

MOTION CONTROL DRIVES

SINAMICS Converters for Single-Axis Drives Distributed Converters







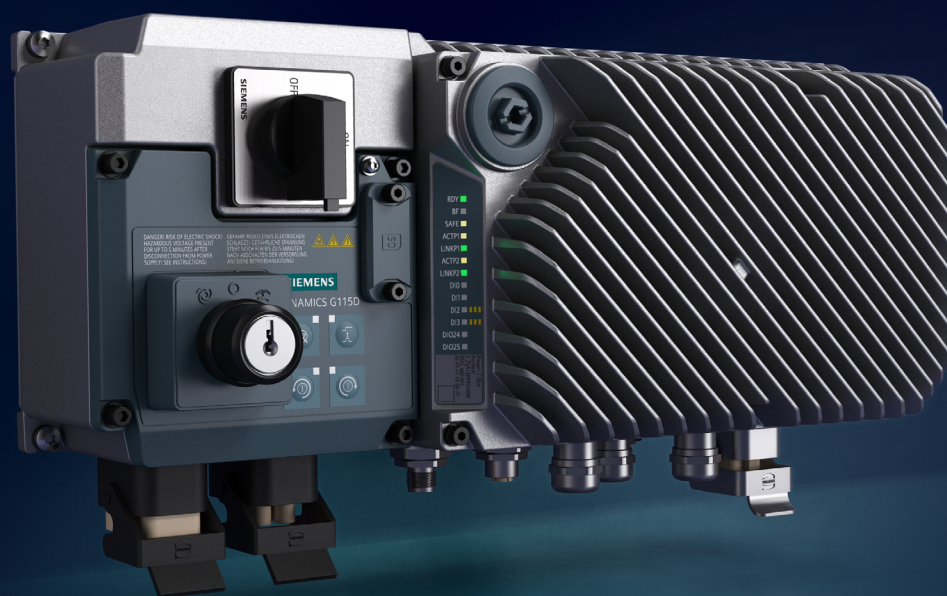









[siemens.com/d31-2](https://www.siemens.com/d31-2)

Catalog
D 31.2

Edition
October
2024

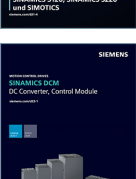

Related catalogs

<p>Motion Control Drives D 31.1 SINAMICS Converters for Single-Axis Drives Built-In Units</p> <p>PDF (E86060-K5531-A111-A5-7600)</p>		<p>Motion Control Drives D 60 SIMOTICS E Drive system for extra low voltage</p> <p>PDF (E86060-K5560-A101-A1)</p>	
<p>Motion Control Drives D 31.5 SINAMICS Umrichter für Einachsantriebe Infrastrukturumrichter für HLK/Wasser/Abwasser SINAMICS G120X</p> <p>PDF (E86060-K5531-A151-A5)</p>		<p>Motion Control System PM 21 SIMOTION Equipment for Production Machines</p> <p>PDF (E86060-K4921-A101-A4-7600)</p>	
<p>Motion Control Drives D 32 SINAMICS S210 Servo Drive System</p> <p>PDF (E86060-K5532-A101-B1-7600)</p>		<p>Industrial Controls IC 10 SIRIUS</p> <p>PDF (E86060-K1010-A101-B7-7600)</p>	
<p>Motion Control Drives D 36.1 SINAMICS Converters for Single-Axis Drives SINAMICS G220 built-in and wall-mounted units</p> <p>PDF (E86060-K5536-A111-A5-7600)</p>		<p>Low-Voltage Power Distribution and Electrical Installation Technology LV 10 SENTRON • SIVACON • ALPHA</p> <p>PDF (E86060-K8280-A101-B9-7600)</p>	
<p>Motion Control Drives D 37.1 SINAMICS S200 Servo drive system</p> <p>PDF (E86060-K5537-A111-A2-7600)</p>		<p>SIMATIC ST 70 Products for Totally Integrated Automation</p> <p>PDF (E86060-K4670-A101-C1-7600)</p>	
<p>SINAMICS S120 D 21.3 Chassis Format Converter Units Chassis-2 Format Converter Units Cabinet Modules, Cabinet Modules-2 SINAMICS S150 Converter Cabinet Units PDF (E86060-K5521-A131-A9-7600)</p>		<p>SIMATIC HMI / PC-based Automation ST 80/ST PC Human Machine Interface Systems PC-based Automation</p> <p>PDF (E86060-K4680-A101-D3-7600)</p>	
<p>Motion Control Drives D 21.4 SINAMICS S120, SINAMICS S220 and SIMOTICS</p> <p>PDF (E86060-K5521-A141-A2-7600)</p>		<p>SITRAIN Digital Industry Academy</p> <p>www.siemens.com/sitrain</p>	
<p>Motion Control Drives D 23.1 SINAMICS DCM series of converters DC Converter, Control Module</p> <p>PDF (E86060-K5523-A111-A4-7600)</p>		<p>SiePortal Information and Ordering Platform on the Internet</p> <p>sieportal.siemens.com</p>	
<p>SIMOTICS S-1FG1 D 41 Servo geared motors Helical, Parallel shaft, Bevel and Helical worm geared motors</p> <p>PDF (E86060-K5541-A101-A6-7600)</p>			



Catalog
D 31.2

Edition
October
2024

MOTION CONTROL DRIVES

SINAMICS Converters for Single-Axis Drives Distributed Converters

[siemens.com/d31.2](https://www.siemens.com/d31.2)

Dear Customer,

We are pleased to present you the new edition of the Catalog D 31.2 - October 2024. The catalog provides a comprehensive overview of SINAMICS converters for single-axis drives – **distributed converters** – comprising the product families SINAMICS G115D, SINAMICS G120D and SIMATIC ET 200pro FC-2.

The catalog has been revised and supplemented.

The SINAMICS G115D distributed frequency converter has been developed for the conveyor technology sector with a focus on the Intra-logistics and Airport industries as well as simple horizontal applications in Automotive and Food & Beverage.

The products listed in this catalog are also included in SiePortal.
Please contact your local Siemens office for additional information.

The Siemens Product Configurator is updated daily and available online at www.siemens.com/spc

Up-to-date information about SINAMICS is available on the internet at: www.siemens.com/sinamics

You can access our SiePortal on the internet at <https://sieportal.siemens.com>

Your personal contact will be glad to receive your suggestions and recommendations for improvement.

You can find your representative in our contact person database at www.siemens.com/automation-contact

We hope that you will often enjoy using Catalog D 31.2 - October 2024 as a selection and ordering reference document and wish you every success with our products and solutions.

With kind regards

A handwritten signature in blue ink, appearing to read 'Frank Golüke', is positioned above the printed name and title.

Frank Golüke
Vice President
General Motion Control
Siemens AG, Digital Industries, Motion Control

SINAMICS Converters for Single-Axis Drives

Distributed Converters

Motion Control Drives

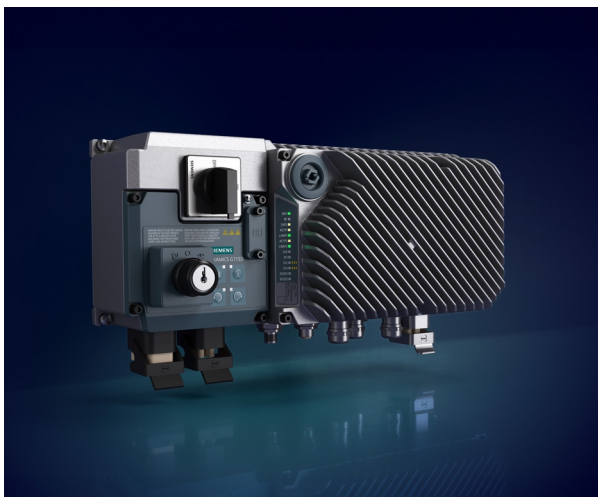

Catalog D 31.2 · October 2024

Supersedes:
Catalog D 31.2 · May 2023

Refer to SiePortal for current updates of this catalog:
<https://sieportal.siemens.com>

Please contact your local Siemens branch.

© Siemens 2024

Click on an Article No. in the catalog PDF to call it up in SiePortal and to obtain all the information.

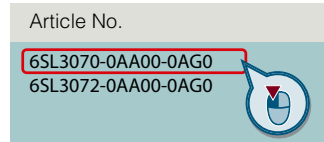

Or directly on the internet, e.g.
www.siemens.com/product_catalog_DIMC?6SL3070-0AA00-0AG0



The products and systems described in this catalog are manufactured/distributed under application of a certified quality management system in accordance with EN ISO 9001. The certificate is recognized by all IQNet countries.

System overview	1
Firmware functionality	2
Safety Integrated	3
Energy efficiency	4
Communication	5
Technology functions	6
SINAMICS G115D distributed drive system	7
SINAMICS G120D distributed converters	8
SIMATIC ET 200pro FC-2 frequency converters	9
Engineering tools	10
Drive applications	11
Services and documentation	12
Appendix	13



Motion beyond expectations

Drives move the industries. But how can they make them more efficient, more reliable and more sustainable – and exceed all expectations while they are doing it? Our answer: Siemens Xcelerator for Digital Drivetrain.

Digital solutions for Drivetrain Design and Drivetrain Health

Combine the real and the digital world to reach the next level of efficiency and sustainability in your drivetrain value chain: with suitable digital solutions for drivetrain design and drivetrain health.

Drivetrain Design:

Simplify and shorten the engineering steps to get faster and more efficiently from concept to the commissioned drivetrain.

Drivetrain Health:

Reduce total cost of ownership for your equipment and machine park – energy, maintenance, downtime.

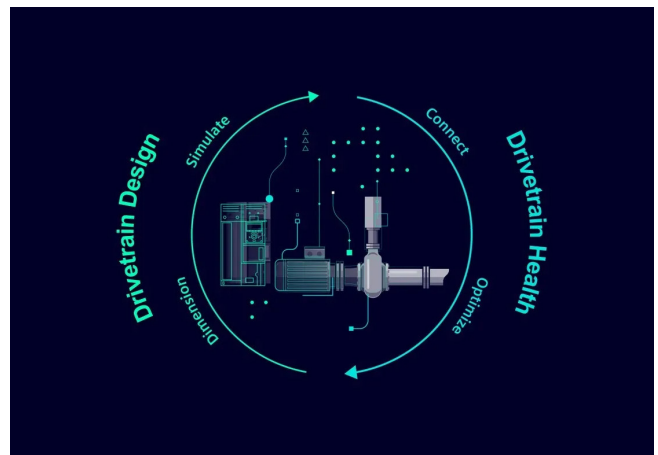

[siemens.com/digital-drivetrain](https://www.siemens.com/digital-drivetrain)

Digitalization along the drivetrain value chain



Dimension

Accurate in motion: Dimension your motors, gearboxes, and complete drivetrains digitally with greater precision – for greater reliability and energy efficiency.



Simulate

Faster in motion: Add the digital twin of the drivetrain to your machine simulation to speed up your design and engineering phases and to accelerate your time-to-market!

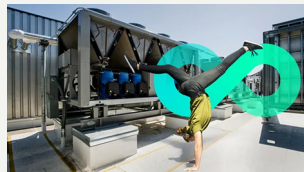

Connect

Data in motion: Acquire high-quality raw data and connect your entire drivetrains or machines to cloud or on-premise platforms – for a consistent and secure data flow.



Optimize

Better in motion: Analyze and visualize drivetrain and machine data in digital solutions and apps to identify optimization potentials and concrete actionable measures how to tap it.

Use cases for digital drivetrain technology



Condition monitoring for drivetrains

Healthy in motion: Gain valuable insights into your drivetrain to optimize maintenance, system availability, cost efficiency, and sustainability: Discover intelligent digital condition monitoring for your drivetrains!

Are your drivetrains fit enough for tough times?

The industries are expected to produce ever more efficiently, ever more sustainably and ever more cost-effectively. And if you can't do that, it's easier to be left behind by the competition. Use digitalization and the data from your motors and converters to optimize your competitiveness – and to keep your production in motion.



What if you consume too much electricity?

With digital solutions and digital drive technology, you can significantly reduce your share of this!



What if you waste too much energy?

Digitalization enables you to detect energy waste and impending system downtimes at an early stage so that you can take counter-measures in due time!



What if your motors are incorrectly designed?

Digital tools make it quicker and easier to correctly design your drive components!



What if your drives fail unexpectedly?

With digital solutions, you can identify risks in your drivetrain at an early stage and react before a failure occurs.

"Our digital solutions transform your drivetrain value chain to the next level of efficiency and sustainability."



SINAMICS frequency converters

SINAMICS frequency converters – the ultimate solution for all drive applications. From low voltage to medium voltage to direct current (DC), our frequency converters meet your needs. With increased efficiency and versatility, take your applications to the next generation for a digital and sustainable future.

Driving next generation applications

When it comes to driving industry advancements, look no further than our SINAMICS frequency converters. They fuel the creation of innovative, next-generation applications that meet the unique needs of every industry.

From pumping and ventilating to moving, positioning, processing, and machining, our converters have you covered. Get ready to take your applications to new heights.



Low voltage converters

Low voltage frequency converters are suitable for a huge range of applications. For example, if materials must be moved, processed, positioned, pumped or compressed. Variable-speed operation saves energy and also increases process quality and process availability.



Servo converters

These servo converters meet the highest dynamic requirements for single and multi-axis applications. The perfect solution for machine tools, packaging machines, continuous material handling, cranes, rolling mills, test stands, material handling, robotics and many other applications requiring high-precision, dynamic motion control.



DC converters

The dynamic performance, ruggedness, and cost-effectiveness of DC technology continue to make it the most cost-effective and proven drive solution for many applications today – with numerous advantages in terms of reliability, ease of use, and operational performance.



Accelerating the digital and sustainable transformation of industry

How can you make production more efficient? Accelerate your digital transformation? And become more sustainable?

The answer is our SINAMICS frequency converters. They are energy efficient, offer the versatility you need for any application, and drive your digital transformation by providing the data to continuously improve production efficiency and sustainability. Our converters offer you integrated safety and security features, efficient engineering and software tools as well as comprehensive lifecycle services. In other words: Everything you need to address the next generation of applications – today and tomorrow.

EFFICIENT

Implement energy-efficient applications easily, quickly, and safely with efficient motion control.

- Sustainable drive systems
- Efficient Motion Control solutions
- Drive System Services

VERSATILE

Drives equipped with tailored safety features to ensure optimal machine safety in a wide range of industrial applications.

- Safety and Security Integrated
- Drive applications
- Drives for any industry

FUTURE-PROOF

Efficient engineering, powerful software tools, and cloud and edge connectivity for greater transparency.

- Digitalization in drive technology
- Efficient drive engineering
- Drive Software for all applications

Totally Integrated Automation



Totally Integrated Automation (TIA) offers smart automation development, flexible machine concepts, transparent operation, and sustainable solutions that enable access to data to calculate and optimize the product carbon footprint. We are constantly improving and expanding TIA to be future-proof and adaptive to existing and upcoming challenges.

A comprehensive portfolio for the challenges of today and tomorrow

The TIA offering is integrated seamlessly and it's so comprehensive that it provides the right automation solutions for every industry. We will continue to improve and expand our proven automation portfolio and are constantly including innovative technologies and solutions that pave the way towards the factory of the future.

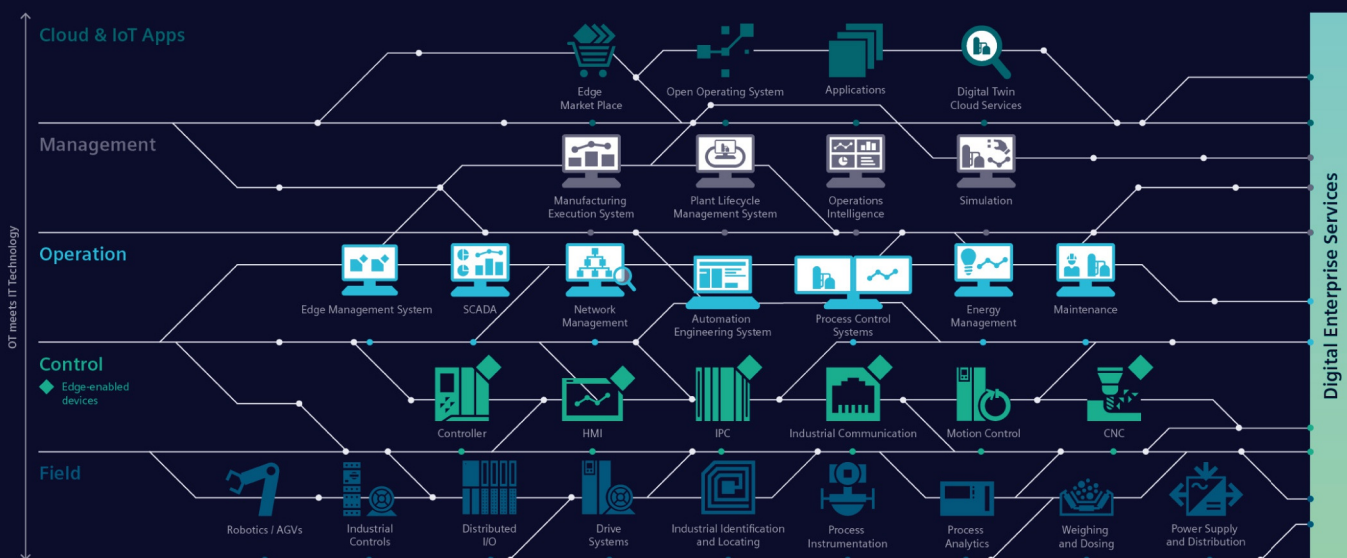

Real added value for the automation of your production

From the development of innovative machine concepts to engineering and optimized production:

TIA offers real added value along the entire value chain.

Smart Automation Development

Innovative machine concepts made easy: When you use standardized library concepts and preconfigured expertise, you can count on efficient engineering. Thanks to the integration of safety features, diagnostic functions, and cybersecurity, you also save valuable time.

Flexible Machine Concepts

No matter what new requirements emerge in the market, TIA supports modular machine concepts and the simple integration of new machines into existing lines – thanks to standardized hardware interfaces and engineering libraries. As a machine builder, this enables you to meet any challenge quickly and reliably.

Transparent Operation

Integrated interfaces let you achieve a new level of transparency for the essential performance indicators in your processes and plants. The connection between IT and OT along with efficient data management lay the foundation for new service models such as predictive maintenance.

Future-proof Automation

Our TIA portfolio is constantly being refined with a view to integrating automation technologies more and more efficiently. The components can then interact with modern IT capabilities, which are becoming increasingly important for specific applications in automation. TIA provides a solid foundation, whether for working with our Industrial Operations X portfolio or for everything the future has in store.

Sustainable Solutions

Sustainability starts with the acquisition of data. With the TIA portfolio, you can measure energy and resource data and make it transparent, providing a solid foundation for calculating the Product Carbon Footprint. This is crucial for drawing the right conclusions and responding to sudden changes in order to lastingly reduce CO₂ emissions and save more resources in production.

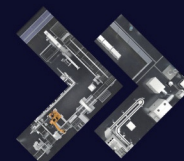

www.siemens.com/tia

TIA Selection Tool – quick, easy, smart configuration

For you to get the most out of our portfolio quickly and easily.

Do you always need the optimum configuration for planning your project?

For your application we offer the TIA Selection Tool to support all project planners, beginners and experts alike.

No detailed portfolio knowledge is necessary.

TIA Selection Tool is available for download as a free desktop version or a cloud variant.

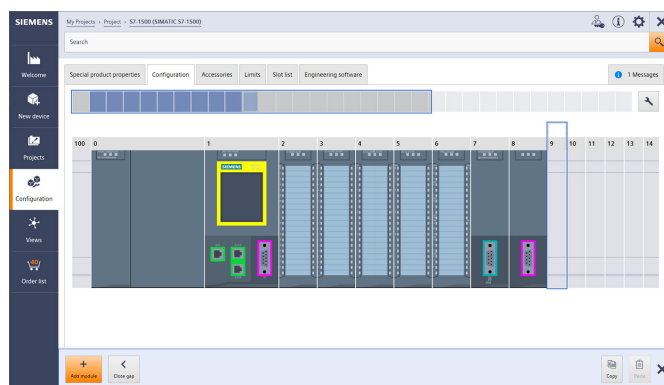

Your Advantages

Quick

- Configure a complete project with just a few entries – without a manual, without special knowledge
- Import and export of hardware configuration to TIA Portal or other systems
- Ideal visualization of the projects to be configured

Easy

- Tool download either as desktop version or web-based cloud version
- Technically always up-to-date about product portfolio and innovative approaches
- Highly flexible, secure, cross-team work in the cloud
- Direct ordering in SiePortal

Smart

- Smart selection wizard for error-free configuration and ordering
- Configuration options can be tested and simulated in advance
- Library for archiving sample configurations

The TIA Selection Tool is a completely paperless solution.

Download it now:

www.siemens.com/tst

For more
information,
scan the
QR code





Sustainability @Siemens

Transforming the everyday to create a better tomorrow.



Decarbonization
Ethics
Governance
Resource Efficiency
Equity
Employability

For more information, see www.siemens.com/sustainability/figures

As a company, Siemens considers environmental, social and governance (ESG) criteria from all angles with its DEGREE framework (decarbonization, ethics, governance, resource efficiency, equity and employability). We are not only committed to reducing the carbon footprint in our own operations to net zero by 2030, but also helping our customers achieve their decarbonization and sustainability goals.

Mission & strategy

As a focused technology company, Siemens is committed to addressing the world's most profound challenges by leveraging the synergies between digitalization and sustainability.

Technology with aim and purpose

We develop technologies that connect the real and digital worlds and enable our customers to positively transform the industries that form the backbone of our economy: industry, infrastructure, transportation and healthcare.

Our contribution

Siemens makes an impact every day by providing innovative solutions in response to challenges relating to environmental protection, decarbonization, health and safety. Innovative solutions that have a clear goal: to make the world more sustainable, more integrative and a better place to live.

Sustainability facts

For almost 175 years, Siemens has been driven by the desire to improve the lives of people around the world with our technologies.



Siemens EcoTech is an environmental product performance label designed to drive the sustainable transformation of industry and infrastructure. The label gives you transparency on the performance of our certified products across environmental relevant criteria, enabling you to make informed choices to support your sustainability goals, see www.siemens.com/SiemensEcoTech.

System overview

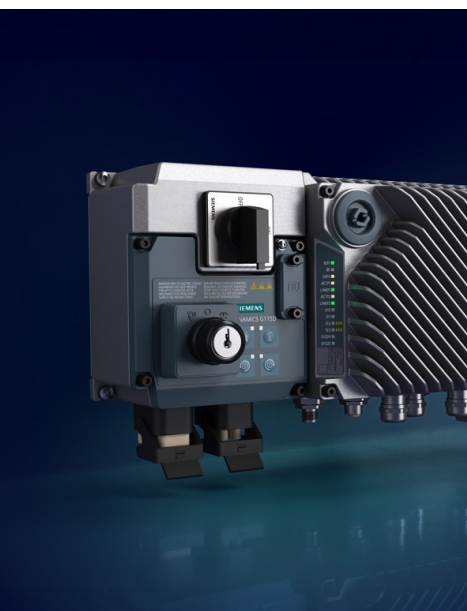

1/2 **The SINAMICS converter family**

1/3 **Drive selection**

1/4 **SIMOTICS motors**

1/5 **Motion Control Encoder measuring systems**

Further information about
SINAMICS and SIMOTICS can be found
on the internet at
www.siemens.com/sinamics
www.siemens.com/simotics

System overview

The SINAMICS converter family









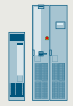

Overview

SINAMICS Frequency converters

SINAMICS frequency converters are the ultimate solution for all drive applications. From low voltage to medium voltage to direct current (DC), our frequency converters meet your needs.

With increased efficiency and versatility, take your drive applications to the next generation for a digital and sustainable future.

www.siemens.com/sinamics

Low voltage											Direct voltage
Standard performance frequency converters		Distributed frequency converters	Industry-specific frequency converters		Servo converters			High performance frequency converters			DC converters
											
SINAMICS V20 G120C G120	SINAMICS G130 G150	SINAMICS G115D G120D SIMATIC ET 200pro FC-2	SINAMICS G120X	SINAMICS G180	SINAMICS V90 S200	SINAMICS S110	SINAMICS S210 (6SL5...)	SINAMICS G220	SINAMICS S120 S120M	SINAMICS S150	SINAMICS DCM DCP ¹⁾
0.12 kW to 250 kW	75 kW to 2700 kW	0.37 kW to 7.5 kW	0.75 kW to 630 kW	2.2 kW to 6600 kW	0.05 kW to 7 kW	0.55 kW to 132 kW	0.05 kW to 7 kW	0.55 kW to 110 kW	0.55 kW to 5700 kW	75 kW to 1200 kW	6 kW to 30 MW
Pumps, fans, compressors, conveyor belts, mixers, mills, spinning machines, textile machines, refrigerated display counters, fitness equipment, ventilation systems, single-axis positioning applications in machine and plant engineering	Pumps, fans, compressors, conveyor belts, mixers, mills, extruders	Conveyor technology, single-axis positioning applications (G120D)	Pumps, fans, compressors, building management systems, process industry, HVAC, water/waste water industries	Pumps, fans, compressors, conveyor belts, extruders, mixers, mills, kneaders, centrifuges, separators	Handling machines, packaging machines, automatic assembly machines, metal forming machines, printing machines, winding and unwinding units	Single-axis positioning applications in machine and plant engineering	Packaging machines, handling equipment, feed and withdrawal devices, stacking units, automatic assembly machines, laboratory automation, wood, glass and ceramics industry, digital printing machines	Pumps, fans, compressors, conveyor belts, mixers, mills, spinning machines, textile machines, refrigerated display counters, fitness equipment, ventilation systems, single-axis positioning applications in machine and plant engineering	Production machines (packaging, textile and printing machines, paper machines, plastic processing machines), machine tools, plants, process lines and rolling mills, marine drives, test bays	Test bays, cross cutters, centrifuges	Rolling mill drives, wire-drawing machines, extruders and kneaders, cableways and lifts, test bay drives
Catalog D 31.1	Catalog D 11	Catalog D 31.2	Catalog D 31.5	Catalog D 18.1	Catalog D 33 D 37.1	Catalog D 31.1	Catalog D 32	Catalog D 36.1	Catalogs D 21.3, D 21.4 NC 62	Catalog D 21.3	Catalog D 23.1, SiePortal
Engineering tools (e.g. Siemens Product Configurator, TIA Selection Tool, DriveSim Designer/Engineer, STARTER and SINAMICS Startdrive)											

¹⁾ DC/DC controllers, see SiePortal.

Overview

SINAMICS selection guide – typical applications

Use	Requirements for torque accuracy/speed accuracy/position accuracy/coordination of axes/functionality					
	Continuous motion			Non-continuous motion		
	Basic	Medium	High	Basic	Medium	High
Pumping, ventilating, compressing 	Centrifugal pumps Radial / axial fans Compressors	Centrifugal pumps Radial / axial fans Compressors	Eccentric screw pumps	Hydraulic pumps Metering pumps	Hydraulic pumps Metering pumps	Descaling pumps Hydraulic pumps
	V20 G120C G120X	G120X G130/G150 G180 ¹⁾ DCM	G220 S120	G120/G220	S110	S120
Moving 	Conveyor belts Roller conveyors Chain conveyors	Conveyor belts Roller conveyors Chain conveyors Lifting/ lowering devices Elevators Escalators/ moving walkways Indoor cranes Marine drives Cable railways	Elevators Container cranes Mining hoists Excavators for open-cast mining Test bays	Acceleration conveyors Storage and retrieval machines	Acceleration conveyors Storage and retrieval machines Cross cutters Reel changers	Storage and retrieval machines Robotics Pick & place Rotary indexing tables Cross cutters Roll feeds Engagers/ disengagers
	V20 G115D G120C ET 200pro FC-2 ²⁾	G120/G220 G120D G130/G150 G180 ¹⁾	G220 S120 S150 DCM	V90 S200 G120/G220 G120D	S110 S210 DCM	S120 S210 DCM
Processing 	Mills Mixers Kneaders Crushers Agitators Centrifuges	Mills Mixers Kneaders Crushers Agitators Centrifuges Extruders Rotary furnaces	Extruders Winders/unwinders Lead/follower drives Calenders Main press drives Printing machines	Tubular bagging machines Single-axis motion control such as • Position profiles • Path profiles	Tubular bagging machines Single-axis motion control such as • Position profiles • Path profiles	Servo presses Rolling mill drives Multi-axis motion control such as • Multi-axis positioning • Cams • Interpolations
	V20 G120C	G120/G220 G130/G150 G180 ¹⁾	G220 S120 S150 DCM	V90 S200 G120/G220	S110 S210	S120 S210 DCM
Machining 	Main drives for • Turning • Milling • Drilling	Main drives for • Drilling • Sawing	Main drives for • Turning • Milling • Drilling • Gear cutting • Grinding	Axis drives for • Turning • Milling • Drilling	Axis drives for • Drilling • Sawing	Axis drives for • Turning • Milling • Drilling • Lasering • Gear cutting • Grinding • Nibbling and punching
	S110	S110 S120	S120	S110	S110 S120	S120

Using the SINAMICS selection guide

The varying range of demands on modern variable frequency drives requires a large number of different types. Selecting the optimum drive has become a significantly more complex process. The application matrix shown simplifies this selection process considerably, by suggesting the ideal SINAMICS drive for examples of typical applications and requirements.

- The application type is selected from the vertical column
 - Pumping, ventilating, compressing
 - Moving
 - Processing
 - Machining
- The quality of the motion type is selected from the horizontal row
 - Basic
 - Medium
 - High

More Information

Further information about SINAMICS is available on the internet at www.siemens.com/sinamics
Practical application examples and descriptions are available on the internet at www.siemens.com/sinamics-applications

¹⁾ Industry-specific converters.

²⁾ Information on the SIMATIC ET 200pro FC-2 frequency converter is available at www.siemens.com/et200pro-fc

System overview

SIMOTICS motors

Overview

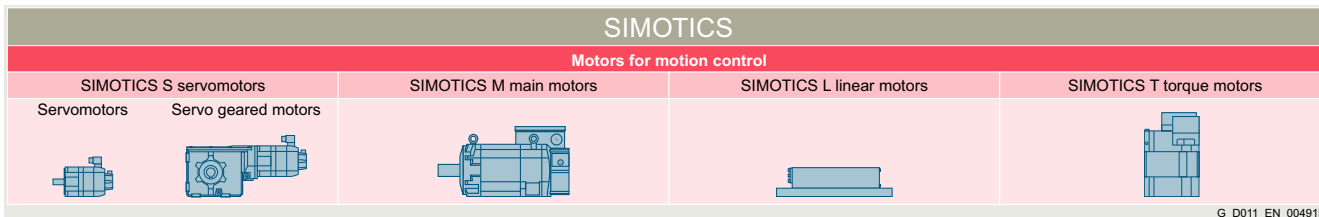

SIMOTICS stands for

- 150 years of experience in building electric motors
- The most comprehensive range of motors for Motion Control applications
- Optimum solutions in all industries, regions and power/performance classes
- Innovative motor technologies of the highest quality and reliability
- Highest dynamic performance, precision and efficiency together with the optimum degree of compactness
- Our motors can be integrated into the drive train as part of the overall system
- A global network of skill sets and worldwide service around the clock

A clearly structured portfolio

The entire SIMOTICS product portfolio is transparently organized according to application-specific criteria in order to help users select the optimum motor for their application.

Whatever it is that you want to move – we can supply the right motor for the task.

www.siemens.com/simotics

Motors from Innomotics

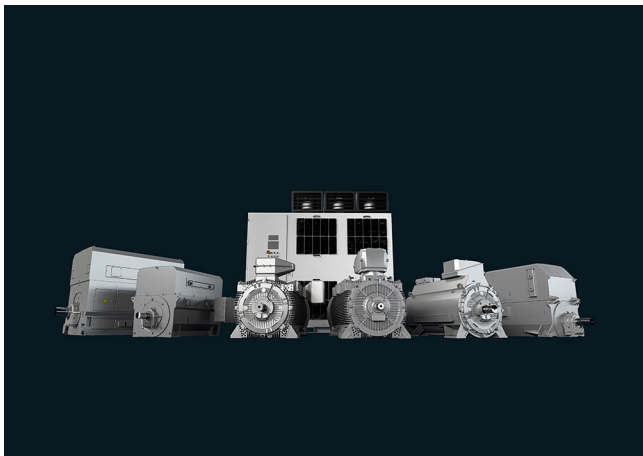

You can also find suitable motors from our product partner Innomotics

www.innomotics.com

An outstanding performance for any job

A key characteristic of all SIMOTICS motors is their quality. They are robust, reliable, dynamic and precise to assure the requisite performance level for any process and deliver exactly the capabilities demanded by the application in hand. Thanks to their compact design, they can be integrated as space-saving units into installations. Furthermore, their impressive energy efficiency makes them effective as a means of reducing operating costs and protecting the environment.

A dense network of skill sets and servicing expertise around the world





SIMOTICS offers not only a wealth of sound experience gleaned from a development history which stretches back over around 150 years, but also the know-how of hundreds of engineers. This knowledge and our worldwide presence form the basis for a unique proximity to industries which feeds through in tangible terms to the specific motor configuration which is tailored to suit your application.

Our specialists are available to answer all your queries regarding any aspect of motor technology. At any time – wherever you are in the world. When you choose SIMOTICS, therefore, you reap the benefits of a global service network which is continuously accessible, thereby helping to optimize response times and minimize downtimes.

Perfection of the complete drive train

SIMOTICS is perfectly coordinated with other Siemens product families. In combination with the SINAMICS integrated converter family and the SIRIUS complete portfolio of industrial controls, SIMOTICS fits seamlessly as part of the complete drive train into automation solutions which are based on the SIMATIC, SIMOTION and SINUMERIK control systems.

Overview

Motion Control Encoder measuring systems								
Encoder type	Incremental encoders			Absolute encoders				
								
Interface	sin/cos 1 V _{pp}	RS422 (TTL)	HTL	DRIVE-CLiQ	SSI	EnDat 2.1	PROFIBUS DP-V2	PROFINET IO with RT/IRT
Resolution	1000 S/R 1024 S/R 2500 S/R	500 S/R 1000 S/R 1024 S/R 1250 S/R 1500 S/R 2000 S/R 2048 S/R 2500 S/R 3600 S/R 5000 S/R	100 S/R 500 S/R 1000 S/R 2500 S/R	Single-turn 24 bit Multi-turn 36 bit (2 ²⁴ steps × 4096 revolutions)	Single-turn 13 bit (8192 steps) Multi-turn 25 bit (8192 steps × 4096 revolutions)	Single-turn 13 bit (8192 steps) Multi-turn 25 bit (8192 steps × 4096 revolutions)	Single-turn 13 bit (8192 steps) Multi-turn 27 bit (8192 steps × 16384 revolutions)	Single-turn 13 bit/16 bit (8192/65536 steps) Multi-turn 27 bit/30 bit (8192/65536 steps × 16384 revolutions)
Catalog	D 21.4							

Motion control encoders are optoelectronic built-on encoders that detect the traversing distances, angles of rotation, speeds or positions of machine axes. Motion control encoders are direct measuring systems that are built-on to shafts, axes or motors. They can be used in conjunction with numerical and programmable logic controllers, drives and position displays. Motion control encoders are system-tested, certified components that have been harmonized for use with the following systems:

- SINUMERIK CNC controls
- SIMOTION Motion Control Systems
- SIMATIC programmable logic controllers
- SINAMICS drive systems

Motion control encoders are used with machine tools and production machines as additional external measuring systems. They are available as incremental or absolute encoders.

- In the case of incremental encoders, the machine must travel to a reference point after each power-off state, as the position is not usually stored in the controller, and movements of the machine while the power is off are not recorded.
- Absolute encoders, on the other hand, also record movements while the power is off and return the actual position after power on. Travel to a reference point is not necessary..

All motion control encoders are available as Synchro flange and clamp flange versions. The absolute encoders are also available with a hollow shaft and torque arm.

The motion control encoders are driven via a plug-in coupling or spring disk coupling. Alternatively, pulleys can also be used.

The motor control encoder supply voltage is 5 V DC or alternatively 10 V to 30 V DC. The 10 V to 30 V DC version supports longer cable lengths. Most control systems supply the voltage directly at the measuring circuit connector. With SINAMICS, the measuring systems are provided with power via the converters or the Sensor Modules.

For motion control encoders with cables, the cable length including the connector is 1 m.

The following bending radii must be observed for the cable to the built-on encoder:

- One-time bending: ≥ 20 mm
- Continuous bending: ≥ 75 mm

More Information

- Internet:
www.siemens.com/sensor-systems
<https://sieportal.siemens.com>

System overview

Notes

1

Firmware functionality

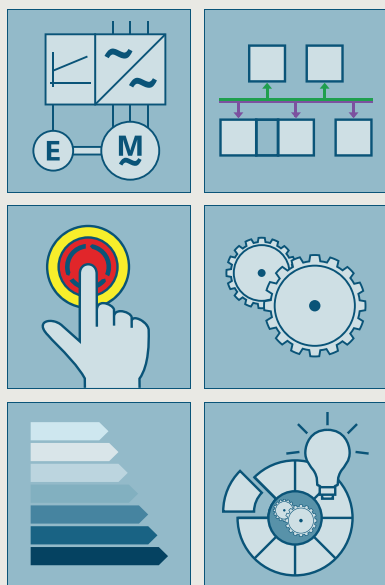
**2/2****Firmware functionality**

2/2

Introduction

2/2

Basic Drive Functions

2/4

Standard Technology Functions

2/5

Advanced Technology Functions

2/6

Common Engineering

2/6

Applications & Branch know-how

Further information about firmware functionality can be found on the internet at www.siemens.com/sinamics-firmware

Firmware functionality

Firmware functionality

Overview

The major part of the functionality of SINAMICS drives is implemented in software. This "embedded" **software** delivers the function of the product and is therefore a significant component of the overall product. The embedded software is also known as **firmware**, because it is firmly connected to specific hardware.

In the case of SINAMICS drives, the firmware is subdivided into the **operating system (OS)** with drivers for the hardware and the converter functions, which are also referred to as the **runtime (RT) functions**.

Introduction

The available firmware functions are so extensive that the overall functional scope has been structured into function groups corresponding to their main applications.

The 8 main groups are:

- Basic Drive Functions
- Standard Technology Functions
- Advanced Technology Functions
- Communication Functions
- Safety Integrated Functions
- Energy Efficiency Functions
- Common Engineering
- Applications & Branch know-how

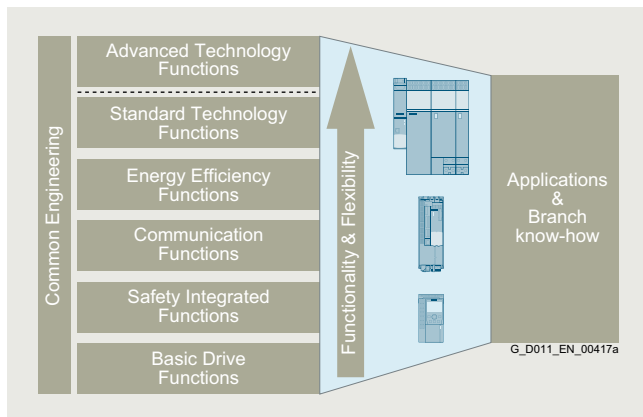

Functionality, including technology and configuration

Basic Drive Functions

The main groups, especially the "Basic Drive Functions", are divided up into further subgroups.

- Control modes
- Availability
- Setpoints and commands
- Limiters, timers and monitoring functions
- Diagnostics
- Protection

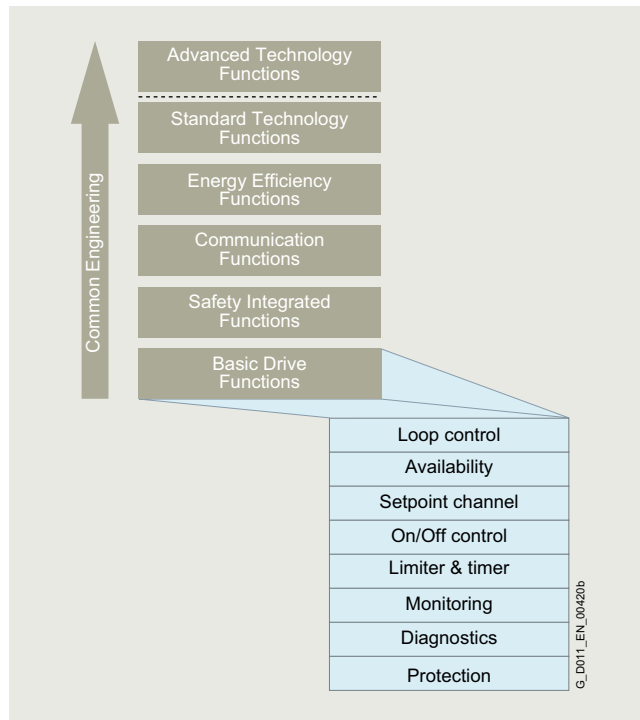

Basic Drive Functions - Control Functions

Control modes

The control methods are the core of the entire converter firmware. They are responsible for optimum movement of the connected motor and the attached machines. The better the control functions, the faster, better and more smoothly the machine operates, thereby significantly enhancing the quality of the production output.

A distinction is made between the following methods:

- V/f control (open-loop control)
- Vector control (closed-loop control)
- Servo control (closed-loop control)

Further classification refers to the control variables:

- Current control
- Speed control
- Torque control
- Position control
- Technological process control (pressure, flow rate, temperature, fill level, etc.)

Overview

Availability

Availability refers to the frequency ratio, namely how often or seldom a single device restricts the entire production process due to a problem. That is why it is important in terms of availability that a drive enters the faulty state only when it is essential for self-protection. Moreover, it is important that the cause of the pending problem is identified and eliminated as quickly as possible.

Features and measures to increase availability:

- Parallel connections, for example, to maintain emergency operation (possibly also at a lower rating), if a power unit fails
- Automatic restart
- Flying restart
- V_{dc} control with kinetic buffering
- Redundancy (hardware, communication, etc.)

Setpoints and commands

The setpoint channel is the link between the setpoint source and the motor control. The converter has a special feature that supports simultaneous input of two setpoints. Generation and subsequent modification of the total setpoint (influencing the direction, skip frequency, up/down ramp) take place in the setpoint channel.

Different sources of command usually result from the requirements to operate a drive from different places (on-site/remote), in different situations (standard/emergency mode) and/or different operating. The BICO binector connector technology allows SINAMICS to configure and combine the command and setpoint sources completely individually.

The following can be used for switching:

- Dataset switchover
- Switching elements among the Free Function Blocks (FFB)
- Fixed values

Limiters and monitoring functions

Limiters or limits are used to constrain input and/or output variables as appropriate to the connected machine; this means that not all positioning variables are used over their full range but are limited judiciously to enhance the safety and quality of the production process.

Timers/runtime counters are used to obtain information or make statements about the temporal course of a process.

- Recording application information for manufacturers
- Recording operating times for users
- Configurable timers for monitoring intervals
- Configurable timers for triggering activities at certain intervals (e.g. maintenance work)

Monitoring is used for early detection of conditions that may be detrimental or even dangerous to the connected machine, so that they can be counteracted expediently. If an appropriate countermeasure is not initiated, a protective response of the converter with probable fault shutdown will ultimately result.

Diagnostics

The "Diagnostics" subgroup comprises all those functions that provide assistance with determining the possible causes of a problem.

If problems occur in a process, or in the driven machine, further interpretation of the measured variables in the converter is required. To this end, different signals should be correlated with respect to time and then observed.

This includes:

- Error and alarm buffer
- Diagnostic buffer
- List of missing signals that interrupt operation
- Tracing for temporal assignment of signal profiles
- I/O simulation
- Telegram content diagnoses
- Terminal status

Protection

All protection functions counteract any possible damage to the converter and/or motor. This is why the shutdown thresholds cannot be parameterized but are factory-tuned and permanently set to match the built-in components. Alarm thresholds may be parameterized as a relative variable for shutdown threshold of some monitoring processes. Thus, a countermeasure that is sensitive to the process may still be initiated upon occurrence of the alarm.

Apart from protection of the hardware, protection of the parameterization and therefore protection of the intellectual expertise of the customer from unauthorized access and copying is also an important part of the protection functions.

- Write protection
- Know-how protection
- Copy protection

Firmware functionality

Firmware functionality

Overview

Standard Technology Functions

The Standard Technology Functions are not restricted to a specific SINAMICS product family, but they are available in full or at least partially in SINAMICS S120 as well as in SINAMICS G120.

- BICO technology
- Free function blocks (FFB)
- Basic positioner (EPOS)
- Technology controller (PID)

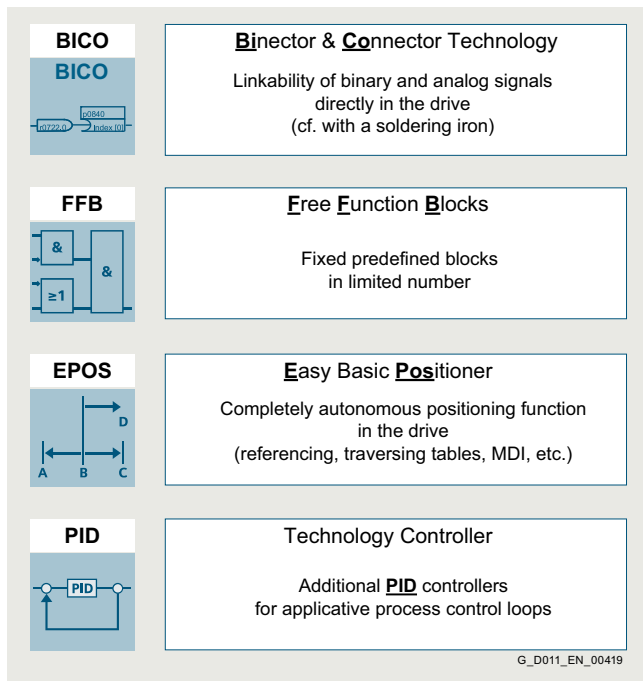

Standard Technology Functions

The Standard Technology Functions significantly expand the application spectrum of the SINAMICS drives because the functions are not permanently and unalterably interconnected; rather, they are interrupted at defined access points and can be connected or wired differently. The BICO technology makes it possible.

The FFBs enable additional, freely interpretable adaptations of the binary and analog signal flow to the given machine application. However, the FFBs are limited in terms of the absolute quantity and the computing intervals (sampling times) that can be selected. These blocks are NOT multi-instance capable.

With EPOS, comprehensive positioning tasks are autonomous in SINAMICS (i.e. their solution does not need a higher-level control). And moreover, this integrated functionality is also extremely flexible: It can be used for highly dynamic servo control as well as for simple applications with vector-controlled asynchronous motors. Up to 64 target positions, as well as the respective traversing speeds, can be permanently stored in the drive during commissioning. Axes can be positioned either absolutely or relatively.

It is, however, also possible to transfer these parameters as required from a higher-level controller. This means that target positions and velocities can even be changed on-the-fly during a positioning run.

The technology controller (PID controller) permits all types of simple process controls to be implemented. It can be used, for example, to control the line pressure, fill level, temperature, flow or also tension control or load balancing.

For more information, see section [Technology functions](#).

Overview

Advanced Technology Functions

The Advanced Technology Functions are the clear differentiating feature between the SINAMICS product families of SINAMICS G120 with the CU2xx-2 Control Units and SINAMICS S120 with the CU3x0-2 Control Units. The Advanced Technology Functions are only available for SINAMICS S120:

- SINAMICS Drive Control Chart (DCC)
- SINAMICS Technology Extensions (TEC)

The Advanced Technology Functions are characterized by maximum flexibility and performance whereby extremely individual and, at the same time, efficient solutions can be achieved.

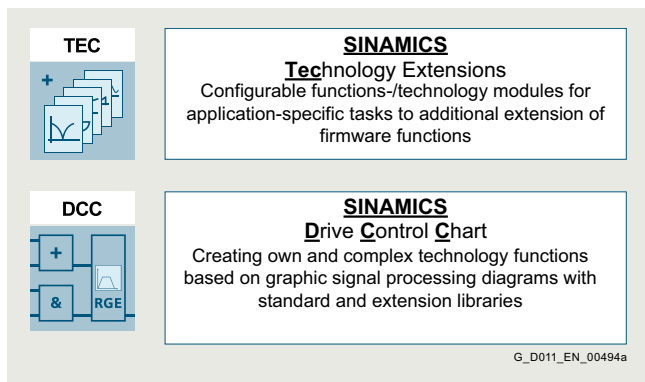

Advanced Technology Functions

SINAMICS DCC comprises the block library, so-called DCB Drive Control Blocks and the DCC Editor for graphical interconnection of blocks. SINAMICS DCC is primarily employed to solve arithmetic and control-related tasks or logic functions associated with complex applications.

In addition to the DCB Standard library, the DCB Extension library can also be used to create applications. The DCB Extension library is comprised of freely programmable blocks which are created for specific applications using DCB Studio and are then graphically interconnected with the DCC Editor in a similar fashion to standard blocks.

SINAMICS Technology Extensions (TECs) are configurable firmware expansions that are specifically created for use in a customized application with special requirements. This functionality can therefore be subsequently installed as an add-on to the standard scope of firmware functions. One example of a SINAMICS TEC is the VIBX vibration extinction for storage and retrieval systems.

For more information, see section [Technology functions](#).

The functional scope of Advanced Technology Functions is scalable and flexible. Depending on the task, you can choose between configurable solutions provided by Siemens or freely created proprietary solutions in the drive.

Siemens provides	Configurable solution for	<ul style="list-style-type: none"> • Positioning • Simple signal processing (logic tasks) • Basic process control 	<p>Standard Technology Functions</p>	<p>Easy Basic Positioner</p> <p>Free Function Blocks</p> <p>Technology Controller (PID)</p>
	Configurable solution that can be modified as	<ul style="list-style-type: none"> • Application-specific tasks 	<p>Advanced Technology Functions</p>	<p>SINAMICS Technology Extensions</p> <ul style="list-style-type: none"> • Vibration Extinguishment • Servo Coupling • Setpoint Generator • Polygonal line • Open Application Link •
Customers create/adapt themselves		<ul style="list-style-type: none"> • Application examples of: <ul style="list-style-type: none"> - Drive-related open-loop and closed-loop control tasks - Motion control functions 		<p>SINAMICS Drive Control Chart</p>
		<ul style="list-style-type: none"> • General drive-related open-loop and closed-loop control tasks 	<ul style="list-style-type: none"> • DCB Standard 	
		<ul style="list-style-type: none"> • Specific expanded functionality for complex tasks • Own function blocks in C/C++ to integrate your own know-how 	<ul style="list-style-type: none"> • DCB Extension 	
				<ul style="list-style-type: none"> • DCB Studio • DCB Extension

G_D011_EN_00493

Depending on the technology function, a license may be required for the application.

Firmware functionality

Firmware functionality

Overview

Safety Integrated Functions

See section [Safety Integrated](#)

Communication Functions

See section [Communication](#)

Energy Efficiency Functions

See section [Energy efficiency](#)

Common Engineering

All functions of the converters are implemented to enable a common engineering approach to their handling no matter which type of drive is selected; i.e. if a function is used in drive x, it can be configured intuitively and commissioned in the same way in drive y. Knowledge gained can therefore be reused easily and efficiently. The configuration and commissioning tools in particular (such as SIZER for Siemens Drives (integrated in TIA Selection Tool), STARTER and SINAMICS Startdrive) reflect this approach..

For more information, see section [Engineering tools](#).

Applications & Branch know-how

Siemens has applied these technology functions (standard and/or advanced) to generate numerous application solutions. These applications can be downloaded from the Siemens application support website at www.siemens.com/sinamics-applications

The STARTER and SINAMICS Startdrive commissioning tools can then be used to activate and configure the applications and download them to the Control Units.

More information

Further information about firmware functionality can be found on the internet at www.siemens.com/sinamics-firmware

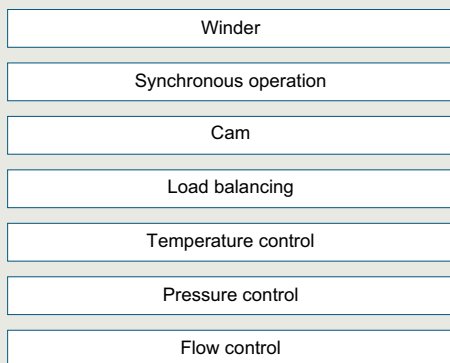

Applications & Branch know-how

Cascade control, bypass, multi-zone control, hibernation, essential service mode ESM, wobble generator

Line infeed functions, e.g. line transformer, dynamic grid support, ...

G_D01_EN_00421a

Applications & Branch know-how

Depending on the technology function, a license may be required for the application.

In some branch-specific Control Units (e.g. CU230P-2) branch-specific functions are also an integral part of the firmware.

For more information, see section [Drive applications](#).

Safety Integrated

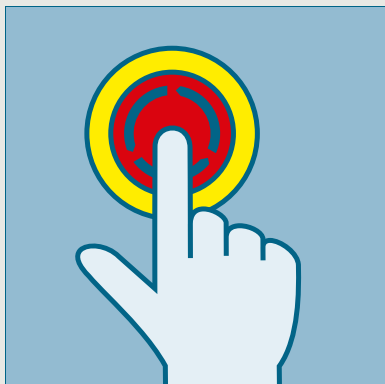
**3/2 Safety Integrated**

3/2 Overview

3/3 Function

3/13 Integration

3/13 More information

3/14 Safety Integrated for SINAMICS G115D

3/14 Overview

3/14 Function

3/15 Safety Integrated for SINAMICS G120D

3/15 Overview

3/15 Benefits

3/17 Function

3/18 Safety Integrated for SINAMICS ET 200pro FC-2

3/18 Overview

3/18 Function

The Safety Integrated Function Manual contains detailed information about the safety functions.

<https://support.industry.siemens.com/cs/document/109781722>

Further manuals pertaining to Safety Integrated in drive systems can be found on the internet at

<https://support.industry.siemens.com/cs/ww/en/ps/13206/man>

Further information about Safety Integrated in SINAMICS can be found on the internet at www.siemens.com/safety-drives

Safety Integrated

Safety Integrated

Overview



Legal framework

Machine manufacturers and plant construction companies must ensure that their machines or plants cannot cause danger due to malfunctions in addition to the general risks of electric shock, heat or radiation.

In Europe, for example, compliance with the Machinery Directive 2006/42/EC is legally stipulated by the EU framework directive for occupational safety. In order to ensure compliance with this directive, it is recommended that the corresponding harmonized European standards are applied. This triggers the "assumption of conformity" and gives manufacturers and operators the legal security in terms of compliance with both national regulations and EU directives. The machine manufacturer uses the CE marking to document compliance with all relevant directives and regulations in the free movement of goods.

Safety-related standards

Functional safety is specified in various standards. For example, ISO 12100 specifies standards pertaining to machine safety (risk assessment and risk reduction). IEC 61508 specifies basic requirements for electronic and programmable safety-related systems. IEC 62061 (only applicable for electrical and electronic control systems) and ISO 13849-1 define the functional and safety-related requirements of safety-oriented control systems.

The above-mentioned standards define different safety requirements that the machine has to satisfy in accordance with the risk, frequency of a dangerous situation, probability of occurrence and the opportunities for recognizing impending danger.

- ISO 13849-1:
Performance Level PL a ... e;
Category B, 1 ... 4
- IEC 62061:
Safety Integrity Level SIL 1 ... 3

Trend toward integrated safety systems

The trend toward greater complexity and higher modularity of machines has seen a shift in safety functions away from the classical central safety functions (for example, shutdown of the complete machine using a main disconnecting means) and into the machine control system and the drives. This is often accompanied by a significant increase in productivity because the setup times are shortened. Depending on the type of machine, it may even be possible to continue manufacturing other parts while the setup is in progress.

Safety Integrated Functions act much faster than those of a conventional design. The safety of a machine is increased further with Safety Integrated. Furthermore, thanks to the faster method of operation, safety measures controlled by integrated safety systems are perceived as less of a hindrance by the machine operator, therefore significantly reducing the motivation to consciously bypass safety functions.

Function

Safety functions integrated in SINAMICS drives

SINAMICS drives are characterized by a large number of Safety Integrated Functions. In combination with the sensors and safety control required for the safety functionality, they ensure that highly-effective protection for persons and machines is implemented in a practice-oriented manner.

They comply with the requirements of the following safety categories:

- PL d and Category 3 according to ISO 13849-1
- SIL 2 according to IEC 61508 and IEC 61800-5-2

Note:

The Safe Brake Test (SBT) diagnostic function meets the requirements for Category 2 according to ISO 13849-1.

The PM240-2 Power Modules, frame sizes FSD to FSG additionally offer STO acc. to IEC 61508 SIL 3 and ISO 13489-1 PL e and Category 3.

The Safety Integrated functions are generally certified by independent institutes. You can obtain the corresponding test certificates and manufacturer's declarations from your Siemens contacts.

The Safety Integrated Functions that are currently available are described below. Their functional safety satisfies the requirements defined in the international standard IEC 61800-5-2 for variable-speed drive systems.

The safety functions integrated into the SINAMICS drive system can be roughly divided into four categories:

- **Functions for safely stopping a drive**
 - Safe Torque Off (STO)
 - Safe Stop 1 (SS1)
 - Safe Stop 2 (SS2)
 - Safe Operating Stop (SOS)
- **Functions for safe brake management**
 - Safe Brake Control (SBC)
 - Safe Brake Test (SBT)
(this diagnostic function exceeds the scope of IEC 61800-5-2)
- **Functions for safely monitoring the motion of a drive**
 - Safely-Limited Speed (SLS)
 - Safe Speed Monitor (SSM)
 - Safe Direction (SDI)
 - Safely-Limited Acceleration (SLA)
- **Functions for safely monitoring the position of a drive**
 - Safely-Limited Position (SLP)
 - Safe Position (SP) (this function exceeds the scope of IEC 61800-5-2)
 - Safe Cam (SCA)

Safe Torque Off (STO)

The STO function is the most common and basic drive-integrated safety function. It ensures that no torque-generating energy can continue to affect a motor and prevents unintentional start-ups.

Effect

This function is a mechanism that prevents the drive from restarting unexpectedly, in accordance with EN 60204-1, Section 5.4. The STO function suppresses the drive pulses (corresponds to Stop Category 0 according to EN 60204-1). The drive is reliably torque-free. This state is monitored internally in the drive.

Application

STO has the immediate effect that the drive cannot supply any torque-generating energy. STO can be used wherever the drive will naturally reach a standstill due to load torque or friction in a sufficiently short time or when "coasting down" of the drive will not have any relevance for safety.

STO makes it possible for persons to work safely when the protective door is open (restart interlock) and is used on machines/installations with moving axes, e.g. on handling or conveyor systems.

Customer benefits

Some of the advantages of the Safety Integrated Function STO over conventional safety technology with electromechanical switchgear include the elimination of separate components as well as of the work that would be required to wire and service them, i.e. no wearing parts as a result of the electronic shutdown. Because of the fast electronic switching times, the function provides a shorter reaction time than the conventional solution comprising electromechanical components. When STO is triggered, the converter remains connected to the network and can be fully diagnosed.

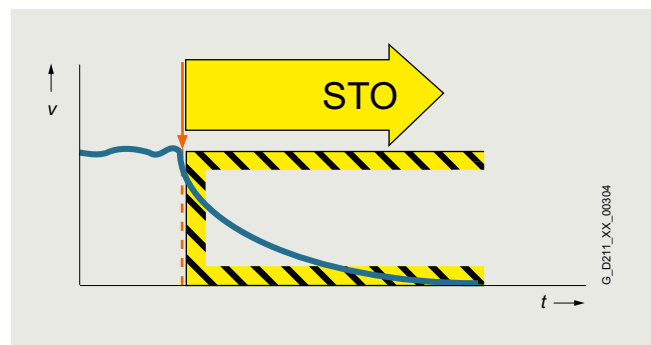

Safety Integrated

Safety Integrated

Function

Safe Stop 1 (SS1)

The SS1 function causes a motor to stop rapidly and safely and switches the motor to torque-free mode after coming to a standstill by activating STO.

Effect

The SS1 function can safely stop the drive in accordance with EN 60204-1, Stop Category 1. When the SS1 function is selected, the drive brakes autonomously along a quick-stop ramp and automatically activates the Safe Torque Off and Safe Brake Control functions (if configured) when the parameterized safety delay time expires.

If the variant "SS1 with external stop (SS1E)" is parameterized, the drive does not brake autonomously when the function is selected. In this case, the higher-level control must bring the drive to a standstill within a parameterized STO transition time. The SBR (Safe Brake Ramp) and SAM (Safe Acceleration Monitor) functions are not active. SS1E is a useful function for drives that need to be stopped as a group by the Motion Control system in order to prevent potential damage to the machine or product.

Application

The SS1 function is used when, in the event of a safety-relevant incident, the drive must stop as quickly as possible with a subsequent transition into the STO state (e.g. EMERGENCY STOP). It is thus used to bring large centrifugal masses to a stop as quickly as possible for the safety of the operating personnel, or to brake motors at high speeds as quickly as possible. Examples of typical applications are saws, grinding machine spindles, centrifuges, winders and storage and retrieval machines.

Customer benefits

The targeted stopping of a drive by means of SS1 reduces the risk of danger, increases the productivity of a machine, and allows the safety clearances in a machine to be reduced. The principle is to bring the drive actively to a standstill, compared with just using the STO function. Complex mechanical brakes that are susceptible to wear are normally not required to brake the motor.

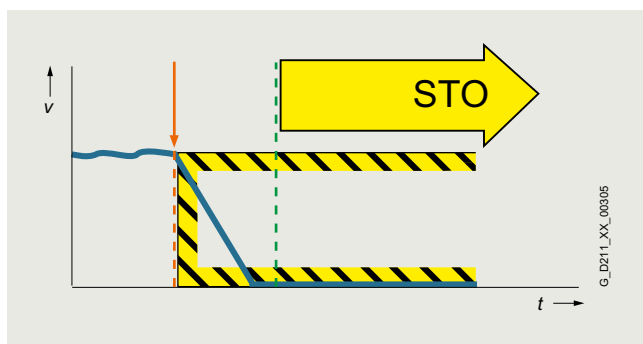

Safe Stop 2 (SS2)

The SS2 function brings the motor to a standstill quickly and safely and then activates the SOS function once the motor has stopped.

Effect

The Safe Stop 2 function can safely stop the drive in accordance with EN 60204-1, Stop Category 2. When the SS2 function is selected, the drive brakes autonomously along a quick stop ramp. In contrast to SS1, the drive control remains operational afterwards, i.e. the motor can supply the full torque required to maintain zero speed. Standstill is safely monitored (Safe Operating Stop function).

If the variant "SS2 with external stop (SS2E)" is parameterized, the drive does not brake autonomously when the function is selected. In this case, the higher-level control must bring the drive to a standstill within a parameterized Safe Operating Stop transition time. The SBR (Safe Brake Ramp) and SAM (Safe Acceleration Monitor) functions are not active. SS2E is a useful function for drives that need to be stopped as a group by the Motion Control system in order to prevent potential damage to the machine or product.

Application

As with SS1, the SS2 function ensures the quickest possible deceleration of the motor. However, the motor power is not switched off. Instead, a control system prevents it from leaving the standstill position – even if it is affected by external forces. Typical applications for SS2 include machine tools, for example.

Customer benefits

The SS2 function ensures a rapid axis stop. Because the control remains active, after the safety function is deselected, productive operation can continue without referencing. This ensures short setup and standstill times and high productivity.

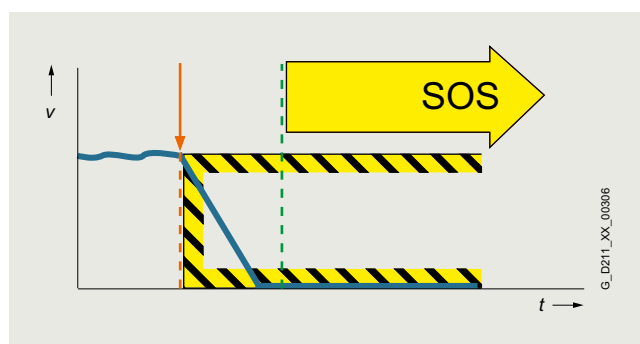

Function

Safe Operating Stop (SOS)

With the SOS function, the stopped motor is held in position by the drive control system and its position is monitored.

Effect

The SOS function constitutes safe standstill monitoring. The drive control remains in operation. The motor can therefore deliver the full torque to hold the current position. The actual position is reliably monitored. In contrast to safety functions SS1 and SS2, the speed setpoint is not influenced autonomously. After SOS has been activated, the higher-level control must bring the drive to a standstill within a parameterized time and then hold the position setpoint.

Application

SOS is an ideal solution for all those applications for which the machine or parts of the machine must be at a safe standstill for certain steps, but the drive must also supply a holding torque. It is ensured that despite counter torque the drive remains in its current position. In contrast to SS1 and SS2, the drive does not brake autonomously in this case. It expects the higher-level controller to ramp down the relevant axes as a coordinated group within an adjustable delay time. This can be used to prevent any damage to the machine or product. Typical applications for SOS include winders, converting and packaging machines and machine tools.

Customer benefits

No mechanical components are necessary to keep the axis in position despite any counterforce that may occur. Due to the short switching times and the fact that the drive control always remains active, setup and downtimes are reduced. Recalibration of the axis after exiting the SOS function is not necessary. The axis can immediately be moved again after deactivation of the SOS function.

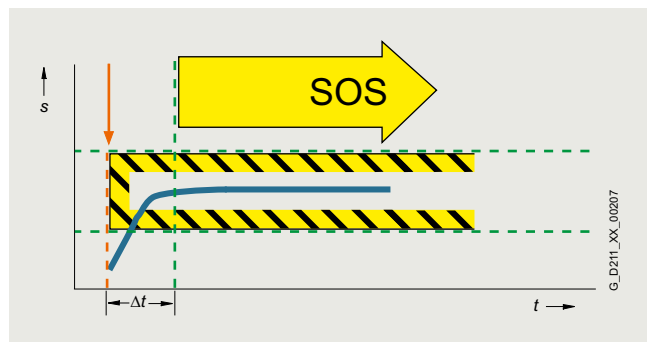

Safe Brake Control (SBC)

The SBC function permits the safe control of a holding brake. SBC is always activated in parallel with STO.

Effect

A holding brake which is active in a de-energized state is controlled and monitored using safe two-channel technology. Due to the two-channel control, the brake may still be activated in the event of an insulation fault in the control cable. Errors of this kind are detected early by means of test pulses.

Note:

Safe Brake Control does not detect mechanical faults in the brake itself, such as worn brake linings. For Motor Modules in booksize format, the terminals for the motor brake are integrated. An additional Safe Brake Relay is required for Power Modules in blocksize format. An additional Safe Brake Adapter is necessary for Power Modules in chassis format.

Application

The SBC function is used in conjunction with the functions STO or SS1 to prevent the movement of an axis in the torque-free state, e.g. because of gravity.

Customer benefits

Again, the function saves the use of external hardware and the associated wiring.

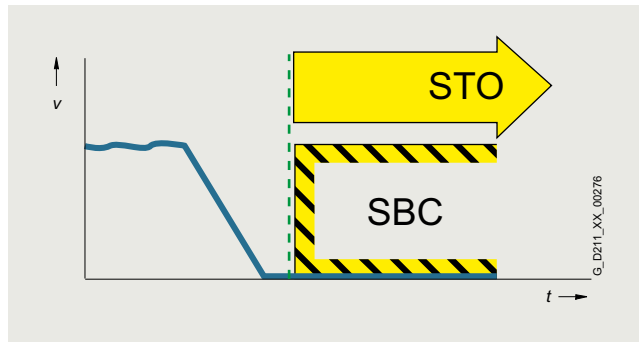

Safety Integrated

Safety Integrated

Function

Safe Brake Test (SBT)

The SBT diagnostic function carries out a brake function test at regular intervals or before personnel enter the danger zone.

Effect

A good way to check the proper functioning of brakes that have become worn is to apply a torque to the closed brake. Drive systems that have two brakes, e.g. motor brake and external brake, can be tested with different torque values.

Application

The SBT diagnostic function is suitable for implementing a safe brake in combination with the SBC function.

Customer benefits

The function detects faults or wear in the brake mechanics. Automatically testing the effectiveness of brakes reduces maintenance costs and increases the safety and availability of the machine or plant.

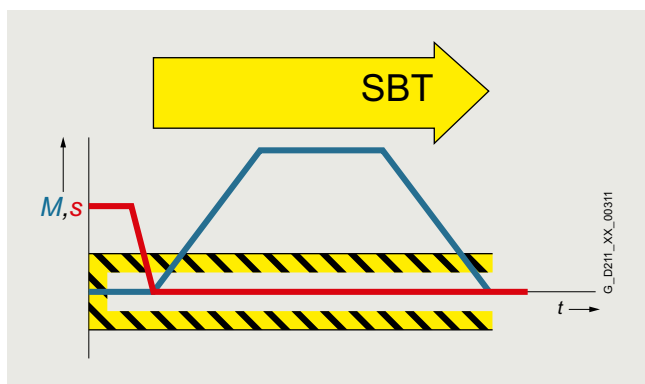

Safely-Limited Speed (SLS)

The SLS function monitors the drive to ensure that it does not exceed a preset speed or velocity limit.

Effect

The SLS function monitors the drive against a parameterized speed limit. Four different limit values can be selected. As in the case of SOS, the speed setpoint is not influenced independently. After SLS has been selected, the higher-level control must bring the drive down below the selected speed limit within a parameterizable time. If the speed limit is exceeded, a customizable drive-integrated fault reaction occurs.

The SLS limit stage 1 can be multiplied by a factor that is transferred in 16-bit resolution via PROFIsafe. This allows an almost unlimited number of limits to be specified.

Application

The SLS function is used if people are in the danger zone of a machine and their safety can only be guaranteed by reduced speed. Typical application cases include those in which an operator must enter the danger zone of the machine for the purposes of maintenance or setting up, such as a winder in which the material is manually threaded by the operator. To prevent injury to the operator, the roller may only spin at a safely reduced speed. SLS is often also used as part of a two-stage safety concept. While a person is in a less critical zone, the SLS function is activated, and the drives are only stopped safely in a smaller area with higher potential risk. SLS can be used not only for operator protection, but also for machinery protection, e.g. if a maximum speed must not be exceeded.

Customer benefits

The SLS function can contribute to a significant reduction in downtime, or greatly simplify or even accelerate setup. The overall effect achieved is a higher availability of the machine. Moreover, external components such as speed monitors can be omitted.

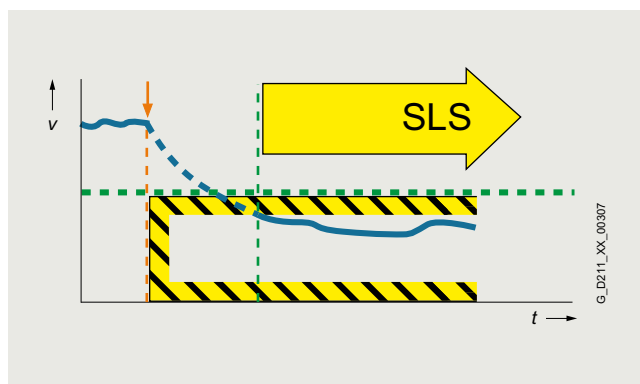

Function

Safe Speed Monitor (SSM)

The SSM function warns when a drive is working below an adjustable speed limit. As long as it remains below the threshold, the function issues a safety-related signal.

Effect

If a speed value drops below a parameterized limit, a safety-related signal is generated. This can, for example, be processed in a safety control unit to respond to the event by programming, depending on the situation.

Application

With the SSM function, in the simplest case, a safety door can be unlocked if the speed drops below a non-critical level. Another typical example is that of a centrifuge that may be filled only when it is operating below a configured speed limit.

Customer benefits

Unlike SLS, there is no drive-integrated fault reaction when the speed limit is exceeded. The safe feedback can be evaluated in a safety control unit, allowing the user to respond appropriately to the situation.

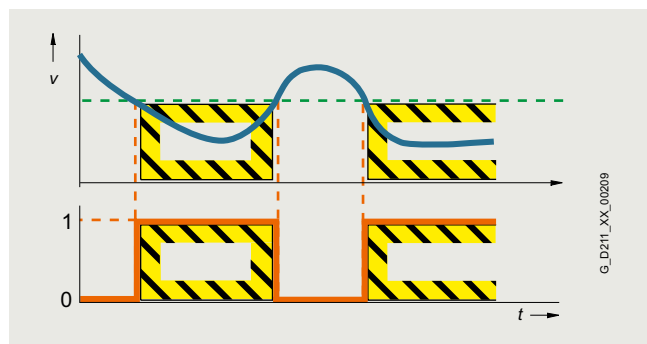

Safe Direction (SDI)

The SDI function ensures that the drive can only move in the selected direction.

Effect

Deviation from the direction of motion currently being monitored is detected reliably and the configured drive-integrated fault reaction is initiated. It is possible to select which direction of rotation is to be monitored.

Application

The SDI function is used when the drive may only move in one direction. A typical application is to permit the operator access to a danger zone, as long as the machine is rotating in the safe direction, i.e. away from the operator. In this state, the operator can feed material into the work zone or remove material from the work zone without danger.

Customer benefits

The function saves the use of external components such as speed monitors and the associated wiring. The release of a danger zone while the machine is moving away from the operator increases productivity. Without the SDI function, the machine must be safely stopped during material loading and removal.

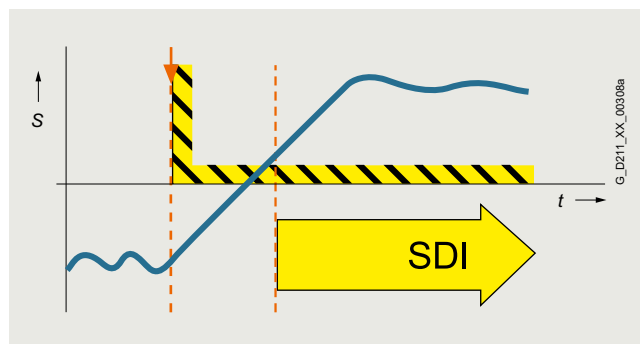

Safety Integrated

Safety Integrated

Function

Safely-Limited Acceleration (SLA)

The SLA function monitors that the drive does not exceed a pre-set acceleration limit value.

Effect

The SLA function monitors that the motor does not violate the defined acceleration limit (e.g. in setup mode). SLA detects early on whether the speed is increasing at an inadmissible rate (the drive accelerates uncontrollably) and initiates the stop response.

Application

The SLA function is used, e.g., for SIMATIC Safe Kinematics.

Customer benefits

The function monitors for maximum permissible acceleration in setup mode and safe monitoring of the tool center point with different kinematics.



Safely-Limited Position (SLP)

The SLP function monitors the axis to ensure that it remains within the permissible traversing range.

Effect

When SLP is activated, the traversing range limited by the configured software limit switches is safely monitored. If the permitted traversing range is exited, a configurable fault reaction occurs. It is possible to toggle between two traversing ranges, even when the machine is in operation.

Application

SLP is used for applications in which machine operators have to enter a protection area, e.g. for feeding in and removing material. Safe monitoring of the axis position ensures that the axis cannot move into the protection area released for operators and so place them in danger, for example, on storage and retrieval machines, gantry cranes or machining centers.

Customer benefits

SLP can be used for highly-effective protection area monitoring. The function does away with the use of external components such as hardware limit switches and the associated wiring expense. Due to the short reaction time following a limit overshoot, safety clearances can be reduced.

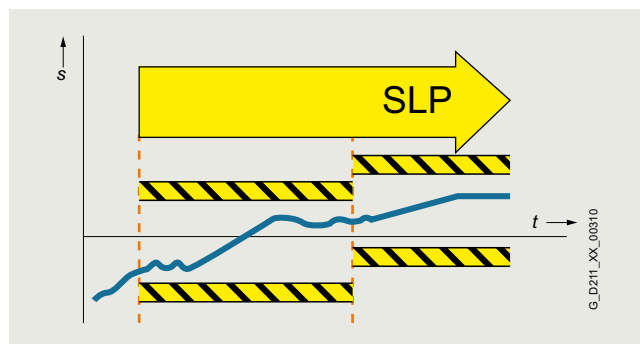

Function

Safe Position (SP)

The SP function transfers the actual position values determined safely in the drive over safe PROFIsafe communication to a safety control.

Effect

In contrast to the SLP function that monitors the current actual position value against a limit and, in the case of an overshoot, activates a drive-integrated fault reaction, SP transfers the current actual position values to the safety control. Position monitoring is implemented in the safety program of the control. Extended PROFIsafe telegrams are available for transferring the position values. The position values can be transferred in 16-bit or 32-bit resolution, as required. A time stamp is also transferred with the position values.

Application

Tailor-made safety concepts can be created using the SP function. It is ideal for use on machines that require flexible safety functions. It is extremely versatile and can be used, for example, to implement safe, axis-specific range detection by means of safe cams. The SP function can also be used to implement multi-axis safety concepts, multi-dimensional protection areas and zone concepts.

Customer benefits

Position monitoring or speed monitoring is implemented in the safety program of the control, so the user has the flexibility for implementing tailor-made safety functions. The reaction to a limit overshoot must also be specified in the safety program. This means a higher initial programming outlay, but it does offer the opportunity for initiating different fault reactions depending on the situation.

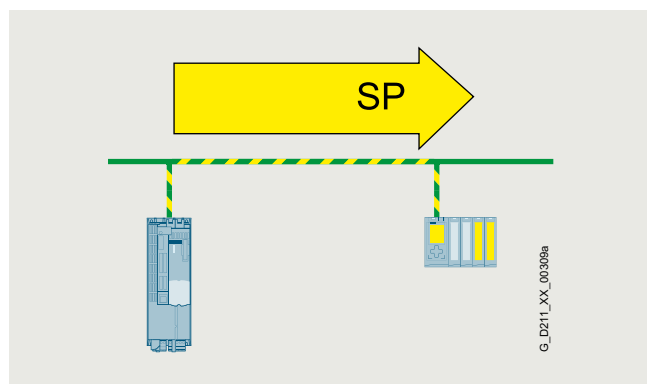

Safe Cam (SCA)

The SCA function enables safety-related monitoring of the position.

Effect

The SCA function outputs a safe signal if the drive is within a specified position range. It facilitates the realization of safe axis-specific range detection. Up to 30 safe cams can be parameterized per axis.

Application

It is only permissible that a protective door is opened if a drive is in a certain position range. The drive may only be traversed with reduced speed when it is located in a certain position range.

Customer benefits

The function enables safety-related switchover of safety functions. With SCA, safe electronic cam controllers can be implemented without additional hardware. With SCA, work and protection zone delimitations are reliably detected.

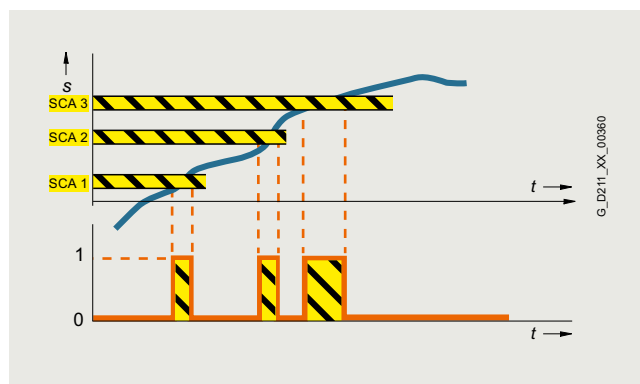

Safety Integrated

Safety Integrated

Function

Basic Functions, Extended Functions, and Advanced Functions

With SINAMICS G converters, the safety functions are basically implemented without encoders.

With SINAMICS S drives, the safety functions are implemented with encoders – individual safety functions can also be operated without encoders.

The Safety Integrated Functions are grouped into Basic Functions, Extended Functions, and Advanced Functions.

The Basic Functions are included in the standard scope of supply.

The Extended Functions must be activated by a license ¹⁾. The Advanced Functions for SINAMICS S120 must also be activated via a license.

The electronic Certificate of License is the paperless delivery form for runtime options for SINAMICS and contains information about the type of rights of use purchased for the software.

- Basic Functions
 - Safe Torque Off (STO)
 - Safe Brake Control (SBC)
 - Safe Stop 1 (SS1)
- Extended Functions
 - Safe Stop 1 (SS1) with SBR or SAM
 - Safe Stop 2 with external stop (SS2E)
 - Safe Stop 2 (SS2) with SBR or SAM
 - Safe Operating Stop (SOS)
 - Safely-Limited Speed (SLS)
 - Safe Speed Monitor (SSM)
 - Safe Direction (SDI)
 - Safely-Limited Acceleration (SLA)
 - Safe Brake Test (SBT) diagnostic function
- Advanced Functions
 - Safely-Limited Position (SLP)
 - Safe Position (SP)
 - Safe Cam (SCA)

The license for Safety Integrated Advanced Functions also includes the license for Safety Integrated Extended Functions.

For the Extended Functions SS1 and SS2 with SAM, Safe Acceleration Monitor (SAM) is performed during braking to identify any faults already during the braking phase.

With SS1 and SS2, a Safe Brake Ramp (SBR) can be configured as an alternative. SS1 can also be parameterized with an external stop (SS1E).

The Basic Functions – activated via on-board terminals on the device, TM54F Terminal Module (only for SINAMICS S) or via PROFIsafe – do not require an encoder.

Activation of the Safety Integrated Functions

The safety functions for SINAMICS drives can be activated via terminals, e.g. for use of a conventional safety circuit.

For standalone safety solutions for small to medium-sized applications, it is frequently sufficient that the various sensing components are directly hardwired to the drive.

For integrated safety solutions, the safety-relevant sequences are generally processed and coordinated in the fail-safe SIMATIC controller. Here, the system components communicate via the PROFINET or PROFIBUS fieldbus. The safety functions are controlled via the safe PROFIsafe communication protocol.

SINAMICS drives can be easily integrated into the plant or system topology.

PROFIsafe

SINAMICS drives support the PROFIsafe profile based on PROFINET as well as on PROFIBUS.

PROFIsafe is an open communications standard that supports standard and safety-related communication over the same communication path (wired or wireless). A second, separate bus system is therefore not necessary. The telegrams that are sent are continually monitored to ensure safety-relevant communication.

Possible errors such as telegrams that have been lost, repeated or received in the incorrect sequence are avoided. This is done by consecutively numbering the telegrams in a safety-relevant fashion, monitoring their reception within a defined time and transferring an ID for transmitter and receiver of a telegram. A CRC (cyclic redundancy check) data security mechanism is also used.

The operating principle of Safety Integrated

Two independent switch-off signal paths

Two independent switch-off signal paths are available. All switch-off signal paths are low active. This ensures that the system is always switched to a safe state if a component fails or in the event of cable breakage. If a fault is discovered in the switch-off signal paths, the STO or SS1 function (depending on parameter settings) is activated and a system restart inhibited.

Two-channel monitoring structure

All the main hardware and software functions for Safety Integrated are implemented in two independent monitoring channels (e.g. switch-off signal paths, data management, data comparison). A cyclic crosswise comparison of the safety-relevant data in the two monitoring channels is carried out.

The monitoring functions in each monitoring channel work on the principle that a defined state must prevail before each action is carried out and a specific acknowledgement must be made after each action. If these expectations of a monitoring channel are not fulfilled, the drive coasts to a standstill (two channel) and an appropriate message is output.

Forced dormant error detection using test stop

The functions and switch-off signal paths must be tested at least once within a defined time in order to meet requirements as per ISO 13849-1 and IEC 61508 in terms of timely fault detection. This must be implemented either in cyclic manual mode or the test stop must be automatically initiated as part of the process. The test stop cycle is monitored, and after a specific time has been exceeded, an alarm is output. A test stop does not require a POWER ON. The acknowledgment is set by canceling the test stop request.

Examples of when forced dormant error detection must be performed:

- When the drives are at a standstill after the system has been switched on
- Before the protective door is opened
- At defined intervals (e.g. every 8 hours)
- In automatic mode, time and event-driven
- When the drives are at a standstill after the system has been switched on
- Before the protective door is opened
- At defined intervals (e.g. every 8 hours)
- In automatic mode, time and event-driven

¹⁾ Only applies to SINAMICS G Control Unit CU250S-2 and SINAMICS S. Available for SINAMICS G via hardware versions "-F".

Function

Safe speed/position sensing without/with encoder

Safe actual value sensing without encoder

A drive monitor with encoder is necessary for operation of a series of safety functions.

For applications with encoderless mode or with encoders that have no safety capability, the safety functions can also be implemented without encoder. It is not possible to use all safety functions in this case.

In operation without encoder, the actual speed values are calculated from the measured electrical actual values. This means that speed monitoring is also possible during operation without an encoder.

Safe actual value sensing with encoder

Incremental encoders or absolute encoders can be used for safe sensing of the position values on a drive.

Safe actual value sensing relies on redundant evaluation of the incremental tracks A/B that supply sin/cos signals of $1 V_{pp}$. Only encoders of the type whose A/B track signals are created and processed using purely analog techniques can be used.

HTL/TTL incremental encoders may also be used. In this case, safe actual value sensing is achieved by using two independent encoders. The minimum possible speed resolution must also be taken into account.

The encoder signals are input via Sensor Modules.

As an alternative, motors with an integrated DRIVE-CLiQ interface can be used. The speed or position actual values are generated directly in the motor as safe values and are transferred to the Control Unit over safe communication via DRIVE-CLiQ.

Certified built-on rotary encoders with DRIVE-CLiQ interface may also be used (see <https://support.industry.siemens.com/cs/document/65402168>).

The encoder must be mechanically attached in such a manner that the encoder shaft is unable to unplug or slide off. For notes on this, see IEC 61800-5-2: 2016, Table D.16.

A list of Siemens motors that fulfill the electrical and mechanical requirements is available at: <https://support.industry.siemens.com/cs/document/33512621>

The following can be used for safe speed/position sensing:

- Single-encoder systems or
- Dual-encoder systems

Single-encoder system

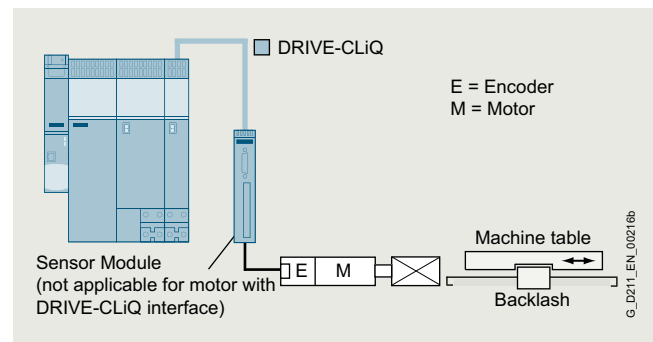

Example: Single-encoder system

In a single-encoder system, the motor encoder is used exclusively for safe actual value sensing.

Dual-encoder system

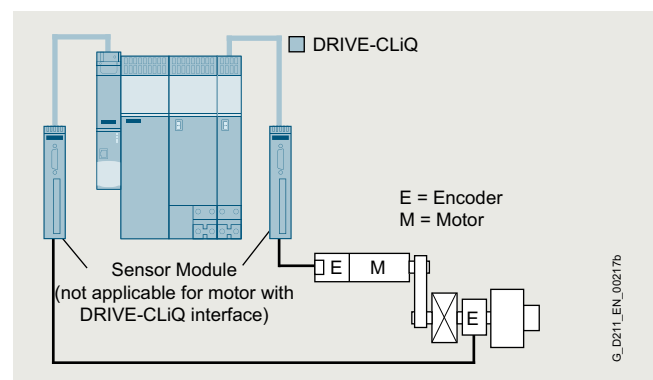

Example: Dual-encoder system

In the case of the dual-encoder system, the safe actual values for a drive are provided by two separate encoders. The actual values are transferred to the Control Unit over DRIVE-CLiQ. When motors without a DRIVE-CLiQ connection are used, a Sensor Module must be provided.

HTL/TTL incremental encoders can be used as an alternative with a dual-encoder system. Either two HTL/TTL encoders, one dual-HTL/TTL encoder or one HTL/TTL encoder and one sin/cos encoder can be used.

Safety Integrated

Safety Integrated

Function

The safety functions are listed below with criteria for actual value sensing:

	Functions	Abbreviation	With encoder	Without encoder	Description
Basic Functions	Safe Torque Off	STO	Yes	Yes	Safe Torque Off
	Safe Stop 1	SS1	Yes	Yes ¹⁾	Safe stopping process in accordance with stop category 1
	Safe Brake Control	SBC	Yes	Yes	Safe Brake Control
Extended Functions	Safe Torque Off	STO	Yes	Yes	Safe Torque Off
	Safe Stop 1	SS1	Yes	Yes ¹⁾	Safe stopping process in accordance with stop category 1
	Safe Brake Control	SBC	Yes	Yes	Safe Brake Control
	Safe Operating Stop	SOS	Yes	No	Safe monitoring of the standstill position
	Safe Stop 2	SS2	Yes	No	Safe stopping process in accordance with stop category 2
	Safely-Limited Speed	SLS	Yes	Yes ¹⁾	Safe monitoring of the maximum speed
	Safe Speed Monitor	SSM	Yes	Yes ¹⁾	Safe monitoring of the minimum speed
	Safe Direction	SDI	Yes	Yes ¹⁾	Safe monitoring of the direction of motion
	Safely-Limited Acceleration	SLA	Yes	No	Safely-Limited Acceleration
	Safe Brake Test	SBT	Yes	No	Diagnostic function for safe testing of the required holding torque of a brake
Advanced Functions	Safely-Limited Position	SLP	Yes	No	Safely-Limited Position
	Safe Position	SP	Yes	Yes ²⁾	Safe transfer of position values
	Safe Cam	SCA	Yes	No	Safe cams

¹⁾ The use of this safety function without encoder is permitted with asynchronous (induction) motors, or with reluctance motors.

²⁾ Only for the transmission of relative position values. An encoder is required to transmit absolute position values.

Integration

The safety functions integrated in SINAMICS drives, including SIMATIC ET 200pro FC-2 frequency converters, are listed below.

Safety Integrated	Low voltage Standard Performance frequency converters SINAMICS						Distributed frequency converters SINAMICS			SIMATIC ET 200pro FC-2 ⁶⁾
	V20	G120C	G120			G130 G150 CU320-2	G115D	G120D		
			CU230P-2	CU240E-2	CU250S-2			CU240D-2	CU250D-2	
Functions										
STO	–	✓	–	✓	✓	✓	✓	✓	✓	✓
SS1	–	–	–	✓ ¹⁾	✓ ²⁾⁸⁾	✓ ²⁾⁸⁾	–	✓ ¹⁾	✓ ¹⁾	–
SS2	–	–	–	–	–	✓ ¹⁾	–	–	–	–
SOS	–	–	–	–	–	✓ ¹⁾	–	–	–	–
SBC	–	–	–	–	✓	✓	–	–	–	–
SBT	–	–	–	–	–	✓ ¹⁾	–	–	–	–
SLS	–	–	–	✓ ¹⁾	✓ ²⁾	✓ ¹⁾	✓ ²⁾	✓ ¹⁾	✓ ¹⁾	–
SSM	–	–	–	✓ ¹⁾	✓ ²⁾	✓ ¹⁾	–	✓ ¹⁾	✓ ¹⁾	–
SDI	–	–	–	✓ ¹⁾	✓ ²⁾	✓ ¹⁾	–	✓ ¹⁾	✓ ¹⁾	–
SLA	–	–	–	–	–	✓ ¹⁾	–	–	–	–
SLP	–	–	–	–	–	✓ ³⁾	–	–	–	–
SP	–	–	–	–	–	✓ ³⁾	–	–	–	–
SCA	–	–	–	–	–	✓ ³⁾	–	–	–	–
Control										
PROFIsafe	–	✓	–	✓	✓	✓	✓	✓	✓	–
F-DI	–	✓	–	✓	✓	✓	✓	✓	✓	–

Safety Integrated	Low voltage Industry-specific frequency converters SINAMICS			Servo converters		High performance frequency converters		
	G120P CU230P-2	G120X	G180	V90	S110 CU305	S120 S120M		S150 CU320-2
						CU310-2	CU320-2	
Functions								
STO	–	✓ ⁷⁾	✓	✓	✓	✓	✓	✓
SS1	–	–	–	–	✓ ²⁾⁸⁾	✓ ²⁾⁸⁾	✓ ²⁾⁸⁾	✓ ²⁾⁸⁾
SS2	–	–	–	–	✓ ²⁾	✓ ²⁾	✓ ²⁾	✓ ²⁾
SOS	–	–	–	–	✓ ²⁾	✓ ²⁾	✓ ²⁾	✓ ²⁾
SBC	–	–	–	–	✓	✓	✓	✓
SBT	–	–	–	–	–	✓ ²⁾	✓ ²⁾	✓ ²⁾
SLS	–	–	–	–	✓ ²⁾	✓ ²⁾	✓ ²⁾	✓ ²⁾
SSM	–	–	–	–	✓ ²⁾	✓ ²⁾	✓ ²⁾	✓ ²⁾
SDI	–	–	–	–	✓ ²⁾	✓ ²⁾	✓ ²⁾	✓ ²⁾
SLA	–	–	–	–	–	✓ ²⁾	✓ ²⁾	✓ ²⁾
SLP	–	–	–	–	–	✓ ³⁾	✓ ³⁾⁴⁾	✓ ⁵⁾
SP	–	–	–	–	–	✓ ³⁾	✓ ³⁾⁴⁾	✓ ⁵⁾
SCA	–	–	–	–	–	✓ ³⁾	✓ ³⁾⁴⁾	✓ ⁵⁾
Control								
PROFIsafe	–	–	–	–	✓	✓	✓	✓
F-DI	–	✓	✓	✓	✓	✓	✓	✓

More Information

The Safety Integrated Function Manual contains detailed information about the safety functions

<https://support.industry.siemens.com/cs/document/109781722>

Further manuals pertaining to Safety Integrated in drive systems can be found on the internet at

<https://support.industry.siemens.com/cs/ww/en/ps/13206/man>

More information about Safety Integrated in SINAMICS can be found on the internet at

www.siemens.com/safety-drives

- 1) With fail-safe Control Unit.
- 2) With Safety Extended license.
- 3) With Safety Advanced license.
- 4) Safety Advanced license for cabinet modules on request.
- 5) Safety Advanced license on request.
- 6) Information on the SIMATIC ET 200pro FC-2 frequency converter – depending on the SIMATIC ET 200pro station – is available at: www.siemens.com/et200pro-fc
- 7) With external safety relay.
- 8) Safe Stop 1 time-controlled (SS1-t) is also included in the Safety Integrated Basic functions.

Safety Integrated

Safety Integrated for SINAMICS G115D

Overview



The SINAMICS G115D distributed frequency converter offers the Safe Torque Off (STO) function as a standard feature.

The Safety Integrated function is completely integrated into the drive system. It can be activated via fail-safe digital inputs on the converter or via PROFINET or PROFIBUS with PROFIsafe.

The Safety Integrated function is implemented electronically and therefore offers short response times in comparison to solutions with externally implemented monitoring functions.

In addition, as of firmware V4.7 SP14 in conjunction with SINAMICS Startdrive from V18 SP1, the safety function SLS (Safely-Limited Speed) is available via Safety Extended license.

Function

Function	Control	Encoder required	License required
STO	<ul style="list-style-type: none"> • F-DI • PROFIsafe 	No	No
SLS	<ul style="list-style-type: none"> • F-DI • PROFIsafe 	No	Safety Extended

Overview



The PM250D Power Modules are generally prepared for Safety Integrated.

In conjunction with a standard Control Unit, the drive provides the safety function STO.

In conjunction with a fail-safe Control Unit, the drive can be turned into a Safety Integrated Drive with comprehensive safety functions.

The Safety Integrated functions are completely integrated into the drive system. They can be activated via fail-safe digital inputs on the Control Unit or via PROFINET with PROFIsafe.

The Safety Integrated functions are implemented electronically and therefore offer short response times in comparison to solutions with externally implemented monitoring functions.

Safety Integrated encoderless

The safety functions do not require a motor encoder; the implementation effort is minimal. Existing machines in particular can be updated with integrated safety technology without the need to change the motor or mechanical system.

The STO function can be used without any restrictions for all applications.

The SS1, SLS, SSM and SDI functions are only permissible for applications where the load can never cause acceleration. An encoder that is used for the purposes of motor control has no significance for the safety functions here.

Control Units

The availability of Safety Integrated functions depends on the type of Control Unit. Standard Control Units and fail-safe Control Units are available. All standard Control Units have STO.

The fail-safe Control Units offer Extended Functions (SLS, SDI, SSM) in addition to the Basic Functions (STO, SS1).

Benefits

Comparison between conventional and integrated safety systems

The safety functions integrated into the drive can greatly reduce the effort required to implement safety concepts.

The integrated safety functions provide support when setting up tailored safety concepts. Configurations of safety concepts are given below based on the example of the SINAMICS G120D.

Safe Torque Off (STO)

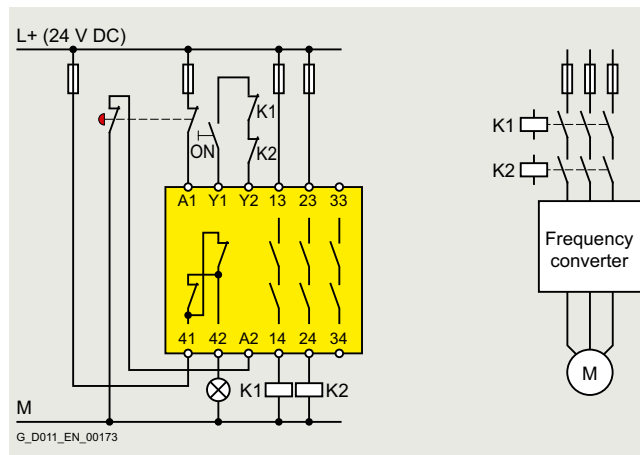

Classic implementation using an external circuit

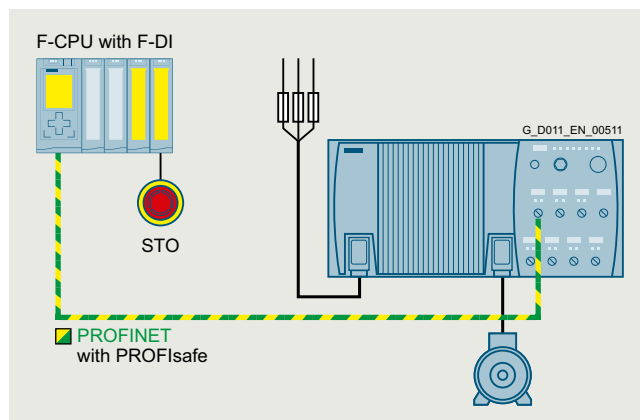

Integrated safety solution via PROFIsafe

Safety Integrated

Safety Integrated for SINAMICS G120D

Benefits

Safe Stop 1 (SS1)

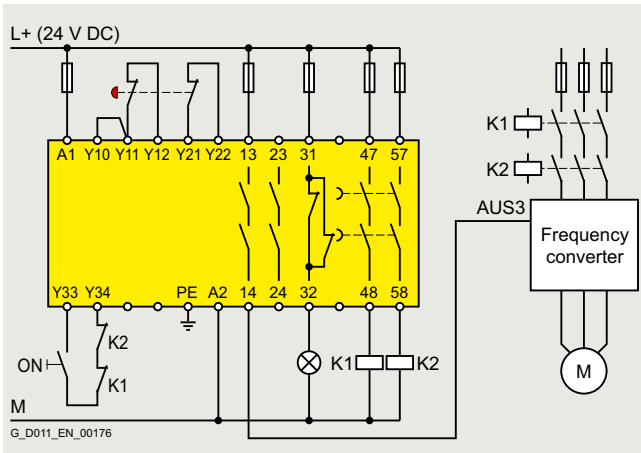

Classic implementation using an external circuit

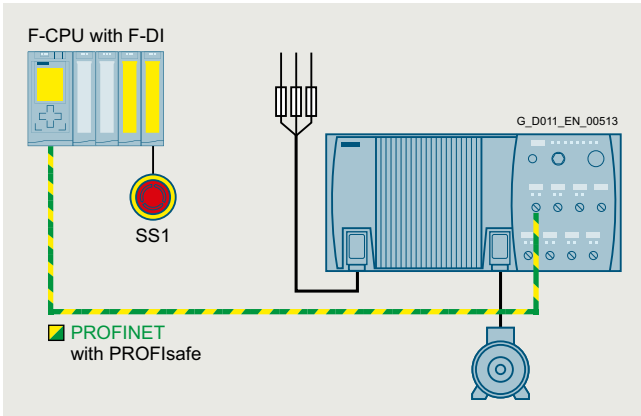

Integrated safety solution via PROFIsafe

Safely-Limited Speed (SLS)

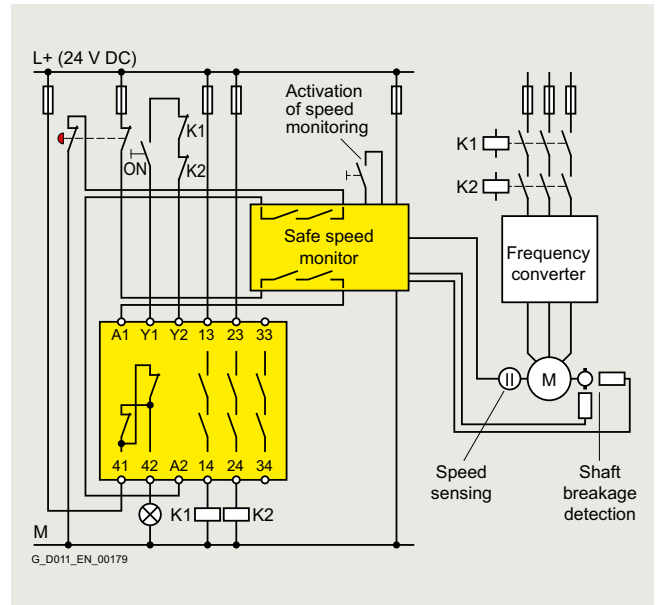

Classic implementation using an external circuit

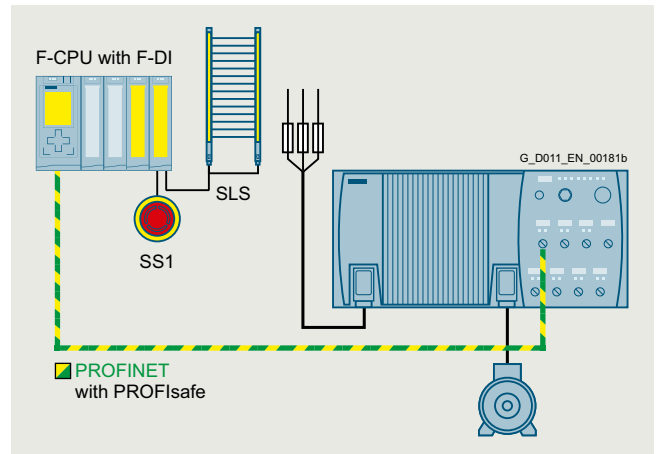

Integrated safety solution via PROFIsafe

Function

Function	Control	Underlying function	Reaction to limit overshoot	Encoder required	License required	Available in
Basic Functions						
STO	<ul style="list-style-type: none"> F-DI PROFIsafe 	–	–	No	No	<ul style="list-style-type: none"> CU240D-2 PN CU240D-2 PN-F CU240D-2 PN-F PP CU250D-2 PN-F CU250D-2 PN-F PP
SS1 time-controlled	<ul style="list-style-type: none"> F-DI PROFIsafe 	Following expiry of the parameterized delay time or if the speed falls below the minimum speed limit STO	STO	No	No	<ul style="list-style-type: none"> CU240D-2 PN-F CU240D-2 PN-F PP CU250D-2 PN-F CU250D-2 PN-F PP
Extended Functions						
SS1 with SBR/SAM	<ul style="list-style-type: none"> F-DI PROFIsafe 	Safe Acceleration Monitor (SAM) or Safe Brake Ramp (SBR) during braking. Following expiry of the parameterized delay time or if the speed falls below the minimum speed limit STO	STO	No	No	<ul style="list-style-type: none"> CU240D-2 PN-F CU240D-2 PN-F PP CU250D-2 PN-F CU250D-2 PN-F PP
SLS	<ul style="list-style-type: none"> F-DI PROFIsafe 	–	STO, SS1 (can be parameterized)	No	No	<ul style="list-style-type: none"> CU240D-2 PN-F CU240D-2 PN-F PP CU250D-2 PN-F CU250D-2 PN-F PP
SDI	<ul style="list-style-type: none"> F-DI PROFIsafe 	–	STO, SS1 (can be parameterized)	No	No	<ul style="list-style-type: none"> CU240D-2 PN-F CU240D-2 PN-F PP CU250D-2 PN-F CU250D-2 PN-F PP
SSM	<ul style="list-style-type: none"> Always active 	–	Signals that the speed has fallen below a specified value	No	No	<ul style="list-style-type: none"> CU240D-2 PN-F CU240D-2 PN-F PP CU250D-2 PN-F CU250D-2 PN-F PP

Safety Integrated

Safety Integrated for SIMATIC ET 200pro FC-2

Overview



SIMATIC ET 200pro FC-2

The SIMATIC ET 200pro FC-2 frequency converter offers the Safe Torque Off (STO) function as a standard feature.

The Safety Integrated function is completely integrated into the drive system. It is controlled via the SIMATIC ET 200pro system. The SIMATIC ET 200pro F-RSM Safety local isolator and PROFIsafe F-Switch Safety modules can be used to control the F0 Safety rail. The converter evaluates the F0 safety rail.

The Safety Integrated function is implemented electronically and therefore offers short response times in comparison to solutions with externally implemented monitoring functions.

Function

Function	Control	Encoder required	License required
STO	<ul style="list-style-type: none"> via SIMATIC ET 200pro system 	No	No

Energy efficiency



4/2 4/2	Energy efficiency Success factor Energy Efficiency
4/3	SIMATIC Energy Suite – integrated energy management
4/4 4/5	Energy-efficient drives Overview of the energy-saving functions for SINAMICS drives
4/7	Energy efficiency classes in accordance with IEC 61800-9-2

Further information about energy efficiency including references from industrial production can be found at www.siemens.com/energy-efficiency www.siemens.com/energysaving

Energy efficiency

Energy efficiency

Overview

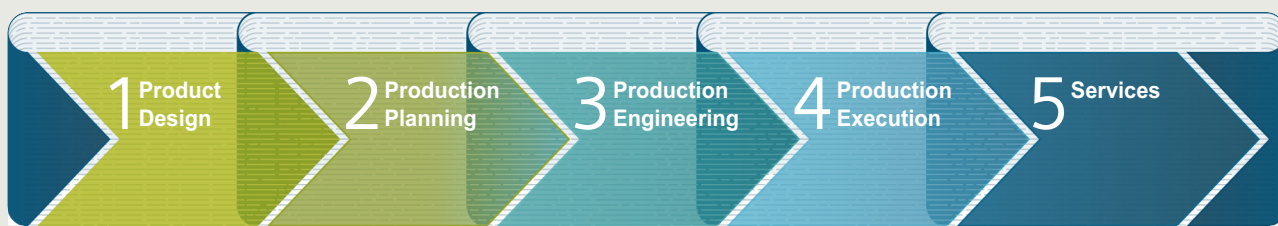

G_D011_EN_00555

4

Success factor Energy Efficiency

Siemens helps you to optimize your energy demand, reduce your energy costs and increase your competitive advantage

Industry is facing enormous challenges: Production processes need to be highly productive, energy-efficient, and resource-saving. Siemens is offering an energy efficiency concept that continually and systematically reduces the power consumption of machines and equipment and thereby boosts the competitive advantage of industrial producers. When implementing energy-efficient solutions, Siemens not only assesses the production process as a whole, but also evaluates each individual production step.

1 Product Design

Improve your confidence in planning outcomes! It is important to know the costs associated with the operation of a production machine so that these can be taken into account in the machine design. For example, the SinaSave software application can help you to calculate how soon you will recoup your investment if you purchase an energy-efficient drive. The Mechatronic Support simulation package will also provide you with the means to test and optimize your machine concept, Helping you to save time, energy and operating expenses. See also the SIZER for Siemens Drives engineering tool (integrated in the TIA Selection Tool).

SinaSave: www.siemens.com/sinasave

SIZER for Siemens Drives (integrated in the TIA Selection Tool): www.siemens.com/sizer

2 Production Planning

Make your plant more profitable! It is possible to carry out an on-screen simulation of individual machines and even the entire production process. By doing this, you can optimize the efficiency and productivity of production processes. For example, you can use the digital models and analysis functions provided by the Plant Simulation tool in order to optimize the motion sequences of your machines, prevent load peak overlaps, recover energy and optimize speeds.

Plant Simulation: www.siemens.com/tecnomatix

3 Production Engineering

Optimize the workflow! The SIMATIC Energy Manager PRO management tool helps you to achieve efficient control of energy and costs. But this requires perfectly coordinated communication and operation between hardware and software. Using the TIA Portal engineering framework, for example, it is easy to set up and optimize every single engineering process. You can then see at a glance the areas in your plant that can be made more productive and environmentally friendly. See also the STARTER commissioning tool and the SINAMICS Startdrive commissioning tool.

SIMATIC Energy Manager PRO:

www.siemens.com/energymanagerpro

TIA Portal: www.siemens.com/tia-portal

STARTER: www.siemens.com/starter

SINAMICS Startdrive: www.siemens.com/startdrive

4 Production Execution

Use innovative drive technology to reduce your energy consumption! The energy-efficient components and systems developed by Siemens can cut the energy consumption of a plant. Important components in an energy-efficient plant are, for example, frequency converters with regenerative feedback functions for applications with variable speeds or soft starters for fixed-speed drives. With its PROEnergy system, Siemens is also offering solutions that permit centralized shutdown of loads or entire production units during production breaks – a vendor- and device-neutral interface for flexible use over short or long production breaks.

5 Services

Improve your productivity and efficiency while reducing total costs! With its Energy & Environmental Services, Siemens is offering a tailored consultancy that will provide you with the necessary support in designing and implementing systematic energy and environmental management solutions. It will give you the satisfaction of achieving maximum energy efficiency throughout your company.

More information

Further information about energy efficiency including references from industrial production can be found at www.siemens.com/energy-efficiency www.siemens.com/energysaving

SIMATIC Energy Suite – integrated energy management

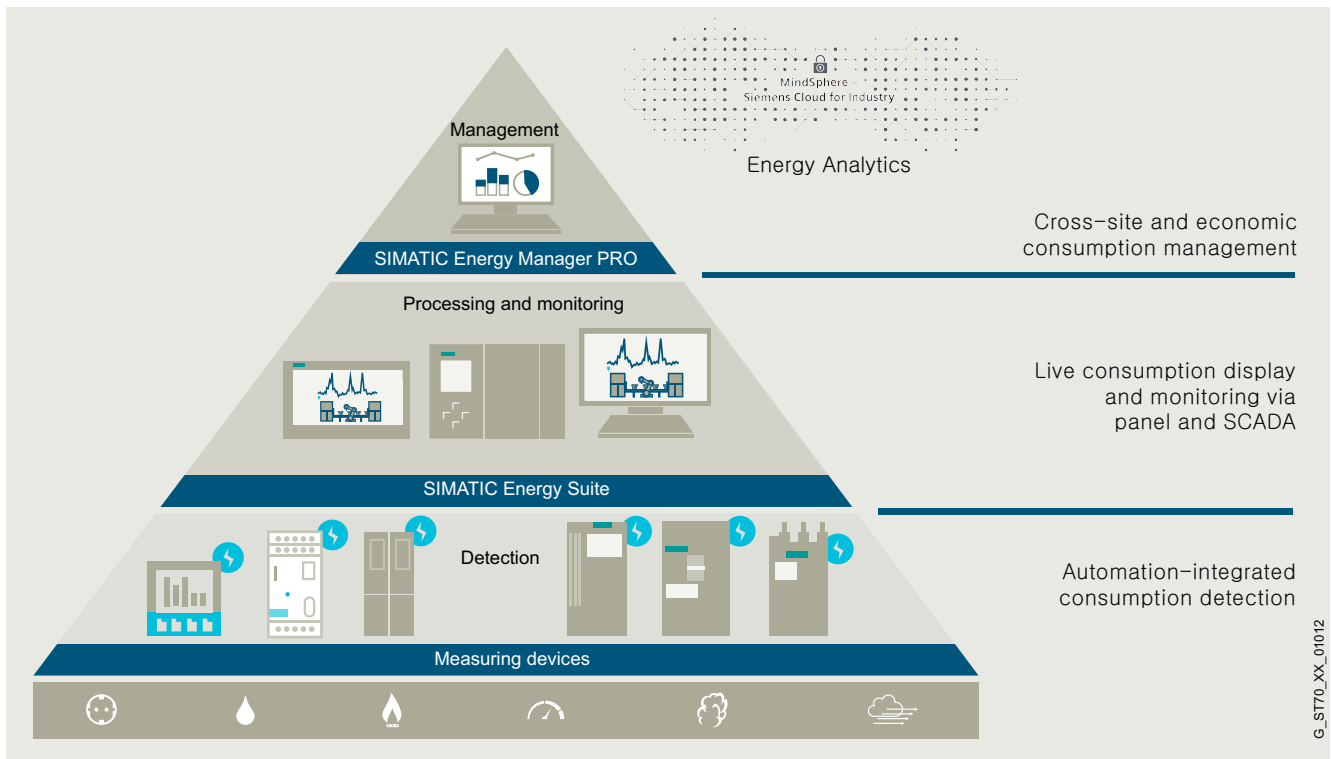

A high energy consumption and automated production are typical for many industries.

If you want to keep your energy costs under control in the long term and you are already focusing on the digital future, you will equip your plant with integrated energy measuring technology, thus anchoring your energy management in the automation of your production processes – which is where most energy is consumed. SIMATIC Energy Suite as an integrated option for the TIA Portal efficiently links energy management with automation, thus creating energy transparency in production. The considerably simplified configuration of energy measuring components from the product families²⁾ SIMATIC, SENTRON, SINAMICS, SIRIUS and SIMOCODE significantly reduces the configuration costs. Thanks to the end-to-end connection to SIMATIC Energy Manager PRO¹⁾ or cloud-based Service Energy Analytics, you can seamlessly expand the recorded energy data to create a cross-site energy management system.

This additionally enables companies to satisfy all the required economic and energy management aspects – from the purchasing of energy and planning all the way to energy controlling.

The advantages at a glance:

- Automatic generation of energy management data
- Integration into TIA Portal and into automation
- Simple configuration

Highlights

- Simple and intuitive configuration instead of programming
- Automatic generation of the PLC energy program
- Convenient integration of measuring components from the Siemens portfolio and from the portfolio of other vendors
- Integrated into the TIA Portal and automation
- Archiving on WinCC Professional or PLC
- Seamless connection to Energy Manager PRO and Energy Analytics

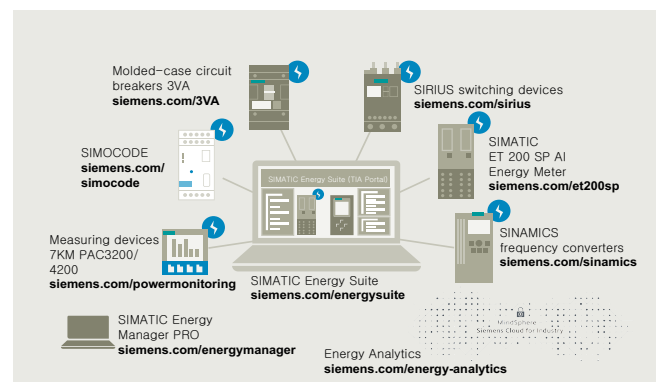

Ready for
SIMATIC
Energy Suite

Further information on
SIMATIC Energy Suite:
www.siemens.com/energysuite

¹⁾ SIMATIC Energy Manager PRO is the innovative successor to SIMATIC B.Data

²⁾ Products of the SIMATIC, SENTRON, SINAMICS, SIRIUS and SIMOCODE product families. You can find details on the currently supported devices here:
www.siemens.com/energysuite-hardware

Energy efficiency

Energy-efficient drives

Overview

Energy-efficient SINAMICS drives save energy in an intelligent way

Exploit energy-saving potential and optimize energy consumption: You can - with intelligent SINAMICS drives. Depending on the application in question, energy consumption can be controlled by motor speed adjustment to suit the individual process and achieve the greatest possible energy savings. The energy consumption of drives for turbo machines can be cut by as much as 60 %. Regenerative feedback is also an option for many applications. Our portfolio of frequency converters is the most comprehensive and standardized range on the market and the first choice for anyone seeking an energy-efficient drive – at low-voltage or medium-voltage level.

Energy-efficient drives with intelligent functions

Depending on the application and load profile, the intelligent energy-saving functions of SINAMICS drives can cut energy consumption.

PROEnergy



Provides energy-related status data for the system components to create transparency for the energy management; energy savings by selective shut-down of plants or plant sections.

ECO mode



In ECO mode, the operating point of the motor in the partial-load range is automatically adjusted and optimized. This reduces motor losses, for example, in machines that do not need a high torque over the entire operating range.

Hibernation mode



Variable-speed drives that are not required to operate continuously are switched to standby or "Hibernation mode". The drive is restarted again as soon as it is needed.

Bypass mode

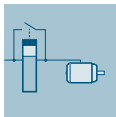

In bypass mode it is possible to "bypass" the converter electrically as soon as the motor is frequently operating close to its rated speed. This solution helps reduce converter losses and so increase overall efficiency.

Cascading

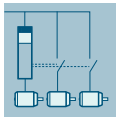

In pump, fan and compressor applications involving high outputs, the entire power demand is distributed among several motors. Phased connection and disconnection by means of partially or fully controlled cascades in combination with converters make a drive system more energy-efficient.

Energy balancing

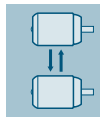

Through the use of converters with coupled drives, energy is exchanged through the common DC link. Through the direct energy exchange from one converter to the next, it is possible to minimize power losses in the system.

Reactive power compensation

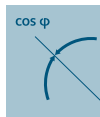

The use of SINAMICS converters with Active Line Modules reduces the capacitive and/or inductive reactive power in the machine. It is then possible to dispense with costly reactive power compensation systems.

Kinetic energy buffering



With dynamic reversing operations in single-axis and multi-axis systems, the kinetic energy available in the system is reused. A motor connected to the common DC link is used to buffer kinetic energy.

Electrical energy buffering



With dynamic reversing operations in single-axis and multi-axis systems, the kinetic energy available in the system is reused. A capacitor module connected to the common DC link is used to buffer electrical energy.

Optimized pulse patterns

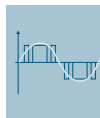

Thanks to optimized clock frequency and pulse pattern, SINAMICS G and SINAMICS S are perfectly suited to SIMOTICS motors. The benefits: Optimization of performance and system efficiency, reduced system losses as well as lower temperature and noise levels.

Energy usage counter/Energy saving counter



Actual energy usage can be displayed during operation. Furthermore, an energy saving counter can be installed to indicate the cumulative energy savings during machine operation as compared to a fixed-speed application.

Regenerative feedback

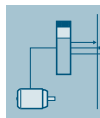

In conventional drive systems, the energy produced during braking is converted to heat using braking resistors. SINAMICS G and SINAMICSS converters with regenerative feedback capability need no braking resistor, and supply the resulting braking energy back into the line.

DC link coupling with SINAMICS V20

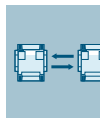

Applications with two SINAMICS V20 converters with the same power rating can share a common DC link in order to reuse regenerated energy.

Integration

Overview of the energy-saving functions for SINAMICS drives including SIMATIC ET 200pro FC-2 frequency converters

Energy-saving function	Low voltage									
	Standard performance frequency converters						Distributed frequency converters			
	SINAMICS						SINAMICS			SIMATIC
	V20	G120C	G120			G130 G150	G115D	G120D		ET 200pro FC-2 ¹⁾
			CU230P-2	CU240E-2	CU250S-2	CU320-2		CU240D-2	CU250D-2	
Functions										
ECO mode	✓	✓	✓	✓	✓	–	✓	✓	✓	✓
Hibernation mode	✓	–	✓	–	–	–	–	–	–	–
Bypass mode	–	–	✓	–	–	✓	–	–	–	–
Cascading	✓	–	✓	–	–	–	–	–	–	–
Energy balancing	✓	–	–	–	–	–	–	–	–	–
Reactive power compensation	–	–	–	–	–	–	–	–	–	–
Kinetic energy buffering	–	–	–	–	–	–	–	–	–	–
Electrical energy buffering	–	–	–	–	–	–	–	–	–	–
Optimized pulse patterns	–	–	–	–	–	✓	–	–	–	–
Energy usage counter/Energy saving counter	✓	✓	✓	✓	✓	✓	✓	✓	✓	✓
Regenerative feedback	–	–	✓ with PM250 Power Module	✓ with PM250 Power Module	✓ with PM250 Power Module	–	–	✓	✓	✓
Communication protocol and profile										
PROFINET	–	✓	✓	✓	✓	✓	✓	✓	✓	✓
• PROFINET energy	–	✓	✓	✓	✓	✓	✓	✓	✓	✓
Ready for SIMATIC Energy Suite										
Integrated energy management	–	✓	✓	✓	✓	–	✓	✓	✓	–

¹⁾ Information on the SIMATIC ET 200pro FC-2 frequency converter – depending on the SIMATIC ET 200pro station – is available at: www.siemens.com/et200pro-fc

Energy efficiency

Energy-efficient drives

Integration

Energy-saving function	Low voltage								
	Industry-specific frequency converters			Servo converters			High performance frequency converters		
	SINAMICS								
	G120P	G120X	G180	V90	S110	S120 S120M	S150		
CU230P-2				CU305	CU310-2	CU320-2	CU320-2		
Functions									
ECO mode	✓	✓	–	–	✓	✓	✓	–	–
Hibernation mode	✓	✓	–	–	–	–	–	–	–
Bypass mode	✓	✓	✓	–	–	✓	✓	✓	–
Cascading	✓	✓	–	–	–	–	–	–	–
Energy balancing	–	–	–	–	–	✓ for multi-axis drives only	✓ for multi-axis drives only	–	–
Reactive power compensation	–	–	–	–	–	✓ with Active Line Module	✓ with Active Line Module	✓	–
Kinetic energy buffering	–	–	✓	–	–	✓ for multi-axis drives only	✓ for multi-axis drives only	–	–
Electrical energy buffering	–	–	–	–	–	✓ for multi-axis drives only	✓ for multi-axis drives only	–	–
Optimized pulse patterns	–	–	–	–	–	✓	✓	✓	–
Energy usage counter/Energy saving counter	✓	✓	–	–	–	✓	✓	✓	–
Regenerative feedback	–	–	–	–	–	✓ with Smart Line Module or Active Line Module	✓ with Smart Line Module or Active Line Module	✓	–
Communication protocol and profile									
PROFINET	✓	✓	✓	–	✓	✓	✓	✓	–
• PROFinergy	✓	✓	–	–	–	✓	✓	✓	–
Ready for SIMATIC Energy Suite									
Integrated energy management	✓	✓	–	–	–	✓	–	–	–

More information

Information on the SIMATIC ET 200pro FC-2 frequency converter with PROFINET or PROFIBUS DP - depending on the SIMATIC ET 200pro station - is available at www.siemens.com/et200pro-fc

Overview

Step by step to more efficiency

One of the core objectives of the European Union is a sustainable power industry. In industrial plants today, around 70 % of the power demand is from electrically driven systems. This high percentage contains huge potential for saving energy in electrical drives. For that reason, the European Union introduced minimum requirements for the energy efficiency of electric motors in the form of a statutory motor regulation as early as 2011.

These activities are extended by the 2019/1781 EU regulation dealing with stricter requirements for DOL (Direct On Line) motors and defining efficiency limits for frequency converters. The regulation provides a legal basis for technical content regarding the efficiency of specific products and services. Standardization, however, has played a leading role in determining the field and the available market technology.

Energy efficiency improvement is supported through a systematic selection of the most efficient converter and drive system technology via the IEC 61800-9 series of standards. Part 1 specifies the methodology to determine the energy efficiency index of an application based on the extended product approach (EPA) and semi analytical models (SAMs), while Part 2 provides indicators for assessing the energy efficiency performance and the classification of converters and drive systems. To take account of the different use cases, consideration of eight application-relevant operating points has been introduced as mandatory for the first time. Determination of loss values at these eight points and definition of efficiency classes are laid down by the standard in a uniform way. This enables data relevant to operation, such as application-specific load profiles, to now be taken into account more easily in the energy efficiency analysis.

The standard is especially important for variable-speed drives of the following types:

- for AC/AC converters without energy recovery functionality
- for motors with integrated converters
- for supply voltages of 100 V to 1000 V
- for power ratings of 0.12 kW to 1000 kW

To cover all applications of driven machines, the IEC 61800-9-2 standard defines operating points in full-load and partial-load operation, at which the losses of the motor and drive systems have to be determined. Based on the loss data at the operating points in partial-load operation, variable-speed drives can be explicitly considered in more detail. This makes their advantages especially clear.

Centrifugal pumps, fans

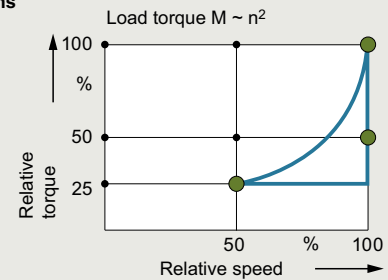

Hoisting gear, extruders, conveyor belts

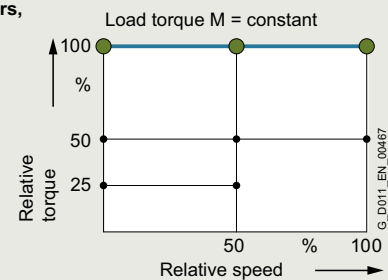

Winders, coilers

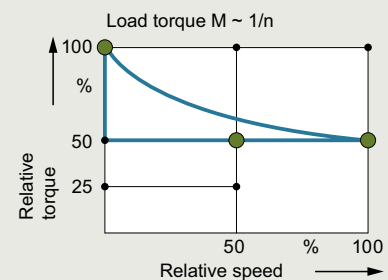

Duty cycles for different driven machines

Moreover, frequency converters and motor systems are classified in efficiency classes, which permit an initial rough estimate of the potential saving. Definition of reference systems is a key aspect of this because they provide standard reference values. The positioning of these reference systems defines the efficiency class. The relative distance from the reference system can be used as an absolute measure of the efficiency at the operating point in question.

Energy efficiency

Energy efficiency classes in accordance with IEC 61800-9-2

Overview

Advantages of the detailed loss consideration of IEC 61800-9-2 over the previous consideration of efficiencies and maximum loss values

For motors, the efficiency consideration was previously only defined for operation without a converter at 50/60 Hz. It provides a good way of comparing the energy efficiency of motors from different manufacturers for this use case.

The more detailed loss analysis of IEC 61800-9-2, on the other hand, is aimed at speed-controlled operation and therefore now also includes motors especially designed for converter operation in the energy analysis. These were previously not covered by the applicable standards.

Moreover, a loss analysis over the entire setting and load range of the motor is possible. This is done in accordance with the standard IEC 61800-9-2 with typical values.

For holistic consideration, it is essential to include all the relevant components of a drive system. The IEC 61800-9-2 standard defines this in detail. The standardized expression of power loss data as a percentage makes comparison considerably easier and more transparent.

The method also makes it possible to consider a motor that produces a holding torque at speed zero, for example. In this case, the efficiency is zero, but a power loss from current producing magnetization and holding torque does occur. In summary, the key advantage of standard IEC 61800-9-2 is the ability to perform the energy analysis of an electrical drive system based on standardized load profiles in all operating ranges due to uniform general conditions. This provides the user with complete transparency irrespective of the manufacturer.

Establishing efficiency classes of frequency converters (Complete Drive Modules CDM)

To avoid overmodulation and to ensure comparability between makes, which cannot be achieved otherwise, the efficiency classes of CDMs refer to the 90/100 operating point (90 % motor stator frequency, 100 % torque current).

Standard IEC 61800-9-2 defines the relative losses of a CDM in efficiency classes IE0 to IE2. With reference to the value of a CDM of efficiency class IE1 (reference converter), a CDM of efficiency class IE2 has 25 % lower losses and a CDM of efficiency class IE0 has 25 % higher losses.

The publication of the 2019/1781 EU regulation has made mandatory the fulfillment of the ecodesign requirements for the declaration of product conformity.

AC/AC converters belonging to the aforementioned categories (specific voltage and power level without regenerative capability) have to fulfill efficiency class IE2 in order to be approved for installation/utilization within EU.

Operating points for CDMs

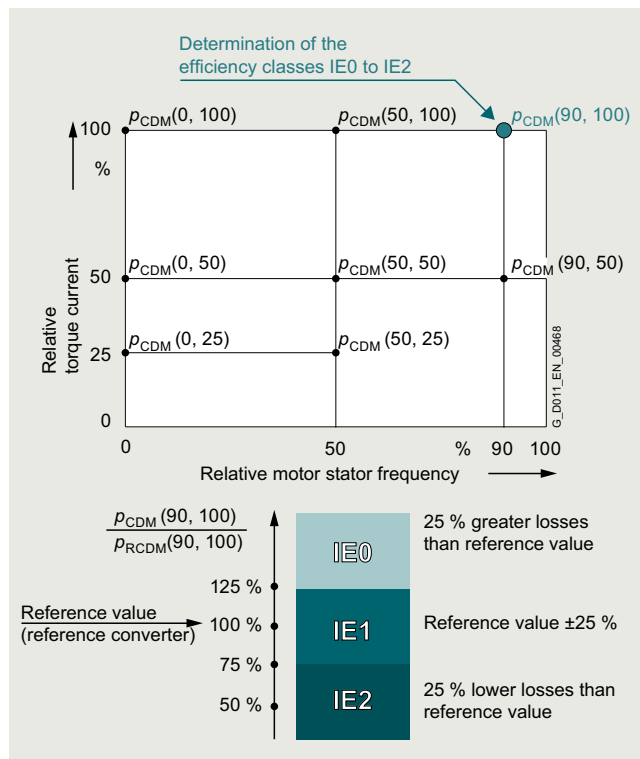

Complete Drive Module (CDM) – determining the efficiency class

Establishing the efficiency classes of drive systems (Power Drive Systems PDS)

What is possible for the individual systems, of course, also applies to the entire electrical PDS (frequency converter plus motor). Detailed comparisons are now possible at this level, too. The reference values for the reference system provide clear indications of the energy performance of the PDS.

Because targeted matching of the motor and CDM provides additional potential for optimization in electrical drive systems, it is especially important for the user to consider the entire drive system.

For the efficiency class of a PDS, too, a specific load point is defined. In this case, the reference point used is the 100/100 operating point (100 % motor stator frequency, 100 % torque).

Standard IEC 61800-9-2 defines the relative losses of a PDS in efficiency classes IES0 to IES2. With reference to the value of a PDS of efficiency class IES1 (reference drive), a PDS of efficiency class IES2 has 20 % lower losses and a PDS of efficiency class IES0 has 20 % higher losses.

Overview

Operating points for PDS

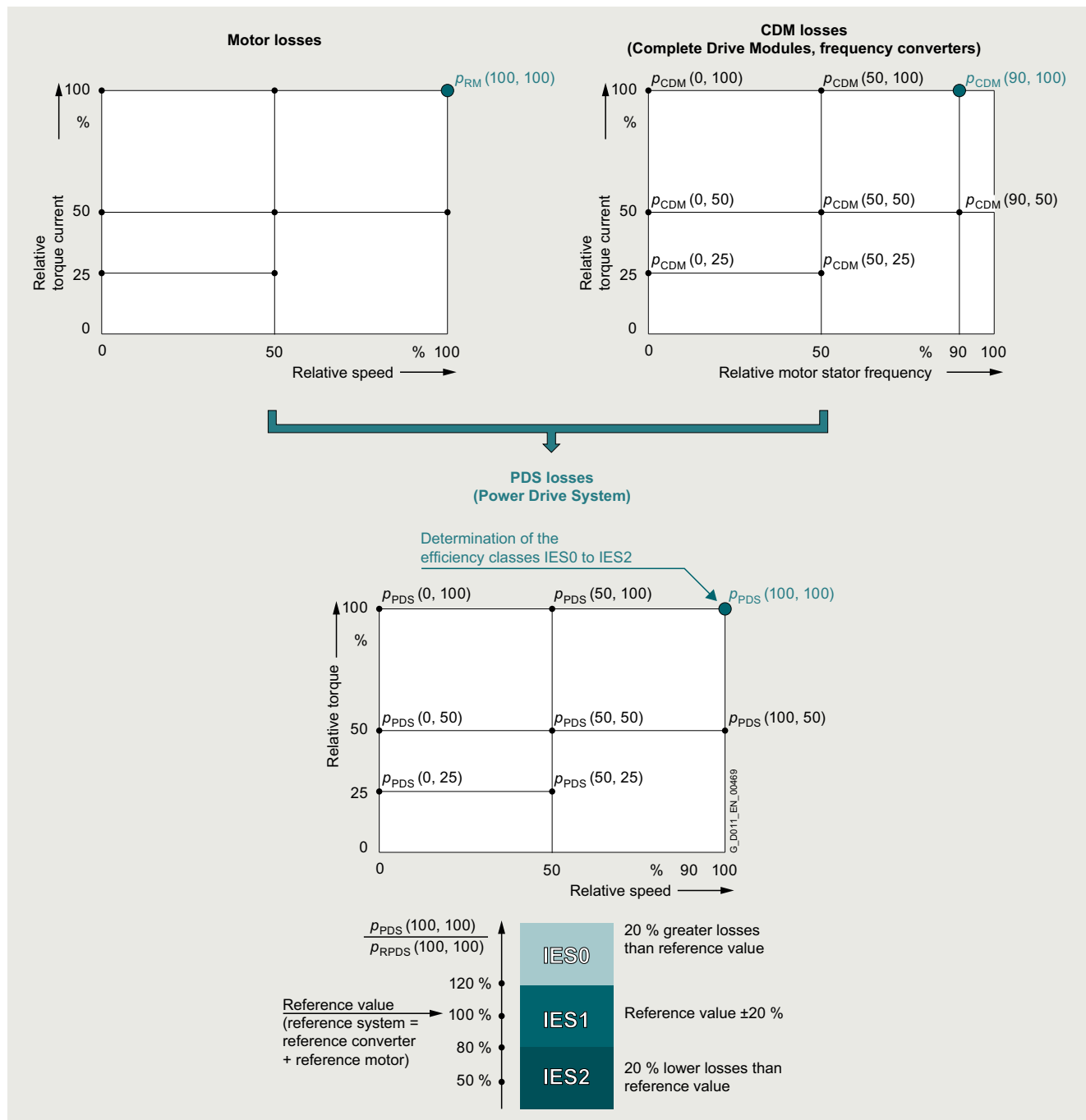

Power Drive System (PDS) – determining the efficiency class

More information

Power loss data of SINAMICS converters for single-axis drives are available

- for SINAMICS V20, SINAMICS G115D/G120/G120C/G120D/G120P/G120X/G130/G150/G180 and SINAMICS S110/S120/S150 on the internet at <https://support.industry.siemens.com/cs/document/94059311>
- for SINAMICS G220 via ID-Link or Siemens Product Configurator in SiePortal at www.siemens.com/sinamics-g220/configuration

More information on current laws and standards, new standards, and mandatory guidelines is available on the internet at www.siemens.com/legislation-and-standards

Energy efficiency

Notes

4

Communication

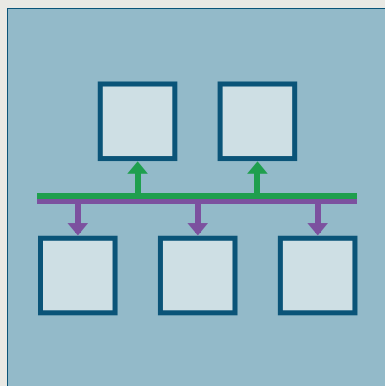

5/2	Communication
5/2	Communication overview
5/4	PROFINET
5/8	PROFIdrive
5/9	PROFIBUS
5/10	Industrial Ethernet
5/11	EtherNet/IP
5/11	Modbus RTU
5/11	AS-Interface
5/11	USS

Further information regarding PROFINET and PROFIBUS can be found at www.profibus.com

Communication

Communication

Overview

Communication overview

Digital bus systems are commonly used in industrial automation today. These handle communication between the control level, the machine control, the sensors and actuators. The SINAMICS product family offers integrated communication interfaces in all product groups – which can be used to connect the most important fieldbus systems in the simplest possible way.

The properties and special application areas of the various bus systems for SINAMICS converters incl. SIMATIC ET 200pro FC-2 frequency converters are briefly described in the following.

Protocol	Low voltage										
	Standard performance frequency converters						Distributed frequency converters				
	SINAMICS						SINAMICS				SIMATIC ET 200pro FC-2 ¹⁾
	V20	G120C	G120			G130 G150	G115D	G120D			
		CU230P-2	CU240E-2	CU250S-2	CU320-2		CU240D-2	CU250D-2			
PROFINET	-	✓	✓	✓	✓	✓	✓	✓	✓	✓	
- PROFINET RT	-	✓	✓	✓	✓	✓	✓	✓	✓	✓	
- PROFINET IRT isochronous	-	-	-	-	-	-	-	-	-	-	
- PROFINET IRT not isochronous	-	✓	✓	✓	✓	✓	✓	✓	✓	✓	
- PROFINET Shared Device	-	✓	✓	✓	✓	✓	-	✓	✓	✓	
- PROFINET media redundancy MRP (step-change)	-	✓	✓	✓	✓	✓	✓	✓	✓	✓	
- PROFINET media redundancy MRPD (bumpless)	-	✓	✓	✓	✓	✓	✓	✓	✓	-	
- System redundancy S2	-	-	-	-	-	✓	-	-	-	-	
- PROFIsafe	-	✓	-	✓	✓	✓	✓	✓	✓	✓	
- PROFInergy	-	✓	✓	✓	✓	✓	✓	✓	✓	✓	
- PROFIdrive application class 1	-	✓	✓	✓	✓	✓	✓	✓	-	✓	
- PROFIdrive application class 3	-	-	-	-	✓	-	-	-	✓	-	
- PROFIdrive application class 4	-	-	-	-	-	-	-	-	-	-	
PROFIBUS DP	-	✓	✓	✓	✓	✓	-	-	-	✓	
- PROFIBUS DP equidistance and isochronous mode	-	-	-	-	-	-	-	-	-	-	
- PROFIBUS DP peer-to-peer communication	-	✓	✓	✓	✓	✓	-	-	-	-	
EtherNet/IP	-	✓	✓	✓	✓	✓	✓	✓	✓	-	
Modbus TCP	-	-	-	-	-	✓	-	-	-	-	
Modbus RTU	✓	✓	✓	✓	✓	-	-	-	-	-	
AS-Interface	-	-	-	-	-	-	✓	-	-	-	
BACnet MS/TP	-	-	✓	-	-	-	-	-	-	-	
CANopen	-	-	-	-	-	-	-	-	-	-	
USS	✓	✓	✓	✓	✓	✓	-	-	-	-	
FLN P1	-	-	✓	-	-	-	-	-	-	-	
Web server	✓ ²⁾	✓ ²⁾	✓ ²⁾	✓ ²⁾	✓ ²⁾	✓	✓ ²⁾	-	-	-	

¹⁾ Information on the SIMATIC ET 200pro FC-2 frequency converter with PROFINET, PROFIBUS DP or EtherNet/IP – depending on the SIMATIC ET 200pro station – is available at www.siemens.com/et200pro-fc

²⁾ Function possible with optional SINAMICS G120 Smart Access web server module.

Overview

Protocol	Low voltage							
	Industry-specific frequency converters			Servo converters		High performance frequency converters		
	SINAMICS							
	G120P	G120X	G180	V90	S110	S120 S120M	S150	
CU230P-2		CB08		CU305	CU310-2	CU320-2	CU320-2	
PROFINET	✓	✓	✓ ²⁾	✓	✓	✓	✓	✓
- PROFINET RT	✓	✓	✓ ²⁾	✓	✓	✓	✓	✓
- PROFINET IRT isochronous	–	–	–	✓	✓	✓	✓	✓
- PROFINET IRT not isochronous	✓	✓	–	✓	✓	✓	✓	✓
- PROFINET Shared Device	✓	✓	–	–	✓	✓	✓	✓
- PROFINET media redundancy MRP (step-change)	✓	✓	✓ ²⁾	–	✓	✓	✓	✓
- PROFINET media redundancy MRPD (bumpless)	✓	✓	–	–	✓	✓	✓	✓
- System redundancy S2	–	–	✓ ²⁾	–	–	✓	✓	✓
- PROFIsafe	–	–	–	–	✓	✓	✓	✓
- PROFIenergy	✓	✓	–	–	–	✓	✓	✓
- PROFIdrive application class 1	✓	✓	–	✓	✓	✓	✓	✓
- PROFIdrive application class 3	–	–	–	✓	✓	✓	✓	✓
- PROFIdrive application class 4	–	–	–	✓	✓	✓	✓	✓
PROFIBUS DP	✓	✓	✓ ²⁾	–	✓	✓	✓	✓
- PROFIBUS DP equidistance and isochronous mode	–	–	–	–	✓	✓	✓	✓
- PROFIBUS DP peer-to-peer communication	✓	✓	–	–	✓	✓	✓	✓
EtherNet/IP	✓	✓	–	–	–	–	✓	✓
Modbus TCP	–	–	✓ ²⁾	–	–	✓	✓	✓
Modbus RTU	✓	✓	✓ ²⁾	✓	–	–	–	–
AS-Interface	–	–	–	–	–	–	–	–
BACnet MS/TP	✓	✓	–	–	–	–	–	–
CANopen	–	–	✓ ²⁾	–	–	–	–	–
USS	✓	✓	–	✓	✓	✓	✓	✓
FLN P1	✓	–	–	–	–	–	–	–
Web server	✓ ¹⁾	✓ ¹⁾	–	–	–	✓	✓	✓

¹⁾ Function possible with optional SINAMICS G120 Smart Access web server module.

²⁾ Function possible with optional communications modules (additional PCBs) for SINAMICS G180.

Communication

PROFINET

Overview



PROFINET – the Ethernet standard for automation

PROFINET is the world's leading Industrial Ethernet standard for automation with more than 40 million nodes installed worldwide.

PROFINET makes companies more successful, because it speeds up processes and raises both productivity and plant availability.

Your advantages at a glance

Flexibility	Efficiency	Performance
Tailor-made plant concepts	Optimal use of resources	Increased productivity
<ul style="list-style-type: none"> ▶ Industrial Wireless LAN ▶ Safety ▶ Flexible topologies ▶ Open standard ▶ Web tools ▶ Expandability 	<ul style="list-style-type: none"> ▶ One cable for everything ▶ Device/network diagnostics ▶ Energy efficiency ▶ Simple wiring ▶ Fast device replacement ▶ Ruggedness/stability 	<ul style="list-style-type: none"> ▶ Speed ▶ High precision ▶ Large quantity structures ▶ High transmission rate ▶ Redundancy ▶ Fast start-up

G_IK10_XX_10304

Overview

Flexibility

Short response times and optimized processes are the basic requirements for competitiveness in global markets because the product lifecycles are becoming shorter and shorter.

PROFINET ensures maximum flexibility in plant structures and production processes, and it enables you to implement innovative machine and plant concepts. For example, mobile devices can also be integrated at locations that are difficult to access.

Flexible topologies

In addition to the linear structure characterized by the established fieldbuses, PROFINET also enables the use of star, tree and ring structures. This is made possible by switching technology via active network components, such as Industrial Ethernet switches and media converters, or by integrating switch functionality into the field devices. This results in increased flexibility in the planning of machines and plants, as well as savings in cabling.

The PROFINET network can be installed without any specialist knowledge at all and meets all requirements that are relevant to the industrial environment. The "PROFINET Installations Guidelines" assist manufacturers and users with network planning, installation and commissioning. Symmetrical copper cables or RFI-resistant fiber-optic cables are used, depending on the application. Devices from different manufacturers are easily connected via standardized and rugged plug-in connectors (up to IP65/IP67 degree of protection).

By integrating switch functionality into the devices, linear topologies can be created that are directly oriented toward an existing machine or plant structure. This reduces cabling overhead and cuts down on components such as external switches.

IWLAN

PROFINET also supports wireless communication with Industrial Wireless LAN, thus opening up new fields of application. For example, technologies subject to wear, such as trailing cables, can be replaced and automated guided vehicle systems and mobile operator panels can be used.

Safety

The PROFIsafe safety profile, which has been tried and tested with PROFIBUS and which permits the transmission of standard and safety-related data on a single bus cable, can also be used with PROFINET. No special network components are necessary for fail-safe communication, which means that standard switches and standard network transitions can continue to be used without any restrictions. In addition, fail-safe communication is equally possible via Industrial Wireless LAN (IWLAN).

Open standard

PROFINET, the open multi-vendor standard (IEC 61158/IEC 61784), is supported by PROFIBUS and PROFINET International (PI). It stands for maximum transparency, open IT communication, network security and simultaneous real-time communication.

Thanks to its openness, PROFINET provides the basis for a standardized automation network in the plant, to which all other machines and devices can be connected. Even the integration of existing plant components, for example using PROFIBUS, presents no problems due to the use of network transitions.

Use of web tools

Thanks to the unrestricted support of TCP/IP, PROFINET permits the use of standard web services such as web servers. Irrespective of the tool used, information from the automation level can be accessed from virtually any location using a commercially available internet browser. This considerably simplifies commissioning and diagnostics. Users can then decide for themselves how much openness to the IT world they want to allow for their machine or plant. This means that PROFINET can be used simply as an isolated plant network or connected via appropriate Security Modules, such as the SCALANCE S modules, to the office network or the internet. In this way, new remote maintenance concepts or the high-speed exchange of production data become possible.

Expandability

On the one hand, PROFINET facilitates the integration of existing systems and networks without any great effort. In this way, PROFINET safeguards investments in existing plant components that communicate via PROFIBUS and other fieldbuses such as AS-Interface. On the other hand, additional PROFINET nodes can be added at any time. By using additional network components, network infrastructures can be expanded using cabling or wireless methods – even while the plant is operating.

Communication

PROFINET

Overview

Efficiency

Greater global competition means that companies must use their resources economically and efficiently. This applies in particular to production. This is where PROFINET ensures greater efficiency. Simple engineering guarantees fast commissioning, while reliable devices ensure a high level of plant availability. Comprehensive diagnostic and maintenance concepts help to reduce plant downtimes and keep maintenance costs to a minimum.

One cable for everything

PROFINET permits simultaneous fieldbus communication with isochronous mode and standard IT communication (TCP/IP) on one cable. This real-time communication for the transmission of user/process data and diagnostic data takes place on a single cable. Specific profile communication (PROFIsafe, PROFIdrive and PROFlenergy) can be integrated without any additional cabling. This solution offers a wide scope of functions at a low level of complexity.

Device and network diagnostics

By retaining the tried and tested PROFIBUS device model, the same diagnostics information is available with PROFINET. In addition, module-specific and channel-specific data can also be read out from the devices during device diagnostics, enabling faults to be located quickly and easily. Apart from the availability of device information, the reliability of network operation has top priority in the network management.

In existing networks the Simple Network Management Protocol (SNMP) has established itself as the de facto standard for the maintenance and monitoring of the network components and their functions. PROFINET uses this standard and gives users the opportunity to maintain their networks with tools that are familiar to them, such as the SINEMA Server network management software.

For easier maintenance of PROFINET devices, both on-site and remotely via a secure VPN connection, application-specific websites can be set up on the web server of the field devices using the familiar HTML standard.

Energy efficiency

Moving toward the green factory: PROFlenergy is a profile that provides functions and mechanisms for PROFINET field devices that support energy-efficient production.

The profile, which is defined by the PNO and is independent of any manufacturers or devices, enables energy demand and costs to be significantly reduced: Using PROFlenergy, any specific loads that are not currently being used can be switched off. This achieves a noticeable reduction in energy costs during breaks in production. PROFlenergy permits the simple, automated activation and deactivation of technologically related plant components. It is coordinated centrally by means of a higher-level controller and is networked via PROFINET. This ensures that as much energy as possible is saved during long breaks. Temporarily switching off plant components contributes to the even distribution and most efficient use of energy.

The use of PROFlenergy is made easy for the machine builder by its integration into familiar series of products. In addition, PROFlenergy is defined in such a way that the necessary function blocks can easily be integrated into existing automation systems at a later stage.

Simple wiring

Particularly stringent demands are made on the installation of cables in the industrial environment. In addition, there is a requirement to set up industry-standard networks in the shortest possible time without any special knowledge.

With FastConnect, Siemens offers a high-speed installation system that meets all of these requirements. FastConnect is the standard-compliant, industry-standard cabling system consisting of cables, connectors and assembly tools for PROFINET networks. The time required for connecting terminals is minimized by the simple installation method using just a single tool, while installation errors are prevented by the practical color-coding. Both copper cables and glass fiber optic cables can be easily assembled on site in this way.

Fast device replacement

PROFINET devices are identified by means of a name assigned during configuration. When replacing a defective device, a new device can be recognized from its topology information by the IO controller and a new name can be assigned to it automatically. This means that no engineering tool is necessary for the replacement of equipment.

This mechanism can even be used for the initial commissioning of a complete system. This speeds up commissioning, particularly in the case of series machines.

Ruggedness

An automation network must be able to withstand most external sources of interference. The use of Switched Ethernet prevents faults in one section of the network from affecting the entire plant network. For areas that are particularly prone to radio frequency interference (RFI), PROFINET allows the use of fiber optic cables.

Performance

Productivity and product quality determine the level of success in the market. Precise motion control, dynamic drives, high-speed controllers and the deterministic synchronization of devices are therefore key factors in achieving superior production. They facilitate high production rates and optimum product quality at the same time.

Speed and precision

Fast motion control applications demand precise and deterministic exchange of data. This is implemented by means of drive controllers using isochronous real time (IRT).

With IRT and isochronous mode, PROFINET permits fast and deterministic communication. This synchronizes the various cycles of a system (input, network, CPU processing and output), even in the case of parallel TCP/IP traffic. The short cycle times of PROFINET make it possible to raise the productivity of machines and plants and to guarantee the product quality and high level of precision.

The standardized PROFIdrive profile permits vendor-independent communication between CPUs and drives.

Overview

Large quantity structures

The use of PROFINET makes it possible to overcome the existing restrictions regarding the scope of machines and systems that can be implemented. In one network, several different controllers can interact with their assigned field devices. The number of field devices per PROFINET network is virtually unlimited – the entire range of IP addresses is available.

High data rate

By using 100 Mbit/s in full duplex mode, PROFINET achieves a significantly higher data rate than previous fieldbuses. This means that other plant data can be transmitted over TCP/IP without any problems, in addition to the process data. PROFINET therefore meets the combined industrial demands for simultaneously transmitting high-speed IO data and large volumes of data for additional sections of the application. Even the transmission of large volumes of data, such as that from cameras, has no adverse effect on the speed and precision of the IO data transmission, thanks to PROFINET mechanisms.

Media redundancy

A higher plant availability can be achieved with a redundant installation (ring topology). The media redundancy can be implemented not only with the aid of external switches, but also by means of integrated PROFINET interfaces. Using the media redundancy protocol (MRP), reconfiguration times of 200 ms can be achieved. If the communication is interrupted in just one part of the ring installation this means that a plant standstill is prevented and any necessary maintenance or repair work can be performed without any time pressure.

For motion control applications, PROFINET with IRT in ring topologies offers extended media redundancy for planned duplication (MRPD) which operates in a bumpless mode without any reconfiguration time. If communication is interrupted (e.g. a cable break) the process can continue operating without interruption.

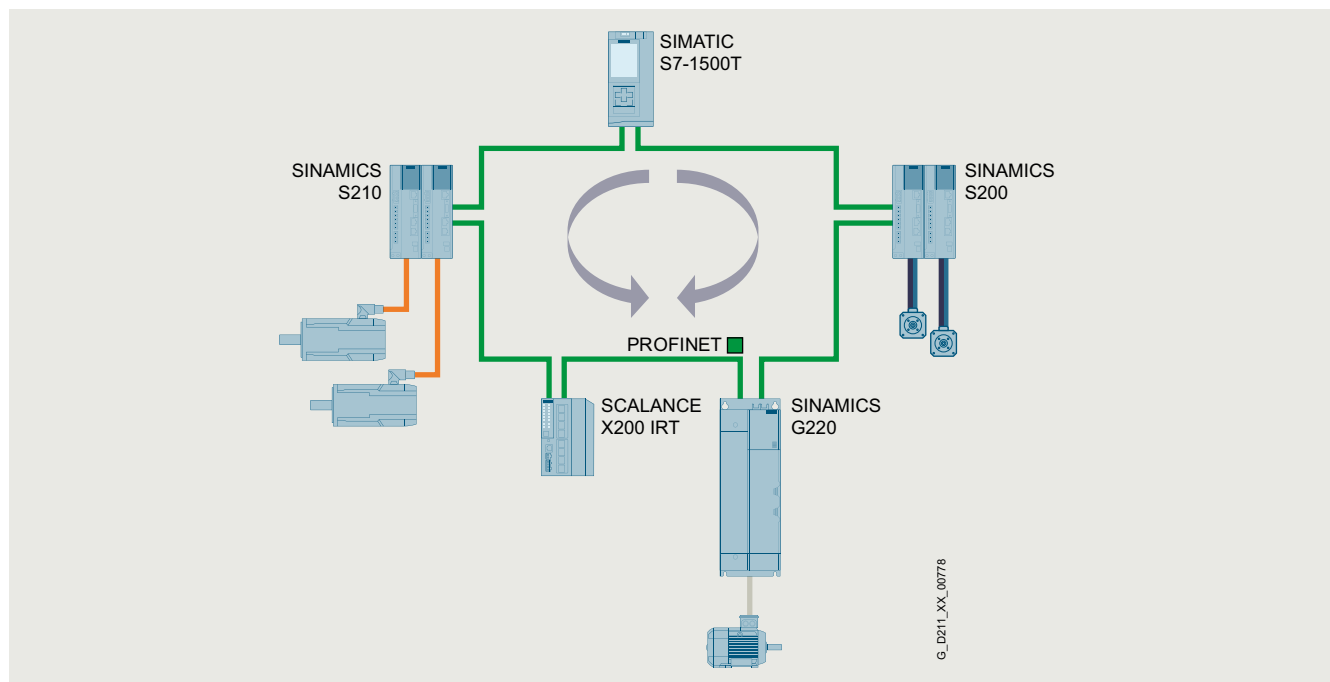

Bumpless media redundancy illustrated by example of SINAMICS G220, S200, S210 and SCALANCE X200IRT

Benefits

- PROFINET is the open Industrial Ethernet standard for automation
- PROFINET is based on Industrial Ethernet
- PROFINET uses TCP/IP and IT standards
- PROFINET is real-time Ethernet
- PROFINET enables seamless integration of fieldbus systems
- PROFINET supports fail-safe communication via PROFIsafe and also via IWLAN

More information

More information is available on the internet at:
www.siemens.com/profinet

Communication

PROFIdrive

Overview



PROFIdrive – the standardized drive interface for PROFINET and PROFIBUS

PROFIdrive defines the device behavior and technique to access internal device data for electric drives connected to PROFINET and PROFIBUS – from basic frequency converters up to high-performance servo controllers.

It describes in detail the practical use of communication functions – device-to-device communication, equidistance and clock cycle synchronization (isochronous mode) in drive applications. In addition, it specifies all device characteristics which influence interfaces connected to a controller over PROFINET or PROFIBUS. This also includes the state machine (sequence control), the encoder interface, scaling of values, definition of standard telegrams, access to drive parameters, etc.

The PROFIdrive profile supports both central as well as distributed motion control concepts.

What are profiles?

For devices and systems used in automation technology, profiles define properties and modes of behavior. This allows manufacturers and users to define common standards. Devices and systems that comply with such a cross-manufacturer profile, are interoperable on a fieldbus and, to a certain degree, can be interchanged.

Are there different types of profiles?

A distinction is made between what are known as application profiles (general or specific) and system profiles:

- Application profiles (also device profiles) predominantly refer to devices (e.g. drives) and include an agreed selection regarding bus communication as well as specific device applications.
- System profiles describe classes of systems, including master functionality, program interfaces and integration resources.

Is PROFIdrive fit for the future?

PROFIdrive has been specified by the PROFIBUS and PROFINET International (PI) user organization, and is specified as a standard that is fit for the future through standard IEC 61800-7.

The basic philosophy: Keep it simple

The PROFIdrive profile tries to keep the drive interface as simple as possible and free from technology functions. As a result, referencing models as well as the functionality and performance of the PROFINET/PROFIBUS master have either no or only little influence on the drive interface.

One drive profile – different application classes

The integration of drives into automation solutions depends very strongly on the particular drive application. In order to be able to address the complete, huge bandwidth of drive applications – from basic frequency converters up to synchronized multi-axis systems with a high dynamic performance – using just one profile, PROFIdrive defines six application classes, to which most drive applications can be assigned:

- Class 1 – standard drives (pumps, fans, agitators, etc.)
- Class 2 – standard drives with technological functions
- Class 3 – positioning drives
- Class 4 – motion control drives with central, higher-level motion control intelligence and the patented "Dynamic Servo Control" positioning concept
- Class 5 – motion control drives with central, higher-level motion control intelligence and position setpoint interface
- Class 6 – motion control drives with distributed motion control intelligence integrated in the drives

Design

The device model of PROFIdrive

PROFIdrive defines a device model comprising function modules, which interoperate inside the device and which reflect the intelligence of the drive system. These modules have objects assigned to them which are described in the profile and are defined with respect to their functions. The overall functionality of a drive is therefore described through the sum of its parameters.

In contrast to other drive profiles, PROFIdrive defines only the access mechanisms to the parameters as well as a subset of profile parameters (approx. 30) such as the fault buffer, drive control and device identification.

All other parameters are vendor-specific which gives drive manufacturers great flexibility with respect to implementing control functions. The elements of a parameter are accessed acyclically over data records.

As a communication protocol, PROFIdrive uses DP-V0, DP-V1, and the DP-V2 expansions for PROFIBUS including the functions "Device-to-Device Communication" and "Isochronous Operation", or PROFINET IO with real-time classes RT and IRT.

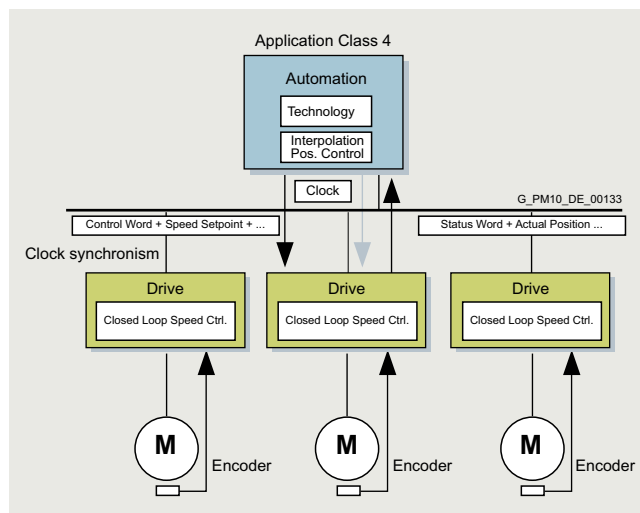

More information

More information on PROFINET and PROFIBUS is available at: www.profibus.com

Overview



PROFIBUS – the proven, rugged bus system for automation engineering applications

The requirements of users for an open, non-proprietary communication system have resulted in the specification and standardization of the PROFIBUS protocol.

PROFIBUS defines the technical and functional features of a serial fieldbus system, with which the distributed field automation devices in the lower area (sensor/actuator level) can be networked up to the mid performance range (cell level).

Standardization according to IEC 61158/EN 50170 secures your investments for the future.

Using the conformity and interoperability test performed by the test laboratories authorized by PROFIBUS & PROFINET International (PI) and the certification of the devices by PI, users have the security of knowing that the quality and functionality is guaranteed, even in multi-vendor installations.

PROFIBUS versions

Two different PROFIBUS versions have been defined in order to comply with the widely varying requirements at field level:

- PROFIBUS PA (Process Automation) – the version for applications in process automation. PROFIBUS PA uses the intrinsically safe transmission technology specified in IEC 61158-2.
- PROFIBUS DP (Distributed Periphery) – this version, which is optimized for speed, is specifically tailored to the communication of automation systems with distributed I/O stations and drives. PROFIBUS DP sets itself apart as a result of very short response times and high noise immunity, and replaces cost-intensive, parallel signal transfer with 24 V and measured value transfer utilizing 0/4 ... 20 mA technology.

Design

Bus participants on PROFIBUS DP

PROFIBUS DP makes a distinction between two different master classes and one device class:

DP master class 1

For PROFIBUS DP, DP master class 1 is the central component. In a defined and continually repeating message cycle the central master station exchanges information with distributed stations (DP devices).

DP master class 2

Devices of this type (programming, configuring or operator control devices) are used during commissioning, for configuring the DP system, for diagnostics or for operating the active plant or system. A DP master class 2 can, for example, read input, output, diagnostic and configuration data of the devices.

DP device

A DP device is an I/O device which receives output information or setpoints from the DP master, and as response, returns input information, measured values and actual values to the DP master. A DP device never sends data automatically, but only when requested by the DP master.

The quantity of input and output information depends on the device, and for each DP device in each send direction can be a maximum of 244 bytes.

Function

Functional scope in DP masters and DP devices

The functional scope can differ between DP masters and DP devices. The different functional scopes are classified as DP-V0, DP-V1 and DP-V2.

DP-V0 communication functions

The DP-V0 master functions consist of "Configuration", "Parameter Assignment" and "Reading Diagnostics Data", as well as cyclic reading of input data/actual values and writing output data/setpoints.

DP-V1 communication functions

The DP-V1 function expansions make it possible to perform acyclic read and write functions as well as processing cyclic data communication. This type of device must be supplied with extensive parameterization data during start-up and during normal operation. These acyclically transferred parameterization data are only rarely changed in comparison to the cyclic setpoints, actual values, and measured values, and are transferred at lower priority in parallel with the cyclic high-speed user data transfer. Detailed diagnostic information can be transferred in the same way.

DP-V2 communication functions

The extended DP-V2 master functions mainly comprise functions for isochronous operation and device-to-device communication between DP devices.

- Isochronous mode:
Isochronous mode is implemented by means of an equidistant signal in the bus system. This cyclic, equidistant cycle is sent by the DP master to all bus nodes in the form of a Global Control Telegram. Master and devices can then synchronize their applications with this signal. The signal jitter between cycles is less than 1 μ s.
- Device-to-device communication:
The "publisher/subscriber" model is used to implement device-to-device communication. Devices declared as publishers make their input data/actual values and measured values available to other devices, the subscribers, for reading. This is performed by sending the response frame to the master as a broadcast. Device-to-device communication is therefore a cyclic process.

Integration

PROFIBUS with SINAMICS

SINAMICS uses the PROFIBUS DP protocol. SINAMICS drives can only be used as DP devices.

Communication

Industrial Ethernet

Overview



Ethernet is the basic internet technology for worldwide networking. The many possibilities of intranet and internet, which have been available for office applications for a long time, are now utilized for production automation with Industrial Ethernet.

Apart from the use of information technology, the deployment of distributed automation systems is also on the increase. This entails breaking up complex control tasks into smaller, manageable and drive-based control systems. This increases the demand for communication and consequently a comprehensive and powerful communication system.

Industrial Ethernet provides a powerful area and cell network for the industrial field, compliant with the IEEE 802.3 (ETHERNET) standard.

Benefits

Ethernet enables a very fast data transfer (10/100 Mbit/s, 1/10 Gbit/s) and at the same time has full-duplex capability. It therefore provides an ideal basis for communication tasks in the industrial field. With a share of over 90 %, Ethernet is the number one network worldwide and offers important features which have essential advantages:

- Fast commissioning thanks to the simplest connection method
- High availability since existing networks can be extended without any adverse effects
- Almost unlimited communication performance because scalable performance is available through switching technology and high data rates when required
- Networking of different application areas such as office and production areas
- Company-wide communication based on WAN (Wide Area Network) technology or the internet
- Investment protection due to continuous compatibility with further developments
- Wireless communication using Industrial Wireless LAN

In order to make Ethernet suitable for industrial applications, considerable expansions with respect to functionality and design are required:

- Network components for use in harsh industrial environments
- Fast assembly of the RJ45 connectors
- Fail-safety through redundancy
- Expanded diagnostics and message concept
- Use of future-oriented network components (e.g. switches)

SIMATIC NET offers corresponding network components and products.

Integration

Industrial Ethernet with SINAMICS

SINAMICS provides Control Units and Communication Boards with PROFINET interface based on 100 Mbit/s Ethernet. This means that process communication in real-time, as well as engineering and HMI via standard TCP/IP are simultaneously possible.

It is also possible to access the web server in SINAMICS at the same time that process communication is in progress.

The CU310-2 and CU320-2 Control Units have an additional Ethernet interface at the front so that service and engineering tasks can be performed very easily.

Communication with SINAMICS over Industrial Ethernet

PG/PC/HMI communication

PG/PC/HMI communication is performed using protocols which are based on the basic TCP/IP protocol.

- Engineering and diagnostics with STARTER and SINAMICS Startdrive

IT communication

IT communication is performed using protocols which are based on the basic TCP/IP protocol. The most important IT protocols are:

- HTTP/HTTPS: Hypertext Transfer Protocol (Secure)
Using a standard internet browser, it is possible to retrieve predefined web pages containing diagnostic information from the device. Furthermore, user-defined web pages containing information defined by the user can be stored in the device.
- SNMP: Simple Network Management Protocol

Overview

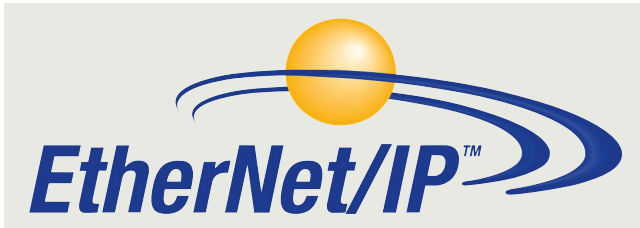

Ethernet Industrial Protocol (EtherNet/IP) is an open standard for industrial networks. EtherNet/IP is used to transmit cyclic I/O data and acyclic parameter data. EtherNet/IP was developed by the ODVA (Open DeviceNet Vendor Association) and belongs to the international standard series IEC 61158.

Overview



As a simple fieldbus protocol, Modbus RTU can be used both cyclically and acyclically. Based on RS485 physical bus characteristics, up to 32 nodes can be networked to one bus segment and connected to a higher-level controller. This protocol is generally used when there are limited demands on data throughput.

Overview



AS-Interface serves as a cost-effective system for the lower field level of automation. AS-Interface was specially developed to meet the demands of connecting binary sensors and actuators as well as interfacing to the higher control level.

A straightforward, cost-effective installation with minimal connection costs was of paramount importance to the developers.

The AS-Interface is often used in systems where numerous actuators and sensors, installed across a wide area, need to be networked cost-effectively. Examples include conveyor and handling systems in airports, automated postal sorting, and the food and beverage industry.

Overview

As a simple fieldbus protocol, USS (**U**niversal **S**erial **I**nterface protocol of Siemens AG, 1992) can be used both cyclically and acyclically. Based on RS485 physical bus characteristics, up to 32 nodes can be networked to one bus segment and connected to a higher-level controller. This protocol is generally used when there are limited demands on data throughput.

Communication

Notes

5

Technology functions

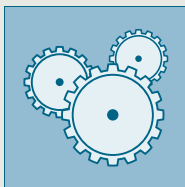
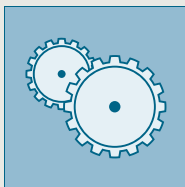
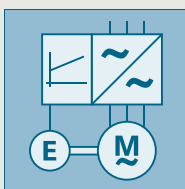

6/2

Free function blocks (FFB)

6/3

Basic positioner EPOS

6/3

Function module basic positioner EPOS

6/4

Functionality of the EPOS basic positioner

Technology functions

Free function blocks (FFB)

Overview

On specific SINAMICS devices, free function blocks (FFB) are available as a standard technology function, which can be called up as an additively activatable function module. The FFB can be used to connect simple binary states or several input signals to a control signal (e.g. ON command). Furthermore, analog signals can also be adapted.

In addition to logical operations such as AND/OR, arithmetic functions as well as more complex blocks such as smoothing elements, limit monitors, or storing elements are also available. All of the blocks can be flexibly interconnected with one another using BICO (Binector-Connector technology).

In the SINAMICS Startdrive engineering tool, the FFB can be comfortably parameterized via screens.

The user-friendly overview for parameter assignment is shown below, based on the example of the SINAMICS G120 inverter. In this example, three digital inputs which are linked to each other via a logical AND function block are acquired. The drive can only be released when all inputs have a HIGH signal.

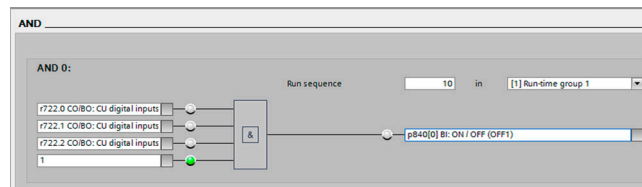

Supported functions in the function module of the free function blocks (FFB)

Logical functions	Programming of Boolean logic and logic operations
Arithmetic functions	Programming of mathematical functions
Timer functions	Generating of pulses and switching delays
Memory functions	Programming of binary flip-flops
Switch functions	Programming of binary and numerical switches
Control functions	Programming of functions for open-loop and closed-loop control
Complex functions	Programming of threshold value monitors and control units

The table above shows an overview of the supported functions of the FFB. Depending on the SINAMICS inverter, up to 25 different block types are available. The number of available blocks per module type is limited. The blocks are not multi-instance-capable.

The sequence and calculation intervals (sampling times) can be selected for each block, but the calculation intervals are limited by the performance of the Control Unit.

Overview

Function module basic positioner EPOS

The basic positioner EPOS is available as a standard technology function for the following SINAMICS Control Units and can be called as a function module that can be activated additionally.

- SINAMICS S120 CU310-2 and CU320-2 Control Units
- SINAMICS S110 CU305 Control Units
- SINAMICS G120 CU250S-2 Control Units
- SINAMICS G120D CU250D-2 Control Units

The basic positioner can be used to resolve basic motion control tasks without additional external technological outlay from the drive itself.

Integrated functionality for absolute and relative positioning of linear and rotary axes with motor encoders or machine encoders.

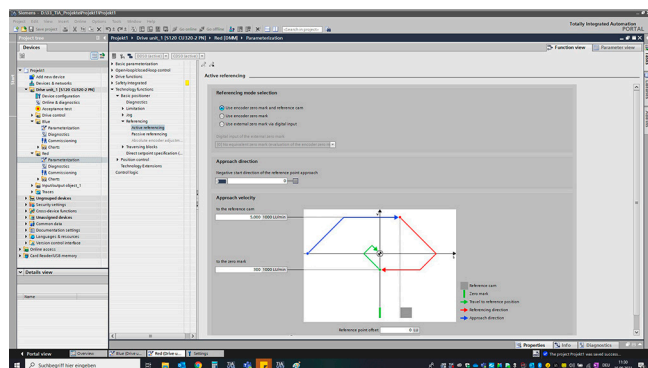
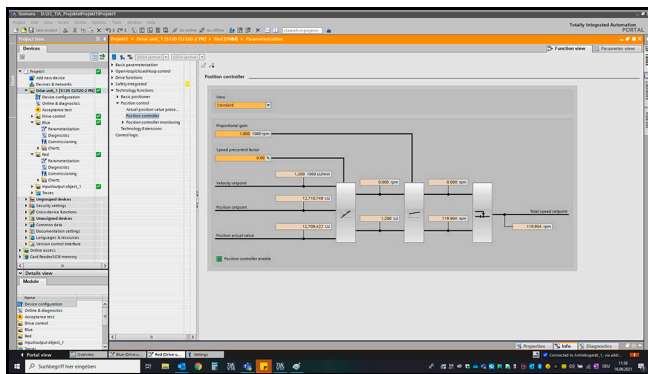

The EPOS basic positioner in the SINAMICS drive system provides powerful and precise positioning functions. Due to its flexibility and adaptability, the basic positioner can be used for a wide range of positioning tasks.

The functions are easy to handle both during commissioning and during operation, and the comprehensive monitoring functions are outstanding.

Many applications can be carried out without external position controllers.

The EPOS basic positioner is used to position linear and rotary axes (modulo) in absolute/relative terms with rotary as well as linear motor encoder or machine encoder (indirect or direct measuring system).

EPOS is a function module that can be activated additionally in Servo Control and in Vector Control.

User-friendly configuring and commissioning, including control panel (operation using PC) and diagnostics, are possible with the STARTER and SINAMICS Startdrive commissioning tools.

In addition to extremely flexible positioning functions, EPOS offers a high degree of user-friendliness and reliability thanks to integral monitoring and compensation functions.

Different operating modes and their functionality increase flexibility and plant productivity, for example, by means of "on-the-fly" and bumpless correction of the motion control.

Preconfigured PROFIdrive positioning frames are available which, when selected, automatically establish the internal "connection" to the basic positioner.

Technology functions

Basic positioner EPOS

Overview

Functionality of the EPOS basic positioner

Lower-level closed-loop position control with the following essential components

- Position actual value sensing (including the lower-level measuring probe evaluation and reference mark search)
- Position controller (including limits, adaptation and pre-control calculation)
- Monitoring functions (standstill, positioning and dynamic following error monitoring, cam signals)

Mechanical system

- Backlash compensation
- Modulo offset

Limitations

- Speed/acceleration/delay/jerk limitation
- Software limit switches (traversing range limitation by means of position setpoint evaluation)
- Stop cams (traversing range limitation using hardware limit switch evaluation)

Referencing or adjustment

- Set reference point (for an axis at standstill)
- Search for reference (separate mode including reversing cam functionality, automatic reversal of direction, homing to "output cam and encoder zero mark" or only "encoder zero mark" or "external zero mark (BERO)")
- Flying referencing (seamless referencing possible during "normal" traversing with the aid of the measuring input evaluation; generally evaluation, e.g. of a BERO. Subordinate function for the modes "jog", "direct setpoint input/MDI" and "traversing blocks")
- Absolute encoder alignment

Traversing block mode

- 64 traversing blocks for
 - SINAMICS S120 CU310-2 and CU320-2 Control Units
- 16 traversing blocks for
 - SINAMICS S110 CU305 Control Units
 - SINAMICS G120 CU250S-2 Control Units
 - SINAMICS G120D CU250D-2 Control Units
- Positioning using traversing blocks that can be stored in the drive unit including continuation conditions and specific jobs for a previously homed axis.
- Configuring traversing blocks using the traversing block editor in the relevant commissioning tool of the SINAMICS converter family
- A traversing block contains the following information:
 - Job number and job (e.g. positioning, waiting, GOTO block jump, setting of binary outputs, travel to fixed stop)
 - Motion parameters (target position, velocity, override for acceleration and deceleration)
 - Mode (e.g.: hide block, continuation conditions such as "Continue_with_stop", "Continue_flying" and "Continue_externally using high-speed measuring inputs")
 - Job parameters (e.g. wait time, block step conditions)

Direct setpoint specification (MDI) mode

- Positioning (absolute, relative) and setting-up (endless closed-loop position control) using direct setpoint inputs (e.g. via the PLC using process data)
- It is always possible to influence the motion parameters during traversing (on-the-fly setpoint acceptance) as well as for on-the-fly changes between the setup and positioning modes.
- The direct setpoint specification mode (MDI) can also be used in the relative positioning or setup mode if the axis is not referenced. This means that on-the-fly synchronization and re-referencing can be carried out using "flying referencing".

Jog mode

- Closed-loop position controlled traversing of the axis with "endless position controlled" or "jog incremental" modes (traverse through a "step width"), which can be toggled between

SINAMICS G115D distributed drive system

0.37 kW to 7.5 kW (0.5 to 10 hp)

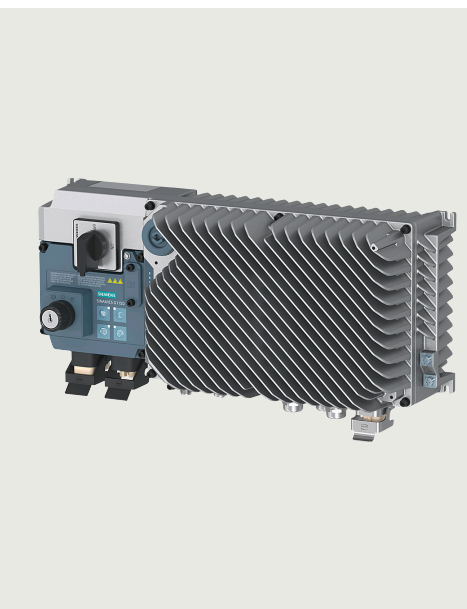

SINAMICS G115D distributed drive system

- 7/2 Application
- 7/2 More information
- 7.1/1 System overview
- 7.2/1 Wall-mounted
- 7.3/1 Supplementary components

The distributed frequency converter SINAMICS G115D supports geared motors Innomotics SG and SG G115D from our product partner Innomotics. Further information about the products of Innomotics can be found under www.innomotics.com

The corresponding catalog D 50.15 from Innomotics can be found on the internet at www.innomotics.com/hub/en/18794

SINAMICS G115D distributed drive system

0.37 kW to 7.5 kW (0.5 to 10 hp)

Introduction

Application

Use	Requirements for torque accuracy/speed accuracy/position accuracy/coordination of axes/functionality					
	Continuous motion			Non-continuous motion		
	Basic	Medium	High	Basic	Medium	High
Pumping, ventilating, compressing	Centrifugal pumps Radial / axial fans Compressors	Centrifugal pumps Radial / axial fans Compressors	Eccentric screw pumps	Hydraulic pumps Metering pumps	Hydraulic pumps Metering pumps	Descaling pumps Hydraulic pumps
	V20 G120C G120X	G120X G130/G150 G180 ¹⁾ DCM	G220 S120	G120/G220	S110	S120
Moving	Conveyor belts Roller conveyors Chain conveyors	Conveyor belts Roller conveyors Chain conveyors Lifting/lowering devices Elevators Escalators/moving walkways Indoor cranes Marine drives Cable railways	Elevators Container cranes Mining hoists Excavators for open-cast mining Test bays	Acceleration conveyors Storage and retrieval machines	Acceleration conveyors Storage and retrieval machines Cross cutters Reel changers	Storage and retrieval machines Robotics Pick & place Rotary indexing tables Cross cutters Roll feeds Engagers/disengagers
	V20 G115D G120C ET 200pro FC-2 ²⁾	G120/G220 G120D G130/G150 G180 ¹⁾	G220 S120 S150 DCM	V90 S200 G120/G220 G120D	S110 S210 DCM	S120 S210 DCM
Processing	Mills Mixers Kneaders Crushers Agitators Centrifuges	Mills Mixers Kneaders Crushers Agitators Centrifuges Extruders Rotary furnaces	Extruders Winders/unwinders Lead/follower drives Calenders Main press drives Printing machines	Tubular bagging machines Single-axis motion control such as • Position profiles • Path profiles	Tubular bagging machines Single-axis motion control such as • Position profiles • Path profiles	Servo presses Rolling mill drives Multi-axis motion control such as • Multi-axis positioning • Cams • Interpolations
	V20 G120C	G120/G220 G130/G150 G180 ¹⁾	G220 S120 S150 DCM	V90 S200 G120/G220	S110 S210	S120 S210 DCM
Machining	Main drives for • Turning • Milling • Drilling	Main drives for • Drilling • Sawing	Main drives for • Turning • Milling • Drilling • Gear cutting • Grinding	Axis drives for • Turning • Milling • Drilling	Axis drives for • Drilling • Sawing	Axis drives for • Turning • Milling • Drilling • Lasering • Gear cutting • Grinding • Nibbling and punching
	S110	S110 S120	S120	S110	S110 S120	S120

The SINAMICS G115D distributed frequency converter meets all the requirements that system manufacturers place on drives for horizontal applications in conveyor technology with a focus on the intralogistics and airport industries as well as for horizontal applications in the automotive and food and beverage industries.

The converter is supplied as with degree of protection up to IP66 and sets standards in terms of efficiency – from the installation phase to commissioning and all the way to handling.

The SINAMICS G115D distributed frequency converter is the first choice for users who want to move conveyed material quickly and efficiently.

Practical application examples and descriptions are available on the internet at
www.siemens.com/sinamics-applications
www.siemens.com/conveyor-technology

More information

You may also be interested in these frequency converters:

- With enhanced safety functionality, energy recovery with positioning function in IP65 degree of protection ⇒ SINAMICS G120D
- More performance for the control cabinet in IP20 degree of protection ⇒ SINAMICS G120, SINAMICS G120C
- With positioning function in the control cabinet in IP20 degree of protection ⇒ SINAMICS G120

¹⁾ Industry-specific converters.

²⁾ Information on the SIMATIC ET 200pro FC-2 frequency converter is available at:
www.siemens.com/et200pro-fc

SINAMICS G115D distributed drive system • System overview

0.37 kW to 7.5 kW (0.5 to 10 hp)

7.1

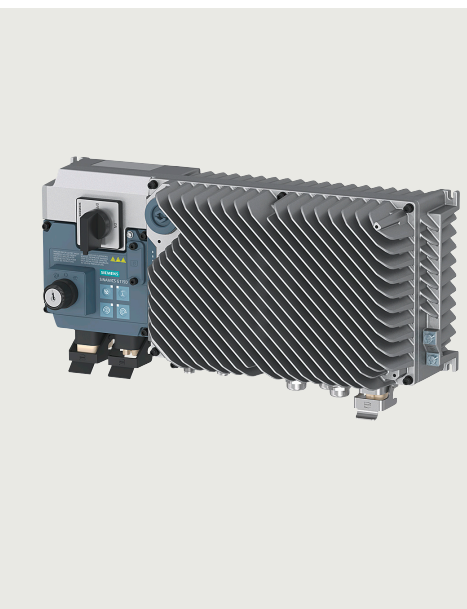

7.1/2 **SINAMICS G115D distributed drive system**

Overview

7.1/5 **SINAMICS G115D distributed converters wall-mounted**

Selection and ordering data

SINAMICS G115D distributed drive system • System overview

0.37 kW to 7.5 kW (0.5 to 10 hp)

SINAMICS G115D distributed drive system

Overview

The SINAMICS G115D decentralized frequency converter meets all the requirements that system manufacturers place on drives for horizontal applications in conveyor technology, with a focus on the intralogistics and airport industries as well as for horizontal applications in the automotive and food & beverage industries.

The converter is supplied with protection class up to IP66 and sets standards in terms of efficiency – from the installation phase to commissioning and handling. The SINAMICS G115D decentralized frequency converter is the first choice for users who want to move conveyed goods quickly and efficiently.

The converter supports geared motors from our product partner Innomotics *) with three-phase asynchronous motors with efficiency class IE3 or high-efficiency synchronous reluctance motors with efficiency class IE4.

It meets all requirements for horizontal conveyor system applications – from simple speed control to sophisticated encoderless vector control. Integrated functions such as fast/slow speed switchover, Quick Stop and limit position disconnecter make the SINAMICS G115D particularly suitable for applications in conveyor systems.

For applications that require safety technology, the SINAMICS G115D offers the integrated STO (Safe Torque Off) function, which can be implemented without additional external components.

In addition, as of firmware V4.7 SP14 in conjunction with SINAMICS Startdrive from V18 SP1, the safety function SLS (Safely-Limited Speed) is available via Safety Extended license.

SINAMICS G115D distributed frequency converter, wall-mounted

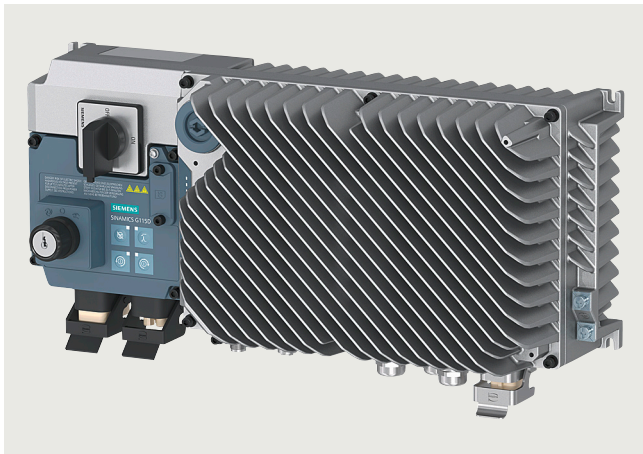

Example: SINAMICS G115D distributed frequency converter, wall-mounted, PROFINET, version with plug-in connection, FSB, 2.2 kW

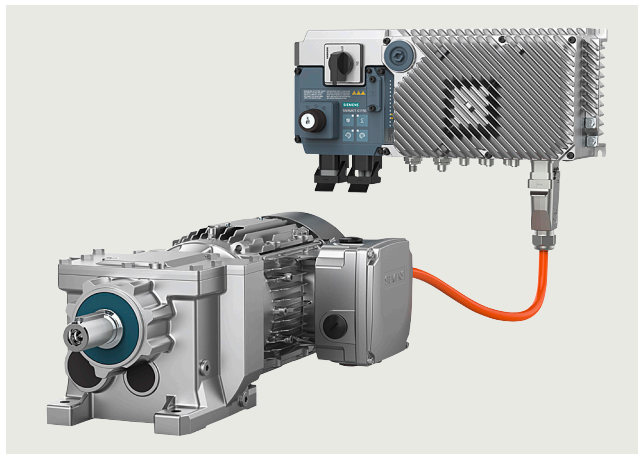

Example: SINAMICS G115D distributed frequency converter, wall-mounted, PROFINET, version with plug-in connection, FSA, 1.5 kW, in connection with a geared motor from our product partner Innomotics *)

The wall-mounted converter with its different versions (frame sizes FSA to FSC) in a performance range from 0.37 kW to 7.5 kW is suitable for a large number of different applications. Thanks to the compact design with degree of protection IP65 (plug-in connection) or IP66 (cable gland), it can be seamlessly integrated.

The converter supports geared motors from our product partner Innomotics *) with three-phase asynchronous motors with efficiency class up to IE3 or high-efficiency synchronous reluctance motors with efficiency class IE4.

Innomotics SG G115D distributed drive system, from our product partner Innomotics *)

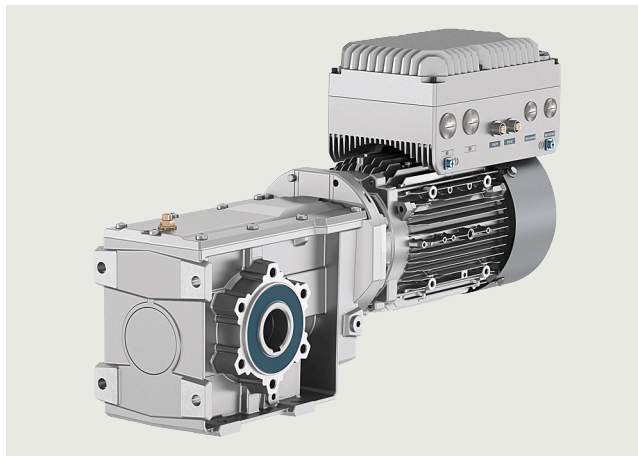

Example: Innomotics SG G115D distributed drive system, from our product partner Innomotics *) , version with cable gland, FSA, 1.5 kW, motor LE 90, gearbox B49, hollow shaft

The distributed drive system Innomotics SG G115D from our product partner Innomotics *) with its different versions (frame sizes FSA and FSB) in a performance range from 0.37 kW to 4 kW is suitable for a large number of different applications.

*) Further information about the products of our product partner Innomotics can be found under www.innomotics.com

Overview**Perfect combination with SIMATIC controllers and PROFINET**

Integration via PROFINET communication with PROFIsafe, AS-Interface, EtherNet/IP into a higher-level control system is very easy thanks to full TIA Portal integration, which provides a tool as well as an operating and data management concept. In addition, an optional web server module is available with the web server module SINAMICS G120 Smart Access (SAM) – a WLAN-based web server solution for simple and fast wireless setup with smartphone, tablet or laptop during commissioning and for diagnostics.

The SINAMICS G115D distributed frequency converter is ready for digitalization. The recorded operating data can be analyzed via the Industrial Edge or in the cloud, e.g. with the Drivetrain Analyzer application. This facilitates the process evaluation of the operating data, with the possibility of adapting it to individual customer requirements. This simplifies the recording and evaluation of the operating conditions of the drive system.

Reasons for using the SINAMICS G115D distributed frequency converter

- User-friendly modular solution – pre-configured and ready for connection
- Versatile, robust and reliable system
- New design for quick and easy installation, cabling and commissioning
- No control cabinet required, thanks to the installation on the machine less space required and lower cooling requirements
- Long cables between the converters and the motors can be avoided (thus less power loss, reduced interference emissions, and lower costs for shielded cables and additional filters)
- Supports geared motors with asynchronous motors from our product partner Innomatics *) and high-efficiency synchronous reluctance motors according to efficiency class IE4
- Temperature range from -30 °C to 55 °C (suitable for installation in deep-freeze applications)
- Integrated safety, STO (Safe Torque Off) via fail-safe digital input F-DI or PROFIsafe and from firmware V4.7 SP14 in conjunction with SINAMICS Startdrive from V18 SP1, the function SLS (Safely-Limited Speed) via Safety Extended license
- Perfectly prepared for digitalization thanks to different communication interfaces and integration via Industrial Edge or in the cloud, e.g. with the Drivetrain Analyzer application
- Special properties for the intralogistics market (e.g. repair switches, local remote control, Safety Integrated, conveyor technology functions)

The family of distributed frequency converters at Siemens

Siemens offers an innovative portfolio of frequency converters for optimal implementation in distributed drive solutions. The strengths of the individual members of the converter family allow easy adaptation to the most diverse application requirements:

- Identical connection systems
- User-friendly commissioning and configuration tools

Products from the family of distributed drives:

- SINAMICS G115D distributed frequency converter
- SINAMICS G120D frequency converters
- SIMATIC ET 200pro FC-2 frequency converters
- SIRIUS M200D motor starters

Hardware configuration

The wall-mounted converter with different device versions (sizes FSA to FSC) in a power range of 0.37 kW to 7.5 kW is suitable for a variety of different applications.

Thanks to the compact design in protection class IP65 (plug-in connection) or IP66 (cable gland), it can be seamlessly integrated.

The converter is configurable regarding fieldbus communication (AS-Interface or PROFINET / EtherNet/IP) and connection method (cable gland or plug-in connection).

Furthermore, the wall-mounted converter can be configured with a repair switch, local remote control and the control voltage of the motor holding brake.

State-of-the-art IGBT technology with pulse width modulation (PWM) is used for extremely reliable and flexible motor operation. The closed-loop control electronics control and monitor the power electronics and the connected motor in several different control modes that can be selected.

The sensors of the conveyor element can be connected to the digital inputs of the converter. These signals can be transmitted to the higher-level control for further processing via PROFINET, EtherNet/IP or AS-Interface.

*) Further information about the products of our product partner Innomatics can be found under www.innomotics.com

SINAMICS G115D distributed drive system • System overview

0.37 kW to 7.5 kW (0.5 to 10 hp)

SINAMICS G115D distributed drive system

Overview

Safety Integrated

The SINAMICS G115D distributed frequency converter are already equipped with the Safety Integrated Function STO (Safe Torque Off), with certification according to IEC 61508 SIL 2 as well as ISO 13849-1 PL d and Category 3. This can be activated either via the PROFIsafe communication protocol or via the fail-safe digital input F-DI.

In addition, as of firmware V4.7 SP14 in conjunction with SINAMICS Startdrive from V18 SP1, the safety function SLS (Safely-Limited Speed) is available via Safety Extended license.

DriveSim Designer (firmware V4.7 SP13 or higher)

DriveSim Designer provides easy-to-use models for PROFIdrive-enabled SINAMICS converters, so you can create a digital twin of your drive.

More information is provided on the internet at:
www.siemens.com/drive-virtualization

Siemens Product Configurator

The Siemens Product Configurator helps you configure the optimum drive technology products for a number of applications – starting with motors and converters as well as the associated options and components and ending with controllers, software licenses and connection systems.

The Siemens Product Configurator can be used on the internet without requiring any installation. The Siemens Product Configurator can be found in SiePortal at the following address:
www.siemens.com/spc

SINAMICS Startdrive commissioning tool

SINAMICS Startdrive is a tool integrated into the TIA Portal for configuring, commissioning and diagnostics of the SINAMICS converter family. SINAMICS Startdrive (V16 update 4 and higher) can be used to implement converter tasks with most of the SINAMICS G and SINAMICS S converter series. The commissioning tool has been optimized in terms of simplicity, ease of use, and consistent use of the benefits of the TIA Portal to provide a uniform working environment for PLC, HMI and drives.

The SINAMICS Startdrive Basic commissioning tool is available for free on the internet at
www.siemens.com/startdrive

Drive dimensioning of the SINAMICS G115D distributed frequency converters with the TIA Selection Tool

The SINAMICS G115D distributed frequency converters are easily configured with the TIA Selection Tool under the Drive Dimensioning plug-in. It provides support when selecting the hardware and firmware components necessary to implement a drive task.

The TIA Selection Tool is available for free on the internet at
<http://www.siemens.com/tia-selection-tool-standalone>

SIMARIS planning tools for plants with SINAMICS drives

Electrical planning: Even easier with software!

Electrical planning for power distribution in non-residential and industrial buildings has never been more complex. To ensure you, as a specialist planner, have the best hand when it comes to electrical planning with SINAMICS drives, we provide support with the following efficient software tools:

- SIMARIS design for dimensioning
- SIMARIS project for calculating the space requirements of the distribution boards

Extended warranty

For SINAMICS G115D, Siemens offers an optional extension of warranty up to 2 ¹/₂ years via **Service Protect**:

- Free for the first 6 months after registering the product at:
www.siemens.com/serviceprotect
- Subject to a charge for a further 1 or 2 years

For further information, go to:

<https://support.industry.siemens.com/cs/ww/en/sc/4842>

Concerning standard warranty please ask your partner at Siemens. Your partner can be found in our Personal Contacts Database at:

www.siemens.com/automation-contact

Siemens EcoTech Profile (SEP) for SINAMICS G115D

Siemens introduces a new label: Siemens EcoTech. It is an environmental declaration for products based on product-specific evaluations of sustainability relevant KPIs. To provide maximum transparency, the Siemens EcoTech Profile (SEP) were created for all Siemens EcoTech products.

It is a Siemens-created, standardized product data sheet which gives insight about the product performance in environmental relevant criteria as well as about interpretation and comparison of data against an existing norm, standard or predecessor product.

You can find more information on the internet at:

<https://sieportal.siemens.com/su/blq7T>
www.siemens.com/SiemensEcoTech



More information

Identification link according to IEC 61406 for SINAMICS G115D

The ID link contains the article and serial number of the product. As a QR code, it replaces the previous data matrix code on the nameplate and takes you with the URL directly to a product information page on the internet with access to the technical documentation, data sheet, certificates, FAQs, product notifications, and catalogs. Paper package inserts become mostly superfluous since the information is available electronically directly via the QR code, even years later. In this way, we are making a valuable contribution to the preservation of our environment. You don't need an additional app. Simply scan the QR code with your smartphone or tablet. According to IEC 61406, the QR code of an ID link is marked with a frame and a triangle at the bottom right.

With their globally unique identifiers, Siemens products are ready for Industry 4.0.

The ID serves as a connection to the administration shell with which modules of the digital twin can be provided.

The latest technical documentation (catalogs, dimensional drawings, certificates, manuals and operating instructions) as well as further technical specifications are available on the internet at:

www.siemens.com/sinamics-g115d/documentation

and in the Siemens Product Configurator
www.siemens.com/sinamics-g115d/configuration

SINAMICS G115D distributed drive system • System overview

0.37 kW to 7.5 kW (0.5 to 10 hp)

SINAMICS G115D distributed converters wall-mounted

Selection and ordering data

SINAMICS G115D distributed converters wall-mounted - 380 ... 480 V 3 AC																						
Rated power ¹⁾		Rated output current I_N ²⁾	Rated input current ³⁾	Frame size	SINAMICS G115D wall-mounted Degree of protection IP65/IP66/UL Type 4X with integrated line filter class A according to EN 55011																	
400 V kW	480 V hp	at 400 V A	at 400 V A		Data position in Article No.																	
380 ... 480 V 3 AC · Rated pulse frequency 4 kHz · Input frequency 45 ... 66 Hz					1	2	3	4	5	6	7	-	8	9	10	11	12	-	13	14	15	16
0.37	0.5	1.3	1.23	FSA	6	S	L	3	5	2	-	X	0	-	3	A	0					
0.55	0.75	1.7	1.58	FSA	6	S	L	3	5	2	-	X	0	-	5	A	0					
0.75	1	2.2	1.99	FSA	6	S	L	3	5	2	-	X	0	-	7	A	0					
1.1	1.5	3.1	2.69	FSA	6	S	L	3	5	2	-	X	1	-	1	A	0					
1.5	2	4.1	3.48	FSA	6	S	L	3	5	2	-	X	1	-	5	A	0					
2.2	3	5.9	5.18	FSB	6	S	L	3	5	2	-	X	2	-	2	A	0					
3.0	4	7.7	6.76	FSB	6	S	L	3	5	2	-	X	3	-	0	A	0					
4.0	5	10.2	8.95	FSB	6	S	L	3	5	2	-	X	4	-	0	A	0					
5.5	7.5	13.2	11.88	FSC	6	S	L	3	5	2	-	X	5	-	5	A	0					
7.5	10	19	17.11	FSC	6	S	L	3	5	2	-	X	7	-	5	A	0					

Article No. supplements

Brake control

180 V DC (independent of the line voltage) *)

380 ... 480 V AC (such as line voltage)

0

1

Operating options

Without operating option *)

Repair switch

Local remote control

Repair switch and local remote control

0

1

2

3

Connection type	Fieldbus communication	I/O	Motor	380 ... 480 V AC	24 V DC ⁵⁾				
Cable gland with daisy chain	M12		Cable gland *)			A 2			
						M12	Cable gland	A 6	
						Q8/0	Cable gland	R 0	
							Cable gland	2 × Power M12 ⁶⁾	R 1
							Cable gland	Power supply unit integrated	H 2
Plug-in connection without daisy chain	M12	M12	Q8/0	Q4/2	7/8* ⁵⁾	B 0			
							Power M12 ⁶⁾	B 4	
							Quickon ⁴⁾	C 0	
							MQ15 ⁴⁾	D 0	
							Q4/2	Power supply unit integrated	K 0
							Quickon ⁴⁾	Power supply unit integrated	L 0
Plug-in connection with daisy chain	M12	M12	Q8/0	2 × Q4/2	2 × 7/8* ⁵⁾	E 0			
							2 × Power M12 ⁶⁾	E 4	
							Power supply unit integrated	N 0	

Fieldbus communication

AS-Interface

PROFINET, EtherNet/IP

A

F

* If you select "Brake voltage 180 V DC" and "Without operating option" in combination with one of the connection types **A2** or **E0**, the delivery time will change from "standard delivery time" to "delivery ex stock".

- Rated power based on the rated output current I_N . The rated output current I_N is based on the duty cycle for high overload (HO).
- The rated output current I_N is based on the duty cycle for high overload (HO). These current values apply at 400 V and are specified on the rating plate of the converter.
- The input current depends on the motor load and line impedance. The input currents apply for a load at rated power for a line impedance corresponding to $u_K = 4\%$. The current values are specified on the rating plate of the converter.

- Not suitable for UL applications (FSA and FSB). Not available for FSC.
- Plug-in connector for 24 V DC with fieldbus communication AS-Interface not available. For AS-Interface the 24 V DC power supply is provided via the M12 plug-in connector for fieldbus communication.
- Version **B4** or **E4** with fieldbus communication AS-Interface cannot be ordered., is covered by version **B0** or **E0**.

SINAMICS G115D distributed drive system • System overview

0.37 kW to 7.5 kW (0.5 to 10 hp)

Clicking to SiePortal

6SL3255-0AA00-5AA0



SINAMICS G115D distributed converters wall-mounted

Selection and ordering data

Supplementary system components for SINAMICS G115D

Description	Article No.
Fuses <ul style="list-style-type: none"> • 10 A for FSA • 16 A for FSB • 32 A for FSC 	3NA3803 3NA3805 3NA3812
External braking resistors Continuous braking power <ul style="list-style-type: none"> • 200 W for FSA • 240 W for FSA • 480 W for FSA • 200 W for FSB • 240 W for FSB • 600 W for FSB • 600 W for FSB • 600 W for FSC • 1200 W for FSC 	6SL3501-1BE32-0AA0 6SL3501-1BE32-4AA0 6SL3501-1BE34-8AA0 6SL3501-1BE32-0BA0 6SL3501-1BE32-4BA0 6SL3501-1BE36-0BA0 6SL3501-1BE36-0CA0 6SL3501-1BE41-2CA0
SINAMICS SD memory card <ul style="list-style-type: none"> • 512 MB, empty • 512 MB + firmware V4.7 SP14 • 512 Mbyte empty + License Extended Functions Safety (SLS) ¹⁾ • 512 Mbyte + Firmware V4.7 SP14 + License Extended Functions Safety (SLS) ¹⁾ • License (without SD Card) for upgrading license of an existing SD Card ²⁾ <p>More information on firmware V4.7 SP14: https://support.industry.siemens.com/cs/document/109817231</p> <p>For an overview and more information on all available firmware versions, see https://support.industry.siemens.com/cs/document/67364620</p>	6SL3054-4AG00-2AA0 6SL3054-7TH00-2BA0 6SL3054-4AG00-2AA0-Z F01 6SL3054-7TH00-2BA0-Z F01 6SL3074-0AA10-0AH0

Description	Article No.
SINAMICS G120 Smart Access Web server module for wireless commissioning, operation and diagnostics using a smartphone, tablet, or laptop	6SL3255-0AA00-5AA0
Interface kit for web server module SINAMICS G120 Smart Access	6SL3555-0XA00-0AA0
MindConnect IOT2040 to connect to Insights Hub via PN with up to 30 data points per second	9AC2112-0AA00-1YA2
MindConnect Nano to connect to Insights Hub via PN with up to 250 data points per second	9AC2112-8BA12-0KA1
PC converter connection kit 2 USB cable (3 m (9.84 ft) long)	6SL3255-0AA00-2CA0
Installation kit for SINAMICS G115D wall-mounted	6SL3566-2GW00-0GA0
Cover kit for outputs 380 ... 480 V AC (Q4/2) and 24 V DC (7/8" and M12)	6SL3566-2GA00-0GA0

7
1

¹⁾ The Certificate of License (CoL) is located on the SINAMICS SD card. In addition, notification of an optional download is received by email.

²⁾ With a CoL in electronic form, the license is supplied as a PDF file. Notification of this with a download link is received by email.

Clicking to SiePortal

6SL3255-0AA00-5AA0



SINAMICS G115D distributed drive system • System overview

0.37 kW to 7.5 kW (0.5 to 10 hp)

SINAMICS G115D distributed converters wall-mounted

Selection and ordering data

Supplementary system components for SINAMICS G115D

Description	Article No.
Connecting cables An overview of all available accessories (e.g. plugs and cables) can be found under the following link: www.siemens.com/distributeddrives-supplementaryproducts	
PROFINET connecting cable IE connecting cable M12-180/M12-180 axial outlet <ul style="list-style-type: none"> • 0.3 m (0.98 ft) • 0.5 m (1.64 ft) • 1 m (3.28 ft) • 1.5 m (4.92 ft) • 2 m (6.56 ft) • 3 m (9.84 ft) • 5 m (16.41 ft) • 10 m (32.81 ft) • 15 m (49 ft) 	
	6XV1870-8AE30 6XV1870-8AE50 6XV1870-8AH10 6XV1870-8AH15 6XV1870-8AH20 6XV1870-8AH30 6XV1870-8AH50 6XV1870-8AN10 6XV1870-8AN15
PROFINET connecting cable IE connecting cable M12-180/IE FC RJ45 plug 145 axial outlet <ul style="list-style-type: none"> • 2 m (6.56 ft) • 3 m (9.84 ft) • 5 m (16.41 ft) • 10 m (32.81 ft) • 15 m (49 ft) 	
	6XV1871-5TH20 6XV1871-5TH30 6XV1871-5TH50 6XV1871-5TN10 6XV1871-5TN15
PROFINET connectors IE M12 plug PRO axial outlet <ul style="list-style-type: none"> • 1 unit • 8 units 	
	6GK1901-0DB20-6AA0 6GK1901-0DB20-6AA8
AS-Interface M12 branch	
	3RK1901-2NR20
Connecting cables/plug-in connectors for 24 V DC power supply 7/8" plug-in connector axial outlet <ul style="list-style-type: none"> • Pin insert (OUT) • Socket insert (IN) 	
	6GK1905-0FA00 6GK1905-0FB00
Connecting cables/plug-in connectors for 24 V DC power supply 7/8" plug-in cable axial outlet <ul style="list-style-type: none"> • 0.3 m (0.98 ft) • 0.5 m (1.64 ft) • 1 m (3.28 ft) • 1.5 m (4.92 ft) • 2 m (6.56 ft) • 3 m (9.84 ft) • 5 m (16.41 ft) • 10 m (32.81 ft) • 15 m (49 ft) 	
	6XV1822-5BE30 6XV1822-5BE50 6XV1822-5BH10 6XV1822-5BH15 6XV1822-5BH20 6XV1822-5BH30 6XV1822-5BH50 6XV1822-5BN10 6XV1822-5BN15

Description	Article No.
Plug-in connectors for digital inputs and digital outputs Y cable for distributed I/Os for dual connection of I/Os using single cables, 5-pole, M12, 200 mm (7.87 in) Connecting cable pre-assembled at one end to connect to the line supply <ul style="list-style-type: none"> • 1.5 m (4.92 ft) • 5 m (16.41 ft) 	6ES7194-6KA00-0XA0 3RK1911-0DB13 3RK1911-0DB33
Connector set Q4/2 (angled) for energy supply <ul style="list-style-type: none"> • 2.5 mm² • 4 mm² • 6 mm² 	3RK1911-2BE50 3RK1911-2BE10 3RK1911-2BE30
Quickon system connector for connections for 380 ... 480 V AC <ul style="list-style-type: none"> • Quickon nut • Quickon connector 	6SL3566-4NA00-0GA0 6SL3566-4MA00-0GA0
Connector set Q4/2 (angled) for power loop-through <ul style="list-style-type: none"> • 2.5 mm² • 4 mm² 	3RK1911-2BF50 3RK1911-2BF10
Training case SINAMICS G115D training case SINAMICS G115D distributed drive system, PROFINET, FSA, 0.37 kW, helical geared motor, incl. SIMATIC S7-1200F and MindConnect IoT 2040	
	6AG1067-1AA38-0AA0

SINAMICS G115D distributed drive system • System overview

0.37 kW to 7.5 kW (0.5 to 10 hp)

[Clicking to SiePortal](#)

6SL3255-0AA00-5AA0

**SINAMICS G115D distributed converters wall-mounted****Selection and ordering data****Spare parts for SINAMICS G115D**

Description	Article No.
Electronic Modules	
• FSA, 0.37 kW	6SL3500-0XE50-3■A0
• FSA, 0.55 kW	6SL3500-0XE50-5■A0
• FSA, 0.75 kW	6SL3500-0XE50-7■A0
• FSA, 1.1 kW	6SL3500-0XE51-1■A0
• FSA, 1.5 kW	6SL3500-0XE51-5■A0
• FSB, 2.2 kW	6SL3500-0XE52-2■A0
• FSB, 3 kW	6SL3500-0XE53-0■A0
• FSB, 4 kW	6SL3500-0XE54-0■A0
• FSC, 5.5 kW	6SL3500-0XE55-5■A0
• FSC, 7.5 kW	6SL3500-0XE57-5■A0
<u>Fieldbus communication</u>	
• AS-Interface	A
• Without fieldbus communication	B
• PROFINET, EtherNet/IP	F
Spare parts kit for SINAMICS G115D wall-mounted	6SL3500-0XK51-0AA0
Replacement fan for SINAMICS G115D wall-mounted	6SL3500-0XF51-0AA0

SINAMICS G115D distributed drive system • Wall-mounted 0.37 kW to 7.5 kW (0.5 to 10 hp)

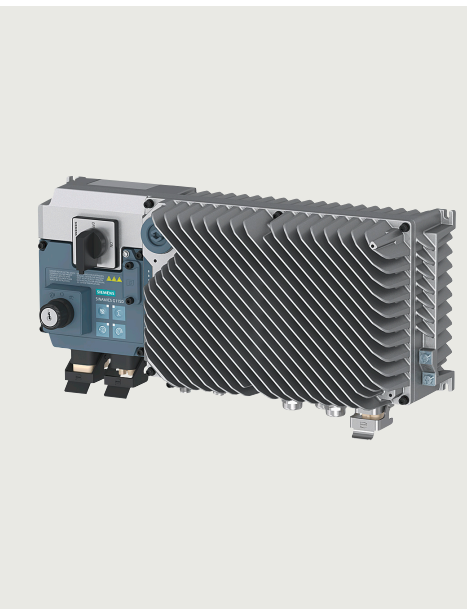

7.2/2 SINAMICS G115D distributed drive system wall-mounted

7.2/2 Overview

7.2/3 Benefits

7.2/3 Application

7.2/4 SINAMICS G115D distributed converters wall-mounted

7.2/4 Design

7.2/5 Function

7.2/6 Integration

7.2/7 Configuration

7.2/8 Selection and ordering data

7.2/11 Technical specifications

7.2/16 Characteristic curves

7.2/17 Dimensional drawings

7.2/18 More information

SINAMICS G115D distributed drive system • Wall-mounted

0.37 kW to 7.5 kW (0.5 to 10 hp)

SINAMICS G115D distributed drive system wall-mounted

Overview

The SINAMICS G115D decentralized frequency converter meets all the requirements that system manufacturers place on drives for horizontal applications in conveyor technology, with a focus on the intralogistics and airport industries as well as for horizontal applications in the automotive and food & beverage industries.

The converter is supplied with protection class up to IP66 and sets standards in terms of efficiency – from the installation phase to commissioning and handling. The SINAMICS G115D decentralized frequency converter is the first choice for users who want to move conveyed goods quickly and efficiently.

The wall-mounted converter with different unit versions (frame sizes FSA to FSC) in a performance range from 0.37 kW to 7.5 kW is suitable for a large number of different applications. The converter supports geared motors from our product partner Innomotics *) with three-phase asynchronous motors with efficiency class up to IE3 or high-efficiency synchronous reluctance motors with efficiency class IE4.

It meets all requirements for horizontal conveyor system applications – from simple speed control to sophisticated encoderless vector control. Thanks to the compact design with degree of protection IP65 (plug-in connection) or IP66 (cable gland), it can be seamlessly integrated.

The integrated conveyor technology functions make the SINAMICS G115D particularly suitable for applications in conveyor systems.

For applications that require safety technology, the SINAMICS G115D offers the integrated STO (Safe Torque Off) function, which can be implemented without additional external components.

In addition, as of firmware V4.7 SP14 in conjunction with SINAMICS Startdrive from V18 SP1, the safety function SLS (Safely-Limited Speed) is available via Safety Extended license.

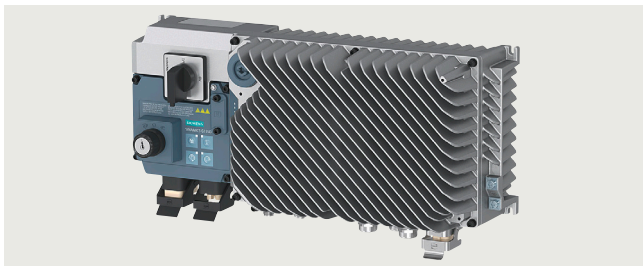

Example: SINAMICS G115D distributed frequency converter, wall-mounted, PROFINET, version with plug-in connection, FSB, 2.2 kW, local remote control with key-operated switch and repair switch

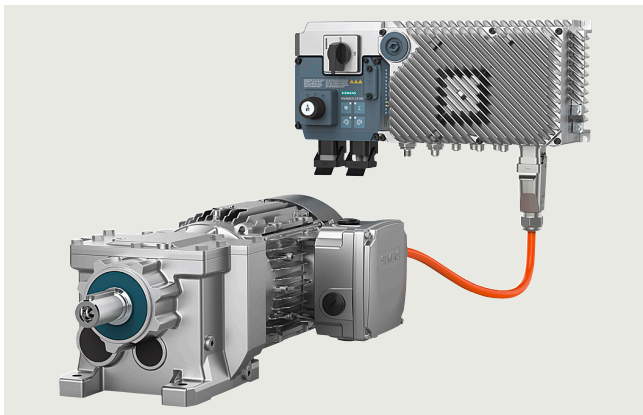

Example: SINAMICS G115D distributed frequency converter wall-mounted, PROFINET, version with plug-in connection, FSA, 1.5 kW, local remote control with key-operated switch and repair switch, in connection with a geared motor from our product partner Innomotics *)

Perfect combination with SIMATIC controllers and PROFINET

Integration via PROFINET communication with PROFIsafe, AS-Interface, EtherNet/IP into a higher-level control system is very easy thanks to full TIA Portal integration, which provides a tool as well as an operating and data management concept. In addition, an optional web server module is available with the web server module SINAMICS G120 Smart Access (SAM) – a WLAN-based web server solution for simple and fast wireless setup with smartphone, tablet or laptop during commissioning and for diagnostics.

The SINAMICS G115D distributed frequency converter is ready for digitalization. The recorded operating data can be analyzed via the Industrial Edge or in the cloud, e.g. with the Drivetrain Analyzer application. This facilitates the process evaluation of the operating data, with the possibility of adapting it to individual customer requirements. This simplifies the recording and evaluation of the operating conditions of the drive system.

Reasons for using the SINAMICS G115D distributed frequency converter

- User-friendly modular solution – pre-configured and ready for connection
- Versatile, robust and reliable system
- New design for quick and easy installation, cabling and commissioning
- No control cabinet required, thanks to the installation on the machine less space required and lower cooling requirements
- Long cables between the converters and the motors can be avoided (thus less power loss, reduced interference emissions, and lower costs for shielded cables and additional filters)
- Supports geared motors from our product partner Innomotics *) with asynchronous motors and high-efficiency synchronous reluctance motors according to efficiency class IE4
- Temperature range from -30 °C to 55 °C (suitable for installation in deep-freeze applications)
- Integrated safety, STO (Safe Torque Off) via fail-safe digital input F-DI or PROFIsafe and from firmware V4.7 SP14 in conjunction with SINAMICS Startdrive from V18 SP1, the function SLS (Safely-Limited Speed) via Safety Extended license
- Perfectly prepared for digitalization thanks to different communication interfaces and integration via Industrial Edge or in the cloud, e.g. with the Drivetrain Analyzer application
- Special properties for the intralogistics market (e.g. repair switches, local remote control, Safety Integrated, conveyor technology functions)

The family of distributed frequency converters at Siemens

Siemens offers an innovative portfolio of frequency converters for optimal implementation in distributed drive solutions. The strengths of the individual members of the converter family allow easy adaptation to the most diverse application requirements:

- Identical connection systems
- User-friendly commissioning and configuration tools

Products from the family of distributed drives:

- SINAMICS G115D distributed frequency converters
- SINAMICS G120D frequency converters
- SIMATIC ET 200pro FC-2 frequency converters
- SIRIUS M200D motor starters

*) Further information about the products of our product partner Innomotics can be found under www.innomotics.com

SINAMICS G115D distributed drive system • Wall-mounted

0.37 kW to 7.5 kW (0.5 to 10 hp)

SINAMICS G115D distributed drive system wall-mounted

Overview

Hardware configuration

The wall-mounted converter with its different versions (frame sizes FSA to FSC) in a performance range from 0.37 kW to 7.5 kW is suitable for a large number of different applications. Thanks to the compact design with degree of protection IP65 (plug-in connection) or IP66 (cable gland), it can be seamlessly integrated.

The converter is configurable regarding fieldbus communication (AS-Interface or PROFINET / EtherNet/IP) and connection method (cable gland or plug-in connection). Furthermore, the wall-mounted frequency converter can be configured with a repair switch, local remote control and the control voltage of the motor holding brake.

State-of-the-art IGBT technology with pulse width modulation (PWM) is used for extremely reliable and flexible motor operation. The closed-loop control electronics control and monitor the power electronics and the connected motor in several different control modes that can be selected.

The sensors of the conveyor element can be connected to the digital inputs of the converter. These signals can be transmitted to the higher-level control for further processing via PROFINET, EtherNet/IP or AS-Interface.

Safety Integrated

The SINAMICS G115D distributed frequency converters are already equipped with the Safety Integrated Function STO (Safe Torque Off), with certification according to IEC 61508 SIL 2 as well as ISO 13849-1 PL d and Category 3. This can be activated either via the PROFIsafe communication protocol or via the fail-safe digital input F-DI.

In addition, as of firmware V4.7 SP14 in conjunction with SINAMICS Startdrive from V18 SP1, the safety function SLS (Safely-Limited Speed) is available via Safety Extended license.

Benefits

Easy commissioning

- Loop-through of 24 V DC and 380 to 480 V 3 AC and communication – no T distributors necessary
- Internal braking resistor – typical applications can be implemented without external braking resistor; optional external braking resistors are available for higher regenerative energy.
- Robust with degree of protection IP65/66, ambient temperature from -30 °C to 55 °C
- Quick and easy commissioning options:
 - via local DIP switches and potentiometers
 - via web server module SINAMICS G120 Smart Access (SAM) with web server and WLAN connection for using a smartphone, tablet or laptop in just a few steps
 - via TIA Portal with SINAMICS Startdrive for the use of a PC
- Wiring of the drive system either via screw connections or via plug connectors. Communication (PROFINET, EtherNet/IP or AS-Interface) generally via plug connectors
- Local diagnostics with LEDs
- Uploading, backup and cloning of the parameters with SINAMICS SD memory card

Full functionality

- Integrated communication: PROFINET, EtherNet/IP and AS-Interface
- Integrated Safety Functions (STO locally via fail-safe digital input F-DI or via PROFIsafe communication protocol) and from firmware V4.7 SP14 in conjunction with SINAMICS Startdrive from V18 SP1, the function SLS (Safely-Limited Speed) via Safety Extended license
- Inputs/outputs can be used as distributed I/O of the PLC
- Basic PLC functions and additional functions for conveyor technology:
 - Horizontal conveyors: fast/slow, Quick Stop, 1 or 2 directions
 - Rotary table: fast/slow, Quick Stop, 2 or 3 positions and limit trip
 - Corner transfer conveyors lift drive: fast/slow, Quick Stop and limit trip
 - Traversing carriage: fast/slow, Quick Stop and limit trip

Efficient engineering

- Full integration in Totally Integrated Automation (TIA) and TIA Portal
- Intuitive selection tools
 - Siemens Product Configurator
 - TIA Selection Tool (TST)
- SINAMICS Startdrive as part of the TIA Portal offers complete integration for intuitive parameterization
- Automatic diagnostics in combination with SIMATIC control

Flexible commissioning functions

- Integrated conveyor technology functions
 - Quick Stop function for fast reaction times for the sensors, e.g. roller conveyors, belt conveyors
 - Limit switch function, e.g. for rotary table, corner transfer unit
- Graphical commissioning of the conveyor technology functions in just a few steps
- Integrated inputs/outputs with variable assignment
- Use of the same software tool (SINAMICS Startdrive) as for all SINAMICS drives

Extended warranty

For SINAMICS G115D, Siemens offers an optional extension of warranty up to 2 ¹/₂ years via **Service Protect**:

- Free for the first 6 months after registering the product at: www.siemens.com/serviceprotect
- Subject to a charge for a further 1 or 2 years

For further information, go to:

<https://support.industry.siemens.com/cs/ww/en/sc/4842>

Concerning standard warranty please ask your partner at Siemens. Your partner can be found in our Personal Contacts Database at:

www.siemens.com/automation-contact

Application

The SINAMICS G115D distributed frequency converters are ideally suited for horizontal conveyor applications, e.g.:

- Roller, belt and chain conveyors
- Simple rotary tables
- Simple transverse shuttles

Reliable operation in harsh environments

The SINAMICS G115D distributed frequency converters are suitable for use in harsh environments

- Degree of protection IP65 (plug-in connector) or IP66 (cable gland)
- Use in ambient temperatures from -30 °C to 55 °C
- Coated PCBs for increased resistance to humidity and dust (Class 3C2), operation according to EN 60721-3-3

SINAMICS G115D distributed drive system • Wall-mounted

0.37 kW to 7.5 kW (0.5 to 10 hp)

SINAMICS G115D distributed converters wall-mounted

Design

The converter is configurable regarding fieldbus communication (AS-Interface or PROFINET / EtherNet/IP) and connection system (cable gland or plug-in connection).

Furthermore, the wall-mounted version can be configured with a repair switch, local remote control and the control voltage of the motor holding brake.

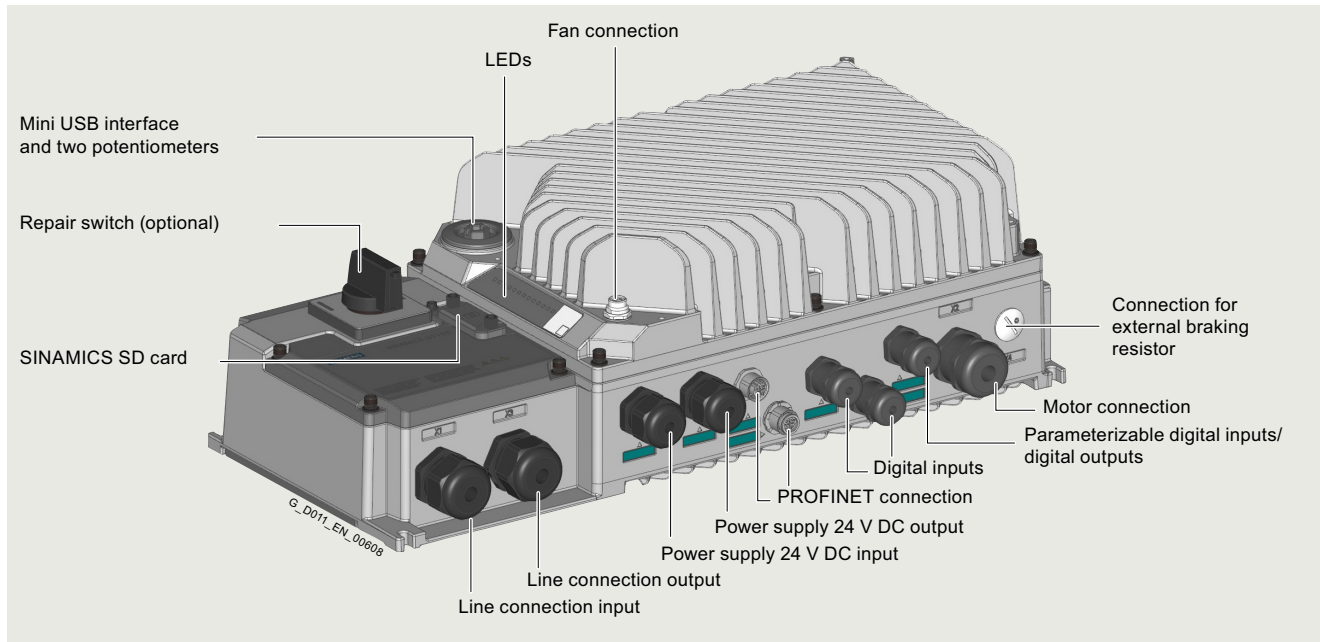

Example: SINAMICS G115D, wall-mounted, version with cable gland and optional repair switch

Repair switch

The wall-mounted converter is available as a version with an integrated repair switch. The repair switch isolates the SINAMICS G115D distributed drive system on the line side from the line supply. It can be secured against reconnection. The switch position can be evaluated with a status signal.

Local remote control with key-operated switch

Master control can be toggled between automatic mode (PLC) and local remote mode using the local remote control. This can also be used to switch off the converter and acknowledge pending faults. Additional functions include switching over between continuous and jog mode, starting the motor including direction of rotation and deactivating the Quick Stop in the manual mode.

24 V DC power supply

The SINAMICS G115D converter is available as a version with an integrated 24 V DC power supply. If this is switched off in a version with the integrated repair switch, the 24 V DC power supply continues to remain active.

Brake control

As standard, brake control with 180 V DC (independent of the line voltage) is integrated. An optional brake control with 380 V to 480 V AC (same as the line voltage) can be selected.

Supplementary system components

SINAMICS SD memory card

The parameter settings of the converter and the firmware can be stored on the optional SINAMICS SD memory card. When service is required, the data are automatically downloaded from the memory card in the converter and the system is ready for use again without further interventions.

External braking resistors

Regenerative energy is converted to heat via the internal braking resistor integrated as standard. Optional external braking resistors are available for higher regenerative energy.

Installation kit

An installation kit with cable glands for the line supply (X1/X3), the motor (X2), the 24 V DC power supply (X01/X02) and the digital inputs/digital outputs (X07/X08/X05) can be ordered for the connection.

Cover kit

The cover kit is used to protect the unused connector plugs for line supply, loop-through (X3) and 24 V DC loop-through (X02).

Connecting cables for communication

Flexible plug-in cables to transfer data between the PROFINET/Industrial Ethernet stations or AS-Interface stations, as well as for 24 V DC power supply.

Connecting cables for line supply, power loop-through and power bus distribution

Connector sets to connect to the line supply and the outgoing motor feeder are available as accessories as well as pre-assembled motor cables for connection to the motor.

PC converter connection kit 2 (mini USB interface cable) for communication with a PC

For controlling and commissioning a converter directly from a PC if the appropriate software (commissioning tool SINAMICS Startdrive V16 update 4 and higher) is installed.

DesignSINAMICS G120 Smart Access (SAM) web server module

Smart Access for the SINAMICS G115D distributed drive system with web server for easy commissioning and diagnostics via WLAN with a smartphone, tablet or laptop in just a few steps.

Interface kit for SINAMICS G120 Smart Access (SAM) web server module

With the interface kit, the SINAMICS G120 Smart Access web server module can be connected to the SINAMICS G115D converter.

SINAMICS G115D training case

The SINAMICS G115D training case is a convincing demonstration system thanks to its compact design. It is suitable for direct customer presentations as well as for testing in the technical department. The functions of SINAMICS G115D in combination with a geared motor can be demonstrated and tested quickly and easily with this case.

Spare partsElectronic Modules

The entire drive electronics is located in the Electronic Module. Thus, in most service cases only this module must be replaced. If a converter fails, this replacement can be performed easily and quickly.

Spare parts kit

A spare parts kit is available, which contains small parts such as seals, cover caps and screws.

Replacement fan

A replacement fan is available, which consists of a pre-assembled unit comprising cover, fan and screws.

Function**Technology functions**

Specific functions for conveyor technology:

- Integrated communication: PROFINET / EtherNet/IP or AS-Interface
- Integrated Safety Functions (STO locally via fail-safe digital input F-DI or via PROFIsafe communication protocol) and from firmware V4.7 SP14 in conjunction with SINAMICS Startdrive from V18 SP1, the function SLS (Safely-Limited Speed) via Safety Extended license
- Inputs/outputs can be used as distributed I/O of the PLC
- Basic PLC functions and additional functions for conveyor technology:
 - Chain and belt conveyors: fast/slow, Quick Stop, 1 or 2 directions
 - Rotary table: fast/slow, Quick Stop, 2 or 3 positions and limit trip
 - Corner transfer conveyors lift drive: fast/slow, Quick Stop and limit trip
 - Traversing carriage: fast/slow, Quick Stop and limit trip

SINAMICS G115D distributed drive system • Wall-mounted

0.37 kW to 7.5 kW (0.5 to 10 hp)

SINAMICS G115D distributed converters wall-mounted

Integration

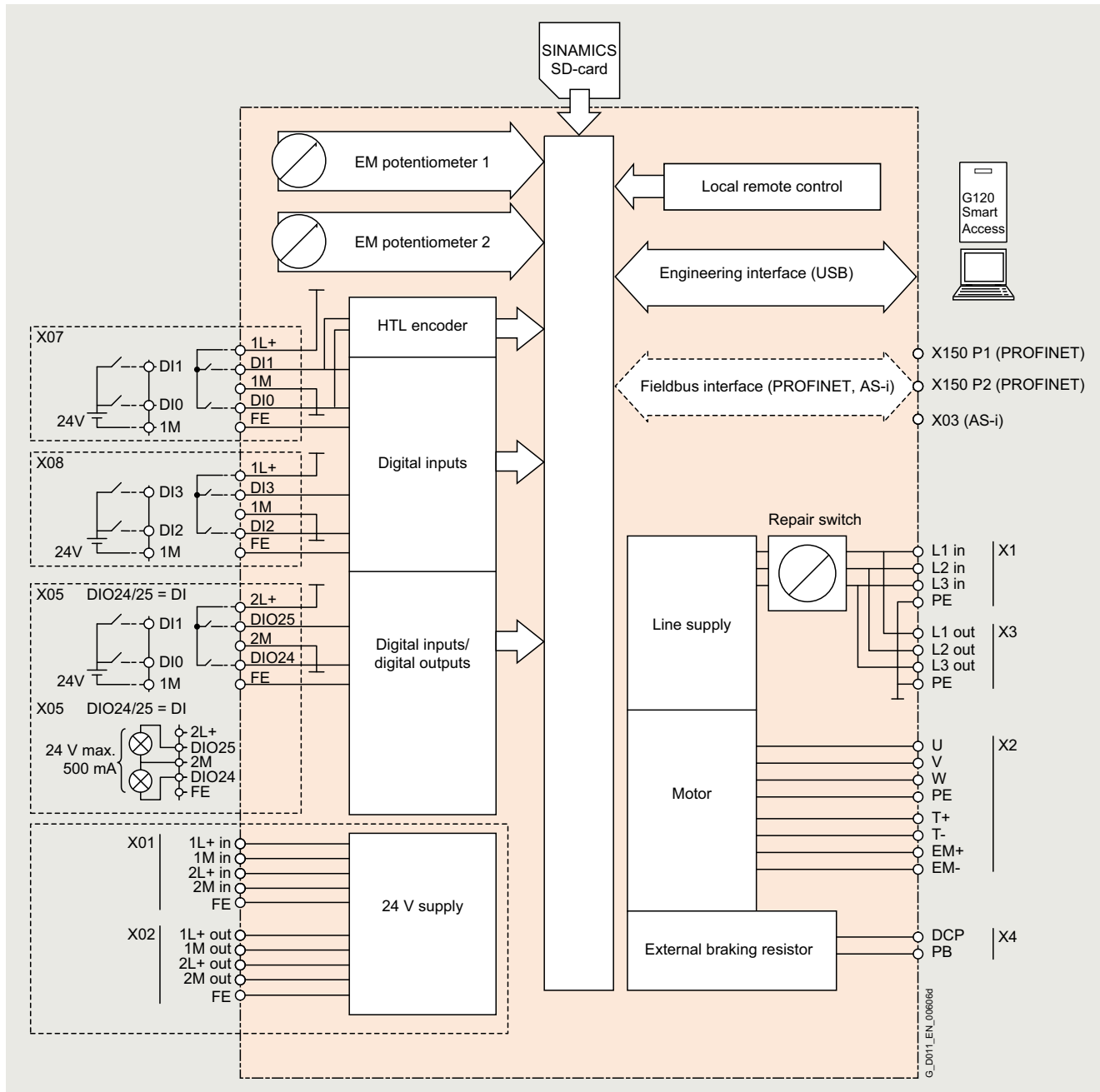

Connection example for SINAMICS G115D, wall-mounted

7
2

G_D011_EN_006060

SINAMICS G115D distributed drive system • Wall-mounted

0.37 kW to 7.5 kW (0.5 to 10 hp)

SINAMICS G115D distributed converters wall-mounted

Configuration

The following configuring tools and engineering tools are available for the SINAMICS G115D:

DriveSim Designer (firmware V4.7 SP13 or higher)

DriveSim Designer provides easy-to-use models for PROFIdrive-enabled SINAMICS converters, so you can create a digital twin of your drive.

More information is provided on the internet at:
www.siemens.com/drive-virtualization

Siemens Product Configurator

The Siemens Product Configurator helps you configure the optimum drive technology products for a number of applications – starting with motors and converters as well as the associated options and components and ending with controllers, software licenses and connection systems. The Siemens Product Configurator can be used on the internet without requiring any installation. The Siemens Product Configurator can be found in SiePortal at the following address:
www.siemens.com/spc

SINAMICS Startdrive commissioning tool (V16 update 4 and higher)

SINAMICS Startdrive is a tool integrated into the TIA Portal for configuring, commissioning and diagnostics of the SINAMICS converter family. SINAMICS Startdrive (V16 update 4 and higher) can be used for implementing drive tasks with most of the SINAMICS G and SINAMICS S converter series. The commissioning tool has been optimized in terms of simplicity, ease of use, and consistent use of the benefits of the TIA Portal to provide a uniform working environment for PLC, HMI and drives.

The SINAMICS Startdrive commissioning tool is available for free on the internet at:
www.siemens.com/startdrive

Drive dimensioning of the SINAMICS G115D distributed frequency converters with the TIA Selection Tool

The SINAMICS G115D distributed frequency converters are easily configured with the TIA Selection Tool under the Drive Dimensioning plug-in. It provides support when selecting the hardware and firmware components necessary to implement a drive task.

The TIA Selection Tool is available for free on the internet at
www.siemens.com/tia-selection-tool-standalone

SIMARIS planning tools for plants with SINAMICS drives

Electrical planning: Even easier with software!

Electrical planning for power distribution in non-residential and industrial buildings has never been more complex. To ensure you, as a specialist planner, have the best hand when it comes to electrical planning with SINAMICS drives, we provide support with the following efficient software tools:

- SIMARIS design for dimensioning
- SIMARIS project for calculating the space requirements of the distribution boards

SINAMICS G115D distributed drive system • Wall-mounted

0.37 kW to 7.5 kW (0.5 to 10 hp)

SINAMICS G115D distributed converters wall-mounted

Selection and ordering data

SINAMICS G115D distributed converters wall-mounted - 380 ... 480 V 3 AC							
Rated power ¹⁾		Rated output current I_N ²⁾	Rated input current ³⁾	Frame size	SINAMICS G115D wall-mounted Degree of protection IP65/IP66/UL Type 4X with integrated line filter class A according to EN 55011		
400 V kW	480 V hp	at 400 V A	at 400 V A		Data position in Article No.		
					1 2 3 4 5 6 7 - 8 9 10 11 12 - 13 14 15 16		
380 ... 480 V 3 AC · Rated pulse frequency 4 kHz · Input frequency 45 ... 66 Hz							
0.37	0.5	1.3	1.23	FSA	6 S L 3 5 2 - - X 0 - 3 A 0		
0.55	0.75	1.7	1.58	FSA	6 S L 3 5 2 - - X 0 - 5 A 0		
0.75	1	2.2	1.99	FSA	6 S L 3 5 2 - - X 0 - 7 A 0		
1.1	1.5	3.1	2.69	FSA	6 S L 3 5 2 - - X 1 - 1 A 0		
1.5	2	4.1	3.48	FSA	6 S L 3 5 2 - - X 1 - 5 A 0		
2.2	3	5.9	5.18	FSB	6 S L 3 5 2 - - X 2 - 2 A 0		
3.0	4	7.7	6.76	FSB	6 S L 3 5 2 - - X 3 - 0 A 0		
4.0	5	10.2	8.95	FSB	6 S L 3 5 2 - - X 4 - 0 A 0		
5.5	7.5	13.2	11.88	FSC	6 S L 3 5 2 - - X 5 - 5 A 0		
7.5	10	19	17.11	FSC	6 S L 3 5 2 - - X 7 - 5 A 0		
Article No. supplements							
Brake control							
180 V DC (independent of the line voltage) *)							
380 ... 480 V AC (such as line voltage)							
Operating options							
Without operating option *)							
Repair switch							
Local remote control							
Repair switch and local remote control							
Connection type	Fieldbus communication	I/O	Motor	380 ... 480 V AC	24 V DC ⁵⁾		
Cable gland with daisy chain	M12	Cable gland *)			A 2		
		M12	Cable gland		A 6		
			Q8/0	Cable gland		R 0	
		Cable gland		2 × Power M12 ⁶⁾		R 1	
		Cable gland		Power supply unit integrated		H 2	
Plug-in connection without daisy chain	M12	M12	Q8/0	Q4/2	7/8* ⁵⁾	B 0	
				Power M12 ⁶⁾		B 4	
				Quickon ⁴⁾		C 0	
				MQ15 ⁴⁾		D 0	
				Q4/2		Power supply unit integrated	K 0
				Quickon ⁴⁾		Power supply unit integrated	L 0
Plug-in connection with daisy chain	M12	M12	Q8/0	2 × Q4/2		E 0	
				2 × Power M12 ⁶⁾		E 4	
				Power supply unit integrated		N 0	
Fieldbus communication							
AS-Interface							
PROFINET, EtherNet/IP							

* If you select "Brake voltage 180 V DC" and "Without operating option" in combination with one of the connection types **A2** or **E0**, the delivery time will change from **standard delivery time** to **delivery ex stock**.

1) Rated power based on the rated output current I_N . The rated output current I_N is based on the duty cycle for high overload (HO).
 2) The rated output current I_N is based on the duty cycle for high overload (HO). These current values apply at 400 V and are specified on the rating plate of the converter.
 3) The input current depends on the motor load and line impedance. The input currents apply for a load at rated power for a line impedance corresponding to $u_K = 4\%$. The current values are specified on the rating plate of the converter.

4) Not suitable for UL applications (FSA and FSB). Not available for FSC.
 5) Plug-in connector for 24 V DC with fieldbus communication AS-Interface not available. For AS-Interface the 24 V DC power supply is provided via the M12 plug-in connector for fieldbus communication.
 6) Version **B4** or **E4** with fieldbus communication AS-Interface cannot be ordered, is covered by version **B0** or **E0**.

Clicking to SiePortal

6SL3255-0AA00-5AA0



SINAMICS G115D distributed drive system • Wall-mounted

0.37 kW to 7.5 kW (0.5 to 10 hp)

SINAMICS G115D distributed converters wall-mounted

Selection and ordering data

Supplementary system components for SINAMICS G115D

Description	Article No.
Fuses	
<ul style="list-style-type: none"> • 10 A for FSA • 16 A for FSB • 32 A for FSC 	3NA3803 3NA3805 3NA3812
External braking resistors	
Continuous braking power	
<ul style="list-style-type: none"> • 200 W for FSA • 240 W for FSA • 480 W for FSA • 200 W for FSB • 240 W for FSB • 600 W for FSB • 600 W for FSC • 1200 W for FSC 	6SL3501-1BE32-0AA0 6SL3501-1BE32-4AA0 6SL3501-1BE34-8AA0 6SL3501-1BE32-0BA0 6SL3501-1BE32-4BA0 6SL3501-1BE36-0BA0 6SL3501-1BE36-0CA0 6SL3501-1BE41-2CA0
SINAMICS SD memory card	
<ul style="list-style-type: none"> • 512 MB, empty • 512 MB + firmware V4.7 SP14 • 512 Mbyte empty + License Extended Functions Safety (SLS) ¹⁾ • 512 Mbyte + Firmware V4.7 SP14 + License Extended Functions Safety (SLS) ¹⁾ • License (without SD Card) for upgrading license of an existing SD Card ²⁾ <p>More information on firmware V4.7 SP14: https://support.industry.siemens.com/cs/document/109817231</p> <p>For an overview and more information on all available firmware versions, see https://support.industry.siemens.com/cs/document/67364620</p>	6SL3054-4AG00-2AA0 6SL3054-7TH00-2BA0 6SL3054-4AG00-2AA0-Z F01 6SL3054-7TH00-2BA0-Z F01 6SL3074-0AA10-0AH0
SINAMICS G120 Smart Access	6SL3255-0AA00-5AA0
Web server module for wireless commissioning, operation and diagnostics using a smartphone, tablet, or laptop	
Interface kit	6SL3555-0XA00-0AA0
for web server module SINAMICS G120 Smart Access	
MindConnect IOT2040	9AC2112-0AA00-1YA2
to connect to Insights Hub via PN with up to 30 data points per second	
MindConnect Nano	9AC2112-8BA12-0KA1
to connect to Insights Hub via PN with up to 250 data points per second	
PC converter connection kit 2	6SL3255-0AA00-2CA0
USB cable (3 m (9.84 ft) long)	
Installation kit	6SL3566-2GW00-0GA0
for SINAMICS G115D wall-mounted	
Cover kit	6SL3566-2GA00-0GA0
for outputs 380 ... 480 V AC (Q4/2) and 24 V DC (7/8" and M12)	

Description	Article No.
Connecting cables	
An overview of all available accessories (e.g. plugs and cables) can be found under the following link: www.siemens.com/distributeddrives-supplementaryproducts	
PROFINET connecting cable	
IE connecting cable M12-180/M12-180 axial outlet	
<ul style="list-style-type: none"> • 0.3 m (0.98 ft) • 0.5 m (1.64 ft) • 1 m (3.28 ft) • 1.5 m (4.92 ft) • 2 m (6.56 ft) • 3 m (9.84 ft) • 5 m (16.41 ft) • 10 m (32.81 ft) • 15 m (49 ft) 	6XV1870-8AE30 6XV1870-8AE50 6XV1870-8AH10 6XV1870-8AH15 6XV1870-8AH20 6XV1870-8AH30 6XV1870-8AH50 6XV1870-8AN10 6XV1870-8AN15
PROFINET connecting cable	
IE connecting cable M12-180/IE FC RJ45 plug 145 axial outlet	
<ul style="list-style-type: none"> • 2 m (6.56 ft) • 3 m (9.84 ft) • 5 m (16.41 ft) • 10 m (32.81 ft) • 15 m (49 ft) 	6XV1871-5TH20 6XV1871-5TH30 6XV1871-5TH50 6XV1871-5TN10 6XV1871-5TN15
PROFINET connectors	
IE M12 plug PRO axial outlet	
<ul style="list-style-type: none"> • 1 unit • 8 units 	6GK1901-0DB20-6AA0 6GK1901-0DB20-6AA8
AS-interface M12 branch	3RK1901-2NR20
Connecting cables/plug-in connectors for 24 V DC power supply	
7/8" plug-in connector axial outlet	
<ul style="list-style-type: none"> • Pin insert (OUT) • Socket insert (IN) 	6GK1905-0FA00 6GK1905-0FB00
Connecting cables/plug-in connectors for 24 V DC power supply	
7/8" plug-in cable axial outlet	
<ul style="list-style-type: none"> • 0.3 m (0.98 ft) • 0.5 m (1.64 ft) • 1 m (3.28 ft) • 1.5 m (4.92 ft) • 2 m (6.56 ft) • 3 m (9.84 ft) • 5 m (16.41 ft) • 10 m (32.81 ft) • 15 m (49 ft) 	6XV1822-5BE30 6XV1822-5BE50 6XV1822-5BH10 6XV1822-5BH15 6XV1822-5BH20 6XV1822-5BH30 6XV1822-5BH50 6XV1822-5BN10 6XV1822-5BN15
Plug-in connectors for digital inputs and digital outputs	6ES7194-6KA00-0XA0
Y cable for distributed I/Os for dual connection of I/Os using single cables, 5-pole, M12, 200 mm (7.87 in)	
Connecting cable pre-assembled at one end to connect to the line supply	
<ul style="list-style-type: none"> • 1.5 m (4.92 ft) • 5 m (16.41 ft) 	3RK1911-0DB13 3RK1911-0DB33
Connector set Q4/2 (angled) for energy supply	
<ul style="list-style-type: none"> • 2.5 mm² • 4 mm² • 6 mm² 	3RK1911-2BE50 3RK1911-2BE10 3RK1911-2BE30
Quickon system connector for connections for 380 ... 480 V AC	
<ul style="list-style-type: none"> • Quickon nut • Quickon connector 	6SL3566-4NA00-0GA0 6SL3566-4MA00-0GA0
Connector set Q4/2 (angled) for power loop-through	
<ul style="list-style-type: none"> • 2.5 mm² • 4 mm² 	3RK1911-2BF50 3RK1911-2BF10
Training case	
SINAMICS G115D training case	6AG1067-1AA38-0AA0
SINAMICS G115D distributed drive system, PROFINET, FSA, 0.37 kW, helical geared motor, incl. SIMATIC S7-1200F and MindConnect IoT 2040	

¹⁾ The Certificate of License (CoL) is located on the SINAMICS SD card. In addition, notification of an optional download is received by email.
²⁾ With a CoL in electronic form, the license is supplied as a PDF file. Notification of this with a download link is received by email.

SINAMICS G115D distributed drive system • Wall-mounted

0.37 kW to 7.5 kW (0.5 to 10 hp)

[Clicking to SiePortal](#)
[6SL3255-0AA00-5AA0](#)

SINAMICS G115D distributed converters wall-mounted

Selection and ordering data

Spare parts for SINAMICS G115D

Description	Article No.
Electronic Modules	
• FSA, 0.37 kW	6SL3500-0XE50-3■A0
• FSA, 0.55 kW	6SL3500-0XE50-5■A0
• FSA, 0.75 kW	6SL3500-0XE50-7■A0
• FSA, 1.1 kW	6SL3500-0XE51-1■A0
• FSA, 1.5 kW	6SL3500-0XE51-5■A0
• FSB, 2.2 kW	6SL3500-0XE52-2■A0
• FSB, 3 kW	6SL3500-0XE53-0■A0
• FSB, 4 kW	6SL3500-0XE54-0■A0
• FSC, 5.5 kW	6SL3500-0XE55-5■A0
• FSC, 7.5 kW	6SL3500-0XE57-5■A0
<u>Fieldbus communication</u>	
• AS-Interface	A
• Without fieldbus communication	B
• PROFINET, EtherNet/IP	F
Spare parts kit for SINAMICS G115D wall-mounted	6SL3500-0XK51-0AA0
Replacement fan for SINAMICS G115D wall-mounted	6SL3500-0XF51-0AA0

SINAMICS G115D distributed drive system • Wall-mounted

0.37 kW to 7.5 kW (0.5 to 10 hp)

SINAMICS G115D distributed converters wall-mounted

Technical specifications

Converters - General technical specifications	
Line voltage	380 V (-10 %) ... 480 V (+10 %) 3 AC
Line supply requirements	$u_K < 4\%$ ($R_{SC} > 25$)
Short-circuit power ratio R_{SC}	
Input frequency	45 ... 66 Hz
Output frequency	0 ... 550 Hz
• Control mode V/f	0 ... 550 Hz
• Control mode Vector	0 ... 240 Hz
Pulse frequency	4 kHz (standard); 4 ... 16 Hz (in steps of 2 kHz) see derating data
Power factor	0.80 ... 0.91
Converter efficiency acc. to IEC 61800-9-2	95 ... 98 %
Efficiency class acc. to IEC 61800-9-2	IE2
Output voltage, max. as % of input voltage	87 ... 95 %
Overload capability	
• High overload (HO)	2 × rated output current for 3 s, followed by 1.5 × rated output current for 57 s, over a cycle time of 300 s
Electromagnetic compatibility	Integrated line filter category C2 according to EN 61800-3 (corresponds to class A according to EN 55011)
Possible braking methods	<ul style="list-style-type: none"> • Dynamic brake with internal braking resistor • Dynamic brake with external braking resistors $R_{min} = 200\ \Omega$ (for FSA), $R_{min} = 80\ \Omega$ (for FSB), $R_{min} = 40\ \Omega$ (for FSC) • Electromechanical (EM) brake: <ul style="list-style-type: none"> - 180 V DC (independent of the line voltage, max. output current 0.8 A) Disconnection on the DC side permits short brake application times. - 380 ... 480 V AC (such as line voltage, max. output current 1 A)
Vibration and shock load	
• Transport according to EN 60721-3-2: 1997	Class 1M2
• Operation according to EN 60721-3-3: 1995	Class 3M2
Environmental class/ harmful chemical substances Operation acc. to EN 60721-3-3	Class 3C2
Degree of pollution According to EN 61800-5-1	2
External 24 V supply According to IEC 60204-1	Touch-proof SELV or PELV power supply. The supply voltage must not exceed 60 V DC under single-fault conditions.
Protection class According to IEC 61800-5-1	Class I (with protective grounding conductor)
Degree of protection	IP65 (for plug-in connection) IP66 (for cable gland) IP65 (for cable gland and motor connection Q8/0) UL type 4X (except for MQ15/Quickon versions)

Converters - General technical specifications	
Operating temperature	-30 ... +40 °C (-22 ... 104 °F) without derating >40 ... 55 °C (104 ... 131 °F) see derating characteristics
Storage temperature	-40 ... +70 °C (-40 ... +158 °F)
Permissible mounting positions	All Derating for specific mounting positions, see operating instruction on the internet at: www.siemens.com/sinamics-g115d/documentation
Relative air humidity	<95 % condensation, icing and salt mist not permissible
Cooling	
• 0.37 ... 3 kW	Natural cooling
• 4 ... 7.5 kW	External cooling with mounted fan
Installation altitude	Up to 1000 m (3281 ft) above sea level without derating Over 1000 m (3281 ft) to 4000 m (13124 ft) see derating data
Short Circuit Current Rating (SCCR) ¹⁾	65 kA
Protection functions	<ul style="list-style-type: none"> • Undervoltage • Phase failure detection • Overvoltage • Overload • Ground fault • Short-circuit • Stall protection • Motor blocking protection • Motor overtemperature • Converter overtemperature • Parameter locking
Certification for fail-safe versions	
• According to EN ISO 13849-1	Category 3
• According to IEC 61508	SIL 2
• According to EN ISO 13849-1	PL d
• PFH according to IEC 61800-5-2	$<50 \times 10^{-9}$
• PFD according to IEC 61508	$<50 \times 10^{-5}$
• Duration of assignment T1	20 years
Compliance with standards	UL 61800-5-1 (UL list number E355661), CE, UKCA, RCM, EAC, KC
CE marking, according to	Low-Voltage Directive 2014/35/EU Eco-design requirements of EU Directive 2019/1781 Filtered variants also: EMC Directive 2014/30/EU

Environmental Product Declaration (EPD)

Environmental Product Declarations (EPD) are available as PDFs for this product.

The EPD PDF provides brief and concise information about the ecological properties of a product.

You can find more information on the internet at:

<https://support.industry.siemens.com/cs/ww/en/ps/27867/cert?ci=5690>

¹⁾ Applies to industrial control cabinet installations according to NEC Article 409 or UL 508A.

SINAMICS G115D distributed drive system • Wall-mounted

0.37 kW to 7.5 kW (0.5 to 10 hp)

SINAMICS G115D distributed converters wall-mounted

Technical specifications

Converter 6SL352 . . . X . . . -	AS-Interface . AA0	PROFINET, EtherNet/IP . AF0
Electrical specifications		
Operating voltage	External 24 V DC	
Current consumption (from the 24 V DC supply)		
• With Power Module frame size FSA	290 mA	290 mA
• With Power Module frame size FSA without fan (2.2 kW and 3 kW)	290 mA	290 mA
• With Power Module frame size FSB with fan (4 kW)	550 mA	550 mA
• With Power Module frame size FSC with fan	580 mA	580 mA
Interfaces		
Digital inputs (not isolated)	4 programmable, PNP, SIMATIC compatible	
• Optional for safe inputs, parameterizable	2 DI = 1F-DI	
• Optionally usable as encoder inputs	2, for connection of an HTL encoder (A and B track)	
• Conductor cross-section (only for version with cable gland)	0.25 ... 0.34 mm ² (24 ... 22 AWG) with end sleeves	
Digital outputs	2, switchable DI/DO	
• Optional for safe inputs, parameterizable	–	
• Conductor cross-section (only for version with cable gland)	0.25 ... 0.34 mm ² (24 ... 22 AWG) with end sleeves	
Bus interface		
Motor temperature sensor	1 input, sensors that can be connected: PTC, KTY, bimetal or Pt1000	1 input, sensors that can be connected: PTC, KTY, bimetal or Pt1000
Control of a mechanical motor brake	✓	✓
Slot for SINAMICS SD memory card	✓	✓
Commissioning interface		
• PROFINET	–	✓
• Mini-USB	✓	✓
Safety functions		
Integrated safety functions acc. to IEC 61508 SIL 2 and ISO 13849-1 PL d and Category 3	Safe Torque Off (STO) and Safely-Limited Speed (SLS – via Safety Extended license from firmware V4.7 SP14 in conjunction with SINAMICS Startdrive from V18 SP1)	
• F-DI	✓	✓
• PROFIsafe	–	✓ (not with EtherNet/IP)
Open-loop/closed-loop control methods		
V/f linear/quadratic/parameterizable	✓	
V/f with flux current control (FCC)	✓	
Vector control, sensorless	✓	
Torque control, sensorless	✓	

SINAMICS G115D distributed drive system • Wall-mounted

0.37 kW to 7.5 kW (0.5 to 10 hp)

SINAMICS G115D distributed converters wall-mounted

Technical specifications

Converter	AS-Interface	PROFINET, EtherNet/IP
6SL352 . . . X . . . -	. AA0	. AF0
Software functions		
Fixed frequencies	✓	
Signal interconnection with BICO technology	✓	
Automatic restart after line supply failure or operating fault	✓	
Slip compensation	✓	
Free function blocks (FFB) for logical and arithmetic operations	✓	
Ramp smoothing	✓	
4 selectable drive data sets	✓	
4 selectable command data sets (CDS) (manual/auto)	✓	
Flying restart	✓	
JOG	✓	
Cyclic recording of ramp-up and ramp-down	✓	✓
Technology controller (PID)	✓	
Conveyor technology functions	✓	✓
Thermal motor protection	✓	
Thermal converter protection	✓	
Setpoint input	✓	
Motor identification	✓	
Motor holding brake	✓	
Mechanical specifications and ambient conditions		
Degree of protection	IP65/IP66/UL type 4X	
Operating temperature	-30 ... +40 °C (-22 ... 104 °F) without derating >40 ... 55 °C (104 ... 131 °F) see derating characteristics	
Storage temperature	-40 ... +70 °C (-40 ... 158 °F)	
Relative air humidity	<95 % condensation, icing and salt mist not permissible	

SINAMICS G115D distributed drive system • Wall-mounted

0.37 kW to 7.5 kW (0.5 to 10 hp)

SINAMICS G115D distributed converters wall-mounted

Technical specifications

Line voltage 380 ... 480 V 3 AC 6SL352 . -		SINAMICS G115D distributed converters				
		. X . . 0-3A . 0	. X . . 0-5A . 0	. X . . 0-7A . 0	. X . . 1-1A . 0	. X . . 1-5A . 0
Rated output current $I_N^{1)}$	A	1.3	1.7	2.2	3.1	4.1
Maximum output current I_{max}	A	2.6	3.4	4.4	6.2	8.2
Rated power	kW	0.37	0.55	0.75	1.1	1.5
Rated pulse frequency	kHz	4	4	4	4	4
Efficiency η according to IEC 61800-9-2		94.60	95.40	96.23	96.67	96.87
Power loss ²⁾ according to IEC 61800-9-2 at rated output current	kW	0.034	0.038	0.043	0.054	0.067
Internal braking resistor						
• Continuous braking power P_{DB} (ambient temperature ≤ 40 °C (104 °F))	W	10	10	10	10	10
• Peak power P_{max} (cycle time 12 s within 120 s (corresponds to 10 % on-load factor)) (ambient temperature ≤ 40 °C (104 °F))	W	100	100	100	100	100
Rated input current ³⁾	A	1.23	1.58	1.99	2.69	3.48
Line supply connection U1/L1, V1/L2, W1/L3, PE						
• Conductor cross-section	mm ²	1.5 ... 6 14 ... 9 AWG	1.5 ... 6 14 ... 9 AWG	1.5 ... 6 14 ... 9 AWG	1.5 ... 6 14 ... 9 AWG	1.5 ... 6 14 ... 9 AWG
PE connection (external connection)						
• Conductor cross-section (recommended)	mm ²	10	10	10	10	10
Motor connection						
• Conductor cross-section						
- U2, V2, W2, PE	mm ²	2.5 ... 4 13 ... 12 AWG	2.5 ... 4 13 ... 12 AWG	2.5 ... 4 13 ... 12 AWG	2.5 ... 4 13 ... 12 AWG	2.5 ... 4 13 ... 12 AWG
- Motor brake	mm ²	0.75 ... 4 18 ... 12 AWG	0.75 ... 4 18 ... 12 AWG	0.75 ... 4 18 ... 12 AWG	0.75 ... 4 18 ... 12 AWG	0.75 ... 4 18 ... 12 AWG
- Temperature sensor	mm ²	0.75 ... 1.5 18 ... 16 AWG	0.75 ... 1.5 18 ... 16 AWG	0.75 ... 1.5 18 ... 16 AWG	0.75 ... 1.5 18 ... 16 AWG	0.75 ... 1.5 18 ... 16 AWG
Degree of protection		IP65/IP66/UL type 4X	IP65/IP66/UL type 4X	IP65/IP66/UL type 4X	IP65/IP66/UL type 4X	IP65/IP66/UL type 4X
Frame size		FSA	FSA	FSA	FSA	FSA
Dimensions						
• Width	mm (in)	380 (14.96)	380 (14.96)	380 (14.96)	380 (14.96)	380 (14.96)
• Height ⁴⁾	mm (in)	156 (6.14)	156 (6.14)	156 (6.14)	156 (6.14)	156 (6.14)
• Depth	mm (in)	129 (5.08)	129 (5.08)	129 (5.08)	129 (5.08)	129 (5.08)
Weight, approx. The exact weights can be found in the data sheet resulting from the configuration on the Siemens Product Configurator.	kg (lb)	6.8 (14.99)	6.8 (14.99)	6.8 (14.99)	6.8 (14.99)	6.8 (14.99)

¹⁾ The rated output current I_N is based on the duty cycle for high overload (HO).

²⁾ Typical values. More information can be found on the internet at <https://support.industry.siemens.com/cs/document/94059311>

³⁾ The input current depends on the motor load and line impedance. The input currents apply for load at rated power for a line impedance corresponding to $u_k = 4\%$.

⁴⁾ The height values are valid without taking into account the connection. Depending on the connection type, the additional height is:

- For version with cable gland: 30 mm (1.18 in)
- For version with cable gland and motor connection Q8/0: 42 mm (1.65 in)
- For version with plug-in connection: 30 mm (1.18 in)
- For version with 24 V DC power supply: 60 mm (2.3 in)

The version with cable gland has no cable gland in the delivery state. The dimensions with cable gland apply to the converter with cable gland equipped with the optionally available installation kit for SINAMICS G115D wall-mounted.

SINAMICS G115D distributed drive system • Wall-mounted

0.37 kW to 7.5 kW (0.5 to 10 hp)

SINAMICS G115D distributed converters wall-mounted

Technical specifications

Line voltage 380 ... 480 V 3 AC 6SL352 . -		SINAMICS G115D distributed converters				
		. X . . 2-2A . 0	. X . . 3-0A . 0	. X . . 4-0A . 0	. X . . 5-5A . 0	. X . . 7-5A . 0
Rated output current I_N ¹⁾	A	5.9	7.7	10.2	13.2	19
Maximum output current I_{max}	A	11.8	15.4	20.4	26.4	38
Rated power	kW	2.2	3	4	5.5	7.5
Rated pulse frequency	kHz	4	4	4	4	4
Efficiency η according to IEC 61800-9-2		96.87	96.85	96.74	97.68	97.69
Power loss ²⁾ according to IEC 61800-9-2 at rated output current	kW	0.096	0.126	0.173	0.171	0.246
Internal braking resistor						
• Continuous braking power P_{DB} (ambient temperature ≤ 40 °C (104 °F))	W	10	10	10	20	20
• Peak power P_{max} (cycle time 12 s within 120 s (cor- responds to 10 % on-load factor)) (ambient temperature ≤ 40 °C (104 °F))	W	100	100	100	200	200
Rated input current ³⁾	A	5.18	6.76	8.95	11.88	17.11
Line supply connection U1/L1, V1/L2, W1/L3, PE						
• Conductor cross-section	mm ²	2.5 ... 6 13 ... 9 AWG	2.5 ... 6 13 ... 9 AWG	2.5 ... 6 13 ... 9 AWG	4 ... 6 11 ... 9 AWG	4 ... 6 11 ... 9 AWG
PE connection (external connection)						
• Conductor cross-section (recom- mended)	mm ²	10	10	10	10	10
Motor connection						
• Conductor cross-section						
- U2, V2, W2, PE	mm ²	2.5 ... 4 13 ... 12 AWG	2.5 ... 4 13 ... 12 AWG	2.5 ... 4 13 ... 12 AWG	4 12 AWG	4 12 AWG
- Motor brake	mm ²	0.75 ... 4 18 ... 12 AWG	0.75 ... 4 18 ... 12 AWG	0.75 ... 4 18 ... 12 AWG	0.75 ... 4 18 ... 12 AWG	0.75 ... 4 18 ... 12 AWG
- Temperature sensor	mm ²	0.75 ... 1.5 18 ... 16 AWG	0.75 ... 1.5 18 ... 16 AWG	0.75 ... 1.5 18 ... 16 AWG	0.75 ... 1.5 18 ... 16 AWG	0.75 ... 1.5 18 ... 16 AWG
Degree of protection		IP65/IP66/UL type 4X	IP65/IP66/UL type 4X	IP65/IP66/UL type 4X	IP65/IP66/UL type 4X	IP65/IP66/UL type 4X
Frame size		FSB	FSB	FSB	FSC	FSC
Dimensions						
• Width	mm (in)	425 (16.73)	425 (16.73)	425 (16.73)	425 (16.73)	425 (16.73)
• Height ⁴⁾	mm (in)	180 (7.09)	180 (7.09)	180 (7.09)	180 (7.09)	180 (7.09)
• Depth	mm (in)	134 (5.28)	134 (5.28)	169 (6.65)	169 (6.65)	169 (6.65)
Weight, approx. The exact weights can be found in the data sheet resulting from the configuration on the Siemens Product Configurator.	kg (lb)	8.4 (18.52)	8.4 (18.52)	8.8 (19.40)	9.1 (20.07)	9.1 (20.07)

¹⁾ The rated output current I_N is based on the duty cycle for high overload (HO).

²⁾ Typical values. More information can be found on the internet at <https://support.industry.siemens.com/cs/document/94059311>

³⁾ The input current depends on the motor load and line impedance. The input currents apply for load at rated power for a line impedance corresponding to $u_K = 4\%$.

⁴⁾ The height values are valid without taking into account the connection. Depending on the connection type, the additional height is:
- For version with cable gland: 30 mm (1.18 in)
- For version with cable gland and motor connection Q8/0: 42 mm (1.65 in)
- For version with plug-in connection: 30 mm (1.18 in)
- For version with 24 V DC power supply: 60 mm (2.3 in)
The version with cable gland has no cable gland in the delivery state. The dimensions with cable gland apply to the converter with cable gland equipped with the optionally available installation kit for SINAMICS G115D wall-mounted.

SINAMICS G115D distributed drive system • Wall-mounted

0.37 kW to 7.5 kW (0.5 to 10 hp)

SINAMICS G115D distributed converters wall-mounted

Characteristic curves

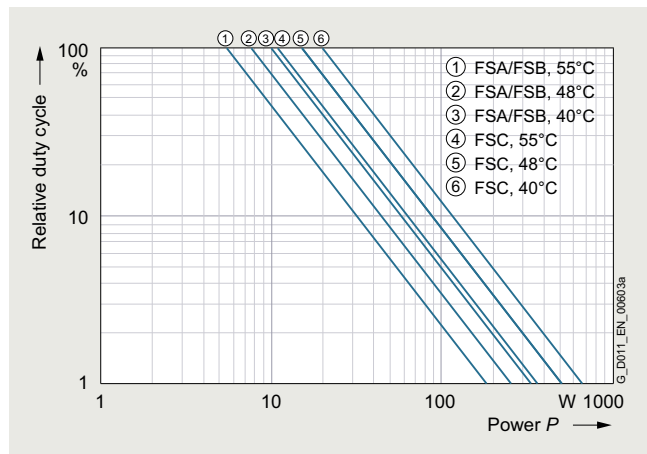

SINAMICS G115D, internal braking resistor, relative duty cycle in relation to a cycle of 120 s

Derating data

Pulse frequency

Rated power at 400 V 3 AC		Rated output current in A for a pulse frequency of						
kW	hp	4 kHz	6 kHz	8 kHz	10 kHz	12 kHz	14 kHz	16 kHz
0.37	0.5	1.3	1.11	0.91	0.78	0.65	0.59	0.52
0.55	0.75	1.7	1.45	1.19	1.02	0.85	0.77	0.68
0.75	1	2.2	1.87	1.54	1.32	1.1	0.99	0.88
1.1	1.5	3.1	2.64	2.17	1.86	1.55	1.4	1.24
1.5	2	4.1	3.49	2.87	2.46	2.05	1.85	1.64
2.2	3	5.9	5.02	4.13	3.54	2.95	2.66	2.36
3	4	7.7	6.55	5.39	4.62	3.85	3.47	3.08
4	5	10.2	8.67	7.14	6.12	5.1	4.59	4.08
5.5	7.5	13.2	11.22	9.24	7.92	6.6	5.94	5.28
7.5	10	19	16.15	13.3	11.4	9.5	8.55	7.6

Ambient temperature

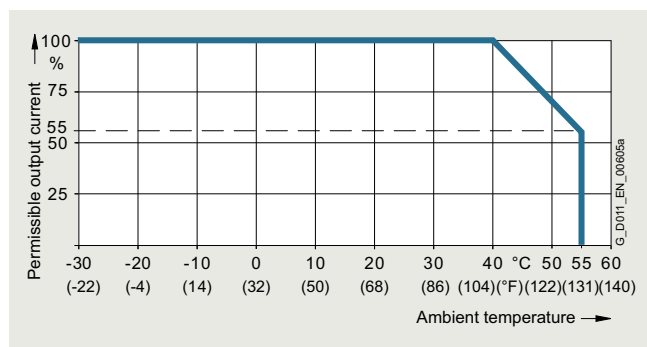

Permissible output current as a function of the ambient temperature

Installation altitude

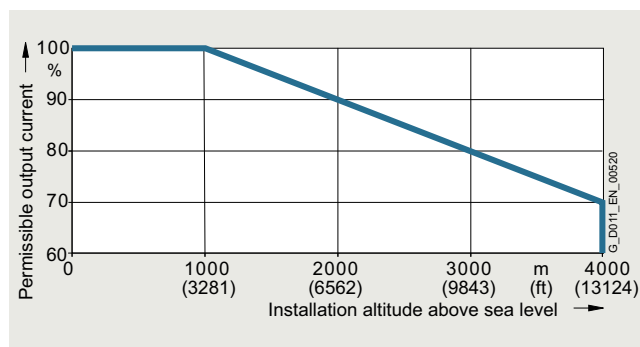

Permissible output current as a function of the installation altitude

No derating necessary at the permissible input voltage depending on the installation altitude.

SINAMICS G115D distributed drive system • Wall-mounted

0.37 kW to 7.5 kW (0.5 to 10 hp)

SINAMICS G115D distributed converters wall-mounted

Dimensional drawings

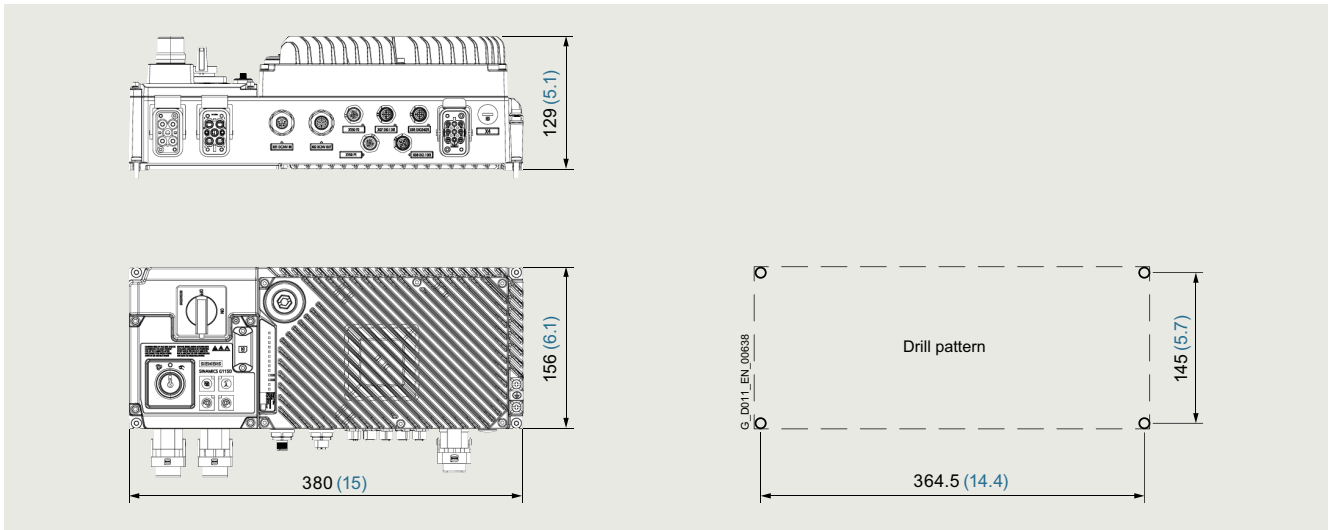

SINAMICS G115D frame size FSA, without fan

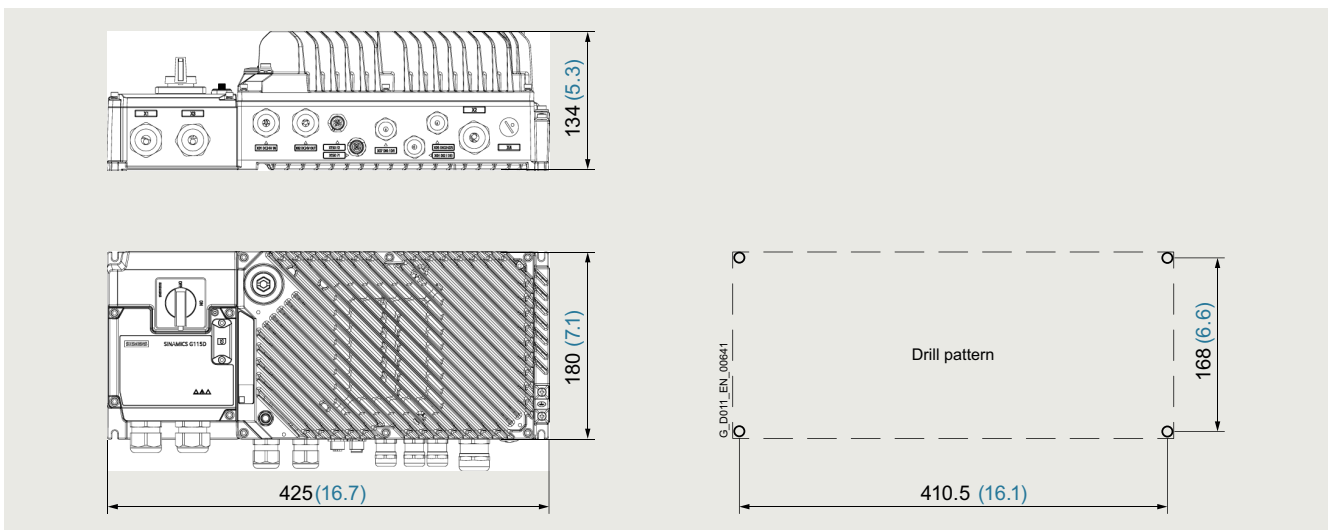

SINAMICS G115D frame size FSB, without fan, rated power 2.2 kW and 3 kW

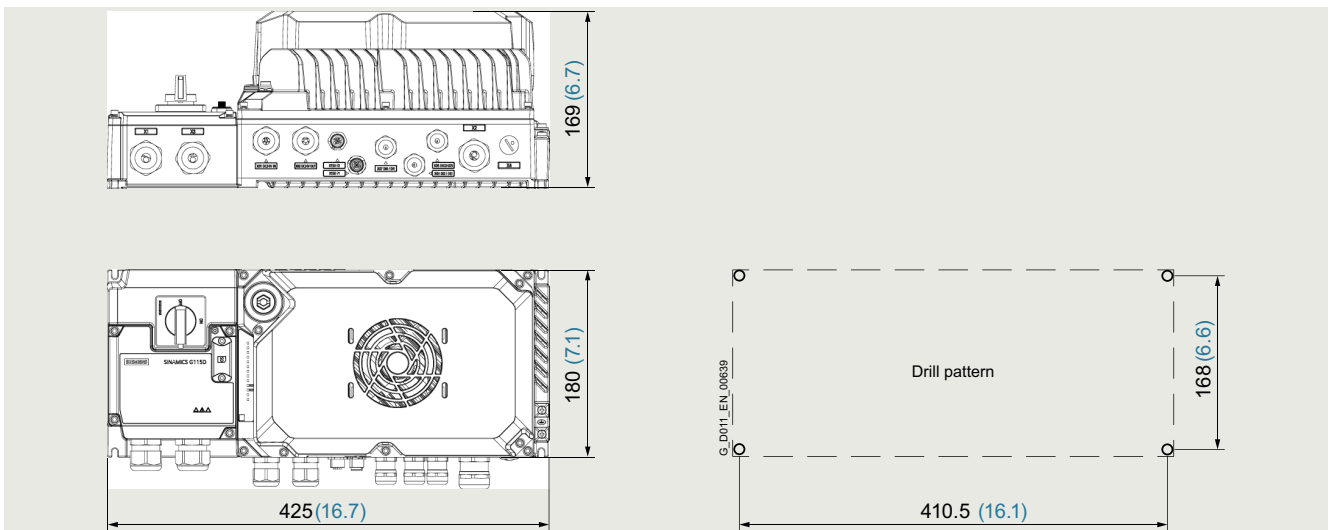

SINAMICS G115D frame size FSB, with fan, rated power 4 kW

SINAMICS G115D distributed drive system • Wall-mounted

0.37 kW to 7.5 kW (0.5 to 10 hp)

SINAMICS G115D distributed converters wall-mounted

Dimensional drawings

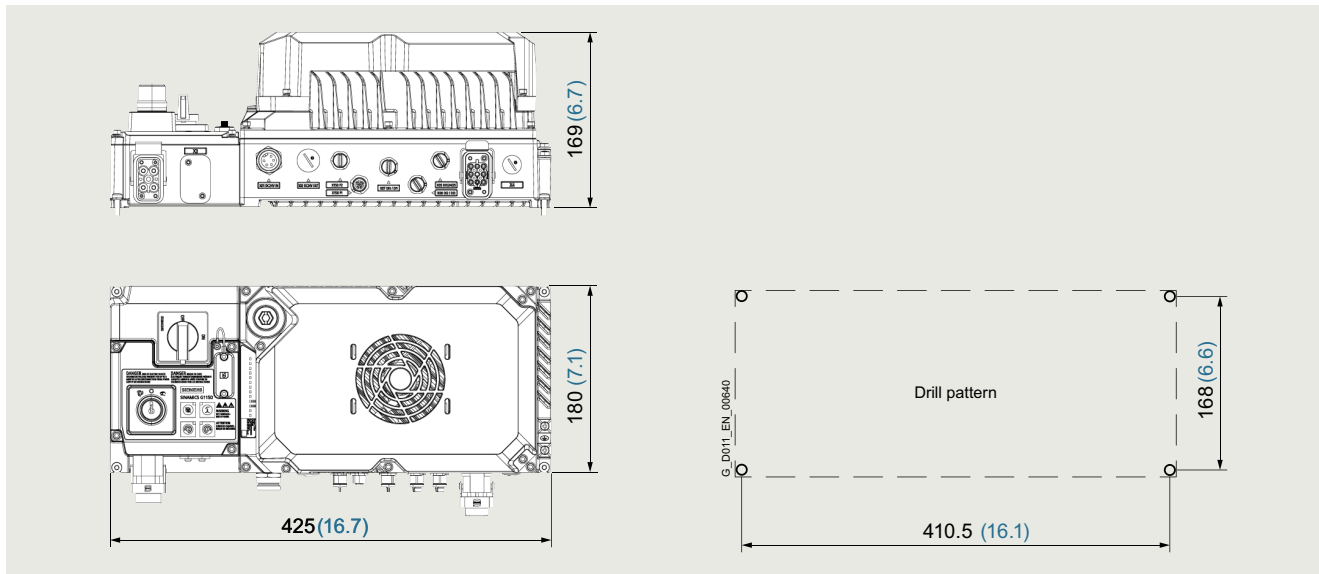

SINAMICS G115D frame size FSC, with fan

The height values are valid without taking into account the connection. Depending on the connection type, the additional height is:

- For version with cable gland: 30 mm (1.18 in)
- For version with cable gland and motor connection Q8/0: 42 mm (1.65 in)
- For version with plug-in connection: 30 mm (1.18 in)
- For version with 24 V DC power supply: 60 mm (2.36 in)

The version with cable gland has no cable gland in the delivery state. The dimensions with cable gland apply to the converter with cable gland equipped with the optionally available installation kit for SINAMICS G115D wall-mounted.

Mounted with 4 M5 bolts, 4 M5 nuts, 4 M5 washers.

Ventilation clearance required (for wall mounting) at the drive end of the converter: 200 mm (7.9 in).

Ventilation clearance required (for wall mounting) at the non-drive end of the converter: 150 mm (5.9 in).

All dimensions in mm (values in brackets are in inches).

More information

Identification link according to IEC 61406 for SINAMICS G115D

The ID link contains the article and serial number of the product. As a QR code, it replaces the previous data matrix code on the nameplate and takes you with the URL directly to a product information page on the internet with access to the technical documentation, data sheet, certificates, FAQs, product notifications, and catalogs. Paper package inserts become mostly superfluous since the information is available electronically directly via the QR code, even years later. In this way, we are making a valuable contribution to the preservation of our environment. You don't need an additional app. Simply scan the QR code with your smartphone or tablet. According to IEC 61406, the QR code of an ID link is marked with a frame and a triangle at the bottom right.

With their globally unique identifiers, Siemens products are ready for Industry 4.0.

The ID serves as a connection to the administration shell with which modules of the digital twin can be provided.

The latest technical documentation (catalogs, dimensional drawings, certificates, manuals and operating instructions) as well as further technical specifications are available on the internet at:

www.siemens.com/sinamics-g115d/documentation

and in the Siemens Product Configurator:

www.siemens.com/sinamics-g115d/configuration

Environmental Product Declaration (EPD)

Environmental Product Declarations (EPD) are available as PDFs for this product.

The EPD PDF provides brief and concise information about the ecological properties of a product.

You can find more information on the internet at:

<https://support.industry.siemens.com/cs/ww/en/ps/27867/cert?ci=5690>



7.3/2 Line-side components
7.3/2 Recommended line-side components

7.3/3 DC link components
7.3/3 External braking resistors

7.3/5 Supplementary system components

- 7.3/5 Memory cards
- 7.3/7 SINAMICS G120 Smart Access
- 7.3/8 Interface kit for SINAMICS G120 Smart Access
- 7.3/8 PC converter connection kit 2

7.3/8 Installation kit for SINAMICS G115D wall-mounted

7.3/9 Cover kit

7.3/10 Connection cables

7.3/12 Spare parts

7.3/12 Electronic Modules

7.3/12 Spare parts kits for SINAMICS G115D wall-mounted

7.3/12 Replacement fans for SINAMICS G115D wall-mounted

SINAMICS G115D distributed drive system • Supplementary components

[Clicking to SiePortal](#)

Line-side components

6SL3255-0AA00-5AA0



Recommended line-side power components

Selection and ordering data

The following table lists recommendations for additional line-side components such as fuses.

Note for use according to IEC standards:

3NA3 fuses are recommended for European countries. The values in the table take into account the overload capability of the converter.

Note for use according to UL regulations:

Fuses for use in North America must be UL-certified, Class CC, G, J, CF or T (JDDZ7) fuses with a rated voltage of 480 V AC.

Short Circuit Current Rating (SCCR)

according to UL

Applies to industrial control cabinet installations according to NEC Article 409 or UL 508A.

- SINAMICS G115D: 65 kA

Recommendations on further overcurrent protection devices are available at:

<https://support.industry.siemens.com/cs/document/109784481>

More information about the listed fuses is available in Catalog LV 10 as well as in SiePortal.

SINAMICS G115D	IEC-compliant		UL/CSA-compliant	
	Fuse		Fuse type	
Frame size	Current	Article No.	Rated voltage 480 V AC	Current
Converter	A		Class	A
380 ... 480 V 3 AC				
FSA	10	3NA3803	CC, G, J, CF, T (JDDZ7)	10
FSB	16	3NA3805	CC, G, J, CF, T (JDDZ7)	15
FSC	32	3NA3812	CC, G, J, CF, T (JDDZ7)	35
Group protection	32	3NA3812	CC, G, J, CF, T (JDDZ7)	35

6SL3255-0AA00-5AA0



Overview

Regenerative energy is converted to heat via the internal braking resistor integrated as standard. Optional external braking resistors are available for higher regenerative energy.

Selection and ordering data

Description	Suitable for SINAMICS G115D Converter frame size	Continuous braking power P_{DB} W	Article No.
External braking resistor	FSA	200	6SL3501-1BE32-0AA0
		240	6SL3501-1BE32-4AA0
		480	6SL3501-1BE34-8AA0
	FSB	200	6SL3501-1BE32-0BA0
		240	6SL3501-1BE32-4BA0
		600	6SL3501-1BE36-0BA0
	FSC	600	6SL3501-1BE36-0CA0
		1200	6SL3501-1BE41-2CA0

Technical specifications

Line voltage 380 ... 480 V 3 AC 6SL3501-	External braking resistor			
		1BE32-0AA0	1BE32-4AA0	1BE34-8AA0
Resistance	Ω	210	220	200
Continuous braking power P_{DB}	W	200	240	480
Peak power P_{max} (load duration $t_a = 12$ s with period $t = 120$ s)	W	1200	1440	2880
Degree of protection		IP65	IP65	IP65
Dimensions				
• Length	mm (in)	320 (12.60)	320 (12.60)	245 (9.65)
• Width	mm (in)	106 (4.17)	106 (4.17)	216 (8.50)
• Depth	mm (in)	64 (2.52)	64 (2.52)	96.5 (3.80)
Weight, approx.	kg (lb)	1.56 (3.44)	2.10 (4.63)	3.89 (8.58)
Suitable for SINAMICS G115D		6SL35...X..0-3A.0 6SL35...X..0-5A.0 6SL35...X..0-7A.0 6SL35...X..1-1A.0 6SL35...X..1-5A.0		
• Converter frame size		FSA		

Line voltage 380 ... 480 V 3 AC 6SL3501-	External braking resistor					
		1BE32-0BA0	1BE32-4BA0	1BE36-0BA0	1BE36-0CA0	1BE41-2CA0
Resistance	Ω	160	150	150	81	72
Continuous braking power P_{DB}	W	200	240	600	600	1200
Peak power P_{max} (load duration $t_a = 12$ s with period $t = 120$ s)	W	1200	1440	3600	3600	7200
Degree of protection		IP65	IP65	IP65	IP65	IP65
Dimensions						
• Length	mm (in)	320 (12.60)	320 (12.60)	245 (9.65)	245 (9.65)	245 (9.65)
• Width	mm (in)	106 (4.17)	106 (4.17)	227 (8.94)	227 (8.94)	349 (13.74)
• Depth	mm (in)	64 (2.52)	64 (2.52)	96.5 (3.80)	96.5 (3.80)	96.5 (3.80)
Weight, approx.	kg (lb)	1.56 (3.44)	2.10 (4.63)	3.42 (7.54)	3.42 (7.54)	5.47 (12.06)
Suitable for SINAMICS G115D		6SL35...X..2-2A.0 6SL35...X..3-0A.0 6SL35...X..4-0A.0			6SL35...X..5-5A.0 6SL35...X..7-5A.0	
• Converter frame size		FSB			FSC	

SINAMICS G115D distributed drive system • Supplementary components

DC link components

External braking resistors

Characteristic curves

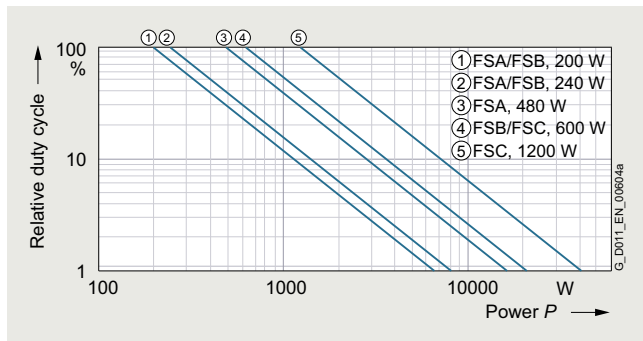

SINAMICS G115D, external braking resistor, relative duty cycle in relation to a cycle of 120 s (up to 55 °C)



Overview



SINAMICS SD memory card

The parameter settings of the converter and the firmware can be stored on the optional SINAMICS SD memory card. When service is required, the data are automatically downloaded from the memory card in the converter and the system is ready for use again without further interventions.

- Parameter settings can be written from the memory card to the converter or saved from the converter to the memory card.
- Up to 100 parameter sets can be stored.
- The memory card supports series commissioning without the use of the SINAMICS Startdrive commissioning tool.

Note:

The memory card is optional, but it facilitates converter replacement.

Selection and ordering data

Description	Article No.
SINAMICS SD card 512 MB	6SL3054-4AG00-2AA0
Optional firmware memory cards	
SINAMICS SD card 512 MB + firmware V4.7 SP14 (Multicard V4.7 SP14)	6SL3054-7TH00-2BA0
Optional memory cards with licenses	
SINAMICS SD card 512 MB + License Extended Functions Safety (SLS) ¹⁾	6SL3054-4AG00-2AA0-Z F01
SINAMICS SD card 512 MB + Firmware V4.7 SP14 + License Extended Functions Safety (SLS) (Multicard V4.7 SP14) + License ¹⁾	6SL3054-7TH00-2BA0-Z F01
License Extended Functions Safety (SLS) (without SD card) for upgrading license of an existing SD card ²⁾	6SL3074-0AA10-0AH0

More information on firmware V4.7 SP14:

<https://support.industry.siemens.com/cs/document/109817231>

For an overview and more information on all available firmware versions, see

<https://support.industry.siemens.com/cs/document/67364620>

¹⁾ The Certificate of License (CoL) is located on the SINAMICS SD card. In addition, notification of an optional download is received by email.

²⁾ With a CoL in electronic form, the license is supplied as a PDF file. Notification of this with a download link is received by email.

SINAMICS G115D distributed drive system • Supplementary components

Supplementary system components

Memory cards

More information

Certificate of License (CoL)

The CoL is the licensee's proof that the use of the software has been licensed by Siemens. A CoL must be assigned to each use and must be kept in a safe place.

Electronic Certificate of License

The electronic Certificate of License is the paperless delivery form for runtime options for SINAMICS and SINUMERIK.

Like the previous paper Certificate of License CoL, the electronic Certificate of License contains information about the type of rights of use purchased for the software. The electronic Certificate of License is supplied as a PDF file via the Online Software Delivery Portal (OSD). This enables quick notification

with a download link to the email address to be stated in the order.

The electronic Certificate of License can then be downloaded from the OSD. The Web License Manager can also be called from the OSD to assign the runtime license to a memory card. In this case, the data of the electronic Certificate of License are automatically transferred to the Web License Manager and do not have to be entered manually.

This ensures quick availability of the license key and simple and secure handling and management of the license certificates.

You will find information on the OSD at: <https://support.industry.siemens.com/cs/document/109759444>

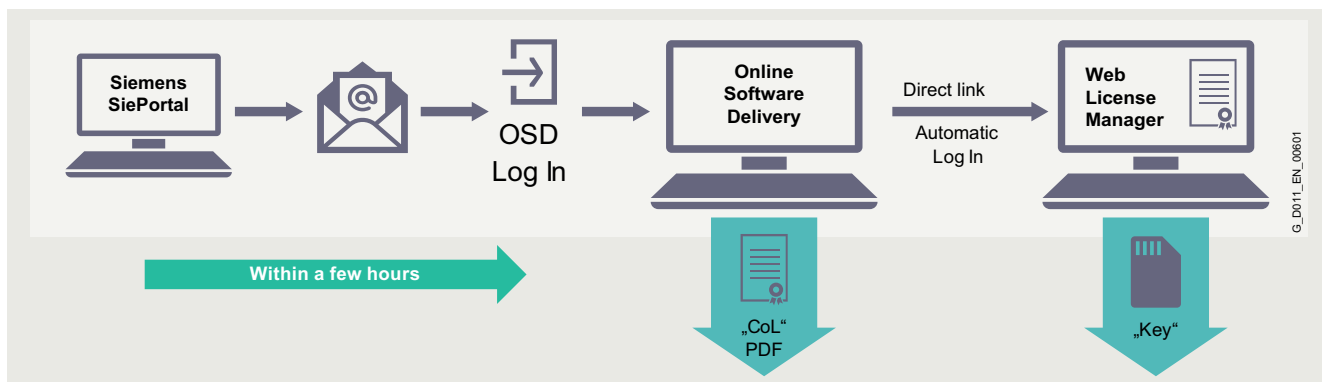

Electronic Certificate of License: Procedure for order licenses

In the future, the pre-licensed memory cards will also be delivered with the corresponding electronic Certificates of License on the memory card. The Certificates of License are stored in directory "KEYS". The pre-licensed memory cards will successively make the transition from paper CoLs to electronic CoLs. The CoL on paper will then no longer be contained in the delivery.

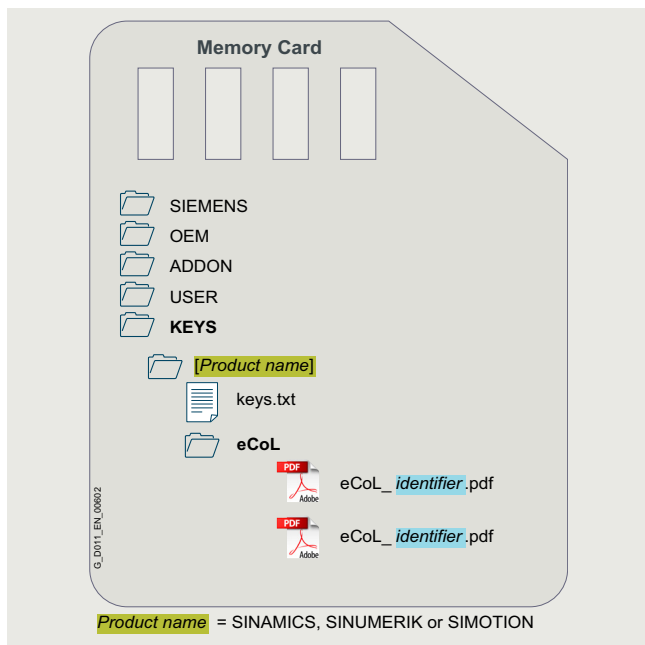

Electronic Certificate of License: Storage location on data medium

7
3

Clicking to SiePortal

6SL3255-0AA00-5AA0



SINAMICS G115D distributed drive system • Supplementary components

Supplementary system components

SINAMICS G120 Smart Access

Overview



SINAMICS G120 Smart Access

It is also easy and convenient to commission and operate the SINAMICS G115D, SINAMICS G120, SINAMICS G120C, SINAMICS G120P and SINAMICS G120X frequency converters of firmware V4.7 SP6 and higher using the web server module SINAMICS G120 Smart Access and a connected smartphone, tablet or laptop.

Benefits

- Wireless commissioning, operation and diagnostics via mobile device or laptop thanks to the optional SINAMICS G120 Smart Access
- Intuitive user interface and commissioning wizard
- Free choice of terminal devices as the web server works with all common web browsers, such as iOS, Android, Microsoft Windows, Linux and Mac OS

Function

- Commissioning using commissioning wizard
- Setting and saving parameters
- Testing motor in JOG mode
- Monitoring of converter data
- Quick diagnostics
- Saving the settings and restoring to factory settings

Integration

The optional SINAMICS G120 Smart Access is simply plugged onto the converter and is available for the following converters of firmware V4.7 SP6 and higher.

- SINAMICS G115D together with the interface kit for SINAMICS G120 Smart Access
- SINAMICS G120C
- SINAMICS G120 together with the CU230P-2 and CU240E-2 Control Units (without fail-safe versions)
- SINAMICS G120P together with the CU230P-2 Control Units
- SINAMICS G120X

Selection and ordering data

Description	Article No.
SINAMICS G120 Smart Access For wireless commissioning, operation and diagnostics of the following converters using a smartphone, tablet, or laptop <ul style="list-style-type: none"> • SINAMICS G115D together with the interface kit for SINAMICS G120 Smart Access • SINAMICS G120C • SINAMICS G120 together with the CU230P-2 and CU240E-2 Control Units (without fail-safe versions) • SINAMICS G120P together with the CU230P-2 Control Units • SINAMICS G120X 	6SL3255-0AA00-5AA0

Technical specifications

SINAMICS G120 Smart Access 6SL3255-0AA00-5AA0	
Operating system	iOS, Android, Microsoft Windows, Linux, Mac OS
Languages	Support of six languages: English, French, German, Italian, Spanish, Chinese
Ambient temperature	<ul style="list-style-type: none"> • During storage and transport -40 ... +70 °C (-40 ... +158 °F) • During operation 0 ... 50 °C (32 ... 122 °F) if the Smart Access is plugged directly into the converter
Air humidity	< 95 %, non-condensing
Degree of protection	Depending on the degree of protection of the converter, max. IP55/UL Type 12 enclosure
Dimensions	<ul style="list-style-type: none"> • Width 70 mm (2.76 in) • Height 108.9 mm (4.29 in) • Depth 17.3 mm (0.68 in)
Weight, approx.	0.08 kg (0.18 lb)
Compliance with standards	CE, UKCA, FCC, SRRC, WPC, ANATEL, BTK

SINAMICS G115D distributed drive system • Supplementary components

[Clicking to SiePortal](#)

Supplementary system components

[6SL3255-0AA00-5AA0](#)

Interface kit for SINAMICS G120 Smart Access

Overview

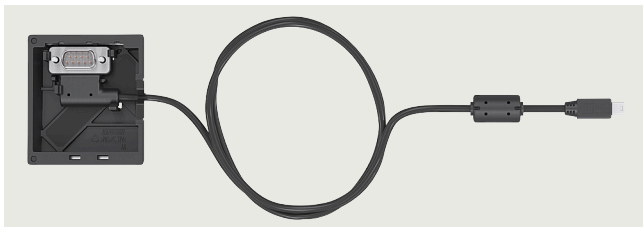

Interface kit with SINAMICS G120 Smart Access for connection with SINAMICS G115D converter



SINAMICS G120 Smart Access with interface kit for connection with SINAMICS G115D converter

With the interface kit, the SINAMICS G120 Smart Access web server module can be connected to the SINAMICS G115D converter.

The scope of delivery includes the Interface Module with a connection cable.

For easy mounting, the interface kit can be plugged directly onto the SINAMICS G115D converter using the rubber mount on the back.

Alternatively, the interface kit can be affixed with the magnetic sides on a metallic surface.

Selection and ordering data

Description	Article No.
Interface kit for SINAMICS G120 Smart Access	6SL3555-0XA00-0AA0

Technical specifications

Interface kit for SINAMICS G120 Smart Access 6SL3555-0XA00-0AA0	
Ambient temperature • During operation	-10 ... +60 °C (14 ... +140 °F)
Air humidity	< 95 %, non-condensing
Dimensions	
• Width	70 mm (2.76 in)
• Height	62.5 mm (2.46 in)
• Depth	40 mm (1.57 in)
• Length of the connection cable	1 m (3.28 ft)
Weight, approx.	0.19 kg (0.42 lb)

PC converter connection kit 2

Overview



PC converter connection kit 2

For controlling and commissioning a converter directly from a PC if a commissioning tool (e.g. SINAMICS Startdrive) has been installed on the PC. With this, the converter can be

- parameterized (commissioning, optimization)
- monitored (diagnostics)
- controlled (master control via the commissioning tool for test purposes)

A USB cable (3 m/9.84 ft) is included in the scope of delivery.

The PC converter connection kit 2 is compatible with the following Control Units and converters (all communication methods):

- SINAMICS G120C
- SINAMICS G120 Control Units
 - CU230P-2
 - CU240E-2
 - CU250S-2
- SINAMICS G115D
- SINAMICS G120D Control Units
 - CU240D-2
 - CU250D-2

Selection and ordering data

Description	Article No.
PC converter connection kit 2 USB cable (3 m/9.84 ft long) for	6SL3255-0AA00-2CA0
• SINAMICS G120C	
• SINAMICS G120 Control Units	
- CU230P-2	
- CU240E-2	
- CU250S-2	
• SINAMICS G115D	
• SINAMICS G120D Control Units	
- CU240D-2	
- CU250D-2	

Clicking to SiePortal

6SL3255-0AA00-5AA0



SINAMICS G115D distributed drive system • Supplementary components

Supplementary system components

Installation kits for SINAMICS G115D wall-mounted

Overview

An installation kit with cable glands for the line supply (X1/X3), the motor (X2), the 24 V DC power supply (X01/X02) and the digital inputs/digital outputs (X07/X08/X05) can be ordered for the connection.

Selection and ordering data

Description	Article No.
Installation kit for SINAMICS G115D wall-mounted	6SL3566-2GW00-0GA0

Cover kit

Overview

The cover kit is used to protect the unused connector plugs for line supply, loop-through (X3) and 24 V DC loop-through (X02).

Selection and ordering data

Description	Article No.
Cover kit for outputs 380 ... 480 V AC (Q4/2) and 24 V DC (7/8* and M12)	6SL3566-2GA00-0GA0

Connecting cables

Overview

An overview of all available accessories (e.g. plugs and cables) can be found under the following link:

www.siemens.com/distributeddrives-supplementaryproducts

Connecting cables for communication**PROFINET connecting cables**

Flexible plug-in cables and plug-in connectors that can be assembled in the field for transmission of data (up to 100 Mbps) between Industrial Ethernet stations.

Description	Article No.
IE connecting cable M12-180/M12-180 axial outlet Pre-assembled IE FC TP trailing cable GP 2 x 2 PROFINET type C with two 4-pole M12 plugs (4-pole, D-coded), IP65/IP67 degree of protection, UL, plug/plug connector (IN/OUT) Length: <ul style="list-style-type: none"> • 0.3 m (0.98 ft) • 0.5 m (1.64 ft) • 1 m (3.28 ft) • 1.5 m (4.92 ft) • 2 m (6.56 ft) • 3 m (9.84 ft) • 5 m (16.4 ft) • 10 m (32.8 ft) • 15 m (49 ft) 	6XV1870-8AE30 6XV1870-8AE50 6XV1870-8AH10 6XV1870-8AH15 6XV1870-8AH20 6XV1870-8AH30 6XV1870-8AH50 6XV1870-8AN10 6XV1870-8AN15
IE connecting cable M12-180/IE FC RJ45 plug 145 axial outlet Pre-assembled IE FC TP trailing cable GP 2 x 2 (PROFINET type C) with M12 plugs (D-coded) and IE FC RJ45 plug, IP65/IP67 degree of protection Length: <ul style="list-style-type: none"> • 2 m (6.56 ft) • 3 m (9.84 ft) • 5 m (16.4 ft) • 10 m (32.8 ft) • 15 m (49 ft) 	6XV1871-5TH20 6XV1871-5TH30 6XV1871-5TH50 6XV1871-5TN10 6XV1871-5TN15
IE M12 Plug PRO axial outlet For assembly in the field, M12 plug-in connector (D-coded), metal enclosure, UL, fast connection method, plug connector <ul style="list-style-type: none"> • 1 unit • 8 units 	6GK1901-0DB20-6AA0 6GK1901-0DB20-6AA8
AS-Interface connecting cable	
Description	Article No.
AS-Interface M12 branch To connect the AS-Interface and the U _{Aux} cable to an M12 socket, UL	3RK1901-2NR20

Connecting cables/plug-in connectors for 24 V DC power supply

Description	Article No.
7/8" plug-in cable axial outlet For 24 V switched and unswitched, pre-assembled with 2 x 7/8" at both ends (axial), 5 x 1.5 mm ² , 5-pole plug/socket connectors Length: <ul style="list-style-type: none"> • 0.3 m (0.98 ft) • 0.5 m (1.64 ft) • 1 m (3.28 ft) • 1.5 m (4.92 ft) • 2 m (6.56 ft) • 3 m (9.84 ft) • 5 m (16.4 ft) • 10 m (32.8 ft) • 15 m (49 ft) 	6XV1822-5BE30 6XV1822-5BE50 6XV1822-5BH10 6XV1822-5BH15 6XV1822-5BH20 6XV1822-5BH30 6XV1822-5BH50 6XV1822-5BN10 6XV1822-5BN15
7/8" plug-in connector axial outlet 5-pole, B-coded, plastic enclosure, 1 package = 5 units <ul style="list-style-type: none"> • Pin insert (OUT) • Socket insert (IN) 	6GK1905-0FA00 6GK1905-0FB00

Plug-in connectors for digital inputs and outputs

Description	Article No.
M12 plug Y cable for distributed I/Os for dual connection of I/Os using single 5-pole M12 cables, 200 mm (7.87 in) <ul style="list-style-type: none"> • Straight 	6ES7194-6KA00-0XA0

Connecting cables for line supply, power loop-through and power bus distribution**Connecting cables pre-assembled at one end and connector sets to connect to the line supply**

Description	Article No.
Connecting cable pre-assembled at one end Power supply cable, open at one end, for Q4/2, angled, 4 x 4 mm ² <ul style="list-style-type: none"> • 1.5 m (4.92 ft) long • 5 m (16.4 ft) long 	3RK1911-0DB13 3RK1911-0DB33
Connector set for the power supply Socket insert Q4/2, 5 socket contacts, grommet housing, angled outlet including screw connection <ul style="list-style-type: none"> • 2.5 mm² • 4 mm² • 6 mm² 	3RK1911-2BE50 3RK1911-2BE10 3RK1911-2BE30

Clicking to SiePortal

6SL3255-0AA00-5AA0



SINAMICS G115D distributed drive system • Supplementary components

Supplementary system components

Connecting cables

Overview

Quickon system plug connectors

Description	Article No.
Quickon system plug connectors for connections for 380 ... 480 V AC <ul style="list-style-type: none"> Quickon nut Quickon connector 	6SL3566-4NA00-0GA0 6SL3566-4MA00-0GA0

Connector insert for power loop-through

Description	Article No.
Connector set for power loop-through Pin insert HAN Q4/2, 4 contact pins, grommet housing, angled outlet including screw connection <ul style="list-style-type: none"> 2.5 mm² 4 mm² 	3RK1911-2BF50 3RK1911-2BF10

Power bus distribution 400 V in IP65 degree of protection

Not essential (daisy chaining within device); use is optional.

Description	Ordering (see Product Partner)
Power T clamp connector for 2.5 ... 6 mm² With attached 7-pole plug, socket insert, grommet housing, UL Seals for various cable cross-sections must be ordered separately	Ordered from and supplied by Harting
T clamp connector Completely pre-assembled	Ordered from and supplied by KnorrTec

SINAMICS G115D distributed drive system • Supplementary components

[Clicking to SiePortal](#)

Spare parts

6SL3255-0AA00-5AA0

Electronic Modules

Overview

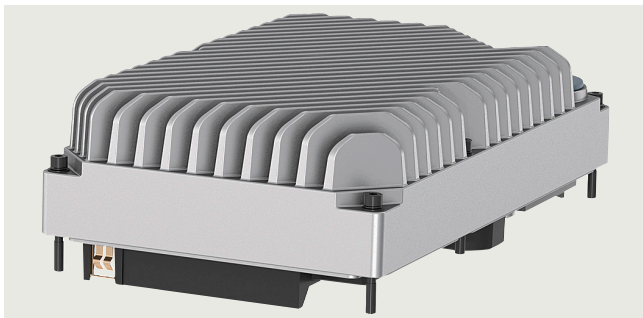

SINAMICS G115D Electronic Module

The Electronic Module must be replaced in case of a permanent malfunction.

For recommissioning, it is advantageous to save the converter settings on the optional SINAMICS SD card or via SINAMICS Startdrive or SINAMICS G120 Smart Access before the replacement.

The Electronic Modules for frame sizes FSB and FSC are supplied without fan. If required, the replacement fan must be ordered in addition.

Selection and ordering data

Description	Article No.
Electronic Modules	
• FSA, 0.37 kW	6SL3500-0XE50-3 ■ A0
• FSA, 0.55 kW	6SL3500-0XE50-5 ■ A0
• FSA, 0.75 kW	6SL3500-0XE50-7 ■ A0
• FSA, 1.1 kW	6SL3500-0XE51-1 ■ A0
• FSA, 1.5 kW	6SL3500-0XE51-5 ■ A0
• FSB, 2.2 kW	6SL3500-0XE52-2 ■ A0
• FSB, 3 kW	6SL3500-0XE53-0 ■ A0
• FSB, 4 kW	6SL3500-0XE54-0 ■ A0
• FSC, 5.5 kW	6SL3500-0XE55-5 ■ A0
• FSC, 7.5 kW	6SL3500-0XE57-5 ■ A0
Fieldbus communication	
• AS-Interface	↑
• Without fieldbus communication	A
• PROFINET, EtherNet/IP	B
	F

Spare parts kits for SINAMICS G115D wall-mounted

Overview

A spare parts kit comprising small parts such as replacement seals, cover caps and screws can be ordered.

Selection and ordering data

Description	Article No.
Spare parts kit for SINAMICS G115D wall-mounted comprising replacement seals, cover caps and screws	6SL3500-0XK51-0AA0

Replacement fans for SINAMICS G115D wall-mounted

Overview

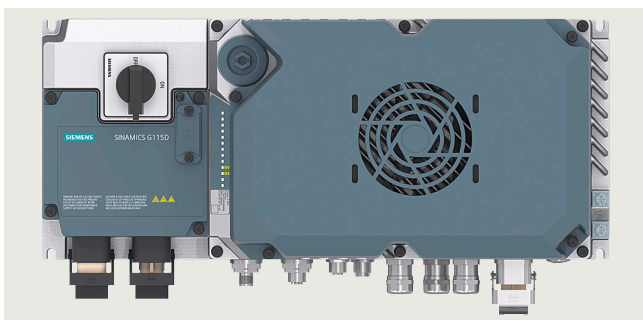

SINAMICS G115D with repair switch and fan

The fans are designed for an extra long service life. In case of exchange, a replacement fan consisting of a pre-mounted unit with cover, fan and screws can be ordered for SINAMICS G115D wall-mounted from 2.2 kW ¹⁾.

Selection and ordering data

Description	Article No.
Replacement fan (pre-mounted unit with cover, fan and screws) for SINAMICS G115D wall-mounted as from 2.2 kW ¹⁾ , frame sizes FSB and FSC	6SL3500-0XF51-0AA0

¹⁾ The replacement fan is required for 2.2 kW and 3 kW (frame size FSB) with hardware version up to and including 02. The replacement fan is not required as of hardware version 03 for 2.2 kW and 3 kW (frame size FSB). The hardware version of the converter can be found on the rating plate. More information and documentation can be found on the internet at: www.siemens.com/sinamics-g115d/documentation

SINAMICS G120D distributed converters

0.75 kW to 7.5 kW (1 hp to 10 hp)



8/2 Introduction

- 8/2 Application
- 8/2 More information

8/3 SINAMICS G120D distributed converters

- 8/3 Overview
- 8/5 Benefits
- 8/6 Design
- 8/7 Configuration
- 8/8 Technical specifications

8/9 CU240D-2 and CU250D-2 Control Units

- 8/9 Overview
- 8/10 Selection and ordering data
- 8/11 Design
- 8/13 Function
- 8/15 Integration
- 8/19 Technical specifications

8/22 PM250D Power Modules

- 8/22 Overview
- 8/22 Selection and ordering data
- 8/23 Integration
- 8/24 Technical specifications
- 8/27 Characteristic curves
- 8/28 Dimensional drawings

8/29 Recommended line-side power components

8/30 Supplementary system components

- 8/31 Intelligent Operator Panel
- IOP-2 Handheld
- 8/32 Memory cards
- 8/32 PC converter connection kit 2 (mini USB interface cable for communication with a PC)
- 8/32 STARTER commissioning tool
- 8/32 SINAMICS Startdrive commissioning tool
- 8/33 Connection cables for the Control Unit
- 8/33 PROFINET connecting cables
- 8/33 Connecting cables/connectors for supplying the Control Unit with 24 V DC power
- 8/34 Connecting cables and connectors for digital inputs and outputs
- 8/34 Connecting cables and connectors for encoders and analog inputs
- 8/34 Connecting cables for Power Modules
- 8/34 Connecting cables pre-assembled at one end and connector sets to connect to the line supply
- 8/35 Motor cables pre-assembled at one end and connector sets to connect the Power Module to the motor
- 8/35 Power bus distribution 400 V in IP65 degree of protection
- 8/35 More Information
- 8/36 **Spare parts**
- 8/36 Spare parts kit
- 8/36 Replacement fans

SINAMICS G120D distributed converters

0.75 kW to 7.5 kW (1 hp to 10 hp)

Introduction

Application

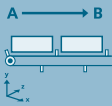
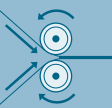
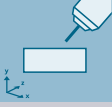
Use	Requirements for torque accuracy/speed accuracy/position accuracy/coordination of axes/functionality					
	Continuous motion			Non-continuous motion		
	Basic	Medium	High	Basic	Medium	High
Pumping, ventilating, compressing 	Centrifugal pumps Radial / axial fans Compressors	Centrifugal pumps Radial / axial fans Compressors	Eccentric screw pumps	Hydraulic pumps Metering pumps	Hydraulic pumps Metering pumps	Descaling pumps Hydraulic pumps
	V20 G120C G120X	G120X G130/G150 G180 ¹⁾ DCM	G220 S120	G120/G220	S110	S120
Moving 	Conveyor belts Roller conveyors Chain conveyors	Conveyor belts Roller conveyors Chain conveyors Lifting/lowering devices Elevators Escalators/moving walkways Indoor cranes Marine drives Cable railways	Elevators Container cranes Mining hoists Excavators for open-cast mining Test bays	Acceleration conveyors Storage and retrieval machines	Acceleration conveyors Storage and retrieval machines Cross cutters Reel changers	Storage and retrieval machines Robotics Pick & place Rotary indexing tables Cross cutters Roll feeds Engagers/disengagers
	V20 G115D G120C ET 200pro FC-2 ²⁾	G120/G220 G120D G130/G150 G180 ¹⁾	G220 S120 S150 DCM	V90 S200 G120/G220 G120D	S110 S210 DCM	S120 S210 DCM
Processing 	Mills Mixers Kneaders Crushers Agitators Centrifuges	Mills Mixers Kneaders Crushers Agitators Centrifuges Extruders Rotary furnaces	Extruders Winders/unwinders Lead/follower drives Calenders Main press drives Printing machines	Tubular bagging machines Single-axis motion control such as • Position profiles • Path profiles	Tubular bagging machines Single-axis motion control such as • Position profiles • Path profiles	Servo presses Rolling mill drives Multi-axis motion control such as • Multi-axis positioning • Cams • Interpolations
	V20 G120C	G120/G220 G130/G150 G180 ¹⁾	G220 S120 S150 DCM	V90 S200 G120/G220	S110 S210	S120 S210 DCM
Machining 	Main drives for • Turning • Milling • Drilling	Main drives for • Drilling • Sawing	Main drives for • Turning • Milling • Drilling • Gear cutting • Grinding	Axis drives for • Turning • Milling • Drilling	Axis drives for • Drilling • Sawing	Axis drives for • Turning • Milling • Drilling • Lasering • Gear cutting • Grinding • Nibbling and punching
	S110	S110 S120	S120	S110	S110 S120	S120

SINAMICS G120D is ideally suited for demanding conveyor system applications in the industrial environment for which a distributed drive with communications capability is required. This applies in particular to the automotive sector, e.g. for assembly lines.

SINAMICS G120D is also suitable for many additional high-performance applications, e.g. in the airport sector, the food and beverage industry (without surfactants) and in distribution logistics (e.g. electric monorail systems).

Practical application examples and descriptions are available on the internet at

www.siemens.com/sinamics-applications
www.siemens.com/conveyor-technology

More information

You may also be interested in these frequency converters:

- Horizontal distributed conveyor-related applications, degree of protection up to IP66 ⇒ SINAMICS G115D
- More performance for the control cabinet in IP20 degree of protection ⇒ SINAMICS G120, SINAMICS G120C
- With positioning function in the control cabinet in IP20 degree of protection ⇒ SINAMICS S110

¹⁾ Industry-specific converters.

²⁾ Information on the SIMATIC ET 200pro FC-2 frequency converter is available at:
www.siemens.com/et200pro-fc

SINAMICS G120D distributed converters

0.75 kW to 7.5 kW (1 hp to 10 hp)

SINAMICS G120D distributed converters

Overview

The SINAMICS G120D distributed converters are the solution for demanding drive tasks especially in the field of conveyor systems. SINAMICS G120D converters continuously control the speed of three-phase asynchronous (induction) motors and fulfill all the requirements of conveyor system applications from simple frequency control through to demanding vector control and positioning requirements. With its intelligent modular design with IP65 degree of protection, it can be seamlessly integrated into the plant or system and supports a high plant availability and low stocks of spare parts. The innovative power unit concept capable of energy recovery helps save energy. The patented implementation concept of the Safety Integrated Functions is unique worldwide and has been extended further, without the use of external components. This drive can be optimally integrated into the Siemens TIA world of automation via PROFINET / EtherNet/IP.

With different device versions (frame sizes FSA to FSC) in a power range from 0.75 kW to 7.5 kW, it is suitable for a wide variety of drive solutions.



Example: SINAMICS G120D, frame size FSA, comprising PM250D Power Module and fail-safe CU250D-2 PN-F Control Unit

Reasons for using distributed drive systems

- Modular drive solutions – therefore standardized mechatronic elements that can be individually tested
- A control cabinet is not required, resulting in a smaller space requirement and lower cooling requirements
- Long motor cables between converter and motor are not required
 - Less power losses
 - Reduced noise radiation
 - Reduced costs for shielded cables
 - No additional filters
- Distributed configurations offer considerable benefits for conveyor systems with their extensive coverage (e.g. in the automotive and logistics sectors)
- Perfectly prepared for digitalization thanks to different communication interfaces and integration via Industrial Edge or in the cloud, e.g. with the Drivetrain Analyzer application

Siemens family of distributed drives

Siemens offers an innovative portfolio of frequency converters to optimally implement distributed drive solutions. The strengths of the individual members of the drive family permit simple adaptation to the widest range of application demands:

- Identical connection systems
- User-friendly commissioning and configuration tools

Products from the family of distributed drives:

- SINAMICS G115D distributed frequency converters
- SINAMICS G120D frequency converters
- SIMATIC ET 200pro FC-2 frequency converters
- SIRIUS M200D motor starters

Modularity

SINAMICS G120D is a modular converter system with IP65 degree of protection comprising various function units. The main units are

- Control Unit (CU)
- Power Module (PM)

The Control Unit controls and monitors the Power Module and the connected motor using several different closed-loop control types that can be selected. The digital inputs, analog inputs and digital outputs on the device support the simple wiring of sensors and actuators directly at the drive. The input signals can either be directly linked within the Control Unit and initiate local responses independently or they can be transferred to the central control via PROFINET / EtherNet/IP for further processing within the context of the overall plant.

The Power Module supplies the motor in a power range from 0.75 kW to 7.5 kW. The Power Module is controlled by a micro-processor in the Control Unit. State-of-the-art IGBT technology with pulse-width-modulation is used for highly reliable and flexible motor operation. Comprehensive protection functions provide a high degree of protection for the Power Module and the motor. The unusually low profile mechanical design is optimized so that the device can be directly used in the plant or system. The Power Module also has the same drilling dimensions for all power ratings (standard footprint). Further, the dimensions are identical to those of SINAMICS G110D. This significantly simplifies the mechanical design, installation and retrofit of a system.

The latest technical documentation (catalogs, dimension drawings, certificates, manuals and operating instructions) is available on the internet at the following address:

www.siemens.com/sinamics-g120d/documentation

and offline in the Siemens Product Configurator:

www.siemens.com/spc

SINAMICS G120D distributed converters

0.75 kW to 7.5 kW (1 hp to 10 hp)

SINAMICS G120D distributed converters

Overview

Safety Integrated

The SINAMICS G120D distributed converters include versions for safety-oriented applications. All Power Modules are already designed for Safety Integrated.

The Safety Integrated function "Safe Torque Off" (STO) (certified according to IEC 61508 SIL 2, ISO 13849-1 PL d and Category 3) is already integrated into the standard version of the CU240D-2 series CU240D-2 PN. It can be activated either over PROFIsafe or over the safety input.

With the fail-safe variants of the CU240D-2 series (CU240D-2 PN-F xx) and with the entire CU250D-2 series, the fail-safe SINAMICS G120D converter provides five safety functions which are certified according to IEC 61508 SIL 2, ISO 13849-1 PL d and Category 3:

- Safe Torque Off (STO)
to protect against active movement of the drive
- Safe Stop 1 (SS1)
for continuous monitoring of a safe braking ramp
- Safely-Limited Speed (SLS)
for protection against dangerous movements on exceeding a speed limit
- Safe direction (SDI)
This function ensures that the drive can only rotate in the selected direction.
- Safe speed monitoring (SSM)
This function signals if a drive is operating below a specific speed/feed velocity.

These functions can be activated by means of PROFIsafe or via the safety inputs. A safety output is provided in addition.

All safety functions can be implemented without having to use a motor encoder; the implementation costs are minimal. Existing systems in particular can be simply updated with safety technology without the need to change the motor or mechanical system.

The Safe Torque Off (STO) function can be used without restriction for all applications. The SS1, SLS, SSM and SDI functions are only permissible for applications where the load can never accelerate when the converter is switched off. They are therefore not permitted for applications involving pull-through loads such as hoisting gear and unwinders.

Efficient Infeed Technology

The innovative Efficient Infeed Technology is employed in PM250D Power Modules. This technology allows the energy produced by motors operating in generator mode connected to standard converters to be fed back into the supply system. At the same time, considerable savings can be achieved in terms of energy consumption and operating costs.

STARTER commissioning tool

The STARTER commissioning tool (V4.3 and higher) supports the commissioning and maintenance of SINAMICS G120D converters. The operator guidance combined with comprehensive, user-friendly functions for the relevant drive solution allow you to commission the device quickly and easily.

SINAMICS Startdrive commissioning tool

SINAMICS Startdrive is a tool integrated into the TIA Portal for configuring, commissioning and diagnostics of the SINAMICS converter family. SINAMICS Startdrive can be used for implementing converter tasks with most of the SINAMICS G and SINAMICS S converter series.

Drive dimensioning of the SINAMICS G115D distributed drive system with the TIA Selection Tool

The SINAMICS G120D distributed drive system is easily configured with the TIA Selection Tool under the Drive Dimensioning plug-in. It provides support when selecting the hardware and firmware components necessary to implement a drive task. The plug-in encompasses the configuration of the entire drive system and allows the handling of individual drives.

SINAMICS G120D distributed converters

0.75 kW to 7.5 kW (1 hp to 10 hp)

SINAMICS G120D distributed converters

Benefits

- Mechanical design, installation and retrofit of systems are significantly simplified as a result of the compact and space-saving design with an extremely low profile and with the same drilling dimensions for all power ratings.
- Wide power range from 0.75 kW to 7.5 kW
- The safety functions make it easier to integrate drives into safety-oriented machines or plants
- The innovative circuit design (bidirectional input rectifier with "pared-down" DC link) allows the kinetic energy of a load to be fed back into the line supply system. This feedback capability provides enormous potential for energy saving because generated energy no longer has to be converted into heat in a braking resistor. Braking resistors and reactors are not necessary - this is a particular advantage in terms of the project engineering outlay, space requirement and installation costs for the high IP65 degree of protection
- Easy commissioning and maintenance via a fieldbus or point-to-point via a mini USB parameterization interface and screen-based parameterization software and wizards
- The same, standardized plug-in connections for the bus, power and I/O connections (ISO 23570) for the complete range of power ratings of SINAMICS G115D, SINAMICS G120D and SIRIUS M200D (motor starter)
- Integrated positioning functionality supports process-related implementation of positioning tasks with a high dynamic response. Positioning can be implemented with an incremental (HTL) or absolute encoder (SSI)
- Increased degree of ruggedness and longer service life as the electronic modules are coated
- Flexibility due to modularity for a future-oriented distributed drive concept with a high IP65 degree of protection
 - The modules can be easily replaced, which makes the system extremely service friendly.
- Simple, standard implementation of completely distributed plant and system concepts by using products in a scalable fashion:
 - SIRIUS M200D (motor starter)
 - SIMATIC ET 200pro FC-2 (converter for the distributed SIMATIC ET 200pro I/O system)
 - SINAMICS G115D distributed frequency converters
 - SINAMICS G120D (converter for demanding, conveyor-related applications)
- Communications-capable via PROFINET / EtherNet/IP with PROFINET profile 4.1:
 - PROFINET features:
 - Neighbor recognition (LLDP)
 - Ring topology possible (MRP (Media redundancy protocol), MRPD (media redundancy with planned duplication)
 - Isochronous real-time communication (IRT)
 - PROFINET energy
 - PROFINET safe
 - Diagnostics, interrupts
 - Shared Device
- Simple connection, engineering, data management as well as control of the converter in sophisticated plants and systems as a result of the consequential integration in TIA (Totally Integrated Automation)
- High degree of operator friendliness by using the Intelligent Operator Panel (IOP-2) to parameterize, diagnose, control (open-loop) and copy drive parameters
- The ability to connect up to 6 sensors and up to 2 actuators to the Control Unit directly ensures that almost all the information relevant to the drive can be managed directly. Fail-safe Control Units can process signals from up to three fail-safe sensors and one fail-safe actuator. The CU240D-2 Control Units are also equipped with two analog inputs, which can also be used as digital inputs. Local pre-processing of the signals relieves the fieldbus of the task and ensures a faster and more reproducible response time
- Integrated EMC filter class A (acc. to EN 55011)
- Integrated brake control, supported brake voltage 180 V DC (at line voltage of 400 V AC – otherwise $U_{line} \times 0.45 =$ brake voltage)
- Integrated motor protection using a thermal motor model and evaluation of PTC, KTY, bimetal or Pt1000 temperature sensors
- Software parameters for simple adaptation to 50 Hz or 60 Hz motors (IEC or NEMA motors)
- Easy replacement of devices and time-saving copying of parameters to optional memory card
- Engineering and commissioning with standard engineering tools such as SIZER for Siemens Drives (V2.9 and higher), SINAMICS DriveSim Designer (firmware V4.7 SP13 and higher), STARTER (V4.3 and higher), SINAMICS Startdrive, TIA Selection Tool and Drive ES: ensure fast engineering and easy commissioning – STARTER is integrated in STEP 7 with Drive ES Basic with all the advantages of central data storage and totally integrated communication
- Certified worldwide for compliance with CE, UKCA, UL, cUL, RCM and Safety Integrated according to IEC 61508 SIL 2 and ISO 13849-1 PL d and Category 3

SINAMICS G120D distributed converters

0.75 kW to 7.5 kW (1 hp to 10 hp)

SINAMICS G120D distributed converters

Design

The SINAMICS G120D distributed converters are modular converters for standard drives. Each SINAMICS G120D comprises two operative units – a Power Module and a Control Unit.

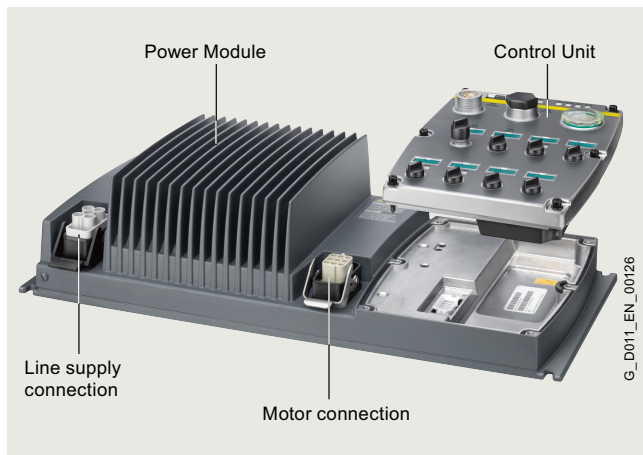

PM250D Power Module with line supply and motor connections and CU240D-2 Control Unit

Power Modules

The following PM250D Power Modules are available for the SINAMICS G120D distributed converters:

PM250D Power Modules

PM250D Power Modules (0.75 kW to 7.5 kW) have an innovative circuit design which allows line-commutated energy recovery back into the line supply. This innovative circuit permits generated energy to be fed back into the supply system and therefore saves energy.

Control Units

A Control Unit performs closed-loop control functions for the converter. In addition to the closed-loop control, it has additional functions that can be adapted to the particular application through parameterization.

The following Control Units are available for SINAMICS G120D distributed converters:

CU240D-2 Control Units

The CU240D-2 Control Units can be used to implement applications with speed/torque control. Several Control Units are available in different versions:

- CU240D-2 PN → PROFINET
- CU240D-2 PN-F → PROFINET fail-safe
- CU240D-2 PN-F PP → PROFINET fail-safe Push Pull

CU250D-2 Control Units

CU250D-2 Control Units can be used to implement applications with positioning requirements in the drive. Several Control Units are available in different versions:

- CU250D-2 PN-F → PROFINET fail-safe
- CU250D-2 PN-F PP → PROFINET fail-safe Push Pull

Supplementary system components

IOP-2 Handheld Intelligent Operator Panel

The IOP-2 Handheld supports both newcomers and drive experts. Thanks to the large plain text display, the menu-based operation and the application wizards, it is easy to commission, diagnose and locally control standard drives.

Memory card

The parameter settings for a converter can be stored on the SINAMICS SD memory card. When service is required, e.g. after the converter has been replaced and the data have been downloaded from the memory card, the drive system is immediately ready for use again. The associated slot is located on the rear of the Control Unit.

Mini USB interface cable for communication with a PC

For controlling and commissioning a converter directly from a PC if the appropriate software (STARTER commissioning tool V4.3 and higher or SINAMICS Startdrive) has been installed.

Connecting cables for the Control Units

Flexible plug-in cables to transfer data between the Industrial Ethernet stations, as well as to supply power to the Control Unit.

Connecting cables for the Power Modules

Connector sets to connect to the line supply and the outgoing motor feeder are available as accessories as well as pre-assembled motor cables for connection to the motor.

Spare parts kit

A spare parts kit is available which comprises small parts such as seals, caps and screws.

Replacement fan

A replacement fan is available, which comprises a pre-mounted unit with cover, fan and screws.

Configuration

The following electronic configuring aids and engineering tools are available for the SINAMICS G120D distributed converters:

SINAMICS DriveSim Designer (firmware V4.7 SP13 or higher)

SINAMICS DriveSim Designer provides easy-to-use models for PROFIdrive-enabled SINAMICS converters, so you can create a digital twin of your drive.

More information is provided on the internet at:
www.siemens.com/drive-virtualization

Siemens Product Configurator

The Siemens Product Configurator helps you configure the optimum drive technology products for a number of applications – starting with gearboxes, motors, converters as well as the associated options and components and ending with controllers, software licenses and connection systems. The Siemens Product Configurator can be used on the internet without requiring any installation. The Siemens Product Configurator can be found in SiePortal at the following address:

www.siemens.com/spc

SIMARIS planning tools for plants with SINAMICS drives

Electrical planning: Even easier with software!

Electrical planning for power distribution in non-residential and industrial buildings has never been more complex. To ensure you, as a specialist planner, have the best hand when it comes to electrical planning with SINAMICS drives, we provide support with the following efficient software tools: SIMARIS design for dimensioning and SIMARIS project for calculating the space requirements of the distribution boards.

SIZER for Siemens Drives (integrated in the TIA Selection Tool) engineering tool.

The PC-based SIZER for Siemens Drives engineering tool makes it easy to configure the SINAMICS drive family. It provides support when selecting the hardware and firmware components necessary to implement a drive task. SIZER for Siemens Drives supports the complete configuration of the drive system, from basic single drives to demanding multi-axis applications.

The SIZER for Siemens Drives engineering tool is available free on the internet at:
www.siemens.com/sizer

STARTER commissioning tool

The STARTER commissioning tool allows menu-prompted commissioning, optimization and diagnostics and the TIA functionality. Apart from the SINAMICS drives, STARTER is also suitable for MICROMASTER 4 devices.

More information about the STARTER commissioning tool is available on the internet at:
www.siemens.com/starter

SINAMICS Startdrive commissioning tool (for SINAMICS G120D from V13)

SINAMICS Startdrive is a tool integrated into the TIA Portal for configuring, commissioning and diagnostics of the SINAMICS converter family. SINAMICS Startdrive (for SINAMICS G120D from V13) can be used for implementing drive tasks with most of the SINAMICS G and SINAMICS S converter series. The commissioning tool has been optimized in terms of simplicity, ease of use, and consistent use of the benefits of the TIA Portal to provide a uniform working environment for PLC, HMI and drives.

The SINAMICS Startdrive commissioning tool is available for free on the internet at:

www.siemens.com/startdrive

Drive dimensioning of the SINAMICS G120D distributed converter with the TIA Selection Tool

The SINAMICS G120D distributed converter is easily configured with the TIA Selection Tool under the drive dimensioning plug-in. It provides support when selecting the hardware and firmware components necessary to implement a drive task. The plug-in encompasses the configuration of the entire drive system and allows the handling of individual drives.

- Intuitive user interface, menu-based operation and help
- Configuration of the SINAMICS G120D distributed converter
- Adjustable load cycles and various mechanical systems integrated
- Interface to the TIA Portal and SiePortal

The TIA Selection Tool is available for free on the internet at:
www.siemens.com/tia-selection-tool-standalone

Drive ES engineering system

Drive ES is the engineering system that can be used to integrate the communication, configuration and data management functions of Siemens drive technology into the SIMATIC automation world easily, efficiently and cost-effectively. The Drive ES PCS software package is available for SINAMICS.

More information about the Drive ES engineering system is available on the internet at:
www.siemens.com/drive-es

SINAMICS G120D distributed converters

0.75 kW to 7.5 kW (1 hp to 10 hp)

SINAMICS G120D distributed converters

Technical specifications

Unless explicitly specified otherwise, the following technical specifications are valid for all the following SINAMICS G120D distributed converter components listed here.

SINAMICS G120D	
Mechanical specifications	
Vibratory load	
• Transport acc. to EN 60721-3-2 ¹⁾	Class 1M2
• Operation acc. to EN 60721-3-3	Class 3M2
Shock load	
• Transport acc. to EN 60721-3-2 ¹⁾	Class 1M2
• Operation acc. to EN 60721-3-3	Class 3M2
Ambient conditions	
Degree of protection	IP65/UL Type 3
External 24 V supply according to IEC 60204-1	Contact-safe SELV or PELV power supply. The supply voltage must not exceed 60 V DC under single fault conditions
Protection class according to IEC 61800-5-1	Class I (with protective grounding conductor)
Permissible ambient/coolant temperature (air) during operation	-10 ... +40 °C (14 ... 104 °F) without derating >40 ... 55 °C (104 ... 131 °F) see derating characteristics
Humidity, max.	95 % at 40 °C (104 °F)
Ambient temperature	
• Storage ¹⁾ acc. to EN 60068-2-1	-40 ... +70 °C (-40 ... +158 °F)
• Transport ¹⁾ acc. to EN 60068-2-1	-40 ... +70 °C (-40 ... +158 °F)
• Operation acc. to EN 60068-2-2	-10 ... +40 °C (14 ... 104 °F) without derating
Environmental class/harmful chemical substances	
• Operation acc. to EN 60721-3-3	Class 3C2
Degree of pollution acc. to EN 61800-5-1	2
Certification for fail-safe versions	
• According to IEC 61508	SIL 2
• According to ISO 13849-1	PL d and Category 3
Standards	
Compliance with standards	UL 508C (UL list number E121068), cUL, CE, UKCA, RCM
CE marking, according to	Low-Voltage Directive 2014/35/EU
EMC Directive	
• Frame sizes FSA to FSC with integrated line filter class A	Category C2 ²⁾ according to EN 61800-3
	Note: The EMC product standard EN 61800-3 does not apply directly to a frequency converter but to a PDS (Power Drive System), which comprises the complete circuitry, motor and cables in addition to the converter. The frequency converters on their own do not generally require identification according to the EMC Directive.

¹⁾ In product packaging.

²⁾ With shielded motor cable up to 15 m (49 ft).

SINAMICS G120D distributed converters

0.75 kW to 7.5 kW (1 hp to 10 hp)

CU240D-2 and CU250D-2 Control Units

Overview

The Control Unit performs closed-loop control functions for the converter. In addition to the closed-loop control, it has additional functions that can be adapted to the particular application through parameterization.

CU250D-2 Control Units can be used to implement applications with positioning requirements in the drive. This expansion opens up their use in lifting, swiveling, traversing or rotating applications. The positioning functionality is comparable to that of SINAMICS S110 servo drives.

Two points must be noted in this context:

- Vector control (VC) and sensorless vector control (SLVC) are possible (but not servo control)
- Positioning using one encoder (HTL/SSI) or using two encoders simultaneously (HTL for speed control and SSI for positioning)

Control Units are available in different versions:

- CU240D-2 PN
- CU240D-2 PN-F
- CU240D-2 PN-F PP (Push Pull)
- CU250D-2 PN-F
- CU250D-2 PN-F PP (Push Pull)

The Push Pull version comprises an alternative connection method for the 24 V DC supply voltage and the PN communication.



CU240D-2 PN Control Unit



CU250D-2 PN-F Control Unit



CU250D-2 PN-F PP Control Unit

SINAMICS G120D distributed converters

0.75 kW to 7.5 kW (1 hp to 10 hp)

[Clicking to SiePortal](#)

6SL3255-0AA00-5AA0

**CU240D-2 and CU250D-2 Control Units****Overview****Safety Integrated functions**

The Safety Integrated function "Safe Torque Off" (STO) (certified according to IEC 61508 SIL 2, ISO 13849-1 PL d and Category 3) is already integrated into the standard version of the CU240D-2 series CU240D-2 PN. It can be activated either over PROFIsafe or over the safety input.

With the fail-safe variants of the CU240D-2 series (CU240D-2 PN-F xx) and with the entire CU250D-2 series, the fail-safe SINAMICS G120D converter provides five safety functions which are certified according to IEC 61508 SIL 2, ISO 13849-1 PL d and Category 3:

- Safe Torque Off (STO)
to protect against active movement of the drive
- Safe Stop 1 (SS1)
for continuous monitoring of a safe braking ramp
- Safely-Limited Speed (SLS)
for protection against dangerous movements on exceeding a speed limit
- Safe direction (SDI)
This function ensures that the drive can only rotate in the selected direction.
- Safe speed monitoring (SSM)
This function signals if a drive is operating below a specific speed/feed velocity.

These functions can be activated by means of PROFIsafe or via the safety inputs. A safety output is provided in addition.

All safety functions can be implemented without having to use a motor encoder; the implementation costs are minimal. Existing systems in particular can be simply updated with safety technology without the need to change the motor or mechanical system.

The Safe Torque Off (STO) function can be used without restriction for all applications. The SS1, SLS, SSM and SDI functions are only permissible for applications where the load can never accelerate when the converter is switched off. They are therefore not permitted for applications involving pull-through loads such as hoisting gear and unwinders.

Selection and ordering data

Communication	Digital inputs (number which can be parameterized as fail-safe given below)	Analog inputs	Digital outputs (number which can be parameterized as fail-safe given below)	Encoder interfaces HTL/SSI	Safety Integrated functions	Description	Control Unit Article No.
CU240D-2 series – standard							
PROFINET, EtherNet/IP	6 (1)	2	2	1/–	STO	CU240D-2 PN	6SL3544-0FB20-1FA0
CU240D-2 series – fail-safe for Safety Integrated							
PROFINET, EtherNet/IP	6 (3)	2	2 (1)	1/–	STO, SLS, SS1, SSM, SDI	CU240D-2 PN-F	6SL3544-0FB21-1FA0
						CU240D-2 PN-F PP	6SL3544-0FB21-1FB0
CU250D-2 serie – basic positioner (EPOS) and fail-safe for Safety Integrated							
PROFINET, EtherNet/IP	6 (3)	–	2 (1)	1/1	STO, SLS, SS1, SSM, SDI	CU250D-2 PN-F	6SL3546-0FB21-1FA0
						CU250D-2 PN-F PP	6SL3546-0FB21-1FB0

Note:

An external 24 V DC power supply is required in order to operate the Control Unit. For information about suitable connecting cables, refer to section Supplementary system components, Connecting cables/connectors for supplying the Control Unit with 24 V DC power.

For optional memory cards, see section Supplementary system components.

Design

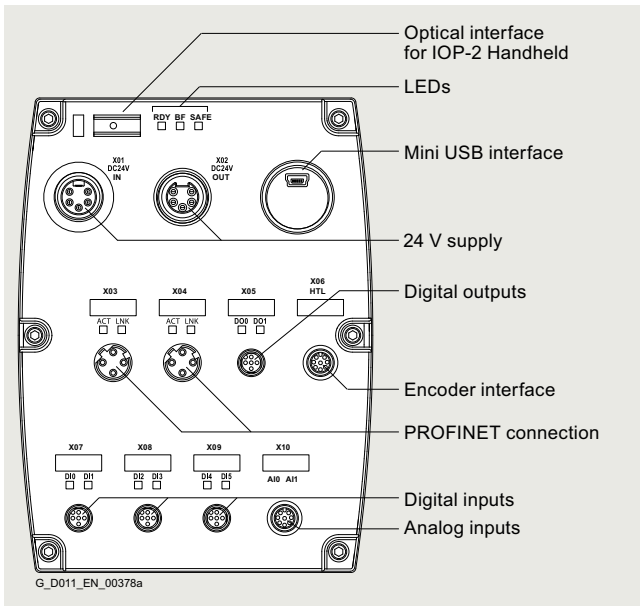

CU240D-2 PN Control Unit

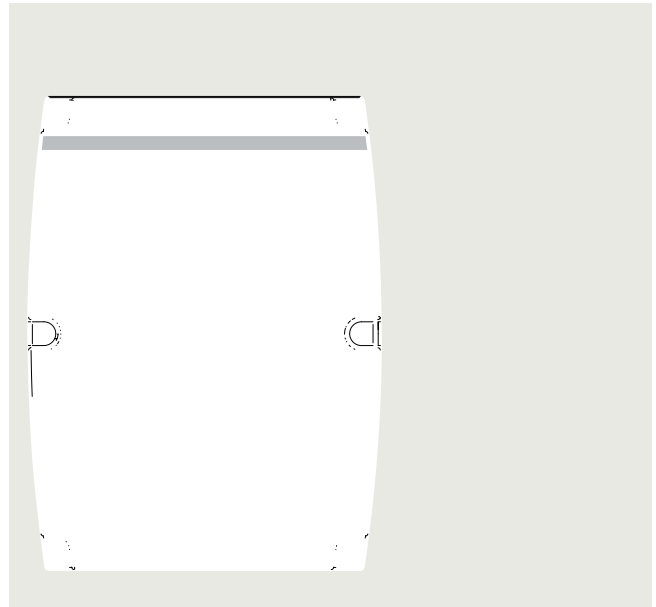

CU240D-2 PN-F Control Unit

SINAMICS G120D distributed converters

0.75 kW to 7.5 kW (1 hp to 10 hp)

CU240D-2 and CU250D-2 Control Units

Design

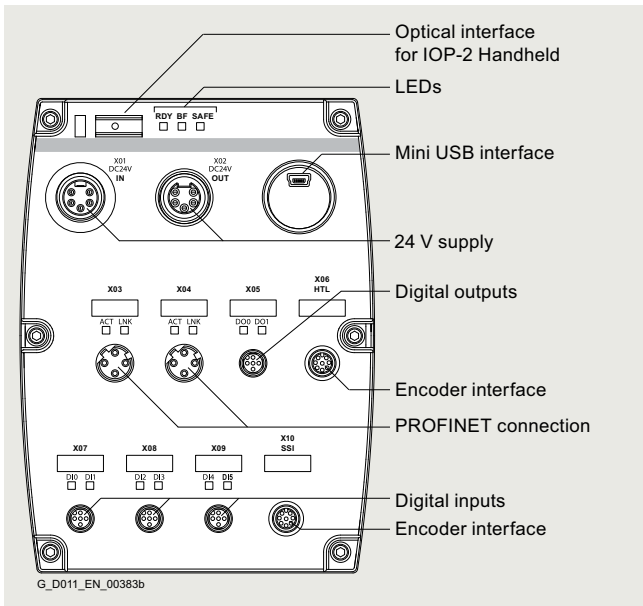

CU250D-2 PN-F Control Unit

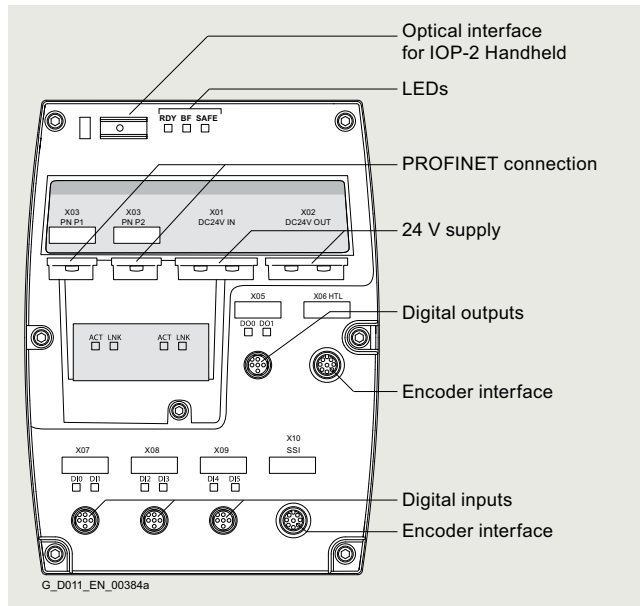

CU250D-2 PN-F PP Control Unit



Control Unit, view from the rear, memory card slot at the top and PM-IF interface at bottom center

Function

Function module basic positioner EPOS

The basic positioner EPOS is available as a standard technology function for the following SINAMICS Control Units and can be called as a function module that can be activated additionally.

- SINAMICS S120 CU310-2 and CU320-2 Control Units
- SINAMICS S110 CU305 Control Units
- SINAMICS G120 CU250S-2 Control Units
- SINAMICS G120D CU250D-2 Control Units

The basic positioner can be used to resolve basic motion control tasks without additional external technological outlay from the drive itself.

Integrated functionality for absolute and relative positioning of linear and rotary axes with motor encoders or machine encoders.

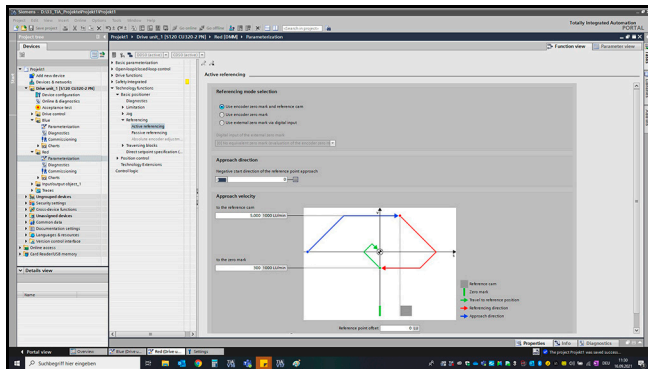
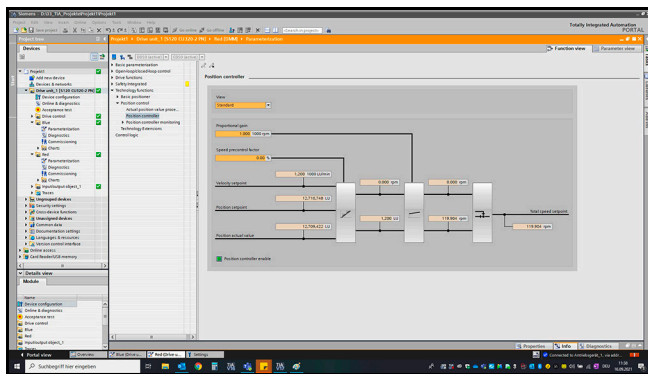

The EPOS basic positioner in the SINAMICS drive system provides powerful and precise positioning functions. Due to its flexibility and adaptability, the basic positioner can be used for a wide range of positioning tasks.

The functions are easy to handle both during commissioning and during operation, and the comprehensive monitoring functions are outstanding.

Many applications can be carried out without external position controllers.

The EPOS basic positioner is used to position linear and rotary axes (modulo) in absolute/relative terms with rotary as well as linear motor encoder or machine encoder (indirect or direct measuring system).

EPOS is a function module that can be activated additionally in Servo Control and in Vector Control.

User-friendly configuring and commissioning, including control panel (operation using PC) and diagnostics, are possible with the STARTER and SINAMICS Startdrive commissioning tools.

In addition to extremely flexible positioning functions, EPOS offers a high degree of user-friendliness and reliability thanks to integral monitoring and compensation functions.

Different operating modes and their functionality increase flexibility and plant productivity, for example, by means of "on-the-fly" and bumpless correction of the motion control.

Preconfigured PROFIdrive positioning frames are available which, when selected, automatically establish the internal "connection" to the basic positioner.

SINAMICS G120D distributed converters

0.75 kW to 7.5 kW (1 hp to 10 hp)

CU240D-2 and CU250D-2 Control Units

Function

Functionality of the EPOS basic positioner

Lower-level closed-loop position control with the following essential components

- Position actual value sensing (including the lower-level measuring probe evaluation and reference mark search)
- Position controller (including limits, adaptation and pre-control calculation)
- Monitoring functions (standstill, positioning and dynamic following error monitoring, cam signals)

Mechanical system

- Backlash compensation
- Modulo offset

Limitations

- Speed/acceleration/delay/jerk limitation
- Software limit switches (traversing range limitation by means of position setpoint evaluation)
- Stop cams (traversing range limitation using hardware limit switch evaluation)

Referencing or adjustment

- Set reference point (for an axis at standstill)
- Search for reference (separate mode including reversing cam functionality, automatic reversal of direction, homing to "output cam and encoder zero mark" or only "encoder zero mark" or "external zero mark (BERO)")
- Flying referencing (seamless referencing possible during "normal" traversing with the aid of the measuring input evaluation; generally evaluation, e.g. of a BERO. Subordinate function for the modes "jog", "direct setpoint input/MDI" and "traversing blocks")
- Absolute encoder alignment

Traversing block mode

- 64 traversing blocks for
 - SINAMICS S120 CU310-2 and CU320-2 Control Units
- 16 traversing blocks for
 - SINAMICS S110 CU305 Control Units
 - SINAMICS G120 CU250S-2 Control Units
 - SINAMICS G120D CU250D-2 Control Units
- Positioning using traversing blocks that can be stored in the drive unit including continuation conditions and specific jobs for a previously homed axis
- Configuring traversing blocks using the traversing block editor in the relevant commissioning tool of the SINAMICS drive family
- A traversing block contains the following information:
 - Job number and job (e.g. positioning, waiting, GOTO block jump, setting of binary outputs, travel to fixed endstop)
 - Motion parameters (target position, velocity, override for acceleration and deceleration)
 - Mode (e.g.: hide block, continuation conditions such as "Continue_with_stop", "Continue_flying" and "Continue_externally_using_high-speed_measuring_inputs")
 - Job parameters (e.g. wait time, block step conditions)

Direct setpoint specification mode (MDI)

- Positioning (absolute, relative) and setting-up (endless closed-loop position control) using direct setpoint inputs (e.g. via the PLC using process data)
- It is always possible to influence the motion parameters during traversing (on-the-fly setpoint acceptance) as well as for on-the-fly changes between the setup and positioning modes.
- The direct setpoint specification mode (MDI) can also be used in the relative positioning or setup mode if the axis is not referenced. This means that on-the-fly synchronization and re-referencing can be carried out using "flying referencing".

Jog mode

- Closed-loop position controlled traversing of the axis with "endless position controlled" or "jog incremental" modes (traverse through a "step width"), which can be toggled between

SINAMICS G120D distributed converters

0.75 kW to 7.5 kW (1 hp to 10 hp)

CU240D-2 and CU250D-2 Control Units

Integration

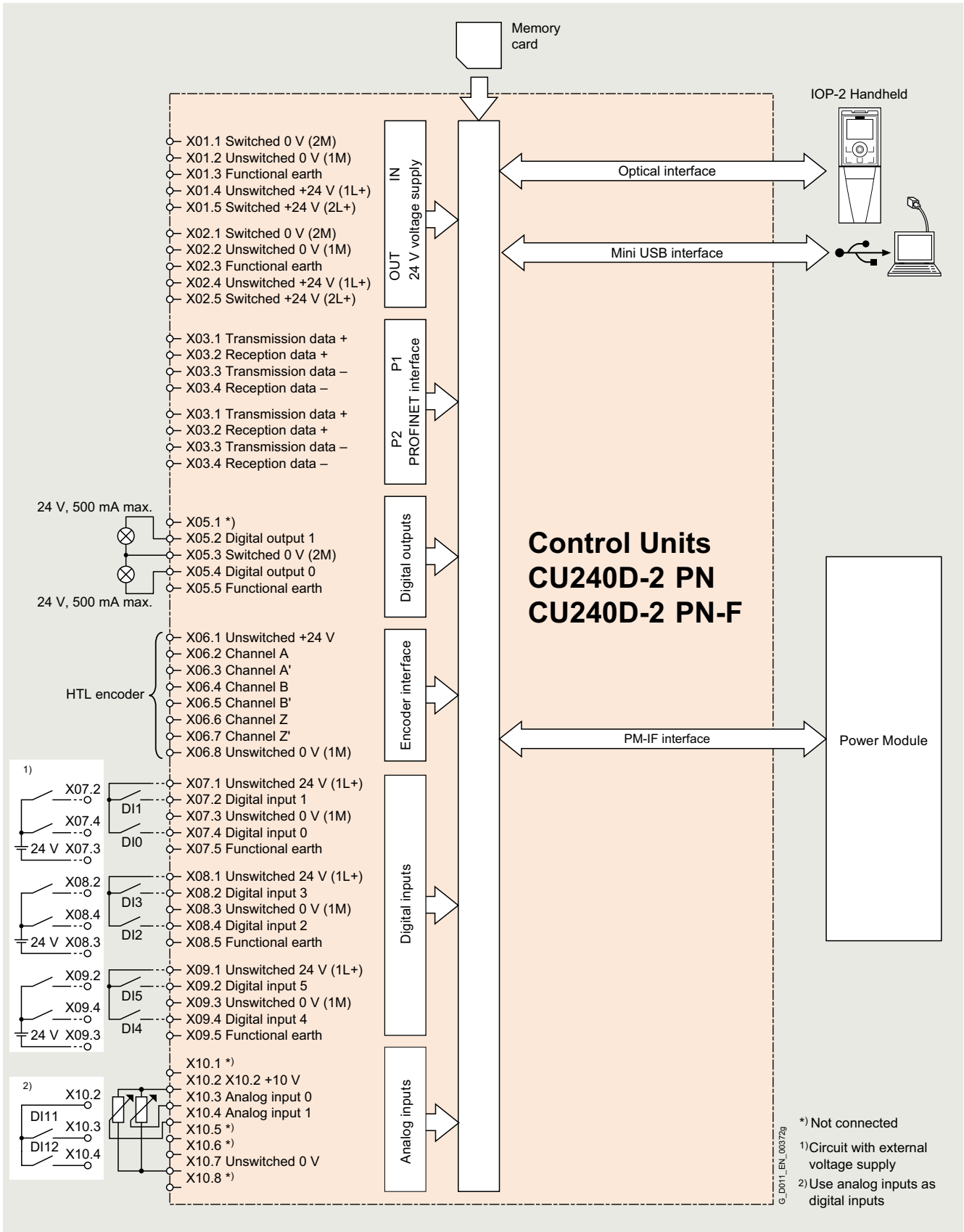

Connection example for CU240D-2 PN and CU240D-2 PN-F Control Units

SINAMICS G120D distributed converters

0.75 kW to 7.5 kW (1 hp to 10 hp)

CU240D-2 and CU250D-2 Control Units

Integration

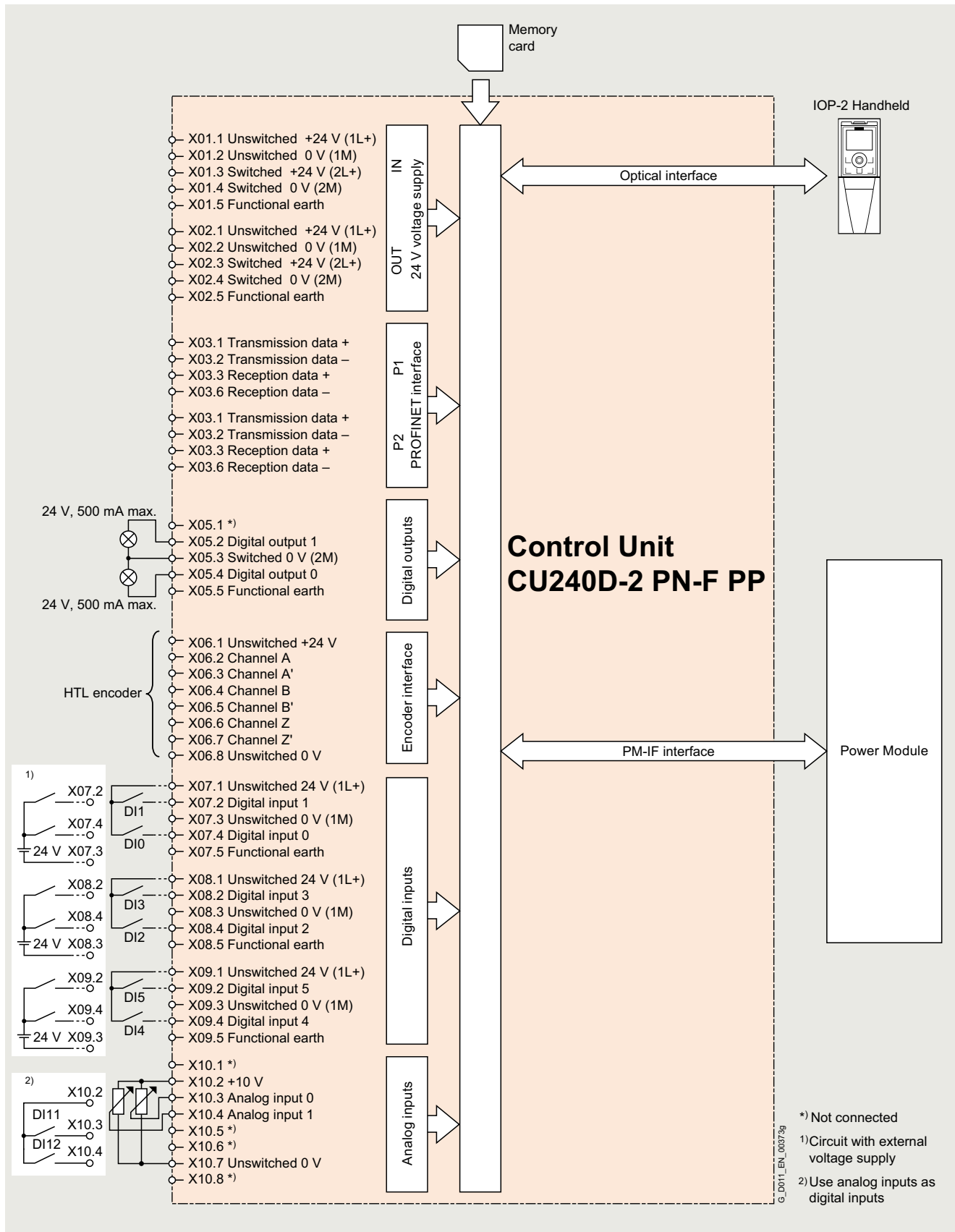

Connection example for CU240D-2 PN-F PP Control Unit

Integration

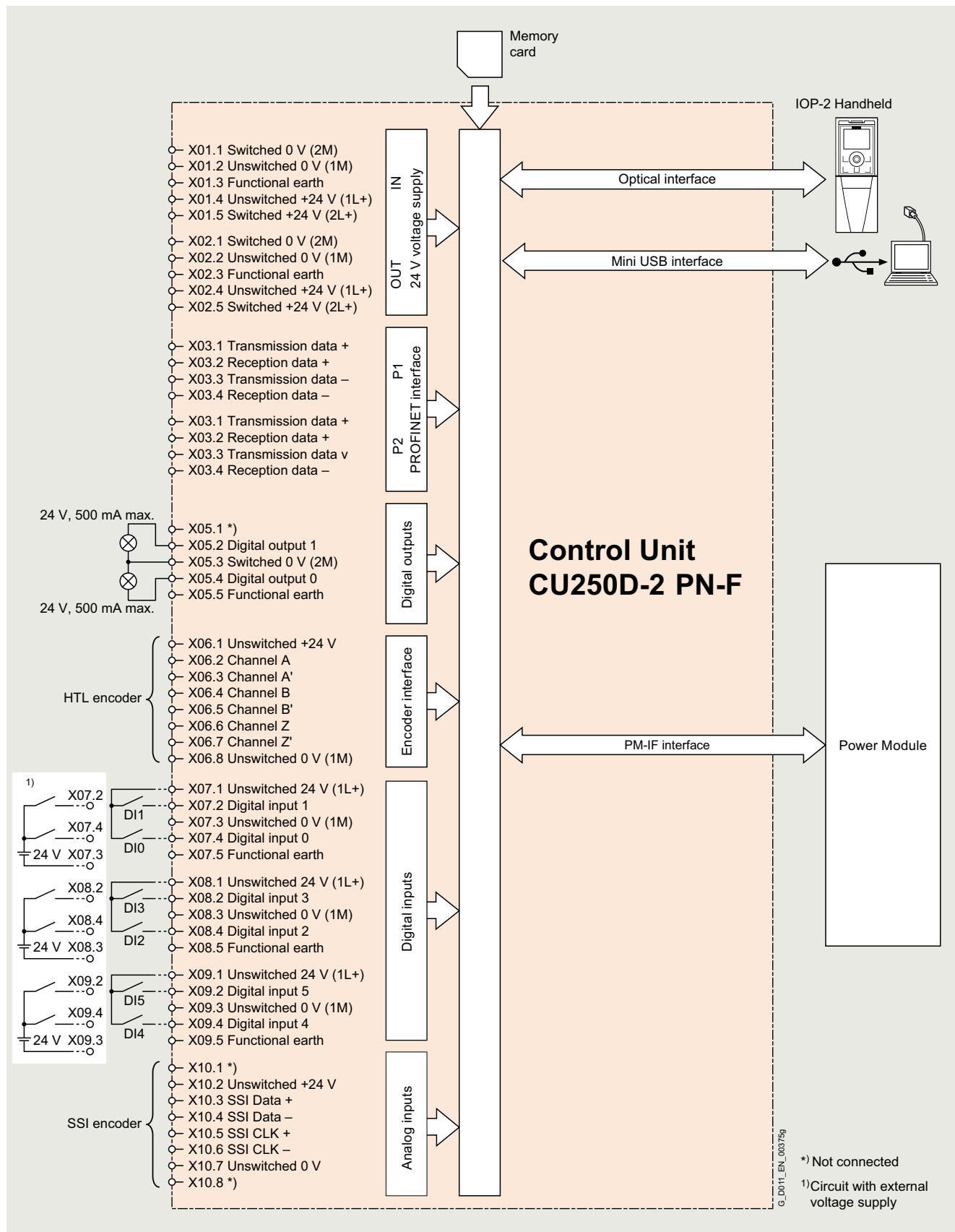

Connection example for CU250D-2 PN-F Control Unit

SINAMICS G120D distributed converters

0.75 kW to 7.5 kW (1 hp to 10 hp)

CU240D-2 and CU250D-2 Control Units

Integration

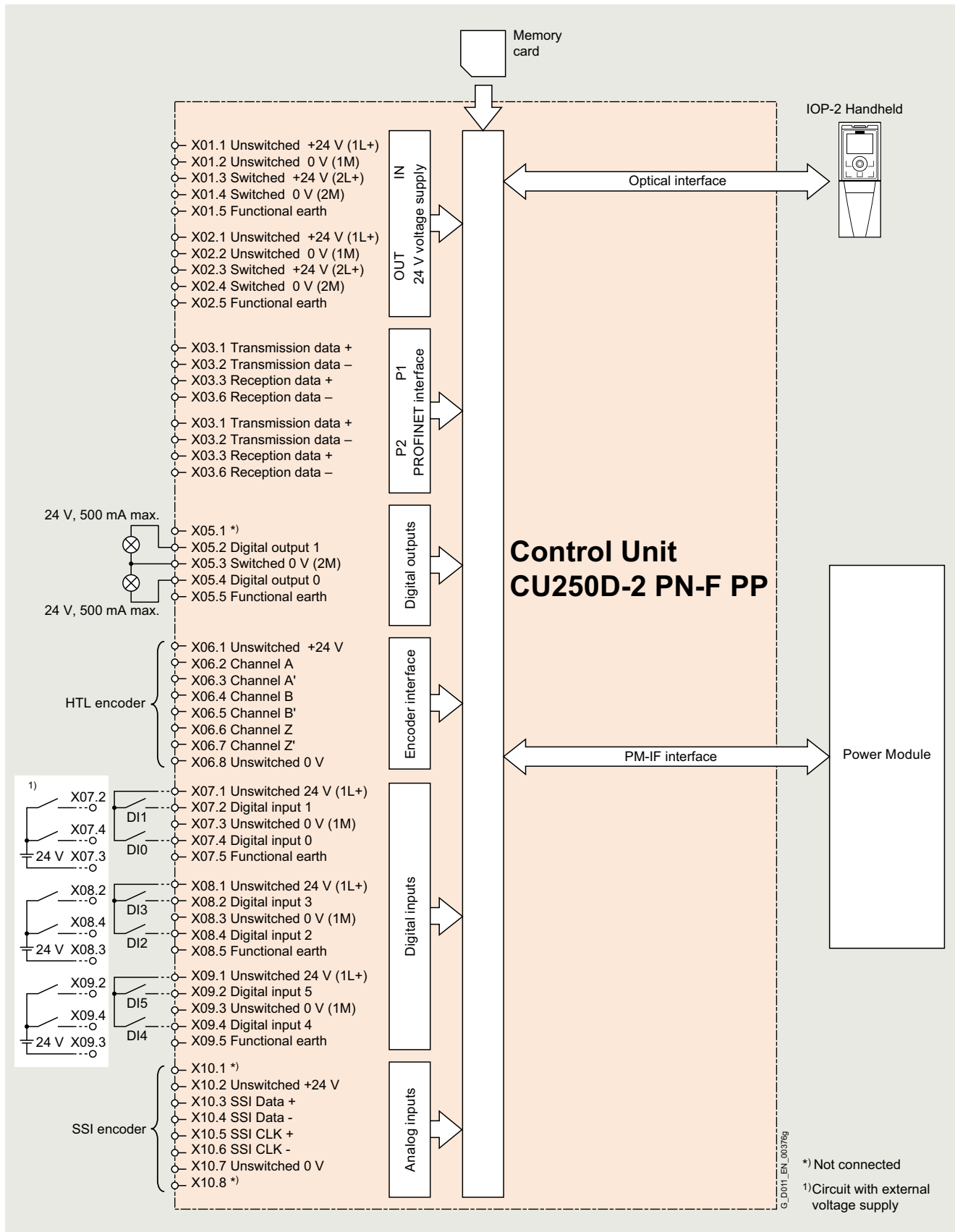

Connection example for CU250D-2 PN-F PP Control Unit

SINAMICS G120D distributed converters

0.75 kW to 7.5 kW (1 hp to 10 hp)

CU240D-2 and CU250D-2 Control Units

Technical specifications

Control Unit	CU240D-2 PN 6SL3544-0FB20-1FA0	CU240D-2 PN-F 6SL3544-0FB21-1FA0 CU240D-2 PN-F PP 6SL3544-0FB21-1FB0	CU250D-2 PN-F 6SL3546-0FB21-1FA0 CU250D-2 PN-F PP 6SL3546-0FB21-1FB0
Electrical specifications			
Operating voltage	External 24 V DC necessary	External 24 V DC necessary	External 24 V DC necessary
Current consumption ¹⁾ (from the 24 V DC supply)			
• With Power Module frame sizes FSA and FSB	400 mA	400 mA	400 mA
• With Power Module frame size FSC	550 mA	550 mA	550 mA
Interfaces			
Digital inputs (not isolated)	6	6	6
• Optionally parameterizable as safe inputs	1	3	3
Analog inputs (0 ... 10 V)	2	2	–
Digital outputs (0.5 A, fed through switched 24 V DC, isolated)	2	2	2
• Optionally parameterizable as safe digital output	–	1	1
Bus interface			
• Fieldbus protocols	PROFINET EtherNet/IP	PROFINET EtherNet/IP	PROFINET EtherNet/IP
• Profiles	PROFIdrive PROFIsafe PROFInergy	PROFIdrive PROFIsafe PROFInergy	PROFIdrive PROFIsafe PROFInergy
HTL encoder interface (incremental interface, bipolar up to 2048 pulses, max. 150 mA)	1	1	1
SSI encoder interface (absolute encoder, single-turn and multi-turn 4096 pulses, 24 V, max. 250 mA)	–	–	1
PTC/KTY interface (connection via Power Module)	✓	✓	✓
• Motor temperature sensor	1 input, sensors that can be connected: PTC, KTY, bimetal or Pt1000	1 input, sensors that can be connected: PTC, KTY, bimetal or Pt1000	1 input, sensors that can be connected: PTC, KTY, bimetal or Pt1000
Control of a mechanical motor brake (connection via Power Module)	✓	✓	✓
Slot for SINAMICS SD memory card	✓	✓	✓
Commissioning interface (mini USB)	✓	✓ Not with PP variants	✓ Not with PP variants

¹⁾ The current consumption of connected encoders (HTL ≤ 100 mA or SSI ≤ 250 mA), sensors (total, max. 300 mA) as well as the current drawn from the digital outputs (total max. 500 mA) must be added, where applicable.

SINAMICS G120D distributed converters

0.75 kW to 7.5 kW (1 hp to 10 hp)

CU240D-2 and CU250D-2 Control Units

Technical specifications

Control Unit	CU240D-2 PN 6SL3544-0FB20-1FA0	CU240D-2 PN-F 6SL3544-0FB21-1FA0 CU240D-2 PN-F PP 6SL3544-0FB21-1FB0	CU250D-2 PN-F 6SL3546-0FB21-1FA0 CU250D-2 PN-F PP 6SL3546-0FB21-1FB0
Safety functions			
Integrated safety functions acc. to IEC 61508 SIL 2, ISO 13849-1 PL d and Category 3	<ul style="list-style-type: none"> • Safe Torque Off (STO) 	<ul style="list-style-type: none"> • Safe Torque Off (STO) • Safe Stop 1 (SS1) • Safely-Limited Speed (SLS) • Safe Direction (SDI) • Safe Speed Monitor (SSM) 	<ul style="list-style-type: none"> • Safe Torque Off (STO) • Safe Stop 1 (SS1) • Safely-Limited Speed (SLS) • Safe Direction (SDI) • Safe Speed Monitor (SSM)
Open-loop/closed-loop control techniques			
V/f linear/ quadratic/ parameterizable	✓	✓	✓
V/f with flux current control (FCC)	✓	✓	✓
Vector control, sensorless	✓	✓	✓
Vector control, with sensor	✓	✓	✓
Torque control, sensorless	✓	✓	–
Torque control, with sensor	✓	✓	–
Software functions			
Basic positioner (EPOS)	–	–	✓
Fixed frequencies	16, parameterizable	16, parameterizable	16, parameterizable
Signal interconnection with BICO technology	✓	✓	✓
Automatic restart after line supply failure or operational fault	✓	✓	✓
Slip compensation	✓	✓	✓
Free function blocks (FFB) for logical and arithmetic operations	✓	✓	–
Ramp smoothing	✓	✓	✓
4 selectable drive datasets	✓	✓	✓
4 selectable command data sets (CDS) (manual/auto)	✓	✓	✓
Flying restart	✓	✓	–
JOG	✓	✓	–
Cyclic recording of ramp-up and ramp-down	✓	✓	✓

SINAMICS G120D distributed converters

0.75 kW to 7.5 kW (1 hp to 10 hp)

CU240D-2 and CU250D-2 Control Units

Technical specifications

Control Unit	CU240D-2 PN 6SL3544-0FB20-1FA0	CU240D-2 PN-F 6SL3544-0FB21-1FA0 CU240D-2 PN-F PP 6SL3544-0FB21-1FB0	CU250D-2 PN-F 6SL3546-0FB21-1FA0 CU250D-2 PN-F PP 6SL3546-0FB21-1FB0
Software functions			
Technology controller (PID)	✓	✓	–
Thermal motor protection	✓	✓	✓
Thermal converter protection	✓	✓	✓
Setpoint input	✓	✓	✓
Motor identification	✓	✓	✓
Motor holding brake	✓	✓	✓
Mechanical specifications and ambient conditions			
Operating temperature	-10 ... +50 °C (14 ... 122 °F)	0 ... 50 °C (32 ... 122 °F)	0 ... 50 °C (32 ... 122 °F)
Storage temperature	-40 ... +70 °C (-40 ... +158 °F)	-40 ... +70 °C (-40 ... +158 °F)	-40 ... +70 °C (-40 ... +158 °F)
Relative humidity	<95 % RH, condensation not permissible	<95 % RH, condensation not permissible	<95 % RH, condensation not permissible
Dimensions			
• Width	153 mm (6.02 in)	153 mm (6.02 in)	153 mm (6.02 in)
• Height	208 mm (8.19 in)	208 mm (8.19 in)	208 mm (8.19 in)
• Depth	55 mm (2.17 in)	55 mm (2.17 in) (PP variant: 118 mm) (4.65 in)	55 mm (2.17 in) (PP variant: 118 mm) (4.65 in)
Weight, approx.	0.8 kg (1.76 lb)	0.8 kg (1.76 lb) (PP variant: 1.3 kg (2.87 lb))	0.8 kg (1.76 lb) (PP variant: 1.3 kg (2.87 lb))

SINAMICS G120D distributed converters

0.75 kW to 7.5 kW (1 hp to 10 hp)

[Clicking to SiePortal](#)
[6SL3255-0AA00-5AA0](#)

PM250D Power Modules

Overview

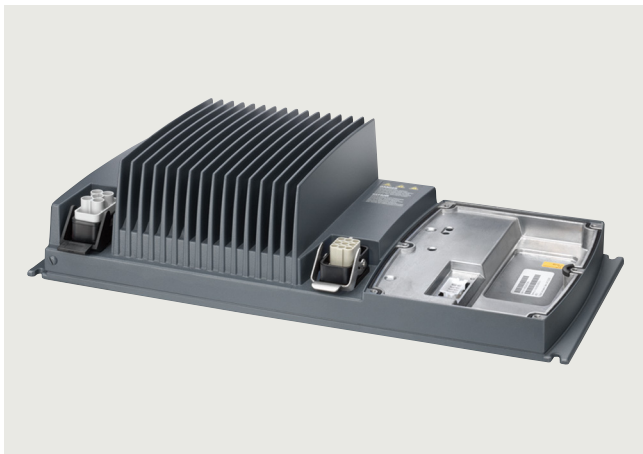

Example of PM250D Power Module, frame size FSA

The regenerative feedback capability of the PM250D Power Module in generating mode (electronic braking) means that energy is returned to the supply system and is not converted into heat in a braking resistor. This saves space, time-consuming dimensioning of the braking resistor as well as its wiring. Generated heat is also reduced.

An innovative circuit design reduces the supply harmonics. A line reactor is not required. This saves space and costs for engineering and procurement.

The PM250D Power Module is also designed for safety-oriented applications. In conjunction with a fail-safe Control Unit, the drive can be transformed into a Safety Integrated Drive ([siehe Control Units](#)).

The PM250D Power Modules with integrated line filter class A are suitable for connection to TN and TT supply systems.

Selection and ordering data

Rated power ¹⁾		Rated output current ²⁾	Input current	Frame size	PM250D Power Module with integrated line filter class A
kW	hp				
380 ... 500 V 3 AC					
0.75	1	2.2	2.1	FSA	6SL3525-0PE17-5AA1
1.5	1.5 ³⁾	4.1	3.8	FSA	6SL3525-0PE21-5AA1
3	4	7.7	7.2	FSB	6SL3525-0PE23-0AA1
4	5	10.2	9.5	FSC	6SL3525-0PE24-0AA1
5.5	7.5	13.2	12.2	FSC	6SL3525-0PE25-5AA1
7.5	10	19	17.7	FSC	6SL3525-0PE27-5AA1

¹⁾ Rated power based on the rated output current I_N .
The rated output current I_N is based on the duty cycle for high overload (HO)

²⁾ The rated output current I_N is based on the duty cycle for high overload (HO). These current values are valid for 400 V and are specified on the rating plate of the Power Module.

³⁾ It is not possible to make any assignment to a particular standard.

SINAMICS G120D distributed converters

0.75 kW to 7.5 kW (1 hp to 10 hp)

PM250D Power Modules

Integration

PM250D Power Modules communicate with the Control Unit via the PM-IF interface.

PM250D Power Modules feature the following interfaces as standard:

- PM-IF interface for connection of the PM250D Power Module and Control Unit.
- Motor connection via Q8 (connector) including control of the motor brake and temperature sensor
- Line supply connection via Q4/2 (socket)

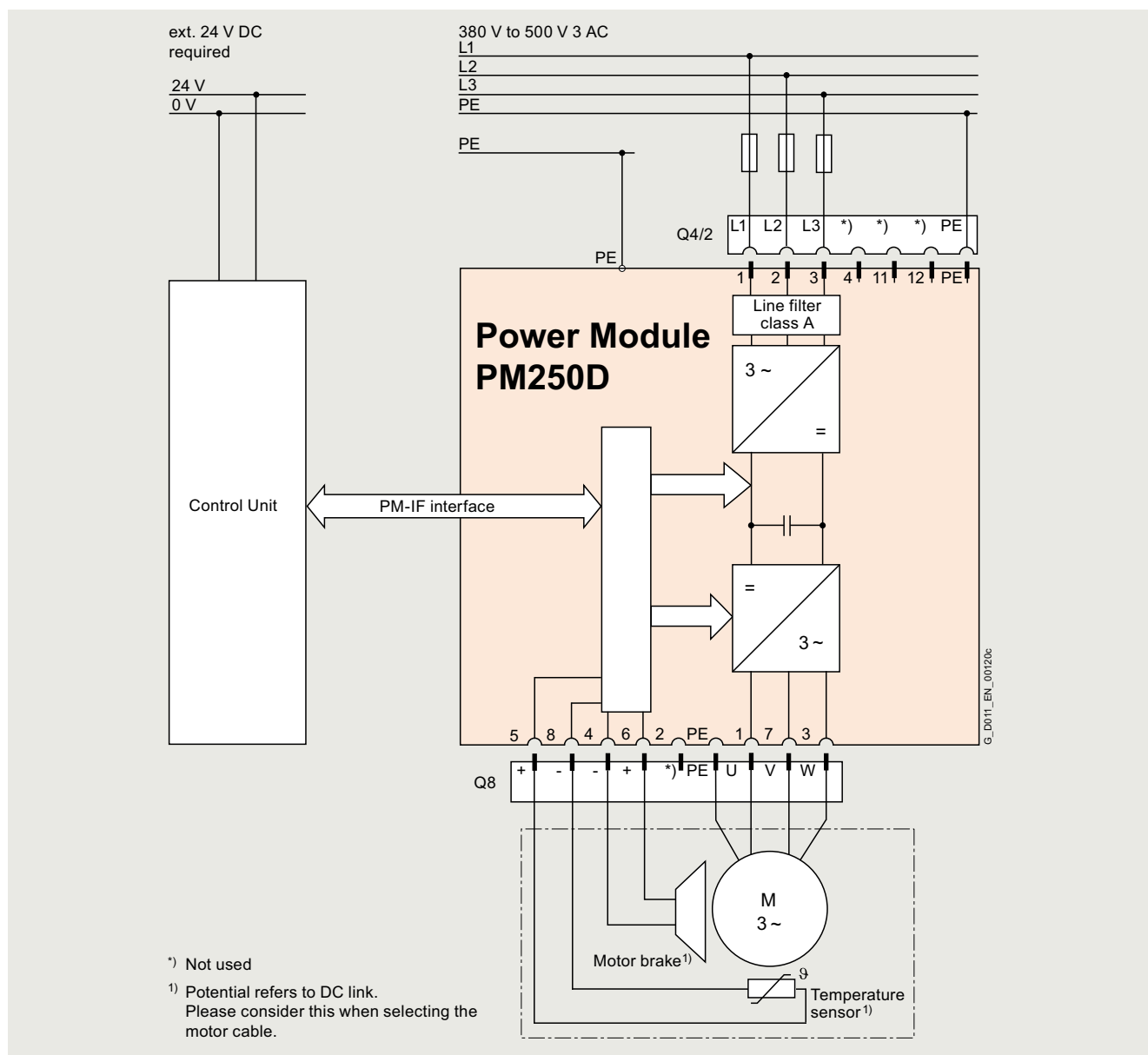

Connection example PM250D Power Module with integrated line filter class A

SINAMICS G120D distributed converters

0.75 kW to 7.5 kW (1 hp to 10 hp)

PM250D Power Modules

Technical specifications

General technical specifications

	PM250D Power Modules												
Line voltage	380 ... 500 V 3 AC ± 10 %												
Line supply requirements Short-circuit power ratio R_{SC}	>100												
Input frequency	47 ... 63 Hz												
Output frequency • Control mode V/f • Control mode Vector	0 ... 550 Hz ¹⁾ 0 ... 200 Hz												
Pulse frequency	4 kHz (standard), for higher pulse frequencies up to 16 kHz see derating data												
Power factor λ	0.95												
Converter efficiency η According to IEC 61800-9-2	95 ... 97 % ²⁾												
Efficiency class According to IEC 61800-9-2	IE2 ²⁾												
Output voltage, max. as % of input voltage	87 %												
Overload capability • High overload (HO)	Maximum duty cycle of a total cycle time of 300 s: • $2 \times$ rated output current I_N (i.e. 200 % overload) for 3 s followed by • $1.5 \times$ rated output current I_N (i.e. 150 % overload) for 57 s and • $0.87 \times$ rated output current I_N for the remaining 240 s												
Electromagnetic compatibility	Integrated line filter class A according to EN 55011												
Possible braking methods	Energy recovery in regenerative mode (max. with rated power possible); Integrated brake control supplies the DC supply voltage for the brake <table border="1"> <tr> <td>Line input voltage</td> <td>380 V AC</td> <td>400 V AC</td> <td>440 V AC</td> <td>480 V AC</td> <td>500 V AC</td> </tr> <tr> <td>Resulting brake voltage</td> <td>171 V DC</td> <td>180 V DC</td> <td>198 V DC</td> <td>216 V DC</td> <td>225 V DC</td> </tr> </table> Disconnection on the DC side permits "fast" braking (max. output current 1 A)	Line input voltage	380 V AC	400 V AC	440 V AC	480 V AC	500 V AC	Resulting brake voltage	171 V DC	180 V DC	198 V DC	216 V DC	225 V DC
Line input voltage	380 V AC	400 V AC	440 V AC	480 V AC	500 V AC								
Resulting brake voltage	171 V DC	180 V DC	198 V DC	216 V DC	225 V DC								
Operating temperature	-10 ... +55 °C (14 ... 131 °F) (operating temperature ranges of the Control Units must be taken into account)												
Storage temperature	-40 ... +70 °C (-40 ... +158 °F)												
Permissible mounting position	Horizontal wall mounting and mounting in the horizontal position												
Relative humidity	<95 % RH, condensation not permissible												
Cooling	FSA and FSB: Convection FSC: Air cooling as required using the integrated fan												
Installation altitude	Up to 1000 m (3281 ft) above sea level without derating >1000 m (3281 ft) see derating characteristics												
Short Circuit Current Rating (SCCR) ³⁾	40 kA												
Protection functions	<ul style="list-style-type: none"> • Undervoltage • Phase failure detection • Overvoltage • Overload • Ground fault • Short-circuit • Stall protection • Motor blocking protection • Motor overtemperature • Converter overtemperature • Parameter locking 												
Compliance with standards	UL 508C (UL list number E121068), cUL, CE, UKCA, RCM												
CE marking, according to	Low-Voltage Directive 2014/35/EU Ecodesign requirements of the EU Directive 2019/1781 ²⁾												

¹⁾ For more information, see <https://support.industry.siemens.com/cs/document/107669667>

²⁾ The SINAMICS G120D frequency converters fall under the ecodesign requirements of the EU Directive 2019/1781; however, the SINAMICS G120D frequency converters are considered to be frequency converters with regenerative feedback functionality. Therefore, no efficiency requirements apply in this case.

³⁾ Applies to industrial control cabinet installations according to NEC article 409 or UL 508A.

SINAMICS G120D distributed converters

0.75 kW to 7.5 kW (1 hp to 10 hp)

PM250D Power Modules

Technical specifications

Line voltage 380 ... 500 V 3 AC	PM250D Power Modules			
		6SL3525-0PE17-5AA1	6SL3525-0PE21-5AA1	6SL3525-0PE23-0AA1
Rated output current I_N ¹⁾	A	2.2	4.1	7.7
Maximum output current I_{max}	A	4.4	8.2	15.4
Rated power	kW (hp)	0.75 (1)	1.5 (1.5)	3 (4)
Rated pulse frequency	kHz	4	4	4
Efficiency η	%	>95	>95	>95
Power loss ²⁾ At rated output current	kW	0.046	0.068	0.125
Cooling air requirement	m ³ /s (ft ³ /s)	0.004 (0.14)	0.005 (0.18)	0.009 (0.32)
Sound pressure level L_{pA} (1 m)	dB	–	–	–
Rated input current ³⁾	A	2.1	3.8	7.2
Line supply connection U1/L1, V1/L2, W1/L3, PE		Q4/2 (connector)	Q4/2 (connector)	Q4/2 (connector)
• Conductor cross-section	mm ²	1.5 ... 6	1.5 ... 6	2.5 ... 6
PE connection (external connection)		On housing with M5 screw	On housing with M5 screw	On housing with M5 screw
• Conductor cross-section (recommended)	mm ²	10 ... 16	10 ... 16	10 ... 16
Motor connection U2, V2, W2, PE, motor brake, temperature sensor		Q8 (socket)	Q8 (socket)	Q8 (socket)
• Conductor cross-section	mm ²	1 ... 4	1 ... 4	2.5 ... 4
Motor cable length, max. Shielded	m (ft)	15 (49)	15 (49)	15 (49)
Degree of protection		IP65/UL Type 3	IP65/UL Type 3	IP65/UL Type 3
Dimensions				
• Width	mm (in)	445 (17.52)	445 (17.52)	445 (17.52)
• Height	mm (in)	210 (8.27)	210 (8.27)	210 (8.27)
• Depth	mm (in)	110 (4.33)	110 (4.33)	180 (4.33)
Frame size		FSA	FSA	FSB
Weight, approx.	kg (lb)	5.7 (12.6)	5.7 (12.6)	8 (17.6)

¹⁾ The rated output current I_N is based on the duty cycle for high overload (HO).

²⁾ Typical values. More information can be found on the internet at <https://support.industry.siemens.com/cs/document/94059311>

³⁾ The input current depends on the motor load and line impedance. The input currents apply for load at rated power for a line impedance corresponding to $u_K = 1\%$.

SINAMICS G120D distributed converters

0.75 kW to 7.5 kW (1 hp to 10 hp)

PM250D Power Modules

Technical specifications

Line voltage 380 ... 500 V 3 AC		PM250D Power Modules		
		6SL3525-0PE24-0AA1	6SL3525-0PE25-5AA1	6SL3525-0PE27-5AA1
Rated output current $I_N^{1)}$	A	10.2	13.2	19
Maximum output current I_{max}	A	20.4	26.4	38
Rated power	kW (hp)	4 (5)	5.5 (7.5)	7.5 (10)
Rated pulse frequency	kHz	4	4	4
Efficiency η	%	>95	>95	>95
Power loss ²⁾ At rated output current	kW	0.167	0.218	0.291
Cooling air requirement	m ³ /s (ft ³ /s)	0.012 (0.42)	0.018 (0.64)	0.025 (0.88)
Sound pressure level L_{pA} (1 m)	dB	74.5	74.5	74.5
Rated input current ³⁾	A	9.5	12.2	17.7
Line supply connection U1/L1, V1/L2, W1/L3, PE		Q4/2 (connector)	Q4/2 (connector)	Q4/2 (connector)
• Conductor cross-section	mm ²	2.5 ... 6	4 ... 6	4 ... 6
PE-connection (external connection)		On housing with M5 screw	On housing with M5 screw	On housing with M5 screw
• Conductor cross-section (recommended)	mm ²	10 ... 16	10 ... 16	10 ... 16
Motor connection U2, V2, W2, PE, motor brake, temperature sensor		Q8 (socket)	Q8 (socket)	Q8 (socket)
• Conductor cross-section	mm ²	2.5 ... 4	4	4
Motor cable length, max. Shielded	m (ft)	15	15	15
Degree of protection		IP65/UL Type 3	IP65/UL Type 3	IP65/UL Type 3
Dimensions				
• Width	mm (in)	445 (17.52)	445 (17.52)	445 (17.52)
• Height	mm (in)	210 (8.27)	210 (8.27)	210 (8.27)
• Depth	mm (in)	220 (8.66)	220 (8.66)	220 (8.66)
Frame size		FSC	FSC	FSC
Weight, approx.	kg (lb)	8.5 (18.7)	8.5 (18.7)	8.5 (18.7)

¹⁾ The rated output current I_N is based on the duty cycle for high overload (HO).

²⁾ Typical values. More information can be found on the internet at <https://support.industry.siemens.com/cs/document/94059311>

³⁾ The input current depends on the motor load and line impedance. The input currents apply for load at rated power for a line impedance corresponding to $u_K = 1\%$.

Characteristic curves

Derating data

Pulse frequency

Rated power at 400 V 3 AC		Rated output current in A for a pulse frequency of						
kW	hp	4 kHz	6 kHz	8 kHz	10 kHz	12 kHz	14 kHz	16 kHz
0.75	1	2.2	1.9	1.5	1.3	1.1	1	0.9
1.5	1.5 ¹⁾	4.1	3.5	2.9	2.5	2.1	1.8	1.6
3	4	7.7	6.5	5.4	4.6	3.9	3.5	3.1
4	5	10.2	8.7	7.1	6.1	5.1	4.6	4.1
5.5	7.5	13.2	11.2	9.2	7.9	6.6	5.9	5.3
7.5	10	19	19	19	17.6	16.3	14.9	13.5

Ambient temperature

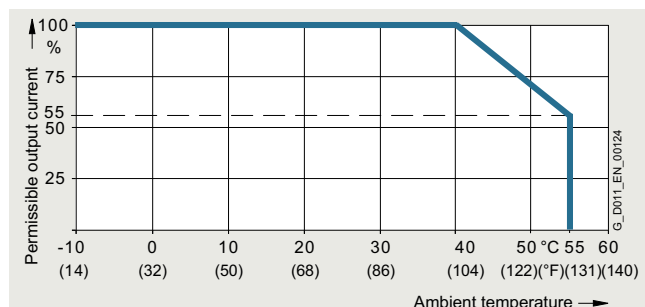

Permissible output current as a function of ambient temperature for PM250D Power Modules, frame sizes FSA to FSC

The operating temperature ranges of the Control Units should be taken into account. The temperature ranges are specified in the technical specifications under Control Units.

Installation altitude

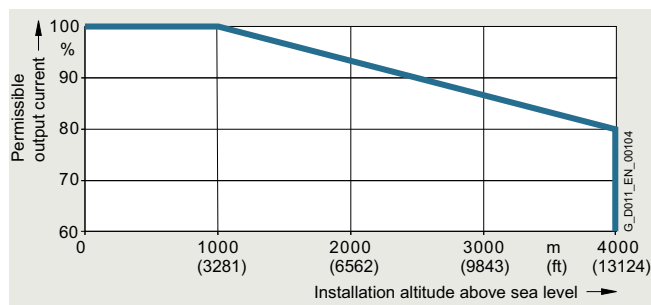

Permissible output current as a function of installation altitude for PM250D Power Modules, frame sizes FSA to FSC

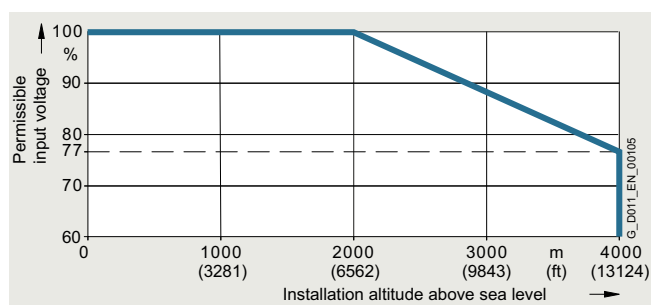

Permissible input voltage as a function of installation altitude for PM250D Power Modules, frame sizes FSA to FSC

¹⁾ It is not possible to make any assignment to a particular standard.

SINAMICS G120D distributed converters

0.75 kW to 7.5 kW (1 hp to 10 hp)

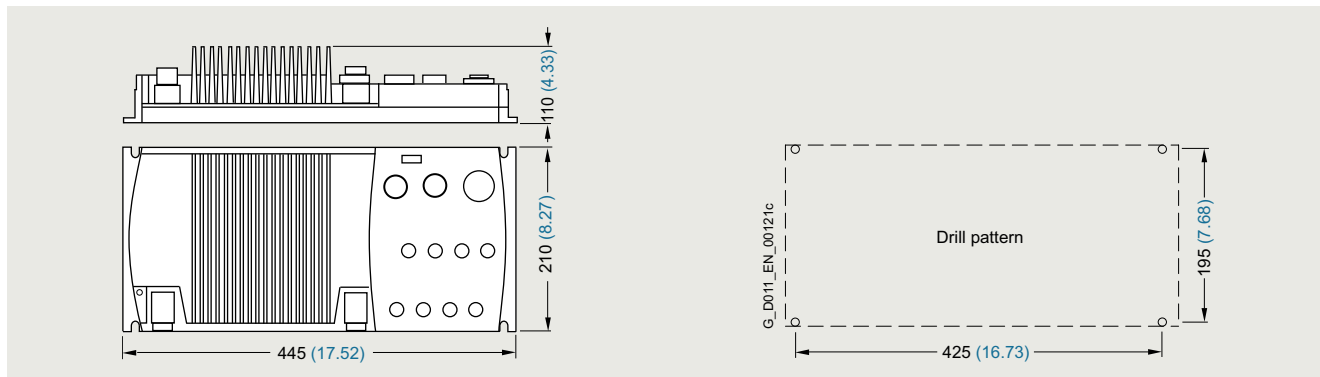
PM250D Power Modules**Dimensional drawings**

PM250D Power Module, frame size FSA, with integrated line filter class A and mounted Control Unit

With a CU2x0D-2 PN-F PP Control Unit, the height increases to 128.3 mm (5.05 inches).

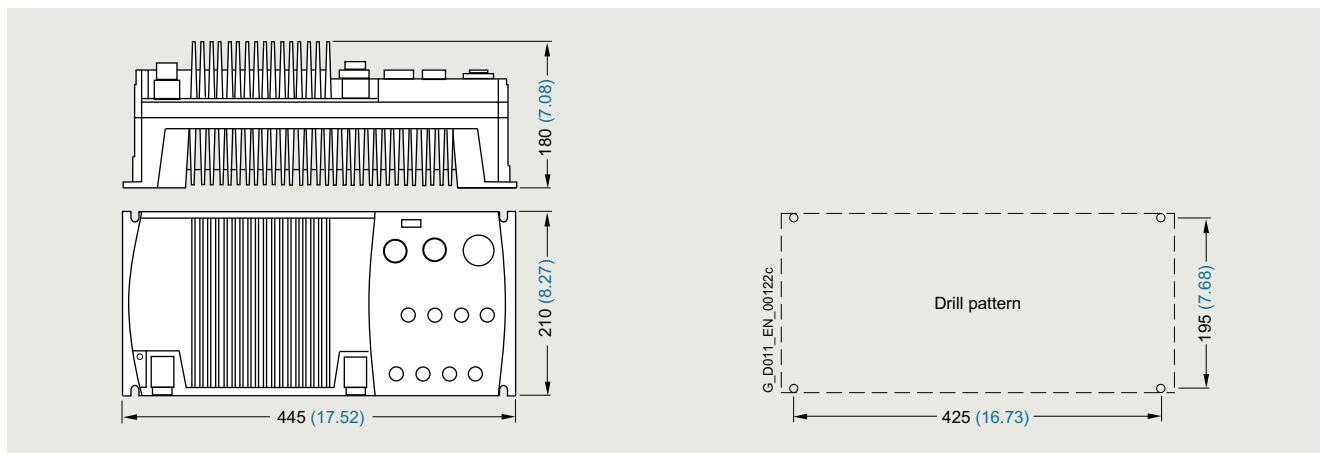

PM250D Power Module, frame size FSB, with integrated line filter class A and mounted Control Unit

With a CU2x0D-2 PN-F PP Control Unit, the height increases to 198.3 mm (7.81 inches).

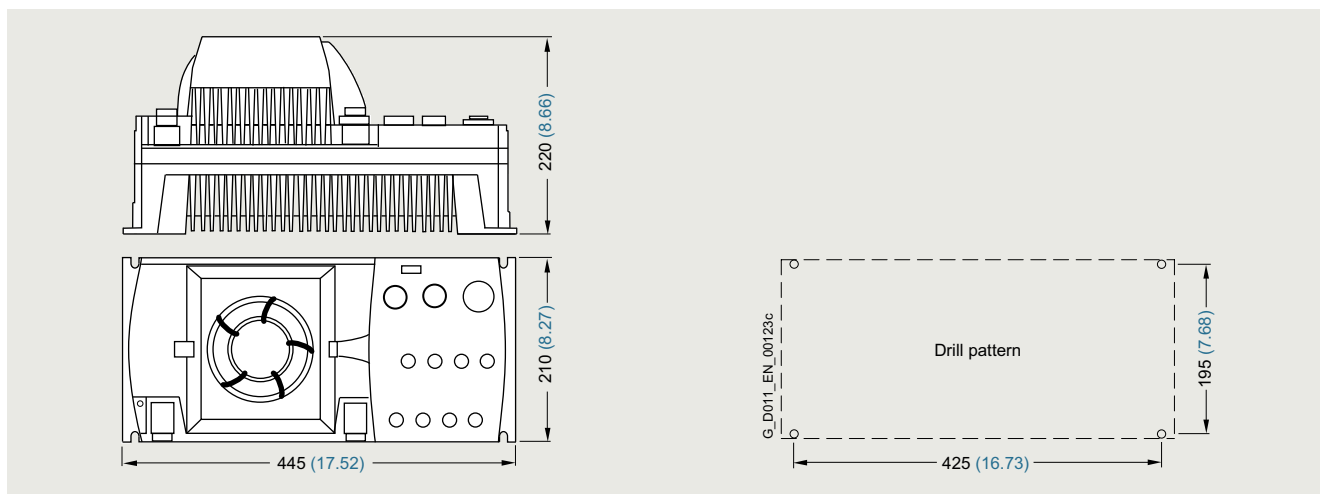

PM250D Power Module, frame size FSC, with integrated line filter class A and mounted Control Unit

Mounted with M5 or M6 screwed joints with a maximum washer diameter of 12 mm (0.47 inches).

3 mm (0.12 inches) Allen screw for the Control Unit.

Ventilation clearance required (for wall mounting) at top and bottom: 150 mm (5.9 inches).

All dimensions in mm (values in brackets are in inches).

Clicking to SiePortal

6SL3255-0AA00-5AA0



SINAMICS G120D distributed converters

0.75 kW to 7.5 kW (1 hp to 10 hp)

Recommended line-side power components

Selection and ordering data

The following table lists recommendations for additional line-side components, such as fuses and circuit breakers.

Note for use in compliance with IEC standards:

3NA3 type fuses and 3RV type circuit breakers are recommended for European countries. The values in the table take into account the overload capability of the converter.

Note for use in compliance with UL regulations:

Fuses for use in North America must be UL-certified, Class J fuses with a rated voltage of 600 V AC.

Short Circuit Current Rating (SCCR)

according to UL

Applies to industrial control panel installations according to NEC Article 409 or UL 508A

- PM250D: 100 kA (480 V 3 AC)

Additional information about the listed fuses and circuit breakers is available in the Catalogs LV 10, IC 10 and IC 10 AO as well as in SiePortal.

Individual protection

Rated power		SINAMICS G120D PM250D Power Modules		IEC-compliant				UL-compliant (according to UL category JDDZ)	
kW	hp	Type 6SL3525-...	Frame size	Fuse		Circuit breaker	Fuse type		
				Current A	Article No.		Rated voltage 600 V AC	Current A	
380 ... 500 V 3 AC									
0.75	1	0PE17-5AA1	FSA	10	3NA3803	3RV2011-1JA10	J	10	
1.5	1.5 ¹⁾	0PE21-5AA1	FSA	10	3NA3803	3RV2011-1JA10	J	15	
3	4	0PE23-0AA1	FSB	16	3NA3805	3RV2011-4AA10	J	25	
4	5	0PE24-0AA1	FSC	20	3NA3807	3RV2021-4BA10	J	35	
5.5	7.5	0PE25-5AA1	FSC	20	3NA3807	3RV2021-4BA10	J	45	
7.5	10	0PE27-5AA1	FSC	32	3NA3812	3RV2021-4PA10	J	60	

Group protection (installation on power bus)

For installations with several converters, the converters are normally supplied from a 400 V power bus. Further information can be found in the operating instructions on the internet at www.siemens.com/sinamics-g120d/documentation

¹⁾ It is not possible to make any assignment to a particular standard.

SINAMICS G120D distributed converters

0.75 kW to 7.5 kW (1 hp to 10 hp)

Supplementary system components

Accessories

For SINAMICS G120D distributed frequency converters, the following supplementary system components are always required or are available depending on the intended application.

Designation	Order	See page
IOP-2 Handheld Intelligent Operator Panel ¹⁾ • RS232 connecting cable ¹⁾	Application-dependent Application-dependent	8/31 8/31
Memory cards	Application-dependent	8/32
PC converter connection kit 2 (mini USB interface cable for communication with a PC)	Application-dependent	8/32
STARTER commissioning tool	Application-dependent	8/32
SINAMICS Startdrive commissioning tool	Application-dependent	8/32
Connecting cables for the Control Unit • PROFINET connecting cable	Application-dependent	8/33
• Connecting cables/connectors for supplying the Control Unit with 24 V DC power	Always required	8/33
• Connecting cables and connectors for digital inputs and outputs	Application-dependent	8/34
• Connecting cables and connectors for encoders and analog inputs	Application-dependent	8/34
Connecting cables for Power Modules • Connecting cables pre-assembled at one end and connector sets to connect to the line supply	Always required	8/34
• Motor cables pre-assembled at one end and connector sets to connect the Power Module to the motor	Always required	8/35
• Power bus distribution 400 V in IP65 degree of protection	Application-dependent	8/35

¹⁾ For use of the IOP-2 Handheld in combination with SINAMICS G120D and SIMATIC ET 200pro FC-2, the RS232 connecting cable with optical interface is required (Article No.: 3RK1922-2BP00). The cable must be ordered separately.

Clicking to SiePortal

6SL3255-0AA00-5AA0



SINAMICS G120D distributed converters

0.75 kW to 7.5 kW (1 hp to 10 hp)

Supplementary system components

Accessories

IOP-2 Handheld Intelligent Operator Panel



IOP-2 Handheld for mobile use

The IOP-2 Handheld Intelligent Operator Panel is a very user-friendly and powerful operator panel for commissioning and diagnostics as well as local operator control and monitoring of SINAMICS G120D and SIMATIC ET 200pro FC-2 distributed converters.

The IOP-2 Handheld supports both newcomers and drive experts. Thanks to the membrane keyboard with a central sensor control field, the high-contrast color displays, the menu-based operation and the application wizards, it is easy to commission standard drives. A drive can be essentially commissioned without having to use a printed parameter list – as the parameters are displayed in plain text, and explanatory help texts and a parameter filtering function are provided.

Application wizards interactively guide you when commissioning important applications such as conveyor technology, pumps, fans and compressors. There is a basic commissioning wizard for general commissioning.

Up to two process values can be graphically visualized and up to four process values can be numerically visualized on the status screen/display. Process values can also be displayed in technological units.

The IOP-2 Handheld supports series commissioning of identical drives. For this purpose, a parameter list can be copied from a frequency converter into the IOP-2 Handheld and downloaded into other drive units of the same type as required.

In addition to the IOP-2, the IOP-2 Handheld includes a housing with rechargeable batteries, a charging unit, an RS232 connecting cable, and a USB cable. The charging unit is supplied with connector adapters for Europe, the US and UK. When the batteries are fully charged, the operating time is up to 10 hours.

To connect the IOP-2 Handheld to SINAMICS G120D and SIMATIC ET 200pro FC-2, the RS232 connecting cable with optical interface is required in addition.

Updating the IOP-2 Handheld

The IOP-2 Handheld can be updated and expanded using the integrated USB interface.

Data to support future drive systems can be transferred from the PC to the IOP-2 Handheld. Further, the USB interface allows user languages and wizards that will become available in the future to be subsequently downloaded and the firmware to be updated for the IOP-2 Handheld ¹⁾.

Description	Article No.
IOP-2 Handheld For use with SINAMICS G120 SINAMICS G120C SINAMICS G120P SINAMICS G120D SIMATIC ET 200pro FC-2 Included in the scope of delivery: <ul style="list-style-type: none"> • IOP-2 • Handheld housing • Rechargeable batteries (4 × AA) • Charging unit (international) • RS232 connecting cable 3 m (9.84 ft) long, can be used in combination with SINAMICS G120 SINAMICS G120C SINAMICS G120P • USB cable 1 m (3.28 ft) long 	6SL3255-0AA00-4HA1
RS232 connecting cable 2.5 m (8.20 ft) long, with optical interface for connecting the IOP-2 Handheld to SINAMICS G120D SIMATIC ET 200pro FC-2	3RK1922-2BP00

IOP-2 Handheld 6SL3255-0AA00-4HA1	
Display	High-contrast color display, a variety of display options
<ul style="list-style-type: none"> • Resolution 	320 × 240 Pixel
Operator panel	Membrane keyboard with central sensor control field
Operating languages	English, German, French, Italian, Spanish, Portuguese, Dutch, Swedish, Finnish, Russian, Czech, Polish, Turkish, Chinese Simplified
Ambient temperature	
<ul style="list-style-type: none"> • During transport and storage • During operation 	-20 ... +55 °C (-4 ... +131 °F) 0 ... 40 °C (32 ... 104 °F)
Humidity	Relative humidity < 95 %, non-condensing
Degree of protection	IP20
Dimensions (H × W × D)	195.04 × 70 × 37.58 mm (7.68 × 2.76 × 1.48 in)
Weight, approx.	0.724 kg (1.6 lb)
Compliance with standards	CE, UKCA, RCM, cULus, EAC, KC-REM-S49-SINAMICS

¹⁾ Information on updates for the IOP-2 Handheld is available at <https://support.industry.siemens.com/cs/document/67273266>

SINAMICS G120D distributed converters

0.75 kW to 7.5 kW (1 hp to 10 hp)

Clicking to SiePortal

6SL3255-0AA00-5AA0

Supplementary system components

Accessories

Memory cards



SINAMICS SD memory card

The parameter settings for a converter can be stored on the SINAMICS SD memory card. In case of service, e.g. after exchanging a converter and importing the data from the memory card, the system is immediately ready for operation again

- Parameter settings can be written from the memory card to the converter or saved from the converter to the memory card.
- Up to 100 parameter sets can be stored.
- The memory card supports series commissioning without the use of the Intelligent Operator Panel IOP-2 Handheld or the STARTER and SINAMICS Startdrive commissioning tools.
- If firmware is stored on the memory card and a Control Unit is installed, the firmware can be upgraded/downgraded during power-up ¹⁾

Note:

The memory card is optional, but it facilitates converter replacement.

Description	Article No.
SINAMICS SD card 512 MB	6SL3054-4AG00-2AA0
Optional firmware memory cards	
SINAMICS SD card 512 MB + firmware V4.7 SP13 (Multicard V4.7 SP13)	6SL3054-7TG00-2BA0
SINAMICS SD card 512 MB + firmware V4.7 SP14 (Multicard V4.7 SP14)	6SL3054-7TH00-2BA0

More information on firmware V4.7 SP14:

<https://support.industry.siemens.com/cs/document/109817231>

For an overview and more information on all available firmware versions, see

<https://support.industry.siemens.com/cs/document/67364620>

PC converter connection kit 2 (mini USB interface cable for communication with a PC)

For controlling and commissioning a converter directly from a PC via a point-to-point connection if the appropriate software (STARTER commissioning tool ²⁾, V4.3 and higher, or SINAMICS Startdrive) has been installed.

Description	Article No.
PC converter connection kit 2 USB cable (3 m/9.84 ft long) for	6SL3255-0AA00-2CA0
• SINAMICS G120C	
• SINAMICS G120 Control Units	
- CU230P-2	
- CU240E-2	
- CU250S-2	
• SINAMICS G115D	
• SINAMICS G120D Control Units	
- CU240D-2	
- CU250D-2 (except for variant PP (Push Pull))	

STARTER commissioning tool

The STARTER commissioning tool (V4.3 and higher) supports the commissioning and maintenance of SINAMICS G120D converters. The operator guidance combined with comprehensive, user-friendly functions for the relevant drive solution allow you to commission the device quickly and easily.

Description	Article No.
STARTER commissioning tool ²⁾ on DVD-ROM	6SL3072-0AA00-0AG0

SINAMICS Startdrive commissioning tool

The SINAMICS Startdrive commissioning tool (V13 and higher) supports the commissioning and maintenance of SINAMICS G120D converters. SINAMICS Startdrive is part of the TIA Portal engineering platform. It supports the intuitive integration of SINAMICS drives in automation. The same operator control concept, the elimination of interfaces and a high degree of user-friendliness make it possible to quickly integrate SINAMICS into an automation process and start it up with the TIA Portal. The TIA Portal with SINAMICS Startdrive offers you a totally integrated engineering platform for the complete application from the project engineering phase through to commissioning and diagnostics.

Description	Article No.
SINAMICS Startdrive commissioning tool ³⁾	6SL3072-4LA02-0XG0

¹⁾ You can find more information about firmware upgrades/downgrades on the internet at <https://support.industry.siemens.com/cs/document/67364620>

²⁾ STARTER commissioning tool is also available on the internet at www.siemens.com/starter

³⁾ The SINAMICS Startdrive Basic commissioning tool is available free on the internet at www.siemens.com/startdrive

Clicking to SiePortal

6SL3255-0AA00-5AA0



SINAMICS G120D distributed converters

0.75 kW to 7.5 kW (1 hp to 10 hp)

Supplementary system components

Accessories

An overview of all available accessories (e.g. plugs and cables) can be found under the following link:
www.siemens.com/distributeddrives-supplementaryproducts

Connecting cables for the Control Unit

PROFINET connecting cable

Flexible plug-in cables and plug-in connectors that can be assembled in the field for transmission of data (up to 100 Mbps) between Industrial Ethernet stations with IP65 degree of protection.

Description	Article No.
IE connecting cable M12-180/M12-180 Pre-assembled IE FC TP trailing cable GP 2 x 2 PROFINET type C with two 4-pole M12 plugs (4-pole, D-coded), IP65/IP67 degree of protection, UL, plug/plug connector (IN/OUT) Length: <ul style="list-style-type: none"> • 0.3 m (0.98 ft) • 0.5 m (1.64 ft) • 1 m (3.28 ft) • 1.5 m (4.92 ft) • 2 m (6.56 ft) • 3 m (9.84 ft) • 5 m (16.4 ft) • 10 m (32.8 ft) • 15 m (49.2 ft) 	6XV1870-8AE30 6XV1870-8AE50 6XV1870-8AH10 6XV1870-8AH15 6XV1870-8AH20 6XV1870-8AH30 6XV1870-8AH50 6XV1870-8AN10 6XV1870-8AN15
IE M12 Plug PRO For assembly in the field, M12 plug-in connector (D-coded), metal enclosure, UL, fast connection method, plug connector <ul style="list-style-type: none"> • 1 unit • 8 units • 1 unit (angled) 	6GK1901-0DB20-6AA0 6GK1901-0DB20-6AA8 3RK1902-2DA00
RJ45 PLUG PRO connector For on-site assembly for CU240D-2 PN-F PP or CU250D-2 PN-F PP Control Unit, UL 1 package = 1 unit <ul style="list-style-type: none"> • 1 unit 	6GK1901-1BB10-6AA0
Plugs for fiber-optic cables POF/PCF plug-in connectors for assembly in the field <ul style="list-style-type: none"> • IE SC RJ POF PLUG PRO (1 unit) • IE SC RJ PCF PLUG PRO (1 unit) 	6GK1900-0MB00-6AA0 6GK1900-0NB00-6AA0

Connecting cables/connectors for supplying the Control Unit with 24 V DC power

Description	Article No.
7/8" plug-in cable For power supply, pre-assembled with two 5-pole 7/8" plug/socket connectors, UL 5 x 1.5 mm ² Length: <ul style="list-style-type: none"> • 0.3 m (0.98 ft) • 0.5 m (1.64 ft) • 1 m (3.28 ft) • 1.5 m (4.92 ft) • 2 m (6.56 ft) • 3 m (9.84 ft) • 5 m (16.4 ft) • 10 m (32.8 ft) • 15 m (49.2 ft) 	6XV1822-5BE30 6XV1822-5BE50 6XV1822-5BH10 6XV1822-5BH15 6XV1822-5BH20 6XV1822-5BH30 6XV1822-5BH50 6XV1822-5BN10 6XV1822-5BN15
7/8" plug-in connector 5-pole, B-coded, plastic enclosure, 1 package = 5 units <ul style="list-style-type: none"> • Pin insert (OUT) • Socket insert (IN) 	6GK1905-0FA00 6GK1905-0FB00
POWER PLUG PRO plug-in connector for the CU2x0D-2 PN-F PP 5-pole push-pull power plug, metal enclosure, for on-site assembly 1 package = 1 unit <ul style="list-style-type: none"> • 1 unit 	6GK1907-0AB11-6AA0

SINAMICS G120D distributed converters

0.75 kW to 7.5 kW (1 hp to 10 hp)

Clicking to SiePortal

6SL3255-0AA00-5AA0



Supplementary system components

Accessories

Connecting cables and connectors for digital inputs and outputs

Description	Article No.
M12 plug-in cable With PUR sheath, to connect digital sensors and actuators, pre-assembled at one end, angled, plug connector, 5-pole, 5 × 0.34 mm ² , UL Length: <ul style="list-style-type: none"> • 1.5 m (4.92 ft) • 5 m (16.4 ft) • 10 m (32.8 ft) 	3RK1902-4HB15-5AA0 3RK1902-4HB50-5AA0 3RK1902-4HC01-5AA0
M12 plug For screw mounting, 5-pole screw-type connection max. 0.75 mm ² , A-coded, max. 4 A, UL, plug connector <ul style="list-style-type: none"> • Straight • Angled 	3RK1902-4BA00-5AA0 3RK1902-4DA00-5AA0

Connecting cables and connectors for encoders and analog inputs

Description	Order (see Product Partner)
M12 cable connector 8-pole plug connector <ul style="list-style-type: none"> • Straight cable outlet • Angled cable outlet 	Ordered from and supplied by KnorrTec Ordered from and supplied by KnorrTec
M12 plug-in cable Pre-assembled at one end, straight, plug connector, 8-pole, 4 × 2 × AWG24, shielded, PUR gray, suitable for trailing cables, for HTL and SSI encoders Length: <ul style="list-style-type: none"> • 1.5 m (4.92 ft) • 5 m (16.4 ft) • 10 m (32.8 ft) 	Ordered from and supplied by KnorrTec Ordered from and supplied by KnorrTec Ordered from and supplied by KnorrTec
M12 plug-in cable Pre-assembled at both ends, 8-pole M12 contact pin to 12-pole M23 socket, 4 × 2 × AWG24, shielded, PUR gray, suitable for trailing cables <ul style="list-style-type: none"> • HTL plug-in cable • SSI plug-in cable Length: <ul style="list-style-type: none"> • 1.5 m (4.92 ft) • 5 m (16.4 ft) • 10 m (32.8 ft) 	Ordered from and supplied by KnorrTec Ordered from and supplied by KnorrTec Ordered from and supplied by KnorrTec
T distribution piece To connect two analog inputs 8-pole M12 contact pin to 2 × 4-pole M12 socket, angled	Ordered from and supplied by KnorrTec

Connecting cables for Power Modules

Connecting cables pre-assembled at one end and connector sets to connect to the line supply

Description	Article No.
Connecting cable pre-assembled at one end Power supply cable, open at one end, for Q4/2, angled, 4 × 4 mm ² <ul style="list-style-type: none"> • 1.5 m (4.92 ft) long • 5 m (16.4 ft) long 	3RK1911-0DB13 3RK1911-0DB33
Connector set for the power supply Q4/2 <ul style="list-style-type: none"> • 2.5 mm² • 4 mm² • 6 mm² 	3RK1911-2BE50 3RK1911-2BE10 3RK1911-2BE30

Clicking to SiePortal

6SL3255-0AA00-5AA0



SINAMICS G120D distributed converters

0.75 kW to 7.5 kW (1 hp to 10 hp)

Supplementary system components

Accessories

Motor cables pre-assembled at one end and connector sets to connect the Power Module to the motor

Motor cables pre-assembled at one end for motors with brake and temperature sensor with Q8 plug, shielded	Article No. (HTG: supplied by Harting) (ZKT: supplied by KnorrTec)		
	4 × 1.5 mm ² 2 × (2 × 0.75 mm ²)	4 × 2.5 mm ² 2 × (2 × 0.75 mm ²)	4 × 4 mm ² 2 × 1 mm ² + 2 × 1.5 mm ²
• 1.5 m (4.92 ft) long	HTG: 61 88 201 0288 ZKT: 70020501000150	HTG: 61 88 201 0291 ZKT: 70009601000150	HTG: 61 88 201 0303 ZKT: 70017001000150
• 3 m (9.84 ft) long	HTG: 61 88 201 0289 ZKT: 70020501000300	HTG: 61 88 201 0292 ZKT: 70009601000300	HTG: 61 88 201 0304 ZKT: 70017001000300
• 5 m (16.4 ft) long	HTG: 61 88 201 0290 ZKT: 70020501000500	HTG: 61 88 201 0293 ZKT: 70009601000500	HTG: 61 88 201 0305 ZKT: 70017001000500
• 10 m (32.8 ft) long	HTG: 61 88 201 0299 ZKT: 70020501001000	HTG: 61 88 201 0301 ZKT: 70009601001000	HTG: 61 88 201 0306 ZKT: 70017001001000
Connector set for motor cable Q8, shielded	HTG: 61 83 401 0131 ZKT: 10032001	HTG: 61 83 401 0132 ZKT: 10032011	HTG: 61 83 401 0133 ZKT: 10032021

Power bus distribution 400 V in IP65 degree of protection

Description	Ordering (see Product Partner)
Power T clamp connector for 2.5 ... 6 mm² With attached 7-pole plug, socket insert, grommet housing, UL Seals for various cable cross-sections must be ordered separately	Ordered from and supplied by Harting
T clamp connector Completely pre-assembled	Ordered from and supplied by KnorrTec
T distributor box, IDC connection power cable Pre-assembled, UL, uncut power cable, 2.5 ... 6 mm ² Push-in connection: 1.5 ... 6 mm ² Seals for various cable cross-sections must be ordered separately	Ordered from and supplied by Weidmüller
Y distributor For direct connection of 400 V supply line Q4/2, conductor cross-section 1.5 ... 4 mm ²	Ordered from and supplied by Harting

More information

A comprehensive range of supplementary products is provided for the distributed drive technology, e.g. pre-assembled cables and connectors. An overview is provided at the following link:
www.siemens.com/distributeddrives-supplementaryproducts

For more information about the connecting cables and plug-in connectors, please refer to Catalog IK PI.

SINAMICS G120D distributed converters

0.75 kW to 7.5 kW (1 hp to 10 hp)

[Clicking to SiePortal](#)

6SL3255-0AA00-5AA0

**Spare parts > Spare parts kit****Overview**

A spare parts kit can be ordered, comprising small parts such as replacement seals, caps and screws.

Selection and ordering data

Description	Article No.
Spare parts kit for SINAMICS G120D Comprising replacement seals, caps and screws	6SL3500-0SK01-0AA0
Replacement caps for CU2x0D-2 PN-F PP	
• 24 V push-pull PLUG PRO caps 1 package = 5 units	6ES7194-4JA50-0AA0
• RJ45 PLUG PRO caps 1 package = 5 units	6ES7194-4JD50-0AA0

Spare parts > Replacement fans**Overview**

The Power Module fans are designed for extra long service life. Replacement fans can be ordered for special applications. In case of a replacement for frame size FSC, a replacement fan which comprises a pre-mounted unit with cover, fan and screws can be ordered.

Selection and ordering data

Rated power		SINAMICS G120D PM250D Power Module		Replacement fan (pre-mounted unit with cover, fan and screws)
kW	hp	Type 6SL3525-...	Frame size	Article No.
380 ... 500 V 3 AC				
4	5	OPE24-0AA1	FSC	6SL3500-0SF01-0AA0
5.5	7.5	OPE25-5AA1		
7.5	10	OPE27-5AA1		

SIMATIC ET 200pro FC-2 frequency converters 1.5 kW (2 hp)



- 9/2 **Introduction**
- 9/2 Application
- 9/2 More information

- SIMATIC ET 200pro FC-2
frequency converters**
- 9/3 Overview
- 9/3 Selection and ordering data
- 9/4 Benefits
- 9/4 Application
- 9/5 Design
- 9/6 Integration
- 9/7 Technical specifications
- 9/8 Characteristic curves
- 9/8 Dimensional drawings
- 9/9 Accessories
- 9/10 More information

Further information about
SIMATIC ET 200pro FC-2
can be found in Catalog ST 70

SIMATIC ET 200pro FC-2 frequency converters

1.5 kW (2 hp)

Introduction

Application

Use	Requirements for torque accuracy/speed accuracy/position accuracy/coordination of axes/functionality					
	Continuous motion			Non-continuous motion		
	Basic	Medium	High	Basic	Medium	High
Pumping, ventilating, compressing	Centrifugal pumps Radial / axial fans Compressors	Centrifugal pumps Radial / axial fans Compressors	Eccentric screw pumps	Hydraulic pumps Metering pumps	Hydraulic pumps Metering pumps	Descaling pumps Hydraulic pumps
	V20 G120C G120X	G120X G130/G150 G180 ¹⁾ DCM	G220 S120	G120/G220	S110	S120
Moving	Conveyor belts Roller conveyors Chain conveyors	Conveyor belts Roller conveyors Chain conveyors Lifting/lowering devices Elevators Escalators/moving walkways Indoor cranes Marine drives Cable railways	Elevators Container cranes Mining hoists Excavators for open-cast mining Test bays	Acceleration conveyors Storage and retrieval machines	Acceleration conveyors Storage and retrieval machines Cross cutters Reel changers	Storage and retrieval machines Robotics Pick & place Rotary indexing tables Cross cutters Roll feeds Engagers/disengagers
	V20 G115D G120C ET 200pro FC-2 ²⁾	G120/G220 G120D G130/G150 G180 ¹⁾	G220 S120 S150 DCM	V90 S200 G120/G220 G120D	S110 S210 DCM	S120 S210 DCM
Processing	Mills Mixers Kneaders Crushers Agitators Centrifuges	Mills Mixers Kneaders Crushers Agitators Centrifuges Extruders Rotary furnaces	Extruders Winders/unwinders Lead/follower drives Calenders Main press drives Printing machines	Tubular bagging machines Single-axis motion control such as • Position profiles • Path profiles	Tubular bagging machines Single-axis motion control such as • Position profiles • Path profiles	Servo presses Rolling mill drives Multi-axis motion control such as • Multi-axis positioning • Cams • Interpolations
	V20 G120C	G120/G200 G130/G150 G180 ¹⁾	G220 S120 S150 DCM	V90 S200 G120/G220	S110 S210	S120 S210 DCM
Machining	Main drives for • Turning • Milling • Drilling	Main drives for • Drilling • Sawing	Main drives for • Turning • Milling • Drilling • Gear cutting • Grinding	Axis drives for • Turning • Milling • Drilling	Axis drives for • Drilling • Sawing	Axis drives for • Turning • Milling • Drilling • Lasering • Gear cutting • Grinding • Nibbling and punching
	S110	S110 S120	S120	S110	S110 S120	S120

The SIMATIC ET 200pro FC-2 frequency converter for a cabinet-free configuration with a high IP65 degree of protection and a power rating of up to 1.5 kW designed as a SIMATIC module, with an integrated safety function and regenerative feedback capability. It supplements the SIMATIC ET 200pro system range with distributed, speed-controlled drives. The frequency converter offers, in combination with the other modules of the modular SIMATIC ET 200pro system, solutions which have been exactly tailored to the plant/system.

Practical application examples and descriptions are available on the internet at www.siemens.com/sinamics-applications

More information

You may also be interested in these frequency converters::

- Horizontal distributed conveyor-related applications, degree of protection up to IP66 ⇒ SINAMICS G115D
- With positioning function in degree of protection IP65 ⇒ SINAMICS G120D
- More performance, higher functionality for the control cabinet in IP20 degree of protection ⇒ SINAMICS G120, SINAMICS G120C
- With positioning function in the control cabinet in IP20 degree of protection ⇒ SINAMICS S110

¹⁾ Industry-specific converters.

²⁾ Information on the SIMATIC ET 200pro FC-2 frequency converter is available at www.siemens.com/et200pro-fc

Clicking to SiePortal

6SL3255-0AA00-5AA0



SIMATIC ET 200pro FC-2 frequency converters

1.5 kW (2 hp)

SIMATIC ET 200pro FC-2 frequency converters

Overview



SIMATIC ET 200pro FC-2 frequency converters

The SIMATIC ET 200pro FC-2 frequency converter has the design of a SIMATIC ET 200pro module. It supplements the SIMATIC ET 200pro system range with distributed, speed-controlled drives. It is suitable for the open-loop and closed-loop control of asynchronous (induction) motors in a wide range of industrial applications. It is predestined for conveyor technology applications using drives networked via PROFIBUS and PROFINET, in particular in distributed designs without control cabinet with high degree of protection (IP65), when combining several drives. The modular, service-friendly concept is ideally suited to manufacturing processes with high plant standstill costs.

Reasons for using distributed drive systems

- Modular drive solutions – therefore standardized mechatronic elements that can be individually tested
- A control cabinet is not required, resulting in a smaller space requirement and lower cooling requirements
- Long motor cables between converter and motor are not required
 - Less power losses
 - Reduced noise radiation
 - Reduced costs for shielded cables
 - No additional filters
- Distributed configurations offer considerable benefits for conveyor systems with their extensive coverage (e.g. in the automotive and logistics sectors)

Siemens family of distributed drives

Siemens offers an innovative portfolio of frequency converters to optimally implement distributed drive solutions. The strengths of the individual members of the drive family permit simple adaptation to the widest range of application demands:

- Identical connection systems
- User-friendly commissioning and configuration tools

Products from the family of distributed drives:

- SINAMICS G115D distributed frequency converters
- SINAMICS G120D frequency converters
- SIMATIC ET 200pro FC-2 frequency converters
- SIRIUS M200D motor starters

Safety Integrated

The distributed SIMATIC ET 200pro FC-2 frequency converters are already equipped with the integrated STO (Safe Torque Off) safety function, certified in accordance with IEC 61508 SIL 2 as well as ISO 13849-1 PL d and Category 3. It can be activated locally via the F-RSM or by means of PROFIsafe.

STARTER commissioning tool

The STARTER commissioning tool (V4.4 and higher) plus the corresponding SINAMICS Support Package (SSP) supports the commissioning and maintenance of SIMATIC ET 200pro FC-2 frequency converters.

The operator guidance combined with comprehensive, user-friendly functions for the relevant drive solution allow you to commission the device quickly and easily.

Engineering Framework STEP7 classic (V5.5 and higher)

Hardware Support Packages (HSP) are available to integrate SIMATIC ET 200pro FC-2 in STEP7 classic.

Engineering Framework TIA Portal (as from V13 SP1)

TIA Portal is a powerful engineering framework providing full access to the whole digitized automation.

Hardware Support Packages (HSP) are available to integrate SIMATIC ET 200pro FC-2 in TIA Portal.

Selection and ordering data

	Article No.
SIMATIC ET 200pro FC-2 frequency converter with integrated safety function STO (Safe Torque Off)	6SL3514-1KE13-5AE0
Backplane bus module for mounting the frequency converter (absolutely essential for operation of the converter)	6SL3260-2TA00-0AA0

SIMATIC ET 200pro FC-2 frequency converters

1.5 kW (2 hp)

SIMATIC ET 200pro FC-2 frequency converters

Benefits

- Quick and easy installation
 - Flexibility as SIMATIC ET 200pro modules can be freely combined with the frequency converter
 - No wiring outlay due to self-assembling communication and supply rails in the backplane bus with each additional module
 - The load voltage is routed to downstream frequency converters or motor starters with minimal installation costs through pre-assembled power jumper plugs (max. 25 A).
- Accelerated engineering, fast installation and commissioning
 - Easy combination and expansion of converter functionality using I/O modules or RSM isolator modules within the distributed station
 - Module replacement possible without interrupting communication to the SIMATIC ET 200pro station and the other modules within SIMATIC ET 200pro
 - No configuration effort required or reduction of space requirements and installation expenditure for the braking resistor due to line-commutated energy recovery
 - Parameter assignment via IOP-2 Handheld, STARTER and optional memory card as parameter storage medium
 - Standard mini USB interface for commissioning
- Low-cost and uniform solutions
 - Communication via PROFIBUS and PROFINET (copper or POF fiber-optic cables) including the corresponding interface module
 - Safety Integrated functionality (STO) already integrated as standard
 - Activation of the fail-safe function (STO) of the frequency converter locally via the Safety Local isolator module F-RSM or via PROFIsafe with the F-Switch PROFIsafe module

Application

- The frequency converter controls the speed of induction motors steplessly.
- The modular, service-friendly concept of the frequency converter is ideally suited to manufacturing processes with high plant standstill costs.
- Ideal solutions can be created using several frequency converters combined in one distributed station when drives are operated in the same area or for the same purposes.
- The frequency converter handles both frequency control for simple applications and sensorless vector control (SLVC) for more complex drive tasks. It also handles the optimum control of a motor brake, if used.
- The converter also supports torque control, for example, for applications with mechanically coupled drives.
- The benefits of regenerative feedback lie primarily in the reduction in configuring overhead (no braking resistor necessary), reduced installation costs and lower space requirements.
- The STO safety function integrated as standard significantly reduces the overhead for drive solutions in plant sections where there is a hazard potential.

SIMATIC ET 200pro FC-2 frequency converters 1.5 kW (2 hp)

SIMATIC ET 200pro FC-2 frequency converters

Design

The SIMATIC ET 200pro FC-2 distributed frequency converter is a compact frequency converter for standard drives which has the design of a SIMATIC ET 200pro module. Each SIMATIC ET 200pro FC-2 frequency converter includes both the Control Unit as well as the Power Module in one unit. In addition, there is a backplane bus module for integrating the frequency converter in the SIMATIC ET 200pro system bus.



SIMATIC ET 200pro FC-2 frequency converter

The SIMATIC ET 200pro FC-2 frequency converter supplements the SIMATIC ET 200pro system range with distributed, speed-controlled drives. The frequency converter offers, in combination with the other modules of the modular SIMATIC ET 200pro system, solutions which have been exactly tailored to the plant/system and allows, through the combination of several frequency converters in one distributed station, ideal solutions when drives are operated in the same area or for the same purposes.



SIMATIC ET 200pro station with two SIMATIC ET 200pro FC-2 converters

It is completely embedded in the SIMATIC ET 200pro system and offers all the system advantages such as cabinet-free installation, easy mounting on the module rack, reduction of the wiring outlay due to self-assembling communication and supply rails in the backplane bus, comprehensive diagnostic mechanisms and high availability thanks to replaceability without affecting other modules in the SIMATIC ET 200pro station.

The certified STO safety function integrated as standard ensures that persons and machines are protected from the dangerous movement of machines. Integration of the safety system into the drive also simplifies the machine architecture and supports system-wide diagnostics.

Active and dynamic braking of the motor is possible without incurring any additional costs. The generated braking energy is fed back into the power supply, so there is no need for a braking chopper and braking resistors. To ensure full motor protection, a temperature sensor of the PTC type, bimetal, KTY or Pt1000 can be connected. The integrated 180 V DC brake control at 400 V line voltage ($U_{\text{line}} \times 0.45 = \text{brake voltage}$) allows the direct activation of a motor holding brake and makes a rectifier in the motor terminal box superfluous.

In combination with an SD memory card, the slot for the optional memory card can be used to save the parameter settings in order to facilitate fast replacement of modules with automatic reparameterization.

SIMATIC ET 200pro FC-2 frequency converters use the control modes frequency control and sensorless vector control. The SIMATIC ET 200pro FC-2 frequency converter also supports torque control, for example, for applications with mechanically coupled drives. The innovative power unit concept capable of energy recovery helps save energy.

Options for parameter assignment:

- STARTER, the graphical parameterization tool for Siemens drives
- The fieldbus
- A point-to-point connection via a mini USB interface
- The optical interface for connection of an IOP-2 Handheld

A parameter set download from the SIMATIC controller is also possible.

SIMATIC ET 200pro FC-2 frequency converters

1.5 kW (2 hp)

SIMATIC ET 200pro FC-2 frequency converters

Integration

The distributed SIMATIC ET 200pro FC-2 frequency converters feature the following interfaces as standard:

- Line supply connection via Q4/2 (socket)
- Motor connection via Q8 (connector) including control of the motor brake and temperature sensor
- Power output via Q4/2 (connector) for looping the 400 V 3 AC further to a subsequent frequency converter or motor starter from the SIMATIC ET 200pro system

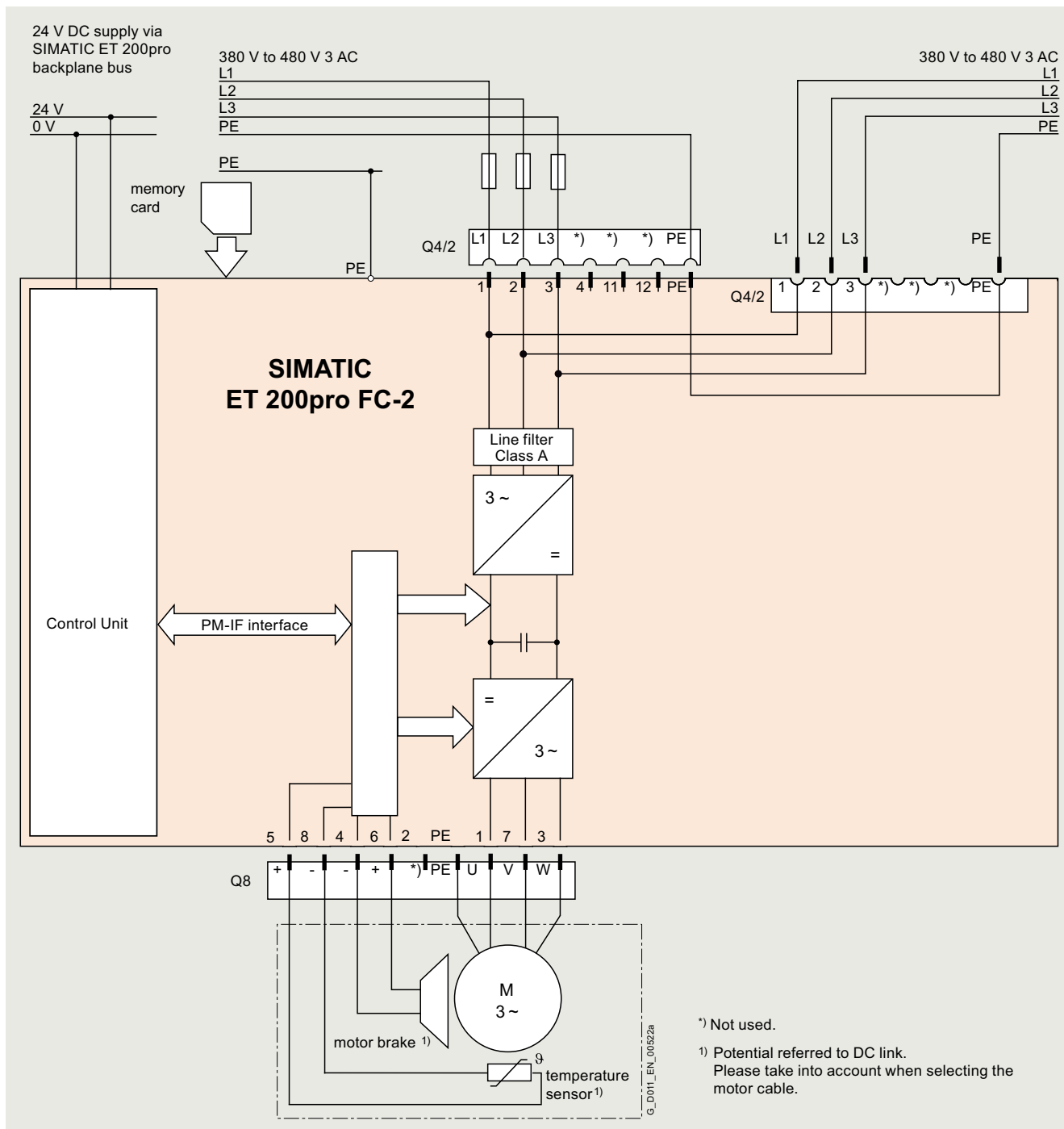

Connection example for SIMATIC ET 200pro FC-2

SIMATIC ET 200pro FC-2 frequency converters

1.5 kW (2 hp)

SIMATIC ET 200pro FC-2 frequency converters

Technical specifications

Distributed frequency converter	SIMATIC ET 200pro FC-2																		
Selection features																			
Integrated safety functions acc. to IEC 61508 SIL 2 and ISO 13849-1 PL d and Category 3	<ul style="list-style-type: none"> • Safe Torque Off (STO) • Control of the integrated safety function via the Safety Local isolator module F-RSM or via F-Switch PROFIsafe 																		
Electrical specifications																			
Line voltage	380 ... 480 V 3 AC ±10 %																		
Power	<ul style="list-style-type: none"> • With an ambient temperature of 0 ... 55 °C (32 °F ... 131 °F) 1.1 kW • With an ambient temperature of 0 ... 45 °C (32 °F ... 113 °F) 1.5 kW 																		
Rated input current/output current	<ul style="list-style-type: none"> • With an ambient temperature of 0 ... 55 °C (32 °F ... 131 °F) 2 A/3.5 A • With an ambient temperature of 0 ... 45 °C (32 °F ... 113 °F) 2.5 A/3.9 A 																		
Line frequency	47 ... 63 Hz																		
Overload capability	<ul style="list-style-type: none"> • Overload current 1.5 x rated output current (i.e. 150 % overload) for 60 s, cycle time 300 s • Overload current 2 x rated output current (i.e. 200 % overload) for 3 s, cycle time 300 s 																		
Output frequency	0 ... 550 Hz																		
Pulse frequency	4 kHz (standard), 4 ... 16 kHz (in 2-kHz increments)																		
Standard SCCR (Short Circuit Current Rating)	10 kA																		
Skipped frequency range	1, parameterizable																		
Converter efficiency	95 ... 97 %																		
Interfaces	<ul style="list-style-type: none"> • Connection to PROFIBUS and PROFINET over the SIMATIC ET 200pro backplane bus • Mini USB interface for commissioning via PC (as from STARTER V4.4 plus SSP) • Optical interface for commissioning via the IOP-2 Handheld • Slot for an optional memory card (SD) for uploading or downloading parameter settings. Facilitates easy device replacement. • PTC, bimetal, KTY84, Pt1000 interface for motor temperature monitoring 																		
Functions																			
Open-loop/closed-loop control methods	<ul style="list-style-type: none"> • V/f control – linear ($M \sim n$) with/without flux current control (FCC), quadratic ($M \sim n^2$) or parameterizable • Vector control – sensorless • Closed-loop torque control 																		
Operating functions	<ul style="list-style-type: none"> • Jogging • BICO technology • Automatic restart following interruptions in operation due to a power failure • Smooth connection of converter to rotating motor 																		
Braking functions	<ul style="list-style-type: none"> • Integrated regenerative feedback functionality • Control of an electromagnetic holding brake <p>Integrated brake control supplies DC power supply to the brake</p> <table border="1"> <tr> <td>Line voltage</td> <td>380 V AC</td> <td>400 V AC</td> <td>440 V AC</td> <td>480 V AC</td> </tr> <tr> <td>Rectified brake voltage</td> <td>171 V DC</td> <td>180 V DC</td> <td>198 V DC</td> <td>216 V DC</td> </tr> <tr> <td>Recommended brake coil voltage for Siemens motors</td> <td>170 ... 200 V DC</td> <td>170 ... 200 V DC 184 ... 218 V DC</td> <td>184 ... 218 V DC</td> <td>184 ... 218 V DC</td> </tr> </table> <p>Disconnection on the DC side permits "fast" braking.</p>				Line voltage	380 V AC	400 V AC	440 V AC	480 V AC	Rectified brake voltage	171 V DC	180 V DC	198 V DC	216 V DC	Recommended brake coil voltage for Siemens motors	170 ... 200 V DC	170 ... 200 V DC 184 ... 218 V DC	184 ... 218 V DC	184 ... 218 V DC
Line voltage	380 V AC	400 V AC	440 V AC	480 V AC															
Rectified brake voltage	171 V DC	180 V DC	198 V DC	216 V DC															
Recommended brake coil voltage for Siemens motors	170 ... 200 V DC	170 ... 200 V DC 184 ... 218 V DC	184 ... 218 V DC	184 ... 218 V DC															
Protection functions	<ul style="list-style-type: none"> • Undervoltage • Overvoltage • Ground fault • Short-circuit • Stall protection • Thermal motor protection (I^2t or sensor) • Converter overtemperature • Motor blocking protection • Phase failure detection 																		
Connectable motors	<ul style="list-style-type: none"> • Low-voltage asynchronous (induction) motors • Motor cable lengths: max. 15 m (49 ft) (shielded) 																		
Mechanical specifications																			
Degree of protection	IP65																		
Operating temperature	0 ... 55 °C (32 ... 131 °F)																		
Mounting position	Vertical wall mounting (vertical alignment of the cooling fins)																		
Dimensions (W × H × D)	155 mm × 246 mm × 248 mm (6.10 in × 9.69 in × 9.76 in)																		
Weight, approx.	4 kg (8.8 lb)																		
Standards																			
Certificates of suitability	UL508C, cUL, CE, UKCA, Low-Voltage Directive 2014/35/EU, EMC Directive 2014/30/EU																		

SIMATIC ET 200pro FC-2 frequency converters

1.5 kW (2 hp)

SIMATIC ET 200pro FC-2 frequency converters

Characteristic curves

Derating data

Pulse frequency

Ambient temperature °C	Rated output current in A at a pulse frequency of						
	4 kHz	6 kHz	8 kHz	10 kHz	12 kHz	14 kHz	16 kHz
0 ... 55 (1.1 kW)	3.5	2.8	2.2	1.6	1.1	0.5	0.0
0 ... 45 (1.5 kW)	3.9	3.9	3.9	3.6	3.3	2.7	2.2

Rated output current as a function of the pulse frequency

Installation altitude

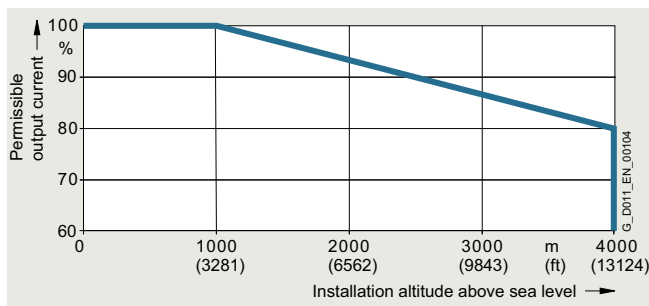

Permissible output current as a function of the installation altitude

Relationship between pulse frequency, temperature and output base-load current

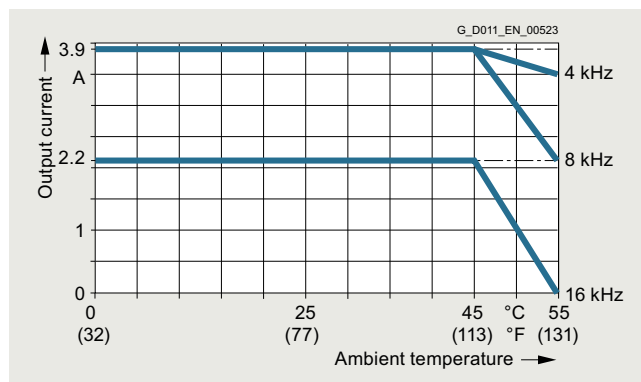

Output current as a function of the pulse frequency and ambient temperature

Dimensional drawings

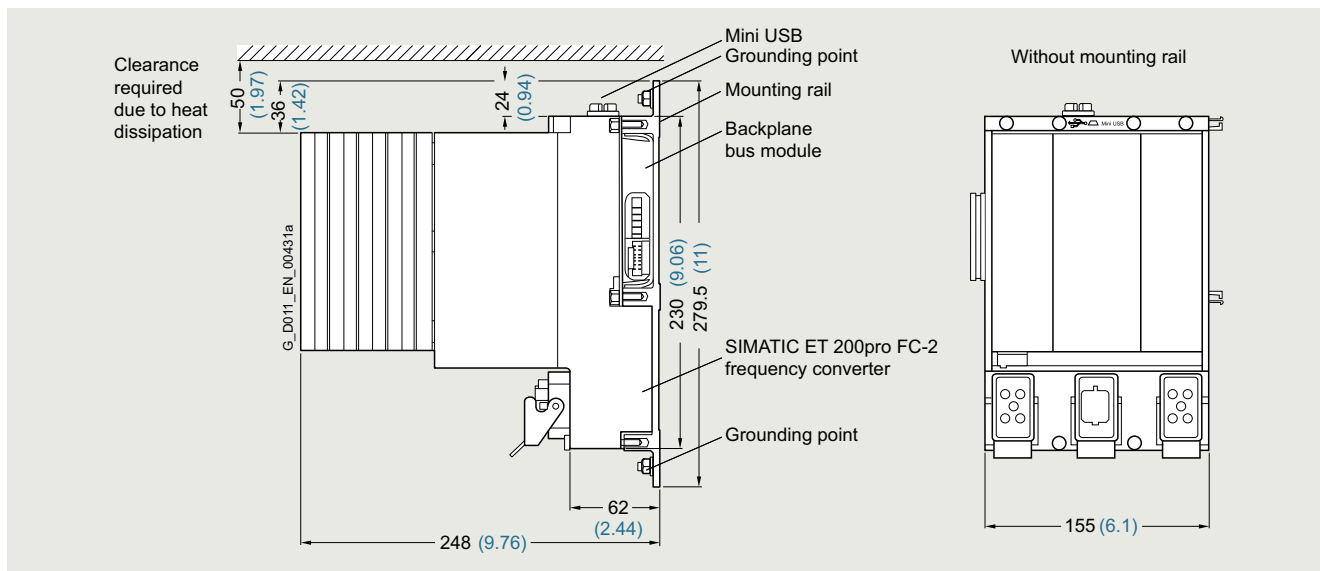

SIMATIC ET 200pro FC-2 frequency converter with backplane bus module and mounting rail

All dimensions in mm (values in brackets are in inches).

Clicking to SiePortal

6SL3255-0AA00-5AA0



SIMATIC ET 200pro FC-2 frequency converters

1.5 kW (2 hp)

SIMATIC ET 200pro FC-2 frequency converters

Accessories

IOP-2 Handheld Intelligent Operator Panel



IOP-2 Handheld for mobile use

The IOP-2 Handheld Intelligent Operator Panel is a very user-friendly and powerful operator panel for commissioning and diagnostics as well as local operator control and monitoring of SINAMICS G120D and SIMATIC ET 200pro FC-2 distributed converters.

The IOP-2 Handheld supports both newcomers and drive experts. Thanks to the membrane keyboard with a central sensor control field, the high-contrast color displays, the menu-based operation and the application wizards, it is easy to commission standard drives. A drive can be essentially commissioned without having to use a printed parameter list – as the parameters are displayed in plain text, and explanatory help texts and a parameter filtering function are provided.

Application wizards interactively guide you when commissioning important applications such as conveyor technology, pumps, fans and compressors. There is a basic commissioning wizard for general commissioning.

Up to two process values can be graphically visualized and up to four process values can be numerically visualized on the status screen/display. Process values can also be displayed in technological units.

The IOP-2 Handheld supports series commissioning of identical drives. For this purpose, a parameter list can be copied from a frequency converter into the IOP-2 Handheld and downloaded into other drive units of the same type as required.

In addition to the IOP-2, the IOP-2 Handheld includes a housing with rechargeable batteries, a charging unit, an RS232 connecting cable, and a USB cable. The charging unit is supplied with connector adapters for Europe, the US and UK. When the batteries are fully charged, the operating time is up to 10 hours.

To connect the IOP-2 Handheld to SINAMICS G120D and SIMATIC ET 200pro FC-2, the RS232 connecting cable with optical interface is required in addition.

Updating the IOP-2 Handheld

The IOP-2 Handheld can be updated and expanded using the integrated USB interface.

Data to support future drive systems can be transferred from the PC to the IOP-2 Handheld. Further, the USB interface allows users to be subsequently downloaded and the firmware to be updated for the IOP-2 Handheld ¹⁾.

Description	Article No.
IOP-2 Handheld For use with SINAMICS G120 SINAMICS G120C SINAMICS G120P SINAMICS G120D SIMATIC ET 200pro FC-2 Included in the scope of delivery: <ul style="list-style-type: none"> • IOP-2 • Handheld housing • Rechargeable batteries (4 × AA) • Charging unit (international) • RS232 connecting cable 3 m (9.84 ft) long, can be used in combination with SINAMICS G120, SINAMICS G120C, SINAMICS G120P • USB cable 1 m (3.28 ft) long 	6SL3255-0AA00-4HA1
RS232 connecting cable 2.5 m (8.20 ft) long, with optical interface for connecting the IOP-2 Handheld to SINAMICS G120D, SIMATIC ET 200pro FC-2	3RK1922-2BP00

	IOP-2 Handheld 6SL3255-0AA00-4HA1
Display	High-contrast color display, a variety of display options
<ul style="list-style-type: none"> • Resolution 	320 × 240 pixels
Operator panel	Membrane keyboard with central sensor control field
Operating languages	English, German, French, Italian, Spanish, Portuguese, Dutch, Swedish, Finnish, Russian, Czech, Polish, Turkish, Chinese Simplified
Ambient temperature	
<ul style="list-style-type: none"> • During transport and storage • During operation 	-20 ... +55 °C (-4 ... +131 °F) 0 ... 40 °C (32 ... 104 °F)
Humidity	Relative humidity < 95 %, non-condensing
Degree of protection	IP20
Dimensions (H × W × D)	195.04 × 70 × 37.58 mm (7.68 × 2.76 × 1.48 in)
Weight, approx.	0.724 kg (1.6 lb)
Compliance with standards	CE, UKCA, RCM, cULus, EAC, KC-REM-S49-SINAMICS

¹⁾ Information on updates for the IOP-2 Handheld is available at <https://support.industry.siemens.com/cs/document/67273266>

SIMATIC ET 200pro FC-2 frequency converters

1.5 kW (2 hp)

Clicking to SiePortal

6SL3255-0AA00-5AA0

SIMATIC ET 200pro FC-2 frequency converters

Accessories

Memory cards



SINAMICS SD memory card

The parameter settings of the converter and the firmware can be stored on the optional SINAMICS SD memory card. When service is required, the data are automatically downloaded from the memory card in the converter and the system is ready for use again without further interventions.

- Parameter settings can be written from the memory card to the converter or saved from the converter to the memory card.
- Up to 100 parameter sets can be stored.
- The memory card supports series commissioning without the use of the Intelligent Operator Panel IOP-2 Handheld or the STARTER commissioning tool.
- If firmware is stored on the memory card and a Control Unit is installed, the firmware can be upgraded/downgraded during power-up¹⁾

Note:

The memory card is optional, but it facilitates converter replacement.

Description	Article No.
SINAMICS SD card 512 MB	6SL3054-4AG00-2AA0
Optional firmware memory cards	
SINAMICS SD card 512 MB + firmware V4.7 SP13 (Multicard V4.7 SP13)	6SL3054-7TG00-2BA0
SINAMICS SD card 512 MB + firmware V4.7 SP14 (Multicard V4.7 SP14)	6SL3054-7TH00-2BA0

More information on firmware V4.7 SP14:

<https://support.industry.siemens.com/cs/document/109817231>

For an overview and more information on all available firmware versions, see

<https://support.industry.siemens.com/cs/document/67364620>

STARTER commissioning tool

The STARTER commissioning tool (V4.4 and higher) plus SSP supports the commissioning and maintenance of SIMATIC ET 200pro FC-2 frequency converters. The operator guidance combined with comprehensive, user-friendly functions for the relevant drive solution allow you to commission the device quickly and easily.

Description	Article No.
STARTER commissioning tool ²⁾ on DVD-ROM	6SL3072-0AA00-0AG0

¹⁾ You can find more information about firmware upgrades/downgrades on the internet at <https://support.industry.siemens.com/cs/document/67364620>

PC converter connection kit 2

The mini USB interface cable is used to control and commission a converter directly from a PC via a point-to-point connection if the appropriate software (STARTER commissioning tool version 4.4 and higher, plus SSP) has been installed.

Description	Article No.
PC converter connection kit 2 Mini USB interface cable for communication with a PC, 3 m (9.84 ft) long	6SL3255-0AA00-2CA0

Connecting cables pre-assembled at one end and connector sets to connect to the line supply

Description	Artikel-Nr.
Connecting cable pre-assembled at one end Power supply cable, open at one end, for Q4/2, angled, 4 × 4 mm ²	
• 1.5 m (4.92 ft) long	3RK1911-0DB13
• 5 m (16.4 ft) long	3RK1911-0DB33
Connector set for the power supply Q4/2	
• 2.5 mm ²	3RK1911-2BE50
• 4 mm ²	3RK1911-2BE10
• 6 mm ²	3RK1911-2BE30

Motor cables pre-assembled at one end and connector sets to connect the converter to the motor

Motor cables pre-assembled at one end for motors with brake and temperature sensor with Q8 plug, shielded	Article No.
	(HTG: supplied by Harting) (ZKT: supplied by KnorrTec)
Cross-section	4 × 1.5 mm ² 2 × (2 × 0.75 mm ²)
• 1.5 m (4.92 ft) long	HTG: 61 88 201 0288 ZKT: 70020501000150
• 3 m (9.84 ft) long	HTG: 61 88 201 0289 ZKT: 70020501000300
• 5 m (16.4 ft) long	HTG: 61 88 201 0290 ZKT: 70020501000500
• 10 m (32.8 ft) long	HTG: 61 88 201 0299 ZKT: 70020501001000
Connector set for motor cable Q8, shielded	HTG: 61 83 401 0131 ZKT: 10032001

Power jumper plugs

The power jumper plug is used for 400 V power transmission to following 400 V modules.

Description	Article No.
Power jumper plugs	3RK1922-2BQ00

More information

A comprehensive range of supplementary products is provided for the distributed drive technology, e.g. pre-assembled cables and connectors. An overview is provided at the following link: www.siemens.com/distributeddrives-supplementaryproducts

For more information about the connecting cables and plug-in connectors, please refer to Catalog IK PI.

²⁾ The STARTER commissioning tool is also available on the internet at www.siemens.com/starter

Engineering tools



10/2	SINAMICS DriveSim Designer
10/4	Siemens Product Configurator
10/5	TIA Selection Tool
10/6	SIMARIS planning tools for systems with SINAMICS drives
10/8	SinaSave energy efficiency tool
10/9	SIZER for Siemens Drives engineering tool (integrated in the TIA Selection Tool)
10/10	STARTER commissioning tool
10/12	SINAMICS Startdrive commissioning tool
10/15	Drive ES engineering software

Cybersecurity information

Siemens provides products and solutions with industrial cybersecurity functions that support the secure operation of plants, systems, machines and networks.

In order to protect plants, systems, machines and networks against cyber threats, it is necessary to implement – and continuously maintain – a holistic, state-of-the-art industrial cybersecurity concept. Siemens' products and solutions constitute one element of such a concept.

Customers are responsible for preventing unauthorized access to their plants, systems, machines and networks. Such systems, machines and components should only be connected to an enterprise network or the internet if and to the extent such a connection is necessary and only when appropriate security measures (e.g. firewalls and/or network segmentation) are in place.

For additional information on industrial cybersecurity measures that may be implemented, please visit

www.siemens.com/cybersecurity-industry

Siemens' products and solutions undergo continuous development to make them more secure. Siemens strongly recommends that product updates are applied as soon as they are available and that the latest product versions are used. Use of product versions that are no longer supported, and failure to apply the latest updates may increase customer's exposure to cyber threats.

To stay informed about product updates, subscribe to the Siemens Industrial Cybersecurity RSS Feed under

www.siemens.com/cert

Engineering tools

DriveSim Designer

Overview

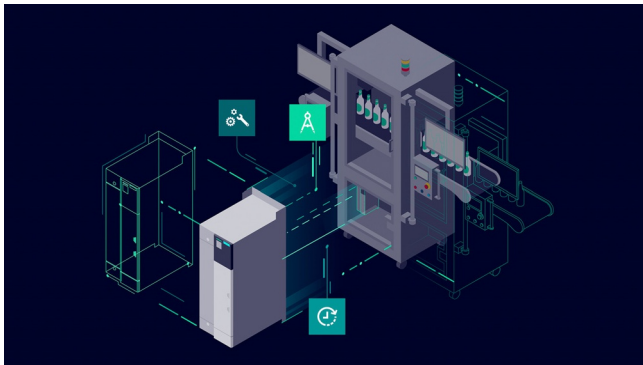

DriveSim Designer provides easy-to-use models for PROFIdrive-enabled SINAMICS converters, so you can create a digital twin of your drive.

The models are validated and tested against real SINAMICS converters and are available in the form of a standardized FMU (Functional Mockup Unit). Therefore, they are compatible with various standard time-based simulation programs such as SIMIT, Simcenter Amesim, ANSYS Twin Builder, MATLAB Simulink or Hopsan.

DriveSim Designer is another element in your engineering toolbox. Together with other virtual Siemens solutions, e.g. SIMATIC S7-PLCSIM Advanced or NX Mechatronics Concept Designer, a consistent model-based development process can be implemented.

Benefits

- Speed up time-to-market for OEMs
- Test validated SINAMICS models under real conditions already at the design or planning stage and make needed adjustments
- Identify issues and improvement capabilities early in the design stage and reduce testing effort to save time and cost
- Download the free-of-charge test version for 1 month to try the suitability of our solution before buying it
- DriveSim Designer offers a wide range of additional functionalities to improve the SINAMICS simulation model, e. g. safety or position telegrams
- Valid for the most used Siemens drives

Advantages of DriveSim Designer compared to SIMIT PROFIdrive blocks:

- Increased level of detail due to speed controller, current setpoint filters and internal load model
- Identical parameter values and meaning as in the real SINAMICS device
- Direct reference to SINAMICS documentation
- Basic Safety functions
- Brake control functions for lifting applications
- Validated against the real SINAMICS drive
- No wiring effort to represent functional configurations
- Significant reduction of SIMIT simulation tags (even more is possible if unused in-/ outputs are deselected within the Component Type Editor (CTE))
- Enables simulation of an (internal) two-mass oscillator as application with realistic SINAMICS parameter settings, besides the known limitations by the minimum sample time in SIMIT
- Compatible with every FMU Co-Simulation 2.0 compatible simulation tool

Application

With DriveSim Designer, you can implement three major use cases:

- Providing load characteristics for drive selection and dimensioning
- Virtual commission your PLC already in the design phase
- Test and improve interaction between PLC, drives and application virtually

Use case 1: Dimension and size the correct drive and motor for your application

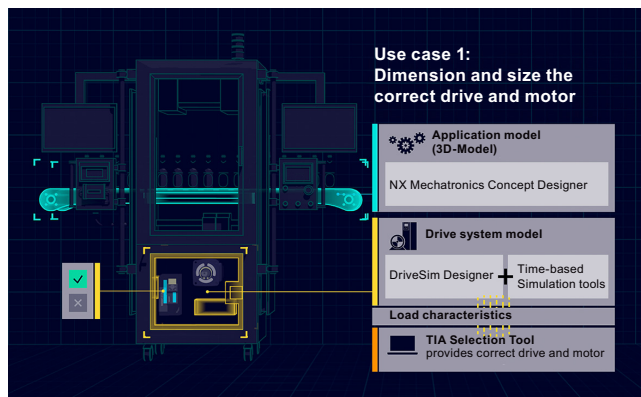

If you are designing a machine, you want to make sure that you select the SINAMICS converter and SIMOTICS motor most suitable for your drive application. As DriveSim Designer is control-unit-agnostic and thus represents a generic drive, you can parametrize it according to the functionality of your application. Running the simulation results in load characteristics, i.e. torque or speed curves over time. You can import these load profiles into TIA Selection Tool to select the suitable Control Unit and dimension the drive to best fit to the demand. So as a result, you have well selected SINAMICS converters and SIMOTICS motors with the help of the digital twin.

Use case 2: Virtual commission your drive and PLC early in the design phase

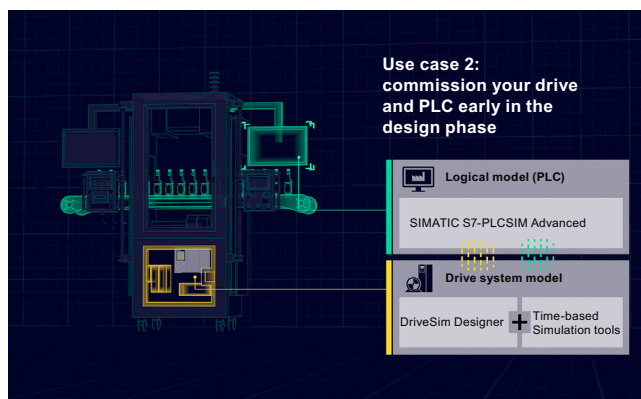

If you are designing a machine, you want to make sure the PLC code works with your SINAMICS drive. After writing the PLC code in TIA Portal, you can connect it via SIMATIC S7-PLCSIM Advanced to any time-based simulation tool (e.g. SIMIT). Integrated into the simulation tool, DriveSim Designer acts as a realistic communication partner for the PLC. Next, you can commission the virtual PLC in TIA Portal as you would do with a real PLC connected to a real drive. Without simulation, you would need to do that on-site. With simulation, you not only save time, but also have the freedom to try out various configurations and optimize your PLC code early in the process.



Application

Use case 3: Combine the application model and automation model with realistic drive system behavior

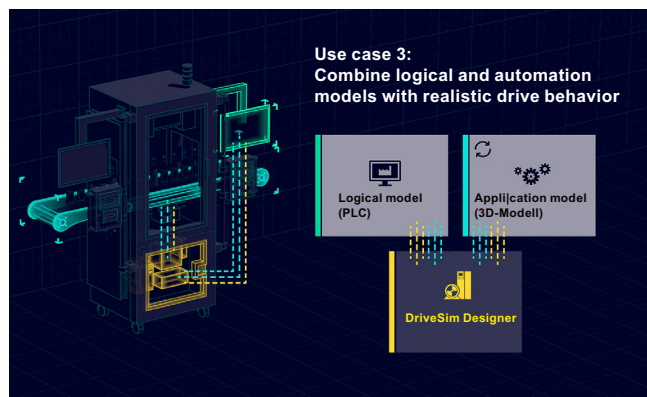

With the third Use case, you can connect a simulation tool such as NX Mechatronic Concept Designer to visualize the mechanical movements of your application. This way, you ensure that the drive behaves according to the desired machine performance. You can test several fault scenarios and optimize the interaction between PLC, application and drive virtually so overall, you can avoid unplanned machine behavior and increase the performance of your setup.

Integration

DriveSim Designer can be run in tools that support FMU 2.0 Co-Simulation Import (<https://fmi-standard.org/tools/>).

The FMU has been tested in the following simulation environments and is available in the attached application examples.

Tool	Manufacturer	DriveSim*** variant	SIMATIC S7-PLCSIM Advanced interface	Notes
SIMIT	Siemens	***.fmu	Yes	<ul style="list-style-type: none"> Permissible configuration: ExternalLoad = 1 & . Speed-Controller = 0 or ExternalLoad = 0 & . Speed-Controller = 1 Simulation with external load can provide wrong results because the minimum possible time step is 1 ms
Simcenter Amesim	Siemens	***_double.fmu	Yes	
MATLAB Simulink	MathWorks	< 2019a ***_unstruct.fmu ≥ 2019a ***.fmu	Yes	
ANSYS Twin Builder	ANSYS	***.fmu	No	
Hopsan	Linköping University	***_double.fmu	No	<ul style="list-style-type: none"> Open Source Install "win64-with_compiler-installer.exe" package

Selection and ordering data

Description	Article No.
DriveSim Designer	9SV1110-3AA00-0AA0

More information

More information is provided on the internet at:
www.siemens.com/drive-virtualization
<https://support.industry.siemens.com/cs/document/109812859>

You can find more videos on the topic at:

- Simulation of drive systems - Quick, Easy and Validated
- Simulation of drive systems - An introduction to SINAMICS
- Getting started with DriveSim Designer
- How to import DriveSim Designer into SIMIT, Matlab Simulink, Amesim and ANSYS TwinBuilder
- How to connect DriveSim Designer via SIMATIC S7-PLCSIM Advanced to TIA Portal
- How to use DriveSim Designer for drive sizing with TIA Selection Tool
- How to visualize drive system behavior in NX Mechatronics Concept Designer

Engineering tools

Siemens Product Configurator

Overview

The Siemens Product Configurator helps you to configure the optimum drive technology products for a number of applications. The product portfolio comprises the full drive technology range of gearbox, motor, converter and connection system as well as corresponding controller with suitable software license. The intuitive user interface in conjunction with product-specific preliminary selectors makes it simple, fast and efficient to configure products. The result is a bill of materials with extensive documentation consisting of technical data sheets, motor characteristic curves, 2D dimensional drawings / 3D CAD models, EPLAN macros and much more. You can order the products directly by transferring the bill of materials to the shopping cart of SiePortal.



Siemens Product Configurator at a glance

- Quick and easy configuration of drive products and associated components – gearboxes, motors, converters, controllers, connection systems
- Extensive documentation for all products and components, such as
 - Data sheets in up to 12 languages
 - Motor characteristic curves
 - 2D dimensional drawings / 3D CAD models in different formats
 - Terminal box drawing and terminal connection diagram
 - Certificates
 - EPLAN macros
- Ability to order products directly through SiePortal

Access to the Siemens Product Configurator

The Siemens Product Configurator can be accessed without the need for registration or logging in:
www.siemens.com/spc

Overview

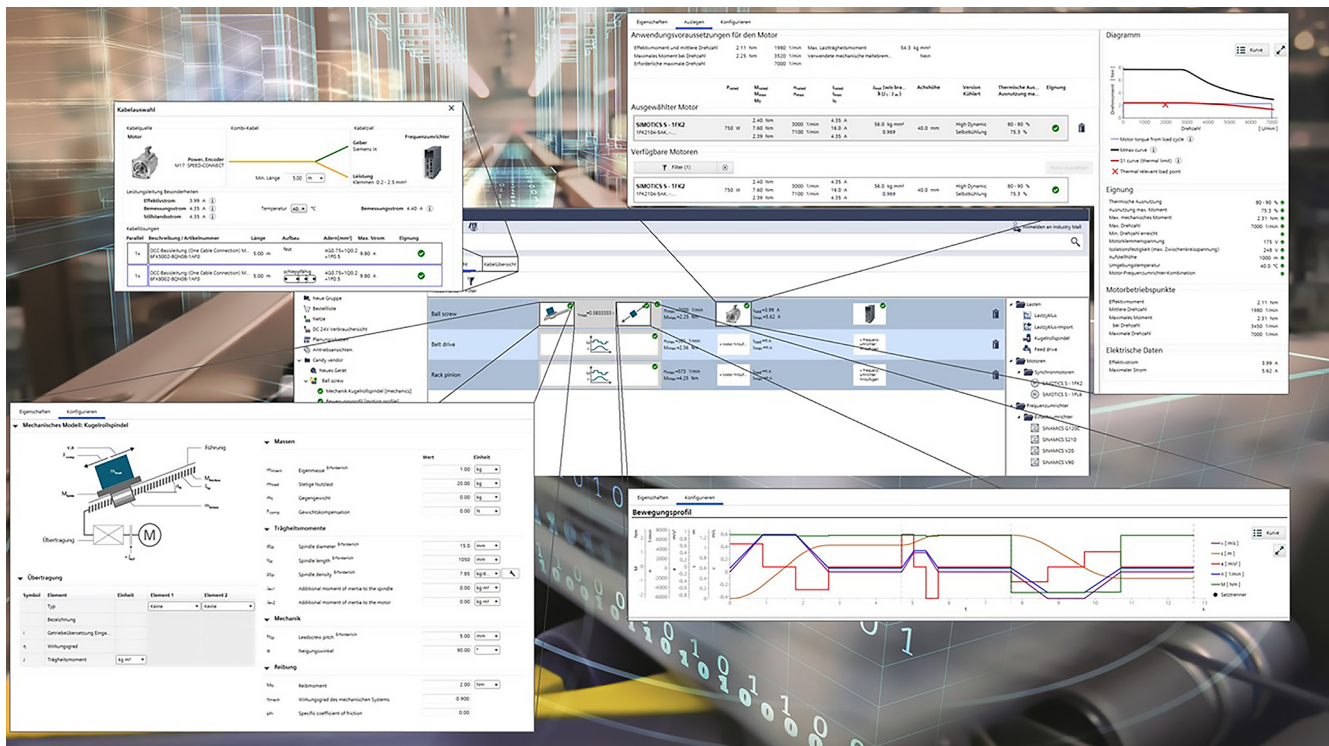

Selection guide and configurator for automation technology

Error-free configuration without expert knowledge through intelligent configurators and selection wizards. Desktop and cloud versions enable cross-team collaboration with maximum flexibility.

There are two versions of TIA Selection Tool:

- Desktop version: for downloading and executing on Microsoft Windows PCs (from Microsoft Windows 10)
- Cloud version: for running in the cloud and launching directly out of the browser (we recommend Google Chrome, Mozilla Firefox and Microsoft Edge)

Projects stored in the cloud can be edited with both tools. This makes it possible to work on-the-go using a tablet, at home on a PC – and vice versa, or together with colleagues and customers.

To use the full functionality, we recommend setting up a SiePortal account for both cases. This gives you access to prices and enables you to save your projects to our cloud.

You can find additional information about TIA Selection Tool at: www.siemens.com/tia-selection-tool

Drive dimensioning with SIZER in TIA Selection Tool (desktop version)

Application-specific requirements can be determined using drive technology dimensioning in TIA Selection Tool. This can include motors, gearboxes, converters and cables. The tool supports the configuration and dimensioning of control functions with an open and closed control loop. The technical documentation with features of the technical drive system, as well as a product list for ordering via SiePortal can also be compiled.

Engineering tools

SIMARIS planning tools for systems with SINAMICS drives

Overview

Electrical planning: Even easier with software!

Electrical planning for power distribution in non-residential and industrial buildings has never been more complex. To ensure you, as a specialist planner, have the best hand when it comes to electrical planning with SINAMICS drives, we provide support with the following efficient software tools: SIMARIS design for dimensioning and SIMARIS project for calculating the space requirements of the distribution boards.

Supported SINAMICS drives:

- SINAMICS G220
- SINAMICS G120, SINAMICS G120D, SINAMICS G120X
- SINAMICS G115D
- SINAMICS G130, SINAMICS G150

SIMARIS planning tools for systems with SINAMICS drives > SIMARIS design

Overview

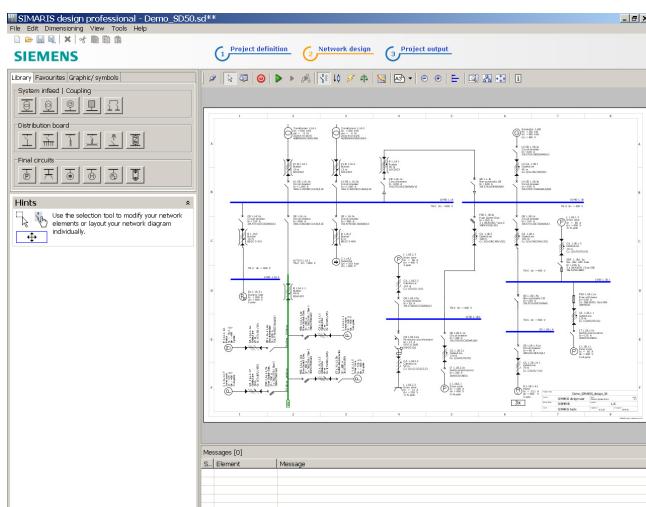

SIMARIS design is a planning tool for quick and effective network calculation and dimensioning of power distribution for non-residential and industrial buildings.

Starting in the planning phase, the entire electrical circuit required for the project can be structured and dimensioned on the basis of real products. For this purpose, the network structure is initially set up based on the stored modules for infeeds, couplings, distributors and branch circuits. It is also possible to reuse stored favorites, such as those processed for previous similar projects. Suitable components and distribution systems are then automatically selected from the product database stored in SIMARIS design based on the selected project-specific parameters and technical data. This precludes the extra costs so often incurred in the implementation phase as a result of systems that have not been correctly coordinated.

Any configuration of electric power distribution is subject to frequent change and adaptation, not only in the planning phase, but also in the implementation phase. SIMARIS design makes it easy to incorporate such changes in the supply concept and to automatically check their reliability in terms of sound engineering practice and the currently applicable standards.

SIMARIS design professional, a program version available for a fee, offers additional useful functions. It can be used to carry out and also document selectivity analyses, essential for safety power supply systems. There is also the option of analyzing and optimizing the energy efficiency of the planned network.

The versatile output variants enable precise documentation of the project structure and of the calculated data suitable for every phase of a project.

There is also the option of exporting the project data. This enables further processing of the planned project in SIMARIS project, and thus also supports and facilitates system planning.

Benefits

- Reduction in processing overhead for projects
- Dimensioning of electrical networks on the basis of real products according to sound engineering practice and the currently applicable standards (VDE, IEC)
- Automatic selection of the correct components from medium voltage through to interfacing of the load from the stored product database, i.e. no detailed knowledge of products and systems required
- Open definition of the types of mains operation and switching states
- Calculation of the short circuit current, load flow, voltage drop and energy balance
- Incorporation of the required person, short circuit and overload protection
- Option of factoring in any necessary functional endurance
- Display and dimensioning of cable and busbar trunking systems for power conveyance and distribution
- High planning reliability coupled with flexibility in the planning and implementation process
- Tracking changes via Change index possible
- Simple adaptation in the case of application changes or expansions
- Option for saving frequently required modules in the Favorites library
- Output of the created network diagram, as well as detailed parts lists and data lists
- Incorporation of country-specific product portfolios
- Comprehensive documentation of planning results with simple data transfer (Office, CAD etc.)

Application

SIMARIS design is a software tool for the network calculation and dimensioning of power distribution for non-residential and industrial buildings. Whether for a shopping center, a hospital or production facilities – with SIMARIS design you can reduce the overhead required for the overall planning of power distribution systems and hence the time spent on the selection and dimensioning of equipment.

More information

For further information and available downloads, please go to: www.siemens.com/simarisdg

If you have any other questions, please do not hesitate to contact our Customer Support Center:

Phone.: +49 70 00 7 46 27 47

Email: technical-assistance@siemens.com

SIMARIS planning tools for systems with SINAMICS drives > SIMARIS project

Overview

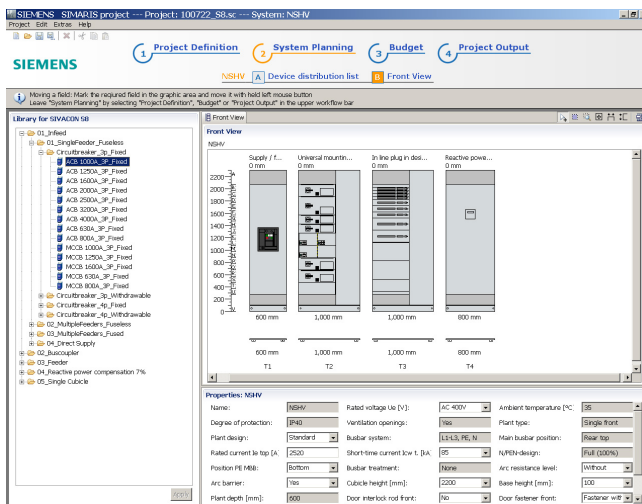

SIMARIS project is a planning tool for fast calculation of space requirements and electrical power distribution system budgets for non-residential and industrial buildings, and for generating specifications automatically.

The following is determined in SIMARIS project based on the pre-defined project structure and the basic technical specifications selected:

- For medium-voltage switchboards: selection of the required system and the required fields, then presentation of a front view with dimensions.
- Following selection of the system for transformers, the required quantity must be selected. Selected transformers are presented as a parts list.
- For low-voltage switchboards and distribution boards: selection of the required protection devices and switching devices per system. The most suitable distribution system is determined automatically based on the list of distribution devices thus created. It is then equipped with the devices and presented graphically in an automatically generated front view that includes dimensions.
- Following selection of the system for busbar trunking systems the length is specified and the additionally required components are selected, e.g. infeeds, junction units and tap-off units. All the resulting components are listed in a parts list.

Detailed information about Siemens devices or their article numbers is not needed because SIMARIS project makes the selection automatically on the basis of the parameters entered. For each item of switchboard or each distribution board, SIMARIS project takes the wiring, control and measurement etc. into account.

A system plan drawn up in SIMARIS design can also be imported into SIMARIS project, which means that selecting devices becomes redundant and SIMARIS project builds up the project structure automatically.

Convenient output versions are available to document the results, including the automatic generation of specifications for the planned systems.

Typical versions of a system planned in SIMARIS project can be saved and repeatedly integrated in new projects from the Favorites library. Automatically created systems can also be subsequently optimized or changed. This is particularly relevant if planning becomes more detailed and the budget needs to be reinforced as a result.

For detailed calculation of costs – on an up-to-date and regional basis – and for more project support, please contact your Siemens representative.

Benefits

- Intuitive and easy to operate
- Automatic selection and placement of matching distribution systems
- Fast determination of the space requirements and cost of power distribution plants
- End-to-end planning, from medium-voltage switchgear assemblies, transformers, low-voltage switchgear and busbar trunking systems right through to the distribution boards
- Simple adaptation of project planning with increasing clarification of implementation requirements, but also in the event of application changes or expansions
- Saving planned systems for similar projects individually in the favorites library and importing them from there into new projects
- Option of factoring in functional endurance for busbar systems
- Convenient output versions for documentation, such as graphic views, lists and specifications
- Projects created in SIMARIS design can also be imported

Application

SIMARIS project is suitable for the fast determination of the space requirements and cost of electrical power distribution in all industrial and non-residential buildings and for the automatic generation of specifications. From shopping centers to hospitals and production buildings – with SIMARIS project it is possible to reduce the amount of work required for the overall planning of power distribution systems and hence the time spent on selecting and dimensioning the necessary equipment.

More information

For further information and available downloads, please go to: www.siemens.com/simarisproject

If you have any other questions, please do not hesitate to contact our Customer Support Center:
Phone.: +49 70 00 7 46 27 47
Email: technical-assistance@siemens.com

Engineering tools

SinaSave energy efficiency tool

Overview

SinaSave determines the energy saving potential and payback time based on your application setup. SinaSave is a web tool which is intuitive to operate and supports you in an investment decision:

- Is it worthwhile to use more energy efficient systems?
- When will my investment pay off?

SinaSave supports you to find the optimum solution: technically, economically, and ecologically.

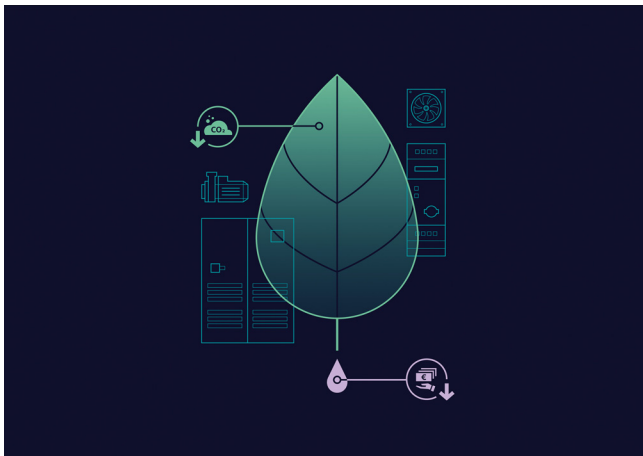

In which cases can SinaSave support you?

- Pump systems
 - Calculate your potential energy and CO2 savings with our pump drive systems
- Fan systems
 - Calculate your potential energy and CO2 savings with our fan drive systems

For standard motors, calculate your potential energy and CO2 savings with the Tool "Evaluate" from our product partner Innomotics (<https://evaluate.innomotics.com>)

SinaSave can be accessed without the need for registration or logging in:
www.siemens.com/sinasave

Benefits

- **Transparency of overall savings potential and individual amortization plan**
 - SinaSave calculates the expected energy consumption and resulting savings based on your individual energy prices, operating times and loads to find the optimum solution to make easy decisions.
- **Ease of use and self-explanatory user guidance to calculate savings potential on overall system level**
 - SinaSave compares different drive system configurations for pumps or fan applications, in addition to direct online (DOL) and variable-speed drive (VSD) systems for greenfield and brownfield projects.
- **Maximizing efficiency to reach sustainable energy and cost savings**
 - SinaSave identifies potential savings in energy, costs and CO2 to reduce your environmental footprint, making your operations more efficient and sustainable.

Functions

- Determine savings potential for energy, power costs, and CO2
- Estimate expected amortization and Total Costs of Ownership (TCO)
- Output of system power losses for motor inverter systems as per IEC 61800-9-2
- Simple design with intuitive usability
- Results presented in graphic form
- Storage and charging, export of a handout, for example for customers or decision-makers
- Multiple languages, 14 currencies, IEC and NEMA standards
- Direct transfer to next processes, e.g. product configuration

More information

Further information about the amortization calculator for energy-efficient drive systems is available on the Internet at:
www.siemens.com/tools-sinasave

Further information about services for energy saving is available on the Internet at:

www.siemens.com/energy-saving

www.siemens.com/energy-efficiency

SIZER for Siemens Drives engineering tool (integrated in the TIA Selection Tool)

Overview

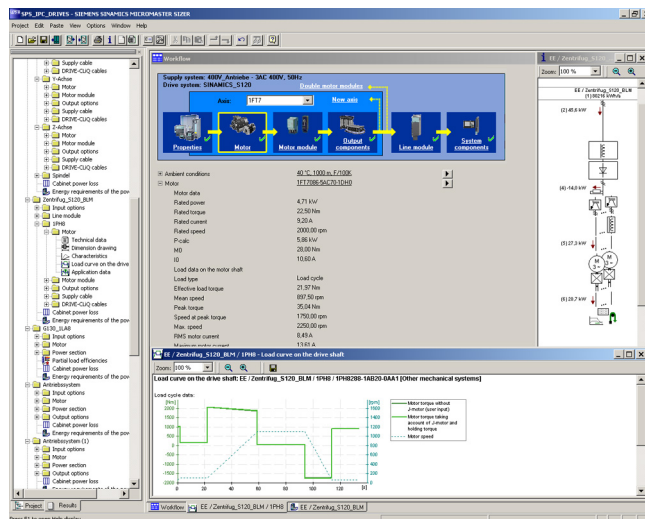

The following drives and controls can be engineered in a user-friendly way using the SIZER for Siemens Drives engineering tool:

- SIMOTICS motors, including servo geared motors
- SINAMICS low-voltage drive systems
- Motor starters
- SINUMERIK CNC
- SIMOTION Motion Control controller
- SIMATIC controller

It provides support when selecting the technologies involved in the hardware and firmware components required for a drive task. SIZER for Siemens Drives covers the full range of operations required to configure a complete drive system, from basic single drives to demanding multi-axis applications.

SIZER for Siemens Drives supports all of the engineering steps in one workflow:

- Configuring the power supply
- Designing the motor and gearbox, including calculation of mechanical transmission elements
- Configuring the drive components
- Compiling the required accessories
- Selecting the line-side and motor-side power options, e.g. cables, filters, and reactors

When SIZER for Siemens Drives was being designed, particular importance was placed on a high degree of usability and a universal, function-based approach to the drive application. The extensive user guidance makes it easy to use the tool. Status information keeps you continually informed about the progress of the configuration process.

The drive configuration is saved in a project. In the project, the components and functions used are displayed in a hierarchical tree structure.

The project view permits the configuration of drive systems and the copying/inserting/modifying of drives already configured.

The configuration process produces the following results:

- A parts list of the required components (export to Excel, use of the Excel data sheet for import to SAP)
- Technical specifications of the system
- Characteristic curves
- Comments on line harmonic distortions
- Mounting arrangement of drive and control components and dimensional drawings of motors
- Energy requirements of the configured application

These results are displayed in a results tree and can be reused for documentation purposes.

Support is provided by the technological online help menu:

- Detailed technical specifications
- Information about the drive systems and their components
- Decision-making criteria for the selection of components
- Online help in English, French, German, Italian, Chinese and Japanese

System requirements

- PG or PC, with Pentium III min. 800 MHz (recommended > 1 GHz)
- 512 MB RAM (1 GB RAM recommended)
- At least 2 GB of free hard disk space
- An additional 100 MB of free hard disk space on Microsoft Windows system drive
- Screen resolution 1024 × 768 pixels
- Operating system:
 - Microsoft Windows 7 (32/64-bit) Professional, Enterprise, Ultimate, Home
 - Microsoft Windows 8.1 (32/64-bit) Professional, Enterprise, Ultimate, Home
 - Microsoft Windows 365
 - Microsoft Windows 10 (64-bit) Professional, Enterprise
- Microsoft Office 2003/2007/2010/2013/2016/365
- Microsoft Internet Explorer V8.0
- Microsoft .NET Framework 2.0
- OpenGL 2.1

More information

Drive dimensioning in the TIA Selection Tool

Application-specific requirements can be determined using drive technology dimensioning in the TIA Selection Tool. This can include motors, gearboxes and converters. The tool supports the configuration and dimensioning of control functions with an open and closed control loop. The technical documentation with features of the technical drive system, as well as a product list for ordering via SiePortal can also be compiled.

You can find more information on the SIZER for Siemens Drives engineering tool at

<https://support.industry.siemens.com/cs/ww/en/ps/13434/dl>

You can find more information about the TIA Selection Tool at: www.siemens.com/tia-selection-tool

Engineering tools

STARTER commissioning tool

Overview

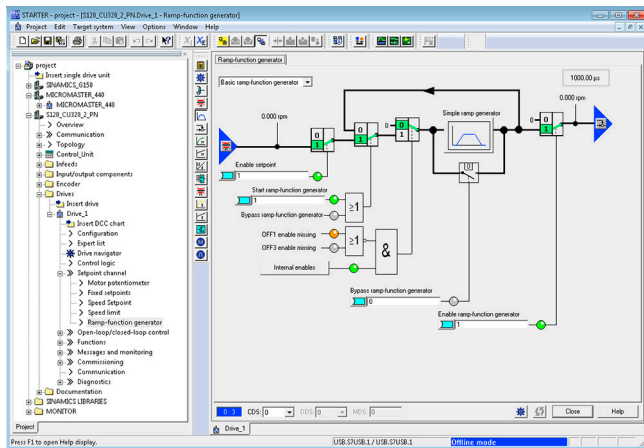

The user-friendly STARTER commissioning tool can be used for:

- Commissioning
- Optimization
- Diagnostics

This software can be operated as a standalone PC application, or integrated as a TIA-compatible program in SIMATIC STEP 7, or highly integrated into the SCOUT Engineering System (for SIMOTION). The basic functions and handling are the same in both cases.

In addition to the SINAMICS drives, STARTER also supports MICROMASTER 4 devices.

The project wizards can be used to create the drives within the structure of the project tree.

Beginners are supported by solution-based dialog guidance, whereby a standard graphics-based display maximizes clarity when setting the drive parameters.

First commissioning is guided by a wizard which makes all the basic settings in the drive. Therefore, getting a motor up and running is merely a question of setting a few of the drive parameters as part of the drive configuration process.

The individual settings required are made using graphics-based parameterization screens, which also precisely visualize the principle of operation of the drive.

Examples of individual settings that can be made include:

- Use of terminals
- Bus interface
- Setpoint channel (e.g. fixed setpoints)
- Closed-loop speed control (e.g. ramp-function generator, limits)
- BICO interconnections
- Diagnostics

For experts, the expert list can be used to specifically and quickly access individual parameters at any time. An individual compilation of frequently used parameters can be saved in dedicated user lists and watch tables.

In addition, the following functions are available for optimization purposes:

- Self-optimization of the controller settings (depending on drive unit)
- Setup and evaluation of trace recordings¹⁾
 - Tool function for recording 2 × 8 signals with
 - Measuring cursor function
 - Extensive trigger functions
 - Several Y scales
 - Sampling times in the current controller cycle clock

Diagnostics functions provide information about:

- Control/status words
- Parameter status
- Operating conditions
- Communication states

Performance features

- User-friendly: Only a small number of settings need to be made for successful first commissioning: The motor starts to rotate
- Solution-oriented dialog-based user guidance simplifies commissioning
- Self-optimization functions reduce manual effort for optimization.

System requirements

The following minimum requirements must be complied with:

- Hardware
 - PG or PC with Pentium III min. 1 GHz (recommended >1 GHz)
 - Work memory 2 GB (4 GB recommended)
 - Screen resolution 1024 × 768 pixels, 16-bit color depth
 - Free hard disk memory: min. 5 GB
- Software
 - Microsoft Internet Explorer V6.0 or higher
 - Microsoft Windows 64-bit operating systems:
 - Windows 10 Pro, from Version 22H2
 - Windows 10 Enterprise, from Version 22H2
 - Windows 10 (IoT) Enterprise 2016 LTSC (OS Build 14393)
 - Windows 10 (IoT) Enterprise 2019 LTSC (OS Build 17763)
 - Windows 10 (IoT) Enterprise 2021 LTSC (OS Build 19044)
 - Windows 11 Pro, from Version 22H2
 - Windows 11 Enterprise, from Version 22H2
 - Windows Server 2019
 - Windows Server 2022

Supported virtualization platforms

STARTER (V5.1 SP1 and higher) can be installed on a virtual machine. For this purpose, one of the following virtualization platforms in the specified version or a newer version can be used:

- VMware vSphere Hypervisor ESX(i) V8.0
- VMware Workstation Pro 17
- VMware Player 17
- Microsoft Hyper-V Server 2022

You can use the following guest operating systems to install STARTER within the selected virtualization platform:

- Microsoft Windows 10 Pro/Enterprise (64 bit)
- Microsoft Windows 11 Pro/Enterprise (64 bit)

Notes:

- The same hardware requirements apply to the guest operating system as for STARTER and SINAMICS DCC.
- The system operator must ensure that the guest operating systems have sufficient system resources.
- The use of manufacturer-certified hardware is recommended for the operation of VMware vSphere Hypervisor ESX(i).

¹⁾ Depending on drive unit.
Not supported for MICROMASTER 4, SINAMICS G110, SINAMICS G120 <firmware V4.4, SINAMICS G110D and SINAMICS G120D <firmware V4.5.

6SL3255-0AA00-5AA0



STARTER commissioning tool

Integration

Data can be exchanged (depending on the version) via PROFIBUS or PROFINET/Ethernet or via a serial interface.

For commissioning and service, a PG/PC can be connected to the CU320-2 Control Unit via PROFIBUS. A PROFIBUS connection must be available with a connecting cable at the PG/PC.

Further, communication between a CU320-2 Control Unit and PG/PC can also be established via Ethernet, either via an (optional) CBE20 Communication Board or the Ethernet interface -X127 on the CU320-2 Control Unit.

Note:

The terminal strip -X127 is suitable as a communication link to the PG/PC only for the purposes of servicing and commissioning.

Selection and ordering data

Description	Article No.
STARTER commissioning tool <u>Single license and certificate of license</u> English, French, German, Italian, Spanish	6SL3072-0AA00-0AG0 6SL3072-0AA00-0AK0
<ul style="list-style-type: none"> On DVD-ROM (STARTER V5.6 HF1) Software download (email address required for delivery) 	

Accessories

Depending on the version of the Control Unit (CU), the Control Unit of the drive unit can communicate with the programming device (PG) or PC via PROFIBUS or PROFINET/Ethernet or via a serial interface. The following accessories are available for the particular drive system as listed in the following table.

Description	Recommended accessories For communication between the drive unit and the programming device or PC Article No.	
SIMATIC ET 200pro FC-2		
<ul style="list-style-type: none"> USB PC converter connection kit 2 Mini USB interface cable for communication with a PC, 3 m (9.84 ft) 		6SL3255-0AA00-2CA0
<ul style="list-style-type: none"> PROFIBUS Connection to the PROFIBUS system in the plant 		See supplementary products ¹⁾
<ul style="list-style-type: none"> PROFINET/Ethernet Connection to the PROFINET system in the plant 		See supplementary products ¹⁾
SINAMICS G120D		
<ul style="list-style-type: none"> USB PC converter connection kit 2 Mini USB interface cable for communication with a PC, 3 m (9.84 ft) 		6SL3255-0AA00-2CA0
<ul style="list-style-type: none"> PROFIBUS Connection to the PROFIBUS system in the plant 		See supplementary products ¹⁾
<ul style="list-style-type: none"> PROFINET/Ethernet Connection to the PROFINET system in the plant 		See supplementary products ¹⁾

More information

The STARTER commissioning tool is also available on the internet under www.siemens.com/starter

¹⁾ An overview of all the supplementary products (e.g. cables and connectors) that are available for the distributed converter family can be found at the following link: www.siemens.com/distributeddrives-supplementaryproducts

SINAMICS Startdrive commissioning tool

Overview

SINAMICS Startdrive is integrated in the TIA Portal and is a tool for the configuration, commissioning and diagnostics of the SINAMICS family of converters.

The SINAMICS Startdrive commissioning tool has been optimized with regard to user friendliness and consistent use of the TIA Portal benefits of a common working environment for PLC, HMI and drives. Time-saving and guided step-by-step commissioning with maximum flexibility is complemented by user-friendly graphic function views for all drive functions, including functional safety (Safety Integrated) and drive-based technology functions (e.g. EPOS). The automatic message display, the powerful real-time trace and the context-sensitive online help make converter diagnostics very easy.

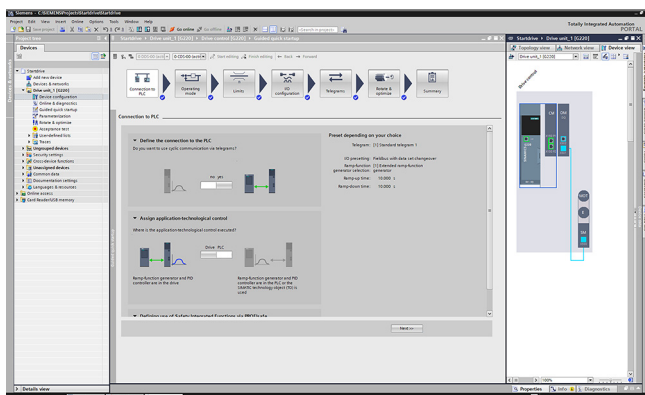

The software packages based on the TIA Portal are harmonized with each other and offer important benefits, the main advantage being a shared project storage. The TIA Portal enables simple integration of SINAMICS converters in your automation solution. Thanks to the standardization of operator actions and the integration in general TIA Portal operating concepts (e.g. UMAC, Openness) as well as standard TIA Portal functions (e.g. Undo/Redo), familiarization is easy both for drive experts as well as SIMATIC users. Special focus is placed on the interaction between SIMATIC and SINAMICS, especially when connecting the SINAMICS drives to SIMATIC technology objects.

Integration

Supported frequency converters

SINAMICS Startdrive Basic enables complete commissioning, diagnostics, parameterization, optimization and connection to the PLC for the following SINAMICS converters integrated in SINAMICS Startdrive:

- SINAMICS G120, G120C, G120D, G120P
- SINAMICS G115D
- SINAMICS G130, G150
- SINAMICS G220 (as of V18 SP2 Update 1)
- SINAMICS S120 ¹⁾, S150
- SINAMICS S200 (as of V18 SP2)
- SINAMICS S210 (6SL3...) and innovated SINAMICS S210 (6SL5...) (as of V18 SP1)
- SINAMICS MV

SINAMICS Startdrive Advanced

With SINAMICS Startdrive Advanced (available as of V15) you benefit from powerful engineering functions that save you considerable time and ultimately costs.

- Safety acceptance test:
 - Guided acceptance test wizard for all drive-based Safety Integrated functions
 - Automatic and safety function-specific generation of traces to analyze the machine behavior
 - Generation of an acceptance report as Excel file (xlsx format, can also be used with OpenOffice)
- Improved optimization options in the drive: Extended measuring functions (available for CU320-2 PN/DP and CU310-2 PN as of V5.2 SP3, SINAMICS S210 (6SL5...) as of V6.1 and SINAMICS S200 as of V6.2), long-term trace
- Export of backup files from the Startdrive project
- Also contains all Startdrive Basic functions
- Only license key required, no additional installation

New in V20Startdrive Basic V20

- Comparison of drive parameters between different drives
- Trace templates for easy creation of trace configurations
- Unit Switching (SI/US Units)
- Integration of the drive version V6.4 for SINAMICS G220, S200, S210 (6SL5...):
 - Introduction of OPC UA server functionality for devices from V6.4

Startdrive Advanced V20

- Export of backup files for drives from V6.x for efficient roll-out of drive parameterizations via SD card

¹⁾ Includes SINAMICS S220 Smart Line Modules booksize format as of SINAMICS Startdrive V17 Update 1.

6SL3255-0AA00-5AA0



SINAMICS Startdrive commissioning tool

Integration

Installation versions

SINAMICS Startdrive can only be installed as an option package for SIMATIC STEP 7. However, a SIMATIC STEP 7 license is not required to run SINAMICS Startdrive.

System requirements

The following table shows the recommended hardware and system equipment for the operation of SINAMICS Startdrive.

Hardware	Recommendation
Computer	As of SIMATIC FIELD PG M6 Comfort (or comparable PC)
Processor	Intel Core i5-8400H (2.5 ... 4.2 GHz; 4 cores + hyper-threading; 8 MB Smart Cache)
RAM	16 GB or more (32 GB for large projects)
Hard disk	SSD with at least 50 GB available memory
Screen resolution	15.6" Full HD display (1920 × 1080 or larger)
Operating systems	<ul style="list-style-type: none"> • Microsoft Windows 10 (64 bit) <ul style="list-style-type: none"> - Windows 10 Professional Version 22H2 - Windows 10 Enterprise 21H2, 22H2 - Windows 10 Enterprise 2019 LTSC - Windows 10 Enterprise 2021 LTSC • Microsoft Windows 11 (64 bit) <ul style="list-style-type: none"> - Windows 11 Home Version 22H2, 23H2 - Windows 11 Professional Version 22H2, 23H2 - Windows 11 Enterprise 22H2, 23H2 • Microsoft Windows Server (64 bit) <ul style="list-style-type: none"> - Windows Server 2016 Standard (full installation) - Windows Server 2019 Standard (full installation) - Windows Server 2022 Standard (full installation)

Compatibility with other products

- SINAMICS Startdrive V20 operates with STEP 7, WinCC and Scout TIA V20 in one framework
- SINAMICS Startdrive V20 can be installed on the same computer in parallel with other versions of SINAMICS Startdrive V12 to V19
- SINAMICS Startdrive can be installed on the same computer as SINAMICS MICROMASTER STARTER

Supported virtualization platforms

SINAMICS Startdrive can be installed in a virtual machine. For this purpose, one of the following virtualization platforms in the specified version or a newer version can be used:

- VMware vSphere Hypervisor (ESXi) 8.0 or higher
- VMware Workstation 17.0 or higher
- VMware Player 17.0 or higher
- Microsoft Hyper-V Server 2019 or higher

Supported safety programs

The following safety programs have been tested with SINAMICS Startdrive V20:

- Virus scanners:
 - Symantec Endpoint Protection 14.3 RU8
 - Trend Micro Apex One
 - McAfee Endpoint Security (ENS) 10.7
 - Microsoft Defender
 - Qihoo 360 (Safe Guard and Virus Scanner)
 - CrowdStrike Falcon Go (Falcon Prevent and Falcon Device Control)
- Encryption software:
 - Microsoft Bitlocker
- Host-based Intrusion Detection System
 - McAfee Application Control 8.4 (Trellix)

Selection and ordering data

Description	Article No.
SINAMICS Startdrive Basic V20 SP1 commissioning tool Single license and certificate of license English, French, German, Italian, Spanish, Chinese Simplified • Software download (email address required for delivery)	6SL3072-4LA02-0XG0
SINAMICS Startdrive Advanced V20 SP1 commissioning tool License key (floating license) English, French, German, Italian, Spanish, Chinese Simplified • On DVD-ROM with license key on USB flash drive • Software download incl. license key (email address required for delivery)	6SL3072-4LA02-0XA5 6SL3072-4LA02-0XG5
Upgrade SINAMICS Startdrive Advanced V15 ... V19 to V20 • On DVD-ROM with license key on USB flash drive • Software download incl. license key (email address required for delivery)	6SL3072-4LA02-0XE5 6SL3072-4LA02-0XK5
Software Update Service with SINAMICS Startdrive Advanced in the TIA Portal Delivery is performed according to the number of ordered SUS products (e.g. 10 upgrade license keys (floating license) with 10 DVD-ROMs, 10 USB flash drives, etc.) • On DVD-ROM with upgrade license key on USB flash drive • Software download incl. license key (email address required for delivery)	6SL3072-4AA02-0XL8 6SL3072-4AA02-0XY8

Note:

SINAMICS DCC can be installed in addition to the SINAMICS Startdrive commissioning tool. This allows the device functionality in the SINAMICS drive system to be expanded with dedicated technological functions as required.

Further information about SINAMICS DCC can be found in the section SINAMICS DCC (Drive Control Chart) in the TIA Portal.

Accessories

Depending on the version of the Control Unit (CU), the Control Unit of the drive unit can communicate with the programming device (PG) or PC via PROFIBUS or PROFINET/Ethernet or via a serial interface. The following accessories are available for the particular drive system as listed in the following table.



SINAMICS Startdrive commissioning tool

Selection and ordering data

Description		Recommended accessories For communication between the drive unit and the programming device or PC Article No.
SINAMICS G115D		
• USB	PC converter connection kit 2 Mini USB interface cable for communication with a PC, 3 m (9.84 ft)	6SL3255-0AA00-2CA0
• PROFINET/ Ethernet	Connection to the PROFINET system in the plant	See supplementary products ¹⁾
SINAMICS G120D		
• USB	PC converter connection kit 2 Mini USB interface cable for communication with a PC, 3 m (9.84 ft)	6SL3255-0AA00-2CA0
• PROFIBUS	Connection to the PROFIBUS system in the plant	See supplementary products ¹⁾
• PROFINET/ Ethernet	Connection to the PROFINET system in the plant	See supplementary products ¹⁾

More information

The SINAMICS Startdrive Basic commissioning tool is available free on the internet at www.siemens.com/startdrive

¹⁾ An overview of all the supplementary products (e.g. cables and connectors) that are available for the distributed drives family can be found at the following link:
www.siemens.com/distributeddrives-supplementaryproducts

Overview

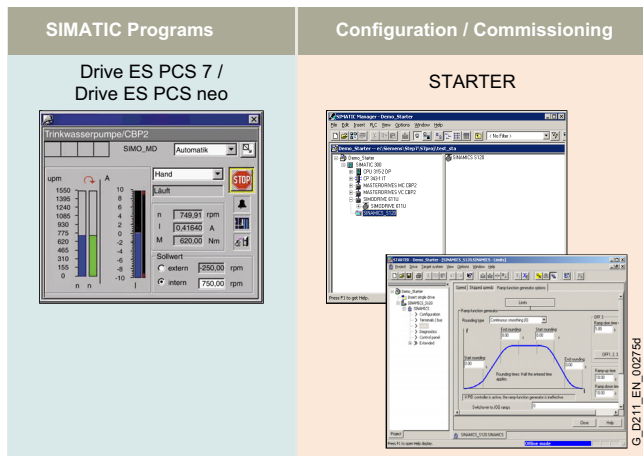

Drive ES/STARTER is the engineering system used to integrate the communication, configuration and data management functions of Siemens drive technology into the SIMATIC automation world easily, efficiently and cost-effectively.

The following software packages are available for selection:

- STARTER
- Drive ES PCS 7 / Drive ES PCS neo Add-On

The Drive ES (**Drive Engineering Software**) fully integrates drives from Siemens into the world of Totally Integrated Automation (STEP 7 V5.x).

Design

The following software packages are available for selection:

- **STARTER**
- **Drive ES PCS 7 (APL Style or Classic Style) / Drive ES PCS neo Add-On**

STARTER

The STARTER commissioning tool is for first-time users of the world of Totally Integrated Automation and the basic software for setting the parameters of the SINAMICS and MICROMASTER 4 drives online and offline in this environment. The STARTER integration enables both the automation system and the drives to be handled using the SIMATIC Manager software. STARTER is the starting point for common data archiving in complete projects and for extending the use of the routing and the SIMATIC tele-service to drives. STARTER provides the configuration tools for the Motion Control functions – device-to-device communication, equidistance and isochronous operation with PROFIBUS DP and ensures that drives with PROFINET IO are simply integrated into the SIMATIC environment.

Drive ES PCS 7 (APL Style or Classic Style)

Drive ES PCS 7 links the drives with a PROFIBUS DP interface into the SIMATIC PCS 7 process control system, and it requires that SIMATIC PCS 7, V6.1 or higher has first been installed. Drive ES PCS 7 provides a block library with blocks for the drives and the corresponding faceplates for the operator station, which enables the drives to be operated from the PCS 7 process control system. From Drive ES PCS 7 V6.1 and higher, drives will also be able to be represented in the PCS 7 Maintenance Station.

From Drive ES PCS 7 V8.0 and higher, two versions of the library are available: The APL (Advanced Process Library) variant and the previous version in the so-called Classic Style.

Detailed contents of the Drive ES PCS 7 (APL Style or Classic Style)

- **Block library for SIMATIC PCS 7** Faceplates and control blocks for SIMOVERT MASTERDRIVES VC and MC, as well as MICROMASTER/MIDIMASTER of the third and fourth generation and SIMOREG DC MASTER and SINAMICS
- **STEP 7 V5.x slave object manager** for user-friendly configuration of drives and non-cyclic PROFIBUS DP communication with the drives
- **STEP 7 V5.x device object manager** for easy configuration of drives with PROFINET-IO interfaces (V8.0 SP1 and higher)
- **SETUP program** for installing the software in the SIMATIC PCS 7 environment

Drive ES PCS neo Add-On

Siemens SINAMICS drives can be controlled via SIMATIC PCS neo and operated and monitored on the OCM client with the SINAMICS library Drive ES PCS neo Add-On. The Drive ES PCS neo faceplates make the data relevant for system operation available on the OCM client. The STARTER commissioning tool on the engineering server can also be used for parameter assignment, commissioning and detailed diagnostics of the SINAMICS drives.

Options

Drive ES PCS 7 Software Update Service

A software update service can also be purchased for the Drive ES PCS 7 software. The user will automatically receive the latest software, service packs and full versions for one year after ordering.

The update service can only be ordered in addition to an existing (i.e. previously ordered) full version.

- Period of update service: 1 year

The update service is automatically extended by 1 further year unless canceled up to 6 weeks prior to expiration.

Description	Article No.
Drive ES PCS 7	
• Update service for single-user license	6SW1700-0JD00-0AB2
Drive ES PCS 7 APL	
• Update service for single-user license	6SW1700-0JD01-0AB2

More information

Further information is available on the internet at: www.siemens.com/drive-es

Engineering tools

Drive ES engineering software

Selection and ordering data

Description	Article No.	Description	Article No.
Drive ES PCS 7 V9.0 SPx ^{*)} Block library for PCS 7 for the integration of drives in Classic Style (as predecessor) Requirement: PCS 7 V9.0 or higher Type of delivery: DVD-ROM Languages: en, de, fr, it, es With electronic documentation		<ul style="list-style-type: none"> • Single-user license incl. 1 runtime license (DVD-ROM) • Single-user license incl. 1 runtime license (OSD) • Runtime license (on paper) • Runtime license (eCoL) • Update service for single-user license • Upgrade from V8.x/V9.x to V10.0 SPx ^{*)} for DVD-ROM • Upgrade from V8.x/V9.x to V10.0 SPx ^{*)} for OSD 	6SW1700-3JD00-0AA0 6SW1700-3JD00-0AG0 6SW1700-5JD00-1AC0 6SW1700-5JD00-1AH0 6SW1700-0JD00-0AB2 6SW1700-1JD00-0AA4
Drive ES PCS 7 APL V9.0 SPx ^{*)} Block library for PCS 7 for the integration of drives in APL Style (Advanced Process Library) Requirement: PCS 7 V9.0 or higher Type of delivery: DVD-ROM Languages: en, de, fr, it, es With electronic documentation		<ul style="list-style-type: none"> • Single-user license incl. 1 runtime license (DVD-ROM) • Single-user license incl. 1 runtime license (OSD) • Runtime license (on paper) • Runtime license (eCoL) • Update service for single-user license • Upgrade from V8.x/V9.x to V10.0 SPx ^{*)} for DVD-ROM • Upgrade from V8.x/V9.x to V10.0 SPx ^{*)} for OSD 	6SW1700-3JD01-0AA0 6SW1700-3JD01-0AG0 6SW1700-5JD00-1AC0 6SW1700-5JD00-1AH0 6SW1700-0JD01-0AB2 6SW1700-1JD01-0AA4
Drive ES PCS 7 V9.1 SPx ^{*)} Block library for PCS 7 for the integration of drives in Classic Style (as predecessor) Requirement: PCS 7 V9.1 or higher Type of delivery: DVD-ROM Languages: en, de, fr, it, es With electronic documentation		<ul style="list-style-type: none"> • Single-user license incl. 1 runtime license • Runtime license (on paper) • Runtime license (eCoL) • Update service for single-user license • Upgrade from V6.x/V7.x/V8.x/V9.x to V9.1 SPx ^{*)} 	6SW1700-2JD00-0AA0 6SW1700-5JD00-1AC0 6SW1700-5JD00-1AH0 6SW1700-0JD00-0AB2 6SW1700-2JD00-0AA4
Drive ES PCS 7 APL V9.1 SPx ^{*)} Block library for PCS 7 for the integration of drives in APL Style (Advanced Process Library) Requirement: PCS 7 V9.1 or higher Type of delivery: DVD-ROM Languages: en, de, fr, it, es With electronic documentation		<ul style="list-style-type: none"> • Single-user license incl. 1 runtime license • Runtime license (on paper) • Runtime license (eCoL) • Update service for single-user license • Upgrade of Drive ES PCS 7 APL V8.x, V9.x to V9.1 SPx ^{*)} or Drive ES PCS 7 V6.x, V7.x, V8.x, V9.x classic to Drive ES PCS 7 APL V9.1 SPx ^{*)} 	6SW1700-2JD01-0AA0 6SW1700-5JD00-1AC0 6SW1700-5JD00-1AH0 6SW1700-0JD01-0AB2 6SW1700-2JD01-0AA4
Drive ES PCS 7 V10.0 SPx ^{*)} Block library for PCS 7 for the integration of drives in Classic Style (as predecessor) Requirement: PCS 7 V10.0 or higher Type of delivery: DVD-ROM, OSD Languages: en, de, fr, it, es With electronic documentation		<ul style="list-style-type: none"> • Single-user license incl. 1 runtime license (DVD-ROM) • Single-user license incl. 1 runtime license (OSD) 	6SW1700-1JE00-0AA0
		Drive ES PCS 7 APL V10.0 SPx ^{*)} Block library for PCS 7 for the integration of drives in APL Style (Advanced Process Library) Requirement: PCS 7 V10.0 or higher Type of delivery: DVD-ROM, OSD Languages: en, de, fr, it, es With electronic documentation	
		<ul style="list-style-type: none"> • Single-user license incl. 1 runtime license (DVD-ROM) • Single-user license incl. 1 runtime license (OSD) • Runtime license (on paper) • Runtime license (eCoL) • Update service for single-user license • Upgrade from V8.x/V9.x to V10.0 SPx ^{*)} for DVD-ROM • Upgrade from V8.x/V9.x to V10.0 SPx ^{*)} for OSD 	6SW1700-3JD01-0AA0 6SW1700-3JD01-0AG0 6SW1700-5JD00-1AC0 6SW1700-5JD00-1AH0 6SW1700-0JD01-0AB2 6SW1700-1JD01-0AA4
		Drive ES PCS neo V3.0 / V3.1 / V4.0 Block library for SIMATIC PCS neo for the integration of SINAMICS drives Requirement: PCS neo V3.0 or higher Type of delivery at V3.0: The SINAMICS library is a component of the SIMATIC PCS neo V3.0 product. Type of delivery at V3.1 / V4.0: Integration via the import of a SINAMICS device type file (product support). License reference for the license code and the Certificate of License for the Drive ES PCS neo SINAMICS library via OSD Languages: de, en, fr, it, es, zh, ja	6SW1700-1JE01-0AH0
		Drive ES PCS neo V4.1 Add-On for SIMATIC PCS neo for the integration of SINAMICS drives Requirement: PCS neo V4.1 or higher License reference for the license code and the Certificate of License for the Drive ES PCS neo Add-On via OSD Languages: de, en, fr, it, es, zh, ja	6SW1700-2JE01-0AH0
		Drive ES PCS neo V5.0 Add-On for SIMATIC PCS neo for the integration of SINAMICS drives Requirement: PCS neo V5.0 or higher License reference for the license code and the Certificate of License for the Drive ES PCS neo Add-On via OSD Languages: de, en, fr, it, es, zh, ja	6SW1750-1CE00-0YA0
		Runtime license Drive ES PCS neo Add-On SINAMICS library To execute the function blocks for a SIMATIC PCS neo Controller Language-neutral, single license for 1 installation Type of delivery: Electronic Certificate of License (OSD)	6SW1700-1JE00-1AH0

^{*)} Orders are automatically supplied with the latest Service Pack (SP).

Drive applications

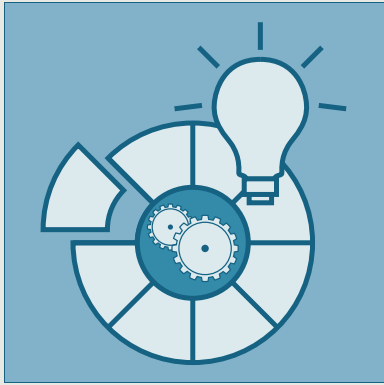

11/2 Drive applications

11/5 Conveyor technology

You can find additional information on the internet at
www.siemens.com/sinamics-applications
<https://support.industry.siemens.com>

Drive applications

Drive applications

Overview

Standard applications: Understanding and profiting from know-how

The development of standard applications is a major area of activity within the Siemens automation and drive environment. The scope of these standard applications ranges from clearly organized documentation that focuses on one or several technologies (e.g. Safety Integrated) to complete, comprehensive, standardized solutions for complex tasks (e.g. cross cutters).

Standard application requirements

One feature that all application examples have in common is that they are designed to help users help themselves. They have been created by developers with extensive tool, commissioning and application know-how to make them as user-friendly as possible. Standard applications generally provide the user with reusable components.

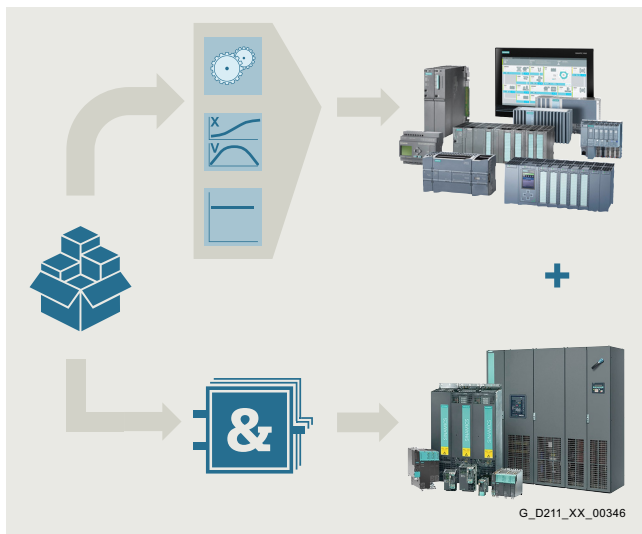

Technology functions in the higher-level control system

- Tested SIMATIC PLC blocks
- Reusable HMIs and faceplates

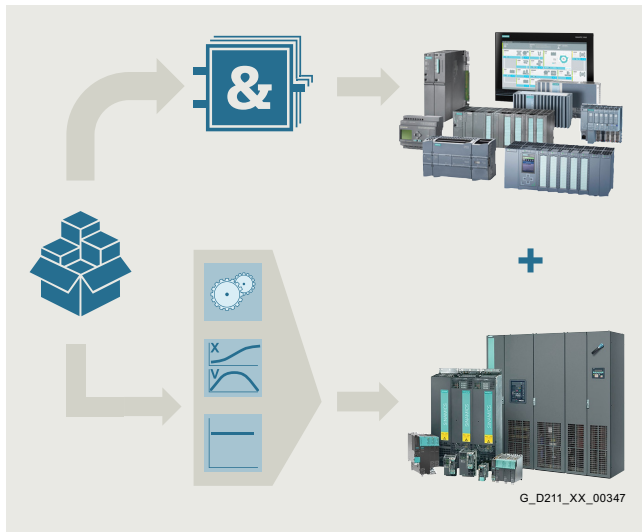

Technology functions in the drive

- Tested SIMATIC PLC blocks
- Reusable HMIs and faceplates
- Application-specific Drive Control Charts (DCC)

Expandable drive technologies

BICO 	B inector & C onconnector Technology Linkability of binary and analog signals directly in the drive (cf. with a soldering iron)
FFB 	F ree F unction B locks Fixed predefined blocks in limited number
EPOS 	E asy B asic P ositioner Completely autonomous positioning function in the drive (referencing, traversing tables, MDI, etc.)
PID 	Technology Controller Additional PID controllers for applicative process control loops

G_D011_EN_00419

Standard technology functions

TEC 	SINAMICS T echnology E xtensions Configurable functions-/technology modules for application-specific tasks to additional extension of firmware functions
DCC 	SINAMICS D rive C ontrol C hart Creating own and complex technology functions based on graphic signal processing diagrams with standard and extension libraries

G_D011_EN_00494a

Advanced technology functions

The development of standard technological applications is a dedicated area of activity within the Siemens automation and drive environment. Owing to the generally large size of the applications, they are supplied with detailed documentation and example codes.

These applications focus on the use of product features such as SINAMICS Drive Control Chart (DCC) with its Drive Control Block (DCB) libraries of DCB Standard and DCB Extension, SINAMICS Technology Extensions (TEC) and Free Function Blocks (FFB).

This enables extensive, complete and standardized solutions to be developed for complex drive tasks.

These solutions can be flexibly adapted while at the same time allowing the user to expand them with additional elements or special functions as required.

Overview

Application examples

Freely available application examples offer:

- Explanation of the necessary configuring steps with Siemens engineering tools
- Reusable standardized blocks for SIMATIC PLC
- Functionally coordinated programs and blocks
- Significantly shorter commissioning times

Various application examples also explain how to use Free Function Blocks (FFB), logic processing integrated in the drive with Drive Control Chart (DCC) and Safety Integrated.

The following application examples are just a selection of some of the many applications that are available on the internet at:

- SINAMICS G: Controlling a speed axis with the "SINA_SPEED" block
<https://support.industry.siemens.com/cs/document/109485727>
- SIMATIC S7-1200 / S7-1500: Encoderless Positioning with SINAMICS G
<https://support.industry.siemens.com/cs/document/109767951>
- Configuring Technology Objects with SIMATIC S7-1500 and SINAMICS S210 in TIA Portal
<https://support.industry.siemens.com/cs/document/109749795>
- SINAMICS S: SINAMICS S120 web server – user-defined sample pages
<https://support.industry.siemens.com/cs/document/78388880>
- SIMATIC – Fail-safe LDrvSafe library for controlling Safety Integrated Functions for the SINAMICS converter family
<https://support.industry.siemens.com/cs/document/109485794>

You can find additional information on the internet at:

www.siemens.com/sinamics-applications

<https://support.industry.siemens.com>

Drive applications

Drive applications

Integration

Overview of drive applications for SINAMICS drives, including SIMATIC ET 200pro FC-2 frequency converters

Drive applications	Low voltage									
	Standard Performance frequency converters						Distributed frequency converters			SIMATIC ET 200pro FC-2 ¹⁾
	SINAMICS						SINAMICS			
V20	G120C	G120		G130 G150		G115D	G120D			
		CU230P-2	CU240E-2	CU250S-2	CU320-2		CU240D-2	CU250D-2		
Standard technology functions										
BICO technology	✓	✓	✓	✓	✓	✓	✓	✓	✓	✓
Free Function Blocks (FFB)	✓	✓	✓	✓	✓	✓	✓	✓	✓	–
Basic positioner (EPOS)	–	–	–	–	✓	–	–	–	✓	–
Technology controller (PID)	✓	✓	✓	✓	✓	✓	✓	✓	✓	–
Advanced technology functions										
SINAMICS Drive Control Chart (DCC)	–	–	–	–	–	✓	–	–	–	–
SINAMICS Technology Extension (TEC)	–	–	–	–	–	✓	–	–	–	–
Applications & Branch know-how										

Siemens has applied these technology functions (standard and/or advanced) to generate numerous application solutions. These applications can be downloaded from the Siemens application support website at: www.siemens.com/sinamics-applications

Drive applications	Low voltage							
	Industry-specific frequency converters			Servo converters		High performance frequency converters		
	SINAMICS							
G120P	G120X	G180 ²⁾	V90	S110	S120 S120M	S150		
CU230P-2		CB08		CU305	CU310-2	CU320-2	CU320-2	
Standard technology functions								
BICO technology	✓	✓	✓	–	✓	✓	✓	✓
Free Function Blocks (FFB)	✓	✓	–	–	✓	✓	✓	✓
Basic positioner (EPOS)	–	–	–	✓	✓	✓	✓	✓
Technology controller (PID)	✓	✓	✓	–	✓	✓	✓	✓
Advanced technology functions								
SINAMICS Drive Control Chart (DCC)	–	–	–	–	–	✓	✓	✓
SINAMICS Technology Extension (TEC)	–	–	–	–	–	✓	✓	✓
Applications & Branch know-how								

Siemens has applied these technology functions (standard and/or advanced) to generate numerous application solutions. These applications can be downloaded from the Siemens application support website at: www.siemens.com/sinamics-applications

¹⁾ Information on the SIMATIC ET 200pro FC-2 frequency converter with PROFINET, PROFIBUS DP or EtherNet/IP – depending on the SIMATIC ET 200pro station – is available at: www.siemens.com/et200pro-fc

²⁾ SINAMICS G180 has its own Control Unit with its own firmware. Compared to the SINAMICS firmware, some functionalities are not available or implemented differently.

Overview**Optimal conveyor technology with Siemens products, systems and solutions**

Siemens provides what is probably the most comprehensive modular system for conveyor applications. Everything from a single source, from the control level, visualization, identification and fieldbus components all the way to motor starters, frequency converters, and motors.

Siemens provides flexible, future-oriented solutions both for standard and for highly complex applications – individually tailored to your requirements.

The integrated modular system

As a partner for everything relating to warehouse and conveyor technology, we can provide you with a quotation for conveyor and warehouse-related equipment up to complete plants for the transport of piece goods or bulk goods that precisely fit your requirements.

- Optimum products and systems – everything from drive and automation technology to safety technology and power distribution
- Competent technical guidance and extensive support to draw-up concepts that are truly fit for the future
- Global service, locally available in over 130 countries

Conveyor systems with value added

In conveyor systems, efficiency and productivity is dependent on the level of integration across all industries. Siemens provides you with everything needed for implementing integrated solutions.

More information

You can find additional information on the internet at www.siemens.com/conveyor-technology

Drive applications

Notes

11

Services and documentation

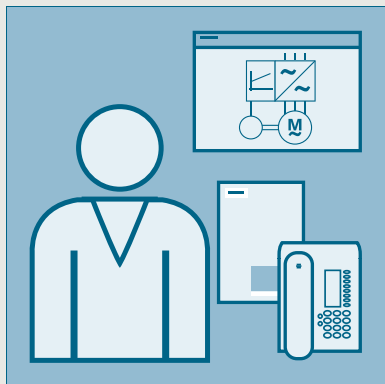

12/2	Partner
12/3	Digital Enterprise Services
12/4	Training
12/4	SITRAIN
12/6	Training courses for SINAMICS low-voltage converters
12/7	SINAMICS G115D training case
12/7	SINAMICS G120D training case
12/8	Switchgear
12/11	Applications
12/12	Supplementary products for distributed drive technology
12/13	mySupport documentation
12/14	Documentation
12/14	General documentation

Services and documentation

Partner

Overview

Partners at Siemens

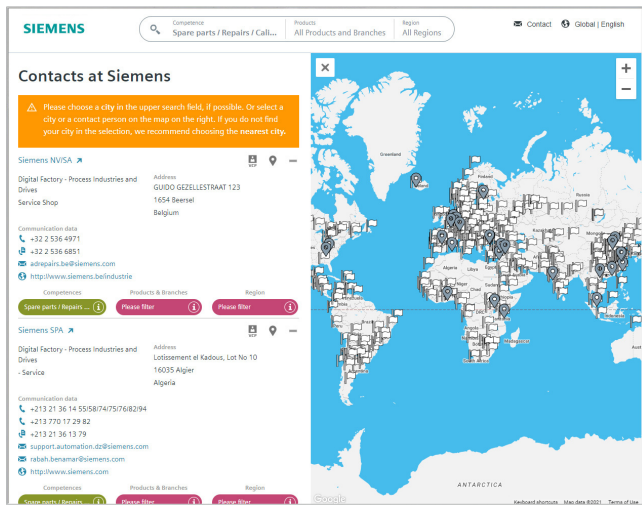

At your service locally, around the globe for consulting, sales, training, service, support, spare parts on the entire portfolio of Siemens.

Your partner can be found in our Personal Contacts Database at: www.siemens.com/automation-contact

You start by selecting

- the required competence,
- products and branches,
- a country and a city

or by a

- location search or free text search

Overview

Digital Enterprise Services

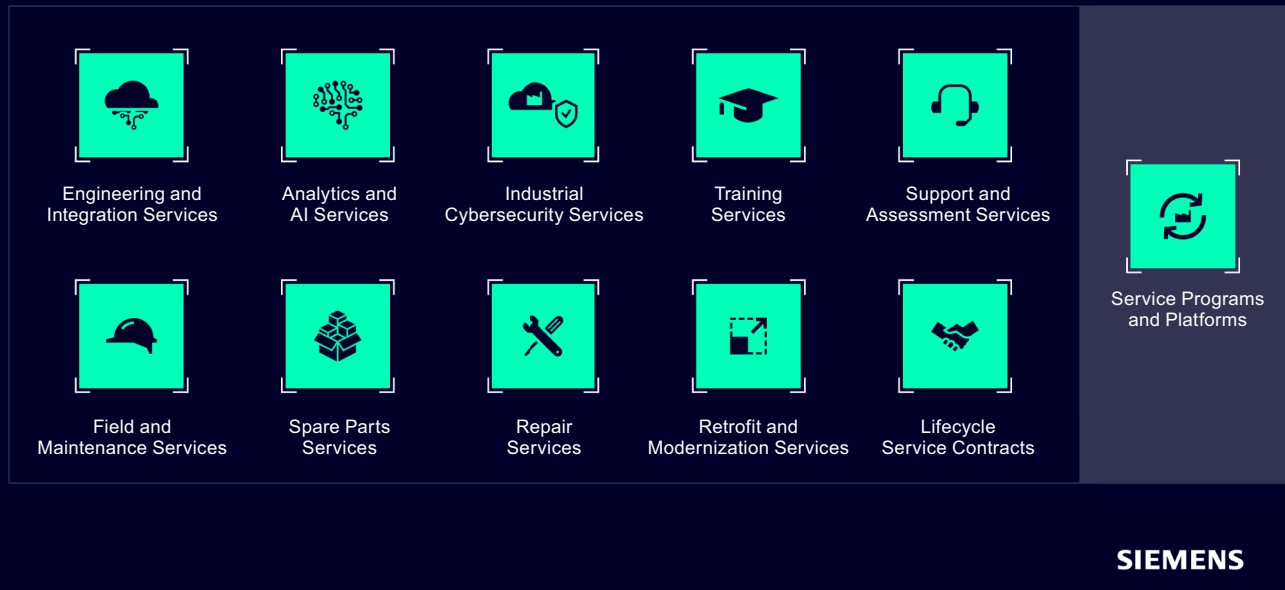

At Digital Enterprise Services, we provide you with comprehensive services throughout the entire lifecycle. From a fully digital factory to a reliable spare parts supply and quick support in the event of outages, we work with our partners to ensure your plant operates optimally – improving availability, productivity, and efficiency.

Our services take industry to the next level and give you a competitive edge:

- **Services for Digital Transformation:** Our innovative and scalable services streamline operations by optimizing your Overall Equipment Effectiveness (OEE), increasing productivity, preventing outages and improving business continuity – all while supporting IT/OT convergence.
- **Services for Sustainability:** Our optimization and lifetime extension services help make your sustainability goals a reality by providing data-driven insights into energy use, enabling you to reduce your carbon footprint and costs. By enabling a circular economy and focusing on product safety, cybersecurity, and supply chain visibility, we extend asset life, save resources, and improve operational efficiency.
- **Lifecycle Services:** Our innovative Lifecycle Services provide reliable support worldwide, offering tailored solutions throughout their entire lifecycle. By optimizing maintenance processes, we improve asset performance, efficiency, reliability, and productivity – from machines to entire plants or factories.

For more information, please visit us at:

www.siemens.com/digital-enterprise-services

www.siemens.com/find-your-service

Dienstleistungen und Dokumentation

Training

SITRAIN

Introduction

Learn the way you like it – with SITRAIN

SITRAIN imparts a wide range of technical knowledge for all industries and applications. Our offering is oriented toward the needs of learners and the demands of innovative companies. Get pleasure out of learning - thanks to innovative learning methods, personal support, and knowledge that will help you in your work and further development. For successful, flexible, and continuous learning.

Education and training directly from the manufacturer

SITRAIN provides you with training from the industrial product and solution portfolio from Siemens and benefits from 30 years of expertise in technical training. Take a look at the many options for expanding your knowledge with SITRAIN and find the course that meets your needs! The following training and further education units are available to you for your individual knowledge building:



Industrial Automation Systems SIMATIC

Training available for:
SIMATIC S7-1500, TIA Portal,
SIMATIC S7-300/400,
SIMATIC S7-1200



Drive Technology

Training available for:
SINAMICS S120 and
SINAMICS G120 low-voltage
converters,
SINAMICS G130 / G150 /
G180 / S150



SINUMERIK CNC automation system

Training available for:
SINUMERIK 840D, SINUMERIK
840D sl and SINUMERIK ONE



Process Control Systems

Training available for:
SIMATIC PCS 7,
SIMATIC PCS neo

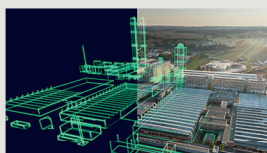

Digital Enterprise

Training available for:
Openness, SIMIT, OPC UA,
Industrial Edge,
Virtual commissioning



Industrial Communications

Training available for:
PROFINET, SCALANCE,
RUGGEDCOM, Industrial Ethernet,
Fieldbus communication,
Industrial Security,
Remote
communication



Identification and Locating

Training available for:
RFID, RTLS-Systems



Operator Control and Monitoring Systems

Training available for:
SIMATIC WinCC Unified in TIA
Portal, SIMATIC WinCC in TIA
Portal, SIMATIC WinCC V7x



Motion Control System SIMOTION

Training available for:
SIMOTION (Programming,
Commissioning, Diagnostics,
Service)



Smart Infrastructure

Training available for:
SIRIUS, SENTRON, SIVACON,
ALPHA, SIMOCODE,
Circuit breakers

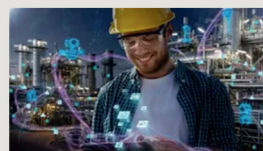

Process Analytics & Instrumentation

Training is available for process
analytics and instrumentation,
explosion protection, process
gas chromatographs



Additional training offer

SIMOVE with Automated
Guided Vehicles (AGV),
SIPLUS CMS, Guidelines and
standards for control cabinets

Introduction

Different learning formats and methods for maximum learning success

With our SITRAIN training formats, you learn in the way that best suits your preferences and routine. You decide whether you would rather take online training or face-to-face training. It is up to you whether you would like to study on demand or at fixed times.

With a personal learning consultant, in the team, or on your own – you can explore all the possibilities.

Discover our three learning formats:



Learning Event

SITRAIN Learning Events are the perfect choice when you want to achieve a defined learning goal in the shortest possible time. You learn in a protected learning environment outside of the daily work routine under the guidance of a learning consultant - virtually, in the training center, or at your company.



**Learning Membership
SITRAIN Access**

With SITRAIN access, you enter a world of extensive and constantly expanding self-study units on our digital learning platform for industry. With SITRAIN access, you can implement a modern learning culture in your team or company with independent and continuous learning.

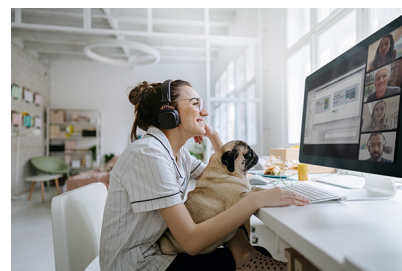

Learning Journey

The Learning Journey is the perfect combination of units taken live and self-study units for sustainable learning success. The modular approach enables simple integration into your daily work. This also includes one-year membership for using the SITRAIN access digital learning platform.

<p>Live</p>	<p>Self-reliant</p>	<p>On demand</p>	<p>Individual</p>
<p>Learn together with others, simultaneously and guided by a learning consultant. Online, in the SITRAIN training center or at your company.</p>	<p>Expand your knowledge self-determined with industry learning and work on your learning units at your own pace and according to your own schedule.</p>	<p>Get the knowledge you need, exactly when you need it. Be it to answer a current question or to work on a special topic.</p>	<p>Talk directly with the learning consultant, clarify detailed questions and get personal coaching for transferring the learned topics to your own application.</p>



Training cases catalog
<https://www.siemens.com/sitrain-catalog-training-cases>

www.siemens.com/sitrain

Find your local offer here



Services and documentation

Training

Training courses for SINAMICS low-voltage converters

Overview

Training courses for SINAMICS drive system



This provides an overview of the training courses available for the SINAMICS drive system.

The courses are modular in design and are directed at a variety of target groups as well as individual customer requirements.

The system overview will acquaint decision-makers and sales personnel with the system very quickly.

The engineering course provides all the information you need to configure the drive system.

The courses dedicated to diagnostics and servicing, parameterization and commissioning, communication as well as extended functions such as Safety Integrated are sure to provide all the technical knowledge service engineers will need.

All courses contain as many practical exercises as possible to enable intensive and direct training on the drive system and with the tools in small groups.

Please also take note of the training options available for SIMOTICS motors. You will find more information about course contents and dates on the internet.

Title	Target group			Duration	Order code
(all courses are available in English and German)	Planners, decision-makers, sales personnel	Commissioning engineers, configuring engineers	Service personnel, maintenance technicians		
Course Fundamentals and overview					
SINAMICS and SIMOTICS – Basics of Drive Technology	✓	✓	✓	5 days	DR-BASIC
Courses SINAMICS S120					
SINAMICS S120 Parameterizing and Commissioning with STARTER	–	✓	–	5 days	DR-S12-PM
SINAMICS S120 Parameterizing and Commissioning in the TIA Portal	–	✓	–	5 days	DR-S12-PMT
SINAMICS S120 Parameterizing Safety Integrated	–	✓	–	4 days	DR-S12-SAF
SINAMICS S120 Parameterizing and Optimization	–	✓	–	5 days	DR-S12-OPT
SINAMICS S120 Diagnostics and Service	–	–	✓	5 days	DR-S12-DG
SINAMICS S120 Diagnostics and Service in the TIA Portal	–	–	✓	5 days	DR-S12-DGT
SINAMICS S120 Diagnostics on Chassis and Cabinet Units	–	✓	✓	3 days	DR-S12-CHA
Courses SINAMICS S210					
SINAMICS S120 Parameterizing and Commissioning with STARTER	–	✓	✓	2 days	DR-S210
Course SINAMICS G120 (including SINAMICS G120X, SINAMICS G120D and SINAMICS G115D)					
Parameterizing and Commissioning	–	✓	–	2 days	DR-G12-PM
Courses SINAMICS G130/G150/G180/S150					
SINAMICS G150/G130/S150 – Diagnostics and Service	–	✓	✓	5 days	DR-G15-DG
SINAMICS G180 – Parameterizing and Service	–	–	✓	2.5 days	DR-G18-DG
Course SINAMICS G220					
SINAMICS G220 – Commissioning and Service	–	✓	✓	5 days	DR-G15-DG

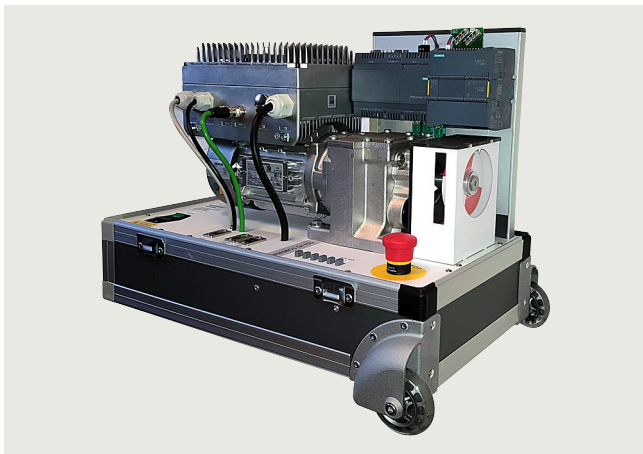
SINAMICS G115D training case
Overview

SINAMICS G115D training case

The SINAMICS G115D training case is a convincing demonstration system thanks to its compact design. It is suitable for direct customer presentations as well as for testing in the technical department. The functions of SINAMICS G115D in combination with a geared motor can be demonstrated and tested quickly and easily with this case.

It contains the following components:

- SINAMICS G115D distributed drive system, PROFINET, frame size FSA, 0.37 kW
- Helical geared motor
- SIMATIC S7-1200F controller
- MindConnect IoT 2040

The SINAMICS G115D training case is supplied in the form of a trolley case.

Technical specifications

	SINAMICS G115D training case 6AG1067-1AA38-0AA0
Supply voltage	110 V / 230 V 1 AC
Dimensions	
• Width	630 mm (24.80 in)
• Height	430 mm (16.93 in)
• Depth	480 mm (18.90 in)
Weight, approx.	43.5 kg (95.9 lb)

Selection and ordering data

Description	Article No.
SINAMICS G115D training case	6AG1067-1AA38-0AA0

SINAMICS G120D training case
Overview

SINAMICS G120D training case

The SINAMICS G120D training case contains the following components:

- SINAMICS G120D distributed frequency converter
 - PM250D Power Module
 - CU250D Control Unit
- SIMATIC S7-300 controller
- SIMATIC Touch Panel KTP600
- Helical geared motor with HTL encoder

The SINAMICS G120D training case is supplied in the form of a trolley case.

Technical specifications

	SINAMICS G120D training case 6AG1067-2AA00-0AA2
Supply voltage	3 AC 400 V
Protection	16 A
Dimensions	
• Width	720 mm (28.35 in)
• Height	380 mm (14.96 in)
• Depth	300 mm (11.81 in)
Weight, approx.	47 kg (104 lb)

Selection and ordering data

Description	Article No.
SINAMICS G120D training case	6AG1067-2AA00-0AA2

Services and documentation

Switchgear

Overview

Systems Engineering Plant Chemnitz (WKC) - Electrical equipment for machines and plants

The Siemens Systems Engineering Plant Chemnitz (WKC) is the European market leader in control cabinet construction for machine tools and manufactures equipment for numerous segments the machine and plant construction industry, as well as for project business in the logistics and automotive sectors.



WKC - Control cabinet wiring

Scope of services offered

The WKC offers a complete portfolio of services for development and production: From concept support and hardware engineering, construction including complete material procurement to testing, advance commissioning support and worldwide in-bound delivery. Each customer decides individually what extent of these services the WKC is to provide.



WKC - Engineering - SSB

Competence center for standardization and air conditioning

The WKC is also competence center for the air conditioning of switchgear, has its own test laboratory, and is a certified UL Panels shop. Siemens WKC therefore is happy to support you with advice on design in accordance with standards and concepts for your drive systems, control, operation and safety. In addition, our engineers configure for you in EPLAN and other CAD systems, execute Design-To-Cost projects, and adapt your documents where necessary to UL or new automation and digitalization technologies.



WKC - Test laboratory - Heat measurement

Overview

Individual support and maximum flexibility

Our technical consultants for complete equipment support customers and sales departments in the various regions. Our customers are supported by job centers and permanently assigned manufacturing teams. As a customer, you will benefit from individual logistics models, flexible production capacities and production areas, change management in all process phases, as well as maximum flexibility for your orders..

Distance is no problem: For coordination with our customers, we use various digital communication and business applications with user-friendly and powerful functions for screensharing, videoconferencing, file transfer, as well as all options for a customer acceptance via webcam (mobile circuit meeting room).



WKC - Automated testing SICAT

Your advantages

We offer complete services from a single source with Siemens quality and stability, extensive specialist support, and flexible resources. We will be glad to accompany you into international markets as well. With us you have a strong partner at your side - from the design stage to final delivery. Whether for series or individual units, Siemens WKC works together with you to implement your projects according to your requirements.

Overview of the portfolio of services

Order coordination

- Project manager with permanent customer assignment
- Complete material purchasing
- Change management in all process phases

Manufacturing

- Creation of a digital twin
- CNC processing of enclosure parts and mounting plates
- In-house painting
- Auto-routing of the wiring
- Automated prefabrication of cables
- Production teams with permanent customer assignment
- Batch or flow production

Automated test (standard)

- Current path test
- Function of switching, operating and signaling devices
- Observance of protective measures and safety

Optional test services / pre-commissioning

- Error-free function of the programmable controllers / I/O devices
- Parameterization and checking of bus systems
- First commissioning of Siemens NC and PLC
- Installation of customer software



WKC - Collaborative robotics

Services and documentation

Switchgear

Overview

Additional services for different project phases

Our portfolio is supplemented by a host of additional services for many different project phases.

Planning

- Evaluation of requirement specifications, requirements
- Advice regarding standard applications and certifications (conformity)
- Advice regarding EMC, air conditioning, and electrical safety
- Design-To-Cost analyses
- Special rated conditions

Implementation/realization

- Creation of an electrical design in various CAE systems
- Creation of an air conditioning design through calculation and simulation
- CAE revision of production documents

Validation/certification

- International standard and certification know-how, e.g.: IEC 60204-1, IEC 61439, UL or cULus
- Checking of air conditioning / EMC designs in own Siemens laboratory or at customer premises
- Execution of EMC precompliance measurements in own laboratory or at your plant location

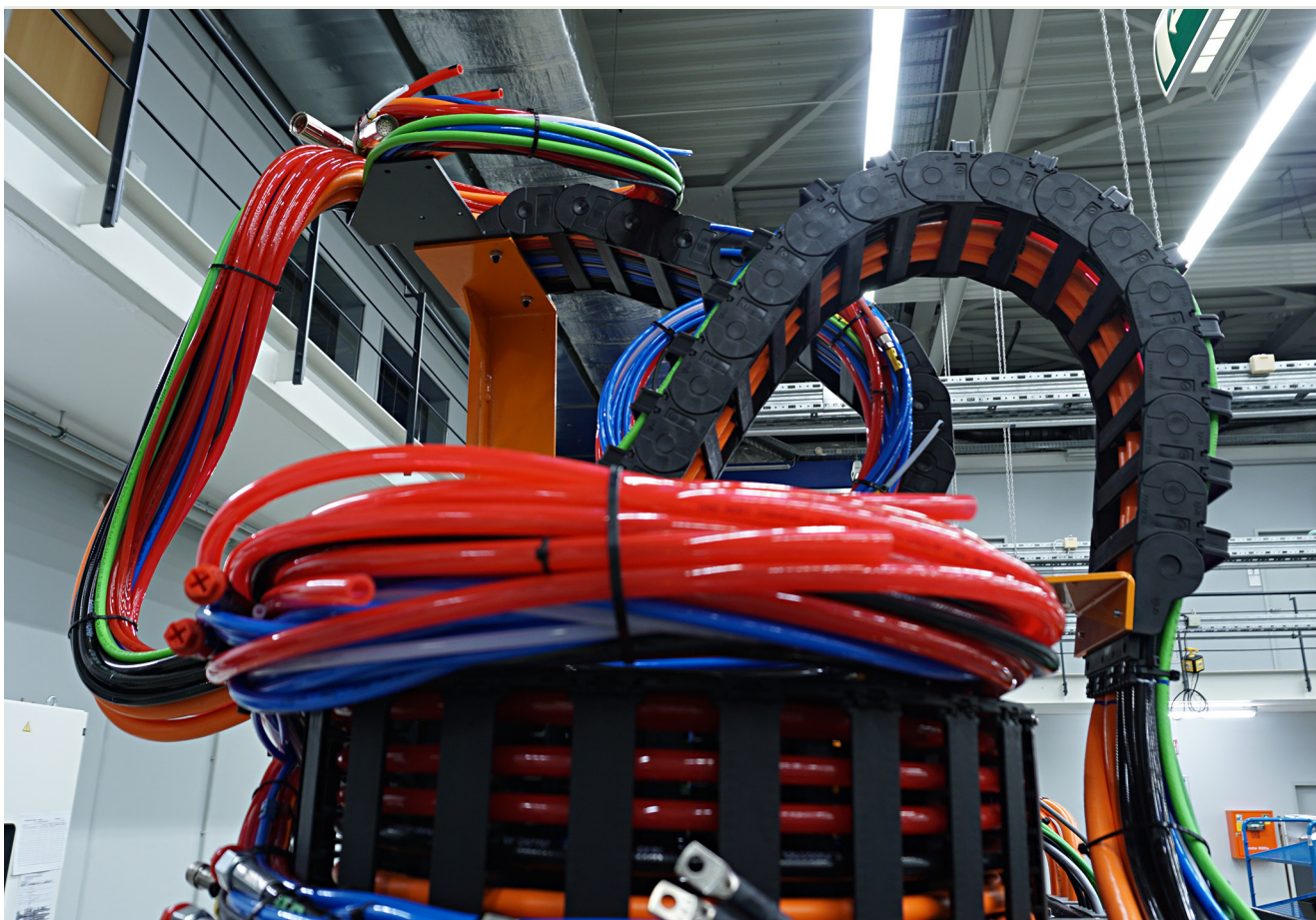

WKC - Additional service - Festoon cable system

More information

You can find additional information on the internet at:

www.siemens.com/panelbuilding

Or contact us by

email: info.wkc.industry@siemens.com

Overview



Our understanding of an application is the customer-specific solution of an automation task based on standard hardware and software components. In this respect, industry knowledge and technological expertise are just as important as expert knowledge about how our products and systems work. We are setting ourselves this challenge with more than 280 application engineers in 20 countries.

Application centers

We currently have application centers in:

- Germany: Head Office in Erlangen and in other German regions, e.g. in Munich, Nuremberg, Stuttgart, Mannheim, Frankfurt, Chemnitz, Cologne, Bielefeld, Bremen, Hanover, Hamburg
- Belgium: Brussels
- Brazil: Sao Paulo
- China: Beijing and 12 regions
- Denmark: Ballerup
- France: Paris
- Great Britain: Manchester
- India: Mumbai
- Italy: Bologna, Milan
- Japan: Tokyo, Osaka
- The Netherlands: The Hague
- Austria: Vienna
- Poland: Warsaw
- Sweden: Göteborg
- Switzerland: Zurich, Lausanne
- Spain: Madrid
- South Korea: Seoul
- Taiwan: Taipei
- Turkey: Istanbul
- USA: Atlanta

These application centers specialize in the use of SIMATIC/SIMOTION/SINAMICS. You therefore can rely on automation and drive specialists for implementing successful applications. By involving your personnel at an early stage in the process, we can provide a solid basis for rapid knowledge transfer, maintenance and further development of your automation solution.

Advice on applications and implementation

We offer a variety of consultation services to help you find the optimum solution for the SIMATIC/SIMOTION/SINAMICS application you want to implement:

The quotation phase includes

- clarification of technical questions,
- discussion of machine concepts and customer-specific solutions,
- selection of suitable technology and
- suggestions for implementation.

A technical feasibility study is also performed at the outset. In this way, difficult points of the application can be identified and solved early on. We can also configure and implement your application as a complete solution from a single source.

A large number of proven standard applications are available for use during the implementation phase. This saves engineering costs.

The system can be commissioned by experienced, competent personnel, if required. This saves time and trouble.

If servicing is required, we can support you on site or remotely. For further information about servicing, please see the section "Industry Services".

On-site application training

Training for the implemented applications can also be organized and carried out on site. This training for machine manufacturers and their customers does not deal with individual products, but the entire hardware and software system (for example, automation, drives and visualization).

From an initial concept to successful installation and commissioning: We provide complete support for SIMATIC/SIMOTION/SINAMICS! Contact your Siemens representative.

You can find further information at www.siemens.com/machinebuilding

Services and documentation

Supplementary products for distributed drive technology

Overview

A comprehensive range of supplementary products is provided for the distributed drive technology, e.g. pre-assembled cables and connectors. An overview is provided at the following link:
www.siemens.com/distributeddrives-supplementaryproducts

Overview

mySupport documentation – Compiling personal documents

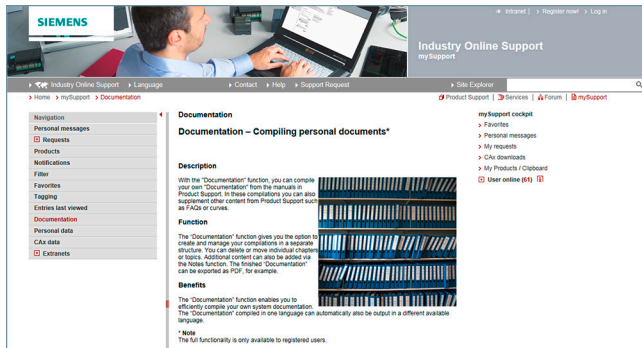

mySupport documentation is a web-based system for generating personalized documentation based on standard documents and is part of the Siemens Industry Online Support portal.

In mySupport, a personal document library can be created in the "Documentation" category. This library can be accessed online in mySupport or also be generated in various formats for offline use.

Previously, this functionality was available in the My Documentation Manager for configurable manuals. Due to the integration in mySupport, all entries of the Industry Online Support can now be imported into the personal document library, including FAQs or product notifications.

If you have already worked with the My Documentation Manager, all of the previously created libraries will continue to be available without restrictions in mySupport.

In addition, the personal library in mySupport can be shared with other mySupport users. In this way, a collection of relevant documents can be created very effectively and used together with other mySupport users all over the world.

You must register/log in for configuring and generating/managing.

Benefits

- Display
View, print or download standard documents or personalized documents
- Configure
Transfer standard documents or parts of them to personalized documents
- Generate/Manage
Generate and manage personalized documents in the formats PDF, RTF or XML in all available languages

Function

Opening mySupport documentation in the Industry Online Support portal

- About the product support, entry type "Manual":
<https://support.industry.siemens.com/cs/ww/en/ps/man>
By clicking on the required version of the manual and then "Show and configure", the manual opens in a modular view, where you can navigate from topic to topic. Here the direct link to a topic can be used and made available to other users. The selected document can be added to the personal library via "mySupport Cockpit" > "Add to mySupport documentation".
- Via the direct link
<https://support.industry.siemens.com/my/ww/en/documentation/advanced>
After login/registration, the online help is displayed as the current document.

More information

You can find additional information on the internet at

- <https://support.industry.siemens.com/my/ww/en/documentation>
- https://support.industry.siemens.com/cs/helpcenter/en/index.htm?#persoenliche_bibliothek_aufbauen.htm

Services and documentation

Documentation

General documentation

Overview

A high-quality programmable control or drive system can be used to maximum effect only if the user is aware of the performance of the products used as a result of intensive training and good technical documentation.

This is becoming more important due to the shorter innovation cycles of modern automation products and the convergence of electronics and mechanical engineering.

A comprehensive range of documentation is available which includes a Getting Started guide, operating instructions, installation manuals and a list manual.

The documents are available in hardcopy form or as a PDF file for downloading from the internet.

In addition to technical information for SINUMERIK, SINAMICS, SIMOTION and SIMOTICS, the documentation is available for download as a PDF file on the Internet

- SINUMERIK
<https://support.industry.siemens.com/cs/document/108464614>
- SINAMICS
<https://support.industry.siemens.com/cs/document/109807358>
- SIMOTION
<https://support.industry.siemens.com/cs/document/109479653>
- SIMOTICS
<https://support.industry.siemens.com/cs/document/109813641>

Application

Explanations of the manuals:

- **Operating Instructions**
contain all the information needed to install the device and make electrical connections, information about commissioning and a description of the converter functions.
Phases of use: Control cabinet construction, commissioning, operation, maintenance and servicing.
- **Hardware Installation Manual**
contains all relevant information about the intended use of the components of a system (technical specifications, interfaces, dimensional drawings, characteristics, or possible applications), information about installation and electrical connections and information about maintenance and servicing.
Phases of use: Control cabinet configuration/construction, maintenance and servicing.
- **Operating and Installation Instructions** (for converter and accessories)
contain all relevant information about the intended use of the components, such as technical specifications, interfaces, dimensional drawings, characteristics, or possible applications.
Phases of use: Control cabinet configuration/construction.
- **Manual/Configuration Manual**
contains all necessary information about the intended use of the components of a system, e.g. technical specifications, interfaces, dimensional drawings, characteristics, or possible applications.
Phases of use: Cabinet configuration/setup, circuit diagram configuration/drawing.
- **Commissioning Manual**
contains all information relevant to commissioning after installation and wiring. It also contains all safety and warning notices relevant to commissioning in addition to overview drawings.
Phases of use: Commissioning of components that have already been connected, configuration of system functions.
- **List Manual**
contains all parameters, function diagrams, and faults/alarms for the product/system as well as their meanings and setting options. It contains parameter data and fault/alarm descriptions with functional correlations.
Phases of use: Commissioning of components that have already been connected, configuration of system functions, fault cause/diagnosis.
- **Getting Started**
provides information about getting started for the first-time user as well as references to additional information. It contains information about the basic steps to be taken during commissioning. The information in the other documentation should be carefully observed for all of the other work required.
Phases of use: Commissioning of components that have already been connected.
- **Function Manual Drive Functions**
contains all the relevant information about individual drive functions: Description, commissioning and integration in the drive system.
Phases of use: Commissioning of components that have already been connected, configuration of system functions.

Appendix



13/2	Certificates of suitability
13/4	Software licenses
13/6	Conversion tables
13/9	Conditions of sale and delivery/Export regulations

Appendix

Certificates of suitability







Overview

Many of the products in this Catalog fulfill requirements, e.g. for UL, CSA or FM and are labeled with the corresponding approval designation.

All of the certificates of suitability, approvals, certificates, declarations of conformity, test certificates, e.g. CE, UL, Safety Integrated etc. have been performed with the associated system components as they are described in the Catalogs and Configuration Manuals.





The certificates are only valid if the products are used with the described system components, are installed according to the Installation Guidelines and used for their intended purpose.

In other cases, the vendor of these products is responsible for arranging for the issue of new certificates.

Test code	Tested by	Device series/ Component	Test standard	Product category/ File-No.
UL: Underwriters Laboratories <i>Independent public testing body in North America</i>				
	UL according to UL standard	SINUMERIK	Standard UL 508, CSA C22.2 No. 142	NRAQ/7.E164110 NRAQ/7.E217227
		SIMOTION	Standard UL 508, CSA C22.2 No. 142	NRAQ/7.E164110
	UL according to CSA standard	SINAMICS	Standard UL 508, 508C, 61800-5-1 CSA C22.2 No. 142, 274	NRAQ/7.E164110, NMMS/2/7/8.E192450, NMMS/2/7/8.E203250, NMMS/7.E214113, NMMS/7.E253831
	UL according to UL and CSA standards			NMMS/2/7/8.E121068 NMMS/7.E355661 NMMS/7.E323473
	UL according to UL standard	SIMODRIVE	Standard UL 508C, CSA C22.2 No. 274	NMMS/2/7/8.E192450 NMMS/7.E214113
	UL according to CSA standard	SIMOTICS	Standard UL 1004-1, 1004-6, 1004-8, CSA C22.2 No. 100	PRGY2/8.E227215 PRHZ2/8.E93429 PRHJ2/8.E342747
	UL according to UL and CSA standard			PRGY2/8.E253922 PRHZ2/8.E342746
		Line/motor reactors	Standard UL 508, 506, 5085-1, 5085-2, 1561, CSA C22.2 No. 14, 47, 66.1-06, 66.2-06	XQNX2/8.E257859 NMTR2/8.E219022 NMMS2/8.E333628 XPTQ2/8.E257852 XPTQ2/8.E103521 NMMS2/8.E224872 XPTQ2/8.E354316 XPTQ2/8.E198309 XQNX2/8.E475972
		Line filters, dv/dt filters, sine-wave filters	UL 1283, CSA C22.2 No. 8	FOKY2/8.E70122
		Resistors	UL 508, 508C, CSA C22.2 No. 14, 274	NMTR2/8.E224314 NMMS2/8.E192450 NMTR2/8.E221095 NMTR2/8.E226619
TUV: TÜV Rheinland of North America Inc. <i>Independent public testing body in North America, Nationally Recognized Testing Laboratory (NRTL)</i>				
TÜV: TÜV SÜD Product Service <i>Independent public testing body in Germany, Nationally Recognized Testing Laboratory (NRTL) for North America</i>				
	TUV according to UL and CSA standards	SINAMICS	NRTL Listing according to standard UL 508C	U7V 12 06 20078 013 U7 11 04 20078 009 U7 11 04 20078 010 U7 11 04 20078 011
		SIMOTION	NRTL Listing according to standard UL 508	U7V 13 03 20078 01
		SIMODRIVE	NRTL Listing according to standard UL 508C, CSA C22.2. No. 14	CU 72090702
		Motion Control Encoder	NRTL Listing according to UL 61010-1 CSA C22.2 No. 61010-1	U8V 10 06 20196 024

Certificates of suitability

Overview

Test code	Tested by	Device series/ Component	Test standard	Product category/ File-No.
CSA: Canadian Standards Association <i>Independent public testing body in Canada</i>				
	CSA according to CSA standard	SINUMERIK	Standard CSA C22.2 No. 142	2252-01 : LR 102527
FMRC: Factory Mutual Research Corporation <i>Independent public testing body in North America</i>				
	FM according to FM standard	SINUMERIK	Standard FMRC 3600, FMRC 3611, FMRC 3810, ANSI/ISA S82.02.1	–
EAC: <i>Independent public testing body within the Eurasian conformity region</i>				
	EAC in accordance with EAC Directive	SINAMICS SINUMERIK SIMOTION	Standard IEC 61800-5-1/-2, IEC 61800-3	–
RCM: Australian Communications and Media Authority <i>Independent public testing body in Australia</i>				
	RCM according to EMV standard	SINAMICS SINUMERIK SIMOTION	Standard IEC AS 61800-3, EN 61800-3	–
KC: National Radio Research Agency <i>Independent public testing body in South Korea</i>				
	KC according to EMV standard	SINAMICS SINUMERIK SIMOTION	Standard KN 11	–
BIA <i>Federal Institute for Occupational Safety</i>				
–	Functional safety	SINAMICS SINUMERIK SIMOTION	Standard EN 61800-5-2	–
TÜV SÜD Rail				
–	Functional safety	SINAMICS SINUMERIK SIMOTION	Standard EN 61800-5-2	–

More information about certificates can be found online at:
<https://support.industry.siemens.com/cs/ww/en/ps/cert>

Appendix

Software licences

Overview

Software types

Software requiring a license is categorized into types. The following software types have been defined:

- Engineering software
- Runtime software

Engineering software

This includes all software products for creating (engineering) user software, e.g. for configuring, programming, parameterizing, testing, commissioning or servicing.

Data generated with engineering software and executable programs can be duplicated for your own use or for use by third-parties free-of-charge.

Runtime software

This includes all software products required for plant/machine operation, e.g. operating system, basic system, system expansions, drivers, etc.

The duplication of the runtime software and executable programs created with the runtime software for your own use or for use by third-parties is subject to a charge.

You can find information about license fees according to use in the ordering data (e.g. in the catalog). Examples of categories of use include per CPU, per installation, per channel, per instance, per axis, per control loop, per variable, etc.

Information about extended rights of use for parameterization/configuration tools supplied as integral components of the scope of supply can be found in the readme file supplied with the relevant product(s).

License types

Siemens Digital Industries and Smart Infrastructure offers various types of software license:

- Floating license
- Single license
- Rental license
- Rental floating license
- Trial license
- Demo license
- Demo floating license

Floating license

The software may be installed for internal use on any number of devices by the licensee. Only the concurrent user is licensed. The concurrent user is the person using the program. Use begins when the software is started. A license is required for each concurrent user.

Single license

Unlike the floating license, a single license permits only one installation of the software per license.

The type of use licensed is specified in the ordering data and in the Certificate of License (CoL). Types of use include for example per instance, per axis, per channel, etc.

One single license is required for each type of use defined.

Rental license

A rental license supports the "sporadic use" of engineering software. Once the license key has been installed, the software can be used for a specific period of time (the operating hours do not have to be consecutive).

One license is required for each installation of the software.

Rental floating license

The rental floating license corresponds to the rental license, except that a license is not required for each installation of the software. Rather, one license is required per object (for example, user or device).

Trial license

A trial license supports "short-term use" of the software in a non-productive context, e.g. for testing and evaluation purposes. It can be transferred to another license.

Demo license

The demo license support the "sporadic use" of engineering software in a non-productive context, for example, use for testing and evaluation purposes. It can be transferred to another license. After the installation of the license key, the software can be operated for a specific period of time, whereby usage can be interrupted as often as required.

One license is required per installation of the software.

Demo floating license

The demo floating license corresponds to the demo license, except that a license is not required for each installation of the software. Rather, one license is required per object (for example, user or device).

Certificate of License (CoL)

The CoL is the licensee's proof that the use of the software has been licensed by Siemens. A CoL is required for every type of use and must be kept in a safe place.

Downgrading

The licensee is permitted to use the software or an earlier version/release of the software, provided that the licensee owns such a version/release and its use is technically feasible.

Delivery versions

Software is constantly being updated. The following delivery versions

- PowerPack
- Upgrade

can be used to access updates.

Existing bug fixes are supplied with the ServicePack version.

PowerPack

PowerPacks can be used to upgrade to more powerful software. The licensee receives a new license agreement and CoL (Certificate of License) with the PowerPack. This CoL, together with the CoL for the original product, proves that the new software is licensed.

A separate PowerPack must be purchased for each original license of the software to be replaced.

Upgrade

An upgrade permits the use of a new version of the software on the condition that a license for a previous version of the product is already held.

The licensee receives a new license agreement and CoL with the upgrade. This CoL, together with the CoL for the previous product, proves that the new version is licensed.

A separate upgrade must be purchased for each original license of the software to be upgraded.

Overview**ServicePack**

ServicePacks are used to debug existing products. ServicePacks may be duplicated for use as prescribed according to the number of existing original licenses.

License key

Siemens Digital Industries and Smart Infrastructure supplies software products with and without license keys.

The license key serves as an electronic license stamp and is also the "switch" for activating the software (floating license, rental license, etc.).

The complete installation of software products requiring license keys includes the program to be licensed (the software) and the license key (which represents the license).

Software Update Service (SUS)

As part of the SUS contract, all software updates for the respective product are made available to you free of charge for a period of one year from the invoice date. The contract will automatically be extended for one year if it is not canceled three months before it expires.

The possession of the current version of the respective software is a basic condition for entering into an SUS contract.

You can download explanations concerning license conditions from https://mall.industry.siemens.com/legal/ww/en/terms_of_trade_en.pdf

Appendix

Conversion tables

Rotary inertia (to convert from A to B, multiply by entry in table)

A \ B	lb-in ²	lb-ft ²	lb-in-s ²	lb-ft-s ² slug-ft ²	kg-cm ²	kg-cm-s ²	gm-cm ²	gm-cm-s ²	oz-in ²	oz-in-s ²
lb-in ²	1	6.94×10^{-3}	2.59×10^{-3}	2.15×10^{-4}	2.926	2.98×10^{-3}	2.92×10^3	2.984	16	4.14×10^{-2}
lb-ft ²	144	1	0.3729	3.10×10^{-2}	421.40	0.4297	4.21×10^5	429.71	2304	5.967
lb-in-s ²	386.08	2.681	1	8.33×10^{-2}	1.129×10^3	1.152	1.129×10^6	1.152×10^3	6.177×10^3	16
lb-ft-s ² slug-ft ²	4.63×10^3	32.17	12	1	1.35×10^4	13.825	1.355×10^7	1.38×10^4	7.41×10^4	192
kg-cm ²	0.3417	2.37×10^{-3}	8.85×10^{-4}	7.37×10^{-5}	1	1.019×10^{-3}	1000	1.019	5.46	1.41×10^{-2}
kg-cm-s ²	335.1	2.327	0.8679	7.23×10^{-2}	980.66	1	9.8×10^5	1000	5.36×10^3	13.887
gm-cm ²	3.417×10^{-4}	2.37×10^{-6}	8.85×10^{-7}	7.37×10^{-8}	1×10^{-3}	1.01×10^{-6}	1	1.01×10^{-3}	5.46×10^{-3}	1.41×10^{-5}
gm-cm-s ²	0.335	2.32×10^{-3}	8.67×10^{-4}	7.23×10^{-5}	0.9806	1×10^{-3}	980.6	1	5.36	1.38×10^{-2}
oz-in ²	0.0625	4.34×10^{-4}	1.61×10^{-4}	1.34×10^{-5}	0.182	1.86×10^{-4}	182.9	0.186	1	2.59×10^{-3}
oz-in-s ²	24.13	0.1675	6.25×10^{-2}	5.20×10^{-3}	70.615	7.20×10^{-2}	7.09×10^4	72.0	386.08	1

Torque (to convert from A to B, multiply by entry in table)

A \ B	lb-in	lb-ft	oz-in	N-m	kg-cm	kg-m	gm-cm	dyne-cm
lb-in	1	8.333×10^{-2}	16	0.113	1.152	1.152×10^{-2}	1.152×10^3	1.129×10^6
lb-ft	12	1	192	1.355	13.825	0.138	1.382×10^4	1.355×10^7
oz-in	6.25×10^{-2}	5.208×10^{-3}	1	7.061×10^{-3}	7.200×10^{-2}	7.200×10^{-4}	72.007	7.061×10^4
N-m	8.850	0.737	141.612	1	10.197	0.102	1.019×10^4	1×10^7
kg-cm	0.8679	7.233×10^{-2}	13.877	9.806×10^{-2}	1	10^{-2}	1000	9.806×10^5
kg-m	86.796	7.233	1.388×10^3	9.806	100	1	1×10^5	9.806×10^7
gm-cm	8.679×10^{-4}	7.233×10^{-5}	1.388×10^{-2}	9.806×10^{-5}	1×10^{-3}	1×10^{-5}	1	980.665
dyne-cm	8.850×10^{-7}	7.375×10^{-8}	1.416×10^{-5}	10^{-7}	1.0197×10^{-6}	1.019×10^{-8}	1.019×10^{-3}	1

Length (to convert from A to B, multiply by entry in table)

A \ B	inches	feet	cm	yd	mm	m
inches	1	0.0833	2.54	0.028	25.4	0.0254
feet	12	1	30.48	0.333	304.8	0.3048
cm	0.3937	0.03281	1	1.09×10^{-2}	10	0.01
yd	36	3	91.44	1	914.4	0.914
mm	0.03937	0.00328	0.1	1.09×10^{-3}	1	0.001
m	39.37	3.281	100	1.09	1000	1

Force (to convert from A to B, multiply by entry in table)

A \ B	lb	oz	gm	dyne	N
lb	1	16	453.6	4.448×10^5	4.4482
oz	0.0625	1	28.35	2.780×10^4	0.27801
gm	2.205×10^{-3}	0.03527	1	1.02×10^{-3}	N.A.
dyne	2.248×10^{-6}	3.59×10^{-5}	980.7	1	0.00001
N	0.22481	3.5967	N.A.	100000	1

Mass (to convert from A to B, multiply by entry in table)

A \ B	lb	oz	gm	kg	slug
lb	1	16	453.6	0.4536	0.0311
oz	6.25×10^{-2}	1	28.35	0.02835	1.93×10^{-3}
gm	2.205×10^{-3}	3.527×10^{-2}	1	10^{-3}	6.852×10^{-5}
kg	2.205	35.27	10^3	1	6.852×10^{-2}
slug	32.17	514.8	1.459×10^4	14.59	1

Rotation (to convert from A to B, multiply by entry in table)

A \ B	rpm	rad/s	degrees/s
rpm	1	0.105	6.0
rad/s	9.55	1	57.30
degrees/s	0.167	1.745×10^{-2}	1

Power (to convert from A to B, multiply by entry in table)

A \ B	hp	Watts
hp (English)	1	745.7
(lb-in) (deg./s)	2.645×10^{-6}	1.972×10^{-3}
(lb-in) (rpm)	1.587×10^{-5}	1.183×10^{-2}
(lb-ft) (deg./s)	3.173×10^{-5}	2.366×10^{-2}
(lb-ft) (rpm)	1.904×10^{-4}	0.1420
Watts	1.341×10^{-3}	1

Temperature Conversion

°F	°C	°C	°F
0	-17.8	-10	14
32	0	0	32
50	10	10	50
70	21.1	20	68
90	32.2	30	86
98.4	37	37	98.4
212	100	100	212
subtract 32 and multiply by $\frac{5}{9}$		multiply by $\frac{9}{5}$ and add 32	

Mechanism Efficiencies

Acme-screw with brass nut	~0.35–0.65
Acme-screw with plastic nut	~0.50–0.85
Ball-screw	~0.85–0.95
Chain and sprocket	~0.95–0.98
Preloaded ball-screw	~0.75–0.85
Spur or bevel-gears	~0.90
Timing belts	~0.96–0.98
Worm gears	~0.45–0.85
Helical gear (1 reduction)	~0.92

Friction Coefficients

Materials	μ
Steel on steel (greased)	~0.15
Plastic on steel	~0.15–0.25
Copper on steel	~0.30
Brass on steel	~0.35
Aluminum on steel	~0.45
Steel on steel	~0.58
Mechanism	μ
Ball bushings	<0.001
Linear bearings	<0.001
Dove-tail slides	~0.2++
Gibb ways	~0.5++

Material Densities

Material	lb-in ³	gm-cm ³
Aluminum	0.096	2.66
Brass	0.299	8.30
Bronze	0.295	8.17
Copper	0.322	8.91
Hard wood	0.029	0.80
Soft wood	0.018	0.48
Plastic	0.040	1.11
Glass	0.079–0.090	2.2–2.5
Titanium	0.163	4.51
Paper	0.025–0.043	0.7–1.2
Polyvinyl chloride	0.047–0.050	1.3–1.4
Rubber	0.033–0.036	0.92–0.99
Silicone rubber, without filler	0.043	1.2
Cast iron, gray	0.274	7.6
Steel	0.280	7.75

Wire Gauges¹⁾

Cross-section mm ²	Standard Wire Gauge (SWG)	American Wire Gauge (AWG)
0.2	25	24
0.3	23	22
0.5	21	20
0.75	20	19
1.0	19	18
1.5	17	16
2.5	15	13
4	13	11
6	12	9
10	9	7
16	7	6
25	5	3
35	3	2
50	0	1/0
70	000	2/0
95	00000	3/0
120	000000	4/0
150	–	6/0
185	–	7/0

¹⁾ The table shows approximate SWG/AWG sizes nearest to standard metric sizes; the cross-sections do not match exactly.

Appendix

Notes

13

1. General Provisions

By using this catalog you can purchase hard- and software products as well as services (together hereinafter referred to as "products") described therein from Siemens Aktiengesellschaft subject to the following Terms and Conditions of Sale and Delivery (hereinafter referred to as "T&C"). Note, for products purchased from any Siemens entity having a registered office outside of Germany, the respective terms and conditions of sale and delivery of the respective Siemens entity apply exclusively. The following T&C apply exclusively for orders placed with Siemens Aktiengesellschaft, Germany.

1.1 For customers with a seat or registered office in European Union

For customers with a seat or registered office in European Union, the following terms and conditions apply subordinate to T&C:

- for products, which include specific terms and conditions in the text of the product description, these specific terms and conditions shall apply and subordinate thereto,,
- for stand-alone software products and software products forming a part of a product or project, the "General Conditions for Software Products for Infrastructure & Industry Business (German law)"¹⁾ and/or
- for consulting services the "Allgemeine Geschäftsbedingungen für Beratungsleistungen für Infrastructure & Industry Geschäft (Deutsches Recht)"¹⁾ (available only in German) and/or
- for other services, the „Supplementary Terms and Conditions for Services for Infrastructure & Industry Business (German Law) ("BL")"¹⁾ and/or
- for other products the "General Conditions for the Supply of Products and Services of the Electrical and Electronics Industry"¹⁾.
In case such products should contain Open Source Software, the conditions of which shall prevail over the "General Conditions for the Supply of Products and Services of the Electrical and Electronics Industry"¹⁾, the Product will be given a note as to which special conditions apply to this open source software. This shall apply mutatis mutandis for notices referring to other third-party software components.

1.2 For customers with a seat or registered office outside European Union

For customers with a seat or registered office outside European Union, the following terms and conditions apply subordinate to T&C:

- for products, which include specific terms and conditions in the description text, these specific terms and conditions shall apply and subordinate thereto,
- for consulting services the "Standard Terms and Conditions for Consulting Services for Infrastructure & Industry Business (Swiss Law)"¹⁾ and/or
- for other services the "International Terms & Conditions for Services"¹⁾ supplemented by "Software Licensing Conditions"¹⁾ and/or
- for other products the "International Terms & Conditions for Products"¹⁾ supplemented by "Software Licensing Conditions"¹⁾

1.3 For customers with master or framework agreement

To the extent products offered are covered by an existing master or framework agreement, the terms and conditions of that agreement shall apply instead of T&C.

2. Prices

The prices are in € (Euro) ex point of delivery, exclusive of packaging.

The sales tax (value added tax) is not included in the prices. It shall be charged separately at the respective rate according to the applicable statutory legal regulations.

Prices are subject to change without prior notice. We will charge the prices valid at the time of delivery.

To compensate for variations in the price of raw materials (e.g. silver, copper, aluminum, lead, gold, dysprosium and neodym), surcharges are calculated on a daily basis using the so-called metal factor for products containing these raw materials.

A surcharge for the respective raw material is calculated as a supplement to the price of a product if the basic official price of the raw material in question is exceeded.

The metal factor of a product indicates the basic official price (for those raw materials concerned) as of which the surcharges on the price of the product are applied, and with what method of calculation. The metal factor, provided it is relevant, can be found in the respective product description.

An exact explanation of the metal factor can be downloaded at:

https://mall.industry.siemens.com/legal/ww/en/terms_of_trade_en.pdf

3. Additional Terms and Conditions

The dimensions are in mm. In Germany, according to the German law on units in measuring technology, data in inches apply only to devices for export.

Illustrations are not binding.

Insofar as there are no remarks on the individual pages of this catalog – especially with regard to data, dimensions and weights given – these are subject to change without prior notice.

¹⁾ The text of the Terms and Conditions of Siemens AG can be downloaded at
https://mall.industry.siemens.com/legal/ww/en/terms_of_trade_en.pdf

Appendix

Conditions of sale and delivery

4. Export Control and Sanctions Compliance

4.1 General

Customer shall comply with all applicable sanctions, embargoes and (re-)export control laws and regulations, and, in any event, with those of the European Union, the United States of America and any locally applicable jurisdiction (collectively "Export Regulations").

4.2 Checks for Products

Prior to any transaction by customer concerning products (including hardware, documentation and technology) delivered by Siemens, or products (including maintenance and technical support) performed by Siemens with a third party, customer shall check and certify by appropriate measures that

- (i) the customer's use, transfer, or distribution of such products, the brokering of contracts or the provision of other economic resources in connection with products will not be in violation of any Export Regulations, also taking into account any prohibitions to circumvent these (e.g., by undue diversion)
- (ii) the products are not intended or provided for prohibited or unauthorized non-civilian purposes (e.g. armaments, nuclear technology, weapons, or any other usage in the field of defense and military);
- (iii) customer has screened all direct and indirect parties involved in the receipt, use, transfer, or distribution of the products against all applicable restricted party lists of the Export Regulations concerning trading with entities, persons and organizations listed therein and
- (iv) products within the scope of items-related restrictions, as specified in the respective annexes to the Export Regulations, will not, unless permitted by the Export Regulations, be
 - (a) exported, directly or indirectly (e.g., via Eurasian Economic Union (EAEU) countries), to Russia or Belarus, or
 - (b) resold to any third party business partner that does not take a prior commitment not to export such products to Russia or Belarus.

4.3 Non-Acceptable Use of Software and Cloud Services

Customer shall not, unless permitted by the Export Regulations or respective governmental licenses or approvals,

- (i) download, install, access or use the products from or in any location prohibited by or subject to comprehensive sanctions or subject or to license requirements according to the Export Regulations;
 - (ii) grant access to, transfer, (re-)export (including any "deemed (re-)exports"), or otherwise make available the products to any entity, person, or organization identified on a restricted party list of the Export Regulations;
 - (iii) use the products for any purpose prohibited by the Export Regulations (e.g. use in connection with armaments, nuclear technology or weapons);
 - (iv) upload to a products platform any customer content unless it is non-controlled (e.g. in the EU: AL = N; in the U.S.: ECCN = N or EAR99);
 - (v) facilitate any of the afore mentioned activities by any user.
- Customer shall provide all users with all information necessary to ensure compliance with the Export Regulations.

4.4 Semiconductor Development

Customer will not, without advance written authorization from Siemens, use offerings for the development or production of integrated circuits at any semiconductor fabrication facility located in China meeting the criteria specified in the U.S. Export Administration Regulations, 15 C.F.R. 744.23.

4.5 Information

Upon request by Siemens, customer shall promptly provide Siemens with all information pertaining to users, the intended use and the location of use or the final destination (in the case of hardware, documentation and technology) of the products. Customer will notify Siemens prior to customer disclosing any information to Siemens that is defense-related or requires controlled or special data handling pursuant to applicable government regulations, and will use the disclosure tools and methods specified by Siemens.

4.6 Reservation

Siemens shall not be obligated to fulfill this agreement if such fulfillment is prevented by any impediments arising out of national or international foreign trade or customs requirements or any embargoes or other sanctions. Customer acknowledges that Siemens may be obliged under the Export Regulations to limit or suspend access by customer and/or users to products.

5. Miscellaneous

Errors excepted and subject to change without prior notice.

Selection and ordering at Siemens SiePortal – Ordering products and downloading catalogs

The screenshot shows the Siemens SiePortal homepage. At the top, there is a search bar and navigation links for Home, Products & Services, Support, and mySiePortal. The main content area features three promotional cards:

- Reliable, combinable and versatile DC-DC converters:** Promotes a wide variety of SINAMICS DC-DC converters for industrial applications, with a 'Buy now' button.
- Compact energy meter direct measurement (max. 80A) at a special price:** Features a special campaign for MID-certified variant SENTRON 7KT1666, highlighting bulk packs and short lead times, with 'Buy now' and 'Download' buttons.
- New SIMATIC ET 200SP CPU, FW V3.0:** Lists benefits like better communication performance, faster program execution, and more memory, with a 'Buy now' button.

A sidebar on the right promotes SiePortal as an integrated platform for product selection, buying, and support workflow, with 'Register here' and 'Password forgotten' links.

Easy product selection and ordering with SiePortal

SiePortal > Products & Services

The internet ordering platform of Siemens AG is located in SiePortal. It provides you with online access to a comprehensive product spectrum that is presented in an informative, well-organized way.

Powerful search functions help you select the required products, while configurators enable you to configure complex product and system components quickly and easily. CAX data are also available for you to use.

Data transfer allows the entire procedure, from selection through ordering to tracking and tracing, to be carried out online. Availability checks, individual customer discounting, and quotation preparation are also possible.

<https://sieportal.siemens.com>

The screenshot shows the search results page in SiePortal. The search criteria are 'Drive Technology' and 'Catalog/Brochure'. The results are sorted by 'Date (latest first)'. The search results list includes:

- Catalog D 32: SINAMICS S110 Servo drive system:** POF 04-0023, Catalog, 189.0004-9332-A101-AB-7600. Settings: English, Chinese. Includes a 'Versions' dropdown.
- Catalog D 31.1: SINAMICS Converters for Single-Axis Drives Built-In Units:** POF 10-0021 - Update 10-0022, Catalog, 186.0004-9331-A111-AB-7600. Settings: English, Chinese. Includes a 'Versions' dropdown.
- Catalog D 41: SIMOTICS S-1FC1 Servo geared motors Helical, Parallel shaft, Bevel and Helical worm geared motors:** POF - February 2023, Catalog, 100.0004-9324-A101-AB-7600. Settings: English. Includes a 'Versions' dropdown.

The left sidebar shows a product tree with 'Drive Technology (50)' selected, and sub-categories like Converters (25), Grid-converters (0), DC-DC Converter (0), Motors (27), Geared motors (6), Selection and engineering tools (2), Digitalization in drive technology (0), Supplementary components (2), Drive technology for extreme requirements (0), Archive (3), and Drives (0).

Downloading catalogs

SiePortal > Support > Knowledge base

You can download catalogs and brochures in PDF format from Siemens Industry Online Support without having to register.

The filter box makes it possible to perform targeted searches.

<https://sieportal.siemens.com>

Cybersecurity information

Siemens provides products and solutions with industrial cybersecurity functions that support the secure operation of plants, systems, machines and networks.

In order to protect plants, systems, machines and networks against cyber threats, it is necessary to implement – and continuously maintain – a holistic, state-of-the-art industrial cybersecurity concept. Siemens' products and solutions constitute one element of such a concept.

Customers are responsible for preventing unauthorized access to their plants, systems, machines and networks. Such systems, machines and components should only be connected to an enterprise network or the internet if and to the extent such a connection is necessary and only when appropriate security measures (e.g. firewalls and/or network segmentation) are in place.

For additional information on industrial cybersecurity measures that may be implemented, please visit www.siemens.com/cybersecurity-industry

Siemens' products and solutions undergo continuous development to make them more secure. Siemens strongly recommends that product updates are applied as soon as they are available and that the latest product versions are used. Use of product versions that are no longer supported, and failure to apply the latest updates may increase customer's exposure to cyber threats.

To stay informed about product updates, subscribe to the Siemens Industrial Cybersecurity RSS Feed under www.siemens.com/cert

Get more information

The SINAMICS converter family:
www.siemens.com/sinamics

SIMOTICS motors for industry:
www.siemens.com/simotics

Motion Control Systems and Solutions for production machine and machine tool equipment:
www.siemens.com/motioncontrol

Local partners worldwide:
www.siemens.com/automation-contact

Published by
Siemens AG

Digital Industries
Motion Control
Postfach 31 80
91050 Erlangen, Germany

For the U.S. published by
Siemens Industry Inc.

100 Technology Drive
Alpharetta, GA 30005
United States

PDF (E86060-K5531-A121-A4-7600)
V6.MKKATA.GMC.100
KG 1024 204 En
Produced in Germany
© Siemens 2024

Subject to changes and errors. The information given in this document only contains general descriptions and/or performance features which may not always specifically reflect those described, or which may undergo modification in the course of further development of the products. The requested performance features are binding only when they are expressly agreed upon in the concluded contract.

All product designations may be trademarks or product names of Siemens AG or other companies whose use by third parties for their own purposes could violate the rights of the owners.