



Modicon M251

Programmable Logic Controller for
modular and distributed architectures



Modicon

Discover [Modicon](#)

Edge control for Industrial IoT

Modicon IIoT-native edge controllers manage complex interfaces across assets and devices or directly into the cloud, with embedded safety and cybersecurity. Modicon provides performance and scalability for a wide range of industrial applications up to high-performance multi-axis machines and high-available redundant processes.

Explore our offer

- [Modicon HVAC Controllers](#)
- [Modicon PLC](#)
- [Modicon Motion Controllers](#)
- [Modicon PAC](#)
- [Modicon I/O](#)
- [Modicon Networking](#)
- [Modicon Power Supply](#)
- [Modicon Wiring](#)
- [Modicon Safety](#)

Life Is On



Quick access to product information

Get technical information about your product

References

Modicon TM3
I/O expansion modules for Modicon controllers
Analog I/O modules

Number and type of channels	Input range	Output range	Resolution	Input terminal (pin)	Reference	Weight
2 enhancement inputs	-10...+10VDC 0...20mA, 4...20mA	-10...+10VDC 0...20mA	10 bits or 10 bits + sign	28P2, 2 28P2, 2	TM3AI2H TM3AI2H	0,110 0,230
4 enhancement inputs	-10...+10VDC 0...20mA, 4...20mA	-10...+10VDC 0...20mA	10 bits or 10 bits + sign	28P2, 4 28P2, 4	TM3AI4H TM3AI4H	0,110 0,230
4 enhancement or temperature inputs	-10...+10VDC 0...20mA, 4...20mA	-10...+10VDC 0...20mA	10 bits or 10 bits + sign	28P2, 4 28P2, 4	TM3AI4T TM3AI4T	0,110 0,230
4 differential temperature inputs	-10...+10VDC 0...20mA, 4...20mA	-10...+10VDC 0...20mA	10 bits or 10 bits + sign	28P2, 8 28P2, 8	TM3AI8T TM3AI8T	0,110 0,230

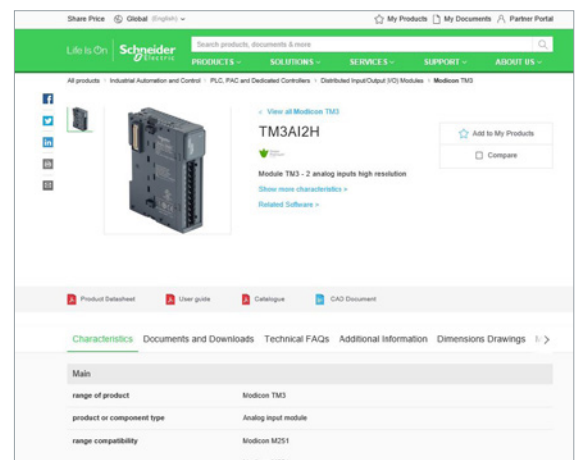

Each commercial reference presented in a catalog contains a hyperlink. Click on it to obtain the technical information of the product:

- Characteristics, Dimensions and drawings, Mounting and clearance, Connections and schemas, Performance curves
- Product image, Instruction sheet, User guide, Product certifications, End of life manual

Find your catalog

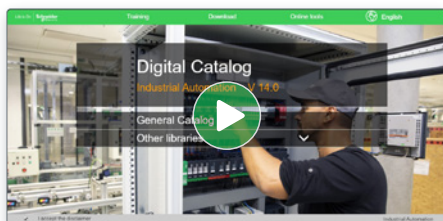

- > With just 3 clicks, you can access the Industrial Automation and Control catalogs, in both English and French
- > Consult digital automation catalogs at [Digi-Cat Online](#)

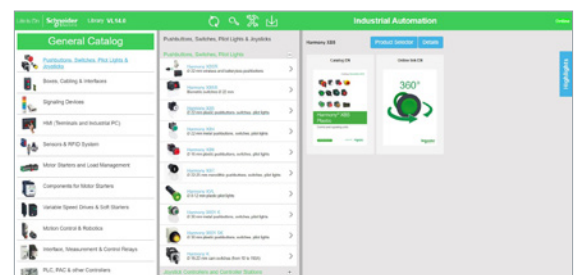

- Up-to-date catalogs
- Embedded product selectors, 360° pictures
- Optimized search by commercial references

Select your training



- > Find the right [Training](#) for your needs on our Global website
- > Locate the training center with the selector tool, using this [link](#)

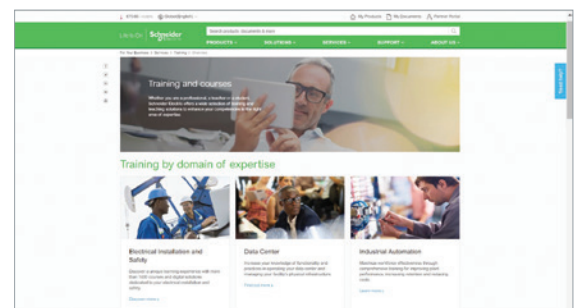

General content

Modicon M251

Programmable Logic Controller for modular and distributed architectures

Introduction to EcoStruxure Machine page 2

Selection guide: controllers for industrial machines page 4

Machine automation page 6

Selection guide: Modicon™ M251 logic controllers page 8

■ **Presentation**

- Applications, Main functions, page 10
- Options: memory card, communication modules page 11
- Communication via modem and router page 12
- I/O extensions with Modicon TM3 expansion modules page 13
- Control architecture for modular machines on Ethernet network page 14
- Control architecture for modular machines on CANopen bus page 15
- Communication over SAE J1939 page 15
- Serial link page 15

■ **Description**

- Modicon M251 logic controllers page 16

■ **Characteristics of M251 logic controllers**

(Conformity, Environmental characteristics, Power supply characteristics) page 16

■ **References**

- Modicon M251 logic controllers page 17
- Options page 17
- Separate parts, software, cordsets page 17

Modicon TM4 communication modules

■ **Ethernet switch module**

- Presentation, description page 18
- References page 19

■ **Profibus DP slave module**

- Presentation, description page 18
- References page 19

Products reference index

- Index page 20

To be competitive in today's digital era, machine builders must be innovative. Smart machines, those that are better connected, more flexible, more efficient, and safe, are enabling machine builders to innovate in ways never before possible.

EcoStruxure, Schneider Electric's open, IoT-enabled architecture and platform, offers powerful solutions for the digital era. As part of this, EcoStruxure Machine brings powerful opportunities for machine builders and OEMs, empowering them to offer smart machines and compete in the new, digital era.

EcoStruxure Machine brings together key technologies for product connectivity and edge control on premises, and cloud technologies to provide analytics and digital services. EcoStruxure Machine helps you bring more innovation and added value to your customers throughout the entire machine life cycle.

Innovation at Every Level for Machines is full systems across three layers:

- Connected products
Our connected products for measuring, actuating, device level monitoring, and control adhere to open standards to provide unmatched integration opportunities and flexibility
- Edge Control
We are IIoT-ready with a proven set of tested and validated reference architectures that enable the design of end-to-end open, connected, and interoperable systems based on industry standards. Ethernet and OPC UA facilitates IT/OT convergence meaning machine builders reap benefits from web interfaces and cloud.

- Apps, Analytics & Services
Seamless integration of machines to the IT layer allows the collection and aggregation of data ready for analysis – for machine builders and end users alike this means increased uptime and the ability to find information faster for more efficient operations and maintenance.

These levels are completely integrated from shop floor to top floor. And we have cloud offers and end-to-end cybersecurity wrapped around.

EcoStruxure Machine makes it easier for OEMs/machine builders to offer their customers smarter machines. The advent of smart machines is driven by the changing needs of end users:

- Evolving workforce
- Reducing costs
- Dynamic markets
- Shorter life cycles
- Prioritizing safety and cybersecurity

EcoStruxure Machine provides one solution for the whole machine life cycle:

- With Smart Design & Engineering the time to market is reduced by up to 30% using our automated engineering and the simulation capabilities
- During Commissioning & Operation of the machine, resources such as energy, material and loss can be improved, and with seamless integration to the IT world efficiency can be improved by up to 40%
- Smart Maintenance & Services reduces the time for corrective actions up to 50%

EcoStruxure™ Machine





* The Schneider Electric industrial software business and AVEVA have merged to trade as AVEVA Group plc, a UK listed company. The Schneider Electric and Life is On trademarks are owned by Schneider Electric and are being licensed to AVEVA by Schneider Electric.

Modicon M251

Programmable Logic Controller for modular and distributed architectures

Controllers for industrial machines

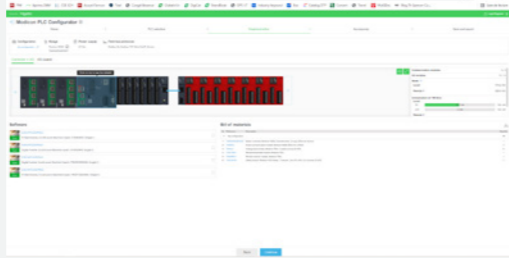
Applications		Logic controller			Logic/motion controller	Motion controller
Type	Specification	For hardwired architectures	For performance-demanding applications	For modular and distributed architectures	IloT ready for performance machines	For automating machines/lines with 0 - 130 servo or robot axes
						
Memory		640 KB RAM, 2 MB Flash	64 MB RAM, 128 MB Flash	64 MB RAM, 128 MB Flash	192 MB RAM, 256 MB Flash	128 KB to 256 KB NV RAM, 512 MB DDR2 to 1 GB DDR3L
Supply voltage		24 V ~ or 100...240 V ~	24 V ~ or 100...240 V ~	24 V ~	24 V ~	24 V ~
Communication fieldbus and networks	Embedded	<ul style="list-style-type: none"> EtherNet/IP Adapter Modbus TCP RS 232/RS 485 Serial Line USB mini-B programming port 	<ul style="list-style-type: none"> EtherNet/IP Modbus TCP CANopen (master) and SAE J1939 Serial Line USB mini-B programming port 	<ul style="list-style-type: none"> EtherNet/IP Modbus TCP CANopen (master) and SAE J1939 Serial Line USB mini-B programming port 	<ul style="list-style-type: none"> EtherNet/IP Modbus TCP Sercos III Serial Line USB mini-B programming port 	<ul style="list-style-type: none"> EtherNet/IP Sercos III CANopen Profibus Profinet EtherCAT
	OPC Unified Architecture (OPC UA)	–	Server	Server	Server (encrypted) Client (encrypted) (depending on reference)	Server (encrypted) Client (encrypted)
	Optional	1 Serial Line	Ethernet Profibus DP	Ethernet Profibus DP	Ethernet, EtherNet/IP Adapter CANopen Master	CANopen Profibus DP RT-Ethernet
Embedded I/O	Input types	Up to 40 logic inputs 2 analog inputs	Up to 24 logic inputs	–	4 fast digital inputs	Up to 20 digital inputs Up to 16 touch probe inputs Up to 4 interrupt inputs Up to 2 analog inputs
	Output types	Up to 16 relay outputs Up to 16 transistor outputs	Up to 16 transistor outputs	–	4 fast digital outputs	Up to 16 digital outputs Up to 2 analog outputs
Synchronized axes		–	–	–	Up to 24 synchronized axes	Up to 130 synchronized axes
Configuration software		EcoStruxure Machine Expert-Basic	EcoStruxure Machine Expert			
Compatible expansion I/O module ranges (Consult the catalog)	Local I/O	Modicon TM3 (DIA3ED2140109EN)	Modicon TM3 (DIA3ED2140109EN)	Modicon TM3 (DIA3ED2140109EN)	Modicon TM3 (DIA3ED2140109EN)	–
	Remote I/O	Modicon TM3 (DIA3ED2140109EN)	Modicon TM3 (DIA3ED2140109EN)	Modicon TM3 (DIA3ED2140109EN)	Modicon TM3 (DIA3ED2140109EN)	–
	Distributed I/O on Ethernet	Modicon TM3 (DIA3ED2140109EN)	Modicon TM3 (DIA3ED2140109EN) Modicon TM5 (DIA3ED2131204EN)	Modicon TM3 (DIA3ED2140109EN) Modicon TM5 (DIA3ED2131204EN)	Modicon TM3 (DIA3ED2140109EN) Modicon TM5 (DIA3ED2131204EN)	Modicon TM5 (DIA3ED2131204EN)
	Distributed I/O on CANopen	–	Modicon TM3 (DIA3ED2140109EN)	Modicon TM3 (DIA3ED2140109EN)	Modicon TM3 (DIA3ED2140109EN)	Modicon TM3 (DIA3ED2140109EN) Modicon TM5 (DIA3ED2131204EN) Modicon TM7 (DIA3ED2140405EN)
	Distributed I/O on Sercos	–	–	–	Modicon TM5 (DIA3ED2131204EN)	Modicon TM5 (DIA3ED2131204EN)
	Distributed I/O on Modbus Serial Line	Modicon TM3 (DIA3ED2140109EN)	Modicon TM3 (DIA3ED2140109EN)	Modicon TM3 (DIA3ED2140109EN)	Modicon TM3 (DIA3ED2140109EN)	–
Safety I/O	Modicon TM3 (DIA3ED2140109EN)	Modicon TM3 (DIA3ED2140109EN)	Modicon TM3 (DIA3ED2140109EN)	Modicon TM3 (DIA3ED2140109EN) Modicon TM5 (DIA3ED2131204EN) Modicon TM7 (DIA3ED2140405EN)	Modicon TM5 (DIA3ED2131204EN) Modicon TM7 (DIA3ED2140405EN)	
Controller range		Modicon M221/M221 Book	Modicon M241	Modicon M251	Modicon M262	PacDrive LMC Eco, LMC Pro2
More details	Consult the catalogs	DIA3ED2140106EN	DIA3ED2140107EN	DIA3ED2140108EN	DIA3ED2180503EN	DIA7ED2160303EN
	Try the configuration tool	<p>Modicon PLC configurator</p>  <ul style="list-style-type: none"> Select your architecture of controller and I/O by <ul style="list-style-type: none"> Usage and application Connectivity, services and IIOT (Protocols, WeB and communication services) I/O Power supply 				

Modicon M251

Programmable Logic Controller for modular and distributed architectures

Machine Automation

Machine Automation

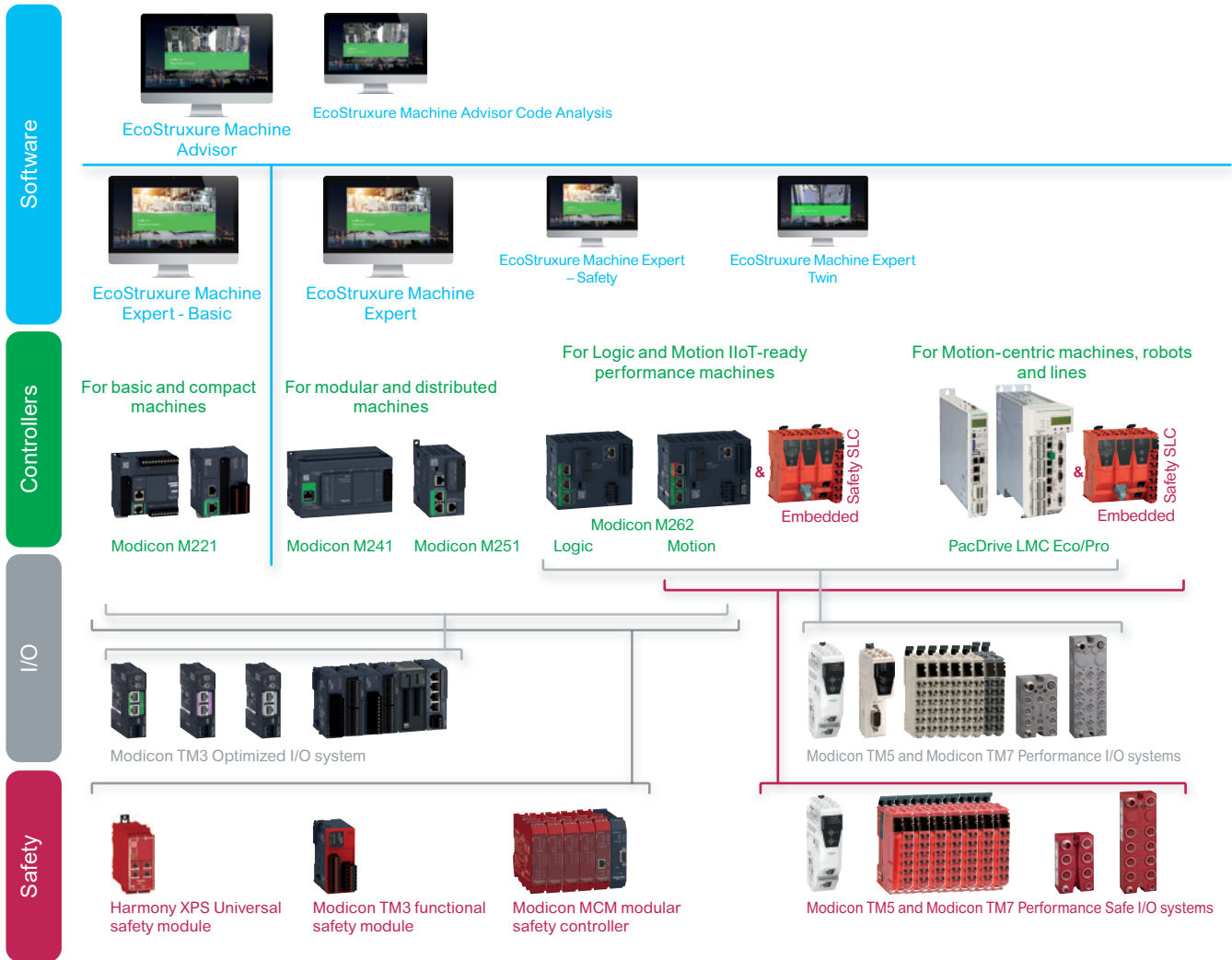

Machine control

The scalability and consistency of I/O ranges allow you to select the right offer depending on your needs

Embedded Safety provides holistic solutions to Modicon M262 and PacDrive 3 LMC controllers, increasing overall safety demand in Machine Automation

All of those devices are managed within a single software, **EcoStruxure Machine Expert**, a powerful and collaborative engineering environment

- > From basic to motion- and robot-centric machines with the PacDrive 3 offer, Modicon controllers and solutions bring a consistent and scalable response to achieving flexibility, performance, productivity and digitization.
- > Modicon TM3 Optimized I/O system for more compact and modular machines
- > Modicon TM5 for more performance-demanding machines, with Modicon TM7 for harsh environments: Both Performance I/O ranges (Modicon TM5 and Modicon TM7) allow safety functions to be implemented using Modicon TM5CSLC safety logic controller
- > Harmony XPS Universal safety modules cover a wide range of safety functions, suitable for small applications with 4-5 safety functions, with diagnostic information provided to controllers via a single wire connection
- > Modicon TM3 safety functional modules are suitable for small applications covering E-Stop functions and diagnostics via TM3 I/O bus
- > Modicon MCM modular safety controllers are suitable for medium size applications with up to 64 dual channel safety functions and diagnostics via Modbus TCP, Modbus RTU, EtherNet/IP, CANopen, EtherCAT and Profibus
- > EcoStruxure Machine Expert – Safety: an optional addon for programming safety logic controllers
- > EcoStruxure Machine Expert – Basic: a software for programming Modicon M221 logic controllers, an intuitive standalone environment accessible to basic skilled technicians
- > EcoStruxure Machine Advisor: a cloud-based services platform designed for machine builders to track machines in operation worldwide, monitor performance data and resolve exceptional events, while reducing support costs by up to 50%

Machine Automation

Comprehensive Schneider offers for machine builders

- > Lexium servo drives, motors and robotics are designed to control applications ranging from a single independent axis up to high-performance synchronized multi-axis machines requiring high-speed and precise positioning and movements



- > The Lexium offer is designed for a broad range of motion-centric machines in applications such as [Packaging](#), [Material Handling](#), [Material Working](#), [Food and Beverage](#) and Electronics

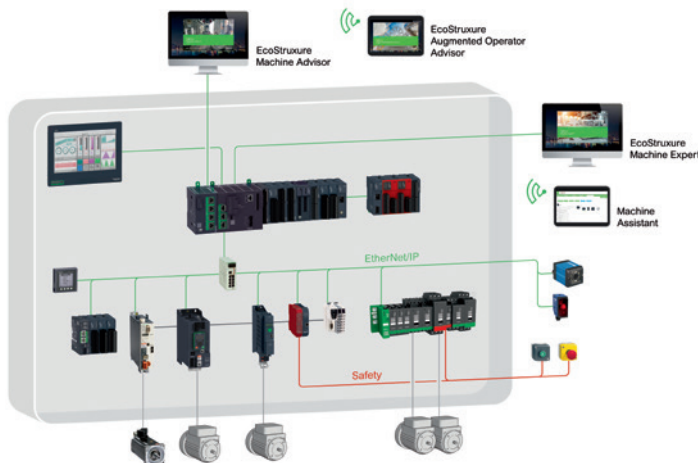

- > Schneider Electric has developed Tested Validated & Documented Architectures (TVDA) applicable for generic machine control applications as well as for dedicated segment applications such as Packaging, Material Working, Material Handling, Hoisting, Pumping, or generic [Machine Control applications](#)

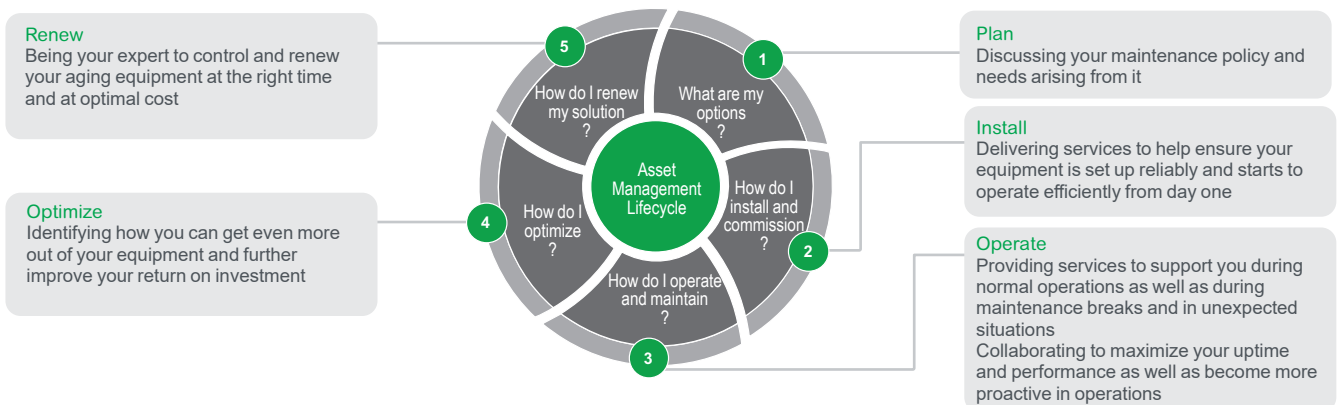

Choose Schneider Electric to help secure your investment and benefit from worldwide services at every step of your project



- > From planning and inception to modernization, we help ensure optimal technical and business performance. Our field service engineers combine 30+ years of manufacturer-level experience with the latest technology to bring innovation to every level of our offer and every step of your project.
- > Our machine control dedicated services empower you to maximize your business infrastructure and face increasingly stringent demands on productivity, safety, equipment availability and performance optimization.

Modicon M251

Programmable Logic Controller for modular and distributed architectures

Applications	Controlling modular machines on distributed architectures	Controlling modular machines on distributed architectures
		
Supply voltage	24 V \overline{DC}	24 V \overline{DC}
I/O expansion	<ul style="list-style-type: none"> <input type="checkbox"/> 7 Modicon TM3 expansion modules <input type="checkbox"/> 14 Modicon TM3 expansion modules with the use of bus expansion modules (transmitter and receiver) <input type="checkbox"/> Possible use of Modicon TM2 expansion modules with restrictions. 	<ul style="list-style-type: none"> <input type="checkbox"/> 7 Modicon TM3 expansion modules <input type="checkbox"/> 14 Modicon TM3 expansion modules with the use of bus expansion modules (transmitter and receiver) <input type="checkbox"/> Possible use of Modicon TM2 expansion modules with restrictions.
Embedded communication	<p>Ethernet link</p> <ul style="list-style-type: none"> ■ Ethernet 1: 2 ports connected by a switch, "Machine" or "Factory" (2 RJ 45 connectors) ■ Ethernet 2: 1 "fieldbus" Ethernet port (1 RJ 45 connector with Industrial Ethernet manager service (EtherNet/IP and TCP I/O Scanner)) <input type="checkbox"/> Protocols: Modbus TCP Client/Server, slave Modbus TCP, EtherNet/IP Adapter, EtherNet/IP Originator (Ethernet port 2), OPC UA Server (1). <input type="checkbox"/> Services: firmware update, data exchange - NGVL and IEC VAR ACCESS, WEB Server, MIB2 SNMP network management, FTP file transfer. FTP Client/Server, SNMP Client/Server, SQL (Client), Email library, email sending and receipt, DHCP Client dynamic configuration, programming, downloading, monitoring, SNMP Client/Server V1 & V2, SNTP Client, DNS Client. <p>CANopen link</p> <p>–</p> <p>Serial link</p> <ul style="list-style-type: none"> ■ 1 serial link port (RJ 45) RS 232/RS 485 with +5 V supply 	<p>Ethernet: 2 ports connected by a switch, "Machine" or "Factory" (2 RJ 45 connectors)</p> <ul style="list-style-type: none"> <input type="checkbox"/> Protocols: Modbus TCP Client/Server, slave Modbus TCP, EtherNet/IP Adapter, OPC UA Server (1). <input type="checkbox"/> Services: firmware update, data exchange - NGVL and IEC VAR ACCESS, WEB Server, MIB2 SNMP network management, FTP file transfer. FTP Client/Server, SNMP Client/Server, SQL (Client), Email library, email sending and receipt, DHCP Client dynamic configuration, programming, downloading, monitoring, SNMP Client/Server V1 & V2, SNTP Client, DNS Client. <p>■ 1 port for CANopen fieldbus (1 x 9-way SUB-D connector) with CANopen (Master) and SAE J1939 Request Manager protocols</p> <p>■ 1 serial link port (RJ 45) RS 232/RS 485 with +5 V supply</p>
Options	<p>Communication modules</p> <ul style="list-style-type: none"> ■ 1 Ethernet port module with switch function and 4 embedded ports ■ 1 module for slave Profibus DP link 	<p>Communication modules</p> <ul style="list-style-type: none"> ■ 1 Ethernet port module with switch function and 4 embedded ports ■ 1 module for slave Profibus DP link
Mounting	Mounting on \perp symmetrical rail or panel	Mounting on \perp symmetrical rail or panel
Software programming	EcoStruxure Machine Expert, consult catalog DIA3ED2180701EN	EcoStruxure Machine Expert, consult catalog DIA3ED2180701EN
Controller type	TM251MESE	TM251MESD
Page	17	17

(1) OPC UA function which can be activated on request.

Modicon M251

Programmable Logic Controller for modular and distributed architectures

General presentation



TM251MESE



TM251MES C



[DIA3ED2140109EN](#)



[DIA3ED2180701EN](#)



QRcode for access to the *TM251MES C* logic controller technical documentation



EcoStruxure Machine Expert software

Presentation

Applications

Modicon M251 controllers offer an innovative, high-performance solution in the field of modular machines and distributed architectures.

Thanks to their compact dimensions, they can optimize the size of wall-mounted and floor standing control system enclosures.

Since Modicon M251 controllers have no embedded I/O, field devices such as variable speed drives and remote I/O are connected on either the CANopen and SAE J1939 machine buses, or over the Ethernet network.

Modicon M251 controllers have an embedded Ethernet port offering FTP Client/Server, Web Server, SQL Client, SNMP Client/Server V1 and V2, OPC UA Server, SNTCP Client and DNS Client services, meaning they can easily be integrated in control system architectures for remote monitoring and maintenance of machines by means of applications for smartphones, tablets and PCs.

The wealth of embedded functions minimizes the cost of the machine:

- Functions embedded in the controller: Modbus serial link, USB port dedicated to programming, Ethernet I/O Scanner, CANopen and SAE J1939 fieldbuses for distributed architectures and advanced position control functions (PLCopen libraries).
- Functions embedded in Modicon TM3 expansion modules (1): functional safety modules, motor-starter control module and remote expansion system.
- Functions embedded in Modicon TM4 communication modules.

The processing power and the memory size of M251 controllers are ideal for targeting high-performance applications.

EcoStruxure Machine Expert programming software (2) is powerful and intuitive, making it quick to create applications.

Main functions

- Both Modicon M251 logic controllers come in an identical format (w x h x d): 54 x 90 x 95 mm (2.13 x 3.54 x 3.74 in.)
- Modicon M251 controllers have no embedded I/O but can be combined with Modicon TM3 expansion modules.
- Every M251 controller has a Run/Stop switch.
- A slot for an industrial SD memory card (Secure Digital card) is available on every M251 controller.
- Each M251 controller has a QR code for direct access to its technical documentation.

Embedded communication

M251 logic controllers incorporate up to 5 communication ports:

- The **TM251MESE** controller incorporates:
 - an "Ethernet 1" (3) network with 2 RJ 45 ports connected by an internal switch, this network being mainly for communication between machines or to your factory network
 - an "Ethernet 2" (3) network with an RJ 45 port, optimized for connecting field devices (variable speed drives, distributed I/O, etc.) by means of the Ethernet I/O Scanner service (Industrial Ethernet Manager). This port can also be connected to a factory network.
- The **TM251MES C** controller incorporates:
 - an "Ethernet" (3) network with 2 RJ 45 ports connected by an internal switch, this network being mainly for communication between machines or to your factory network
 - a CANopen port (CANopen master/SAE J1939 Request Manager) for connecting field devices (variable speed drives, distributed I/O, etc.)
- Moreover, both these M251 logic controllers incorporate:
 - a serial link port
 - a programming port

Processing power

- DualCore processor
- RAM: 64 MB
- Flash memory: 128 MB
- Program: 128 K Boolean instructions

Programming

Modicon M251 logic controllers are programmed with EcoStruxure Machine Expert, consult catalog [DIA3ED2180701EN](#).

(1) Consult catalog [DIA3ED2140109EN](#).

(2) Consult catalog [DIA3ED2180701EN](#).

(3) Ethernet with embedded Web server function.

Modicon M251

Programmable Logic Controller for modular and distributed architectures

Options for Modicon M251 logic controllers



Options for Modicon M251 controllers

Memory card

The **TMASD1** industrial SD memory card, 256 MB capacity, is available for:

- application backup
- program transfer
- data logging
- firmware update

Communication modules (1)

2 communication module models are dedicated to Modicon M251 logic controllers:

- the **TM4ES4** Ethernet switch module
- the **TM4PDPS1** slave Profibus DP module

Modicon TM4 communication modules are assembled by simple interlocking on the left-hand side of the controllers and a bus expansion connector is used to distribute data and the power supply.

Up to 3 communication modules can be added on the left of M251 logic controllers. See [page 18](#).

■ Ethernet switch module

- The **TM4ES4** module is a 4-port Ethernet interface (10/100 Mbps, MDI/MDIX) with the following protocols: Ethernet Modbus TCP (Client/Server), EtherNet/IP (Adapter/Originator), UDP, TCP, SNMP and EcoStruxure Machine.
- Clipped onto the left-hand side of a Modicon M251 controller, it consists of an autonomous switch with 4 ports, supplied by the Modicon M251 controller.

■ Slave PROFIBUS DP module

- The **TM4PDPS1** communication module can be used to configure a Master connection on the PROFIBUS DP bus.

(1) For rules for combining Modicon TM4 communication modules and Modicon M251 logic controllers, see [page 18](#).

Modicon M251

Programmable Logic Controller for modular and distributed architectures

Communication via modem and router

Communication via modem and router

The communication via modem and router offer is dedicated to the following applications:

- Synchronization between remote machines; direct data exchange between controllers.
- Remote maintenance; access to the controller via the EcoStruxure Machine Expert programming software.
- Remote control and monitoring of machines; receipt of information and sending commands on a GSM/UMTS phone (1).

This offer comprises a Schneider Electric modem, GSM/UMTS modem and a VPN router made by eWon.

For the modem and router, please consult our [website](#).

(1) Global System Mobile (2G)/Universal Mobile Telecommunications System (3G).

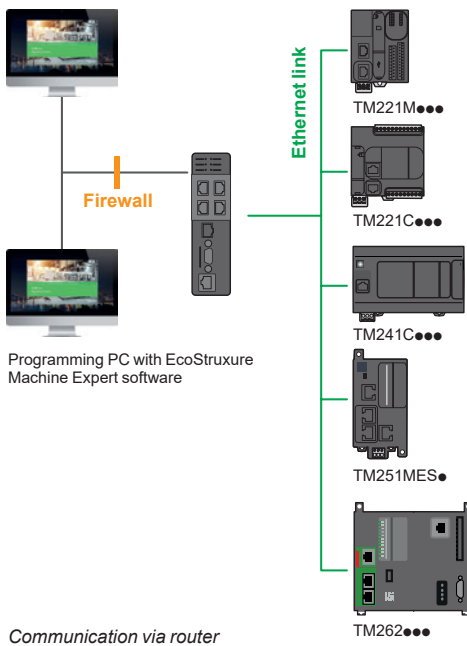
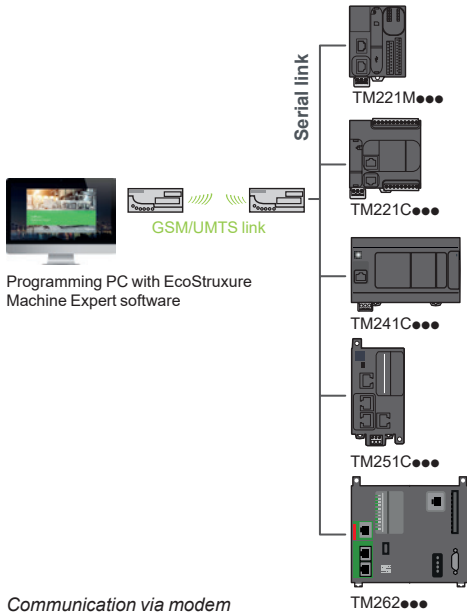

Modicon M251

Programmable Logic Controller for modular and distributed architectures

I/O expansion with Modicon TM3 expansion modules

I/O expansion with Modicon TM3 modules

Modicon TM3 expansion modules

Modicon M251 logic controllers have no embedded I/O, yet can still take Modicon TM3 expansion modules for connecting sensors and actuators locally:

- digital I/O modules for creating configurations with up to 448 digital I/O
- analog I/O modules for creating configurations with up to 112 analog I/O, to receive the signals from, for example, position, temperature, and speed sensors and also capable of controlling variable speed drives or any other device with a current or voltage input
- expert modules for controlling TeSys motor-starters, connected with RJ 45 cordsets to simplify wiring the control section
- functional safety modules which simplify wiring and can be configured in the EcoStruxure Machine Expert software

In addition, the Modicon TM3 expansion system is flexible due to the possibility of remotely locating some of the Modicon TM3 modules in the enclosure or another cabinet, up to 5 meters (16.404 ft) away, using a bus expansion system.

The Modicon TM3 expansion system is common to the ranges of Modicon M221, M241 and M251 logic controllers, and Modicon M262 Logic/Motion controller meaning that applications can be upgraded without changing expansion module.

I/O configuration

EcoStruxure Machine Expert software is used to configure the local and remote I/O and distributed I/O islands.

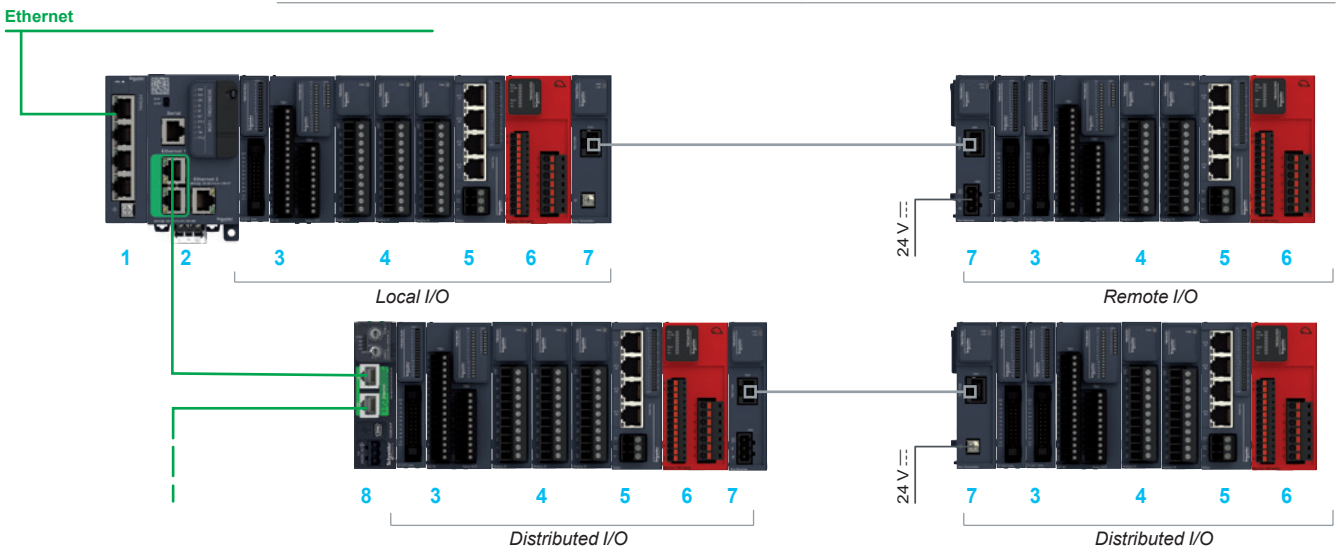

- | | |
|--|--|
| 1 TM4ES4 Ethernet switch communication module | 6 Functional safety modules |
| 2 Modicon TM251MESE logic controller | 7 Bus expansion modules (transmitter and receiver) and bus expansion cable |
| 3 Digital I/O modules | 8 TM3BC bus coupler module |
| 4 Analog I/O modules | |
| 5 Expert module for controlling TeSys motor starters | |

Local I/O

Maximum configuration: 7 Modicon TM3 expansion modules associated with a Modicon M251 logic controller.

Remote I/O

Maximum configuration : 14 Modicon TM3 expansion modules (7 local modules + 7 remote modules) with Modicon TM3 bus expansion modules (transmitter module and receiver module).

The transmitter and receiver bus expansion modules can be used to:

- increase the number of expansion modules that can be connected to a Modicon M25 logic controller from 7 to 14
- locate Modicon TM3 expansion modules remotely, up to 5 m (16.40 ft) away

The transmitter module and receiver module are physically connected by a bus expansion cable, reference **ACTPC6FULS●●WE**, or any other Cat 5E, F/UT cable up to 5 m (16.40 ft).

Distributed I/O

The Modicon TM3BC bus coupler module is used to create distributed I/O islands on the Ethernet network.

- The bus coupler module is connected via an isolated RJ45/RJ45 cable.
- Maximum configuration: 14 Modicon TM3 expansion modules (7 modules + 7 modules) with the Modicon TM3 bus expansion system (transmitter module and receiver module).

Modicon M251

Programmable Logic Controller for modular and distributed architectures
Embedded communication



Embedded communication

Control architecture for modular machines on Ethernet network

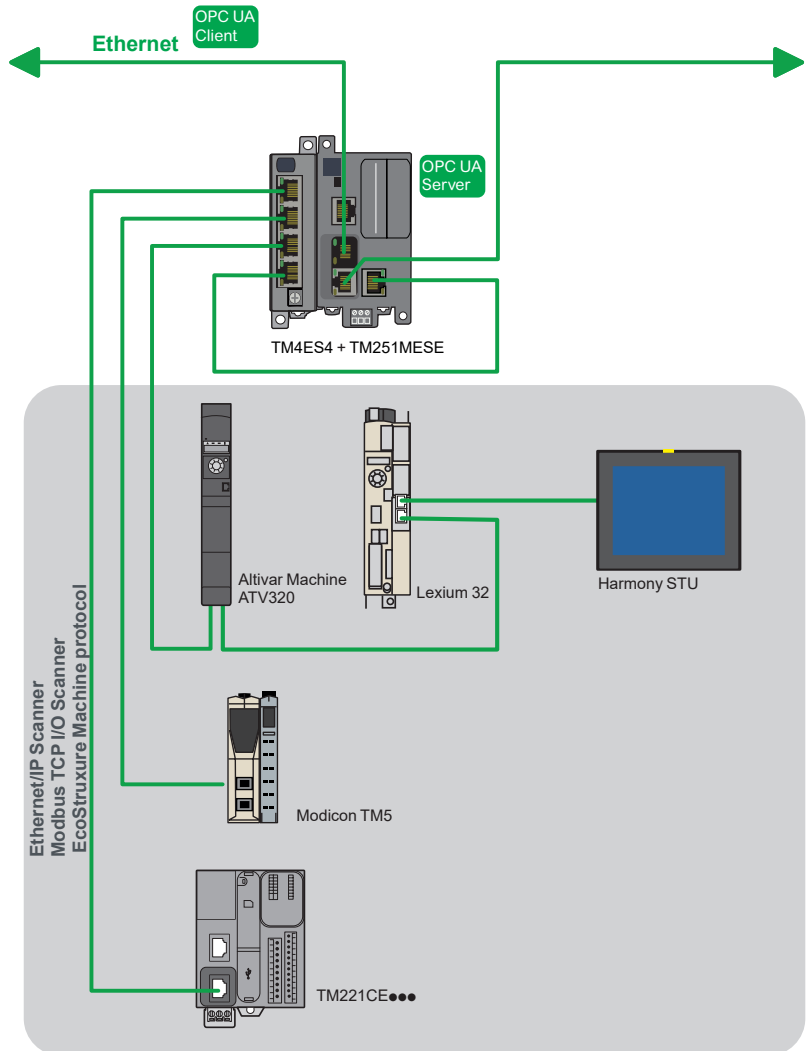

M251 controllers have 2 embedded Ethernet ports connected by an RJ 45 switch (10/100 Mbps, MDI/MDIX) with the Modbus TCP, EtherNet/IP, UDP, TCP, SNMP and EcoStruxure Machine on Ethernet protocols. These ports are specifically for communication between machines or to your factory network. These ports are marked "Ethernet" or "Ethernet 1".

- Every M251 controller has an embedded web server and FTP (Client/Server) server. As well as the default address based on the MAC address, a controller IP address can be assigned via a DHCP server or via a BOOTP, SQL Client and SNMP (Client/Server) server.
- Ethernet ports also offer the same upload/download, update and debug functions as the programming port (USB mini-B) when the controller is supplied with power.
- A firewall is used to filter the IP addresses that are authorized to access the controller and to lock each communication protocol.
- **TM251MESE** controllers have, in addition to the 2 embedded "Ethernet and Ethernet 1" ports, an optimized "Ethernet 2" port for connecting field devices (variable speed drives, distributed I/O, etc.), RJ 45 type, with EtherNet/IP Scanner, Modbus TCP I/O Scanner, Ethernet Modbus TCP Client/Server, EtherNet/IP Originator and Adapter, UDP, TCP, SNMP and EcoStruxure Machine services.
 - EtherNet/IP Scanner can be used to connect up to 16 slave devices managed by the controller in 10 ms (1024 input words + 1024 output words).
 - Modbus TCP I/O Scanner can be used to connect up to 64 slave devices managed by the controller in 64 ms.

Connection cables and accessories for Industrial Ethernet network: please consult our catalog [DIA3ED2160105EN](#).

Modicon M251

Programmable Logic Controller for modular and distributed architectures

Embedded communication

Embedded communication (continued)

Control architecture for modular machines on CANopen bus

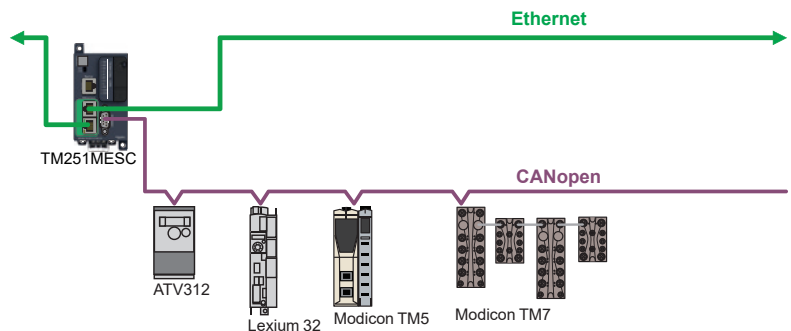

TM251MESC controllers have an embedded master CANopen port.

- The link can be configured between 20 Kbps and 1 Mbps, and supports up to 63 slaves with 252 TPDO (1008 words) and 252 RPDO (1008 words).
- CANopen-based architectures can be used to distribute I/O modules as close to the sensors and actuators as possible, thus reducing wiring costs and times, and to communicate with different devices such as variable speed drives, servo drives, etc.
- The CANopen configurator is integrated in the EcoStruxure Machine Expert software and can also be used to import standard description files in EDS format.

CANopen connection cables and accessories: please consult our catalog [DIA3ED2160104EN](#).

Communication on SAE J1939 network

The SAE J1939 protocol is available on the CANopen port of the **TM251MESC** logic controller.

The SAE J1939 protocol is mainly used in the commercial vehicles sector to communicate with the various electronic control units embedded in the same vehicle such as the engine, transmission, braking system, retarder and dashboard, etc.

Serial link

Every M251 controller has an embedded serial link that can be configured as RS 232 or RS 485.

In addition, a 5 V/200 mA voltage is available on the RJ 45 connector, which can therefore power a Harmony **STO** or **STU** HMI or a Bluetooth® communication adapter, or other devices.

This link incorporates the two most commonly used protocols on the market:

- Master or Slave Modbus ASCII/RTU
- Character string (ASCII)

Connection cables and accessories for serial link: please consult catalog [DIA3ED2160106EN](#).

Programming port with power off charging function

The programming port, equipped with a USB mini-B connector, is embedded in every M251 controller; it is dedicated to communication with a PC equipped with EcoStruxure Machine Expert for:

- programming
- debugging
- maintenance

In addition, it offers the ability to load an application program or update the firmware without the controller being powered by another source.

Modicon M251

Programmable Logic Controller for modular and distributed architectures

Modicon M251 logic controllers

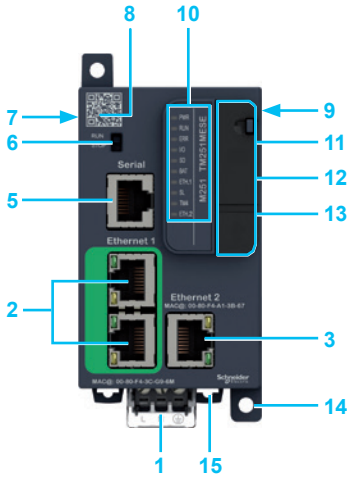

TM251MESE controller

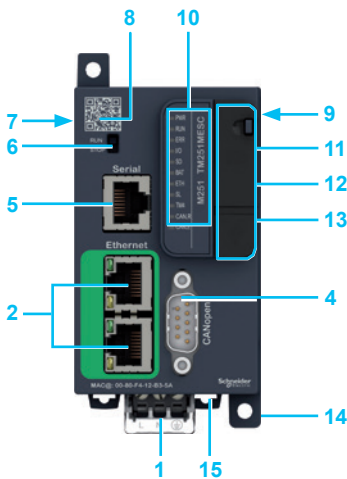

TM251MESC controller

Description

M251 controllers

- 1 Removable screw terminal block, 3 terminals for connecting the 24 V $\overline{\text{DC}}$ supply.
- 2 2 RJ 45 connectors connected by an internal switch for “Machine” or “Factory” Ethernet network, with exchange and activity speed LED indicator.
- 3 On **TM251MESE** controller: RJ 45 connector for “fieldbus” Ethernet 2 network with exchange and activity speed LED indicator.
- 4 On **TM251MESC** controller: a connector for linking to the CANopen and SAE J1939 machine bus (9-way SUB-D).
- 5 SL serial link port (RS 232 or RS 485): RJ 45 connector.
- 6 Run/Stop switch.
- 7 TM4 bus connector: communication bus for linking to TM4 communication modules.
- 8 QR code for access to the controller technical documentation.
- 9 Modicon TM3 bus connector for linking to a Modicon TM3 expansion module.
- 10 LED display block showing: the status of the controller and its components (battery, industrial SD memory card), the status of the embedded communication ports (Ethernet 1 and 2, CANopen, serial link).

Behind the removable cover 11, 12, 13

- 11 Slot for the industrial SD memory card.
- 12 Backup battery slot.
- 13 A USB mini-B connector for a programming terminal.
- 14 Lugs for panel mounting, with screws.
- 15 Clip for locking on $\overline{\text{DIN}}$ symmetrical rail.

Characteristics of M251 logic controllers

Conformity

■ Certifications

- CE, cULus Listing Mark, C-Tick, EAC, LR, ABS, DNV and GL, cULus Haz. Loc. approval
- ODVA and Achilles.

■ Standards

- IEC/EN 61131-2 (Edition 2 2007), UL508, ANSI/ISA 12.12.01-2007, CSA C22.2 No. 213, No. 142, E61131-2 and IACS E10.

Environmental characteristics

- Ambient operating temperature: - 10...+ 55°C (+14...+ 131°F)
- Storage temperature: - 40...+ 70°C (- 40...+ 158°F)
- Relative humidity: 5...95% (non-condensing)

Operating altitude:

- 0...2,000 m (0...6,562 ft): complete specification for temperature and exposure
- 2,000...4,000 m (6,562...13,123 ft):
 - temperature derating: + 1°C/400 m (+ 1.8°F/1,312 ft)
 - insulation losses: 150 V $\overline{\text{DC}}$ /1,000 m (150 V $\overline{\text{DC}}$ /3,280 ft)

- Storage altitude: 0...3,000 m (0...9,842 ft)

Immunity to mechanical stress:

- For 1131: 5...8.4 Hz (amplitude 3.5 mm/0.138 in.); 8.4...150 Hz (acceleration 1 g)
- For merchant navy: 5...13.2 Hz (amplitude 1.0 mm/0.039 in.); 13.2...100 Hz (acceleration 0.7g)

Supply characteristics

- 24 V $\overline{\text{DC}}$ power supply
- Voltage limit (including ripple): 19.2...28.8 V $\overline{\text{DC}}$
- Immunity to micro-cuts (class PS-2): 10 ms
- Max. consumption: 45 W

Modicon M251

Programmable Logic Controller for modular and distributed architectures

M251 logic controllers, options, separate parts, programming software, connection cables



TM251MESE



TM251MESC



TMSD1

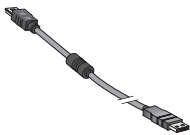

TCSXCNAMUM3P

References

Modicon M251 logic controllers (1)

Designation	Embedded communication ports				Reference	Weight kg lb
	Ethernet 1 "Machine" or "Factory" (RJ 45)	Ethernet 2 "Fieldbus" (RJ 45)	CANopen (9-way SUB-D): CANopen and SAE J1939	Serial link (RJ 45)		
24 V $\bar{\text{---}}$ power supply						
M251 logic controllers	2 (connected by a switch)	1	–	1	TM251MESE	0.220 0.485
	2 (connected by a switch)	–	1	1	TM251MESC	0.220 0.485

Options for Modicon M251 logic controllers

Designation	Description	Reference	Weight kg lb
Industrial SD memory card	Application backup and program transfer Capacity: 256 MB	TMSD1	0.004 0.009

Replacement parts

Designation	Description	Reference	Weight kg lb
Set of power supply terminal blocks	8 removable terminal blocks with screw terminals	TMAT2PSET	0.127 0.280

Backup battery The battery supplied with each controller is not available as a separate part in the Schneider Electric catalog. If a replacement part is needed, only use a Panasonic battery type BR2032.

Programming software

Designation	Use	Reference
EcoStruxure Machine Expert software	For Modicon M251 logic controllers	Please consult our catalog DIA3ED2180701EN

Expansion modules

Designation	Use	Reference
Modicon TM3 expansion modules	For Modicon M251 logic controllers	Please consult our catalogue DIA3ED2140109EN

Communication modules

Designation	Use	Reference
Modicon TM4 communication modules	Ethernet switch module, slave Profibus DP module	See page 18

Connection cables

Designation	Use		Length	Reference	Weight kg lb
	from	to			
Programming cables	PC USB port	USB mini-B port on M251 controllers	3 m (0.98 ft)	TCSXCNAMUM3P (3)	0.065 0.143
			1.8 m (5.90 ft)	BMXXCAUSBH018	0.065 0.143

(1) M251 controllers are supplied with:
 - a removable screw terminal block for connecting the power supply
 - a BR2032 button cell backup battery
 (2) Every M251 logic controller has an embedded USB mini-B programming port.
 (3) Unshielded, non-grounded cable. Only for use on temporary connections. For permanent connections, use cable reference BMXXCAUSBH018.

Modicon M251

Programmable Logic Controller for modular and distributed architectures

Modicon TM4 communication modules

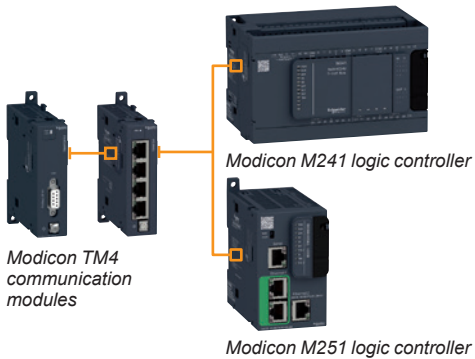

Presentation

Applications

The Modicon TM4 communication module offer is dedicated to Modicon M241 and Modicon M251 logic controllers, increasing the options for connection.

Two communication module models are available:

- The TM4ES4 Ethernet switch module, offering an Ethernet connection with 4 ports
- The TM4PDPS1 Profibus DP slave module

■ Ethernet switch module

The TM4ES4 module is a 4-port Ethernet interface (10/100 Mbps, MDI/MDIX) with the following protocols: Ethernet Modbus TCP Client/Server, Ethernet/IP Adapter, UDP, TCP, SNMP, OPC UA Server and EcoStruxure Machine.

- The TM4ES4 module is ready for use as soon as it is connected to the communication bus of M241 and M251 controllers.
- This module is used to add the Ethernet function to TM241C24● and TM241C40● controllers without an embedded Ethernet port, while offering an additional Ethernet switch function.
- Connected on controllers with embedded Ethernet port type TM241CE24●●● or TM241CE40●●●, it can constitute a second Ethernet link for the "Machine" or "Factory" network.
- Connected on controllers with an embedded Ethernet port type TM241CE●●● or on a TM251MES● controller, it can also constitute an autonomous switch with four ports: communication between the TM4ES4 module and the Modicon M241 and M251 controllers is not automatically enabled by the bus connector.

■ Slave Profibus DP module

The TM4PDPS1 communication module can be used to configure a slave connection on the Profibus DP bus.

Rules for combination

Up to 3 communication modules (in total) can be added on the left of M241 and M251 logic controllers, in order to increase their options for connection to the Ethernet and Profibus networks.

- TM241C24●●●, TM241C40●●●, TM241CE24●●● and TM241CE40●●● controllers can all be provided with a TM4ES4 module with the Ethernet port function and 2 TM4ES4 modules with the autonomous switch function while complying with the maximum number of 3 TM4 modules in total.
- TM241CEC24● and TM251●●● controllers can be provided with 3 TM4ES4 modules with the autonomous switch function while complying with the maximum number of 3 TM4 modules in total.
- TM4 communication modules are assembled by simply clipping them onto the left-hand side of M241 and M251 controllers, and a bus expansion connector is used to distribute data and power.

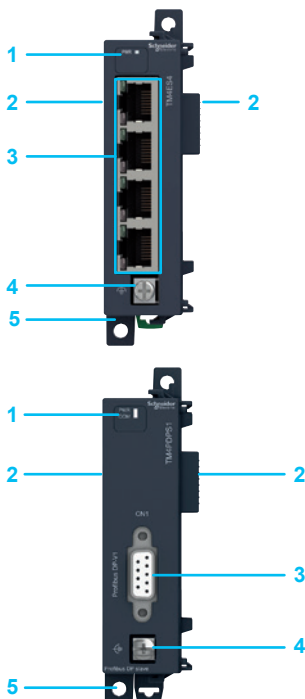

Description

■ TM4ES4 Ethernet switch module

- 1 Power on LED indicator.
- 2 Bus connector (1 on each side).
- 3 4 RJ 45 connectors for Ethernet network, with exchange and activity speed LED indicator.
- 4 Screw terminal for the functional ground (FG) connection.
- 5 Locking clip on \perp symmetrical rail.

■ TM4PDPS1 slave Profibus DP module

- 1 Power on LED indicator.
- 2 Bus connector (1 on each side).
- 3 9-way SUB-D connector for connection to the Profibus DP bus.
- 4 Screw terminal for the functional ground (FG) connection.
- 5 Locking clip on \perp symmetrical rail.

Modicon M251

Programmable Logic Controller for modular and distributed architectures

Modicon TM4 communication modules

References



TM4ES4



TM4PDPS1

Options for M251 logic controllers

Designation	Description	Reference	Weight kg lb
Communication modules	Ethernet switch module with switch function and 4 embedded ports Equipped with 4 RJ 45 connectors (10/100 Mbps, MDI/MDIX)	TM4ES4 (1)	0.110 0.243
	Slave Profibus DP module Equipped with a 9-way SUB-D connector	TM4PDPS1	0.110 0.243

(1) Can be used as an Ethernet port or an autonomous switch depending on the controller model and configuration.

B	
BMXXCAUSBH018	17
	20
T	
TCSXCNAMUM3P	17
	20
TM4ES4	19
	20
TM4PDPS1	19
	20
TM251MESC	17
	20
TM251MESE	17
	20
TMASD1	17
	20
TMAT2PSET	17
	20

Life Is On



Learn more about our products at
www.se.com

The information provided in this documentation contains general descriptions and/or technical characteristics of the performance of the products contained herein. This documentation is not intended as a substitute for and is not to be used for determining suitability or reliability of these products for specific user applications. It is the duty of any such user or integrator to perform the appropriate and complete risk analysis, evaluation and testing of the products with respect to the relevant specific application or use thereof. Neither Schneider Electric nor any of its affiliates or subsidiaries shall be responsible or liable for misuse of the information contained herein.

Design: Schneider Electric
Photos: Schneider Electric

Schneider Electric Industries SAS

Head Office
35, rue Joseph Monier - CS 30323
F-92500 Rueil-Malmaison Cedex
France

DIA3ED2140108EN
October 2023 - V8.0