



Catalog
D 34



Edition
July 2023

MOTION CONTROL DRIVES

SIMATIC MICRO-DRIVE

Drive system for safety
extra low-voltage

Related catalogs

<p>Motion Control Drives D 31.1 SINAMICS Converters for Single-Axis Drives Built-In Units</p> <p>E86060-K5531-A111-A4-7600</p>		<p>Industrial Controls IC 10 SIRIUS</p> <p>PDF (E86060-K1010-A101-B5-7600)</p>	
<p>Motion Control Drives D 31.2 SINAMICS Converters for Single-Axis Drives Distributed Converters</p> <p>PDF (E86060-K5531-A121-A3-7600)</p>		<p>Low-Voltage Power Distribution and Electrical Installation Technology LV 10 SENTRON • SIVACON • ALPHA</p> <p>PDF (E86060-K8280-A101-B6-7600)</p>	
<p>Motion Control Drives D 31.5 SINAMICS Converters for Single-Axis Drives SINAMICS G120X infrastructure converters for HVAC/Water/Wastewater</p> <p>PDF (E86060-K5531-A151-A4-7600)</p>		<p>SIMATIC ST 70 Products for Totally Integrated Automation</p> <p>PDF (E86060-K4670-A101-B9-7600)</p>	
<p>Motion Control Drives D 32 SINAMICS S210 Servo Drive System</p> <p>PDF (E86060-K5532-A101-A8-7600)</p>		<p>SIMATIC HMI / PC-based Automation ST 80/ST PC Human Machine Interface Systems PC-based Automation</p> <p>PDF (E86060-K4680-A101-DO-7600)</p>	
<p>SINAMICS S120 D 21.3 Chassis Format Converter Units Chassis-2 Format Converter Units Cabinet Modules, Cabinet Modules-2 SINAMICS S150 Converter Cabinet Units PDF (E86060-K5521-A131-A8-7600)</p>		<p>Industrial Communication IK PI SIMATIC NET</p> <p>E86060-K6710-A101-B8-7600</p>	
<p>Motion Control Drives D 21.4 SINAMICS S120 and SIMOTICS</p> <p>E86060-K5521-A141-A1-7600</p>		<p>SiePortal Information and Ordering Platform on the Internet:</p> <p>sieportal.siemens.com</p>	
<p>SIMOTICS S-1FG1 D 41 Servo geared motors Helical, Parallel shaft, Bevel and Helical worm geared motors</p> <p>PDF (E86060-K5541-A101-A6-7600)</p>			
<p>SIMOTICS GP, SD, XP, DP D 81.1 Low-Voltage Motors Type series 1FP1, 1LE1, 1LE5, 1MB1, 1MB5, 1PC1 Frame sizes 63 to 450 Power range 0.09 to 1000 kW PDF (E86060-K5581-A111-B6-7600)</p>			
<p>SIMOGEAR D 50.1 Geared Motors Helical, parallel shaft, bevel, helical worm, worm geared motors and electric-monorail geared motors PDF (E86060-K5250-A111-A9-7600)</p>			

**MOTION CONTROL DRIVES****SIMATIC MICRO-DRIVE****Drive system for safety extra low-voltage**[siemens.com/d34](https://www.siemens.com/d34)

Dear Customer,

We are pleased to present you with the new edition of Catalog D 34 · July 2023. The catalog provides a comprehensive overview of the SIMATIC MICRO-DRIVE drive system for safety extra low-voltage.

SIMATIC MICRO-DRIVE is an extremely versatile, system-integrated and safety-related drive system which covers a wide range of applications in the protective extra-low voltage range. The system comprises the SIMATIC MICRO-DRIVE PDC Drives (ProfiDriveControl) and SIMATIC MICRO-DRIVE TM Drives – the new drive controller modules for SIMATIC ET 200SP – as well as flexibly applicable motors and plug-in cables.

Suitable control systems from the SIMATIC portfolio from Siemens optimally round off the motion control functions of this future-proof solution.

The products listed in this catalog are also included in SiePortal. Please contact your local Siemens office for additional information.

Up-to-date information about SIMATIC MICRO-DRIVE is available on the internet at:

www.siemens.com/micro-drive

You can access our SiePortal on the internet at

<https://sieportal.siemens.com>

Your personal contact will be glad to receive your suggestions and recommendations for improvement.

You can find your contact in our contact person database at

www.siemens.com/automation-contact

We hope that you will enjoy using Catalog D 34 · July 2023 as a selection and ordering reference document and wish you every success with our products and solutions.

With kind regards

A handwritten signature in blue ink, appearing to read 'Frank Golüke', is positioned above the printed name and title.

Frank Golüke
Vice President
General Motion Control
Siemens AG, Digital Industries, Motion Control

SIMATIC MICRO-DRIVE

Drive system for safety extra low-voltage

Motion Control Drives



Catalog D 34 · July 2023

Supersedes:
Catalog D 34 · August 2021

Refer to SiePortal for current updates of this catalog:
<https://sieportal.siemens.com>

Please contact your local Siemens branch.

© Siemens 2023

System overview

1

SIMATIC MICRO-DRIVE drive system

2

Appendix

3



The products and systems described in this catalog are manufactured/distributed under application of a certified quality management system in accordance with EN ISO 9001 (Certified Registration No. 001323 QM15). The certificate is recognized by all IQNet countries.

Digitalization in drive technology

From the digital world to the real world

[siemens.com/digital-drives](https://www.siemens.com/digital-drives)

Increase your transparency and productivity by digitalizing your drive technology

Many drives are used in the manufacturing and process industries. They produce lots of data anyway – why not use them to increase the availability and productivity of machines and plants?

Drive technology offers the ideal entry point into the world of digitalization – for plant and machine builders as well as for users.

The digitalization portfolio for the drive train spans over the complete life cycle – from the design phase to realization and optimization – in the digital and the real world.

Our portfolio contains drive simulation solutions and efficient engineering tools, comprehensive connectivity that allows drives to be easily linked to the relevant platforms as well as smart analytics (e.g. cloud and edge apps) and drive system services.

These solutions enable you to gain a better understanding of processes, states and utilization. The health status of the drive train can be monitored and analyzing drive data enables an early detection of anomalies and reduces downtimes. This way, availability and productivity of machines and plants can be increased and the actual maintenance demand can be identified. Furthermore, data-based business models and service offerings are facilitated.

Our digitalization portfolio covers all phases of the life cycle: from the design phase to realization and optimization. It covers the digital and the real drive train.

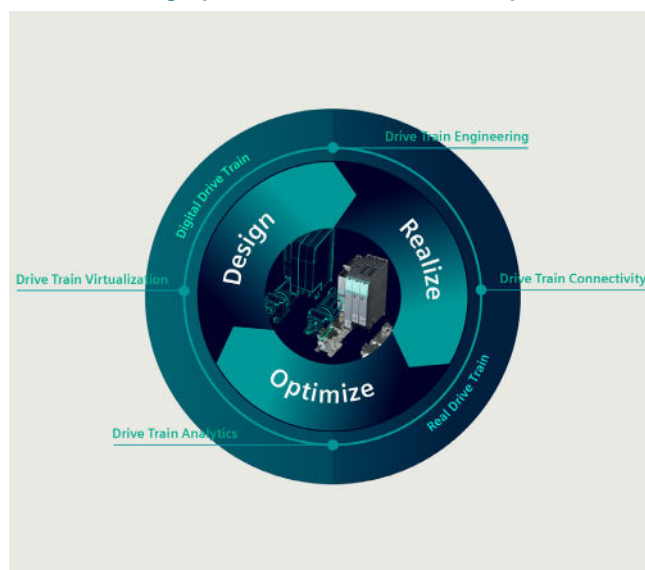

Design: By creating a digital twin of the drives, machine builders can shorten their time-to-market since they can design, simulate and optimize their machine before ordering any material or products. Together with other tools from the engineering box, simulation can also speed up the engineering phase of drives and entire machines, for example by virtual commissioning of the PLC.

Realize: Once the machine is in operation, the drives can be connected to other platforms, for example to the cloud and Industrial Edge. This creates transparency in terms of what is going on inside the drive train, e.g. with regard to the actual current, torque and speed.

Optimize: To understand the collected data, our drive train analytics portfolio provides algorithms and analysis tools to unlock the potential of the data and turn the gained transparency into insights and valuable knowledge. These insights can then again be used in the design phase of the next life cycle, thus closing the loop.

Benefits of drive train digitalization

Machine builders



Availability



Increase the availability of your machines

Speed



Shorten time-to-market

Business models



Develop new service and business models

Machine operators



Productivity



Increase the productivity of your production

Flexibility



Increase the flexibility of your production

Efficiency



Identify potential for optimization

Benefits for machine and plant builders

- Increased availability of machines and plants – thanks to digital options for checking and implementing design improvements and comprehensive monitoring of drive systems
- Shorter time-to-market and faster development times – thanks to practical software tools and a continuous database for concurrent development processes as well as virtual simulations, tests, and commissioning of machines and plants
- New options for future service and business models – ranging from customized application solutions and digital services to contractually guaranteed availabilities of machines and plants

Benefits for machine and plant operators

- Increased availability and productivity of production, fewer unscheduled downtimes – through the early detection of deviations and emerging risks thanks to digital drive monitoring
- More flexible production down to batch size 1 – through more effective use of knowledge from existing production lines thanks to transparent utilization, states, locations, and capacities down to the drive level
- Identification of potential for optimization to make production faster, better, and more efficient thanks to data-based transparency – for example, for faster modifications, simpler quality control, and the early prediction of maintenance demand as well as demand-oriented maintenance



TIA Selection Tool – quick, easy, smart configuration

For you to get the most out of our portfolio quickly and easily.

Do you always need the optimum configuration for planning your project?

For your application we offer the TIA Selection Tool to support all project planners, beginners and experts alike.

No detailed portfolio knowledge is necessary.

TIA Selection Tool is available for download as a free desktop version or a cloud variant.

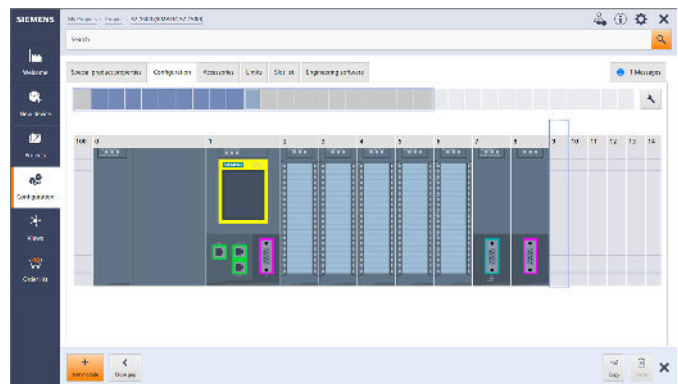

Your Advantages

Quick

- Configure a complete project with just a few entries – without a manual, without special knowledge
- Import and export of hardware configuration to TIA Portal or other systems
- Ideal visualization of the projects to be configured

Easy

- Tool download either as desktop version or web-based cloud version
- Technically always up-to-date about product portfolio and innovative approaches
- Highly flexible, secure, cross-team work in the cloud
- Direct ordering in SiePortal

Smart

- Smart selection wizard for error-free configuration and ordering
- Configuration options can be tested and simulated in advance
- Library for archiving sample configurations

The TIA Selection Tool is a completely paperless solution.

Download it now:

www.siemens.com/tst

For more
information,
scan the
QR code



System overview



1/2 **System overview**

1/6 **Safety Integrated**

1/10 **Communication**

1/10 PROFINET

1/13 PROFIdrive

SIMATIC MICRO-DRIVE drive system

System overview

System overview

1

Overview



SIMATIC MICRO-DRIVE drive system, PDC Drives, PDC100, PDC100F, PDC600, PDC600F, PDC1000 V1 variants



Drive controller modules for ET200SP
SIMATIC MICRO-DRIVE F-TM StepDrive ST, ServoDrive HF and
ServoDrive ST

First-class drive system in the protective extra-low voltage range

The requirements for motion control tasks in automation are ever increasing and are becoming more and more multi-faceted and complex. Digitalization is bringing about new solution approaches, regardless of the industry or application.

Fit for digitalization with SIMATIC MICRO-DRIVE

The SIMATIC MICRO-DRIVE drive system allows you to make a perfect entry into the world of digitalization. Thanks to Totally Integrated Automation (TIA), converters and motors are completely integrated into the Siemens automation environment and can be easily selected using the TIA Selection Tool and configured using the TIA Portal. A wide range of tools for the complete machine building cycle ensures efficient engineering and fast commissioning. Machine data is made available through MindSphere, the cloud-based, open IoT operating system from Siemens.

Well designed, flexible and fit for the future

SIMATIC MICRO-DRIVE is an extremely versatile, seamless and safety-oriented drive system that covers a wide range of applications in the protective extra-low voltage range.

It comprises the SIMATIC MICRO-DRIVE PDC Drives and TM Drives, as well as versatile EC motors and plug-in cables. The right controllers from the SIMATIC portfolio from Siemens optimally round out the motion control functions of this future-proof solution.

The F-TM StepDrive ST completes the portfolio within the range of controlling stepper motors.

In combination with EC Motors and stepper motors up to 280 W the F-TM ServoDrive HF allows positioning and speed control in very confined spaces. The triple overload capability and the support of BiSS-C Multiturn encoders extend the scope of applications.

Can be combined with motors and plug-in cables from selected Siemens Product Partners

To ensure that all of the requirements in drive technology are met in the best way possible, the SIMATIC MICRO-DRIVE drive system is compatible with individual and supplementary motors (Dunkermotoren, ebm-papst) and plug-in cables (Harting, KnorrTec) from well-established Siemens Product Partners. This allows an optimal combination of suitable products from proven product partners for the individual application.

Strong in classic and innovative applications

SIMATIC MICRO-DRIVE is the ideal drive in numerous application areas. The system stands out when executing positioning tasks in production and manufacturing as well as in innovative application domains. Examples include drives for storage and retrieval machine shuttles and high bay racking systems, driverless transport systems as well as medical applications such as safely and reliably moving MRT examination tables and automatically aligning ceiling-mounted devices in radiographic applications.

Overview

For all applications

Moving

Energy-efficient and rugged solutions for basic conveyor technology with roller or chain conveyors, for hoisting gear and elevators – as well as for storage and retrieval machines – and always with Safety Integrated on board.

Processing

Ideal solution for continuous processes with simple speed and torque accuracy, for example with extruders, centrifuges, agitators on all types of production machines – motion control, isochronous communication (only for SIMATIC MICRO-DRIVE PDC Drives) and Safety Integrated.

Positioning

SIMATIC MICRO-DRIVE is the solution for 24/48 V DC applications: The positioning of individual axes and even the coordinated interpolation of several axes – such as in complex robotic applications – can be achieved easily.

Simple commissioning of SIMATIC MICRO-DRIVE PDC Drives through One Button Tuning and TIA Portal (V15 SP1 or higher)

Commissioning and engineering are possible with TIA Portal (V15 SP1 or higher). The tool for configuration, commissioning and diagnostics has been optimized with regard to the consistent utilization of the TIA Portal advantages – one shared work environment for PLC, HMI and drives.

For more information, see the Engineering tools section.

Safety Integrated

The integrated safety functions provide highly effective, application-oriented protection for personnel and machinery (terms as defined in IEC 61800-5-2).

The following Safety Integrated functions are included (not all of the functions are included in all of the drive controllers):

- Safe Torque Off (STO) ¹⁾
- Safe Stop 1 (SS1, only for failsafe variants, e.g. PDC100F)
- Safely-Limited Speed (SLS, only for failsafe variants, e.g. PDC100F)
- Safely-Limited Torque (SLT, only for PDC100F)
Monitoring of motor current and torque during operation by means of safely-limited torque
- Safe Speed Monitor (SSM, only for failsafe variants, e.g. PDC100F)

The Safety Integrated functions are implemented electronically and therefore require no additional installation effort or space in the control cabinet. Furthermore, the costs are considerably lower than for externally implemented monitoring functions.

The Safety Integrated functions can be easily put into operation via the TIA Portal (V15 SP1 or higher) and activation through a SIMATIC controller via PROFIsafe.

Perfect combination with SIMATIC S7-1500, SIMATIC S7-1500 T-CPU, SIMATIC ET 200SP Open Controller via PROFINET or SIMATIC ET 200SP

Communication with the higher-level control takes place via PROFINET. For optimal interaction between the controller and

the SIMATIC MICRO-DRIVE drive system, SIMATIC S7-1200, SIMATIC S7-1500, SIMATIC S7-1500 T-CPU, SIMATIC ET 200SP Open Controller can be used as the control system.

The SIMATIC MICRO-DRIVE PDC Drives features an integrated PROFINET IRT communication interface with a communication cycle of up to 1 ms for connecting to a control system.

Standardized protocols for linking to a higher-level control with RT and IRT are supported – the PROFIdrive profile for positioning mode and the PROFIsafe profile for safety-oriented communication. Functions such as Shared Device and ring redundancy PROFInergy are also possible.

All from a single source: Through the use of Motion Control functionalities in the controller, the combination of converter and SIMATIC S7 automation system or a controller allows ideally harmonized engineering. As a result, commissioning times are shortened.

Technology objects and Motion Control blocks of the higher-level controller provide numerous possibilities of motion, such as continuous operation, positioning, synchronous operation, coordinated motion of multiple axes, cam disks, or interpolation.

Siemens offers tested SIMATIC PLC/HMI application examples for connection of the drive system to a SIMATIC control system:

www.siemens.com/sinamics-applications

Further information on the SIMATIC S7-1500, SIMATIC S7-1500 T-CPU controllers and SIMATIC ET 200SP Open Controller is available in the ST 70 Catalog and on the internet at

www.siemens.com/simatic-s7-1500

¹⁾ Does not apply for PDC1000 V1.

SIMATIC MICRO-DRIVE drive system

System overview

System overview

1

Overview

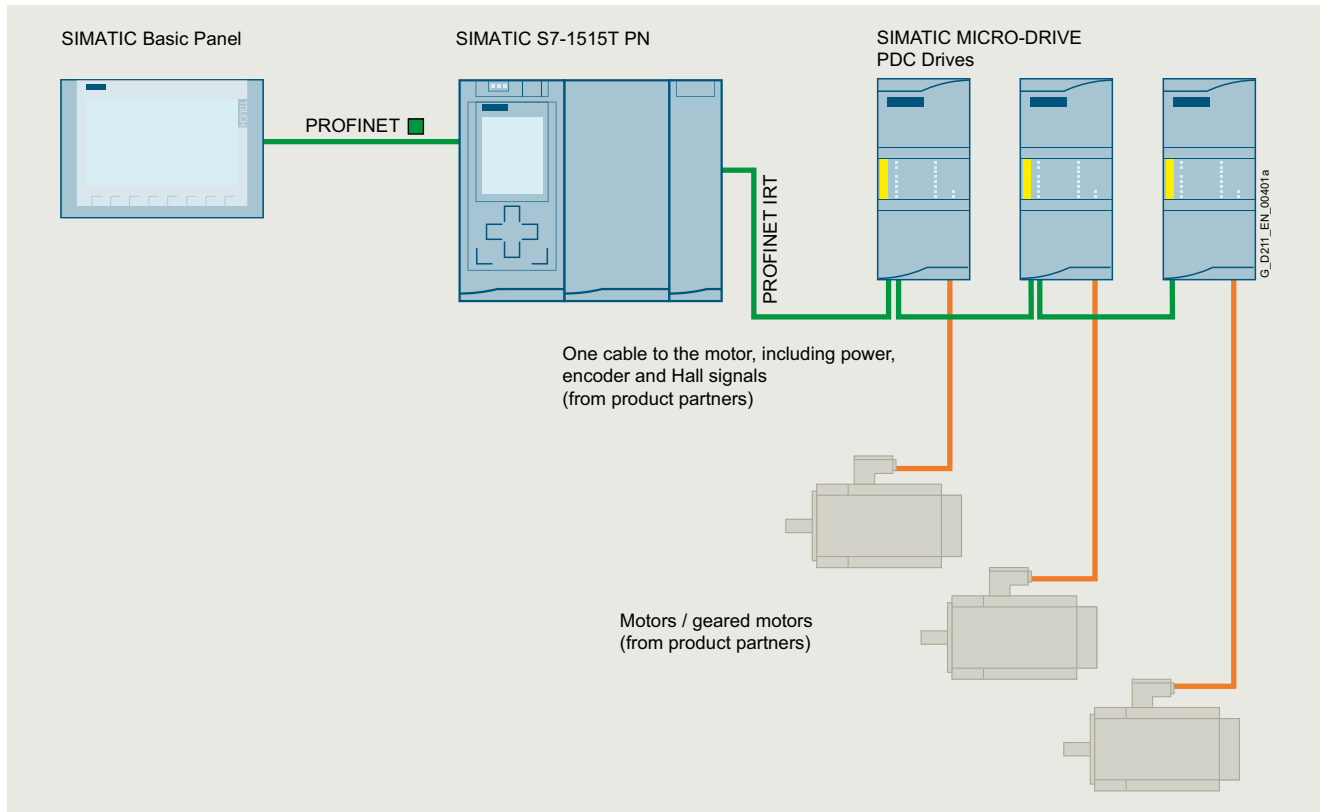

Example: communication via PROFINET with SIMATIC MICRO-DRIVE PDC Drives

Overview

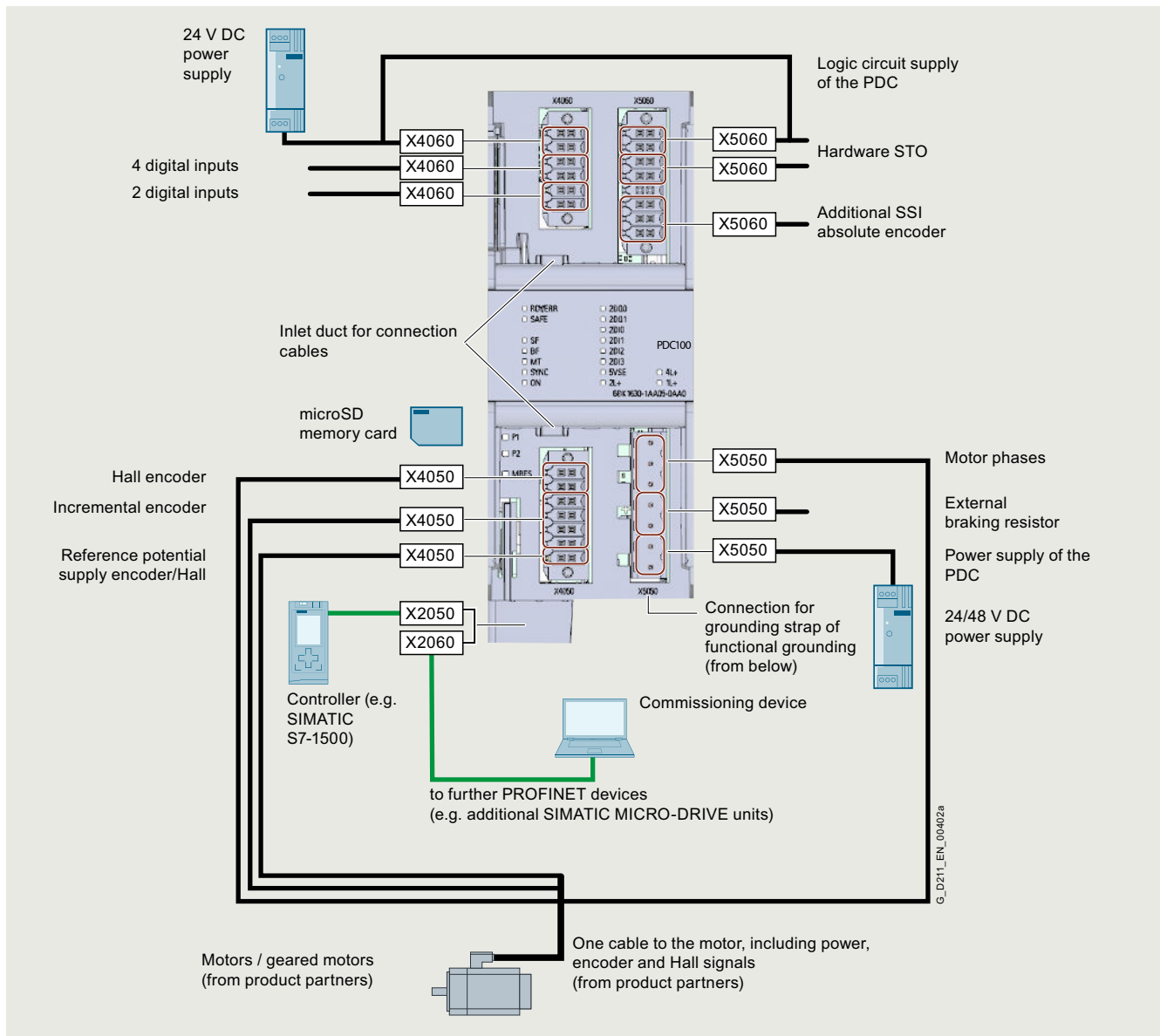

Connection example: SIMATIC MICRO-DRIVE drive system, PDC Drives, PDC100 variant

Can be used worldwide

In addition to the usual approvals, the UL approval for the North American market has also been requested for the SIMATIC MICRO-DRIVE drive system. Thus, the SIMATIC MICRO-DRIVE drive system is available for worldwide use.

Further information

Detailed information on the SIMATIC MICRO-DRIVE drive system, including the latest technical documentation (brochures, tutorials, dimensional drawings, certificates, equipment manuals and operating instructions), is available on the internet at:

www.siemens.com/micro-drive

and also via the TIA Selection Tool:

www.siemens.com/tia-selection-tool

SIMATIC MICRO-DRIVE drive system

System overview

Safety Integrated

1

Overview

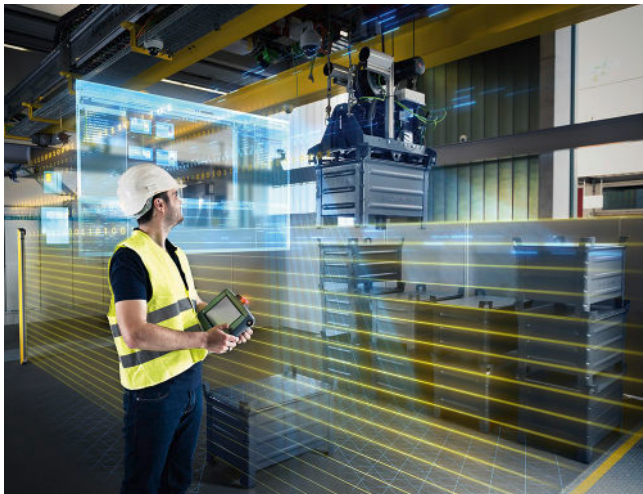

Legal framework

Machine manufacturers and manufacturing plants must ensure that their machines or plants cannot cause danger due to malfunctions in addition to the general risks of electric shock, heat or radiation.

In Europe, for example, compliance with the Machinery Directive 2006/42/EC is legally stipulated by the EU Directive on Safety and Health at Work. In order to ensure compliance with this directive, it is recommended that the corresponding harmonized European standards are applied. This triggers the "assumption of conformity" and gives manufacturers and operators the legal security in terms of compliance with both national regulations and EU directives. The machine manufacturer uses the CE marking to document the compliance with all relevant directives and regulations in the free movement of goods.

Safety-related standards

Functional safety is specified in various standards. For example, EN ISO 12100 specifies standards pertaining to machine safety (risk assessment and risk reduction). IEC 61508 specifies basic requirements for electronic and programmable safety-related systems. EN 62061 (only applicable for electrical and electronic control systems) and EN ISO 13849-1, which has replaced EN 954-1, define the functional and safety-related requirements of safety-oriented control systems.

The above-mentioned standards define different safety requirements that the machine has to satisfy in accordance with the risk, frequency of a dangerous situation, probability of occurrence and the opportunities for recognizing impending danger.

- EN ISO 13849-1: Performance Level PL a ... e; Category B, 1 ... 4
- EN 62061: Safety Integrity Level SIL 1 ... 3

Trend toward integrated safety systems

The trend toward greater complexity and higher modularity of machines has seen a shift in safety functions away from the classical central safety functions (for example, shutdown of the complete machine using a main disconnecting means) and into the machine control system and the drives. This is often accompanied by a significant increase in productivity because the equipping times are shortened. Depending on the type of machine, it may even be possible to continue manufacturing other parts while equipping is in progress.

Integrated safety functions act much faster than those of a conventional design. The safety of a machine is increased further with Safety Integrated. Furthermore, thanks to the faster method of operation, safety measures controlled by integrated safety systems are perceived as less of a hindrance by the machine operator, therefore significantly reducing the motivation to consciously bypass safety functions.

Function

The safety functions integrated in SIMATIC MICRO-DRIVE are described below.

Safety functions integrated in the SIMATIC MICRO-DRIVE drives (integrated in the failsafe variants, e.g. PDC100F)

The large number of safety functions integrated in the SIMATIC MICRO-DRIVE drive system in combination with the sensors and safety control required for the safety function contribute to the implementation of highly effective, practical personnel and machine protection.

They comply with the requirements of the following safety categories:

- PL d and Category 3 according to EN ISO 13849-1
- SIL 2 according to IEC 61508 and IEC 61800-5-2

The Safety Integrated functions are generally certified by independent institutes. You can obtain the corresponding test certificates and manufacturer's declarations from your Siemens contacts.

The integrated safety functions that are currently available are described below. Their functional safety satisfies the requirements defined in the international standard IEC 61800-5-2 for variable-speed drive systems.

The safety functions integrated into the SIMATIC MICRO-DRIVE drive system can be roughly divided into two categories:

- **Functions for safely stopping a drive**
 - Safe Torque Off (STO)
 - Safe Stop 1 (SS1)
- **Functions for safely monitoring the motion of a drive**
 - Safely-Limited Speed (SLS)
 - Safely-Limited Torque (SLT¹⁾)
 - Safe Speed Monitor (SSM)

¹⁾ Only for PDC100F.

Function
Safe Torque Off (STO)

The STO function is the most common and basic drive-integrated safety function. It ensures that no torque-generating energy can continue to affect a motor and prevents unintentional start-ups.

Effect

This function is a mechanism that prevents the drive from restarting unexpectedly, in accordance with EN 60204-1, Section 5.4. The STO function suppresses the drive pulses (corresponds to Stop Category 0 according to EN 60204-1). The drive is reliably torque-free. This state is monitored internally in the drive.

Application

STO has the immediate effect that the drive cannot supply any torque-generating energy. STO can be used wherever the drive will naturally reach a standstill due to load torque or friction in a sufficiently short time or when "coasting down" of the drive will not have any relevance for safety.

STO makes it possible for persons to work safely when the protective door is open (restart interlock) and is used on machines/installations with moving axes, e.g. on handling or conveyor systems.

Customer benefits

Some of the advantages of the Safety Integrated Function STO over conventional safety technology with electromechanical switchgear include the elimination of separate components as well as of the work that would be required to wire and service them, i.e. no wearing parts as a result of the electronic shutdown. Because of the fast electronic switching times, the function provides a shorter reaction time than the conventional solution comprising electromechanical components. When STO is triggered, the converter remains connected to the network and can be fully diagnosed.

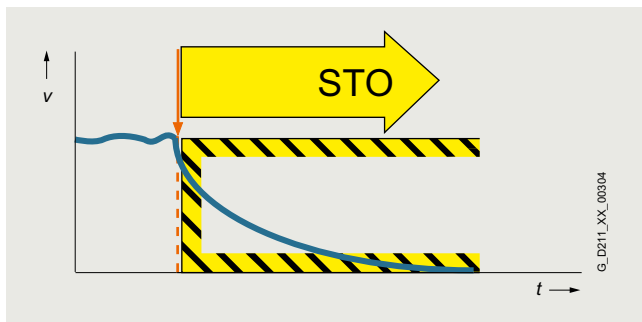
Safe Stop 1 (SS1)

The SS1 function causes a motor to stop rapidly and safely and switches the motor to torque-free mode after coming to a standstill by activating STO.

Effect

The SS1 function can safely stop the drive in accordance with EN 60204-1, Stop Category 1. When the SS1 function is selected, the drive brakes autonomously along a quick stop ramp and automatically activates the Safe Torque Off functions when the set safe delay time has expired.

Application

The SS1 function is used when, in the event of a safety-relevant incident, the drive must stop as quickly as possible with a subsequent transition into the STO state (e.g. EMERGENCY STOP). It is thus used to bring large centrifugal masses to a stop as quickly as possible for the safety of the operating personnel, or to brake motors at high speeds as quickly as possible. Examples of typical applications are saws, grinding machine spindles, centrifuges, winders and storage and retrieval machines.

Customer benefits

The targeted stopping of a drive by means of SS1 reduces the risk of danger, increases the productivity of a machine, and allows the safety clearances in a machine to be reduced. The principle is to bring the drive actively to a standstill, compared with just using the STO function. Complex mechanical brakes that are susceptible to wear are not normally required to brake the motor.

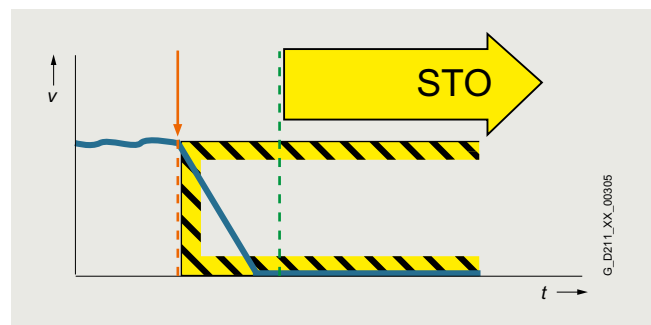

SIMATIC MICRO-DRIVE drive system

System overview

Safety Integrated

1

Function

Safely-Limited Speed (SLS)

The SLS function monitors the drive to ensure that it does not exceed a preset speed or velocity limit.

Effect

The SLS function monitors the drive against a parameterized speed limit. Four different limit values can be selected. The speed setpoint is not influenced independently. After SLS has been selected, the higher-level control must bring the drive down below the selected speed limit within a parameterizable time. If the speed limit is exceeded, a customizable drive-integrated fault reaction occurs.

The SLS limit stage 1 can be multiplied by a factor that is transferred in 16-bit resolution via PROFI-safe. This allows an almost unlimited number of limits to be specified.

Application

The SLS function is used if people are in the danger zone of a machine and their safety can only be guaranteed by reduced speed. Typical application cases include those in which an operator must enter the danger zone of the machine for the purposes of maintenance or setting up, such as a winder in which the material is manually threaded by the operator. To prevent injury to the operator, the roller may only spin at a safely reduced speed. SLS is often also used as part of a two-stage safety concept. While a person is in a less critical zone, the SLS function is activated, and the drives are only stopped in a smaller area with higher potential risk. SLS can be used not only for operator protection, but also for machinery protection, e.g. if a maximum speed must not be exceeded.

Customer benefits

The SLS function can contribute to a significant reduction in downtime, or greatly simplify or even accelerate setup. The overall effect achieved is a higher availability of the machine. Moreover, external components such as speed monitors can be omitted.

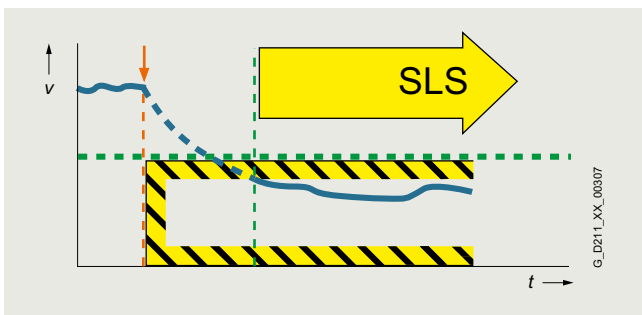

Safely-Limited Torque (SLT)

The SLT function monitors the current/torque of a motor.

Effect

The SLT function allows the torque to be reduced within a defined period of time. If the torque exceeds the SLT monitoring limit, the drive responds with a "Safe Stop". The stop responses STO or SS1 can be specified via parameters.

Application

In the simplest case, this function is used for force limiting when opening and closing a protective door on a machine.

Customer benefits

The SLT function avoids the use of external hardware for measuring and limiting the force and the associated wiring effort.

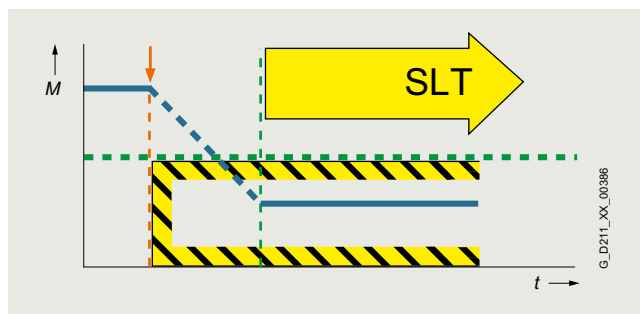

Function
Safe Speed Monitor (SSM)

The SSM function warns when a drive is working below an adjustable speed limit. As long as it remains below the threshold, the function issues a safety-related signal.

Effect

If a speed value drops below a parameterized limit, a safety-related signal is generated. This can, for example, be processed in a safety controller to respond to the event by programming, depending on the situation.

Application

With the SSM function, in the simplest case, a safety door can be unlocked if the speed drops below a non-critical level. Another typical example is that of a centrifuge that may be filled only when it is operating below a configured speed limit.

Customer benefits

Unlike SLS, there is no drive-integrated fault reaction when the speed limit is exceeded. The safe feedback can be evaluated in a safety control unit, allowing the user to respond appropriately to the situation.

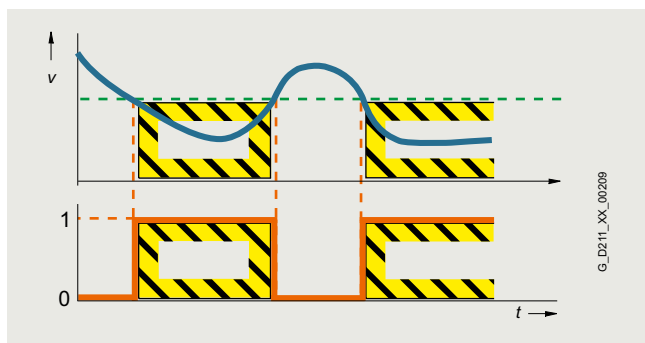
Activation of the Safety Integrated Functions

The STO safety function for SIMATIC MICRO-DRIVE can be activated via terminals, e.g. for use of a conventional safety circuit.

For standalone safety solutions for small to medium sized applications, it is frequently sufficient that the various sensing components are directly hardwired to the drive.

For integrated safety solutions, the safety-relevant sequences are generally processed and coordinated in the fail-safe SIMATIC controller. In this case, the system components communicate via the PROFINET fieldbus. The safety functions are controlled via the safe PROFIsafe communication protocol.

The SIMATIC MICRO-DRIVE drives can be easily integrated into the plant or system topology.

PROFIsafe (only for the failsafe variants, e.g. PDC100F)

SIMATIC MICRO-DRIVE drives support the PROFIsafe profile based on PROFINET.

PROFIsafe is an open communications standard that supports standard and safety-related communication over the same communication path (wired or wireless). A second, separate bus system is therefore not necessary. The telegrams that are sent are continually monitored to ensure safety-relevant communication.

Possible errors such as telegrams that have been lost, repeated or received in the incorrect sequence are avoided. This is done by consecutively numbering the telegrams in a safety-relevant fashion, monitoring their reception within a defined time and transferring an ID for transmitter and receiver of a telegram. A CRC (cyclic redundancy check) data security mechanism is also used.

The operating principle of Safety Integrated
Two independent switch-off signal paths

Two independent switch-off signal paths are available. All switch-off signal paths are low active. This ensures that the system is always switched to a safe state if a component fails or in the event of cable breakage. If a fault is discovered in the switch-off signal paths, the STO or SS1 function (depending on parameter settings) is activated and a system restart inhibited.

Two-channel monitoring structure

All the main hardware and software functions for Safety Integrated are implemented in two independent monitoring channels (e.g. switch-off signal paths, data management, data comparison). A cyclic crosswise comparison of the safety-relevant data in the two monitoring channels is carried out.

The monitoring functions in each monitoring channel work on the principle that a defined state must prevail before each action is carried out and a specific acknowledgement must be made after each action. If these expectations of a monitoring channel are not fulfilled, the drive coasts to a standstill (two channel) and an appropriate message is output.

Safe actual value sensing with encoder

The safe actual value sensing is based on the redundant evaluation of the differential incremental tracks A/B that supply HTL/TTL and the three Hall-effect sensors integrated in the motor.

All EC motors of the Siemens Product Partners with IQ encoder and Hall-effect sensors can be used for all of the safety functions of the SIMATIC MICRO-DRIVE drive system.

SIMATIC MICRO-DRIVE drive system

System overview

Communication

1

Overview

Communication overview

The properties and special application areas of the different bus systems for SIMATIC MICRO-DRIVE are described briefly below.

Protocol	SIMATIC MICRO-DRIVE PDC100, PDC600, PDC1000 V1	SIMATIC MICRO-DRIVE PDC100F, PDC600F	SIMATIC MICRO-DRIVE TM Drives
PROFINET	✓	✓	✓
- PROFINET RT	✓	✓	✓
- PROFINET IRT isochronous	✓	✓	–
- PROFINET Shared Device	✓	✓	–
- PROFINET media redundancy MRP (surge-prone)	✓	✓	–
- PROFI-safe	–	✓	–
- PROFIdrive application class 1	✓	✓	✓
- PROFIdrive application class 4	✓	✓	–

Communication > PROFINET

Overview



PROFINET – the Ethernet standard for automation

PROFINET is the world's leading Industrial Ethernet standard for automation with more than 40 million nodes installed worldwide.

PROFINET makes companies more successful, because it speeds up processes and raises both productivity and plant availability.

Your advantages at a glance

Flexibility

Tailor-made plant concepts

- ▶ Industrial Wireless LAN
- ▶ Safety
- ▶ Flexible topologies
- ▶ Open standard
- ▶ Web tools
- ▶ Expandability

Efficiency

Optimal use of resources

- ▶ One cable for everything
- ▶ Device/network diagnostics
- ▶ Energy efficiency
- ▶ Simple wiring
- ▶ Fast device replacement
- ▶ Ruggedness/stability

Performance

Increased productivity

- ▶ Speed
- ▶ High precision
- ▶ Large quantity structures
- ▶ High transmission rate
- ▶ Redundancy
- ▶ Fast start-up

G_IK10_XX_10304

Overview

Flexibility

Short response times and optimized processes are the basic requirements for competitiveness in global markets because the product lifecycles are becoming shorter and shorter.

PROFINET ensures maximum flexibility in plant structures and production processes, and it enables you to implement innovative machine and plant concepts. For example, mobile devices can also be integrated at locations that are difficult to access.

Flexible topologies

In addition to the linear structure characterized by the established fieldbuses, PROFINET also enables the use of star, tree and ring structures. This is made possible by switching technology via active network components, such as Industrial Ethernet switches and media converters, or by integrating switch functionality into the field devices. This results in increased flexibility in the planning of machines and plants, as well as savings in cabling.

The PROFINET network can be installed without any specialist knowledge at all and meets all requirements that are relevant to the industrial environment. The "PROFINET Installations Guidelines" assist manufacturers and users with network planning, installation and commissioning. Symmetrical copper cables or RFI-resistant fiber-optic cables are used, depending on the application. Devices from different manufacturers are easily connected via standardized and rugged plug-in connectors (up to IP65/IP67 degree of protection).

By integrating switch functionality into the devices, linear topologies can be created that are directly oriented toward an existing machine or plant structure. This reduces cabling overhead and cuts down on components such as external switches.

IWLAN

PROFINET also supports wireless communication with Industrial Wireless LAN, thus opening up new fields of application. For example, technologies subject to wear, such as trailing cables, can be replaced and automated guided vehicle systems and mobile operator panels can be used.

Safety

The PROFIsafe safety profile, which has been tried and tested with PROFIBUS and which permits the transmission of standard and safety-related data on a single bus cable, can also be used with PROFINET. No special network components are necessary for fail-safe communication, which means that standard switches and standard network transitions can continue to be used without any restrictions. In addition, fail-safe communication is equally possible via Industrial Wireless LAN (IWLAN).

Open standard

PROFINET, the open multi-vendor standard (IEC 61158/IEC 61784), is supported by PROFIBUS and PROFINET International (PI). It stands for maximum transparency, open IT communication, network security and simultaneous real-time communication.

Thanks to its openness, PROFINET provides the basis for a standardized automation network in the plant, to which all other machines and devices can be connected. Even the integration of existing plant components, for example using PROFIBUS, presents no problems due to the use of network transitions.

Use of web tools

Thanks to the unrestricted support of TCP/IP, PROFINET permits the use of standard web services such as web servers. Irrespective of the tool used, information from the automation level can be accessed from virtually any location using a commercially available internet browser. This considerably simplifies commissioning and diagnostics. Users can then decide for themselves how much openness to the IT world they want to allow for their machine or plant. This means that PROFINET can be used simply as an isolated plant network or connected via appropriate security modules, such as the SCALANCE S modules, to the office network or the internet. In this way, new remote maintenance concepts or the high-speed exchange of production data become possible.

Expandability

On the one hand, PROFINET facilitates the integration of existing systems and networks without any great effort. In this way, PROFINET safeguards investments in existing plant components that communicate via PROFIBUS and other fieldbuses such as AS-Interface. On the other hand, additional PROFINET nodes can be added at any time. By using additional network components, network infrastructures can be expanded using cabling or wireless methods – even while the plant is operating.

Efficiency

Greater global competition means that companies must use their resources economically and efficiently. This applies in particular to production. This is where PROFINET ensures greater efficiency. Simple engineering guarantees fast commissioning, while reliable devices ensure a high level of plant availability. Comprehensive diagnostic and maintenance concepts help to reduce plant downtimes and keep maintenance costs to a minimum.

One cable for everything

PROFINET permits simultaneous fieldbus communication with isochronous mode and standard IT communication (TCP/IP) on one cable. This real-time communication for the transmission of user/process data and diagnostic data takes place on a single cable. Specific profile communication (PROFIsafe and PROFIdrive) can be integrated without any additional cabling. This solution offers a wide scope of functions at a low level of complexity.

Device and network diagnostics

By retaining the tried and tested PROFIBUS device model, the same diagnostics information is available with PROFINET. In addition, module-specific and channel-specific data can also be read out from the devices during device diagnosis, enabling faults to be located quickly and easily. Apart from the availability of device information, the reliability of network operation has top priority in the network management.

In existing networks the Simple Network Management Protocol (SNMP) has established itself as the de facto standard for the maintenance and monitoring of the network components and their functions. PROFINET uses this standard and gives users the opportunity to maintain their networks with tools that are familiar to them, such as the SINEMA Server network management software.

For easier maintenance of PROFINET devices, both on-site and remotely via a secure VPN connection, application-specific websites can be set up on the web server of the field devices using the familiar HTML standard.

SIMATIC MICRO-DRIVE drive system

System overview

Communication > PROFINET

1

Overview

Simple wiring

Particularly stringent demands are made on the installation of cables in the industrial environment. In addition, there is a requirement to set up industry-standard networks in the shortest possible time without any special knowledge.

With FastConnect, Siemens offers a high-speed installation system that meets all of these requirements. FastConnect is the standard-compliant, industry-standard cabling system consisting of cables, connectors and assembly tools for PROFINET networks. The time required for connecting terminals is minimized by the simple installation method using just a single tool, while installation errors are prevented by the practical color-coding. Both copper cables and glass fiber optic cables can be easily assembled on site in this way.

Fast device replacement

PROFINET devices are identified by means of a name assigned during configuration. When replacing a defective device, a new device can be recognized from its topology information by the IO controller and a new name can be assigned to it automatically. This means that no engineering tool is necessary for the replacement of equipment.

This mechanism can even be used for the initial commissioning of a complete system. This speeds up commissioning, particularly in the case of series machines.

Ruggedness

An automation network must be able to withstand most external sources of interference. The use of Switched Ethernet prevents faults in one section of the network from affecting the entire plant network. For areas that are particularly prone to radio frequency interference (RFI), PROFINET allows the use of fiber optic cables.

Performance

Productivity and product quality determine the level of success in the market. Precise motion control, dynamic drives, high-speed controllers and the deterministic synchronization of devices are therefore key factors in achieving superior production. They facilitate high production rates and optimum product quality at the same time.

Speed and precision

Fast motion control applications demand precise and deterministic exchange of data. This is implemented by means of drive controllers using isochronous real time (IRT).

With IRT and isochronous mode, PROFINET permits fast and deterministic communication. This synchronizes the various cycles of a system (input, network, CPU processing and output), even in the case of parallel TCP/IP traffic. The short cycle times of PROFINET make it possible to raise the productivity of machines and plants and to guarantee the product quality and high level of precision.

The standardized PROFIdrive profile permits vendor-independent communication between CPUs and drives.

Large quantity structures

The use of PROFINET makes it possible to overcome the existing restrictions regarding the scope of machines and systems that can be implemented. In one network, several different controllers can interact with their assigned field devices. The number of field devices per PROFINET network is virtually unlimited – the entire range of IP addresses is available.

High data rate

By using 100 Mbit/s in full duplex mode, PROFINET achieves a significantly higher data rate than previous fieldbuses. This means that other plant data can be transmitted over TCP/IP without any problems, in addition to the process data. PROFINET therefore meets the combined industrial demands for simultaneously transmitting high-speed IO data and large volumes of data for additional sections of the application. Even the transmission of large volumes of data, such as that from cameras, has no adverse effect on the speed and precision of the IO data transmission, thanks to PROFINET mechanisms.

Media redundancy

A higher plant availability can be achieved with a redundant installation (ring topology). The media redundancy can be implemented not only with the aid of external switches, but also by means of integrated PROFINET interfaces. Using the media redundancy protocol (MRP), reconfiguration times of 200 ms can be achieved. If the communication is interrupted in just one part of the ring installation this means that a plant standstill is prevented and any necessary maintenance or repair work can be performed without any time pressure.

For motion control applications, PROFINET with IRT in ring topologies offers extended media redundancy for planned duplication (MRPD) which operates in a bumpless mode without any reconfiguration time. If communication is interrupted (e.g. a cable break) the process can continue operating without interruption.

Benefits

- PROFINET is the open Industrial Ethernet standard for automation
- PROFINET is based on Industrial Ethernet
- PROFINET uses TCP/IP and IT standards
- PROFINET is real-time Ethernet
- PROFINET enables seamless integration of fieldbus systems
- PROFINET supports fail-safe communication via PROFIsafe and also via IWLAN

Overview



PROFIdrive – the standardized drive interface for PROFINET and PROFIBUS

PROFIdrive defines the device behavior and technique to access internal device data for electric drives connected to PROFINET and PROFIBUS – from basic frequency converters up to high-performance servo controllers.

It describes in detail the practical use of communication functions – device-to-device communication, equidistance and clock cycle synchronization (isochronous mode) in drive applications. In addition, it specifies all device characteristics which influence interfaces connected to a controller over PROFINET or PROFIBUS. This also includes the state machine (sequence control), the encoder interface, scaling of values, definition of standard telegrams, access to drive parameters etc.

The PROFIdrive profile supports both central as well as distributed motion control concepts.

What are profiles?

For devices and systems used in automation technology, profiles define properties and modes of behavior. This allows manufacturers and users to define common standards. Devices and systems that comply with such a cross-manufacturer profile, are interoperable on a fieldbus and, to a certain degree, can be interchanged.

Are there different types of profiles?

A distinction is made between what are known as application profiles (general or specific) and system profiles:

- Application profiles (also device profiles) predominantly refer to devices (e.g. drives) and include an agreed selection regarding bus communication as well as specific device applications.
- System profiles describe classes of systems, including master functionality, program interfaces and integration resources.

Is PROFIdrive fit for the future?

PROFIdrive has been specified by the PROFIBUS and PROFINET International (PI) user organization, and is specified as a standard that is fit for the future through standard IEC 61800-7.

The basic philosophy: Keep it simple

The PROFIdrive profile tries to keep the drive interface as simple as possible and free from technology functions. As a result, referencing models as well as the functionality and performance of the PROFINET/PROFIBUS master have either no or only little influence on the drive interface.

One drive profile – different application classes

The integration of drives into automation solutions depends very strongly on the particular drive application. In order to be able to address the complete, huge bandwidth of drive applications – from basic frequency converters up to synchronized multi-axis systems with a high dynamic performance – using just one profile, PROFIdrive defines six application classes, to which most drive applications can be assigned:

- Class 1 – standard drives (pumps, fans, agitators, etc.)
- Class 2 – standard drives with technological functions
- Class 3 – positioning drives
- Class 4 – motion control drives with central, higher-level motion control intelligence and the patented "Dynamic Servo Control" positioning concept
- Class 5 – motion control drives with central, higher-level motion control intelligence and position setpoint interface
- Class 6 – motion control drives with distributed motion control intelligence integrated in the drives

Design

The device model of PROFIdrive

PROFIdrive defines a device model comprising function modules, which interoperate inside the device and which reflect the intelligence of the drive system. These modules have objects assigned to them which are described in the profile and are defined with respect to their functions. The overall functionality of a drive is therefore described through the sum of its parameters.

In contrast to other drive profiles, PROFIdrive defines only the access mechanisms to the parameters as well as a subset of profile parameters (approx. 30) such as the fault buffer, drive control and device identification.

All other parameters are vendor-specific which gives drive manufacturers great flexibility with respect to implementing control functions. The elements of a parameter are accessed acyclically over data records.

As a communication protocol, PROFIdrive uses DP-V0, DP-V1, and the DP-V2 expansions for PROFIBUS including the functions "Device-to-Device Communication" and "Isochronous Operation", or PROFINET IO with real-time classes RT and IRT.

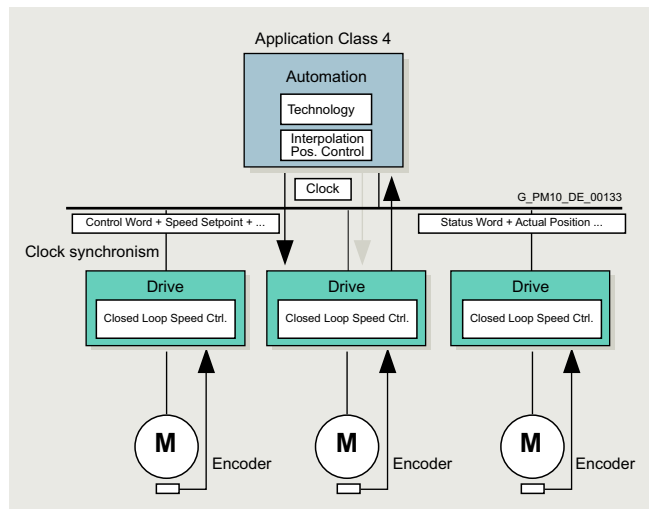

SIMATIC MICRO-DRIVE drive system

Notes

1



2/2	PDC Drives
2/8	TM Drives
2/8	F-TM ServoDrive HF
2/11	F-TM ServoDrive ST
2/14	F-TM StepDrive ST
2/17	Motors/gear units and connection systems from Siemens Product Partners
2/19	ebm-papst motors/gear units
2/27	Dunkermotoren motors/gear units
2/30	KnorrTec connection systems
2/34	Harting connection systems
2/37	Selection and engineering tools
2/38	Services and documentation
2/38	SITRAIN – Digital Industry Academy
2/40	SIMATIC MICRO-DRIVE training case
2/40	SIMATIC F-TM ServoDrive ST Starter Kit
2/40	SIMATIC MICRO-DRIVE documentation

SIMATIC MICRO-DRIVE drive system

PDC Drives

Overview



PDC Drives, PDC100F variant

- SIMATIC MICRO-DRIVE PDC Drives (ProfiDriveControl)
- Available in the variants: Standard (PDCxxx), Failsafe (PDCxxxF)

Variant	Power	Device width
Standard		
PDC100	100 W	50 mm
PDC600	600 W	90 mm
PDC1000 V1	1000 W	90 mm
Failsafe		
PDC100F	100 W	50 mm
PDC600F	600 W	90 mm

Function

Basic functions (for standard PDC for all PDC Drives)

- PROFIdrive profile via PROFINET
- Hardware STO
- Digital inputs and outputs
- PDC100 and PDC100F with integrated braking chopper
- PROFINET line-capable (2 × PROFINET ports)
- PROFINET Shared Device
- TTL/HTL Hall signals

In addition to standard PDC for PDCxxxF variants

- Extended Safety drive functions STO, SS1, SLT ¹⁾, SLS ²⁾ and SSM ²⁾ via PROFIsafe

Selection and ordering data

SIMATIC MICRO-DRIVE PDC Drives (ProfiDriveControl)

Variant	Article No.
Standard	
• PDC100 Power 100 W	6BK1630-1AA10-0AA0
• PDC600; Power 600 W	6BK1630-1AA60-0AA0
• PDC1000 V1; Power 1000 W	6BK1630-1BA00-0AA0
Failsafe with Extended Safety drive functions	
• PDC100F; Power 100 W	6BK1630-2AA10-0AA0
• PDC600F; Power 600 W	6BK1630-2AA60-0AA0

¹⁾ Only for PDC100F.

²⁾ Extended requirements for the motor and encoder system must be observed. The certified Motor Product Partners comply with these requirements.

Technical specifications

Article number	6BK1630-1AA10-0AA0 SIMATIC MICRO-DRIVE PDC100	6BK1630-2AA10-0AA0 SIMATIC MICRO-DRIVE PDC100F
General information		
Product type designation	DC and EC motor controller	DC and EC motor controller
Product description	Control of DC and EC motors	Control of DC and EC motors
Mean time between failures (MTBF)	100 000 h	100 000 h
Product function		
• Isochronous mode	Yes	Yes
• Four-quadrant operation	Yes	Yes
• Speed control with encoder	Yes	Yes
• Speed control without encoder	No	No
• Safety Functions	Yes; STO	Yes; STO, SS1, SLT, SLS, SSM
Protection function		
• Undervoltage protection	Yes	Yes
• Overvoltage protection	Yes	Yes
• Overload protection	Yes	Yes
• Ground-fault protection	Yes	Yes
• Short-circuit protection	Yes	Yes
Engineering with		
• STEP 7 TIA Portal configurable/ integrated from version	V14 SP1	V14 SP1
Installation type/mounting		
Mounting type	35 mm rail, screw mounting	35 mm rail, screw mounting
Type of ventilation	Convection cooling	Convection cooling
Supply voltage		
Design of the power supply	DC	DC
Rated value (DC)	24 V	24 V
Supply voltage of the motor		
• Type of motor voltage	24 ... 48 V DC, SELV / PELV	24 ... 48 V DC, SELV / PELV
• permissible range, lower limit (DC)	19.2 V	19.2 V
• supply voltage / of the motor / at DC / rated value / maximum	50.4 V	50.4 V
Output current		
Current output (rated value)	1.56 A	1.56 A
Output current, max.	2.3 A	2.3 A
Digital inputs		
Number of digital inputs	4	4
Number of safety inputs	1; For STO, antivalent (2-pin) - 24 V DC	1; For STO, antivalent (2-pin) - 24 V DC
Input characteristic according to IEC 61131	Permissible DC leakage current (0 signal) to 2 mA	Permissible DC leakage current (0 signal) to 2 mA
Digital outputs		
Type of digital output	Source output (PNP, current-sourcing)	Source output (PNP, current-sourcing)
Number of digital outputs	2	2
Number of safety outputs	0	0
Encoder		
Connectable encoders		
• Incremental encoder (symmetrical)	Yes; Up to 200 kHz	Yes; Up to 200 kHz
• Incremental encoder (asymmetrical)	Yes	Yes
• Absolute encoder (SSI)	Yes; 350 kHz	Yes; 350 kHz
Interfaces		
Number of industrial Ethernet interfaces	0	0
Number of PROFINET interfaces	2	2

SIMATIC MICRO-DRIVE drive system

PDC Drives

Technical specifications

Article number	6BK1630-1AA10-0AA0 SIMATIC MICRO-DRIVE PDC100	6BK1630-2AA10-0AA0 SIMATIC MICRO-DRIVE PDC100F
Degree and class of protection		
IP degree of protection	IP20	IP20
Standards, approvals, certificates		
CE mark	Yes	Yes
CSA approval	No	No
cULus	Yes	Yes
RCM (formerly C-TICK)	Yes	Yes
KC approval	Yes	Yes
EAC (formerly Gost-R)	Yes	Yes
China RoHS compliance	Yes	Yes
reference designation according to IEC 81346-2 (2009)	T	T
Highest safety class achievable in safety mode		
• Performance level according to ISO 13849-1	d	d
• SIL acc. to IEC 61508	SIL 2	SIL 2
Ambient conditions		
Ambient temperature during operation		
• min.	-20 °C	-20 °C
• max.	60 °C	60 °C
• horizontal installation, max.	40 °C	40 °C
Ambient temperature during storage/transportation		
• Storage, min.	-20 °C	-20 °C
• Storage, max.	80 °C	80 °C
Relative humidity		
• Operation, max.	95 %; no condensation	95 %; no condensation
• Storage, max.	95 %; no condensation	95 %; no condensation
Vibrations		
• Vibration resistance during operation acc. to IEC 60068-2-6	5 ... 8.5 Hz / 3.5 mm, 8.5 ... 150 Hz / 1 g; for wall mounting: 9 ... 29 Hz / 1.5 mm, 29 ... 200 Hz / 5 g	5 ... 8.5 Hz / 3.5 mm, 8.5 ... 150 Hz / 1 g; for wall mounting: 9 ... 29 Hz / 1.5 mm, 29 ... 200 Hz / 5 g
• Vibration resistance during storage acc. to IEC 60068-2-6	5 ... 9 Hz / 3.5 mm, 9 ... 500 Hz / 1 g	5 ... 9 Hz / 3.5 mm, 9 ... 500 Hz / 1 g
Shock testing		
• Shock resistance during operation acc. to IEC 60068-2-27	15 g / 11 ms; for wall mounting: 10 g / 30 ms, 25 g / 6 ms	15 g / 11 ms; for wall mounting: 10 g / 30 ms, 25 g / 6 ms
Cables		
Cable length for motor, shielded, max.	10 m	10 m
Dimensions		
Width	50 mm	50 mm
Height	125 mm; 136 mm with protective collar for PN connector	125 mm; 136 mm with protective collar for PN connector
Depth	120 mm	120 mm
Weights		
Weight, approx.	350 g	350 g
Other		
Brake design	Holding brake	Holding brake
Braking chopper	Yes; Onboard, expandable	Yes; Onboard, expandable
Note:	Maximum 30 J per braking process, maximum 30 J per minute	Maximum 30 J per braking process, maximum 30 J per minute

Technical specifications

Article number	6BK1630-1AA60-0AA0 SIMATIC MICRO-DRIVE PDC600	6BK1630-2AA60-0AA0 SIMATIC MICRO-DRIVE PDC600F
General information		
Product type designation	EC motor controller	EC motor controller
Product description	Control of EC motors	Control of EC motors
Mean time between failures (MTBF)	100 000 h	100 000 h
Product function		
• Isochronous mode	Yes	Yes
• Four-quadrant operation	Yes	Yes
• Speed control with encoder	Yes	Yes
• Speed control without encoder	No	No
• Safety Functions	Yes; STO	Yes; STO, SS1, SLS, SSM
Protection function		
• Undervoltage protection	Yes	Yes
• Overvoltage protection	Yes	Yes
• Overload protection	Yes	Yes
• Ground-fault protection	Yes	Yes
• Short-circuit protection	Yes	Yes
Engineering with		
• STEP 7 TIA Portal configurable/ integrated from version	V14 SP1	V14 SP1
Installation type/mounting		
Mounting type	35 mm rail, screw mounting	35 mm rail, screw mounting
Type of ventilation	Convection cooling	Convection cooling
Supply voltage		
Design of the power supply	DC	DC
Rated value (DC)	24 V	24 V
Supply voltage of the motor		
• Type of motor voltage	24 ... 48 V DC, SELV / PELV	24 ... 48 V DC, SELV / PELV
• permissible range, lower limit (DC)	16.8 V	16.8 V
• supply voltage / of the motor / at DC / rated value / maximum	52.8 V	52.8 V
Output current		
Current output (rated value)	11 A	11 A
Output current, max.	22 A	22 A
Output frequency	500 Hz	500 Hz
Digital inputs		
Number of digital inputs	4	4
Number of safety inputs	1; For STO, antivalent (2-pin) - 24 V DC	1; For STO, antivalent (2-pin) - 24 V DC
Digital outputs		
Type of digital output	Source output (PNP, current-sourcing)	Source output (PNP, current-sourcing)
Number of digital outputs	2	2
Number of safety outputs	0	0
Encoder		
Connectable encoders		
• Incremental encoder (symmetrical)	Yes; Up to 200 kHz	Yes; Up to 200 kHz
• Incremental encoder (asymmetrical)	Yes	Yes
• Absolute encoder (SSI)	Yes; 350 kHz	Yes; 350 kHz
Interfaces		
Number of industrial Ethernet interfaces	0	0
Number of PROFINET interfaces	2	2

SIMATIC MICRO-DRIVE drive system

PDC Drives

Technical specifications

Article number	6BK1630-1AA60-0AA0	6BK1630-2AA60-0AA0
	SIMATIC MICRO-DRIVE PDC600	SIMATIC MICRO-DRIVE PDC600F
Degree and class of protection		
IP degree of protection	IP20	IP20
Standards, approvals, certificates		
CE mark	Yes	Yes
CSA approval	No	No
cULus	Yes	Yes
RCM (formerly C-TICK)	Yes	Yes
KC approval	Yes	Yes
EAC (formerly Gost-R)	Yes	Yes
China RoHS compliance	Yes	Yes
Highest safety class achievable in safety mode		
• Performance level according to ISO 13849-1	d	d
• SIL acc. to IEC 61508	SIL 2	SIL 2
Ambient conditions		
Ambient temperature during operation		
• min.	-20 °C	-20 °C
• max.	60 °C	60 °C
Ambient temperature during storage/transportation		
• Storage, min.	-20 °C	-20 °C
• Storage, max.	80 °C	80 °C
Relative humidity		
• Operation, max.	95 %; no condensation	95 %
• Storage, max.	95 %; no condensation	95 %
Vibrations		
• Vibration resistance during operation acc. to IEC 60068-2-6	5 ... 8.5 Hz / 3.5 mm, 8.5 ... 150 Hz / 1 g; for wall mounting: 9 ... 29 Hz / 1.5 mm, 29 ... 200 Hz / 5 g	5 ... 8.5 Hz / 3.5 mm, 8.5 ... 150 Hz / 1 g; for wall mounting: 9 ... 29 Hz / 1.5 mm, 29 ... 200 Hz / 5 g
• Vibration resistance during storage acc. to IEC 60068-2-6	5 ... 8.5 Hz / 3.5 mm, 8.5 ... 500 Hz / 1 g	5 ... 8.5 Hz / 3.5 mm, 8.5 ... 500 Hz / 1 g
Shock testing		
• Shock resistance during operation acc. to IEC 60068-2-27	15 g / 11 ms; for wall mounting: 5 g / 30 ms, 15 g / 11 ms	15 g / 11 ms; for wall mounting: 5 g / 30 ms, 15 g / 11 ms
Cables		
Cable length for motor, shielded, max.	10 m	10 m
Dimensions		
Width	90 mm	90 mm
Height	125 mm; 136 mm with protective collar for PN connector	125 mm; 136 mm with protective collar for PN connector
Depth	120 mm	120 mm
Weights		
Weight, approx.	0.65 kg	0.65 kg
Other		
Braking chopper	Yes; External resistance	Yes; External resistance

Technical specifications

Article number	6BK1630-1BA00-0AA0 SIMATIC MICRO-DRIVE PDC1000-V1
General information	
Product type designation	EC motor controller
Product description	Control of EC motors
Mean time between failures (MTBF)	100 000 h
Product function	
• Isochronous mode	Yes
• Four-quadrant operation	Yes
• Speed control with encoder	Yes
• Speed control without encoder	No
• Safety Functions	No
Protection function	
• Undervoltage protection	Yes
• Overvoltage protection	Yes
• Overload protection	Yes
• Short-circuit protection	Yes
Engineering with	
• STEP 7 TIA Portal configurable/ integrated from version	V15 SP1
Installation type/mounting	
Mounting type	35 millimeter rail and mounting plate screw connection
Type of ventilation	Convection cooling
Supply voltage	
Design of the power supply	DC
Rated value (DC)	24 V
Supply voltage of the motor	
• Type of motor voltage	24 ... 48 V DC, SELV / PELV
• permissible range, lower limit (DC)	16.8 V
• supply voltage / of the motor / at DC / rated value / maximum	52.8 V
Output current	
Current output (rated value)	17.3 A
Output current, max.	34.6 A
Output frequency	500 Hz
Digital inputs	
Number of digital inputs	5
Number of safety inputs	0
Digital outputs	
Number of digital outputs	2; 24 V DC, 1 A
Number of safety outputs	0
Encoder	
Connectable encoders	
• Incremental encoder (symmetrical)	Yes; Up to 200 kHz
• Absolute encoder (SSI)	Yes; With SSI interface
Interfaces	
Number of industrial Ethernet interfaces	0
Number of PROFINET interfaces	2
Degree and class of protection	
IP degree of protection	IP20
Standards, approvals, certifi- cates	
CE mark	Yes
CSA approval	No
UL approval	No

Article number	6BK1630-1BA00-0AA0 SIMATIC MICRO-DRIVE PDC1000-V1
cULus	No
FM approval	No
RCM (formerly C-TICK)	No
KC approval	No
EAC (formerly Gost-R)	Yes
China RoHS compliance	No
reference designation according to IEC 81346-2 (2009)	T
Ambient conditions	
Ambient temperature during operation	
• min.	-20 °C
• max.	60 °C
Ambient temperature during storage/transportation	
• Storage, min.	-20 °C
• Storage, max.	80 °C
Relative humidity	
• Operation, max.	90 %; no condensation
• Storage, max.	95 %; no condensation
Vibrations	
• Vibration resistance during operation acc. to IEC 60068-2-6	5 ... 8.5 Hz / 3.5 mm, 8.5 ... 150 Hz / 1 g; for wall mounting: 9 ... 29 Hz / 1.5 mm, 29 ... 200 Hz / 5 g
• Vibration resistance during storage acc. to IEC 60068-2-6	5 ... 9 Hz / 3.5 mm, 9 ... 500 Hz / 1 g
Shock testing	
• Shock resistance during operation acc. to IEC 60068-2-27	15 g / 11 ms; for wall mounting: 10 g / 30 ms, 25 g / 6 ms
Cables	
Cable length for motor, shielded, max.	10 m
Connection method	
Type of connection	Plug-in terminal
Dimensions	
Width	90 mm
Height	125 mm; 136 mm with protective col- lar for PN connector
Depth	120 mm
Weights	
Weight, approx.	0.65 kg
Other	
Brake design	Holding brake
Braking chopper	Yes; External resistance

Accessories

Shielding bracket set

For good EMC shielding on the PDC Drives

- For supporting the plug-in cable/cable shields
- Available in widths of 50 mm, 70 mm und 90 mm

Description	Article No.
Shielding bracket set	
For supporting the plug-in cable/cable shields	
• Width 50 mm	6BK1638-0XA50-0AA0
• Width 70 mm	6BK1638-0XA70-0AA0
• Width 90 mm	6BK1638-0XA80-0AA0

SIMATIC MICRO-DRIVE drive system

TM Drives

F-TM ServoDrive HF

Overview



SIMATIC MICRO-DRIVE F-TM ServoDrive HF with Base Unit

In combination with EC Motors and stepper motors up to 280 W the ET 200SP technology module F-TM ServoDrive HF allows positioning and speed control in very confined spaces. The triple overload capability and the support of BiSS-C multi-turn encoders extend the scope of applications of the TM Drive product family.

Engineering in the TIA Portal stands for consistency in a single tool. This facilitates drive dimensioning, commissioning and servicing.

The new drive system consists of:

- The F-TM ServoDrive HF,
- The BaseUnit (U0),
- Motors with gearbox for flexible use and
- Connecting cables.

Further information on the distributed I/O system SIMATIC ET 200SP is available in the ST 70 Catalog and on the internet at www.siemens.com/et200sp

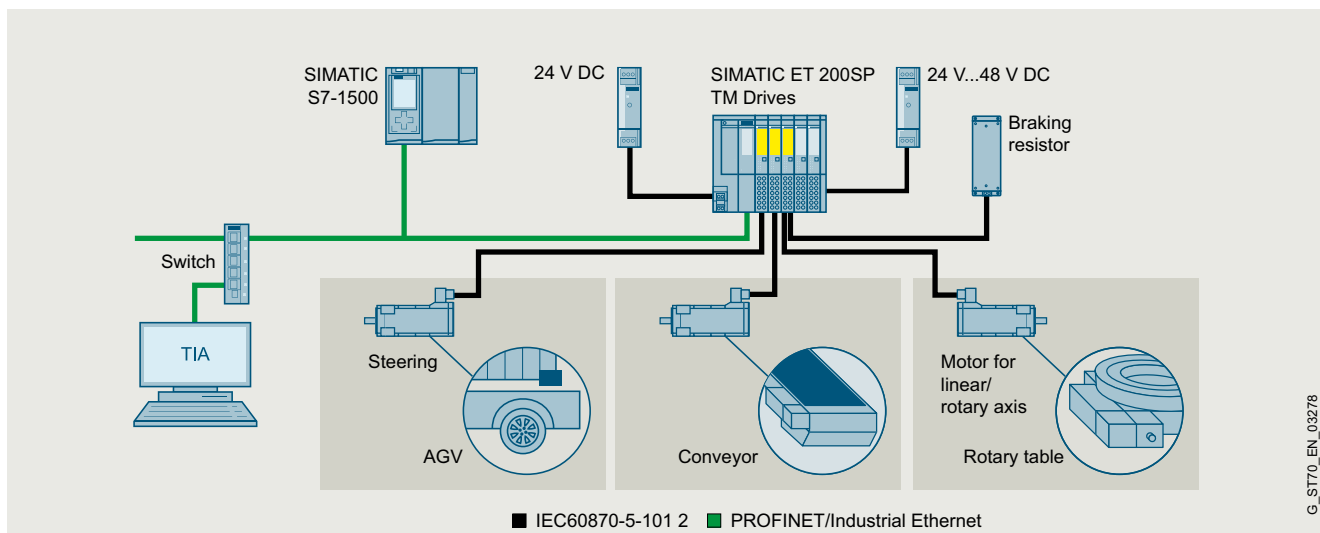

Application example TM Drives

Characteristics

- PROFIdrive profile via PROFINET
- Hardware-STO (SIL 3)
- Triple overload
- Digital input
- Integrated braking chopper
- Encoder connection for
 - IQ encoders
 - Incremental encoders
 - BiSS-C encoders
 - Hall encoder

Variant	Power	Peak power	Device width
High Feature	280 W	840 W	20 mm

More information:
www.siemens.com/micro-drive

Selection and ordering data

F-TM ServoDrive HF for SIMATIC MICRO-DRIVE	
Variant	Article No.
• High Feature V1; 24 ... 48 V, 5 A with hardware STO and integrated braking chopper	6BK1136-6AB01-0CU0

G_ST70_EN_03278

Technical specifications

Article number	6BK1136-6AB01-0CU0 F-TM ServoDrive HF
General information	
Product type designation	F-TM ServoDrive HF
Product description	control of EC and stepper motors
Product function	
• I&M data	Yes
• Isochronous mode	No
• Four-quadrant operation	Yes
• Speed control with encoder	Yes
• Speed control without encoder	No
• Safety Functions	Yes; Drive controller with hardwired STO
Protection function	
• Undervoltage protection	Yes
• Overvoltage protection	Yes
• Overload protection	Yes
• Ground-fault protection	No
• Short-circuit protection	Yes
Installation type/mounting	
Type of ventilation	Convection cooling
Supply voltage	
Design of the power supply	24 ... 48 V DC, SELV / PELV
Output voltage	
Rated value, min.	24 V
Rated value, max.	48 V
Output current	
Current output (rated value)	5 A
Output current, max.	15 A
Output frequency	599 Hz
Encoder supply	
Number of outputs	1
5 V encoder supply	
• 5 V	Yes
• Short-circuit protection	Yes
• Output current, max.	150 mA
Digital inputs	
Number of digital inputs	1; input for message signal
Number of safety inputs	1; For STO, antivalent (2-pin) - 24 V DC
Encoder	
Connectable encoders	
• Incremental encoder (symmetrical)	Yes; up to 500 Hz per channel
• Absolute encoder (SSI)	Yes; BiSS-C
• Hall encoder	Yes
• BiSS-C encoder	Yes
Interrupts/diagnostics/status information	
Alarms	
• Diagnostic alarm	Yes
• Hardware interrupt	No
Diagnoses	
• Monitoring the supply voltage	Yes
• Wire-break	Yes
• Short-circuit	Yes
• Telegram error at SSI encoder	Yes; BiSS-C
• Group error	Yes

Article number	6BK1136-6AB01-0CU0 F-TM ServoDrive HF
Diagnostics indication LED	
• RUN LED	Yes
• ERROR LED	Yes
Integrated Functions	
Position detection	
• Incremental acquisition	Yes
• Absolute acquisition	Yes
• Suitable for S7-1500 Motion Control	Yes
Potential separation	
Potential separation channels	
• between the channels and back-plane bus	Yes
Degree and class of protection	
IP degree of protection	IP20
Standards, approvals, certificates	
CE mark	Yes
UKCA mark	Yes
cULus	Yes
RCM (formerly C-TICK)	Yes
KC approval	Yes
EAC (formerly Gost-R)	Yes
RoHS conformity	Yes
China RoHS compliance	Yes
Standard for EMC according to EN 61800-3	Yes
Standard for drive acc. to EN 61800-5-1	Yes
Standard for drive acc. to EN 61800-5-2	Yes
Highest safety class achievable in safety mode	
• Performance level according to ISO 13849-1	Category 3, performance level d, according to EN ISO 13849-1:2015
• SIL acc. to IEC 61508	3
• SIL acc. to DIN EN 61800-5-2	3
Ambient conditions	
Pollution degree during storage and transport	2
Ambient temperature during operation	
• horizontal installation, min.	-30 °C; No condensation, splash water, icing, salt spray or oil mist permitted.
• horizontal installation, max.	60 °C; No condensation, splash water, icing, salt spray or oil mist permitted. Note the derating data!
• vertical installation, min.	-30 °C; No condensation, splash water, icing, salt spray or oil mist permitted.
• vertical installation, max.	50 °C; No condensation, splash water, icing, salt spray or oil mist permitted. Note the derating data!
Ambient temperature during storage/transportation	
• Storage, min.	-30 °C
• Storage, max.	70 °C
Altitude during operation relating to sea level	
• Installation altitude above sea level, max.	3 000 m

SIMATIC MICRO-DRIVE drive system

TM Drives

F-TM ServoDrive HF**Technical specifications**

Article number	6BK1136-6AB01-0CU0 F-TM ServoDrive HF
Cables	
Cable length for motor, shielded, max.	10 m
Dimensions	
Width	20 mm
Height	73 mm
Depth	58 mm
Weights	
Weight, approx.	55 g
Other	
Brake design	holding brake control via the process image
Braking chopper	Yes

Accessories

Description	Article No.
ET 200SP BaseUnit type U0	6ES7193-6BP00-0DU0 6ES7193-6BP00-0BU0
<ul style="list-style-type: none"> For constructing a new potential group (white) For continuing an existing potential group (gray) 	
Shield connection for ET 200SP Includes 5 shield connections	6ES7193-6SC20-1AM0

2

Overview



SIMATIC MICRO-DRIVE FM-ServoDrive ST

In combination with EC motors, the ET 200SP technology module F-TM ServoDrive ST allows positioning and speed control of EC motors up to 280 W in very confined spaces.

Engineering in the TIA Portal stands for consistency in a single tool. This facilitates drive dimensioning, commissioning and servicing.

The new drive system consists of

- The F-TM ServoDrive ST
- The BaseUnit (U0)
- Motors with gearbox for flexible use and
- Connecting cables.

Further information on the distributed I/O system SIMATIC ET 200SP is available in the ST 70 Catalog and on the internet at www.siemens.com/et200sp

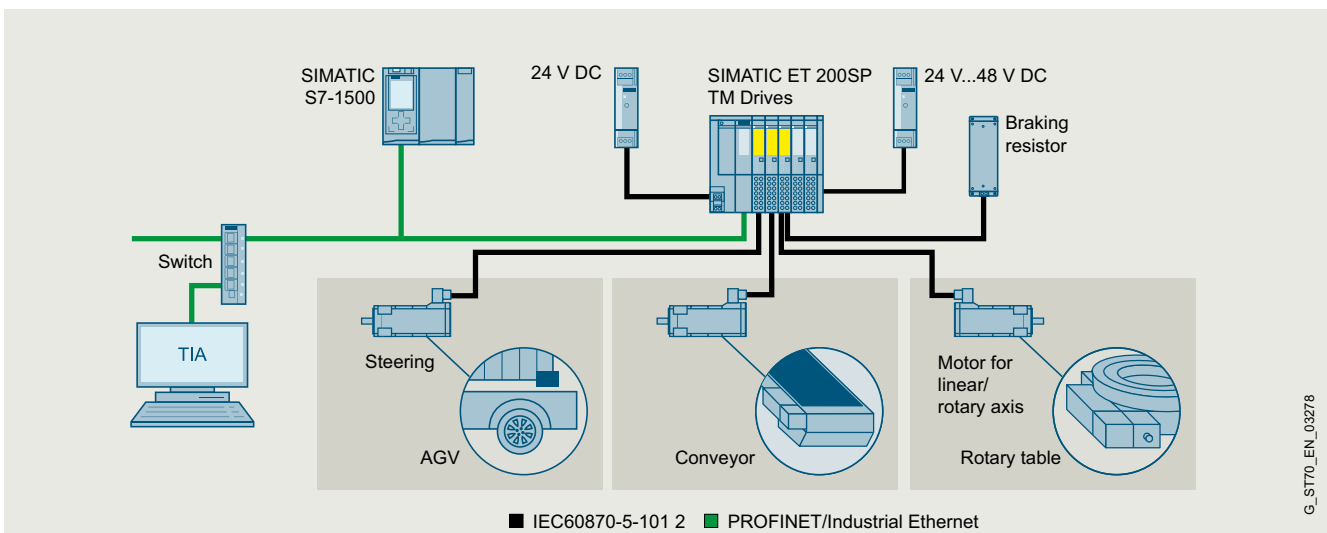

G_ST70_EN_03278

Application example TM Drives

Characteristics

- PROFIdrive profile via PROFINET
- Hardware STO (SIL 2)
- Double overload
- Digital input
- Integrated braking chopper
- Encoder connection for
 - IQ encoders
 - Incremental encoders
 - Hall encoder

Variant	Power	Device width
Standard	280 W	20 mm

More information:
www.siemens.com/micro-drive

Selection and ordering data

F-TM ServoDrive ST for SIMATIC MICRO-DRIVE

Variant	Article No.
<ul style="list-style-type: none"> • Standard V1; 24 ... 48 V, 5 A with hardware STO and integrated braking chopper 	6BK1136-6AB01-0BU0

SIMATIC MICRO-DRIVE drive system

TM Drives

F-TM ServoDrive ST

Technical specifications

Article number	6BK1136-6AB01-0BU0 F-TM ServoDrive ST
General information	
Product type designation	F-TM ServoDrive ST
Product description	Control of EC motors
Product function	
• I&M data	Yes
• Isochronous mode	No
• Four-quadrant operation	Yes
• Speed control with encoder	Yes
• Speed control without encoder	No
• Safety Functions	Yes; Drive controller with hardwired STO
Protection function	
• Undervoltage protection	Yes
• Overvoltage protection	Yes
• Overload protection	Yes
• Ground-fault protection	No
• Short-circuit protection	Yes
Installation type/mounting	
Type of ventilation	Convection cooling
Supply voltage	
Design of the power supply	24 ... 48 V DC, SELV / PELV
Output voltage	
Rated value, min.	24 V
Rated value, max.	48 V
Output current	
Current output (rated value)	5 A
Output current, max.	10 A
Output frequency	599 Hz
Encoder supply	
Number of outputs	1
5 V encoder supply	
• 5 V	Yes
• Short-circuit protection	Yes
• Output current, max.	150 mA
Digital inputs	
Number of digital inputs	1; input for message signal
Number of safety inputs	1; For STO, antivalent (2-pin) - 24 V DC
Encoder	
Connectable encoders	
• Incremental encoder (symmetrical)	Yes; up to 500 Hz per channel
• Hall encoder	Yes
Interrupts/diagnostics/status information	
Alarms	
• Diagnostic alarm	Yes
• Hardware interrupt	No
Diagnoses	
• Monitoring the supply voltage	Yes
• Wire-break	Yes
• Short-circuit	Yes
• Group error	Yes
Diagnostics indication LED	
• RUN LED	Yes
• ERROR LED	Yes

Article number	6BK1136-6AB01-0BU0 F-TM ServoDrive ST
Integrated Functions	
Position detection	
• Incremental acquisition	Yes
• Absolute acquisition	No
• Suitable for S7-1500 Motion Control	Yes
Potential separation	
Potential separation channels	
• between the channels and back-plane bus	Yes
Degree and class of protection	
IP degree of protection	IP20
Standards, approvals, certificates	
CE mark	Yes
UKCA mark	Yes
cULus	Yes
RCM (formerly C-TICK)	Yes
KC approval	Yes
EAC (formerly Gost-R)	Yes
RoHS conformity	Yes
China RoHS compliance	Yes
Standard for EMC according to EN 61800-3	Yes
Standard for drive acc. to EN 61800-5-1	Yes
Standard for drive acc. to EN 61800-5-2	Yes
Highest safety class achievable in safety mode	
• Performance level according to ISO 13849-1	Category 3, performance level d, according to EN ISO 13849-1:2015
• SIL acc. to IEC 61508	2
• SIL acc. to DIN EN 61800-5-2	2
Ambient conditions	
Pollution degree during storage and transport	2
Ambient temperature during operation	
• horizontal installation, min.	-30 °C; No condensation, splash water, icing, salt spray or oil mist permitted.
• horizontal installation, max.	60 °C; No condensation, splash water, icing, salt spray or oil mist permitted. Note the derating data!
• vertical installation, min.	-30 °C; No condensation, splash water, icing, salt spray or oil mist permitted.
• vertical installation, max.	50 °C; No condensation, splash water, icing, salt spray or oil mist permitted. Note the derating data!
Ambient temperature during storage/transportation	
• Storage, min.	-30 °C
• Storage, max.	70 °C
Altitude during operation relating to sea level	
• Installation altitude above sea level, max.	3 000 m

Technical specifications

Article number	6BK1136-6AB01-0BU0 F-TM ServoDrive ST
Cables	
Cable length for motor, shielded, max.	10 m
Dimensions	
Width	20 mm
Height	73 mm
Depth	58 mm
Weights	
Weight, approx.	55 g
Other	
Brake design	holding brake control via the process image
Braking chopper	Yes

Accessories

Description	Article No.
SIMATIC F-TM ServoDrive ST Starter Kit Scope of supply: <ul style="list-style-type: none"> SIMATIC MICRO-DRIVE F-TM ServoDrive ST SIMATIC ET 200SP PROFINET IM 155-6PN ST Interface Module SIMATIC ET 200SP BaseUnit type U0 All-in-one plug-in cable CSD_LAI02, length 1.5 m ebm-papst motor ECI42.20 24 V 	6BK1637-6AB00-0BU0
ET 200SP BaseUnit type U0 <ul style="list-style-type: none"> For constructing a new potential group (white) For continuing an existing potential group (gray) 	6ES7193-6BP00-0DU0 6ES7193-6BP00-0BU0
Shield connection for ET 200SP Includes 5 shield connections	6ES7193-6SC20-1AM0

SIMATIC MICRO-DRIVE drive system

TM Drives

F-TM StepDrive ST

Overview



The ET 200SP technology module F-TM StepDrive ST allows positioning and speed control of stepper motors up to 10 A peak current in very confined spaces.

Engineering in the TIA Portal stands for consistency in a single tool. This facilitates drive dimensioning, commissioning and servicing.

The new drive system consists of

- The F-TM StepDrive ST
- The BaseUnit (U0)

Further information on the distributed I/O system SIMATIC ET 200SP is available in the ST 70 Catalog and on the internet at www.siemens.com/et200sp

SIMATIC MICRO-DRIVE F-TM StepDrive ST

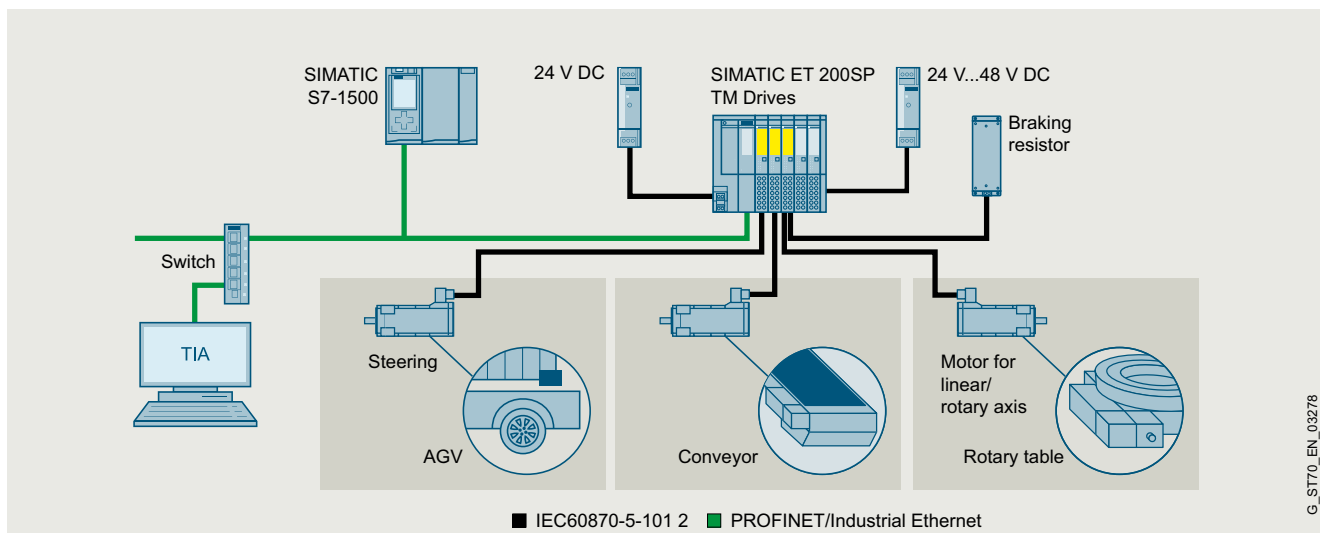

Application example TM Drives

Characteristics

- Bipolar stepper motors
- PROFIdrive profile via PROFINET
- Hardware STO (SIL3)
- Digital input
- Encoderless open-loop controlled operation
- Closed-loop operation with encoder feedback

- Encoder connection for - Incremental encoders

Variant	Power	Device width
Standard	280 W	20 mm

More information:
www.siemens.com/micro-drive

Selection and ordering data

F-TM StepDrive ST for SIMATIC MICRO-DRIVE	
Variant	Article No
• Standard V1; 24 ... 48 V, 5 A with hardware STO	6BK1136-6SB01-0BU0

G_ST70_EN_03278

Technical specifications

Article number	6BK1136-6SB01-0BU0 F-TM StepDrive ST
General information	
Product type designation	F-TM StepDrive ST
Product description	control of stepper motors
Product function	
• I&M data	Yes
• Isochronous mode	No
• Four-quadrant operation	Yes
• Speed control with encoder	No
• Speed control without encoder	No
• Safety Functions	Yes; Drive controller with hardwired STO
Protection function	
• Undervoltage protection	Yes
• Overvoltage protection	Yes
• Overload protection	Yes
• Ground-fault protection	No
• Short-circuit protection	Yes
Installation type/mounting	
Type of ventilation	Convection cooling
Supply voltage	
Design of the power supply	24 ... 48 V DC, SELV / PELV
Output voltage	
Rated value, min.	24 V
Rated value, max.	48 V
Output current	
Current output (rated value)	5 A
Output current, max.	10 A
Output frequency	1 500 Hz
Encoder supply	
Number of outputs	1
5 V encoder supply	
• 5 V	Yes
• Short-circuit protection	Yes
• Output current, max.	150 mA
Digital inputs	
Number of digital inputs	1; input for message signal
Number of safety inputs	1; For STO, antivalent (2-pin) - 24 V DC
Encoder	
Connectable encoders	
• Incremental encoder (symmetrical)	Yes; up to 500 Hz per channel
Interruptions/diagnostics/status information	
Alarms	
• Diagnostic alarm	Yes
• Hardware interrupt	No
Diagnoses	
• Monitoring the supply voltage	Yes
• Wire-break	Yes
• Short-circuit	Yes
• Group error	Yes

Article number	6BK1136-6SB01-0BU0 F-TM StepDrive ST
Diagnostics indication LED	
• RUN LED	Yes
• ERROR LED	Yes
Integrated Functions	
Position detection	
• Incremental acquisition	Yes
• Absolute acquisition	No
• Suitable for S7-1500 Motion Control	Yes
Potential separation	
Potential separation channels	
• between the channels and back-plane bus	Yes
Degree and class of protection	
IP degree of protection	IP20
Standards, approvals, certificate	
CE mark	Yes
UKCA mark	Yes
cULus	Yes
RCM (formerly C-TICK)	Yes
KC approval	Yes
EAC (formerly Gost-R)	Yes
RoHS conformity	Yes
China RoHS compliance	Yes
Standard for EMC according to EN 61800-3	Yes
Standard for drive acc. to EN 61800-5-1	Yes
Standard for drive acc. to EN 61800-5-2	Yes
Highest safety class achievable in safety mode	
• Performance level according to ISO 13849-1	Category 3, performance level d, according to EN ISO 13849-1:2015
• SIL acc. to IEC 61508	3
• SIL acc. to DIN EN 61800-5-2	3
Ambient conditions	
Pollution degree during storage and transport	2
Ambient temperature during operation	
• horizontal installation, min.	-30 °C; No condensation, splash water, icing, salt spray or oil mist permitted.
• horizontal installation, max.	60 °C; No condensation, splash water, icing, salt spray or oil mist permitted. Note the derating data!
• vertical installation, min.	-30 °C; No condensation, splash water, icing, salt spray or oil mist permitted.
• vertical installation, max.	50 °C; No condensation, splash water, icing, salt spray or oil mist permitted. Note the derating data!
Ambient temperature during storage/transportation	
• Storage, min.	-30 °C
• Storage, max.	70 °C
Altitude during operation relating to sea level	
• Installation altitude above sea level, max.	3 000 m

SIMATIC MICRO-DRIVE drive system

TM Drives

F-TM StepDrive ST**Technical specifications**

Article number	6BK1136-6SB01-0BU0 F-TM StepDrive ST
Cables	
Cable length for motor, shielded, max.	10 m
Dimensions	
Width	20 mm
Height	73 mm
Depth	58 mm
Weights	
Weight, approx.	55 g
Other	
Brake design	holding brake control via the process image
Braking chopper	No

Accessories

Description	Article No.
ET 200SP BaseUnit type U0	6ES7193-6BP00-0DU0 6ES7193-6BP00-0BU0
<ul style="list-style-type: none"> For constructing a new potential group (white) For continuing an existing potential group (gray) 	
Shield connection for ET 200SP	6ES7193-6SC20-1AM0
Includes 5 shield connections	

2

Overview**Motors/gear units and connection systems from Siemens Product Partners**Note

Siemens Product Partners are third-party companies outside of Siemens AG and its associated companies. Information and descriptions of products from the Siemens Product Partners are non-binding and are the responsibility of the Siemens Product Partner. These products are independently manufactured by the respective, responsible Siemens Product Partner and are sold and delivered by said partner according to its business and delivery terms.

Insofar as it is not compulsory by law, Siemens assumes no liability or warranty for these products or for the connection to these products of the Siemens Product Partners. Please also note the information on the exclusion of liability/use of hyperlinks (see More information).

Motors/gear units

Motor from ebm-papst and motor from Dunkermotoren

- Fully compatible motors and geared motors for SIMATIC MICRO-DRIVE
- From the portfolios of the Siemens Product Partners¹⁾ Dunkermotoren and ebm-papst
- Various combinations are available with the following components:
 - Motor
 - Planetary gearbox
 - Hall-effect sensors
 - Encoder (incremental encoder)
 - Optionally with holding brake
- Individual motor-gearbox combinations for the quick configuration during the bidding phase (not for series purchasing) can be ordered via SiePortal
- Complete sets can be ordered via the web shops of the Siemens Product Partners: <https://www.dunkermotoren.com/simatic-micro-drive>

<https://idt-config.ebmpapst.com/simatic-micro-drive>

Delivery time of preferred types

Preferred types are components from Siemens Product Partners that will be shipped within 5 work days. The shipping time must be added to the delivery time. Availability of the individual components is a prerequisite.

Connection system

KnorrTec plug-in cable for SIMATIC MICRO-DRIVE

- Fully compatible plug-in cables for SIMATIC MICRO-DRIVE
- From the portfolios of the Siemens Product Partners¹⁾ HARTING and KnorrTec
- Pre-assembled at both ends
- Different versions available for different requirements
- Individual cable lengths for the quick configuration during the bidding phase (not for series purchasing) can be ordered via SiePortal
- Complete sets can be ordered via the web shops of the Siemens Product Partners: www.harting.com/US/en/solutions/siemens-product-partner-simatic-micro-drive

www.knorrtec.de/eshop.php?seourl=simatic_micro-drive.html&s_language=english

¹⁾ Information on the Siemens Product Partners: www.siemens.com/productpartner

SIMATIC MICRO-DRIVE drive system

Motors/gear units and connection systems from Siemens Product Partners

Overview

PPP plug-in cables for SIMATIC MICRO-DRIVE as of V1.0

In the following you will find an overview of all the plug-in cables that are required between the PDC Drives and the motors or geared motors:

Plug-in cables for motors from ebm-papst					
Motor size	Motor power	Motor connector Size	Drive controller		
	W		PDC100/ PDC100F	PDC600/ PDC600F/ PDC1000 V1	F-TM ServoDrive ST F-TM ServoDrive HF
For 48 V DC					
PDC connector			Weidmüller, small	Phoenix, large	
ECI42.20	46	M12	LAI02	LAI020	CSD_LAI02
ECI42.40	92	M12	LAI02	LAI020	CSD_LAI02
ECI63.20	150	M12	LAI02	LAI020	CSD_LAI02
ECI63.40	280	M12	LAI02	LAI020	CSD_LAI02
ECI63.60	370	M12	LAI02	LAI020	CSD_LAI02
ECI80.40	503	M23	-	LPMo3	-
ECI80.60	754	M23	-	LPMo3	-
Plug-in encoder cable			-	LPEn2	-
Plug-in brake cable			LPBr2	LPBr2	LPBr2

Plug-in cables for Dunkermotoren motors					
Motor size	Motor power	Motor connector Size	Drive controller		
	W		PDC100/ PDC100F	PDC600/ PDC600F/ PDC1000 V1	F-TM ServoDrive ST F-TM ServoDrive HF
For 40 V DC					
PDC connector			Weidmüller, small	Phoenix, large	
BG45x30	90	M16	LAI01	LAI010	CSD_LAI01
BG65Sx50	186	M16	LAI01	LAI010	CSD_LAI01
BG75x50	400	M17	-	LPMo1	-
For 48 V DC					
BG95x40	717	M23	-	LPMo3	-
BG95x80	1109	M23	-	LPMo3	-
Plug-in encoder cable			-	LPEn1	-
Plug-in brake cable			LPBr1	LPBr1	LPBr1

Legend

LAI0x = all-in-one connecting cable, single-cable system (all signals in one plug-in cable, motor phases, Hall-effect sensor, incremental encoders, power supplies)

LPMox = plug-in motor cable

LPEnx = plug-in encoder cable

LPBrx = plug-in brake cable

More information

Note

Exclusion of liability/use of hyperlinks

Siemens has composed this description with great care. However, it is not possible for Siemens to perform a check of the completeness, correctness and up-to-datedness of the data provided by Siemens Product Partners. Therefore, it cannot be ruled out that individual data may be incorrect, incomplete, or not up-to-date. Siemens does not assume any liability in this case, nor for the usability of the data or of the product for the user, unless the liability is compulsory by law.

This document contains addresses of third-party web pages. Siemens accepts no responsibility for the contents of these web sites, nor does Siemens adopt these web sites and their contents as its own, as Siemens cannot check the information presented there and is also not responsible for the content and information provided on them. The user uses these web sites at his own risk.

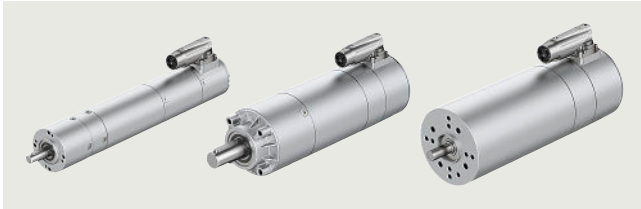
Overview

ebm-papst motors ECI-42.40-K1-PP42.2, ECI-63.20-K1-PP63.1, ECI-63.60-K1 for SIMATIC MICRO-DRIVE

- Motors for SIMATIC MICRO-DRIVE from the Siemens Product Partner [ebm-papst](#)
- Motors with 24 V or 48 V supply voltage
- With and without mounted planetary gearbox and mounted IQ encoder (single-turn)
- Hall-effect sensors
- Optionally with holding brake
- Degree of protection IP54 (motors without gearbox) or degree of protection IP50 (motors with gearbox)

The TIA Selection Tool can be used for the technical dimensioning of the drive axis. This allows users to specify the motion and load conditions. The dimensioning tool provides recommendations for the various possible motor-gearbox combinations and the usable PDC Drives with power specification.

All technical data of the drive combinations can be found on the SIMATIC MICRO-DRIVE web pages of the Siemens Product Partners.

For ebm-papst:

<https://idt-config.ebmpapst.com/simatic-micro-drive>

Selection and ordering data**Motors for SIMATIC MICRO-DRIVE from the Siemens Product Partner [ebm-papst](#)**

Motors with article numbers including the prefix "EBM:" can be ordered directly from Siemens for quick configuration during the bidding phase.

Motors with article numbers without the prefix "EBM:" can be ordered directly from the Product Partner.

Without brake

Type of gear unit	Gear unit reduction ratio	Preferred type	Product partner article no. Article No.	Preferred type	Product partner article no. Article No.
Can be used with all PDC and F-TM ServoDrive ST/HF drive controllers					
			Motor ECI42.20 24 V DC		Motor ECI42.20 48 V DC
PerformaxPlus 42.1	5		SGE4220BK1PP42100560		SGE4220DK1PP42100560
PerformaxPlus 42.1	9	✓	SGE4220BK1PP42100960 EBM:SGE4220BK1PP42100960		SGE4220DK1PP42100960
PerformaxPlus 42.2	30		SGE4220BK1PP42203060		SGE4220DK1PP42203060
PerformaxPlus 42.2	54	✓	SGE4220BK1PP42205460 EBM:SGE4220BK1PP42205460		SGE4220DK1PP42205460
without gear unit	-	✓	SSE4220BK1xxxxxxxx60 EBM:SSE4220BK1xxxxxxxx60		SSE4220DK1xxxxxxxx60
Can be used with all PDC and F-TM ServoDrive ST/HF drive controllers					
			Motor ECI42.40 24 V DC		Motor ECI42.40 48 V DC
PerformaxPlus 42.1	5		SGE4240BK1PP42100560	✓	SGE4240DK1PP42100560 EBM:SGE4240DK1PP42100560
PerformaxPlus 42.1	9		SGE4240BK1PP42100960		SGE4240DK1PP42100960
PerformaxPlus 42.2	30		SGE4240BK1PP42203060	✓	SGE4240DK1PP42203060 EBM:SGE4240DK1PP42203060
PerformaxPlus 42.2	54		SGE4240BK1PP42205460		SGE4240DK1PP42205460
without gear unit	-		SSE4240BK1xxxxxxxx60		SSE4240DK1xxxxxxxx60

SIMATIC MICRO-DRIVE drive system

Motors/gear units and connection systems from Siemens Product Partners

ebm-papst motors/gear units

Selection and ordering data

Without brake

Type of gear unit	Gear unit reduction ratio	Preferred type	Product partner article no. Article No.	Preferred type	Product partner article no. Article No.
Can be used with all PDC and F-TM ServoDrive ST/HF drive controllers					
			Motor ECI63.20 24 V DC		Motor ECI63.20 48 V DC
PerformaxPlus 63.1	5		SGE6320BK1PP63100560		SGE6320DK1PP63100560
PerformaxPlus 63.1	9		SGE6320BK1PP63100960		SGE6320DK1PP63100960
PerformaxPlus 63.2	30	✓	SGE6320BK1PP63203060 EBM:SGE6320BK1PP63203060		SGE6320DK1PP63203060
PerformaxPlus 63.2	54		SGE6320BK1PP63205460		SGE6320DK1PP63205460
without gear unit	-		SSE6320BK1xxxxxxxxx60		SSE6320DK1xxxxxxxxx60
Can be used with all PDC and F-TM ServoDrive ST/HF drive controllers					
			Motor ECI63.40 24 V DC		Motor ECI63.40 48 V DC
PerformaxPlus 63.1	5		SGE6340BK1PP63100560		SGE6340DK1PP63100560
PerformaxPlus 63.1	9		SGE6340BK1PP63100960	✓	SGE6340DK1PP63100960 EBM:SGE6340DK1PP63100960
PerformaxPlus 63.2	30		SGE6340BK1PP63203060		SGE6340DK1PP63203060
PerformaxPlus 63.2	54		SGE6340BK1PP63205460		SGE6340DK1PP63205460
without gear unit	-		SSE6340BK1xxxxxxxxx60		SSE6340DK1xxxxxxxxx60
Can be used with all PDC and F-TM ServoDrive ST/HF drive controllers					
			Motor ECI63.60 24 V DC		Motor ECI63.60 48 V DC
PerformaxPlus 63.1	5		-		SGE6360DK1PP63100560
PerformaxPlus 63.1	9		-		SGE6360DK1PP63100960
PerformaxPlus 63.2	30		-		SGE6360DK1PP63203060
PerformaxPlus 63.2	54		-		SGE6360DK1PP63205460
without gear unit	-		-		SSE6360DK1xxxxxxxxx60
Can be used with PDC600/PDC600F drive controller and PDC1000 V1 drive controller					
			Motor ECI80.40 24 V DC		Motor ECI80.40 48 V DC
PE 80.1	5		-		SGE8040DK1PE80100560
PE 80.1	8		-		SGE8040DK1PE80100860
PE 80.2	25		-		SGE8040DK1PE80202560
PE 80.2	40		-		SGE8040DK1PE80204060
without gear unit	-		-		SSE8040DK1xxxxxxxxx60
Can be used with PDC600/PDC600F drive controller and PDC1000 V1 drive controller					
			Motor ECI80.60 24 V DC		Motor ECI80.60 48 V DC
PE 80.1	5		-		SGE8060DK1PE80100560
PE 80.1	8		-		SGE8060DK1PE80100860
PE 80.2	25		-	✓	SGE8060DK1PE80202560 EBM:SGE8060DK1PE80202560
PE 80.2	40		-		SGE8060DK1PE80204060
without gear unit	-		-	✓	SSE8060DK1xxxxxxxxx60 EBM:SSE8060DK1xxxxxxxxx60

SIMATIC MICRO-DRIVE drive system

Motors/gear units and connection systems from Siemens Product Partners

ebm-papst motors/gear units

Selection and ordering data

With brake

Type of gear unit	Gear unit reduction ratio	Preferred type	Product partner article no. Article No.	Preferred type	Product partner article no. Article No.
-------------------	---------------------------	----------------	---	----------------	---

Can be used with all PDC and F-TM ServoDrive ST/HF drive controllers

			Motor ECI42.20 24 V DC		Motor ECI42.20 48 V DC
PerformaxPlus 42.1	5	✓	SGE4220BK1PP42100561 EBM:SGE4220BK1PP42100561		SGE4220DK1PP42100561
PerformaxPlus 42.1	9		SGE4220BK1PP42100961		SGE4220DK1PP42100961
PerformaxPlus 42.2	30	✓	SGE4220BK1PP42203061 EBM:SGE4220BK1PP42203061		SGE4220DK1PP42203061
PerformaxPlus 42.2	54		SGE4220BK1PP42205461		SGE4220DK1PP42205461
without gear unit	-		SSE4220BK1xxxxxxxx61		SSE4220DK1xxxxxxxx61

Can be used with all PDC and F-TM ServoDrive ST/HF drive controllers

			Motor ECI42.40 24 V DC		Motor ECI42.40 48 V DC
PerformaxPlus 42.1	5		SGE4240BK1PP42100561		SGE4240DK1PP42100561
PerformaxPlus 42.1	9		SGE4240BK1PP42100961	✓	SGE4240DK1PP42100961 EBM:SGE4240DK1PP42100961
PerformaxPlus 42.2	30		SGE4240BK1PP42203061		SGE4240DK1PP42203061
PerformaxPlus 42.2	54		SGE4240BK1PP42205461		SGE4240DK1PP42205461
without gear unit	-		SSE4240BK1xxxxxxxx61	✓	SSE4240DK1xxxxxxxx61 EBM:SSE4240DK1xxxxxxxx61

Can be used with all PDC and F-TM ServoDrive ST/HF drive controllers

			Motor ECI63.20 24 V DC		Motor ECI63.20 48 V DC
PerformaxPlus 63.1	5		SGE6320BK1PP63100561		SGE6320DK1PP63100561
PerformaxPlus 63.1	9		SGE6320BK1PP63100961		SGE6320DK1PP63100961
PerformaxPlus 63.2	30		SGE6320BK1PP63203061		SGE6320DK1PP63203061
PerformaxPlus 63.2	54		SGE6320BK1PP63205461		SGE6320DK1PP63205461
without gear unit	-		SSE6320BK1xxxxxxxx61		SSE6320DK1xxxxxxxx61

Can be used with all PDC and F-TM ServoDrive ST/HF drive controllers

			Motor ECI63.40 24 V DC		Motor ECI63.40 48 V DC
PerformaxPlus 63.1	5		SGE6340BK1PP63100561		SGE6340DK1PP63100561
PerformaxPlus 63.1	9	✓	SGE6340BK1PP63100961 EBM:SGE6340BK1PP63100961		SGE6340DK1PP63100961
PerformaxPlus 63.2	30		SGE6340BK1PP63203061		SGE6340DK1PP63203061
PerformaxPlus 63.2	54		SGE6340BK1PP63205461	✓	SGE6340DK1PP63205461 EBM:SGE6340DK1PP63205461
without gear unit	-		SSE6340BK1xxxxxxxx61		SSE6340DK1xxxxxxxx61

Can be used with all PDC and F-TM ServoDrive ST/HF drive controllers

			Motor ECI63.60 24 V DC		Motor ECI63.60 48 V DC
PerformaxPlus 63.1	5	-			SGE6360DK1PP63100561
PerformaxPlus 63.1	9	-		✓	SGE6360DK1PP63100961 EBM:SGE6360DK1PP63100961
PerformaxPlus 63.2	30	-		✓	SGE6360DK1PP63203061 EBM:SGE6360DK1PP63203061
PerformaxPlus 63.2	54	-			SGE6360DK1PP63205461
without gear unit	-	-			SSE6360DK1xxxxxxxx61

2

SIMATIC MICRO-DRIVE drive system

Motors/gear units and connection systems from Siemens Product Partners

ebm-papst motors/gear units**Selection and ordering data****With brake**

Type of gear unit	Gear unit reduction ratio	Preferred type	Product partner article no. Article No.	Preferred type	Product partner article no. Article No.
Can be used with PDC600/PDC600F drive controller and PDC1000 V1 drive controller					
			Motor EC180.40 24 V DC		Motor EC180.40 48 V DC
PE 80.1	5	-	-		SGE8040DK1PE80100561
PE 80.1	8	-	-	✓	SGE8040DK1PE80100861 EBM:SGE8040DK1PE80100861
PE 80.2	25	-	-		SGE8040DK1PE80202561
PE 80.2	40	-	-	✓	SGE8040DK1PE80204061 EBM:SGE8040DK1PE80204061
without gear unit	-	-	-		SSE8040DK1xxxxxxxx61
Can be used with PDC600/PDC600F drive controller and PDC1000 V1 drive controller					
			Motor EC180.60 24 V DC		Motor EC180.60 48 V DC
PE 80.1	5	-	-		SGE8060DK1PE80100561
PE 80.1	8	-	-	✓	SGE8060DK1PE80100861 EBM:SGE8060DK1PE80100861
PE 80.2	25	-	-		SGE8060DK1PE80202561
PE 80.2	40	-	-	✓	SGE8060DK1PE80204061 EBM:SGE8060DK1PE80204061
without gear unit	-	-	-		SSE8060DK1xxxxxxxx61

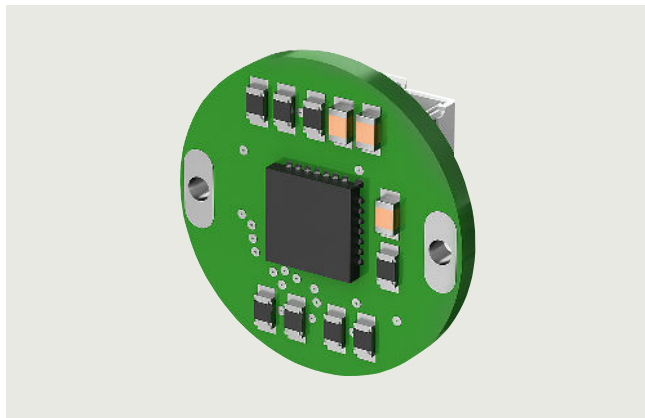
Selection and ordering data**Drive with IEM 38 magnetic incremental encoder**

IEM 38 magnetic incremental encoder

Characteristics

- Magnetic 3 channel incremental encoder
- A resolution of 12 bit is attained by appropriate evaluation
- The encoder is non-contacting and wear-free
- Additional resolutions and interfaces on request

Encoder type	IEM 38
Type of the measured value	incremental
Type of the measured method	magnetic
Resolution	1024 PPR ¹⁾ 4096 CPR ²⁾
Output signal A, B, Z ³⁾	A, /A, B, /B, Z, /Z (RS422)
Max. signal frequency f	4000 kHz
Supply voltage U_B	+5 V DC \pm 10 %
Power consumption I_B	max. 30 mA
Precision	\pm 35°
Protection class	IP54 (implemented via installation in the drive)
Permissible ambient temperature range T_U	-40 ... +125 °C

Without brake

Product name	Type of the gear unit	Gear unit reduction ratio	Encoder	Preferred type	Product partner article no. Article No.
--------------	-----------------------	---------------------------	---------	----------------	---

Can be used with all PDC and F-TM ServoDrive ST/HF drive controllers

					Motor ECI42.40 DC 48 V
ECI-42.40-D00-K1-S-G14 - PerformaxPLUS 42.1 (5,0:1)	PerformaxPLUS 42.1 (5,0:1)	5	IEM 38 magnetic incremental encoder		ECI-42.40-K1-48-PP42.1.5-PF-G14-WR
ECI-42.40-D00-K1-S-G14 - PerformaxPLUS 42.2 (30,0:1)	PerformaxPLUS 42.2 (30,0:1)	30			ECI-42.40-K1-48-PP42.2.30-PF-G14-WR
ECI-42.40-D00-K1-S-G14	without gear unit	-			ECI-42.40-K1-48-GL-G14-WR

With brake

Product name	Type of the gear unit	Gear unit reduction ratio	Encoder	Preferred type	Product partner article no. Article No.
--------------	-----------------------	---------------------------	---------	----------------	---

Can be used with all PDC and F-TM ServoDrive ST/HF drive controllers

					Motor ECI42.40 DC 48 V
ECI-42.40-D00-K1-S-IB-G14 - PerformaxPLUS 42.1 (5,0:1)	PerformaxPLUS 42.1 (5,0:1)	5	IEM 38 magnetic incremental encoder		ECI-42.40-K1-48-PP42.1.5-PF-B09-G14-WR
ECI-42.40-D00-K1-S-IB-G14 - PerformaxPLUS 42.2 (30,0:1)	PerformaxPLUS 42.2 (30,0:1)	30			ECI-42.40-K1-48-PP42.2.30-PF-B09-G14-WR
ECI-42.40-D00-K1-S-IB-G14	without gear unit	-			ECI-42.40-K1-48-GL-B09-G14-WR

Connection cables see <https://idt-config.ebmpapst.com/>

- 1 m harness article no. 992 0160 200
- 3 m harness article no. 992 0160 201
- 10 m harness article no. 992 0160 202

¹⁾ PPR = Period per revolution; signal impulse from one rising edge to the next rising edge on a channel = 1 cycle.

²⁾ CPR 0 Counts per revolution; edge change during quadrature evaluation = 1 edge interval.

³⁾ A and B channel with 90° phase offset.

SIMATIC MICRO-DRIVE drive system

Motors/gear units and connection systems from Siemens Product Partners

ebm-papst motors/gear units

Selection and ordering data

Drive with IEM 58 magnetic incremental encoder

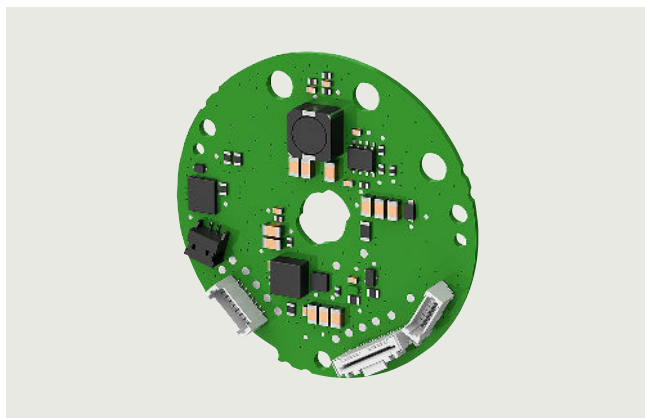

IEM 58 magnetic incremental encoder

Characteristics

- Magnetic 3 channel incremental encoder
- A resolution of 12 bit is attained by appropriate evaluation
- The encoder is non-contacting and wear-free
- Additional resolutions and interfaces on request

Encoder type	IEM 58
Type of the measured value	incremental
Type of the measured method	magnetic
Resolution	1024 PPR ¹⁾ 4096 CPR ²⁾
Output signal A, B, Z ³⁾	A, /A, B, /B, Z, /Z (RS422)
Max. signal frequency f	120 kHz
Supply voltage U_B	+5 ... 24 V DC
Power consumption I_B	max. 20 mA
Precision	$\pm 0.5^\circ$
Protection class	IP54 (implemented via installation in the drive)
Permissible ambient temperature range T_U	-30 ... +105 °C

Without brake

Product name	Type of the gear unit	Gear unit reduction ratio	Encoder	Preferred type	Product partner article no. Article No.
--------------	-----------------------	---------------------------	---------	----------------	---

Can be used with all PDC and F-TM ServoDrive ST/HF drive controllers

					Motor ECI63.20 DC 48 V
ECI-63.20-D00-K1-S-G10 - PerformaxPLUS 63.1 (5,0:1)	PerformaxPLUS 63.1 (5,0:1)	5	EM 58 magnetic incremental encoder		ECI-63.20-K1-48-PP63.1.5-PF-G10-WR
ECI-63.20-D00-K1-S-G10 - PerformaxPLUS 63.2 (30,0:1)	PerformaxPLUS 63.2 (30,0:1)	30			ECI-63.20-K1-48-PP63.2.30-PF-G10-WR
ECI-63.20-D00-K1-S-G10	without gear unit	-			ECI-63.20-K1-48-GL-G10-WR
					Motor ECI63.40 DC 48 V
ECI-63.40-D00-K1-S-G10 - PerformaxPLUS 63.1 (5,0:1)	PerformaxPLUS 63.1 (5,0:1)	5	IEM 58 magnetic incremental encoder		ECI-63.40-K1-48-PP63.1.5-PF-G10-WR
ECI-63.40-D00-K1-S-G10 - PerformaxPLUS 63.2 (30,0:1)	PerformaxPLUS 63.2 (30,0:1)	30			ECI-63.40-K1-48-PP63.2.30-PF-G10-WR
ECI-63.40-D00-K1-S-G10	without gear unit	-			ECI-63.40-K1-48-GL-G10-WR

With brake

Product name	Type of the gear unit	Gear unit reduction ratio	Encoder	Preferred type	Product partner article no. Article No.
--------------	-----------------------	---------------------------	---------	----------------	---

Can be used with all PDC and F-TM ServoDrive ST/HF drive controllers

					Motor ECI63.20 DC 48 V
ECI-63.20-D00-K1-S-IB-G10 - PerformaxPLUS 63.1 (5,0:1)	PerformaxPLUS 63.1 (5,0:1)	5	IEM 58 magnetic incremental encoder		ECI-63.20-K1-48-PP63.1.5-PF-B08-G10-WR
ECI-63.20-D00-K1-S-IB-G10 - PerformaxPLUS 63.2 (30,0:1)	PerformaxPLUS 63.2 (30,0:1)	30			ECI-63.20-K1-48-PP63.2.30-PF-B08-G10-WR
ECI-63.20-D00-K1-S-IB-G10	without gear unit	-			ECI-63.20-K1-48-GL-B08-G10-WR
					Motor ECI63.40 DC 48 V
ECI-63.40-D00-K1-S-IB-G10 - PerformaxPLUS 63.1 (5,0:1)	PerformaxPLUS 63.1 (5,0:1)	5	IEM 58 magnetic incremental encoder		ECI-63.40-K1-48-PP63.1.5-PF-B08-G10-WR
ECI-63.40-D00-K1-S-IB-G10 - PerformaxPLUS 63.2 (30,0:1)	PerformaxPLUS 63.2 (30,0:1)	30			ECI-63.40-K1-48-PP63.2.30-PF-B08-G10-WR
ECI-63.40-D00-K1-S-IB-G10	without gear unit	-			ECI-63.40-K1-48-GL-B08-G10-WR

Connection cables see <https://idt-config.ebmpapst.com/>

- 1 m harness article no. 992 0160 200
- 3 m harness article no. 992 0160 201
- 10 m harness article no. 992 0160 202

- ¹⁾ PPR = Period per revolution; signal impulse from one rising edge to the next rising edge on a channel = 1 cycle.
- ²⁾ CPR 0 Counts per revolution; edge change during quadrature evaluation = 1 edge interval.
- ³⁾ A and B channel with 90° phase offset.
- ⁴⁾ Value applies to operation at $T_U = 40^\circ\text{C}$.

Selection and ordering data**Drive with AEM 35 absolute encoder multiturn**

AEM 35 absolute encoder multiturn

Characteristics

- Magnetic absolute encoder multiturn, optional singleturn
- A resolution of 17 bit (singleturn) or 16 bit (multiturn) is attained by appropriate evaluation
- The encoder is non-contacting and wear-free
- Battery-less counter buffering using the Wiegand effect
- Additional resolutions and interfaces on request

Encoder type	AEM 35
Type of the measured value	absolute multiturn
Type of the measured method	magnetic
Resolution	• singleturn • multiturn
Counter buffering	Energy-Harvesting (without battery, without gear unit)
Interface	BISS C (optional SSI)
Max. signal frequency f	10000 kHz
Supply voltage U_B	+5 ... 15 V DC
Power consumption I_B	60 mA
Precision	$\pm 0.5^\circ$
Protection class	IP54 (implemented via installation in the drive)
Permissible ambient temperature range T_U	-40 ... +105 °C

Without brake

Product name	Type of the gear unit	Gear unit reduction ratio	Encoder	Preferred type	Product partner article no. Article No.
--------------	-----------------------	---------------------------	---------	----------------	---

Can be used with F-TM ServoDrive HF drive controllers

					Motor ECI42.40 DC 48 V
ECI-42.40-D00-K1-S-G5 - PerformaxPLUS 42.1 (5,0:1)	PerformaxPLUS 42.1 (5,0:1)	5	AEM 35 absolute encoder multiturn		ECI-42.40-K1-48-PP42.1.5-PF-G05-WR
ECI-42.40-D00-K1-S-G5 - PerformaxPLUS 42.2 (30,0:1)	PerformaxPLUS 42.2 (30,0:1)	30			ECI-42.40-K1-48-PP42.2.30-PF-G05-WR
ECI-42.40-D00-K1-S-G5	without gear unit	-			ECI-42.40-K1-48-GL-G05-WR
					Motor ECI63.20 DC 48 V
ECI-63.20-D00-K1-S-G5 - PerformaxPLUS 63.1 (5,0:1)	PerformaxPLUS 63.1 (5,0:1)	5	AEM 35 absolute encoder multiturn		ECI-63.20-K1-48-PP63.1.5-PF-G05-WR
ECI-63.20-D00-K1-S-G5 - PerformaxPLUS 63.2 (30,0:1)	PerformaxPLUS 63.2 (30,0:1)	30			ECI-63.20-K1-48-PP63.2.30-PF-G05-WR
ECI-63.20-D00-K1-S-G5	without gear unit	-			ECI-63.20-K1-48-GL-G05-WR
					Motor ECI63.40 DC 48 V
ECI-63.40-D00-K1-S-G5 - PerformaxPLUS 63.1 (5,0:1)	PerformaxPLUS 63.1 (5,0:1)	5	AEM 35 absolute encoder multiturn		ECI-63.40-K1-48-PP63.1.5-PF-G05-WR
ECI-63.40-D00-K1-S-G5 - PerformaxPLUS 63.2 (30,0:1)	PerformaxPLUS 63.2 (30,0:1)	30			ECI-63.40-K1-48-PP63.2.30-PF-G05-WR
ECI-63.40-D00-K1-S-G5	without gear unit	-			ECI-63.40-K1-48-GL-G05-WR

SIMATIC MICRO-DRIVE drive system

Motors/gear units and connection systems from Siemens Product Partners

ebm-papst motors/gear units**Selection and ordering data****With brake**

Product name	Type of the gear unit	Gear unit reduction ratio	Encoder	Preferred type	Product partner article no. Article No.
--------------	-----------------------	---------------------------	---------	----------------	---

Can be used with F-TM ServoDrive HF drive controllers

					Motor ECI42.40 DC 48 V
ECI-42.40-D00-K1-S-IB-G5 - PerformaxPLUS 42.1 (5,0:1)	PerformaxPLUS 42.1 (5,0:1)	5	AEM 35 absolute encoder multiturn		ECI-42.40-K1-48-PP42.1.5-PF-B09-G05-WR
ECI-42.40-D00-K1-S-IB-G5 - PerformaxPLUS 42.2 (30,0:1)	PerformaxPLUS 42.2 (30,0:1)	30			ECI-42.40-K1-48-PP42.2.30-PF-B09-G05-WR
ECI-42.40-D00-K1-S-IB-G5	without gear unit	-			ECI-42.40-K1-48-GL-B09-G05-WR
					Motor ECI63.20 DC 48 V
ECI-63.20-D00-K1-S-IB-G6 - PerformaxPLUS 63.1 (5,0:1)	PerformaxPLUS 63.1 (5,0:1)	5	AEM 35 absolute encoder multiturn		ECI-63.20-K1-48-PP63.1.5-PF-B08-G05-WR
ECI-63.20-D00-K1-S-IB-G5 - PerformaxPLUS 63.2 (30,0:1)	PerformaxPLUS 63.2 (30,0:1)	30			ECI-63.20-K1-48-PP63.2.30-PF-B08-G05-WR
ECI-63.20-D00-K1-S-IB-G5	without gear unit	-			ECI-63.20-K1-48-GL-B08-G05-WR
					Motor ECI63.40 DC 48 V
ECI-63.40-D00-K1-S-IB-G5 - PerformaxPLUS 63.1 (5,0:1)	PerformaxPLUS 63.1 (5,0:1)	5	AEM 35 absolute encoder multiturn		ECI-63.40-K1-48-PP63.1.5-PF-B08-G05-WR
ECI-63.40-D00-K1-S-IB-G5 - PerformaxPLUS 63.2 (30,0:1)	PerformaxPLUS 63.2 (30,0:1)	30			ECI-63.40-K1-48-PP63.2.30-PF-B08-G05-WR
ECI-63.40-D00-K1-S-IB-G5	without gear unit	-			ECI-63.40-K1-48-GL-B08-G05-WR

Connection cables see <https://idt-config.ebmpapst.com/>

- 1 m harness article no. 992 0160 200
- 3 m harness article no. 992 0160 201
- 10 m harness article no. 992 0160 202

Overview

Dunkermotoren motors BG45x30, BG65Sx50, BG95x40 without gear unit for SIMATIC MICRO-DRIVE

- Motors for SIMATIC MICRO-DRIVE from the Siemens Product Partner [Dunkermotoren](#)
- Motors with 24 V or 40 V/48 V supply voltage
- With mounted planetary gearbox and mounted IQ encoder (single-turn absolute encoder)
- Hall-effect sensors
- Optionally with holding brake
- Degree of protection IP65 (motors and gearboxes)

The TIA Selection Tool can be used for the technical dimensioning of the drive axis. This allows users to specify the motion and load conditions. The dimensioning tool provides recommendations for the various possible motor-gearbox combinations and the usable PDC Drives with power specification.

All technical data of the drive combinations can be found on the SIMATIC MICRO-DRIVE web pages of the Siemens Product Partners.

For Dunkermotoren:

www.dunkermotoren.com/simatic-micro-drive

SIMATIC MICRO-DRIVE drive system

Motors/gear units and connection systems from Siemens Product Partners

Dunkermotoren motors/gear units

Selection and ordering data

Motors for SIMATIC MICRO-DRIVE from the Siemens Product Partner Dunkermotoren

Motors with article numbers including the prefix "DUN:" can be ordered directly from Siemens for quick configuration during the bidding phase.

Motors with article numbers without the prefix "DUN:" can be ordered directly from the Product Partner.

Without brake					
Type of gear unit	Gear unit reduction ratio	Preferred type	Product partner article no. Article No.	Preferred type	Product partner article no. Article No.
Can be used with all PDC and F-TM ServoDrive ST/HF drive controllers					
			Motor BG45x30 Voltage 24 V DC		Motor BG45x30 Voltage 40 V DC
PLG52	6.25		96545.02600		96545.02800
PLG52	20.25		96545.02601		96545.02801
PLG52	126.56		96545.02602		96545.02802
Without gear unit	-	✓	96545.02699 DUN:9654502699		96545.02899
Can be used with all PDC and F-TM ServoDrive ST/HF drive controllers					
			Motor BG65Sx50 Voltage 24 V DC		Motor BG65Sx50 Voltage 40 V DC
PLG63	4.00		96566.02610		96566.02810
PLG63	7.00		96566.02611		96566.02811
PLG63	16.80		96566.02612		96566.02812
PLG63	35.00		96566.02613		96566.02813
PLG63	100.00		96566.02614		96566.02814
PLG63	175.00		96566.02615		96566.02815
Without gear unit	-		96566.02699		96566.02899
Can be used with PDC600/PDC600F drive controller and PDC1000 V1 drive controller					
			Motor BG75x50 Voltage 24 V DC		Motor BG75x50 Voltage 40 V DC
PLG75	4.00		-		96575.02620
PLG75	7.00		-		96575.02621
PLG75	16.80		-		96575.02622
PLG75	35.00		-		96575.02623
PLG75	100.00		-		96575.02624
PLG75	175.00		-		96575.02625
Without gear unit	-		-		96575.02699
Can be used with PDC600/PDC600F drive controller and PDC1000 V1 drive controller					
			Motor BG95x40 Voltage 24 V DC		Motor BG95x40 Voltage 48 V DC
PLG95	4.00		-		96595.02630
PLG95	16.80		-		96595.02631
Without gear unit	-		-		96595.02699
Can be used with PDC600/PDC600F drive controller and PDC1000 V1 drive controller					
			Motor BG95x80 Voltage 24 V DC		Motor BG95x80 Voltage 48 V DC
PLG95	4.00		-		96595.03030
PLG95	16.80		-		96595.03031
Without gear unit	-		-		96595.03099

SIMATIC MICRO-DRIVE drive system

Motors/gear units and connection systems from Siemens Product Partners

Dunkermotoren motors/gear units

Selection and ordering data

With brake					
Type of gear unit	Gear unit reduction ratio	Preferred type	Product partner article no. Article No.	Preferred type	Product partner article no. Article No.
Can be used with all PDC and F-TM ServoDrive ST/HF drive controllers					
			Motor BG45x30 With brake E38 Voltage 24 V DC		Motor BG45x30 With brake E38 Voltage 40 V DC
PLG52	6.25	✓	96545.02700 DUN:9654502700		96545.02900
PLG52	20.25		96545.02701	✓	96545.02901 DUN:9654502901
PLG52	126.56	✓	96545.02702 DUN:9654502702		96545.02902
Without gear unit	-		96545.02799	✓	96545.02999 DUN:9654502999
Can be used with all PDC and F-TM ServoDrive ST/HF drive controllers					
			Motor BG65Sx50 With brake E90 Voltage 24 V DC		Motor BG65Sx50 With brake E90 Voltage 40 V DC
PLG63	4.00		96566.02710		96566.02910
PLG63	7.00		96566.02711	✓	96566.02911 DUN:9656602911
PLG63	16.80		96566.02712		96566.02912
PLG63	35.00		96566.02713		96566.02913
PLG63	100.00		96566.02714	✓	96566.02914 DUN:9656602914
PLG63	175.00		96566.02715		96566.02915
Without gear unit	-		96566.02799		96566.02999
Can be used with PDC600/PDC600F drive controller and PDC1000 V1 drive controller					
			Motor BG75x50 With brake E100 Voltage 24 V DC		Motor BG75x50 With brake E100 Voltage 40 V DC
PLG75	4.00		-		96575.02720
PLG75	7.00		-		96575.02721
PLG75	16.80		-		96575.02722
PLG75	35.00		-	✓	96575.02723 DUN:9657502723
PLG75	100.00		-		96575.02724
PLG75	175.00		-		96575.02725
Without gear unit	-		-		96575.02799
Can be used with PDC600/PDC600F drive controller and PDC1000 V1 drive controller					
			Motor BG95x40 With brake E600 Voltage 24 V DC		Motor BG95x40 With brake E600 Voltage 48 V DC
PLG95	4.00		-		96595.02730
PLG95	16.80		-	✓	96595.02731 DUN:9659502731
Without gear unit	-		-		96595.02799
Can be used with PDC600/PDC600F drive controller and PDC1000 V1 drive controller					
			Motor BG95x80 With brake E600 Voltage 24 V DC		Motor BG95x80 With brake E600 Voltage 48 V DC
PLG95	4.00		-		96595.03130
PLG95	16.80		-		96595.03131
Without gear unit	-		-		96595.03199

SIMATIC MICRO-DRIVE drive system

Motors/gear units and connection systems from Siemens Product Partners

KnorrTec connection systems

Overview

- KnorrTec plug-in cables for SIMATIC MICRO-DRIVE
- Can be used for drives of the Siemens Product Partners Dunkermotoren and ebm-papst
- Versions for simple industrial applications:
 - Silicone-free
 - Flame resistance according to IEC 60332 (20 s)
 - Temperature range -30 ... +80 °C (not moving) or -5 ... +80 °C (moving)
- Designs for demanding industrial applications:
 - Highly flexible – suitable for cable carriers
 - Oil-resistant according to EN 60811-404
 - UL/CSA-listed components
 - Halogen-free
 - Silicone-free
 - UV-resistant
 - Generally good chemical resistance
 - Hydrolysis and microbe-resistant
 - Flame resistance according to UL758/1581 (horizontal + FT2) and EN 60332-2-2 (20 s)
 - Temperature range -45 ... +80 °C (not moving) or -25 ... +80 °C (moving)

Selection and ordering data

Plug-in cables for PDC Drives or TM Drives and Dunkermotoren motors

Plug-in cables with article numbers including the prefix "ZKT:" can be ordered directly from Siemens for quick configuration during the bidding phase.

Plug-in cables with article numbers without the prefix "ZKT:" can be ordered directly from the Product Partner.

Designation of the plug-in cable	Length m	For simple industrial applications		For demanding industrial applications in UL-listed materials		in UL-certified production	
		Preferred type	Product partner article no. Article No.	Preferred type	Product partner article no. Article No.	Preferred type	Product partner article no. Article No.
For connecting PDC100/PDC100F drive controllers and Dunkermotoren motors BG45x30 and BG65Sx50							
LAI01 All-in-one plug-in cable	0.5		70051000000050		70051020000050		70051070000050
	1.5		70051000000150		70051020000150		70051070000150
	3.0		70051000000300	✓	70051020000300 ZKT:70051020000300		70051070000300
	5.0		70051000000500		70051020000500		70051070000500
	10.0		70051000001000	✓	70051020001000 ZKT:70051020001000		70051070001000
	1)		70051000000000		70051020000000		70051070000000
For connecting PDC600/PDC600F drive controllers and PDC1000 V1 drive controllers and Dunkermotoren motors BG45x30 and BG65Sx50							
LAI010 All-in-one plug-in cable	0.5	-			70051920000050		70051970000050
	1.5	-			70051920000150		70051970000150
	3.0	-		✓	70051920000300 ZKT:70051920000300		70051970000300
	5.0	-			70051920000500		70051970000500
	10.0	-		✓	70051920001000 ZKT:70051920001000		70051970001000
	1)	-			70051920000000		70051970000000
For connecting F-TM ServoDrive ST/HF and Dunkermotoren motors BG45x30 and BG65Sx50							
CSD_LAI01 All-in-one plug-in cable	0.5	-			70056020000050		70056070000050
	1.5	-		✓	70056020000150 ZKT:70056020000150		70056070000150
	3.0	-			70056020000300		70056070000300
	5.0	-		✓	70056020000500 ZKT:70056020000500		70056070000500
	10.0	-			70056020001000		70056070001000
	1)	-			70056020000000		70056070000000

1) Customer specific length up to 10 m on request.

SIMATIC MICRO-DRIVE drive system

Motors/gear units and connection systems from Siemens Product Partners

KnorrTec connection systems

Selection and ordering data

Designation of the plug-in cable	Length m	For simple industrial applications		For demanding industrial applications in UL-listed materials		in UL-certified production	
		Pre-ferred type	Product partner article no. Article No.	Pre-ferred type	Product partner article no. Article No.	Pre-ferred type	Product partner article no. Article No.
For connecting PDC600/PDC600F drive controllers and PDC1000 V1 drive controllers and Dunkermotoren motors BG75x50							
LPMo1 Plug-in motor cable	0.5		7005110000050		7005112000050		7005117000050
	1.5		7005110000150		7005112000150		7005117000150
	3.0		7005110000300	✓	7005112000300 ZKT:70051120000300		7005117000300
	5.0		7005110000500		7005112000500		7005117000500
	10.0		70051100001000	✓	70051120001000 ZKT:70051120001000		70051170001000
	1) ¹⁾		70051100000000		70051120000000		70051170000000
For connecting PDC600/PDC600F drive controllers and PDC1000 V1 drive controllers and Dunkermotoren motors BG95x40 and BG95x80							
LPMo3 Plug-in motor cable	0.5		7005180000050		7005182000050		7005187000050
	1.5		7005180000150		7005182000150		7005187000150
	3.0		7005180000300	✓	7005182000300 ZKT:70051820000300		7005187000300
	5.0		7005180000500		7005182000500		7005187000500
	10.0		70051800001000	✓	70051820001000 ZKT:70051820001000		70051870001000
	1) ¹⁾		70051800000000		70051820000000		70051870000000
For connecting PDC600/PDC600F drive controllers and PDC1000 V1 drive controllers and Dunkermotoren motors BG75x50, BG95x40 and BG95x80							
LPEn1 Plug-in encoder cable	0.5		7005120000050		7005122000050		7005127000050
	1.5		7005120000150		7005122000150		7005127000150
	3.0		7005120000300	✓	7005122000300 ZKT:70051220000300		7005127000300
	5.0		7005120000500		7005122000500		7005127000500
	10.0		70051200001000	✓	70051220001000 ZKT:70051220001000		70051270001000
	1) ¹⁾		70051200000000		70051220000000		70051270000000
For connecting PDC100/PDC100F drive controllers, PDC600/PDC600F drive controllers and PDC1000 V1 drive controllers and all motors from Dunkermotoren							
LPBr1 Plug-in brake cable	0.5		7005130000050		7005132000050		7005137000050
	1.5		7005130000150		7005132000150		7005137000150
	3.0		7005130000300	✓	7005132000300 ZKT:70051320000300		7005137000300
	5.0		7005130000500		7005132000500		7005137000500
	10.0		70051300001000	✓	70051320001000 ZKT:70051320001000		70051370001000
	1) ¹⁾		70051300000000		70051320000000		70051370000000

1) Customer specific length up to 10 m on request.

SIMATIC MICRO-DRIVE drive system

Motors/gear units and connection systems from Siemens Product Partners

KnorrTec connection systems

Selection and ordering data

Plug-in cables for PDC Drives or TM Drives and motors from ebm-papst

Plug-in cables with article numbers including the prefix "ZKT:" can be ordered directly from Siemens for quick configuration during the bidding phase.

Plug-in cables with article numbers without the prefix "ZKT:" can be ordered directly from the Product Partner.

Designation of the plug-in cable	Length m	For simple industrial applications		For demanding industrial applications in UL-listed materials		in UL-certified production	
		Preferred type	Product partner article no. Article No.	Preferred type	Product partner article no. Article No.	Preferred type	Product partner article no. Article No.
For connecting PDC100/PDC100F drive controllers and ebm-papst motors ECI42.20, ECI42.40, ECI63.20, ECI63.40 and ECI63.60							
LAI02 All-in-one plug-in cable	0.5		7005140000050		7005142000050		7005147000050
	1.5		7005140000150		7005142000150		7005147000150
	3.0		7005140000300	✓	7005142000300 ZKT:70051420000300		7005147000300
	5.0		7005140000500		7005142000500		7005147000500
	10.0		70051400001000	✓	70051420001000 ZKT:70051420001000		70051470001000
	1) ¹⁾		70051400000000		70051420000000		70051470000000
For connecting PDC600/PDC600F drive controllers and PDC1000 V1 drive controllers and ebm-papst motors ECI42.20, ECI42.40, ECI63.20, ECI63.40 and ECI63.60							
LAI020 All-in-one plug-in cable	0.5	-			7005152000050		7005157000050
	1.5	-			7005152000150		7005157000150
	3.0	-		✓	7005152000300 ZKT:70051520000300		7005157000300
	5.0	-			7005152000500		7005157000500
	10.0	-		✓	70051520001000 ZKT:70051520001000		70051570001000
	1) ¹⁾	-			70051520000000		70051570000000
For connecting F-TM ServoDrive ST/HF and ebm-papst motors ECI42.20, ECI42.40, ECI63.20, ECI63.40 and ECI63.60							
CSD_LAI02 All-in-one plug-in cable	0.5	-			7005642000050		7005647000050
	1.5	-		✓	7005642000150 ZKT:70056420000150		7005647000150
	3.0	-			7005642000300		7005647000300
	5.0	-		✓	7005642000500 ZKT:70056420000500		7005647000500
	10.0	-			70056420001000		70056470001000
	1) ¹⁾	-			70056420000000		70056470000000
For connecting PDC600/PDC600F drive controllers and PDC1000 V1 drive controllers and ebm-papst motors ECI80.40 and ECI80.60							
LPMo3 Plug-in motor cable	0.5		7005180000050		7005182000050		7005187000050
	1.5		7005180000150		7005182000150		7005187000150
	3.0		7005180000300	✓	7005182000300 ZKT:70051820000300		7005187000300
	5.0		7005180000500		7005182000500		7005187000500
	10.0		70051800001000	✓	70051820001000 ZKT:70051820001000		70051870001000
	1) ¹⁾		70051800000000		70051820000000		70051870000000

¹⁾ Customer specific length up to 10 m on request.

Selection and ordering data

Designation of the plug-in cable	Length m	For simple industrial applications		For demanding industrial applications in UL-listed materials		in UL-certified production	
		Preferred type	Product partner article no. Article No.	Preferred type	Product partner article no. Article No.	Preferred type	Product partner article no. Article No.
For connecting PDC600/PDC600F drive controllers and PDC1000 V1 drive controllers and ebm-papst motors ECI80.40 and ECI80.60							
LPEn2 Plug-in encoder cable	0.5		7005160000050		7005162000050		7005167000050
	1.5		7005160000150		70051620000150		70051670000150
	3.0		7005160000300	✓	70051620000300 ZKT:70051620000300		70051670000300
	5.0		7005160000500		70051620000500		70051670000500
	10.0		70051600001000	✓	70051620001000 ZKT:70051620001000		70051670001000
	1) ¹⁾		70051600000000		70051620000000		70051670000000
For connecting PDC100/PDC100F drive controllers, PDC600/PDC600F drive controllers and PDC1000 V1 drive controllers and all motors from ebm-papst							
LPBr2 Plug-in brake cable	0.5		7005170000050		7005172000050		7005177000050
	1.5		70051700000150		70051720000150		70051770000150
	3.0		70051700000300	✓	70051720000300 ZKT:70051720000300		70051770000300
	5.0		70051700000500		70051720000500		70051770000500
	10.0		700517000001000	✓	700517200001000 ZKT:700517200001000		700517700001000
	1) ¹⁾		70051700000000		70051720000000		70051770000000

1) Customer specific length up to 10 m on request.

SIMATIC MICRO-DRIVE drive system

Motors/gear units and connection systems from Siemens Product Partners

Harting connection systems

Overview

- HARTING plug-in cables for SIMATIC MICRO-DRIVE
- Can be used for drives of the Siemens Product Partners Dunkermotoren and ebm-papst
- Versions for simple industrial applications:
 - Silicone-free, virtually oil-resistant
 - Flame resistance according to IEC 60332-1 (20 s)
 - Temperature range -30 ... +80 °C (not moving) or -5 ... +80 °C (moving)
- Designs for demanding industrial applications:
 - Highly flexible – suitable for cable carriers
 - Oil-resistant according to EN 60811-404
 - UL/CSA-certified
 - Halogen-free
 - Silicone-free
 - UV-resistant
 - Generally good chemical resistance
 - Hydrolysis and microbe-resistant
 - Flame resistance according to UL758/1581 (horizontal + FT2) and EN 60332-2-2 (20 s)
 - Temperature range -40 ... +80 °C (not moving) or -25 ... +80 °C (moving)

Selection and ordering data

Plug-in cables for PDC Drives or TM Drives and Dunkermotoren motors

Designation of the plug-in cable	Length m	Preferred type	For simple industrial applications	For demanding industrial applications in UL-certified production
			Product partner article no.	Product partner article no.
For connecting PDC100/PDC100F drive controllers and Dunkermotoren motors BG45x30 and BG65Sx50				
LAI01 All-in-one plug-in cable	0.5		6172010050	6172020050
	1.5		6172010150	6172020150
	3.0		6172010300	6172020300
	5.0		6172010500	6172020500
	10.0		6172011000	6172021000
	1) ¹⁾		617201xxxx	617202xxxx
For connecting PDC600/PDC600F drive controllers and PDC1000 V1 drive controllers and Dunkermotoren motors BG45x30 and BG65Sx50				
LAI010 All-in-one plug-in cable	0.5		-	6172240050
	1.5		-	6172240150
	3.0		-	6172240300
	5.0		-	6172240500
	10.0		-	6172241000
	1) ¹⁾		-	on request
For connecting F-TM ServoDrive ST/HF and Dunkermotoren motors BG45x30 and BG65Sx50				
CSD-LAI01 All-in-one plug-in cable	0.5		6172500050	6172510050
	1.5		6172500150	6172510150
	3.0		6172500300	6172510300
	5.0		6172500500	6172510500
	10.0		6172501000	6172511000
	1) ¹⁾		on request	on request
For connecting PDC600/PDC600F drive controllers and PDC1000 V1 drive controllers and Dunkermotoren motors BG75x50				
LPMo1 Plug-in motor cable	0.5		6172030050	6172040050
	1.5		6172030150	6172040150
	3.0		6172030300	6172040300
	5.0		6172030500	6172040500
	10.0		6172031000	6172041000
	1) ¹⁾		617203xxxx	617204xxxx

¹⁾ Customer specific length up to 10 m on request.

SIMATIC MICRO-DRIVE drive system

Motors/gear units and connection systems from Siemens Product Partners

Harting connection systems**Selection and ordering data**

Designation of the plug-in cable	Length m	Preferred type	For simple industrial applications	For demanding industrial applications in UL-certified production
			Product partner article no.	Product partner article no.
For connecting PDC600/PDC600F drive controllers and PDC1000 V1 drive controllers and Dunkermotoren motors BG95x40 and BG95x80				
LPMo3 Plug-in motor cable	0.5		6172090050	6172100050
	1.5		6172090150	6172100150
	3.0		6172090300	6172100300
	5.0		6172090500	6172100500
	10.0		6172091000	6172101000
	1) ¹⁾		617209xxxx	617210xxxx
For connecting PDC600/PDC600F drive controllers and PDC1000 V1 drive controllers and Dunkermotoren motors BG75x50, BG95x40 and BG95x80				
LPEn1 Plug-in encoder cable	0.5		6172050050	6172060050
	1.5		6172050150	6172060150
	3.0		6172050300	6172060300
	5.0		6172050500	6172060500
	10.0		6172051000	6172061000
	1) ¹⁾		617205xxxx	617206xxxx
For connecting PDC100/PDC100F drive controllers, PDC600/PDC600F drive controllers and PDC1000 V1 drive controllers and all motors from Dunkermotoren				
LPBr1 Plug-in brake cable	0.5		6172070050	6172080050
	1.5		6172070150	6172080150
	3.0		6172070300	6172080300
	5.0		6172070500	6172080500
	10.0		6172071000	6172081000
	1) ¹⁾		617207xxxx	617208xxxx

1) Customer specific length up to 10 m on request.

SIMATIC MICRO-DRIVE drive system

Motors/gear units and connection systems from Siemens Product Partners

Harting connection systems

Selection and ordering data

Plug-in cables for PDC Drives or TM Drives and motors from ebm-papst

Designation of the plug-in cable	Length m	Preferred type	For simple industrial applications	For demanding industrial applications
			Product partner article no.	Product partner article no.
For connecting PDC100/PDC100F drive controllers and ebm-papst motors ECI42.20, ECI42.40, ECI63.20, ECI63.40 and ECI63.60				
LAIQ2 All-in-one plug-in cable	0.5		6172110050	6172120050
	1.5		6172110150	6172120150
	3.0		6172110300	6172120300
	5.0		6172110500	6172120500
	10.0		6172111000	6172121000
	1) ¹⁾		617211xxxx	617212xxxx
For connecting PDC600/PDC600F drive controllers and PDC1000 V1 drive controllers and ebm-papst motors ECI42.20, ECI42.40, ECI63.20, ECI63.40 and ECI63.60				
LAIQ20 All-in-one plug-in cable	0.5		-	6172260050
	1.5		-	6172260150
	3.0		-	6172260300
	5.0		-	6172260500
	10.0		-	6172261000
	1) ¹⁾		-	on request
For connecting F-TM ServoDrive ST/HF and ebm-papst motors ECI42.20, ECI42.40, ECI63.20, ECI63.40 and ECI63.60				
CSD_LAIQ2 All-in-one plug-in cable	0.5		6172520050	6172530050
	1.5		6172520150	6172530150
	3.0		6172520300	6172530300
	5.0		6172520500	6172530500
	10.0		6172521000	6172531000
	1) ¹⁾		on request	on request
For connecting PDC600/PDC600F drive controllers and PDC1000 V1 drive controllers and ebm-papst motors ECI80.40 and ECI80.60				
LPEn2 Plug-in encoder cable	0.5		6172150050	6172160050
	1.5		6172150150	6172160150
	3.0		6172150300	6172160300
	5.0		6172150500	6172160500
	10.0		6172151000	6172161000
	1) ¹⁾		617215xxxx	617216xxxx
For connecting PDC100/PDC100F drive controllers, PDC600/PDC600F drive controllers and PDC1000 V1 drive controllers and all motors from ebm-papst				
LPBr2 Plug-in brake cable	0.5		6172170050	6172180050
	1.5		6172170150	6172180150
	3.0		6172170300	6172180300
	5.0		6172170500	6172180500
	10.0		6172171000	6172181000
	1) ¹⁾		617217xxxx	617218xxxx

1) Customer specific length up to 10 m on request.

Overview

The TIA Selection Tool is available for selecting the individual drive components. Drive dimensioning can also be carried out Functions in the TIA Selection Tool

there with program support, comparable to the SIZER engineering tool.

You can find information about the TIA Selection Tool at: www.siemens.com/tst

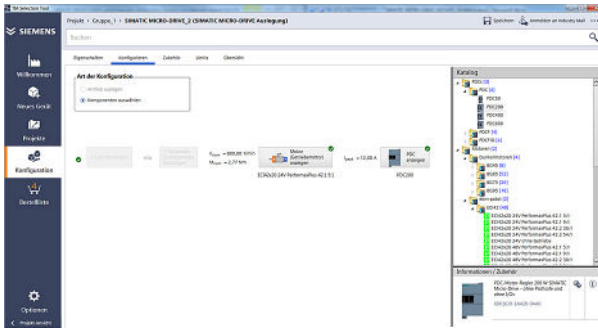

Component selection – Axis overview of the selected components

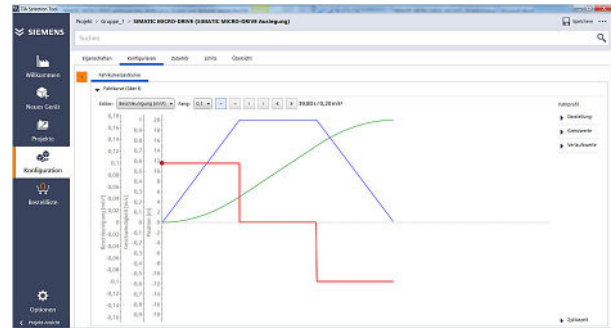

Dimensioning – Traversing profile editor with graphical and tabular input

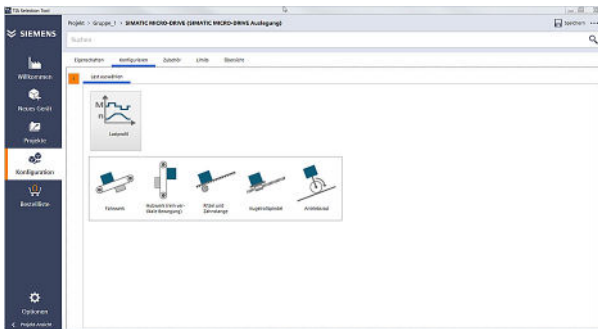

Dimensioning – Selection of the application

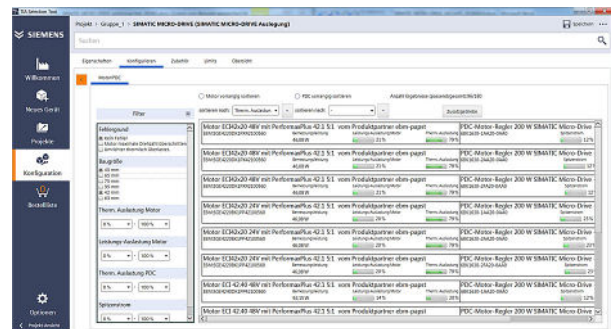

Dimensioning – Selection and filtering of the right combination of motor and PDC Drives

2

SIMATIC MICRO-DRIVE Antriebssystem

Services and documentation

SITRAIN – Digital Industry Academy

Introduction

2



SITRAIN – DIGITAL INDUSTRY ACADEMY
The Future of Learning starts **now**

SITRAIN - Digital Industry Academy stands for a modern learning culture that focuses on the needs of learners and the demands of innovative companies.

SITRAIN offers a comprehensive range of knowledge on Siemens industrial products and, under the vision "Future of Learning", pursues a holistic approach that combines different forms and methods of learning. Different learning formats allow for more effective, flexible and continuous learning depending on the type of learning.

Education and training directly from the manufacturer



Industrial Automation Systems SIMATIC

Training available for: SIMATIC S7-1500, TIA Portal, SIMATIC S7-300/400, SIMATIC S7-1200



Drive Technology

Training available for: SINAMICS S120 and SINAMICS G120 low-voltage converters, SINAMICS G130 / G150 / G180 / S150



SINUMERIK CNC automation system

Training available for: SINUMERIK 840D, SINUMERIK 840D sl and SINUMERIK ONE



Process Control Systems

Training available for: SIMATIC PCS 7, SIMATIC PCS neo



Digital Enterprise

Training available for: Openness, SIMIT, OPC UA, Industrial Edge, Virtual commissioning



Industrial Communications

Training available for: PROFINET, SCALANCE, RUGGEDOM, Industrial Ethernet, Fieldbus communication, Industrial Security, Remote communication

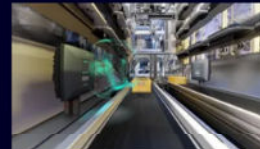

Identification and Locating

Training available for: RFID, RTLS-Systems



Operator Control and Monitoring Systems

Training available for: SIMATIC WinCC Unified in TIA Portal, SIMATIC WinCC in TIA Portal, SIMATIC WinCC V7x



Motion Control System SIMOTION

Training available for: SIMOTION (Programming, Commissioning, Diagnostics, Service)



Smart Infrastructure

Training available for: SIRIUS, SENTRON, SIVACON, ALPHA, SIMOCODE, Circuit breakers



Process Analytics & Instrumentation

Training is available for process analytics and instrumentation, explosion protection, process gas chromatographs



Additional training offer

SIMOVE with Automated Guided Vehicles (AGV), SIPLUS CMS, Guidelines and standards for control cabinets

Introduction

Different learning formats and methods for maximum learning success

Face-to-face training in the training center or in the virtual classroom, with fixed dates and course times, learning in a group with a learning guide? Or digital training, on your own responsibility and location-independent, on demand, 24/7?

With the learning formats "Learning Journey", "Learning Membership" and "Learning Event", SITRAIN offers a wide range of different learning options in connection with didactically effective methods and modular possibilities.

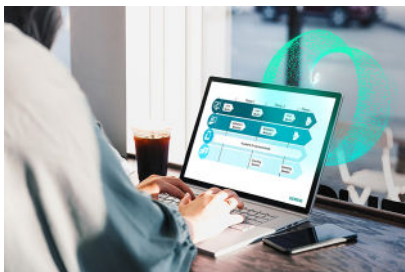

Learning Journey

The combination for sustainable learning success

- The optimal mix of self-study units and guided live modules
- Includes a Learning Membership to work through the self-study modules and access on-demand content
- The SITRAIN learning consultant is available for questions and one-on-one consultations
- Ideal integration into the daily work routine and adaptation to one's own learning pace.



Learning Membership

Securing knowledge through continuous learning on your own responsibility

- With access to the comprehensive and constantly growing range of self-study units on SITRAIN access, the digital learning platform
- Search and find specific learning content or simply have a look around – anytime and anywhere
- A modern learning culture through continuous learning on your own responsibility and transparency about your learning success in the team or company.



Learning Event

Acquire theoretical and practical knowledge in a compact and guided format

- You achieve a defined learning goal in the shortest possible time
- The learning consultant guides you through the practical exercises and is also exclusively available to you during the theoretical sessions for the entire duration
- Focused learning, outside of the daily work routine, in a protected learning environment – virtually, in the training center, or at your company.



Live

Learn together with others, simultaneously and guided by a learning consultant. Online, in the SITRAIN training center or at your company.



Self-reliant

Expand your knowledge self-determined with industry learning and work on your learning units at your own pace and according to your own schedule.



On demand

Get the knowledge you need, exactly when you need it. Be it to answer a current question or to work on a special topic.



Individuell

Talk directly with the learning consultant, clarify detailed questions and get personal coaching for transferring the learned topics to your own application.



Training cases catalog

<https://www.siemens.com/sitRAIN-catalog-training-cases>

Find your local offer here



SITRAIN – Digital Industry Academy worldwide

You will find the regional knowledge offer in the country selection. One click will take you to the corresponding website.

SIMATIC MICRO-DRIVE drive system

Services and documentation

SIMATIC MICRO-DRIVE training case

Overview



SIMATIC MICRO-DRIVE, training case, advanced version with F-TM ServoDrive ST

The SIMATIC MICRO-DRIVE training case is a convincing demonstration system thanks to its compact design.

It is suitable for direct customer presentations as well as for tests in technical departments. It enables the functions of SIMATIC MICRO-DRIVE to be demonstrated and tested quickly and easily.

The SIMATIC MICRO-DRIVE training case contains the following components:

- F-TM ServoDrive ST
- PDC Drives, PDC100F variant
- ebm-papst ECI42.20 motor, with angle disc, without gear unit, without brake
- KnorrTec cable
- 4 buttons for digital inputs and 2 LED lamps for digital outputs for PDC100F
- Prepared for S7-1500 PLC.

The SIMATIC MICRO-DRIVE training case is supplied in the form of a stackable Tanos Systainer case.

Technical specifications

SIMATIC MICRO-DRIVE training case	6AG1067-2AA00-0AE0
Supply voltage	110 ... 220 V AC
Dimensions	
• Width	210 mm
• Height	270 mm
• Depth	380 mm
Weight, approx.	11 kg

Selection and ordering data

SIMATIC MICRO-DRIVE training case	
Variant	Article No.
SIMATIC MICRO-DRIVE training case including PDC Drives, PDC100F variant and F-TM ServoDrive ST bundle	6AG1067-2AA00-0AE0

SIMATIC F-TM ServoDrive Starter Kit

Overview

The SIMATIC F-TM ServoDrive ST Starter Kit with Article No. 6BK1637-6AB00-0BU0 includes

- SIMATIC MICRO-DRIVE F-TM ServoDrive ST
- SIMATIC ET 200SP PROFINET IM 155-6PN ST Interface Module
- SIMATIC ET 200SP BaseUnit type U0
- All-in-one plug-in cable CSD_LAiO2, length 1.5 m
- ebm-papst motor ECI42.20 24 V

Selection and ordering data

Description	Article No.
SIMATIC F-TM ServoDrive ST Starter Kit	6BK1637-6AB00-0BU0
Scope of supply:	
• SIMATIC MICRO-DRIVE F-TM ServoDrive ST	
• SIMATIC ET 200SP PROFINET IM 155-6PN ST Interface Module	
• SIMATIC ET 200SP BaseUnit type U0	
• All-in-one plug-in cable CSD_LAiO2, length 1.5 m	
• ebm-papst motor ECI42.20 24 V	

SIMATIC MICRO-DRIVE documentation

Overview

The operating instructions for SIMATIC MICRO-DRIVE are available free of charge on the internet at:

www.siemens.com/micro-drive/documentation

Detailed information on the SIMATIC MICRO-DRIVE drive system, including the latest technical documentation (brochures, tutorials, dimensional drawings, certificates, equipment manuals and operating instructions), is available on the internet at:

www.siemens.com/micro-drive

and also via the TIA Selection Tool:

www.siemens.com/tia-selection-tool

Appendix



3/2	Partners
3/3	Industry Services
3/4	Industry Services – Portfolio overview
3/6	Online Support
3/7	Conditions of sale and delivery

Appendix

Partners

Partners at Siemens

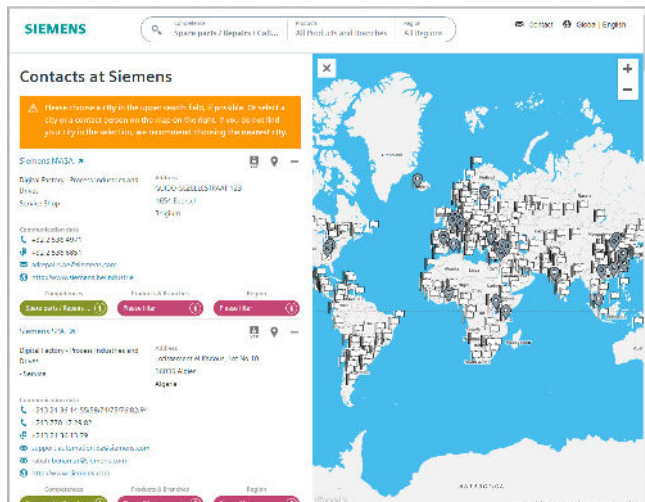

At your service locally, around the globe for consulting, sales, training, service, support, spare parts on the entire portfolio of Siemens.

Your partner can be found in our Personal Contacts Database at: www.siemens.com/automation-contact

You start by selecting

- the required competence,
- products and branches,
- a country and a city

or by a

- location search or free text search.

3

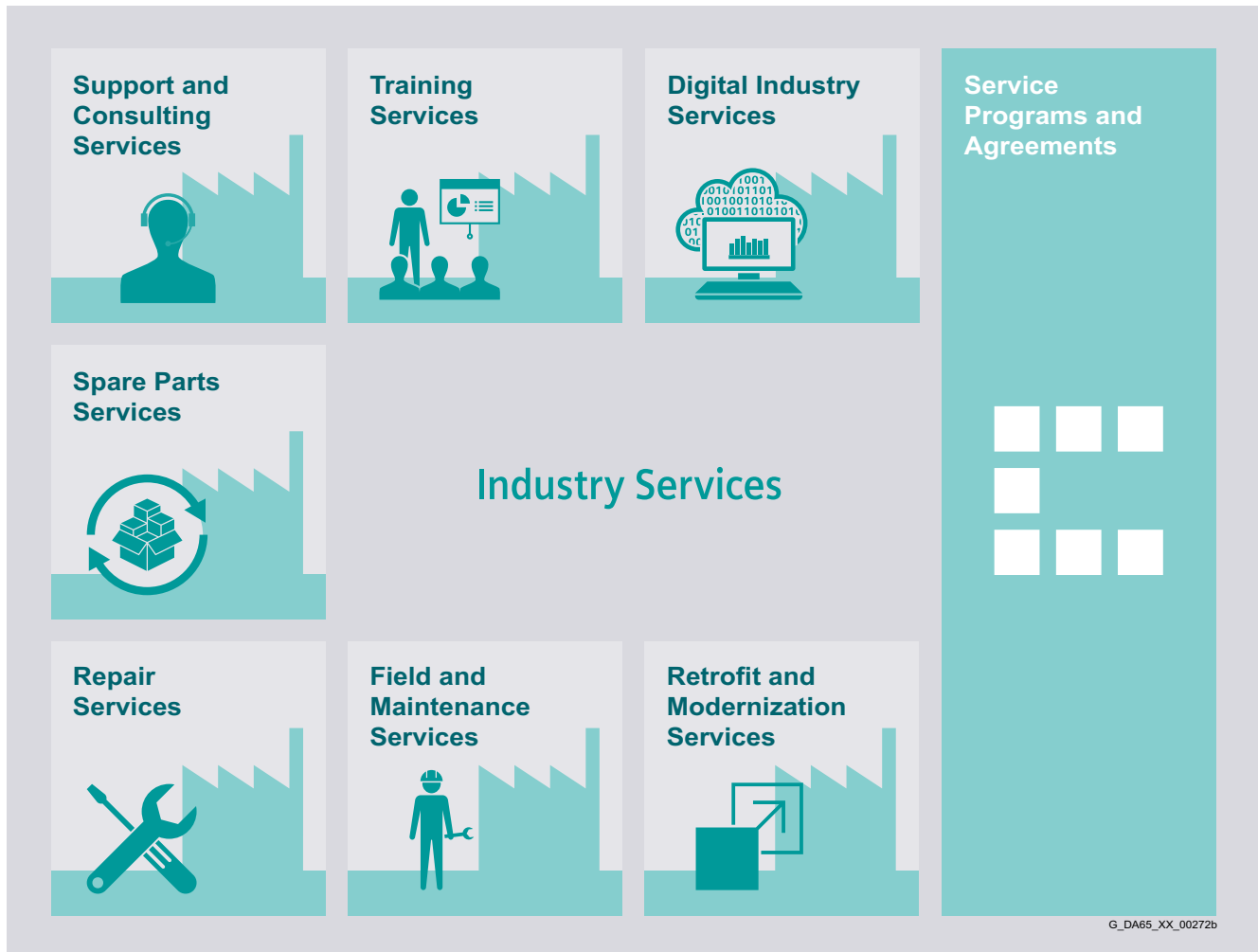
Overview

3

Keep your business running and shaping your digital future – with Industry Services

Optimizing the productivity of your equipment and operations can be a challenge, especially with constantly changing market conditions. Working with our service experts makes it easier. We understand your industry's unique processes and provide the services needed so that you can better achieve your business goals.

You can count on us to maximize your uptime and minimize your downtime, increasing your operations' productivity and reliability. When your operations have to be changed quickly to meet a new demand or business opportunity, our services give you the flexibility to adapt. Of course, we take care that your production is protected against cyber threats. We assist in keeping your operations as energy and resource efficient as possible and reducing your total cost of ownership. As a trendsetter, we ensure that you can capitalize on the opportunities of digitalization and by applying data analytics to enhance decision making: You can be sure that your plant reaches its full potential and retains this over the longer lifespan.

You can rely on our highly dedicated team of engineers, technicians and specialists to deliver the services you need – safely, professionally and in compliance with all regulations. We are there for you, where you need us, when you need us.

www.siemens.com/industryservices

Appendix

Industry Services

Industry Services – Portfolio overview

Overview

Digital Industry Services



Digital Industry Services make your industrial processes transparent to gain improvements in productivity, asset availability, and energy efficiency.

Production data is generated, filtered and translated with intelligent analytics to enhance decision-making.

This is done whilst taking data security into consideration and with continuous protection against cyber-attack threats.

www.siemens.com/global/en/products/services/industry/digital-industry-services.html

Support and Consulting Services



Industry Online Support site for comprehensive information, application examples, FAQs and support requests.

Technical and Engineering Support for advice and answers for all inquiries about functionality, handling, and fault clearance. The Service Card as prepaid support for value added services such as Priority Call Back or Extended Support offers the clear advantage of quick and easy purchasing.

Information & Consulting Services, e.g. SIMATIC System Audit; clarity about the state and service capability of your automation system or Lifecycle Information Services; transparency on the lifecycle of the products in your plants.

<https://support.industry.siemens.com/cs/ww/en/sc/2235>

Training Services



From the basics and advanced to specialist skills, SITRAIN courses provide expertise right from the manufacturer – and encompass the entire spectrum of Siemens products and systems for the industry.

Worldwide, SITRAIN courses are available wherever you need a training course in more than 170 locations in over 60 countries.

<https://support.industry.siemens.com/cs/ww/en/sc/2226>

Spare Parts Services



Spare Parts Services are available worldwide for smooth and fast supply of spare parts – and thus optimal plant availability. Genuine spare parts are available for up to ten years. Logistic experts take care of procurement, transport, custom clearance, storage and order management. Reliable logistics processes ensure that components reach their destination as needed.

Since not all spare parts can be kept in stock at all times, Siemens offers a preventive measure for spare parts provisioning on the customer's premises with optimized **Spare Parts Packages** for individual products, custom-assembled drive components and entire integrated drive trains – including risk consulting.

Asset Optimization Services help you design a strategy for parts supply where your investment and carrying costs are reduced and the risk of obsolescence is avoided.

<https://support.industry.siemens.com/cs/ww/en/sc/2110>

Overview (continued)

Repair Services



Repair Services are offered on-site and in regional repair centers for fast restoration of faulty devices' functionality.

Also available are extended repair services, which include additional diagnostic and repair measures, as well as emergency services.

<https://support.industry.siemens.com/cs/ww/en/sc/2154>

Retrofit and Modernization Services



Provide a cost-effective solution for the expansion of entire plants, optimization of systems or upgrading existing products to the latest technology and software, e.g. migration services for automation systems.

Service experts support projects from planning through commissioning and, if desired over the entire extended lifespan, e.g. Retrofit for Integrated Drive Systems for an extended lifetime of your machines and plants.

<https://support.industry.siemens.com/cs/ww/en/sc/2286>

Field and Maintenance Services



Siemens specialists are available globally to provide expert field and maintenance services, including commissioning, functional testing, preventive maintenance and fault clearance. All services can be included in customized service agreements with defined reaction times or fixed maintenance intervals.

<https://support.industry.siemens.com/cs/ww/en/sc/2265>

Service Programs and Agreements



A technical Service Program or Agreement enables you to easily bundle a wide range of services into a single annual or multi-year agreement.

You pick the services you need to match your unique requirements or fill gaps in your organization's maintenance capabilities.

Programs and agreements can be customized as KPI-based and/or performance-based contracts.

<https://support.industry.siemens.com/cs/ww/en/sc/2275>

Appendix

Industry Services

Online Support

Overview

Online Support – fast, intuitive, whenever you want, wherever you need

Web

www.siemens.com/online-support

App



Scan the QR code for information on our Online Support app.



FAQ / Application examples

Information about industrial products, programming and configuration as well as application examples



Technical information

Videos, documentation, manuals, updates, product notes, compatibility tool, certificates, planning data such as dimensional drawings, product data, 3D models



Forum

Exchange information and experience with other users and experts

Online Support for Siemens Industry Products

Siemens Industry and Online Support with some 1.7 million visitors per month is one of the most popular web services provided by Siemens. It is the central access point for comprehensive technical know-how about products, systems and services for automation and drives applications as well as for process industries.

In connection with the challenges and opportunities related to digitalization you can look forward to continued support with innovative offerings.

1. General Provisions

By using this catalog you can purchase products (hardware, software and services) described therein from Siemens Aktiengesellschaft subject to the following Terms and Conditions of Sale and Delivery (hereinafter referred to as "T&C"). Please note that the scope, the quality and the conditions for supplies and services, including software products, by any Siemens entity having a registered office outside Germany, shall be subject exclusively to the General Terms and Conditions of the respective Siemens entity. The following T&C apply exclusively for orders placed with Siemens Aktiengesellschaft, Germany.

1.1 For customers with a seat or registered office in European Union

For customers with a seat or registered office in European Union, the following terms and conditions apply subordinate to T&C:

- for products, which include specific terms and conditions in the description text, these specific terms and conditions shall apply and subordinate thereto,
- for stand-alone software products and software products forming a part of a product or project, the "General License Conditions for Software Products for Automation and Drives for Customers with a Seat or registered Office in Germany"¹⁾ and/or
- for consulting services the "Allgemeine Geschäftsbedingungen für Beratungsleistungen der Division DF – Deutschland" (available only in German) and/or
- for other services, the „Supplementary Terms and Conditions for Services ("BL")"¹⁾ and/or
- for other supplies the "General Conditions for the Supply of Products and Services of the Electrical and Electronics Industry"¹⁾.

In case such supplies should contain Open Source Software, the conditions of which shall prevail over the "General Conditions for the Supply of Products and Services of the Electrical and Electronics Industry"¹⁾, a notice will be contained in the scope of delivery in which the applicable conditions for Open Source Software are specified. This shall apply mutatis mutandis for notices referring to other third party software components.

1.2 For customers with a seat or registered office outside European Union

For customers with a seat or registered office outside European Union, the following terms and conditions apply subordinate to T&C:

- for products, which include specific terms and conditions in the description text, these specific terms and conditions shall apply and subordinate thereto,
- for consulting services the "Standard Terms and Conditions for Consulting Services of the Division DF for Customers with a Seat or Registered Office Outside of Germany"¹⁾ and/or
- for other services the "International Terms & Conditions for Services"¹⁾ supplemented by "Software Licensing Conditions"¹⁾ and/or
- for other supplies of hard- and software the "International Terms & Conditions for Products"¹⁾ supplemented by "Software Licensing Conditions"¹⁾

1.3 For customers with master or framework agreement

To the extent our supplies and/or services offered are covered by an existing master or framework agreement, the terms and conditions of that agreement shall apply instead of T&C.

2. Prices

The prices are in € (Euro) ex point of delivery, exclusive of packaging.

The sales tax (value added tax) is not included in the prices. It shall be charged separately at the respective rate according to the applicable statutory legal regulations.

Prices are subject to change without prior notice. We will charge the prices valid at the time of delivery.

To compensate for variations in the price of raw materials (e.g. silver, copper, aluminum, lead, gold, dysprosium and neodym), surcharges are calculated on a daily basis using the so-called metal factor for products containing these raw materials.

A surcharge for the respective raw material is calculated as a supplement to the price of a product if the basic official price of the raw material in question is exceeded.

The metal factor of a product indicates the basic official price (for those raw materials concerned) as of which the surcharges on the price of the product are applied, and with what method of calculation.

An exact explanation of the metal factor can be downloaded at: https://mall.industry.siemens.com/legal/ww/en/terms_of_trade_en.pdf

To calculate the surcharge (except in the cases of dysprosium and neodym), the official price from the day prior to that on which the order was received or the release order was effected is used.

To calculate the surcharge applicable to dysprosium and neodym ("rare earths"), the corresponding three-month basic average price in the quarter prior to that in which the order was received or the release order was effected is used with a one-month buffer (details on the calculation can be found in the explanation of the metal factor).

3. Additional Terms and Conditions

The dimensions are in mm. In Germany, according to the German law on units in measuring technology, data in inches apply only to devices for export.

Illustrations are not binding.

Insofar as there are no remarks on the individual pages of this catalog – especially with regard to data, dimensions and weights given – these are subject to change without prior notice.

¹⁾ The text of the Terms and Conditions of Siemens AG can be downloaded at https://mall.industry.siemens.com/legal/ww/en/terms_of_trade_en.pdf

Appendix

Conditions of sale and delivery

4. Export Regulations

We shall not be obligated to fulfill any agreement if such fulfillment is prevented by any impediments arising out of national or international foreign trade or customs requirements or any embargoes and/or other sanctions.

Export may be subject to license. We shall indicate in the delivery details whether licenses are required under German, European and US export lists.

Our products are controlled by the U.S. Government (when labeled with "ECCN" unequal "N") and authorized for export only to the country of ultimate destination for use by the ultimate consignee or end-user(s) herein identified. They may not be resold, transferred, or otherwise disposed of, to any other country or to any person other than the authorized ultimate consignee or end-user(s), either in their original form or after being incorporated into other items, without first obtaining approval from the U.S. Government or as otherwise authorized by U.S. law and regulations. Products labeled with "AL" unequal "N" are subject to European / national export authorization.

The export indications can be viewed in advance in the description of the respective goods on the Industry Mall, our online catalog system. Only the export labels "AL" and "ECCN" indicated on order confirmations, delivery notes and invoices are authoritative.

Products without label, with label "AL:N" / "ECCN:N", or label "AL:9X9999" / "ECCN: 9X9999" may require authorization from responsible authorities depending on the final end-use, or the destination.

If you transfer goods (hardware and/or software and/or technology as well as corresponding documentation, regardless of the mode of provision) delivered by us or works and services (including all kinds of technical support) performed by us to a third party worldwide, you shall comply with all applicable national and international (re-)export control regulations. In any event of such transfer of goods, works and services you shall comply with the (re-) export control regulations of the Federal Republic of Germany, of the European Union and of the United States of America.

Prior to any transfer of goods, works and services provided by us to a third party you shall in particular check and guarantee by appropriate measures that

- there will be no infringement of an embargo imposed by the European Union, by the United States of America and/ or by the United Nations by such transfer, by brokering of contracts concerning those goods, works and services or by provision of other economic resources in connection with those goods, works and services, also considering the limitations of domestic business and prohibitions of by-passing those embargoes;
- such goods, works and services are not intended for use in connection with armaments, nuclear technology or weapons, if and to the extent such use is subject to prohibition or authorization, unless required authorization is provided;
- the regulations of all applicable Sanctioned Party Lists of the European Union and the United States of America concerning the trading with entities, persons and organizations listed therein are considered.

If required to enable authorities or us to conduct export control checks, you, upon request by us, shall promptly provide us with all information pertaining to the particular end customer, the particular destination and the particular intended use of goods, works and services provided by us, as well as any export control restrictions existing.

You acknowledge that under the EU embargo regulations against Iran, Syria and Russia respectively the sale of certain listed goods and related services is subject to authorization by the competent export control authorities of the European Union. If (i) the goods or services ordered by you are destined for Iran, Syria or Russia, and (ii) the contract for our supplies and/or services is subject to prior authorization of the competent export control authorities of the European Union, the contract between you and us shall come into force in this respect only upon granting of such authorization.

The products listed in this catalog may be subject to European/German and/or US export regulations. Any export requiring approval is therefore subject to authorization by the relevant authorities.

Errors excepted and subject to change without prior notice.

Selection and ordering at Siemens SiePortal – Ordering products and downloading catalogs

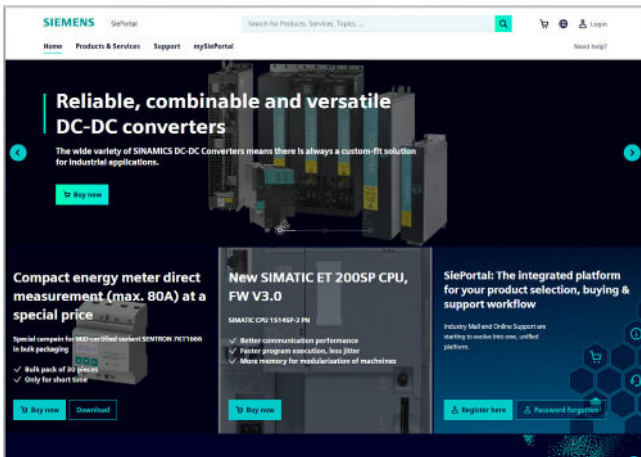

Easy product selection and ordering with SiePortal

SiePortal > Products & Services

The internet ordering platform of Siemens AG is located in SiePortal. It provides you with online access to a comprehensive product spectrum that is presented in an informative, well-organized way.

Powerful search functions help you select the required products, while configurators enable you to configure complex product and system components quickly and easily. CAX data are also available for you to use.

Data transfer allows the entire procedure, from selection through ordering to tracking and tracing, to be carried out online. Availability checks, individual customer discounting, and quotation preparation are also possible.

<https://sieportal.siemens.com>

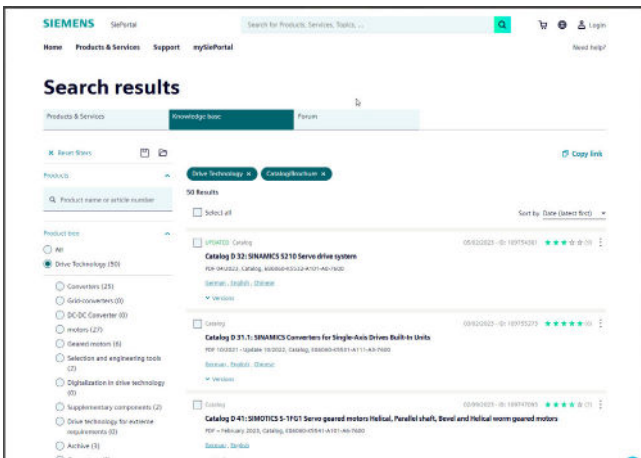

Downloading catalogs

SiePortal > Support > Knowledge base

You can download catalogs and brochures in PDF format from Siemens Industry Online Support without having to register.

The filter box makes it possible to perform targeted searches.

<https://sieportal.siemens.com>

Get more information

SIMATIC MICRO-DRIVE drive system:

www.siemens.com/micro-drive

Motion Control Systems and Solutions for production machine and machine tool equipment:

www.siemens.com/motioncontrol

Local partners worldwide:

www.siemens.com/automation-contact

Published by
Siemens AG

Digital Industries
Motion Control
Postfach 31 80
91050 Erlangen, Germany

For the U.S. published by
Siemens Industry Inc.

100 Technology Drive
Alpharetta, GA 30005
United States

PDF (E86060-K5534-A101-A3-7600)
V6.MKKATA.GMC.190
KG 0723 68 En
Produced in Germany
© Siemens 2023

Security information

Siemens provides products and solutions with industrial security functions that support the secure operation of plants, systems, machines and networks.

In order to protect plants, systems, machines and networks against cyber threats, it is necessary to implement – and continuously maintain – a holistic, state-of-the-art industrial security concept.

Siemens' products and solutions constitute one element of such a concept.

Customers are responsible for preventing unauthorized access to their plants, systems, machines and networks. Such systems, machines and components should only be connected to an enterprise network or the internet if and to the extent such a connection is necessary and only when appropriate security measures (e.g. firewalls and/or network segmentation) are in place.

For additional information on industrial security measures that may be implemented, please visit <https://www.siemens.com/industrialsecurity>

Siemens' products and solutions undergo continuous development to make them more secure. Siemens strongly recommends that product updates are applied as soon as they are available and that the latest product versions are used. Use of product versions that are no longer supported, and failure to apply the latest updates may increase customer's exposure to cyber threats.

To stay informed about product updates, subscribe to the Siemens Industrial Security RSS Feed under <https://www.siemens.com/cert>

Subject to changes and errors. The information given in this document only contains general descriptions and/or performance features which may not always specifically reflect those described, or which may undergo modification in the course of further development of the products. The requested performance features are binding only when they are expressly agreed upon in the concluded contract.

All product designations may be trademarks or product names of Siemens AG or other companies whose use by third parties for their own purposes could violate the rights of the owners.