

PLC / DCS System Cabling & Migration Solutions

Version 2022



Orange Selection

Quick and easy planning

As a planning engineer, do you want to select products easily and receive them quickly? From a partner you can rely on? Then plan with the Orange Selection from Weidmüller in the future. The Orange Selection items are always available, carefully selected and the portfolio consists of more than 1,500 items to fully cover your standard needs.

If your order is placed before 3:00 pm, we guarantee that your order will be on its way the very next working day.

For even more efficient planning and production processes, we will of course provide all articles in digital form. CAD, ETIM and eClass data are available in our online product catalogue **catalog.weidmueller.com**

We have summarised all the advantages of the Orange Selection on our website.

Check it out: **www.weidmueller.com/orange-selection**



PLC / DCS System Cabling & Migration Solutions

Catalogue 4.5

PLC / DCS System Cabling & Migration Solutions

Universal solutions for PLC input/output cards

Dedicated solution for Honeywell C300

Interface units for Yokogawa CS3000 and ProSafe

Passive interfaces for general applications

Isolated Interfaces and solutions for general applications

Pre-assembled cables for general applications

Migration Systems

Card holders

Appendix

Service and Support

Index

Index Type / Index Order No.

PLC / DCS System Cabling & Migration Solutions

RS IO
Page A.39

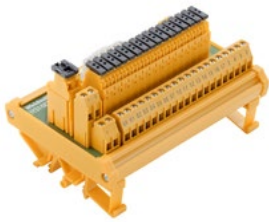

- Passive interfaces for digital input/outputs for PLCs
- Ribbon cable connection 20 pole 1-2-3 wires
- With LED, fuses, disconnecter
- Screw or tension clamp connection

RS A
Page A.53



- Passive interfaces for analogue input/output for PLCs
- Connection connector SUB-D
- With disconnection by channel and test points
- Screw or tension clamp connection

RSM
Page A.58



- Isolated digital inputs interfaces for PLCs
- Ribbon connection cable 20 pole
- Screw or tension clamp connection

RSM
Page A.62



- Isolated interfaces for digital outputs for PLCs
- Ribbon connection cable 20 pole
- With narrow 6 mm relay or standard RCL
- Screw, tension clamp and PUSH IN connection

FTA-C300
Page B.5

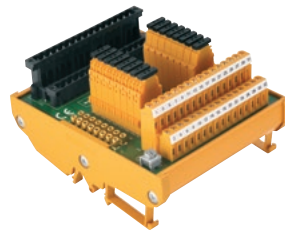

- Passive input/output interfaces for Honeywell C300
- Screw or tension clamp connection

FTA-C300-RSLIM
Page B.12

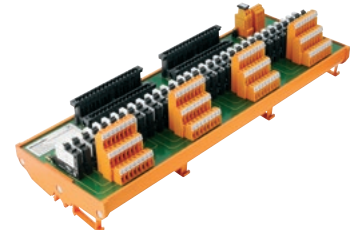

- Isolated digital input/output interfaces for Honeywell C300
- Screw or tension clamp connection

C300 / PAC-C300
Page B.13



- Pre-assembled cables for Honeywell C300
- Premium range (with housing) and Basic range (without housing)

TBY-C3
Page C.5

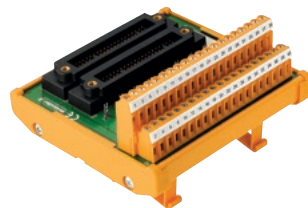

- Passive Interfaces for CS3000 digital and analogue cards
- 2 KS (40 poles) or AKB (50 poles) connectors for redundancy
- With LED, fuses, disconnectors
- Screw and tension clamp connection

TBY-ADV
Page C.11

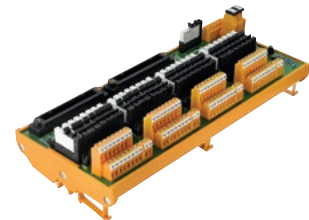

- Isolated Interfaces for CS3000 digital cards
- 2 AKB (50 poles) connectors for redundancy
- 6.4mm relays with fuses and disconnectors
- Screw and tension clamp connection

TBY-RS

Page C.17

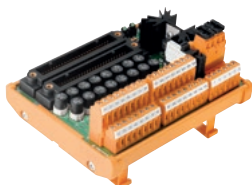

- Passive Interfaces for ProSafe digital and analogue cards
- 2 KS (40 poles) or AKB (50 poles) connectors for redundancy
- With LED, fuses, disconnections
- Screw and tension clamp connection

PAC-YOK-MIL

Page C.26



- Pre-assembled cable for Yokogawa CS3000 and ProSafe
- MIL connector - MIL connector
- MIL connector - ferrules
- Colour code according DIN 47100

BKP

Page C.30



- Backplane for Digital outputs SIL relays with alarm (as optional)

RS F

Page D.6



- Interface for ribbon cable in accordance with IEC 60603-1/ DIN 41651
- Connection 1:1
- 10 to 64 poles

RS SD

Page D.8



- Interface for connector SUB-D in accordance with IEC 60807-2/ DIN 41652
- Connection 1:1
- 9 to 50 male or female poles

RS SD HD

Page D.10



- Interface for connector SUB-D high-density
- Connection 1:1
- 15, 26, 44, 62 poles
- Screw connection

RS RJ45

Page D.11



- Interfaces with RJ45 connector
- Connection 1:1

RS ELCO

Page D.12

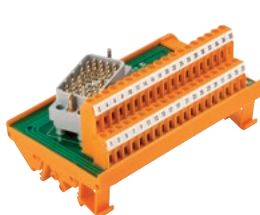

- Interface with male ELCO plug-in connectors
- Screw or tension clamp connection

RS ELCO F

Page D.13



- Interface with female ELCO plug-in connectors
- 20 to 56 poles
- Screw connection

PLC / DCS System Cabling & Migration Solutions

RSX

Page D.17



- Axial components such as resistors, diodes and capacitors, can be soldered into the RSX component modules

RS VERT

Page D.18



- Supply voltage distributor modules
- Connection 1:1
- 2 to 6 potentials

RSD

Page D.21



- Interfaces with independent diodes or with anode or common cathode
- Screw connection

RSM 1CO/2CO

Page E.5

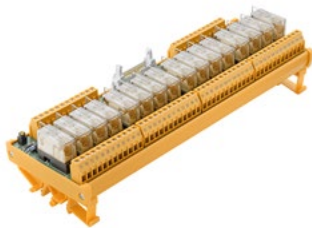

- Relay interface 1 or 2 changeover
- From 4 to 16 electromechanical relays
- Positive or negative switching or ac/dc
- Flat-connector available to make easy the connection to PLC'S
- Compatible with solid-state relays
- Screw, PUSH IN and tension clamp connection

RSMS 1CO

Page E.13



- Relay interface 1 changeover
- From 8 to 16 electromechanical relays
- Positive or negative switching or ac/dc
- Flat-connector available to make easy the connection to PLC'S
- Compatible with solid-state relays
- Screw and tension clamp

TIA F10

Page E.49



- TERMSERIES interface adapter for PLC wiring
- For 8-16 relays RSS
- For 8 relays RCL
- Sub-d and flat-connector connection

TRS

Page E.63

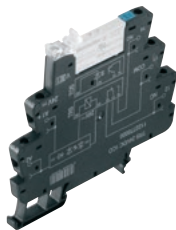

- All-purpose, pluggable relay modules
- Space-saving width
- AgNi contact with and without gold plating
- Screw and tension clamp connection

PAC-UNIV-HE

Page F.3



- Pre-assembled cables with ribbon cable connector
- Wire-end ferrules or ribbon cable connector
- Halogen free option
- Connection 1:1

PAC-UNIV-D

Page F.4



- Pre-assembled cables with SUB-D connector
- Wire-end ferrules or SUB-D connector
- Connection 1:1
- Halogen free option
- Shielded cable

PAC-HD

Page F.6



- Pre-assembled cables with High density SUB-D connector
- Wire-end ferrules or HD SUB-D connector
- Connection 1:1
- Shielded cable

PAC-ELCO

Page F.8



- Pre-assembled cables with ELCO connector
- Wire-end ferrules or ELCO connector
- Connection 1:1
- Shielded cable

PAC-UNIV

Page F.9

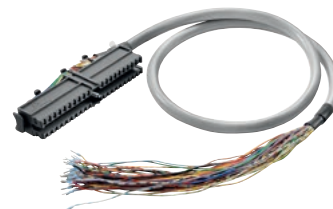

- Pre-assembled cables
- At one end has the PLC connector
- The other end has a wire-end ferrule

FAD S5115

Page G.12



- Front adapters for migrations from Siemens S5-115
- Clip-in foot for TS35
- Bridge system

FAD S5135

Page G.16



- Front adapters for migrations from Siemens S5-135
- Bridge system

FAD BLK1, BLK, BLK7, BLK9

Page G.20



- Front adapters for migrations from Schneider TSX
- Clip-in foot for TS35
- Bridge system

FAD PREM

Page G.26



- Front adapters for migrations from Schneider Premium
- Clip-in foot for TS35
- Bridge system

FAD 1771

Page G.29



- Front adapters for migrations from Rockwell PLC-5
- Clip-in foot for TS35
- Bridge system

MIGRATION RACK

Page G.33



- 19" racks
- Same dimensions as the original Siemens or Schneider racks

PLC / DCS System Cabling & Migration Solutions

SP-RS PLC PLC-5

Page G.39



- Front adapters for migrations from Rockwell PLC-5
- Card system

IPC620

Page G.44



- Front adapters for migrations from Honeywell PLC-5
- Card system

FAD – Front adapters for migrations – Schneider Quantum module

Page G.47



- Point-to-point connection
- Conversion between the Quantum connector to connector S2CD-THR 3.5/20 (2 units)
- 40 points

FAD – Front adapters for migrations – Siemens APAC

Seite G.48



- Point-to-point connection
- Conversion between the Moore connector to connector SL 3.5/24 poles
- 24 points

RS F20 X – Redundancy interfaces

Seite G.49

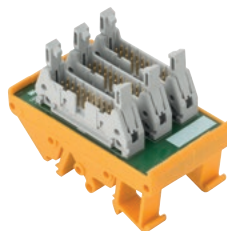

- Connection 1 to 1 for input interfaces
- Diode protection for output interfaces

SKH

Page H.4



- Card holders for adapting Euro format cards (19")
- Plug-in connectors acc. to IEC 603/DIN 41612 and DIN 41617

Universal solutions for PLC input/output cards

Universal solutions for PLC input/output cards	Introduction	A.2
	ABB S800	- Selection guide A.12
	EMERSON DELTA V	- Selection guide A.13
	GE FANUC RX3i	- Selection guide A.14
	HONEYWELL C200	- Selection guide A.15
	HONEYWELL - CONTROL EDGE	- Selection guide A.16
	mitsubishi MELSEC Q	- Selection guide A.17
	MOELLER XIOC	- Selection guide A.18
	OMRON - CJ1W	- Selection guide A.19
	ROCKWELL - COMPACT LOGIX	- Selection guide A.20
	ROCKWELL - CONTROL LOGIX	- Selection guide A.21
	ROCKWELL - MICRO LOGIX 1400	- Selection guide A.22
	SCHNEIDER - M258	- Selection guide A.23
	SCHNEIDER - M340 / M580	- Selection guide A.24
	SCHNEIDER - MICRO	- Selection guide A.25
	SCHNEIDER - QUANTUM	- Selection guide A.26
	SCHNEIDER - TM3	- Selection guide A.27
	SCHNEIDER - TWIDO	- Selection guide A.28
	SIEMENS - S7-200	- Selection guide A.29
	SIEMENS - S7-300 / ET-200M	- Selection guide A.30
	SIEMENS - S7-400	- Selection guide A.33
	SIEMENS - S7-1200	- Selection guide A.34
	SIEMENS - S7-1500 / ET 200MP	- Selection guide A.35
	SIEMENS - ET 200SP	- Selection guide A.36
	SIEMENS - ET 200SP HA	- Selection guide A.37
	WEIDMÜLLER - u-remote	A.38
	RS IO - Selection guide for passive interfaces for digital signals	A.39
	RS IO - Passive interface for digital signals	A.40
	RS A - Selection guide for passive interfaces for analogue signals	A.53
	RS A - Passive interface for analogue signals	A.54
	RSM - Selection guide for insulated interfaces for digital input signals	A.58
	RSM - Isolated interfaces for digital input signals	A.59
	RSM - Selection guide for insulated interfaces for digital output signals	A.62
	RSM - Isolated interfaces for digital output signals	A.63

Universal solutions for PLC input/output cards

Aimed at reducing costs, and to save space and time in the construction of electrical cabinets, the universal cabling system for PLCs is provided as an effective alternative to end-to-end cabling design. Weidmüller offers a wide range of pre-assembled cables and interfaces to major PLC manufacturers:

- The interfaces are used as an interconnection element between the control and the process, and are supplied with tension clamp or screw connection. Those interfaces, with a compact design, provide different functions such as LEDs, fuses, disconnectors or relays.
- The pre-assembled cables are supplied with the manufacturer's own connector at one end and are available in different lengths.

Universal system

The system is designed to be compatible with all main commercial PLCs: ABB, Emerson, Fanuc, Honeywell, Mitsubishi, Omron, Rockwell, Schneider, Siemens, ...



Guaranteed connection

The original factory connector is on one end of the PLC and standard connectors are on the other end: ribbon cable with fixing housing for digital signals and SUB-D connector for analogue signals. Available in different lengths.



Simple system configuration

Selection tables are available in this catalogue to assist you in choosing the right products for your application. In addition, there is also an automatic software selection guide on the website.

PLC SIEMENS – S7-300 / ET-200M

Order code	PLC		Number of channels	Number of relays	Number of inputs	Number of outputs
	Input	Output				
6ES7 312-1CG03-0AB0	16 DI	16 DO	16	16	16	16
6ES7 312-1CG04-0AB0	16 DI	16 DO	16	16	16	16
6ES7 312-1CG05-0AB0	16 DI	16 DO	16	16	16	16
6ES7 312-1CG06-0AB0	16 DI	16 DO	16	16	16	16
6ES7 312-1CG07-0AB0	16 DI	16 DO	16	16	16	16
6ES7 312-1CG08-0AB0	16 DI	16 DO	16	16	16	16
6ES7 312-1CG09-0AB0	16 DI	16 DO	16	16	16	16
6ES7 312-1CG10-0AB0	16 DI	16 DO	16	16	16	16
6ES7 312-1CG11-0AB0	16 DI	16 DO	16	16	16	16
6ES7 312-1CG12-0AB0	16 DI	16 DO	16	16	16	16
6ES7 312-1CG13-0AB0	16 DI	16 DO	16	16	16	16
6ES7 312-1CG14-0AB0	16 DI	16 DO	16	16	16	16
6ES7 312-1CG15-0AB0	16 DI	16 DO	16	16	16	16
6ES7 312-1CG16-0AB0	16 DI	16 DO	16	16	16	16
6ES7 312-1CG17-0AB0	16 DI	16 DO	16	16	16	16
6ES7 312-1CG18-0AB0	16 DI	16 DO	16	16	16	16
6ES7 312-1CG19-0AB0	16 DI	16 DO	16	16	16	16
6ES7 312-1CG20-0AB0	16 DI	16 DO	16	16	16	16
6ES7 312-1CG21-0AB0	16 DI	16 DO	16	16	16	16
6ES7 312-1CG22-0AB0	16 DI	16 DO	16	16	16	16
6ES7 312-1CG23-0AB0	16 DI	16 DO	16	16	16	16
6ES7 312-1CG24-0AB0	16 DI	16 DO	16	16	16	16
6ES7 312-1CG25-0AB0	16 DI	16 DO	16	16	16	16
6ES7 312-1CG26-0AB0	16 DI	16 DO	16	16	16	16
6ES7 312-1CG27-0AB0	16 DI	16 DO	16	16	16	16
6ES7 312-1CG28-0AB0	16 DI	16 DO	16	16	16	16
6ES7 312-1CG29-0AB0	16 DI	16 DO	16	16	16	16
6ES7 312-1CG30-0AB0	16 DI	16 DO	16	16	16	16
6ES7 312-1CG31-0AB0	16 DI	16 DO	16	16	16	16
6ES7 312-1CG32-0AB0	16 DI	16 DO	16	16	16	16
6ES7 312-1CG33-0AB0	16 DI	16 DO	16	16	16	16
6ES7 312-1CG34-0AB0	16 DI	16 DO	16	16	16	16
6ES7 312-1CG35-0AB0	16 DI	16 DO	16	16	16	16
6ES7 312-1CG36-0AB0	16 DI	16 DO	16	16	16	16
6ES7 312-1CG37-0AB0	16 DI	16 DO	16	16	16	16
6ES7 312-1CG38-0AB0	16 DI	16 DO	16	16	16	16
6ES7 312-1CG39-0AB0	16 DI	16 DO	16	16	16	16
6ES7 312-1CG40-0AB0	16 DI	16 DO	16	16	16	16
6ES7 312-1CG41-0AB0	16 DI	16 DO	16	16	16	16
6ES7 312-1CG42-0AB0	16 DI	16 DO	16	16	16	16
6ES7 312-1CG43-0AB0	16 DI	16 DO	16	16	16	16
6ES7 312-1CG44-0AB0	16 DI	16 DO	16	16	16	16
6ES7 312-1CG45-0AB0	16 DI	16 DO	16	16	16	16
6ES7 312-1CG46-0AB0	16 DI	16 DO	16	16	16	16
6ES7 312-1CG47-0AB0	16 DI	16 DO	16	16	16	16
6ES7 312-1CG48-0AB0	16 DI	16 DO	16	16	16	16
6ES7 312-1CG49-0AB0	16 DI	16 DO	16	16	16	16
6ES7 312-1CG50-0AB0	16 DI	16 DO	16	16	16	16

Wide range of passive interfaces

The range includes passive input/output interfaces for digital and analogue signals. The interfaces are available in screw or tension clamp connection and the sensors/actuators can be connected with 1, 2 or 3 wires, whichever is needed. You can also choose from a large variety of components:

- LED indication
- Fuse
- Disconnector
- Test leads

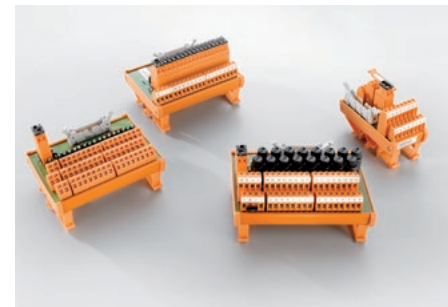
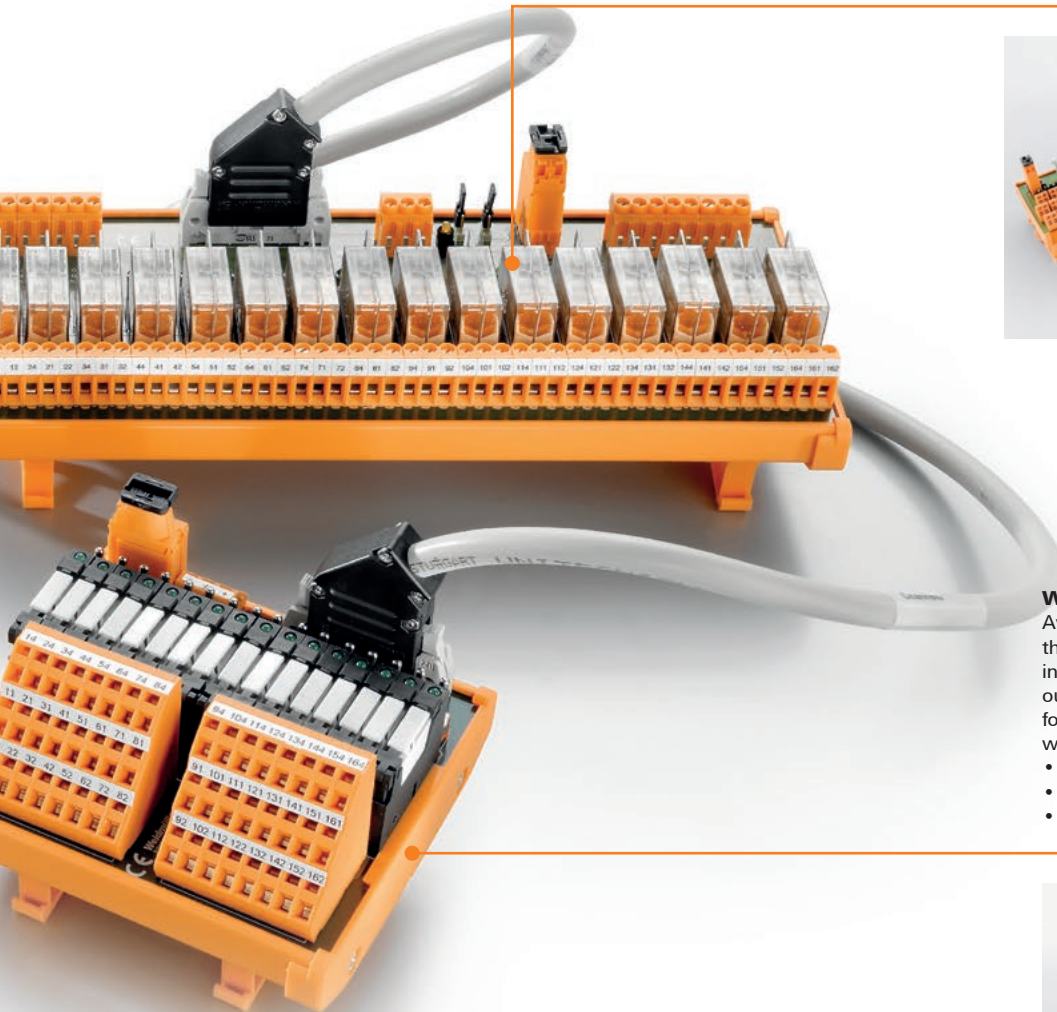

Wide range of relay insulated interfaces

Available in versions with 8, 12 and 16 relays, the RSM family offers the possibility of insulating digital signals both in input and output cards. Options include our compact format (6 mm relays) or standard (RCL relay), with additional features including:

- Switch in coil and contact
- Fuse in contact
- 1 or 2 CO contacts

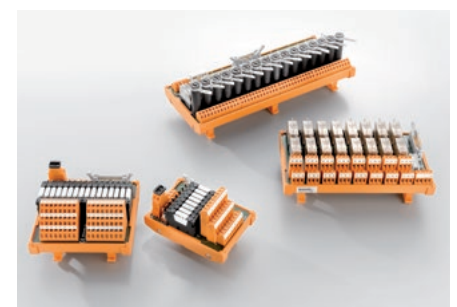

Universal solutions for PLC input/output cards

The increasing complexity of machinery and facilities in the industry means that attention is being drawn to the resulting rise in the costs of wiring. Traditional end-to-end cabling between the PLC and the field components has many drawbacks:

- High assembly costs: Time-consuming routing and assembly of connecting leads.
- The risk of wiring mistakes increases in proportion with the number of individual wires at one end.
- Individual wires occupy a considerable amount of space in the cabinet.
- High installation and implementation time.
- High labelling and documentation workload

Weidmüller offers a complete line of pre-assembled cables, together with a range of compact interfaces, to connect with the main commercial PLCs:

- ABB S88
- Emerson Delta V
- GE Fanuc 90-30 and RX3i
- Honeywell C200, Control Edge
- Mitsubishi Melsec
- Omron CJ1W
- Rockwell Compact Logix , Control Logix and Micro Logix
- Schneider Micro, Twido, Quantum, M340/M580, M258 and TM3
- Siemens S7-200, S7-300, S7-400, S7-1200 and S7-1500, ET 200SP and ET 200SP HA

PLC interface

The range includes passive input/output interfaces for digital and analogue signals and relay boards to insulate the input and output signals. These modules accept all common commercial connectors and are available for screw or tension clamp connection.

The Weidmüller universal interfaces for the PLC have the following individual components:

- Extruded profile for inserting the PCB
- Clip-on feet for locking on standardised mounting rails TS 32 and TS 35
- Printed circuit board where the following elements can be identified
 - Plug-in connectors to the PLC (Ribbon cable, RSV or SUB-D)
 - Weidmüller terminals for screw or tension clamp connection
 - Electronic or mechanical components offering additional functions: LED, relays, fuses...

These interfaces are universal: the same interface can be used by different PLCs from different manufacturers. Pre-assembled cables are responsible for adequately communicating the PLC with its field components.



Digital input/output interfaces (H System)

The digital input/output interfaces have been designed using a ribbon cable connector suitable for the majority of signals coming from the PLC. In addition, the pre-assembled cables are designed using a cross-section of 0.25 mm² and have a cover that guarantees complete and safe fastening with the interface connector.

The range has been designed for 8, 16 and 32 signals in tension clamp or screw connection and you can choose additional functions including:

- LED
- Fusible
- Interruptor

Additionally, sensors/actuators can be connected using 1-, 2-, or 3-wire techniques; this way, the space that is usually needed for connecting the common power supply points, which are normally connected via additional terminals, is not required.

1-wire system:

In field components, one of the wires is connected to the interface while the other is connected to a common power supply point (for example a terminal block).

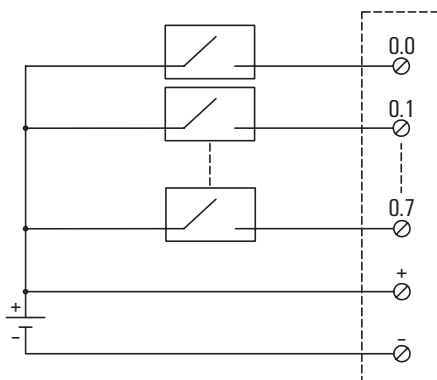

2-wire system:

The 2 wires of the field element are connected to the interface with power bus in one of them.

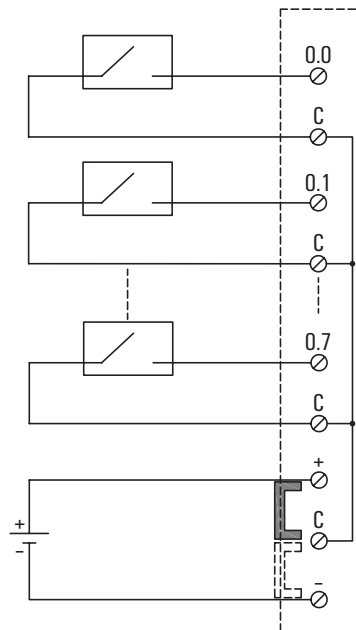

3-wire system:

The interface is designed for 3 wire field components, with one for positive, one for negative and one for the signal that is sent to the PLC.

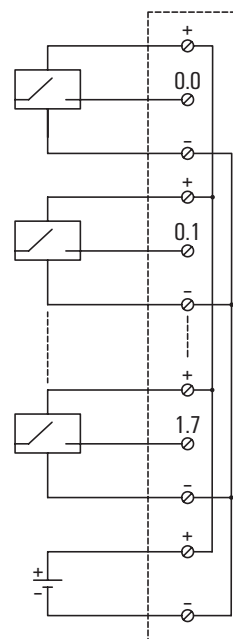

Universal solutions for PLC input/output cards

Digital input/output interfaces for high voltage (R System)

The digital signals used by PLCs are usually 24V DC or a maximum of 48 V DC. Nevertheless, a few cards also work at higher voltages, up to 230 V AC.

For these voltages, the insulation distance between channels has to be increased up to values that the ribbon cable connector is not able provide. In this case, interfaces supplied with RSV connectors have been included in the range.



Analogue input/output interfaces (S System)

The analogue input/output interfaces have been designed using a shielded SUB-D connector, ideal for avoid interferences in the transmission of analogue signals. The pre-assembled cables are also supplied with shielded cable.

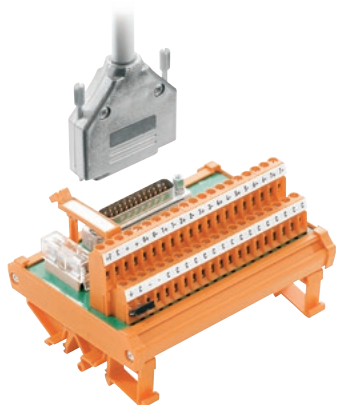

Insulated digital input/output interfaces

The insulated digital input/output interfaces are used, when necessary, to isolate the PLC signal from the field signal, normally when adapting voltages between the field components and the PLC operational voltage.

The current provided by the PLC is not high enough for the different field components in the output cards. In this case, the relay acts like an amplifier and offers enough power to connect the different elements, such as, for example, electro valves.

The RSM family, available in 8 and 16 relay versions connects to the PLC with a ribbon cable and is available in compact form (6 mm relays) or standard (RCL relay) and includes additional features such as:

- Switch in coil and contact
- Fuse in contact
- 1 or 2 CO contacts

In addition, the relays also can be replaced by the Weidmüller solid-state-relays.

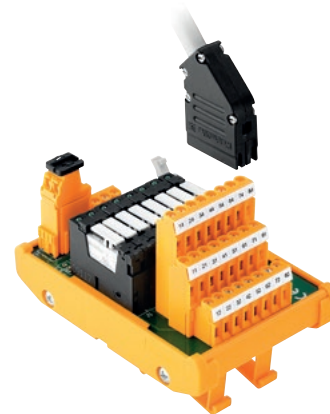

Pre-assembled cables

The connection using pre-assembled cables drastically reduces the connection work between the PLC and the field components.

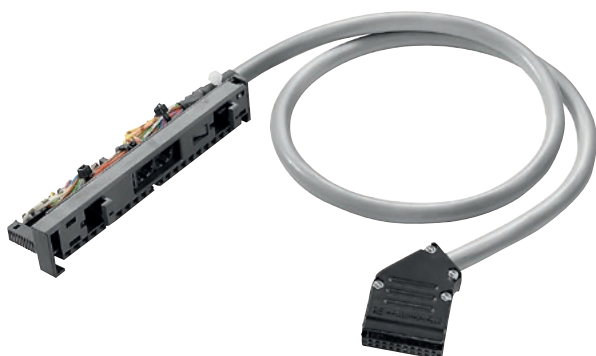

Each pre-assembled cable has the following features:

- PLC connector: The original connector of the manufacturer is used.
- Interface Connector: 3 types of connectors are used according to the interface they connect to.
 - Ribbon cable connectors - which are supplied with a hood to protect them from cable extraction forces and ensure secure and reliable connection.
 - Very robust RSV connectors that allow working with high voltages of up to 230 V.
 - SUB-D connectors, where the wire screening for analogue signals is connected directly to the metallic body of the connector to minimise the effect of electromagnetic interferences.
- Cable: A multipole 0.25 mm² cross-section wire is used. This is also shielded for analogue signal cables. Each of the individual wires is identified by means of a colour code according to DIN 47100.

Table of colour codes according to DIN 47100

N°	Colour	N°	Colour	N°	Colour
1	White	22	Brown/Blue	43	Blue/Black
2	Brown	23	White/Red	44	Red/Black
3	Green	24	Brown/Red	45	White/Brown/Black
4	Yellow	25	White/Black	46	Yellow/Green/Black
5	Grey	26	Brown/Black	47	Grey/Pink/Black
6	Pink	27	Grey/Green	48	Blue/Red/Black
7	Blue	28	Yellow/Grey	49	White/Green/Black
8	Red	29	Pink/Green	50	Green/Brown/Black
9	Black	30	Yellow/Pink	51	White/Yellow/Black
10	Violet	31	Green/Blue	52	Yellow/Brown/Black
11	Grey/Pink	32	Yellow/Blue	53	White/Grey/Black
12	Red/Blue	33	Green/Red	54	Grey/Brown/Black
13	White/Green	34	Yellow/Red	55	White/Pink/Black
14	Brown/Green	35	Green/Black	56	Pink/Brown/Black
15	White/Yellow	36	Yellow/Black	57	White/Blue/Black
16	Yellow/Brown	37	Grey/Blue	58	Brown/Blue/Black
17	White/Grey	38	Pink/Blue	59	White/Red/Black
18	Grey/Brown	39	Grey/Red	60	Brown/Red/Black
19	White/Pink	40	Pink/Red	61	Black/White
20	Pink/Brown	41	Grey/Black		
21	White/Blue	42	Pink/Black		

Tables and automatic selection guides:

To help you choose the right products for your application, Weidmüller offers a catalogue with a selection of tables which can be found on the following pages.

In addition, on our website, we have an automatic selection guide, using intuitive software that can help you to choose the appropriate interface and cable for your Input/Output cards. This can be found at www.weidmueller.com

Universal solutions for PLC input/output cards

Advantages of the system:

The combination of pre-assembled cables and the interfaces allows the final connecting system to be:

- **Safe**
 - It excludes the risk of errors in cabling

- **Fast**

The use of pre-assembled cables means there are real savings in time:

 - during design, thanks to the selection guides.
 - during assembly.
 - during startup.
 - in the detection/resolution of problems.

- **Reliable**
 - no cabling errors,
 - clean cabling in cabinet
(multi-pole cables instead of single cables)

- **Flexible**
 - a multitude of input/output interfaces
 - variable cable lengths,
 - expansions can be made without any problem.
 - flexibility thanks to the simplicity of interchanging and diverse input/output interfaces.
 - easy migration to another system, simply by changing the pre-assembled cable.

- **Small-space reduction**
 - more space in the cable ducts,
 - narrow modules,
 - no terminal block

PLC interface selection tables

A

Universal solutions for PLC input/output cards

A

Selection guide

PLC SIEMENS - S7-300 / ET-200M

DI/DO	PLC		Cables		Interfaces					
	Input/Output cards		Standard		Direct inputs/outputs		Insulated inputs		Insulated outputs	
	Manufacturer code	Number/Type of channels	Order No.	Quantity	Type	Quantity	Type	Quantity	Type	Quantity
16 DI	6ES7323-1BL00-0AA0	16 DI	7789236xxx	1	H2016	1	I2016	1	O2016	1
	6ES7331-7HF01-0AB0	8AI	7789801xxx	1	H20	1				
8 AI	6ES7331-1KF01-0AB0	8 AI	7789604xxx	1	A3716	1				
	6ES7331-1KF02-0AB0	8 AI	7789604xxx	1	A3716	1				
2 AI	6ES7331-7KB01-0AB0	2 AI	7789224xxx	1	A1504	1				
	6ES7331-7KB02-0AB0	2 AI	7789224xxx	1	A1504	1				
8 AI	6ES7331-7KF00-0AB0	8 AI	7789229xxx	1	A2508	1				
	6ES7331-7KF01-0AB0	8 AI	7789229xxx	1	A2508	1				
8 AI	6ES7331-7KF02-0AB0	8 AI	7789231xxx	1	A3716	1				
	6ES7331-7NF00-0AB0	8 AI	7789233xxx	1	A2508	1				

Selection guide

DI/DO	Manufacturer code	Number/Type of channels	Order No.	Quantity	Type	Quantity	Type	Quantity	Type	Quantity
16 DI	6ES7323-1BL00-0AA0	16 DI	7789236xxx	1	H2016	1	I2016	1	O2016	1
	6ES7331-7HF01-0AB0	8AI	7789801xxx	1	H20	1				
8 AI	6ES7331-1KF01-0AB0	8 AI	7789604xxx	1	A3716	1				
	6ES7331-1KF02-0AB0	8 AI	7789604xxx	1	A3716	1				
2 AI	6ES7331-7KB01-0AB0	2 AI	7789224xxx	1	A1504	1				
	6ES7331-7KB02-0AB0	2 AI	7789224xxx	1	A1504	1				
8 AI	6ES7331-7KF00-0AB0	8 AI	7789229xxx	1	A2508	1				
	6ES7331-7KF01-0AB0	8 AI	7789229xxx	1	A2508	1				
8 AI	6ES7331-7KF02-0AB0	8 AI	7789231xxx	1	A3716	1				
	6ES7331-7NF00-0AB0	8 AI	7789233xxx	1	A2508	1				

RS IO - Selection guide for passive interfaces for digital signals

Number of channels	Type of wiring	Connection	LED by channel	Disconnectable	Pass	Order No.	Type	Page
16-channel	1	S/S	-	-	-	6224291001	RS 232C LP2M S/20	A.56
						6224291002	RS 232C	A.56
						6224481001	RS 485 LP2M S/40	A.56
2-channel	2	S/S	-	-	-	9463740000	RS 485	A.56
						9463830000	RS 485 2W L/R S	A.57
16-channel	2	S/S	-	-	-	9445700000	RS 180 1W S	A.58
						9445710000	RS 180 1W S/2	A.58
						1311700000	RS 180 1W L/R 2	A.58
						9446000000	RS 180 2W L/R S	A.58
						1311700000	RS 180 2W L/R 2	A.58
						9446720000	RS 180 2W F/R S	A.60
						9446730000	RS 180 2W F/R 2	A.60
						1311800000	RS 180 2W L/R S	A.60
						1311800000	RS 180 2W L/R 2	A.60
						1311800000	RS 180 2W F/R S	A.61
						1311800000	RS 180 2W F/R 2	A.61
						9446820000	RS 180 2W L/R S	A.62
						9446830000	RS 180 2W L/R 2	A.62
						1311900000	RS 180 2W F/R S	A.63
						1311900000	RS 180 2W F/R 2	A.63
						9446920000	RS 180 2W L/R S	A.64
9446930000	RS 180 2W L/R 2	A.64						
8-channel	2	S/S	-	-	-	9445700000	RS 180 1W S	A.58
						9445710000	RS 180 1W S/2	A.58
						9445720000	RS 180 1W L/R 2	A.58
12-channel	2	S/S	-	-	-	9446100000	RS 232 1W S	A.48
						9446110000	RS 232 1W S/2	A.48
						9446120000	RS 232 1W L/R 2	A.48

The selection tables help you to choose the pre-assembled cables and interfaces.

1 Select the PLC card from the corresponding table

- Example:**
- PLC: Siemens S7-300
 - Card: 6ES7321-1BH82-0AA0

2 Check the code of the cable to be ordered:

- Example:**
- Cable code 7789234xxx
 - Quantity: 1 unit (by card)

The last 3 digits indicate the length: For example 015 indicates 1.5 m

3 Locate the exact family of modules and the quantity you require

Example:

- H2016 System Quantity: 1 unit (by card)

or

- I2016 System Quantity: 1 unit (by card)

Take the notes into account (if there are any)

The portfolio includes:

Passive digital input/output interfaces (H System)

H20: Universal interface for pin to pin 20 pole ribbon cable (see chapter D)

H2008: Passive input/output 8-channel digital interface

H2016: Passive input/output 16-channel digital interface

H40: Universal interface for pin to pin 40 pole ribbon cable (see chapter D)

Passive digital input/output interfaces for high voltage (R System)

R2416: Passive input/output 16-channel digital interface (for high voltage)

R3632: Passive input/output 32-channel digital interface (for high voltage)

Passive analogue output/input interfaces (S System)

A15: Universal interface for pin to pin SUB-D 15 male poles (see catalogue D)

A25: Universal interface for pin to pin SUB-D 25 male poles (see catalogue D)

A37: Universal interface for pin to pin SUB-D 37 male poles (see catalogue D)

A1504: Passive input/output 4-channel analogue interface

A2508: Passive input/output 8-channel analogue interface

A3716: Passive input/output 16-channel analogue interface

A2508P: Passive input/output 8-channel analogue interface (specific)

Relay insulated digital output/input interfaces

O2008: 8-channel insulated digital output interface positive switching

O2008N: 8-channel insulated digital output interface negative switching

O2016: 16-channel insulated digital output interface positive switching

O2016N: 16-channel insulated digital output interface negative switching

I2016: 16-channel insulated digital input interface

4 Note the page number that is shown in the top part of the column

Example:

- H2016 System -> See page A.39

or

- I2016 System -> See page A.58

5 Once the module family is chosen (step 3 - eg H2016), go to the page identified in step 4 and locate that family in the new table on that page.

6 Choose the interface according to your application needs ie. 1, 2 or 3 wires, screw or tension clamp connection, with fuse, LED, switch, etc.

7 Go to the specifications page where you can check all the details of the interface.

Note: The interfaces are intended to be used inside an IP20 enclosure at least.

PLC ABB S800



A

	PLC		Cables		Interfaces					
	Input/Output cards		Standard		Direct inputs/outputs		Insulated inputs		Insulated outputs	
					- see page A.39 (H,R) or A.53 (A) -		- see page A.58 -		- see page A.62 -	
	Manufacturer code	Number/Type of channels	Order No.	Quantity	Type	Quantity	Type	Quantity	Type	Quantity
DI	DI810	16 DI	7789641xxx	1	H2016	1	I2016	1		
	DI811 ^{A)}	16 DI	7789641xxx	1	H2016	1				
	DI814 ^{A)}	16 DI	7789641xxx	1	H0216	1				
	DI818 + TU819	32 DI	7789641xxx	2	H2016	2				
	DI830	16 DI	7789641xxx	1	H2016	1	I2016	1		
	DI831 ^{A)}	16 DI	7789641xxx	1	H2016	1				
	DI840	16 DI	7789641xxx	1	H2016	1	I2016	1		
	DI880	16 DI	7789641xxx	1	H2016	1	I2016	1		
DO	DO810	16 DO	7789641xxx	1	H2016	1			O2016	1
	DO814 ^{B)}	16 DO	7789641xxx	1	H2016	1			O2016N	1
	DO815	8 DO	7789643xxx	1	H2016	1			O2016	1
	DO818+TU819	32 DO	7789641xxx	2	H2016	2			O2016	2
	DO840	16 DO	7789641xxx	1	H2016	1			O2016	1
	DO880	16 DO	7789641xxx	1	H2016	1			O2016	1
AI	AI810	8 AI	7789657xxx	1	A25	1				
	AI810	8 AI	2491490xxx	1	A2508	1				
	AI820	4 AI	7789657xxx	1	A25	1				
	AI830	8 AI	7789657xxx	1	A25	1				
	AI830A	8 AI	7789657xxx	1	A25	1				
	AI845	8 AI	7789657xxx	1	A25	1				
	AI880+TU854	8 AI	7789657xxx	1	A2508	1				
AO	AO810	8 AO	7789657xxx	1	A25	1				
	AO810	8 AO	1349920xxx	1	A2508	1				
	AO810V2	8 AO	7789657xxx	1	A25	1				
	AO815	8 AO	7789657xxx	1	A25	1				
	AO820	4 AO	7789657xxx	1	A25	1				
	AO845	8 AO	7789657xxx	1	A25	1				

Note A) Attention! Only use interfaces without LEDs
 B) Attention! Use only interfaces without LEDs for the direct option.

- Please, always take into account the characteristics of the PLC card (voltage, current...) when selecting interfaces. In some cases, the card can work at higher voltages than those indicated in the interface.
 - Use with 812TU MTU
 - The interfaces are intended to be used inside an IP20 enclosure at least.
 - The last 3 digits of the cable code indicate its length in decimetres. For example, if the code ends in 100, the cable would be 10 m long.
- * In the case that an input/output card does not appear in this table, you can check our on-line PLC selection guide at www.weidmuller.com where you will always find the most up-to-date information.

PLC EMERSON DELTA V

	PLC		Cables		Interfaces					
	Input/Output cards		Standard		Direct inputs/outputs		Insulated inputs		Insulated outputs	
					- see page A.39 (H,R) or A.53 (A) -		- see page A.58 -		- see page A.62 -	
	Manufacturer code	Number/Type of channels	Order No.	Quantity	Type	Quantity	Type	Quantity	Type	Quantity
DI	VE4001S2T1B1 ^{A)}	8 DI	7789100xxx	1	H2016	1				
	VE4001S2T1B2 ^{A)}	8 DI	7789100xxx	1	H2016	1				
	VE4001S2T1B3 ^{A)}	8 DI	7789701xxx	1	H2016	1				
	VE4001S2T2B1 ^{A)}	8 DI	7789100xxx	1	H2016	1				
	VE4001S2T2B2 ^{A)}	8 DI	7789100xxx	1	H2016	1				
	VE4001S2T2B3 ^{A)}	8 DI	7789701xxx	1	H2016	1				
	VE4001S2T2B4 ^{A)}	32 DI	7789100xxx	2	H2016	2				
	VE4001S2T2B5 ^{A)}	32 DI	7789702xxx	2	H2016	2				
	VE4001S3T1B1	8 DI	7789104xxx	1	R2416	1				
	VE4001S3T1B2	8 DI	7789104xxx	1	R2416	1				
VE4001S3T2B1	8 DI	7789104xxx	1	R2416	1					
VE4001S3T2B2	8 DI	7789104xxx	1	R2416	1					
DO	VE4002S1T1B1 ^{A)}	8 DO	7789100xxx	1	H2008	1				
	VE4002S1T1B2 ^{A)}	8 DO	7789100xxx	1	H2008	1				
	VE4002S1T1B3 ^{A)}	8 DO	7789701xxx	1	H2016	1				
	VE4002S1T2B1 ^{A)}	8 DO	7789100xxx	1	H2008	1				
	VE4002S1T2B2 ^{A)}	8 DO	7789100xxx	1	H2008	1				
	VE4002S1T2B3 ^{A)}	8 DO	7789700xxx	1	H2008	1				
	VE4002S1T2B4 ^{A)}	8 DO	7789703xxx	1	H2008	1				
	VE4002S1T2B5 ^{A)}	32 DO	7789100xxx	2	H2016	2				
	VE4002S1T2B6 ^{A)}	32 DO	7789702xxx	2	H2016	2				
	VE4002S2T2B1	8 DO	7789104xxx	1	R2416	1				
VE4002S2T2B2	8 DO	7789104xxx	1	R2416	1					
AI	VE4003S2B1	8 AI	1350490xxx	1	A2508	1				
	VE4003S2B2	8 AI	1350490xxx	1	A2508	1				
	VE4003S2B3	8 AI	1350490xxx	1	A2508	1				
	VE4003S2B4	8 AI	7789704xxx	1	A2508	1				
	VE4003S2B6	16 AI	1350500xxx	1	A3716	1				
	VE4003S3B3	8 AI	1350490xxx	1	A2508	1				
	VE4003S3B4	8 AI	7789704xxx	1	A2508	1				
	VE4003S6B1	8 AI	1350500xxx	1	A3716	1				
AO	VE4005S2B1	8 AO	1350490xxx	1	A2508	1				
	VE4005S2B2	8 AO	1350490xxx	1	A2508	1				
	VE4005S2B3	8 AO	7789704xxx	1	A2508	1				

Note A) Attention! Only use interfaces without LEDs

- Please, always take into account the characteristics of the PLC card (voltage, current...) when selecting interfaces. In some cases, the card can work at higher voltages than those indicated in the interface.
- Cables 7789100xxx, 7789104xxx, 7789106xxx, 7789108xxx, 1350480xxx, 1350490xxx and 1350500xxx have wire-end ferrules at one end. These cables do not have a PLC connector. Colour code according to DIN 47100.
- The interfaces are intended to be used inside an IP20 enclosure at least.
- The last 3 digits of the cable code indicate its length in decimetres. For example, if the code ends in 100, the cable would be 10 m long.

* In the case that an input/output card does not appear in this table, you can check our on-line PLC selection guide at www.weidmuller.com where you will always find the most up-to-date information.

PLC GE FANUC RX3i



A

	PLC		Cables		Interfaces					
	Input/Output cards		Standard		Direct inputs/outputs		Insulated inputs		Insulated outputs	
	Manufacturer code	Number/Type of channels	Order No.	Quantity	- see page A.39 (H,R) or A.53 (A) -		- see page A.58 -		- see page A.62 -	
					Type	Quantity	Type	Quantity	Type	Quantity
DI	IC694MDL230	8 DI	2680670xxx		R2416	1				
	IC694MDL231	8 DI	2680670xxx		R2416	1				
	IC694MDL240	16 DI	2680650xxx		R2416	1				
	IC694MDL241	16 DI, positive logic	2680630xxx		H2016	1	I2016	1		
	IC694MDL250	16 DI	7789631xxx		R3632	1				
	IC694MDL260	32 DI	7789632xxx		R3632	1				
	IC694MDL634	8 DI, positive logic	2680630xxx		H2008	1				
	IC694MDL645	16 DI, positive logic	2680630xxx		H2016	1	I2016	1		
	IC694MDL646	16 DI, positive logic	2680630xxx		H2016	1	I2016	1		
	IC694MDL654	32 DI, positive logic	7789066xxx		H2016	2	I2016	2		
IC694MDL655	32 DI, positive logic	7789066xxx		H2016	2	I2016	2			
IC694MDL660	32 DI	7789619xxx		H2016	2	I2016	2			
DO	IC694MDL310	12 DO	2680660xxx		R2416	1				
	IC694MDL340	16 DO	2680660xxx		R2416	1				
	IC694MDL350	16 DO	7789631xxx		R3632	1				
	IC694MDL390	5 DO	7789636xxx		R2416	1				
	IC694MDL732	8 DO	2680640xxx		H2008	1			O2008	1
	IC694MDL734	6 DO	7789669xxx		R2416	1				
	IC694MDL740	16 DO	2680640xxx		H2016	1			O2016	1
	IC694MDL741 ^{A)}	16 DO	2680640xxx		H2016	1			O2016N	1
	IC694MDL742 ^{B)}	16 DO	2680640xxx		H2016	1			O2016	1
	IC694MDL752 ^{A)}	32 DO	7789066xxx		H2016	2			O2016N	2
	IC694MDL753	32 DO	7789066xxx		H2016	2			O2016	2
	IC694MDL754	32 DO	7789618xxx		H2016	2			O2016	2
	IC694MDL916	16 DO	7789696xxx		R3632	1				
	IC694MDL930	8 DO	2680670xxx		R2416	1				
IC694MDL931	8 DO	7789665xxx		R3632	1					
IC694MDL940	16 DO	7789666xxx		R2416	1					
AI	IC694ALG220	4 AI, voltage differential applications	2680800xxx		A1504	1				
	IC694ALG221	4 AI, voltage differential applications	2680790xxx		A1504	1				
	IC694ALG222	16 AI	2680690xxx		A2508	1				
	IC694ALG223	16 AI	2680690xxx		A2508	1				
	IC695ALG106	6 AI, current applications	1373690xxx		A2508	1				
	IC695ALG106	6 AI, voltage applications	1373700xxx		A2508	1				
	IC695ALG508	8 AI	1338580xxx		A3716	1				
	IC695ALG600	8 AI, resistance applications	7789622xxx		A3716	1				
	IC695ALG600	8 AI, voltage or current applications	7789623xxx		A3716	1				
	IC695ALG608	8 AI, common applications	7789667xxx		A2508	1				
		4 AI, differential applications								
	IC695ALG616	8 AI, differential applications	7789626xxx		A3716	1				
	IC695ALG616	4 AI, common mode applications	7789798xxx		A3716	1				
IC695ALG626 ^{C)}	8 AI, differential applications	7789626xxx		A3716	1					
IC695ALG626 ^{C)}	16 AI, common mode applications	7789798xxx		A3716	1					
AO	IC694ALG390	2 AO	2680700xxx		A2508	1				
	IC694ALG391	2 AO	2680700xxx		A2508	1				
	IC694ALG392	8 AO, current applications	2680770xxx		A1504	1				
	IC694ALG392	8 AO, voltage applications	2680780xxx		A1504	1				
	IC695ALG704	4 AO	7789668xxx		A1504	1				
	IC695ALG708	8 AO	7789625xxx		A2508	1				
	IC695ALG728 ^{B)C)}	8 AO	7789625xxx		A2508	1				
	IC695ALG808	8 AO	7789621xxx		A2508	1				
AI/AO	IC694ALG442	4 AI	2680720xxx		A3716	1				
		2 AO								
DI/DO	IC695HCS308	8 DI	1419430xxx		H20	1				
		7 DO								

Note A) Attention! Use only interfaces without LEDs for the direct option. B) LEDs interfaces only possible if configured at 24 V DC
 C) Attention! Only use Interfaces without disconnectors and test points

- Please, always take into account the characteristics of the PLC card (voltage, current...) when selecting interfaces. In some cases, the card can work at higher voltages than those indicated in the interface.
- The interfaces are intended to be used inside an IP20 enclosure at least.
- The last 3 digits of the cable code indicate its length in decimetres. For example, if the code ends in 100, the cable would be 10 m long.

* In the case that an input/output card does not appear in this table, you can check our on-line PLC selection guide at www.weidmueller.com where you will always find the most up-to-date information.

PLC HONEYWELL C200



	PLC		Cables		Interfaces					
	Input/Output cards		Standard		Direct inputs/outputs		Insulated inputs		Insulated outputs	
	Manufacturer code	Number/Type of channels	Order No.	Quantity	- see page A.39 (H,R) or A.53 (A) -		- see page A.58 -		- see page A.62 -	
					Type	Quantity	Type	Quantity	Type	Quantity
DI	TC-IDA161 / TK-IDA161	16 DI	7789031xxx	1	R2416	1				
	TC-IDD321 / TK-IDD321	32 DI	7789041xxx	1	H2016	2	I2016	2		
	TC-IDJ161 / TK-IDJ161	16 DI	7789049xxx	1	H2016	1	I2016	1		
	TC-IDK161 / TK-IDK161	16 DI	7789030xxx	1	R3632	1				
	TC-IDW161 / TK-IDW161	16 DI	7789030xxx	1	R3632	1				
	TC-IDX161 / TK-IDX161	16 DI	7789049xxx	1	H2016	1	I2016	1		
DO	TC-ODA161 / TK-ODA161	16 DO	7789056xxx	1	R2416	1				
	TC-ODD321 / TK-ODD321	32 DO	7789042xxx	1	H2016	1			O2016	1
	TC-ODJ161 / TK-ODJ161	16 DO	7789059xxx	1	H2016	1			O2016	1
	TC-ODK161 / TK-ODK161	16 DO	7789030xxx	1	R3632	1				
	TC-ODX161 / TK-ODX161	16 DO	7789040xxx	1	H2016	1			O2016	1
	TC-ORC081 / TK-ORC081	8 DO	7789155xxx	1	R2416	1				
	TC-ORC161 / TK-ORC161	16 DO	7789030xxx	1	R3632	1				
AI	TC-IAH061 / TK-IAH061	6 AI, current applications	7789156xxx	1	A2508	1				
	TC-IAH061 / TK-IAH061	6 AI, voltage applications	7789157xxx	1	A2508	1				
	TC-IAH161 / TK-IAH161	16 AI	7789032xxx	1	A3716	1				
	TC-IXR061 / TK-IXR061 ^A	6 AI, resistances 0 to 550 Ω	7789158xxx	1	A2508	1				
AO	TC-OAH061 / TK-OAH061	6 AO	7789159xxx	1	A2508	1				
	TC-OAV061 / TK-OAV161	6 AO	7789157xxx	1	A2508	1				
	TC-OAV081 / TK-OAV081	8 AO, current applications	7789037xxx	1	A2508	1				
	TC-OAV081 / TK-OAV081	8 AO, voltage applications	7789038xxx	1	A2508	1				

Note A) Only for 2-wires applications

- Please, always take into account the characteristics of the PLC card (voltage, current...) when selecting interfaces. In some cases, the card can work at higher voltages than those indicated in the interface.
 - The interfaces are intended to be used inside an IP20 enclosure at least.
 - The last 3 digits of the cable code indicate its length in decimetres. For example, if the code ends in 100, the cable would be 10 m long.
- * In the case that an input/output card does not appear in this table, you can check our on-line PLC selection guide at www.weidmuller.com where you will always find the most up-to-date information.

HONEYWELL – CONTROL EDGE

A

	PLC		Cables		Interfaces					
	Input/Output cards		Standard		Direct inputs/outputs		Insulated inputs		Insulated outputs	
					- see page A.39 (H,R) or A.53 (A) -		- see page A.58 -		- see page A.62 -	
	Manufacturer code	Number/Type of channels	Order No.	Quantity	Type	Quantity	Type	Quantity	Type	Quantity
DI	900G03-0202	16 DI	2857130xxx	1	R2416	1				
	900G04-0101	16 DI	2857140xxx	1	R2416	1				
	900G32-0101 A)	32 DI	2789130xxx	1	H2016	2	I2016	2		
DO	900G01-0202	16 DI	2857440xxx	1	H20	1				
	900H03-0202	8 DO	2857150xxx	1	R2416	1				
	900H01-0202 B)	8DO	2857460xxx	1						
AI	900H32-0102	32 DO	2789390xxx	1	H2016	2			O2016	2
	900A16-0103	16 AI	2789370xxx	1	A3716	1				
	900B01-0301	4 AO	2857120xxx	1	A1504	1				
AO	900B08-0202	8 AO	2789380xxx	1	A2508	1				
	900U01-0100	16 UIO, Single power connection	2789110xxx	1	A3716	1				
	900U01-0100	16 UIO, Dual power connection	2789120xxx	1	A2508	2				
UAI	900A01-0202	8 UAI, 2-wires except Ohms Input configuration	2857110xxx	1	A2508	1				
AI/AO	900K01-0201 C)	4 AI/AO	2857450xxx	1	A25	1				

Note
 A) Only possible if configured at 24 V DC.
 B) Connect with terminal block.
 C) Connection 1 to 1 between interface and I/O card.

- Please, always take into account the characteristics of the PLC card (voltage, current...) when selecting interfaces. In some cases, the card can work at higher voltages than those indicated in the interface.
 - The interfaces are intended to be used inside an IP20 enclosure at least.
 - The last 3 digits of the cable code indicate its length in decimetres. For example, if the code ends in 100, the cable would be 10 m long.
- * In the case that an input/output card does not appear in this table, you can check our on-line PLC selection guide at www.weidmuller.com where you will always find the most up-to-date information.

PLC MITSUBISHI MELSEC Q



	PLC		Cables		Interfaces					
	Input/Output cards		Standard		Direct inputs/outputs		Insulated inputs		Insulated outputs	
	Manufacturer code	Number/Type of channels	Order No.	Quantity	- see page A.39 (H,R) or A.53 (A) -		- see page A.58 -		- see page A.62 -	
					Type	Quantity	Type	Quantity	Type	Quantity
DI	QX10	16 DI	7789104xxx	1	R2416	1				
	QX40 ^{A)}	16 DI	7789100xxx	1	H2016	1				
	QX40-S1 ^{A)}	16 DI	7789100xxx	1	H2016	1				
	QX41 ^{A)}	32 DI	7789681xxx	1	H2016	2				
	QX41-S1 ^{A)}	32 DI	7789681xxx	1	H2016	2				
	QX42 ^{A)}	64 DI	7789681xxx	2	H2016	4				
	QX42-S1 ^{A)}	64 DI	7789681xxx	2	H2016	4				
	QX50	16 DI	7789104xxx	1	R2416	1				
	QX70 ^{A)}	16 DI	7789100xxx	1	H2016	1				
	QX71 ^{A)}	32 DI	7789681xxx	1	H2016	2				
	QX72 ^{A)}	64 DI	7789681xxx	2	H2016	4				
	QX80	16 DI	7789100xxx	1	H2016	1	I2016	1		
	QX81	32DI	7789682xxx	1	H2016	2	I2016	2		
QX82	64 DI	7789683xxx	2	H2016	4	I2016	4			
QX82-S1	64 DI	7789683xxx	2	H2016	4	I2016	4			
DO	QY10	16 DO	7789104xxx	1	R2416	1				
	QY18A	8 DO	7789104xxx	1	R2416	1				
	QY22	16 DO	7789104xxx	1	R2416	1				
	QY40P ^{B)}	16 DO	7789100xxx	1	H2016	1			O2016N	1
	QY41P ^{B)}	32 DO	7789708xxx	1	H2016	2			O2016N	2
	QY42P ^{B)}	64 DO	7789708xxx	2	H2016	4			O2016N	4
	QY50 ^{B)}	16 DO	7789100xxx	1	H2016	1			O2016N	1
	QY68A	8 DO	7789100xxx	1	H2016	1			O2016	1
	QY70 ^{B)}	16 DO	7789100xxx	1	H2016	1			O2016N	1
	QY71 ^{B)}	32 DO	7789708xxx	1	H2016	2			O2016N	2
	QY80	16 DO	7789100xxx	1	H2016	1			O2016	1
	QY81	32DO	7789709xxx	1	H2016	2			O2016	2
	QY81P	32DO	7789709xxx	1	H2016	2				
DI/DO	QH42P ^{B)}	32 DI	7789681xxx	1	H2016	2				
		32 DO	7789708xxx	1	H2016	2			O2016N	2
	QX41Y41P ^{B)}	32 DI	7789681xxx	1	H2016	2				
		32 DO	7789708xxx	1	H2016	2			O2016N	2
	QX48Y57 ^{B)}	8 DI	7789100xxx	2	H2016	1				
7 DO		H2016			1			O2016N	1	
AI	Q62AD-DGH	2 AI	1350480xxx	1	A1504	1				
	Q64AD	4 AI	1350480xxx	1	A1504	1				
	Q64AD-GH	4 AI	1350480xxx	1	A1504	1				
	Q68AD-G	8 AI, current applications	7789684xxx	1	A2508	1				
	Q68AD-G	8 AI, voltage applications	7789685xxx	1	A2508	1				
	Q68ADI	8 AI	1350490xxx	1	A2508	1				
	Q68ADV	8 AI	1350490xxx	1	A2508	1				
AO	Q62DA	2 AO	1350480xxx	1	A1504	1				
	Q62DA-FG	2AO	1350480xxx	1	A1504	1				
	Q62DAN	2 AO	1350480xxx	1	A1504	1				
	Q64DA	4 AO	1350480xxx	1	A1504	1				
	Q64DAN	4 AO	1350480xxx	1	A1504	1				
	Q66DA-G	6 AO, current applications	7789710xxx	1	A2508	1				
	Q66DA-G	6 AO, voltage applications	7789711xxx	1	A2508	1				
	Q68DAI	8 AO	1350490xxx	1	A2508	1				
	Q68DAIN	8 AO	1350490xxx	1	A2508	1				
	Q68DAV	8 AO	1350490xxx	1	A2508	1				
	Q68DAVN	8 AO	1350490xxx	1	A2508	1				

Note
A) Attention! Only use interfaces without LEDs
B) Attention! Use only interfaces without LEDs for the direct option.

- Please, always take into account the characteristics of the PLC card (voltage, current...) when selecting interfaces. In some cases, the card can work at higher voltages than those indicated in the interface.
- The interfaces are intended to be used inside an IP20 enclosure at least.
- The last 3 digits of the cable code indicate its length in decimetres. For example, if the code ends in 100, the cable would be 10 m long.

* In the case that an input/output card does not appear in this table, you can check our on-line PLC selection guide at www.weidmueller.com where you will always find the most up-to-date information.

PLC MOELLER XIOC

	PLC		Cables		Interfaces					
	Input/Output cards		Standard		Direct inputs/outputs		Insulated inputs		Insulated outputs	
					- see page A.39 (H,R) or A.53 (A) -		- see page A.58 -		- see page A.62 -	
	Manufacturer code	Number/Type of channels	Order No.	Quantity	Type	Quantity	Type	Quantity	Type	Quantity
DI	XIOC-16DI	16 DI, positive logic	7789862xxx	1	H2016	1	I2016	1		
		16 DI, negative logic ^{A)}	7789863xxx	1	H2016	1				
	XIOC-16DI-AC	16 DI	7789864xxx	1	R2416	1				
	XIOC-16DI-AC110	16 DI	7789864xxx	1	R2416	1				
	XIOC-32DI	32 DI, positive logic	7789771xxx	1	H2016	2	I2016	2		
		32 DI, negative logic ^{A)}	7789768xxx	1	H2016	2				
XIOC-8DI	8 DI, positive logic	7789862xxx	1	H2008	1					
	8 DI, negative logic ^{A)}	7789863xxx	1	H2016	1					
DO	XIOC-12DO-R ^{B)}	12 DO	7789871xxx	1	R2416	1				
	XIOC-16DO	16 DO	7789865xxx	1	H2016	1			O2016	1
	XIOC-16DO-S	16 DO	7789865xxx	1	H2016	1			O2016	1
	XIOC-32DO	32 DO	7789866xxx	1	H2016	2			O2016	2
	XIOC-8DO	8 DO	7789865xxx	1	H2008	1			O2008	1
DI/DO	XIOC-16DX	16 DI	7789872xxx	1	H2016	1				
		16 DO								
AI	XIOC-8AI-U2	8 AI	7789867xxx	1	A2508	1				
		8 AI	7789867xxx	1	A2508	1				
		8 AI	7789867xxx	1	A2508	1				
AO	XIOC-2AO-U1-2AO-U2	4 AO	7789868xxx	1	A1504	1				
		2 AO	7789868xxx	1	A1504	1				
		4 AO	7789868xxx	1	A1504	1				
		4 AO	7789868xxx	1	A1504	1				
AI/AO	XIOC-2AI-1AO-U1	2 AI	7789870xxx	1	A1504	1				
		2 AO								
	XIOC-2AI-1AO-U1-I1	2 AI	7789870xxx	1	A1504	1				
		2 AO								
	XIOC-4AI-2AO-U1	4 AI	7789869xxx	1	A2508	1				
		2 AO								
XIOC-4AI-2AO-U1-I1	4 AI	7789869xxx	1	A2508	1					
	2 AO									

Note
 A) Attention! Only use interfaces without LEDs
 B) The 24 V DC power supply should be provided externally

- Please, always take into account the characteristics of the PLC card (voltage, current...) when selecting interfaces. In some cases, the card can work at higher voltages than those indicated in the interface.
- The interfaces are intended to be used inside an IP20 enclosure at least.
- The last 3 digits of the cable code indicate its length in decimetres. For example, if the code ends in 100, the cable would be 10 m long.

* In the case that an input/output card does not appear in this table, you can check our on-line PLC selection guide at www.weidmueller.com where you will always find the most up-to-date information.

PLC OMRON – CJ1W



	PLC		Cables		Interfaces					
	Input/Output cards		Standard		Direct inputs/outputs		Insulated inputs		Insulated outputs	
	Manufacturer code	Number/Type of channels	Order No.	Quantity	- see page A.39 (H,R) or A.53 (A) -		- see page A.58 -		- see page A.62 -	
					Type	Quantity	Type	Quantity	Type	Quantity
DI	IA111	16 DI	7789664xxx	1	R2416	1				
	ID211	16 DI, positive logic	7789645xxx	1	H2016	1	I2016	1		
		16 DI, negative logic ^{A)}	7789833xxx	1	H2016	1				
	ID231	32 DI, positive logic	7789771xxx	1	H2016	2	I2016	2		
		32 DI, negative logic ^{A)}	7789768xxx	1	H2016	2				
	ID232	32 DI, positive logic	7789772xxx	1	H2016	2	I2016	2		
		32 DI, negative logic ^{A)}	7789767xxx	1	H2016	2				
	ID261	64 DI, positive logic	7789771xxx	2	H2016	4	I2016	4		
64 DI, negative logic ^{A)}		7789768xxx	2	H2016	4					
ID262	64 DI, positive logic	7789772xxx	2	H2016	4	I2016	4			
	64 DI, negative logic ^{A)}	7789767xxx	2	H2016	4					
DO	OC201	8 DO	7789649xxx	1	R2416	1				
	OC211	16 DO	7789664xxx	1	R2416	1				
	OD201 ^{B)}	8 DO	7789650xxx	1	H2016	1			O2016N	1
	OD202	8 DO	7789650xxx	1	H2008	1			O2008	1
	OD211 ^{B)}	16 DO	7789794xxx	1	H2016	1			O2016N	2
	OD212	16 DO	7789794xxx	1	H2016	1			O2016	2
	OD231 ^{B)}	32 DO	7789793xxx	1	H2016	2			O2016N	2
	OD232	32 DO	7789373xxx	1	H2016	2			O2016	2
	OD233 ^{B)}	32 DO	7789373xxx	1	H2016	2			O2016N	2
	OD261 ^{B)}	64 DO	7789793xxx	2	H2016	4			O2016N	4
	OD262	64 DO	7789373xxx	2	H2016	4			O2016	4
	OD263 ^{B)}	64 DO	7789373xxx	2	H2016	4			O2016N	4
DI/DO	MD232	16 DI, positive logic	7789328xxx	1	H2016	1				
		16 DO	7789329xxx	1	H2016	1			O2016	1
	MD232 ^{C)}	16 DI, negative logic	7789329xxx	1	H2016	1				
		16 DO	7789329xxx	1	H2016	1			O2016	1

Note
A) Attention! Only use interfaces without LEDs
B) Attention! Use only interfaces without LEDs for the direct option.
C) Attention! Use only interfaces without LEDs for the direct input option

- Please, always take into account the characteristics of the PLC card (voltage, current...) when selecting interfaces. In some cases, the card can work at higher voltages than those indicated in the interface.
- The interfaces are intended to be used inside an IP20 enclosure at least.
- The last 3 digits of the cable code indicate its length in decimetres. For example, if the code ends in 100, the cable would be 10 m long.

* In the case that an input/output card does not appear in this table, you can check our on-line PLC selection guide at www.weidmuller.com where you will always find the most up-to-date information.

PLC ROCKWELL – COMPACT LOGIX



A

	PLC		Cables		Interfaces					
	Input/Output cards		Standard		Direct inputs/outputs		Insulated inputs		Insulated outputs	
					- see page A.39 (H,R) or A.53 (A) -		- see page A.58 -		- see page A.62 -	
	Manufacturer code	Number/Type of channels	Order No.	Quantity	Type	Quantity	Type	Quantity	Type	Quantity
DI	1769-IA16	16 DI	7789025xxx	1	R2416	1				
	1769-IA8I	8 DI	7789016xxx	1	R2416	1				
	1769-IM12	12 DI	7789025xxx	1	R2416	1				
	1769-IQ16	16 DI, positive logic	7789770xxx	1	H2016	1	I2016	1		
		16 DI, negative logic ^{A)}	7789831xxx	1	H2016	1				
	1769-IQ16F	16 DI, positive logic	7789770xxx	1	H2016	1	I2016	1		
		16 DI, negative logic ^{A)}	7789831xxx	1	H2016	1				
	1769-IQ32	32 DI, positive logic	7789770xxx	1	H2016	2	I2016	2		
			7789695xxx	1						
1769-IQ32 ^{A)}	32 DI, negative logic	7789831xxx	1	H2016	2					
		7789832xxx	1							
1769-IQ32T	32 DI, positive logic	1489160xxx	1	H2016	2	I2016	2			
		1489180xxx	1							
DO	1769-OA16	16 DO	7789024xxx	1	R2416	1				
	1769-OB16	16 DO	7789769xxx	1	H2016	1			O2016	1
	1769-OB16P	16 DO	7789769xxx	1	H2016	1			O2016	1
			7789697xxx	1					O2016	2
	1769-OB32	32 DO	1489170xxx	1	H2016	2			O2016	2
	1769-OB32T	32 DO	7789015xxx	1	H2008	1			O2008	1
	1769-OB8	8 DO	7789769xxx	1	H2016	1				
	1769-OV16 ^{A)}	16 DO	7789024xxx	1	R2416	1				
	1769-OW16	16 DO	7789016xxx	1	R2416	1				
1769-OW8I	8 DO	7789026xxx	1	A1504	1					
AI	1769-IF4	4 AI, current applications	7789046xxx	1	A1504	1				
	1769-IF4	4 AI, voltage applications	7789027xxx	1	A1504	1				
	1769-IF4I	4 AI, current applications	7789047xxx	1	A1504	1				
	1769-IF4I	4 AI, voltage applications	7789028xxx	1	A2508	1				
	1769-IF8	8 AI, current applications	7789045xxx	1	A2508	1				
	1769-IF8	8 AI, voltage applications	7789029xxx	1	A1504	1				
AO	1769-OF2	2 AO	7789043xxx	1	A1504	1				
	1769-OF4CI	4 AO	7789044xxx	1	A2508	1				
	1769-OF8C	8 AO	7789044xxx	1	A2508	1				
	1769-OF8V	8 AO	7789044xxx	1	A2508	1				

Note A) Attention! Only use interfaces without LEDs

- Please, always take into account the characteristics of the PLC card (voltage, current...) when selecting interfaces. In some cases, the card can work at higher voltages than those indicated in the interface.
- The interfaces are intended to be used inside an IP20 enclosure at least.
- The last 3 digits of the cable code indicate its length in decimetres. For example, if the code ends in 100, the cable would be 10 m long.

* In the case that an input/output card does not appear in this table, you can check our on-line PLC selection guide at www.weidmueller.com where you will always find the most up-to-date information.

PLC ROCKWELL – CONTROL LOGIX



	PLC		Cables		Interfaces					
	Input/Output cards		Standard		Direct inputs/outputs		Insulated inputs		Insulated outputs	
	Manufacturer code	Number/Type of channels	Order No.	Quantity	- see page A.39 (H,R) or A.53 (A) -		- see page A.58 -		- see page A.62 -	
					Type	Quantity	Type	Quantity	Type	Quantity
DI	1756-IA16	16 DI	7789031xxx	1	R2416	1				
	1756-IA16I	16 DI	7789030xxx	1	R3632	1				
	1756-IB16	16 DI	7789039xxx	1	H2016	1	I2016	1		
	1756-IB16D	16 DI	7789049xxx	1	H2016	1	I2016	1		
	1756-IB16I	16 DI	7789049xxx	1	H2016	1	I2016	1		
	1756-IB32	32 DI	7789041xxx	1	H2016	2	I2016	2		
	1756-IC16	16 DI	7789031xxx	1	R2416	1				
	1756-IH16I	16 DI	7789030xxx	1	R3632	1				
	1756-IM16I	16 DI	7789030xxx	1	R3632	1				
1756-IN16	16 DI	7789031xxx	1	R3632	1					
DO	1756-OA16	16 DO	7789056xxx	1	R3632	1				
	1756-OA16I	16 DO	7789030xxx	1	R3632	1				
	1756-OB16D	16 DO	7789040xxx	1	H2016	1			O2016	1
	1756-OB16E	16 DO	7789058xxx	1	H2016	1			O2016	1
	1756-OB16I	16 DO	7789059xxx	1	H2016	1			O2016	1
	1756-OB32	32 DO	7789042xxx	1	H2016	2			O2016	2
	1756-OB8	8 DO	7789151xxx	1	H2008	1			O2008	1
	1756-OB8EI	8 DO	7789152xxx	1	H2008	1			O2008	1
	1756-OC8	8 DO	7789153xxx	1	R2416	1				
	1756-OH8I	8 DO	7789154xxx	1	R2416	1				
	1756-OV16E	16 DO	7789058xxx	1	H2016	1			O2016	1
	1756-OW16I	16 DO	7789030xxx	1	R3632	1				
	1756-OW16I	16 DO ^{A)}	7789059xxx	1	H2016	1			O2016	1
	1756-OX8I	8 DO	7789155xxx	1	R2416	1				
AI	1756-IF16 / 1756-IF16H	16 AI	7789032xxx	1	A3716	1				
	1756-IF6I	6 AI, current applications	7789156xxx	1	A2508	1				
	1756-IF6I	6 AI, voltage applications	7789157xxx	1	A2508	1				
	1756-IF8	8 AI, current applications	7789035xxx	1	A2508	1				
	1756-IF8	8 AI, voltage applications	7789036xxx	1	A2508	1				
	1756-IR6I	6 AI	7789158xxx	1	A2508	1				
	1756-IF8IH	8 AI	2733480xxx	1	A2508	1				
1756-IF16IH	16AI	2733490xxx	1	A3716	1					
AO	1756-OF4	4 AO, current applications	7789033xxx	1	A1504	1				
	1756-OF4	4 AO, voltage applications	7789034xxx	1	A1504	1				
	1756-OF6CI	6 AO, resistances 0 to 550 Ω	7789159xxx	1	A2508	1				
	1756-OF6VI	6 AO	7789157xxx	1	A2508	1				
	1756-OF8/ 1756-OF8H	8 AO, current applications	7789037xxx	1	A2508	1				
	1756-OF8/ 1756-OF8H	8 AO, voltage applications	7789038xxx	1	A2508	1				
1756-OF8IH	8 AI	2733480xxx	1	A2508	1					

Hinweis A) Only valid for 24Vdc voltage

- Please, always take into account the characteristics of the PLC card (voltage, current...) when selecting interfaces. In some cases, the card can work at higher voltages than those indicated in the interface.
- The interfaces are intended to be used inside an IP20 enclosure at least.
- The last 3 digits of the cable code indicate its length in decimetres. For example, if the code ends in 100, the cable would be 10 m long.

* In the case that an input/output card does not appear in this table, you can check our on-line PLC selection guide at www.weidmuller.com where you will always find the most up-to-date information.

PLC ROCKWELL – MICRO LOGIX 1400

A

	PLC		Cables		Interfaces					
	Input/Output cards		Standard		Direct inputs/outputs		Insulated inputs		Insulated outputs	
					- see page A.39 (H,R) or A.53 (A) -		- see page A.58 -		- see page A.62 -	
	Manufacturer code	Number/Type of channels	Order No.	Quantity	Type	Quantity	Type	Quantity	Type	Quantity
DI	1762-IQ16	16 DI	7789100xxx	1	H2016	1	I2016	1		
	1762-IQ8	8 DI	7789100xxx	1	H2008	1				
DO	1762-OB16	16 DO	7789100xxx	1	H2016	1			O2016	1
	1762-OB8	8 DO	7789100xxx	1	H2008	1			O2008	1
	1762-OV32T ^{A)}	32 DO	7789006xxx	1	H2016	2			O2016N	2
	1762-OW16	16 DO	7789104xxx	1	R2416	1				
	1762-OX6I	6 DO	7789106xxx	1	R3632	1				
AI	1762-IF4	4 AI	1350480xxx	1	A1504	1				
	1762-IR4	4 AI, 2-wire applications	1350480xxx	1	A1504	1				
	1762-IR4 ^{B)}	4 AI, 3 and 4-wire applications	1350490xxx	1	A2508	1				
AO	1762-OF4	4 AO	1350480xxx	1	A1504	1				
AI/AO	1762-IF20F2	2 AI	1350480xxx	1	A1504	1				
		2 AO								

Note
 A) Attention! Use only interfaces without LEDs for the direct option.
 B) Attention! Only use Interfaces without disconnectors and test points

- Please, always take into account the characteristics of the PLC card (voltage, current...) when selecting interfaces.
 In some cases, the card can work at higher voltages than those indicated in the interface.
 - Cables 7789100xxx, 7789104xxx, 7789106xxx, 7789108xxx, 1350480xxx, 1350490xxx and 1350500xxx have wire-end ferrules at one end. These cables do not have a PLC connector. Colour code according to DIN 47100.
 - The interfaces are intended to be used inside an IP20 enclosure at least.
 - The last 3 digits of the cable code indicate its length in decimetres. For example, if the code ends in 100, the cable would be 10 m long.
- * In the case that an input/output card does not appear in this table, you can check our on-line PLC selection guide at www.weidmuller.com where you will always find the most up-to-date information.

PLC SCHNEIDER – M258

	PLC		Cables		Interfaces					
	Input/Output cards		Standard		Direct inputs/outputs		Insulated inputs		Insulated outputs	
					- see page A.39 (H,R) or A.53 (A) -		- see page A.58 -		- see page A.62 -	
	Manufacturer code	Number/Type of channels	Order No.	Quantity	Type	Quantity	Type	Quantity	Type	Quantity
DI	TM5SDI12D	12 DI	7789840xxx	1	H2016	1				
	TM5SDI2D	2 DI	7789100xxx	1	H20	1				
	TM5SDI4D	4 DI	7789100xxx	1	H20	1				
	TM5SDI6D	6 DI	7789100xxx	1	H20	1				
DO	TM5SDO12T	12 DO	7789840xxx	1	H2016	1			02016	1
	TM5SDO2T	2 DO	7789100xxx	1	H20	1				
	TM5SDO4T	4 DO	7789100xxx	1	H20	1				
	TM5SDO4TA	4 DO	7789100xxx	1	H20	1				
	TM5SDO6T	6 DO	7789100xxx	1	H20	1				
	TM5SDO8TA	8 DO	7789857xxx	1	H2008	1			02008	1
DI/DO	TM5SDM12DT	8 DI	7789859xxx	1	H2008	1				
		4 DO			H2008	1			02008	1
AI	TM5SAI2PH	2 AI	7789841xxx	1	A15	1				
	TM5SAI4PH	4 AI	7789841xxx	1	A15	1				

Note

- Please, always take into account the characteristics of the PLC card (voltage, current...) when selecting interfaces.
In some cases, the card can work at higher voltages than those indicated in the interface.
 - Cables 7789100xxx, 7789104xxx, 7789106xxx, 7789108xxx, 1350480xxx, 1350490xxx and 1350500xxx have wire-end ferrules at one end. These cables do not have a PLC connector. Colour code according to DIN 47100.
 - The interfaces are intended to be used inside an IP20 enclosure at least.
 - The last 3 digits of the cable code indicate its length in decimetres. For example, if the code ends in 100, the cable would be 10 m long.
- * In the case that an input/output card does not appear in this table, you can check our on-line PLC selection guide at www.weidmuller.com where you will always find the most up-to-date information.

PLC SCHNEIDER – M340 / M580



A

	PLC		Cables		Interfaces					
	Input/Output cards		Standard		Direct inputs/outputs		Insulated inputs		Insulated outputs	
	Manufacturer code	Number/Type of channels	Order No.	Quantity	Type	Quantity	Type	Quantity	Type	Quantity
DI	BMX DAI 1602	16 DI, negative logic ^{A)}	7789630xxx	1	H2016	1				
		16 DI, positive logic	7789382xxx	1	R2416	1				
	BMX DAI 1603	16 DI	7789382xxx	1	R2416	1				
	BMX DAI 1604	16 DI	7789382xxx	1	R2416	1				
	BMX DDI 1602	16 DI	7789380xxx	1	H2016	1	I2016	1		
	BMX DDI 1603	16 DI	7789382xxx	1	R2416	1				
DO	BMX DDI 3202 K	32 DI	7789387xxx	1	H2016	2	I2016	2		
	BMX DDI 6402 K	64 DI	7789387xxx	2	H2016	4	I2016	4		
	BMX DAO 1605	16 DO	7789383xxx	1	R2416	1				
	BMX DDO 1602	16 DO	7789380xxx	1	H2016	1			O2016	1
	BMX DDO 1612 ^{B)}	16 DO	7789380xxx	1	H2016	1			O2016N	1
	BMX DDO 3202 K	32 DO	7789387xxx	1	H2016	2			O2016	2
	BMX DDO 6402 K	64 DO	7789387xxx	2	H2016	4			O2016	4
	BMX DRA 0805	8 DO	7789633xxx	1	R2416	1				
	BMX DRA 1605	16 DO	7789384xxx	1	R2416	1				
	DI/DO	BMX DDM 16022	8 DI	7789386xxx	1	H2008	1			
8 DO			H2008			1			O2008	1
BMX DDM 3202 K		16 DI	7789387xxx	1	H2016	1				
16 DO	H2016	1					O2016	1		
AI	BMX AMI 0410	4 AI, current applications	7789638xxx	1	A1504	1				
	BMX AMI 0410	4 AI, voltage applications	7789637xxx	1	A1504	1				
	BMX ART 0414	4 AI	7789639xxx	1	A3716	1				
	BMX AMI 0810	8AI, current applications	7789846xxx	1	A2508	1				
	BMX AMI 0800	8AI, current applications	7789846xxx	1	A2508	1				
	BMX AMI 0800	8AI, voltage/current applications	1479600xxx	1	H40	1				
AO	BMX ART 0814	8 AI	7789639xxx	2	A3716	2				
	BMX AMO 0210	2 AO	7789640xxx	1	A1504	1				
	BMX AMO 0410	4 AO	7789637xxx	1	A1504	1				
AI/AO	BMX AMO 0802	8 AO	7789847xxx	1	A2508	1				
	BMX AMM 0600	4 AI + 2 AO, current applications	7789629xxx	1	A1504	2				
	BMX AMM 0600	4 AI + 2 AO, voltage applications	7789628xxx	1	A1504	2				

Note
 A) Attention! Only use interfaces without LEDs
 B) Attention! Use only interfaces without LEDs for the direct option.

- Please, always take into account the characteristics of the PLC card (voltage, current...) when selecting interfaces. In some cases, the card can work at higher voltages than those indicated in the interface.
- The interfaces are intended to be used inside an IP20 enclosure at least.
- The last 3 digits of the cable code indicate its length in decimetres. For example, if the code ends in 100, the cable would be 10 m long.

* In the case that an input/output card does not appear in this table, you can check our on-line PLC selection guide at www.weidmueller.com where you will always find the most up-to-date information.

PLC SCHNEIDER – MICRO



	PLC		Cables		Interfaces					
	Input/Output cards		Standard		Direct inputs/outputs		Insulated inputs		Insulated outputs	
	Manufacturer code	Number/Type of channels	Order No.	Quantity	- see page A.39 (H,R) or A.53 (A) -		- see page A.58 -		- see page A.62 -	
					Type	Quantity	Type	Quantity	Type	Quantity
DI	TSX DEZ 12D2 ^{A)}	12 DI	7789312xxx	1	H2016	1				
	TSX DEZ 12D2K	12 DI	7789301xxx	1	H2016	1				
	TSX DEZ 32D2	32 DI	7789314xxx	1	H2016	2				
DO	TSX DSZ 32R5	32 DO	7789330xxx	1	R3632	1				
	TSX DSZ 32T2	32 DO	7789314xxx	1	H2016	2				
	TSX DSZ 04T22	4 DO	7789312xxx	1	H2008	1			02008	1
	TSX DSZ 08R5	16 DO	7789308xxx	1	R2416	1				
	TSX DSZ 08T2	8 DO	7789312xxx	1	H2008	1			02008	1
	TSX DSZ 08T2K	8 DO	7789301xxx	1	H2008	1			02008	1
						H2008	1			
DI/DO	TSX DMZ 16DTK	8 DI	7789834xxx	1	H2008	1				
		8 DO			H2008	1			02008	1
	TSX DMZ 28AR	16 DI	7789331xxx	1	R2416	1				
		12 DO			R2416	1				
	TSX DMZ 28DR	16 DI	7789331xxx	1	R2416	1				
		12 DO			R2416	1				
	TSX DMZ 28DT	16 DI	7789313xxx	1	H2016	1				
		12 DO			H2016	1			02016	1
	TSX DMZ 28DTK	16 DI	7789301xxx	1	H2016	1				
		12 DO	7789301xxx	1	H2016	1			02016	1
	TSX DMZ 64DTK	32 DI	7789301xxx	2	H2016	2				
		32 DO	7789301xxx	2	H2016	2			02016	2
AI	TSX AEZ 414	4 AI	7789309xxx	1	A1504	1				
	TSX AEZ 801	8 AI	7789311xxx	1	A2508	1				
	TSX AEZ 802	8 AI	7789311xxx	1	A2508	1				
AO	TSX ASZ 200	2 AO	7789310xxx	1	A1504	1				
	TSX ASZ 401	4 AO	7789310xxx	1	A1504	1				

Note A) Attention! Only use interfaces without LEDs

- Please, always take into account the characteristics of the PLC card (voltage, current...) when selecting interfaces. In some cases, the card can work at higher voltages than those indicated in the interface.
 - The interfaces are intended to be used inside an IP20 enclosure at least.
 - The last 3 digits of the cable code indicate its length in decimetres. For example, if the code ends in 100, the cable would be 10 m long.
- * In the case that an input/output card does not appear in this table, you can check our on-line PLC selection guide at www.weidmuller.com where you will always find the most up-to-date information.

PLC SCHNEIDER – QUANTUM



A

	PLC		Cables		Interfaces					
	Input/Output cards		Standard		Direct inputs/outputs		Insulated inputs		Insulated outputs	
	Manufacturer code	Number/Type of channels	Order No.	Quantity	Type	Quantity	Type	Quantity	Type	Quantity
DI	140 DAI 340 00	16 DI	7789118xxx	1	R3632	1				
	140 DAI 353 00	32 DI	7789118xxx	1	R3632	1				
	140 DAI 440 00	16 DI	7789118xxx	1	R3632	1				
	140 DAI 453 00	32 DI	7789118xxx	1	R3632	1				
	140 DAI 540 00	16 DI	7789118xxx	1	R3632	1				
	140 DAI 543 00	16 DI	7789113xxx	1	R2416	1				
	140 DAI 553 00	32 DI	7789118xxx	1	R3632	1				
	140 DAI 740 00	16 DI	7789118xxx	1	R3632	1				
	140 DDI 353 00	32 DI	7789121xxx	1	H2016	2	I2016	2		
	140 DDI 364 00	96 DI	7789301xxx	6	H2016	6	I2016	6		
	140 DDI 841 00	16 DI	7789119xxx	1	H2016	1	I2016	1		
140 DDI 853 00	32 DI	7789121xxx	1	H2016	2	I2016	2			
DO	140 DAO 840 00	16 DO	7789118xxx	1	R3632	1				
	140 DAO 842 10	16 DO	7789113xxx	1	R2416	1				
	140 DDO 353 00	32 DO	7789121xxx	1	H2016	2			O2016	2
	140 DDO 364 00	96 DO	7789301xxx	6	H2016	6			O2016	6
	140 DDO 843 00	16 DO	7789120xxx	1	H2016	1			O2016	1
140 DRA 840 00	16 DO	7789118xxx	1	R3632	1					
DI/DO	140 DDM 390 00	16 DI	7789133xxx	1	H2016	1				
		8 DO			H2008	1			O2008	1
AI	140 ACI 030 00	8 AI, current applications	7789125xxx	1	A2508	1				
	140 ACI 030 00	8 AI, voltage applications	7789134xxx	1	A2508	1				
	140 ACI 040 00	16 AI	7789123xxx	1	A3716	1				
	140 AII 330 00	8 AI, 2-wire resistances applications	7789136xxx	1	A2508	1				
	140 ARI 030 10	8 AI, 2-wire resistances applications	7789135xxx	1	A2508	1				
	140 AVI 030 00	8 AI, current applications	7789125xxx	1	A2508	1				
AO	140 AVI 030 00	8 AI, voltage applications	7789134xxx	1	A2508	1				
	140 ACO 020 00	4 AO	7789124xxx	1	A1504	1				
	140 ACO 130 00	8 AO, without monitoring	7789126xxx	1	A2508	1				
	140 AIO 330 00	8 AIO	7789137xxx	1	A2508	1				

Note

- Please, always take into account the characteristics of the PLC card (voltage, current...) when selecting interfaces. In some cases, the card can work at higher voltages than those indicated in the interface.
- The interfaces are intended to be used inside an IP20 enclosure at least.
- The last 3 digits of the cable code indicate its length in decimetres. For example, if the code ends in 100, the cable would be 10 m long.

* In the case that an input/output card does not appear in this table, you can check our on-line PLC selection guide at www.weidmueller.com where you will always find the most up-to-date information.

PLC SCHNEIDER – TM3

	PLC		Cables		Interfaces					
	Input/Output cards		Standard		Direct inputs/outputs		Insulated inputs		Insulated outputs	
					- see page A.39 (H,R) or A.53 (A) -		- see page A.58 -		- see page A.62 -	
	Manufacturer code	Number/Type of channels	Order No.	Quantity	Type	Quantity	Type	Quantity	Type	Quantity
DI	TM3DI8A	8DI	2858220xxx	1	R2416	1				
	TM3DI8 / TM3DI8G	8DI, positive logic	2857910xxx	1	H2008	1	I2016	1		
	TM3DI16 / TM3DI16G	16DI, positive logic	2857920xxx	1	H2016	1	I2016	1		
	TM3DI16K	16DI, positive logic	2534060xxx	1	H2016	1	I2016	1		
	TM3DI32K	32DI, positive logic	2534060xxx	2	H2016	2	I2016	2		
DO	TM3DQ8R / TM3DQ8RG ^{B)}	8DO, positive logic	2857930xxx	1	H2008	1			O2008	1
	TM3DQ8T / TM3DQ8TG	8DO	2857940xxx	1	H2008	1			O2008	1
	TM3DQ8U / TM3DQ8UG ^{A)}	8DO	2857950xxx	1	H2008	1			O2008N	1
	TM3DQ16R / TM3DQ16RG ^{B)}	16DO, positive logic	2857960xxx	1	H2016	1			O2016	1
	TM3DQ16T / TM3DQ16TG	16DO	2857970xxx	1	H2016	1			O2016	1
	TM3DQ16U / TM3DQ16UG ^{A)}	16DO	2858090xxx	1	H2016	1			O2016N	1
	TM3DQ16TK	16DO	7789329xxx	1	H2016	1			O2016	1
	TM3DQ16UK ^{A)}	16DO	2858110xxx	1	H2016	1			O2016N	1
	TM3DQ32TK	32DO	7789329xxx	2	H2016	2			O2016	2
	TM3DQ32UK ^{A)}	32DO	2858110xxx	2	H2016	2			O2016N	2
DI/DO	TM3DM24R / TM3DM24RG ^{B)}	16DI	2858120xxx	1	H2016	1	I2016	1		
		8DO, positive logic	2857930xxx	1	H2008	1			O2008	1
AI	TM3AI2H / TM3AI2HG	2AI	2858130xxx	1	A1504	1				
	TM3AI4 / TM3AI4G	4AI	2858140xxx	1	A1504	1				
	TM3AI8 / TM3AI8G	8AI	2858150xxx	1	A2508	1				
	TM3TI4 / TM3TI4G	4AI	2858140xxx	1	A1504	1				
AO	TM3AQ2 / TM3AQ2G	2AO	2858160xxx	1	A1504	1				
	TM3AQ4 / TM3AQ4G	4AO	2858170xxx	1	A1504	1				
AI/O	TM3AM6 / TM3AM6G	4AI	2858180xxx	1	A2508	1				
		2AO								
	TM3TM3 / TM3TM3G	2AI	2858190xxx	1	A1504	1				
		1AO								

Note A) Attention! Only use interfaces without LEDs
 B) Only possible if configured at 24 V DC

- Please, always take into account the characteristics of the PLC card (voltage, current...) when selecting interfaces. In some cases, the card can work at higher voltages than those indicated in the interface.
- The interfaces are intended to be used inside an IP20 enclosure at least.
- The last 3 digits of the cable code indicate its length in decimetres. For example, if the code ends in 100, the cable would be 10 m long.

* In the case that an input/output card does not appear in this table, you can check our on-line PLC selection guide at www.weidmueller.com where you will always find the most up-to-date information.

PLC SCHNEIDER – TWIDO



A

	PLC		Cables		Interfaces					
	Input/Output cards		Standard		Direct inputs/outputs		Insulated inputs		Insulated outputs	
	Manufacturer code	Number/Type of channels	Order No.	Quantity	- see page A.39 (H,R) or A.53 (A) -		- see page A.58 -		- see page A.62 -	
					Type	Quantity	Type	Quantity	Type	Quantity
DI	TWD DDI 16DK	16 DI, positive logic	7789328xxx	1	H2016	1	I2016	1		
	TWD DDI 16DT	16 DI, positive logic	7789100xxx	1	H2016	1	I2016	1		
	TWD DDI 16DT ^{A)}	16 DI, negative logic	7789100xxx	1	H2016	1				
	TWD DDI 32DK	32 DI	7789328xxx	2	H2016	2	I2016	2		
	TWD DDI 8DT	8 DI, positive logic	7789100xxx	1	H2008	1	I2016	1		
	TWD DDI 8DT ^{A)}	8 DI, negative logic	7789100xxx	1	H2016	1				
DO	TWD DDO 16TK	16 DO	7789329xxx	1	H2016	1			O2016	1
	TWD DDO 16UK ^{B)}	16 DO	7789328xxx	1	H2016	1			O2016N	1
	TWD DDO 32TK	32 DO	7789329xxx	2	H2016	2			O2016	2
	TWD DDO 32UK ^{B)}	32 DO	7789328xxx	2	H2016	2			O2016N	2
	TWD DDO 8TT	8 DO	7789100xxx	1	H2008	1			O2008	1
	TWD DDO 8UT ^{A)}	8 DO	7789100xxx	1	H2016	1				
	TWD DRA 16RT	16 DO	7789104xxx	1	R2416	1				
DI/DO	TWD LMDA 20DRT	12 DI, positive logic	7789100xxx	1	H2016	1				
		8 DO	7789104xxx	1	R2416	1				
	TWD LMDA 20DRT ^{B)}	12 DI, negative logic	7789100xxx	1	H2016	1				
		8 DO	7789104xxx	1	R2416	1				
	TWD LMDA 20DTK	12 DI, positive logic	7789327xxx	1	H2016	1				
		8 DO			H2016	1			O2016	1
	TWD LMDA 20DUK ^{C)}	12 DI, positive logic	7789326xxx	1	H2016	1				
		8 DO			H2016	1				
TWD LMDA 40DTK	24 DI, positive logic	7789327xxx	2	H2016	2					
	16 DO			H2008	2			O2008	2	
TWD LMDA 40DUK ^{C)}	24 DI, positive logic	7789326xxx	2	H2016	2					
	16 DO			H2016	2					
AI	TWD AMI 2HT	2 AI	1350480xxx	1	A1504	1				
AO	TWD AMO 1HT	1 AI	1350480xxx	1	A1504	1				
AI/AO	TWD ALM 3LT	2 AI	1350480xxx	1	A1504	1				
		1 AO				1				
	TWD AMM 3HT	2 AI	1350480xxx	1	A1504	1				
		1 AO				1				

Note
 A) Attention! Only use interfaces without LEDs
 B) Attention! Use only interfaces without LEDs for the direct option.
 C) Attention! Use only interfaces without LEDs for the direct output option.

- Please, always take into account the characteristics of the PLC card (voltage, current...) when selecting interfaces. In some cases, the card can work at higher voltages than those indicated in the interface.
 - Cables 7789100xxx, 7789104xxx, 7789106xxx, 7789108xxx, 1350480xxx, 1350490xxx and 1350500xxx have wire-end ferrules at one end. These cables do not have a PLC connector. Colour code according to DIN 47100.
 - The interfaces are intended to be used inside an IP20 enclosure at least.
 - The last 3 digits of the cable code indicate its length in decimetres. For example, if the code ends in 100, the cable would be 10 m long.
- * In the case that an input/output card does not appear in this table, you can check our on-line PLC selection guide at www.weidmueller.com where you will always find the most up-to-date information.

PLC SIEMENS – S7-200

	PLC		Cables		Interfaces					
	Input/Output cards		Standard		Direct inputs/outputs		Insulated inputs		Insulated outputs	
					- see page A.39 (H,R) or A.53 (A) -		- see page A.58 -		- see page A.62 -	
	Manufacturer code	Number/Type of channels	Order No.	Quantity	Type	Quantity	Type	Quantity	Type	Quantity
DI	6ES7221-1BF22-0XA0	8 DI	7789100xxx	1	H2008	1				
	6ES7221-1BH22-0XA0	16 DI	7789100xxx	1	H2016	1	I2016	1		
	6ES7221-1EF22-0XA0	8 DI	7789104xxx	1	R2416	1				
DO	6ES7222-1BD22-0XA0	4 DO	7789100xxx	1	H2008	1			O2008	1
	6ES7222-1BF22-0XA0	8 DO	7789100xxx	1	H2008	1			O2008	1
	6ES7222-1EF22-0XA0	8 DO	7789104xxx	1	R2416	1				
	6ES7222-1HD22-0XA0	8 DO	7789104xxx	1	R2416	1				
DI/DO	6ES7223-1BF22-0XA0	4 DI	7789100xxx	2	H2008	1			O2008	1
		4 DO			H2008	1				
	6ES7223-1BH22-0XA0	8 DI	7789100xxx	2	H2008	1			O2008	1
		8 DO			H2008	1				
	6ES7223-1BL22-0XA0	16 DI	7789100xxx	2	H2016	1			O2016	1
		16 DO			H2016	1				
	6ES7223-1BM22-0XA0	32 DI	7789100xxx	4	H2016	2			O2016	2
		32 DO			H2016	2				
	6ES7223-1PL22-0XA0	16 DI	7789100xxx	1	H2016	1				
		16 DO			7789104xxx	1	R2416	1		
6ES223-1PM22-0XA0	32 DI	7789100xxx	2	H2016	2					
	32 DO			7789104xxx	2	R2416	2			
AI	6ES7231-0HC22-0XA0	4 AI	1350480xxx	1	A1504	1				
	6ES7231-0HF22-0XA0	8 AI	1350490xxx	1	A2508	1				
AO	6ES7232-0HB22-0XA0	2 AO	1350480xxx	1	A1504	1				
	6ES7232-0HD22-0XA0	4 AO	1350480xxx	1	A1504	1				
AI/AO	6ES7235-0KD22-0XA0	4 AI / 1 AO	1350490xxx	1	A2508	1				
DI/DO/AI	6ES7214-1AE30-0XB0	14 DI	7789100xxx	1	H2016	1				
		10 DO	7789100xxx	1	H2016	1				
		2 AI	1350480xxx	1	A1504	1				
	6ES7214-1AG31-0XB0	14 DI	7789100xxx	1	H2016	1				
		10 DO	7789100xxx	1	H2016	1				
		2 AI	1350480xxx	1	A1504	1				

Note

- Please, always take into account the characteristics of the PLC card (voltage, current...) when selecting interfaces.
In some cases, the card can work at higher voltages than those indicated in the interface.
 - Cables 7789100xxx, 7789104xxx, 7789106xxx, 7789108xxx, 1350480xxx, 1350490xxx and 1350500xxx have wire-end ferrules at one end. These cables do not have a PLC connector. Colour code according to DIN 47100.
 - The interfaces are intended to be used inside an IP20 enclosure at least.
 - The last 3 digits of the cable code indicate its length in decimetres. For example, if the code ends in 100, the cable would be 10 m long.
- * In the case that an input/output card does not appear in this table, you can check our on-line PLC selection guide at www.weidmueller.com where you will always find the most up-to-date information.

PLC SIEMENS – S7-300/ET-200M



A

	PLC		Cables		Interfaces						
	Input/Output cards		Standard		Direct inputs/outputs		Insulated inputs		Insulated outputs		
	Manufacturer code	Number/Type of channels	Order No.	Quantity	- see page A.39 (H,R) or A.53 (A) -		- see page A.58 -		- see page A.62 -		
					Type	Quantity	Type	Quantity	Type	Quantity	
DI	6ES7321-1BH00-0AA0	16 DI	7789234xxx	1	H2016	1	I2016	1			
	6ES7321-1BH01-0AA0	16 DI	7789234xxx	1	H2016	1	I2016	1			
	6ES7321-1BH02-0AA0	16 DI	7789234xxx	1	H2016	1	I2016	1			
	6ES7321-1BH50-0AA0	16 DI	7789234xxx	1	H2016	1	I2016	1			
	6ES7321-1BH80-0AA0	16 DI	7789234xxx	1	H2016	1	I2016	1			
	6ES7321-1BH81-0AA0	16 DI	7789234xxx	1	H2016	1	I2016	1			
	6ES7321-1BH82-0AA0	16 DI	7789234xxx	1	H2016	1	I2016	1			
	6ES7321-1BL00-0AA0	32 DI	7789236xxx	1	H2016	2	I2016	2			
	6ES7321-1BL80-0AA0	32 DI	7789236xxx	1	H2016	2	I2016	2			
	6ES7321-1BP00-0AA0	64 DI, positive logic	7789771xxx	2	H2016	4	I2016	4			
		64 DI, negative logic ^{A)}	7789768xxx	2	H2016	4					
	6ES7321-1CH20-0AA0	16 DI	7789211xxx	1	R2416	1					
	6ES7321-1CH80-0AA0	16 DI	7789211xxx	1	R2416	1					
	6ES7321-1EH00-0AA0	16 DI	7789212xxx	1	R2416	1					
	6ES7321-1EH01-0AA0	16 DI	7789212xxx	1	R2416	1					
	6ES7321-1EL00-0AA0	32 DI	7789215xxx	1	R3632	1					
	6ES7321-1FH00-0AA0	16 DI	7789212xxx	1	R2416	1					
	6ES7321-7BH00-0AB0	16 DI	7789210xxx	1	R2416	1					
	6ES7321-7BH01-0AB0	16 DI	7789210xxx	1	R2416	1					
	6ES7321-7BH80-0AB0	16 DI	7789210xxx	1	R2416	1					
6ES7321-7RD00-0AB0	16 DI	2183160xxx	1	H20	1						
6ES7326-1BK02-0AB0	24 DI	2183170xxx	1	H40	1						
DO	6ES7322-1BF00-0AA0	8 DO	7789239xxx	1	H2008	1			O2008	1	
	6ES7322-1BF01-0AA0	8 DO	7789239xxx	1	H2008	1			O2008	1	
	6ES7322-1BH00-0AA0	16 DO	7789234xxx	1	H2016	1			O2016	1	
	6ES7322-1BH01-0AA0	16 DO	7789234xxx	1	H2016	1			O2016	1	
	6ES7322-1BH10-0AA0	16 DO	7789234xxx	1	H2016	1			O2016	1	
	6ES7322-1BH81-0AA0	16 DO	7789234xxx	1	H2016	1			O2016	1	
	6ES7322-1BL00-0AA0	32 DO	7789236xxx	1	H2016	2			O2016	2	
	6ES7322-1BP00-0AA0	64 DO	7789246xxx	2	H2016	4			O2016	4	
	6ES7322-1BP50-0AA0 ^{A)}	64 DO	7789246xxx	2	H2016	4			O2016N	4	
	6ES7322-1EH00-0AA0	16 DO	7789211xxx	1	R2416	1					
	6ES7322-1EH01-0AA0	16 DO	7789211xxx	1	R2416	1					
	6ES7322-1EL00-0AA0	32 DO	7789211xxx	2	R2416	2					
	6ES7322-1FH00-0AA0	16 DO	7789211xxx	1	R2416	1					
	6ES7322-1FL00-0AA0	32 DO	7789211xxx	2	R2416	2					
	6ES7322-1HF80-0AA0	8 DO	7789190xxx	1	R2416	1					
	6ES7322-1HH01-0AA0	16 DO, only 24Vdc	7789779xxx	1	H2016	1			O2016	1	
	6ES7322-5GH00-0AB0	16 DO	7789215xxx	1	R3632	1					
	6ES7322-5RD00-0AB0 ^{B)}	4 DO	7789192xxx	1	H2016	1					
	6ES7322-5SD00-0AB0 ^{B)}	4 DO	7789192xxx	1	H2016	1					
	6ES7322-8BF00-0AB0	8 DO, without redundancy	7789239xxx	1	H2008	1			O2008	1	
	6ES7322-8BF00-0AB0	8 DO, with redundancy	7789830xxx	1	H2008	1			O2008	1	
	6ES7322-8BH01-0AB0	16 DO, without redundancy	7789729xxx	1	H2016	1			O2016	1	
	6ES7322-8BH01-0AB0	16 DO, with redundancy	7789730xxx	1	H2016	1			O2016	1	
	6ES7326-2BF10-0AB0	16 DO	2183170xxx	1	H40	1					
	6ES7326-2BF41-0AB0	8 DO	2183170xxx	1	H40	1					
	DI/DO	6ES7323-1BH00-0A00	8 DI 8 DO	7789237xxx	1	H2008	1			O2008	1
		6ES7323-1BH01-0A00	8 DI 8 DO	7789237xxx	1	H2008	1			O2008	1
		6ES7323-1BH80-0A00	8 DI 8 DO	7789237xxx	1	H2008	1			O2008	1
6ES7323-1BH80-0A00		8 DI 8 DO	7789237xxx	1	H2008	1			O2008	1	
6ES7323-1BL00-0A00		16 DI 16 DO	7789236xxx	1	H2016	1	I2016	1	O2016	1	
AI	6ES7331-7HF01-0AB0	8 AI	7789801xxx	1	H20	1					
	6ES7331-1KF01-0AB0	8 AI	7789604xxx	1	A3716	1					
	6ES7331-1KF02-0AB0	8 AI	7789604xxx	1	A3716	1					
	6ES7331-7KB00-0AB0	2 AI	7789224xxx	1	A1504	1					

PLC SIEMENS – S7-300 / ET-200M

	PLC		Cables		Interfaces						
	Input/Output cards		Standard		Direct inputs/outputs		Insulated inputs		Insulated outputs		
					- see page A.39 (H,R) or A.53 (A) -		- see page A.58 -		- see page A.62 -		
	Manufacturer code	Number/Type of channels	Order No.	Quantity	Type	Quantity	Type	Quantity	Type	Quantity	
AI	6ES7331-7KB01-0AB0	2 AI	7789224xxx	1	A1504	1					
	6ES7331-7KB02-0AB0	2 AI	7789224xxx	1	A1504	1					
	6ES7331-7KF00-0AB0	8 AI	7789229xxx	1	A2508	1					
	6ES7331-7KF01-0AB0	8 AI	7789229xxx	1	A2508	1					
	6ES7331-7KF02-0AB0	8 AI	7789229xxx	1	A2508	1					
	6ES7331-7NF00-0AB0	8 AI	7789231xxx	1	A3716	1					
	6ES7331-7NF10-0AB0	8 AI, voltage application	7789233xxx	1	A2508	1					
		8 AI, current application	7789759xxx	1	H40	1					
	6ES7331-7PF00-0AB0	8 AI, 2-wire applications	7789230xxx	1	A2508	1					
	6ES7331-7PF00-0AB0	8 AI, 3 and 4-wire applications	7789759xxx	1	H40	1					
	6ES7331-7PF01-0AB0	8 AI, 2-wire applications	7789230xxx	1	A2508	1					
	6ES7331-7PF01-0AB0	8 AI, 3 and 4-wire applications	7789759xxx	1	H40	1					
	6ES7331-7RD00-0AB0	4 AI, 2-wire applications	7789193xxx	1	A1504	1					
	6ES7331-7RD00-0AB0	4 AI, 4-wire applications	7789194xxx	1	A2508	1					
	6ES7331-7TF01-0AB0	8 AI, 2-wire applications	7789229xxx	1	A2508	1					
6ES7331-7TF01-0AB0	8 AI, 4-wire applications	7789800xxx	1	A2508	1						
6ES7336-4GE00-0AB0	6 AI	7789801xxx	1	H20	1						
AO	6ES7332-5HB00-0AB0	2 AO, 2-wire voltage applications	7789228xxx	1	A1504	1					
	6ES7332-5HB00-0AB0	2 AO, 4-wire voltage applications	7789801xxx	1	H20	1					
	6ES7332-5HB00-0AB0	2 AO, current applications	7789227xxx	1	A1504	1					
	6ES7332-5HB01-0AB0	2 AO, 2-wire voltage applications	7789228xxx	1	A1504	1					
	6ES7332-5HB01-0AB0	2 AO, 4-wire voltage applications	7789801xxx	1	H20	1					
	6ES7332-5HB01-0AB0	2 AO, current applications	7789227xxx	1	A1504	1					
	6ES7332-5HB81-0AB0	2 AO, 2-wire voltage applications	7789228xxx	1	A1504	1					
	6ES7332-5HB81-0AB0	2 AO, 4-wire voltage applications	7789801xxx	1	H20	1					
	6ES7332-5HB81-0AB0	2 AO, current applications	7789227xxx	1	A1504	1					
	6ES7332-5HD00-0AB0	4 AO, 2-wire voltage applications	7789228xxx	1	A1504	1					
	6ES7332-5HD00-0AB0	4 AO, 4-wire voltage applications	7789801xxx	1	H20	1					
	6ES7332-5HD00-0AB0	4 AO, current applications	7789227xxx	1	A1504	1					
	6ES7332-5HD01-0AB0	4 AO, 2-wire voltage applications	7789228xxx	1	A1504	1					
	6ES7332-5HD01-0AB0	4 AO, 4-wire voltage applications	7789801xxx	1	H20	1					
	6ES7332-5HD01-0AB0	4 AO, current applications	7789227xxx	1	A1504	1					
	6ES7332-5HF00-0AB0	8 AO, voltage applications	7789759xxx	1	H40	1					
	6ES7332-5HF00-0AB0	8 AO, current applications	7789233xxx	1	A2508	1					
	6ES7332-5RD00-0AB0	4 AO	7789195xxx	1	A1504	1					
	6ES7332-7ND01-0AB0	4 AO, 2-wire voltage applications	7789228xxx	1	A1504	1					
	6ES7332-7ND01-0AB0	4 AO, 4-wire voltage applications	7789801xxx	1	H20	1					
	6ES7332-7ND01-0AB0	4 AO, current applications	7789227xxx	1	A1504	1					
	6ES7332-7ND02-0AB0	4 AO, 2-wire voltage applications	7789228xxx	1	A1504	1					
	6ES7332-7ND02-0AB0	4 AO, 4-wire voltage applications	7789801xxx	1	H20	1					
	6ES7332-7ND02-0AB0	4 AO, current applications	7789227xxx	1	A1504	1					
	6ES7332-8TF01-0AB0	8 AO	7789229xxx	1	A2508	1					
	AI/AO	6ES7334-0CE01-0AA0	4 AI + 2 AO	7789225xxx	1	A3716	1				
		6ES7334-0KE00-0AB0	4 AI + 2 AO	7789196xxx	1	A2508	1				
		6ES7335-7HG01-0AB0	4 AI + 2 AO	7789226xxx	1	A3716	1				
6ES7335-7HG02-0AB0		4 AI + 2 AO	7789226xxx	1	A3716	1					
CPU	6ES7312-5BD00-0AB0	10 DI	1431530xxx	1	H2016	1					
		6 DO			H2008	1			02008	1	
	6ES7312-5BD01-0AB0	10 DI	1431530xxx	1	H2016	1					
		6 DO			H2008	1			02008	1	
	6ES7312-5BE03-0AB0	10 DI	1431530xxx	1	H2016	1					
		6 DO			H2008	1			02008	1	
	6ES7312-5BF04-0AB0	10 DI	1431530xxx	1	H2016	1					
		8 DO			H2008	1					
	6ES7312-6EH04-0AB0	16 DI	7789222xxx	1	H2016	1	I2016	1			
		16 DO			H2016	1			02016	1	
		8 DI			7789223xxx	1	H2008	1			
	6ES7313-5BE00-0AB0	5 AI + 2 AO	7789223xxx	1	A2508P	1					
16 DI		H2016			1						
16 DO		H2016			1			02016	1		
8 DI		H2008			1						
6ES7313-5BE00-0AB0	5 AI + 2 AO	7789223xxx	1	A2508P	1						
	16 DI			H2016	1						

PLC SIEMENS – S7-300 / ET-200M

A

	PLC		Cables		Interfaces					
	Input/Output cards		Standard		Direct inputs/outputs		Insulated inputs		Insulated outputs	
	Manufacturer code	Number/Type of channels	Order No.	Quantity	Type	Quantity	Type	Quantity	Type	Quantity
CPU	6ES7313-5BE01-0AB0	16 DI	7789222xxx	1	H2016	1	I2016	1		
		16 DO			H2016	1		02016	1	
		8 DI	7789223xxx	1	H2008	1				
		5 AI + 2 AO			A2508P	1				
	6ES7313-5BF03-0AB0	16 DI	7789222xxx	1	H2016	1	I2016	1		
		16 DO			H2016	1		02016	1	
		8 DI	7789223xxx	1	H2008	1				
		5 AI + 2 AO			A2508P	1				
	6ES7313-5BG04-0AB0	16 DI	7789222xxx	1	H2016	1	I2016	1		
		16 DO			H2016	1		02016	1	
		8 DI	7789223xxx	1	H2008	1				
		5 AI + 2 AO			A2508P	1				
	6ES7313-6BE00-0AB0	16 DI	7789222xxx	1	H2016	1	I2016	1		
		16 DO			H2016	1		02016	1	
	6ES7313-6BE01-0AB0	16 DI	7789222xxx	1	H2016	1	I2016	1		
		16 DO			H2016	1		02016	1	
	6ES7313-6BF03-0AB0	16 DI	7789222xxx	1	H2016	1	I2016	1		
		16 DO			H2016	1		02016	1	
	6ES7313-6CE00-0AB0	16 DI	7789222xxx	1	H2016	1	I2016	1		
		16 DO			H2016	1		02016	1	
	6ES7313-6CE01-0AB0	16 DI	7789222xxx	1	H2016	1	I2016	1		
		16 DO			H2016	1		02016	1	
	6ES7313-6CF03-0AB0	16 DI	7789222xxx	1	H2016	1	I2016	1		
		16 DO			H2016	1		02016	1	
	6ES7314-6BF00-0AB0	16 DI	7789222xxx	1	H2016	1	I2016	1		
		16 DO			H2016	1		02016	1	
		8 DI	7789223xxx	1	H2008	1				
		5 AI + 2 AO			A2508P	1				
	6ES7314-6BF01-0AB0	16 DI	7789222xxx	1	H2016	1	I2016	1		
		16 DO			H2016	1		02016	1	
		8 DI	7789223xxx	1	H2008	1				
		5 AI + 2 AO			A2508P	1				
	6ES7314-6BF02-0AB0	16 DI	7789222xxx	1	H2016	1	I2016	1		
		16 DO			H2016	1		02016	1	
		8 DI	7789223xxx	1	H2008	1				
		5 AI + 2 AO			A2508P	1				
	6ES7314-6CF00-0AB0	16 DI	7789222xxx	1	H2016	1	I2016	1		
		16 DO			H2016	1		02016	1	
		8 DI	7789223xxx	1	H2008	1				
		5 AI + 2 AO			A2508P	1				
	6ES7314-6CF01-0AB0	16 DI	7789222xxx	1	H2016	1	I2016	1		
		16 DO			H2016	1		02016	1	
		8 DI	7789223xxx	1	H2008	1				
		5 AI + 2 AO			A2508P	1				
	6ES7314-6CF02-0AB0	16 DI	7789222xxx	1	H2016	1	I2016	1		
		16 DO			H2016	1		02016	1	
		8 DI	7789223xxx	1	H2008	1				
		5 AI + 2 AO			A2508P	1				
6ES7314-6CH04-0AB0	16 DI	7789222xxx	1	H2016	1	I2016	1			
	16 DO			H2016	1		02016	1		
	8 DI	7789223xxx	1	H2008	1					
	5 AI + 2 AO			A2508P	1					

Note A) Attention! Use only interfaces without LEDs for the direct option.
 B) This is not an ATEX solution. The interface cannot have LEDs, fuses, disconnectors or test points

- Please, always take into account the characteristics of the PLC card (voltage, current...) when selecting interfaces. In some cases, the card can work at higher voltages than those indicated in the interface.
- The interfaces are intended to be used inside an IP20 enclosure at least.
- The last 3 digits of the cable code indicate its length in decimetres. For example, if the code ends in 100, the cable would be 10 m long.

* In the case that an input/output card does not appear in this table, you can check our on-line PLC selection guide at www.weidmueller.com where you will always find the most up-to-date information.

PLC SIEMENS – S7-400



	PLC		Cables		Interfaces					
	Input/Output cards		Standard		Direct inputs/outputs		Insulated inputs		Insulated outputs	
	Manufacturer code	Number/Type of channels	Order No.	Quantity	- see page A.39 (H,R) or A.53 (A) -		- see page A.58 -		- see page A.62 -	
					Type	Quantity	Type	Quantity	Type	Quantity
DI	6ES7421-1BL00-0AA0	32 DI	7789292xxx	1	H2016	2	I2016	2		
	6ES7421-1BL01-0AA0	32 DI	7789292xxx	1	H2016	2	I2016	2		
	6ES7421-1EL00-0AA0	32 DI	7789278xxx	1	R3632	1				
	6ES7421-1FH00-0AA0	16 DI	7789273xxx	1	R2416	1				
	6ES7421-1FH20-0AA0	16 DI	7789273xxx	1	R2416	1				
	6ES7421-7BH00-0AB0	16 DI	7789290xxx	1	H2016	2	I2016	2		
	6ES7421-7BH01-0AB0	16 DI	7789290xxx	1	H2016	2	I2016	2		
6ES7421-7DH00-0AB0	16 DI	7789278xxx	1	R3632	1					
DO	6ES7422-1BH10-0AA0	16 DO	7789291xxx	1	H2016	1			O2016	1
	6ES7422-1BH11-0AA0	16 DO	7789291xxx	1	H2016	1			O2016	1
	6ES7422-1BL00-0AA0	32 DO	7789292xxx	1	H2016	2			O2016	2
	6ES7422-1FH00-0AA0	16 DO	7789273xxx	1	R2416	1				
	6ES7422-1HH00-0AA0	16 DO	7789270xxx	1	R3632	1				
	6ES7422-5EH10-0AB0	16 DO	7789291xxx	1	H2016	1			O2016	1
	6ES7422-7BL00-0AB0	32 DO	7789292xxx	1	H2016	2			O2016	2
AI	6ES7431-0HH00-0AB0	16 AI	7789284xxx	1	A3716	1				
	6ES7431-1KF00-0AB0	8 AI, voltage and resistance applications	2062360xxx	1	A2508	1				
	6ES7431-1KF00-0AB0	8 AI, current applications	2062380xxx	1	A2508	1				
	6ES7431-1KF10-0AB0	8 AI	7789285xxx	1	A2508	1				
	6ES7431-1KF20-0AB0	8 AI	7789285xxx	1	A2508	1				
	6ES7431-7KF10-0AB0	16 AI	7789284xxx	1	A3716	1				
	6ES7431-7QH00-0AB0	16 AI	7789284xxx	1	A3716	1				
AO	6ES7432-1HF00-0AB0	8 AO, common mode voltage applications	7789288xxx	1	A2508	1				

Note

- Please, always take into account the characteristics of the PLC card (voltage, current...) when selecting interfaces. In some cases, the card can work at higher voltages than those indicated in the interface.
- The interfaces are intended to be used inside an IP20 enclosure at least.
- The last 3 digits of the cable code indicate its length in decimetres. For example, if the code ends in 100, the cable would be 10 m long.

* In the case that an input/output card does not appear in this table, you can check our on-line PLC selection guide at www.weidmuller.com where you will always find the most up-to-date information.

PLC SIEMENS – S7-1200



A

	PLC		Cables		Interfaces					
	Input/Output cards		Standard		Direct inputs/outputs		Insulated inputs		Insulated outputs	
					- see page A.39 (H,R) or A.53 (A) -		- see page A.58 -		- see page A.62 -	
	Manufacturer code	Number/Type of channels	Order No.	Quantity	Type	Quantity	Type	Quantity	Type	Quantity
DI	6ES7221-1BF30-0XB0	8 DI	1329110xxx	1	H2008	1				
	6ES7221-1BF32-0XB0	8 DI	1329110xxx	1	H2008	1				
	6ES7221-1BH30-0XB0	16 DI	1329120xxx	1	H2016	1	I2016	1		
	6ES7221-1BH32-0XB0	16 DI	1329120xxx	1	H2016	1	I2016	1		
DO	6ES7222-1HH30-0XB0	16 DO	1329140xxx	1	R2416	1				
	6ES7222-1BF30-0XB0	8 DO	1329150xxx	1	H2008	1			O2008	1
	6ES7222-1BH30-0XB0	16 DO	1329170xxx	1	H2016	1			O2016	1
	6ES7222-1BH32-0XB0	16 DO	1329170xxx	1	H2016	1			O2016	1
DI/DO	6ES7223-1PL30-0XB0	16 DI	1329200xxx	1	H2016	1				
		16 DO	1329210xxx	1	R2416	1				
	6ES7223-1BH30-0XB0	8 DI	1329180xxx	1	H2008	1				
		8 DO	1329230xxx	1	H2008	1			O2008	1
	6ES7223-1BL30-0XB0	16 DI	1329200xxx	1	H2016	1				
		16 DO	1329240xxx	1	H2016	1			O2016	1
	6ES7223-1BL32-0XB0	16 DI	1329200xxx	1	H2016	1				
		16 DO	1329240xxx	1	H2016	1			O2016	1
AI	6ES7231-4HD30-0XB0	4 AI	1329250xxx	1	A1504	1				
	6ES7231-4HD32-0XB0	4 AI	1329250xxx	1	A1504	1				
	6ES7231-4HF30-0XB0	8 AI	1329270xxx	1	A2508	1				
AO	6ES7232-4HB30-0XB0	2 AO	1329280xxx	1	A1504	1				
	6ES7232-4HD30-0XB0	4 AO	1329290xxx	1	A1504	1				
AI/AO	6ES7234-4HE30-0XB0	4 AI + 2 AO	1329300xxx	1	A2508	1				

Note

- Please, always take into account the characteristics of the PLC card (voltage, current...) when selecting interfaces. In some cases, the card can work at higher voltages than those indicated in the interface.
 - Cables 7789100xxx, 7789104xxx, 7789106xxx, 7789108xxx, 1350480xxxx, 1350490xxx and 1350500xxx have wire-end ferrules at one end. These cables do not have a PLC connector. Colour code according to DIN 47100.
 - The interfaces are intended to be used inside an IP20 enclosure at least.
 - The last 3 digits of the cable code indicate its length in decimetres. For example, if the code ends in 100, the cable would be 10 m long.
- * In the case that an input/output card does not appear in this table, you can check our on-line PLC selection guide at www.weidmueller.com where you will always find the most up-to-date information.



PLC SIEMENS – S7-1500 / ET 200MP

	PLC		Cables		Interfaces					
	Input/Output cards		Standard		Direct inputs/outputs		Insulated inputs		Insulated outputs	
					- see page A.39 (H,R) or A.53 (A) -		- see page A.58 -		- see page A.62 -	
	Manufacturer code	Number/Type of channels	Order No.	Quantity	Type	Quantity	Type	Quantity	Type	Quantity
DI	6ES7521-1BH00-0AB0	16 DI	1462090xxx	1	H2016	1	I2016	1		
	6ES7521-1BH50-0AA0 ^{A)}	16 DI	1462100xxx	1	H2016	1				
	6ES7521-1BL00-0AB0	32 DI	1462040xxx	1	H2016	2	I2016	2		
	6ES7521-1BL10-0AA0	32 DI	1994500xxx	1	H2016	2	I2016	2		
	6ES7521-1FH00-0AA0	16 DI	1462130xxx	1	R2416	1				
	6ES7521-7EH00-0AB0	16DI	2744080xxx	1	R2416 ^{B)}	1				
	6ES7521-1BH10-0AA0	16DI	2605170xxx	1	H2016	1	I2016	1		
	6ES7521-1BP00-0AA0	64DI (positive logic)	2814170xxx	2	H2016	4	I2016	4		
6ES7521-1BP00-0AA0	64DI (negative logic)	2814160xxx	2	H2016 ^{A)}	4					
DO	6ES7522-1BF00-0AB0	8 DO	1462110xxx	1	H2008	1			O2008	1
	6ES7522-1BH00-0AB0	16 DO	1462090xxx	1	H2016	1			O2016	1
	6ES7522-1BL00-0AB0	32 DO	2744090xxx	1	R3632	1				
	6ES7522-1BL01-0AB0	32 DO	1462040xxx	1	H2016	2			O2016	2
	6ES7522-1BL10-0AA0	32 DO	1994500xxx	1	H2016	2			O2016	2
	6ES7522-5FF00-0AB0	8 DO	1462140xxx	1	R2416	1				
	6ES7522-5FH00-0AB0	16 DO	2000150xxx ^{E)}	1						
	6ES7522-1BP50-0AA0	64DO	2814320xxx	2	H2016 ^{A)}	4			O2016N	4
	6ES7522-1BP00-0AA0	64DO	2814320xxx	2	H2016	4			O2016	4
	DI/DO	6ES7523-1BP50-0AA0 (di positive logic)	32DI	2814170xxx	1	H2016	2	I2016	2	
6ES7523-1BP50-0AA0 (di negative logic)		32DO	2814320xxx	1	H2016	2			O2016	2
6ES7523-1BP50-0AA0 (di positive logic)		32DI	2814160xxx	1	H2016 ^{A)}	2				
6ES7523-1BP50-0AA0 (di negative logic)		32DO	2814320xxx	1	H2016 ^{A)}	2			O2016N	2
AI	6ES7531-7KF00-0AB0 (current mode 2 wires)	8 AI	2752610xxx	1	A2508 ^{C)}	1				
	6ES7531-7KF00-0AB0 (current mode 4 wires)	8 AI	2655850xxx	1	A2508 ^{C)}	1				
	6ES7531-7KF00-0AB0 (voltage mode)	8 AI	2695350xxx	1	A2508 ^{C)}	1				
	6ES7531-7NF10-0AB0 (current mode)	8 AI	2752610xxx	1	A2508	1				
	6ES7531-7NF10-0AB0 (voltage mode)	8 AI	2695350xxx	1	A2508	1				
	6ES7531-7QD00-0AB0 (4-wires transmitter)	4 AI	2740910xxx	1	A1504 ^{B)}	1				
	6ES7531-7QD00-0AB0 (2-wires transmitter)	4 AI	2740930xxx	1	A1504	1				
	6ES7531-7NF00-0AB0 (voltage mode)	8AI	2695350xxx	1	A2508	1				
	6ES7531-7NF00-0AB0 (current mode)	8AI	2655850xxx	1	A2508	1				
	6ES7531-7PF00-0AB0 (pin to pin)	8AI	2836810xxx	1	A50	1				
AO	6ES7532-5HD00-0AB0	4 AO, 2-wire voltage applications	1462150xxx	1	A1504	1				
	6ES7532-5HD00-0AB0	4 AO, 4-wire voltage applications	1462170xxx	1	A2508	1				
	6ES7532-5HD00-0AB0	4 AO, current applications	1462160xxx	1	A1504	1				
	6ES7532-5HF00-0AB0	8 AO, 2-wire voltage applications	1991700xxx	1	A2508	1				
	6ES7532-5HF00-0AB0	8 AO, 4-wire voltage applications	1991720xxx	1	A3716	1				
	6ES7532-5HF00-0AB0	8 AO, current applications	1991710xxx	1	A2508	1				
	6ES7532-5NB00-0AB0	2AO, 2-wires	1462160xxx	1	A1504	1				
	6ES7532-5ND00-0AB0 (voltage mode)	4AO, 2-wires	1462150xxx	1	A1504	1				
	6ES7532-5ND00-0AB0 (current mode)	4AO, 2-wires	1462160xxx	1	A1504	1				

Note
 A) Attention! Only use interfaces without LEDs
 B) The supplies are grouped into 4 groups at 3,4,5,6
 C) Supply has to be connected in the Power terminal of the Pcb connector
 D) The PLC card has to be supplied directly in the Siemens card Supply connector
 E) Cable provided with ferrules. To be connected to terminal block or other electrical device

- Please, always take into account the characteristics of the PLC card (voltage, current,...) when selecting interfaces. In some cases, the card can work at higher voltages than those indicated in the interface.
- The interfaces are intended to be used inside an IP20 enclosure at least.
- The last 3 digits of the cable code indicate its length in decimetres. For example, if the code ends in 100, the cable would be 10 m long.

* In the case that an input/output card does not appear in this table, you can check our on-line PLC selection guide at www.weidmuller.com where you will always find the most up-to-date information.

SIEMENS – ET 200SP

A

	PLC		Cables		Interfaces					
	Input/Output cards		Standard		Direct inputs/outputs		Insulated inputs		Insulated outputs	
					- see page A.39 (H,R) or A.53 (A) -		- see page A.58 -		- see page A.62 -	
	Manufacturer code	Number/Type of channels	Order No.	Quantity	Type	Quantity	Type	Quantity	Type	Quantity
DI	6ES7131-6BF01-0AA0 ^{B)}	DI 8x24VDC BA	2742890xxx ¹⁾	1	H2008	1	I2016 ^{D)}	1		
	6ES7131-6BF61-0AA0 ^{A)C)}	DI 08x24Vdc SRC BA	2742890xxx ¹⁾	1	H2016 ^{D)}	1				
	6ES7131-6BF01-0BA0 ^{B)}	DI 8x24VDC ST	2742890xxx ¹⁾	1	H2008	1	I2016 ^{D)}	1		
	6ES7131-6BH01-0BA0 ^{B)}	DI 16x24VDC ST	2732130xxx ¹⁾	1	H2016	1	I2016	1		
	6ES7131-6BF00-0CA0 ^{B)}	DI 08x24Vdc HF	2742890xxx ¹⁾	1	H2008	1	I2016 ^{D)}	1		
	6ES7131-6TF00-0CA0	DI 8xNAMUR HF	2732130xxx ¹⁾	1	H20	1				
DO	6ES7131-6BF00-0DA0 ^{B)}	DI 8x24VDC HS	2742890xxx ¹⁾	1	H2008	1	I2016 ^{D)}	1		
	6ES7132-6BF01-0AA0 ^{C)}	DQ 8x24VDC/0.5A BA	2742890xxx ¹⁾	1	H2008	1			02008	1
	6ES7132-6BF61-0AA0 ^{A)B)}	DQ 8x24VDC/0.5A SNK BA	2742890xxx ¹⁾	1	H2016 ^{D)}	1			02008N	1
	6ES7132-6BD20-0BA0 ^{C)}	DQ 4x24VDC/2A ST	2756670xxx ¹⁾	1	H2008	1			02008	1
	6ES7132-6BF01-0BA0 ^{C)}	DQ 8x24VDC/0.5A ST	2742890xxx ¹⁾	1	H2008	1			02008	1
	6ES7132-6BH00-0AA0 ^{C)}	DQ 16x24VDC/0.5A BA	2732130xxx ¹⁾	1	H2016	1			02016	1
	6ES7132-6BH01-0BA0 ^{C)}	DQ 16x24VDC/0.5A ST	2732130xxx ¹⁾	1	H2016	1			02016	1
	6ES7132-6BD20-0CA0 ^{C)}	DQ 4x24VDC/2A HF	2756670xxx ¹⁾	1	H2008	1			02008	1
	6ES7132-6BF00-0CA0 ^{C)}	DQ 8x24VDC/0.5A HF	2742890xxx ¹⁾	1	H2008	1			02008	1
	6ES7132-6BD20-0DA0	DQ 4x24VDC/2A HS	2732130xxx ¹⁾	1	H20	1				
6ES7132-6GD51-0BA0	RQ 4x24VDC/2A CO ST	2732130xxx ¹⁾	1	H20	1					
AI	6ES7134-6GF00-0AA1	AI 8x1 2-/4-fils BA	2732150xxx ¹⁾	1	A2508	1				
	6ES7134-6FF00-0AA1	AI 8xU BA	2732160xxx ²⁾	1	A2508	1				
			2732150xxx ¹⁾	1	A2508	1				
	6ES7134-6FB00-0BA1	AI 2xU ST	2756690xxx ¹⁾	1	A1504	1				
			2756700xxx ²⁾	1	A1504	1				
	6ES7134-6HD01-0BA1(Tension mode)	AI 4xU/I 2-wire ST	2742880xxx ¹⁾	1	A1504	1				
	6ES7134-6HD01-0BA1(Current mode)		2884770xxx ¹⁾	1	A1504	1				
	6ES7134-6HD01-0BA1(Tension mode)		2756720xxx ²⁾	1	A1504	1				
	6ES7134-6HD01-0BA1(Current mode)		2884780xxx ²⁾	1	A1504	1				
	6ES7134-6GD01-0BA1(2-wire current mode)	AI 4x1 2-/4-wire ST	2884770xxx ¹⁾	1	A1504	1				
	6ES7134-6GD01-0BA1(4-wire current mode)		2742880xxx ¹⁾	1	A1504	1				
	6ES7134-6GD01-0BA1(2-wire current mode)		2884780xxx ²⁾	1	A1504	1				
	6ES7134-6GD01-0BA1(4-wire current mode)		2756720xxx ²⁾	1	A1504	1				
	6ES7134-6HB00-0CA1 ^{E)}	AI 2xU/I 2-/4-wire HF	2756730xxx ¹⁾	1	A25	1				
			2756740xxx ²⁾	1	A25	1				
6ES7134-6JD00-0CA1 ^{E)}	AI 4xRTD/TC 2-/3-/4-wire HF	2756730xxx ¹⁾	1	A25	1					
		2756740xxx ²⁾	1	A25	1					
6ES7134-6JF00-0CA1	AI 8xRTD/TC 2-wire HF	2732150xxx ¹⁾	1	A2508	1					
		2732160xxx ²⁾	1	A2508	1					
6ES7134-6HB00-0DA1 ^{E)}	AI 2xU/I 2-/4-wire HS	2756750xxx ¹⁾	1	A15	1					
		2756760xxx ²⁾	1	A15	1					
6ES7134-6TD00-0CA1 ^{F)}	AI 4x1 2-wire 4...20mA HART	2884790xxx ¹⁾	1	A2508	1					
		2884800xxx ²⁾	1	A2508	1					
6ES7134-6GB00-0BA1 ^{E)}	AI 2x1 2-/4-wire ST	2756730xxx ¹⁾	1	A25	1					
		2756740xxx ²⁾	1	A25	1					
7MH4134-6LB00-0DA0 ^{E)}	AI 2xSG 4-/6-wire HS	2756750xxx ¹⁾	1	A15	1					
		2756760xxx ²⁾	1	A15	1					
AO	6ES7135-6FB00-0BA1	AQ 2xU ST	2756770xxx ¹⁾	1	A1504	1				
			2756780xxx ²⁾	1	A1504	1				
	6ES7135-6GB00-0BA1	AQ 2x1 ST	2756770xxx ¹⁾	1	A1504	1				
			2756780xxx ²⁾	1	A1504	1				
	6ES7135-6HB00-0CA1	AQ 2xUI HF	2756790xxx ¹⁾	1	A1504	1				
			2756800xxx ²⁾	1	A1504	1				
6ES7135-6HB00-0DA1	AQ 2xUI HS	2756790xxx ¹⁾	1	A1504	1					
		2756800xxx ²⁾	1	A1504	1					
6ES7135-6HD00-0BA1	AQ 4xUI ST	2742880xxx ¹⁾	1	A1504	1					

Note
 A) Attention! Only use interfaces without LEDs
 B) In 2-wires PLC interfaces, the common and the positive of the interface has to be connected with a bridged.
 C) In 2-wires PLC interfaces, the common and the negative of the interface has to be connected with a bridged.
 D) The last 8 channels of the interface are not used.
 E) Connection 1 to 1 between interface and I/O card
 F) The 2-wire connections are in the channels 0 to 3 and the Hart test connections are in the channels 4 to 7
 1) Starting Terminal block 6ES7193-6BP00-0DA0 included with the cable
 2) Bridged Terminal block 6ES7193-6BP00-0BA0 included with the cable

- All interfaces which are connected with an pre-assembled cable with starting Terminal block the supply voltage has to be connected in the interface.
- Please, always take into account the characteristics of the PLC card (voltage, current...) when selecting interfaces. In some cases, the card can work at higher voltages than those indicated in the interface.
- The interfaces are intended to be used inside an IP20 enclosure at least.
- The last 3 digits of the cable code indicate its length in decimetres. For example, if the code ends in 100, the cable would be 10 m long.

SIEMENS – ET 200SP HA

	PLC		Cables		Interfaces					
	Input/Output cards		Standard		Direct inputs/outputs		Insulated inputs		Insulated outputs	
					- see page A.39 (H,R) or A.53 (A) -		- see page A.58 -		- see page A.62 -	
	Manufacturer code	Number/Type of channels	Order No.	Quantity	Type	Quantity	Type	Quantity	Type	Quantity
DI	6DL1131-6BH00-0PH1	DI 16x24VDC (1-wire)	2856330xxx ¹⁾	1	H2016	1	I2016	1		
			2765980xxx ²⁾	1	H2016	1	I2016	1		
			1349790xxx ⁵⁾	1	H2016	1	I2016	1		
	6DL1131-6BL00-0PH1	DI 32x24VDC (1-wire)	2856380xxx ¹⁾	1	H2016	2	I2016	2		
			2757820xxx ²⁾	1	H2016	2	I2016	2		
			1349790xxx ⁵⁾	1	H2016	2	I2016	2		
	6DL1131-6DF00-0PK0 ^{A)}	DI 8x24 ... 125VDC HA	2765990xxx ³⁾	1	H2008	1	I2016	1		
			1349790xxx ⁵⁾	1	H2008	1	I2016	1		
	6DL1131-6GF00-0PK0	DI 8x230VAC	2766010xxx ³⁾	1	R2416	1				
			7789104xxx ⁵⁾	1	R2416	1				
	6DL1131-6TH00-0PH1 ^{B)}	DI 16x NAMUR	2856390xxx ¹⁾	1	H40	1				
			2766000xxx ²⁾	1	H40	1				
1349880xxx ⁵⁾			1	H40	1					
6DL1133-6EW00-0PH1	AI-DI16/DQ16x24VDC HART (digital mode, 1-wire)	2856330xxx ¹⁾	1	H2016	1	I2016	1			
		2765980xxx ²⁾	1	H2016	1	I2016	1			
		1349790xxx ⁵⁾	1	H2016	1	I2016	1			
DO	6DL1132-6BH00-0PH1	DQ 16x24VDC/0.5A (1-wire)	2856330xxx ¹⁾	1	H2016	1			O2016	1
			2765980xxx ²⁾	1	H2016	1			O2016	1
			1349790xxx ⁵⁾	1	H2016	1			O2016	1
	6DL1132-6BL00-0PH1	DQ 32x24VDC/0.5A	2856380xxx ¹⁾	1	H2016	2			O2016	2
			2757820xxx ²⁾	1	H2016	2			O2016	2
			1349790xxx ⁵⁾	1	H2016	2			O2016	2
6DL1132-6HD50-0PK0	RQ 4x24VDC 230VAC/5A	2766020xxx ³⁾	1	R2416	1					
		7789104xxx ⁵⁾	1	R2416	1					
AI	6DL1133-6EW00-0PH1	AI-DI16/DQ16x24VDC HART (Analogue mode, 2-conductor terminal of a measuring transducer)	2856400xxx ¹⁾	1	A3716	1				
			2766030xxx ²⁾	1	A3716	1				
			2766040xxx ⁴⁾	1	A3716	1				
			1350500xxx ⁵⁾	1	A3716	1				
	6DL1134-6TH00-0PH1	AI 16x1 2-WIRE HART (2-wire)	2856400xxx ¹⁾	1	A3716	1				
			2766030xxx ²⁾	1	A3716	1				
			2766040xxx ⁴⁾	1	A3716	1				
			1350500xxx ⁵⁾	1	A3716	1				
			2856410xxx ¹⁾	1	A3716	1				
6DL1134-6JH00-0PH1 ^{C)}	AI16xTC/8xRTD 2-/3-/4-WIRE(2-wire)	2766050xxx ²⁾	1	A3716	1					
		2766060xxx ⁴⁾	1	A3716	1					
		1350500xxx ⁵⁾	1	A3716	1					
AO	6DL1135-6TF00-0PH1	AQ 8x1 HART HA	2856420xxx ¹⁾	1	A2508	1				
			2766070xxx ²⁾	1	A2508	1				
			2766080xxx ⁴⁾	1	A2508	1				
			1350490xxx ⁵⁾	1	A2508	1				

Note

A) Only possible if configured at 24 V DC
 B) Connection 1 to 1 between interface and I/O card. The pin 37-39 of the interface has to be connected to Supply + and de 38-40 to Supply.
 C) Sub-D Terminal block does not support temperature compensation for TC.

In the case that in the Order No. appear 2 or more part-numbers, recommendation is to use option 1)
 1) Sub-D Terminal block 6DL1193-6TC00-0DHO NOT included with the cable. Recommended cable for this card
 2) Starting Terminal block 6DL1193-6TP00-0DH1 included with the cable
 3) Starting Terminal block 6DL1193-6TP00-0DK0 included with the cable
 4) Bridged Terminal block 6DL1193-6TP00-0BH1 included with the cable
 5) The cable is supplied with the ferrules and the corresponding interface connector. The terminal block is NOT included with the cable. The customer has to wire the cable to the terminal block by itself.

- All interfaces which are connected with an pre-assembled cable with starting Terminal block the supply voltage has to be connected in the interface.
- Please, always take into account the characteristics of the PLC card (voltage, current...) when selecting interfaces. In some cases, the card can work at higher voltages than those indicated in the interface.
- The interfaces are intended to be used inside an IP20 enclosure at least.
- The last 3 digits of the cable code indicate its length in decimetres. For example, if the code ends in 100, the cable would be 10 m long.

* In the case that an input/output card does not appear in this table, you can check our on-line PLC selection guide at www.weidmueller.com where you will always find the most up-to-date information.

WEIDMÜLLER – u-remote

A

	PLC		Cables		Interfaces					
	Input/Output cards		Standard		Direct inputs/outputs		Insulated inputs		Insulated outputs	
					- see page A.39 (H,R) or A.53 (A) -		- see page A.58 -		- see page A.62 -	
	Manufacturer code	Number/Type of channels	Order No.	Quantity	Type	Quantity	Type	Quantity	Type	Quantity
DI	1315210000 UR20-16DI-P-PLC-INT	16 DI	1405060xxx	1	H2016	1	I2016	1		
DO	1315270000 UR20-16DO-P-PLC-INT	16 DO	1405060xxx	1	H2016	1			O2016	1
AI	1315670000 UR20-8AI-I-PLC-INT	8AI	1478470xxx	1	A2508	1				
Note										

RS IO – Selection guide for passive interfaces for digital signals

Number of channels	Type		Features				Interfaces			
	Family	Type of wiring	Connection		LED by channel	Disconnectable	Fuse	Order No.	Type	Page
			Screw connection	Tension clamp connection						
Universal	H20	1:1						0224261001	RS F20 LP2N 5/20	D.6
		1:1						8537110000	RS F20 Z	D.6
	H40	1:1						0224461001	RS F40 LP2N 5/40	D.6
		1:1						8537140000	RS F40 Z	D.6
8-channel	H2008	2-wire						9445530000	RS 8IO 2W L H S	A.40
16-channel	H2016	1-wire						9445700000	RS 16IO 1W H S	A.41
								9445710000	RS 16IO 1W L H S	A.41
								1311750000	RS 16IO 1W H Z	A.41
								1311770000	RS 16IO 1W L H Z	A.41
								9445810000	RS 16IO 1W I L H S	A.42
								1311780000	RS 16IO 1W I L H Z	A.42
		2-wire						9445720000	RS 16IO 2W H S	A.43
								9445730000	RS 16IO 2W L H S	A.43
								1311790000	RS 16IO 2W H Z	A.43
								1311800000	RS 16IO 2W L H Z	A.43
								1311810000	RS 16IO 2W I H S	A.44
								9445750000	RS 16IO 2W I L H S	A.44
								1311820000	RS 16IO 2W I H Z	A.44
								1311830000	RS 16IO 2W I L H Z	A.44
								1431700000	RS 16IO 2W I L 2H S	A.45
								9445820000	RS 16IO 2W F H S	A.46
								1311850000	RS 16IO 2W F L H S	A.46
			3-wire						1311840000	RS 16IO 2W F H Z
							1311870000	RS 16IO 2W F L H Z	A.46	
							9445760000	RS 16IO 3W H S	A.47	
							9445770000	RS 16IO 3W L H S	A.47	
							1311880000	RS 16IO 3W H Z	A.47	
							1311890000	RS 16IO 3W L H Z	A.47	
	R2416	1-wire					9441500000	RS 16IO 1W R S	A.48	
						9441860000	RS 16IO 1W I R S	A.48		
2-wire						9441700000	RS 16IO 2W R S	A.49		
						9441560000	RS 16IO 2W F R S	A.49		
	3-wire					9441600000	RS 16IO 3W I R S	A.50		
32-channel	R3632	1-wire						9441510000	RS 32IO 1W R S	A.51
								9441870000	RS 32IO 1W I R S	A.51
	2-wire							9441710000	RS 32IO 2W R S	A.52
								9441570000	RS 32IO 2W F R S	A.52
Note 1: Coding of the interface descriptions		RS: 8IO: 8 inputs/outputs 12IO: 12 inputs/outputs 16IO: 16 inputs/outputs 32IO: 32 inputs/outputs		1W: 1-wire 2W: 2-wire 3W: 3-wire Number of wires	(empty): Direct I: Switch L: LED F: Fuse H: Switch + LED FL: Fuse + LED	H HE connector (ribbon cable) R: RSV connector	S: Screw connection Z: Tension clamp connection			

RS IO – Interface

for 8 digital signals 2-wire H (HE connector) system

Digital input/output passive interface

- 1, 2 or 3 wires
- With LED indicator (optional)
- With fuse or disconnection per channel (optional)
- Fuse powered protection
- Screw or tension clamp connection

RS 8IO 2W L H

H system, 2 wires with LED

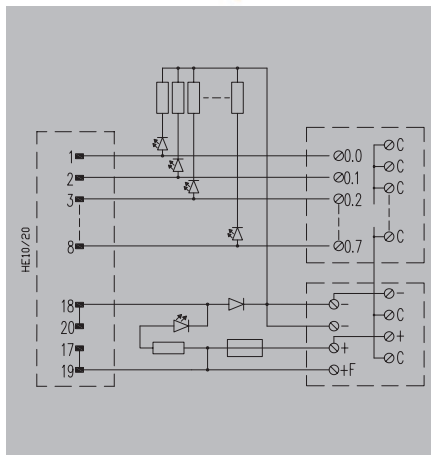
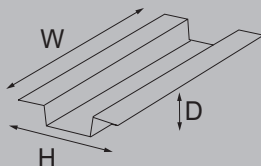
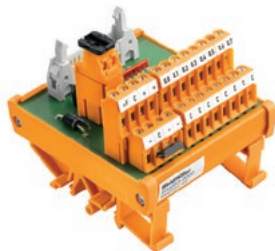

Technical data

Connection data and functionality
Connection on control side
Number of poles (control side)
LED status display per channel
LED status of the supply voltage
Fuse per channel
Power supply fuse
Type of test point
Rated data
Operating voltage
Max. current per channel
Operating voltage (supply)
Operating current (supply)
General data
Ambient temperature (operational)
Storage temperature
Approvals
Insulation coordination (EN50178)
Rated insulation voltage
Surge voltage category
Pollution severity level
Pulse voltage test (1,2/50µs)
Dimensions
Clamping range, min./max.
Clamping range, min./max.
Rail
Width / Height
Note

Plug-in connector in acc. with IEC60603-13 / DIN41651
20-pole plug
green
yellow
No
3.15 A
No
CE
24 V DC ± 10%
1 A
24 V DC ± 10%
2 A
CE
-25...50 °C
-40...60 °C
CE, EAC
< 50 V AC
III
2
0.8 kV
Screw connection
0.13 mm ² / 6 mm ²
0.13 mm ² / 6 mm ²
TS 35, TS 32
74 mm / 87 mm
The common C may carry up to 3 A if the external jumpers are not used

Ordering data

Screw connection with LED

Type	Depth	Order No.
RS 8IO 2W L H S	72 mm	9445530000

Note

The UL values only apply to the version with screw connection (UL recognised).
--

Accessories

Note

--

RS IO – Interface
for 16 digital signals 1-wire H system

Digital input/output passive interface

- 1, 2 or 3 conductors
- With LED status indicator (optional)
- With fuse or circuit breaker per channel (optional)
- Surge protection fuse
- Screw connection or plug-in connection

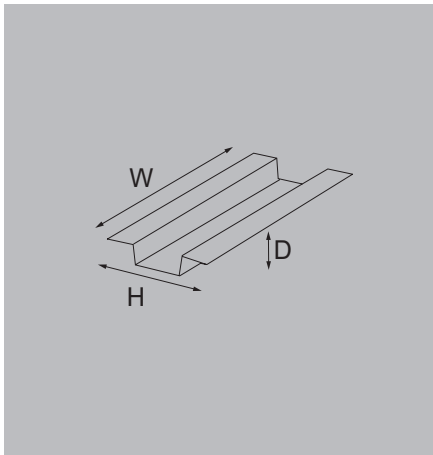

RS 16IO 1W H

H system, 1 wire

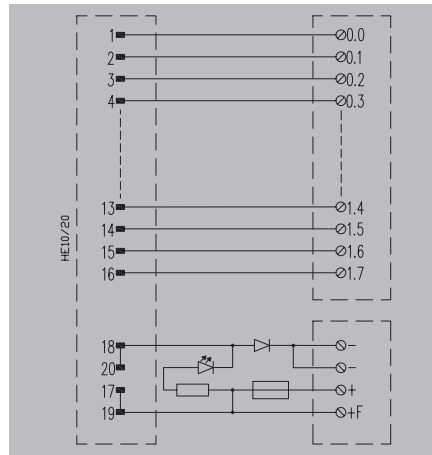

RS 16IO 1W L H

H system, 1 wire with LED

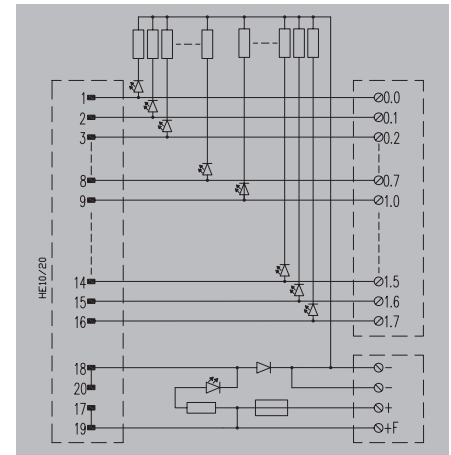

Technical data

Connection data and functionality	
Connection on control side	
Number of poles (control side)	
LED status display per channel	
LED status of the supply voltage	
Fuse per channel	
Power supply fuse	
Type of test point	
Rated data	
Operating voltage	
Max. current per channel	
Operating voltage (supply)	
Operating current (supply)	
General data	
Ambient temperature (operational)	
Storage temperature	
Approvals	
Insulation coordination (EN50178)	
Rated insulation voltage	
Surge voltage category	
Pollution severity level	
Pulse voltage test (1,2/50µs)	
Dimensions	
Clamping range, min./max.	
Clamping range, min./max.	
Rail	
Width / Height	
Note	

Ordering data

Type	Depth	Order No.
RS 16IO 1W H S	72 mm	9445700000
RS 16IO 1W H Z	72 mm	1311750000

The UL values only apply to the version with screw connection (UL recognised).

Accessories

Note

Connection data and functionality	
Plug-in connector in acc. with IEC60603-13 / DIN41651	
20-pole plug	
No	
yellow	
No	
3.15 A	
No	
CE	
25 V AC / 50 V DC	
1 A	
24 V DC ± 10%	
2 A	
CE	
-25...50 °C	
-40...60 °C	
CE; EAC	
< 50 V AC	
III	
2	
0.8 kV	
Screw connection	
0.13 mm ² / 6 mm ²	
0.13 mm ² / 6 mm ²	
TS 35, TS 32	
46 mm / 87 mm	
Tension-clamp connection	
0.13 mm ² / 2.5 mm ²	
0.13 mm ² / 2.5 mm ²	
TS 35, TS 32	
46 mm / 87 mm	
Note	

Type	Depth	Order No.
RS 16IO 1W L H S	72 mm	9445710000
RS 16IO 1W L H Z	72 mm	1311770000

The UL values only apply to the version with screw connection (UL recognised).

Note

Connection data and functionality	
Plug-in connector in acc. with IEC60603-13 / DIN41651	
20-pole plug	
green	
yellow	
No	
3.15 A	
No	
CE	
24 V DC ± 10%	
1 A	
24 V DC ± 10%	
2 A	
CE	
-25...50 °C	
-40...60 °C	
CE; EAC	
< 50 V AC	
III	
2	
0.8 kV	
Screw connection	
0.13 mm ² / 6 mm ²	
0.13 mm ² / 6 mm ²	
TS 35, TS 32	
46 mm / 87 mm	
Tension-clamp connection	
0.13 mm ² / 2.5 mm ²	
0.13 mm ² / 2.5 mm ²	
TS 35, TS 32	
46 mm / 87 mm	
Note	

Type	Depth	Order No.
RS 16IO 1W L H S	72 mm	9445710000
RS 16IO 1W L H Z	72 mm	1311770000

The UL values only apply to the version with screw connection (UL recognised).

Note

RS IO – Interface
for 16 digital signals 1-wire H system

Digital input/output passive interface

- 1, 2 or 3 wires
- With LED indicator (optional)
- With fuse or disconnection per channel (optional)
- Fuse powered protection
- Screw or tension clamp connection

RS 16IO 1W I-L H

H system, 1 wire with LED and disconnection per channel

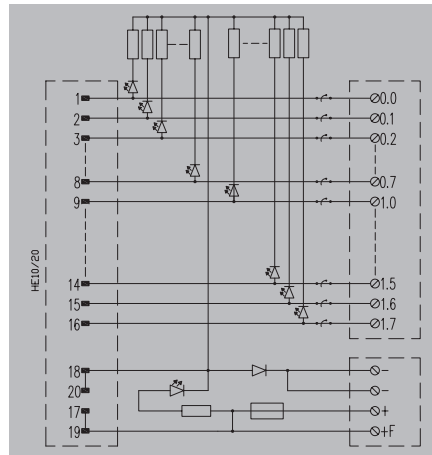
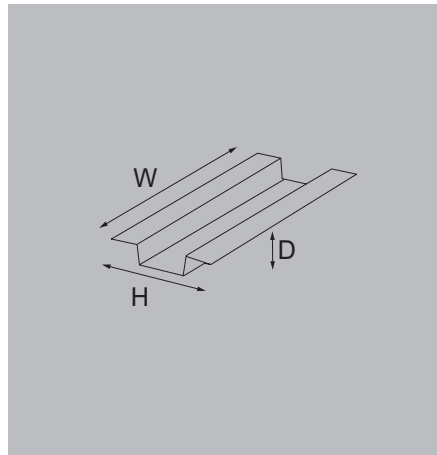

Technical data

Connection data and functionality
Connection on control side
Number of poles (control side)
LED status display per channel
LED status of the supply voltage
Fuse per channel
Power supply fuse
Type of test point
Rated data
Operating voltage
Max. current per channel
Operating voltage (supply)
Operating current (supply)
General data
Ambient temperature (operational)
Storage temperature
Approvals
Insulation coordination (EN50178)
Rated insulation voltage
Surge voltage category
Pollution severity level
Pulse voltage test (1,2/50µs)
Dimensions
Clamping range, min./max.
Clamping range, min./max.
Rail
Width / Height
Note

Plug-in connector in acc. with IEC60603-13 / DIN41651	
20-pole plug	
green	
yellow	
No	
3.15 A	
No	
CE	
24 V DC ± 10%	
1 A	
24 V DC ± 10%	
2 A	
CE	
-25...50 °C	
-40...60 °C	
CE, EAC	
< 50 V AC	
III	
2	
0.8 kV	
Screw connection	Tension-clamp connection
0.13 mm ² / 6 mm ²	0.14 mm ² / 1.5 mm ²
0.13 mm ² / 6 mm ²	0.14 mm ² / 1.5 mm ²
TS 35, TS 32	TS 35, TS 32
110 mm / 87 mm	110 mm / 87 mm

Ordering data

Screw connection without LED
Screw connection with LED
Tension clamp connection without LED
Tension clamp connection with LED
Note

Type	Depth	Order No.
RS 16IO 1W I-L H S	72 mm	9445810000
RS 16IO 1W I-L H Z	72 mm	1311780000

The UL values only apply to the version with screw connection (UL recognised).

Accessories

Note

RS IO – Interface
for 16 digital signals 2-wire H system

Digital input/output passive interface

- 1, 2 or 3 wires
- With LED indicator (optional)
- With fuse or disconnection per channel (optional)
- Fuse powered protection
- Screw or tension clamp connection

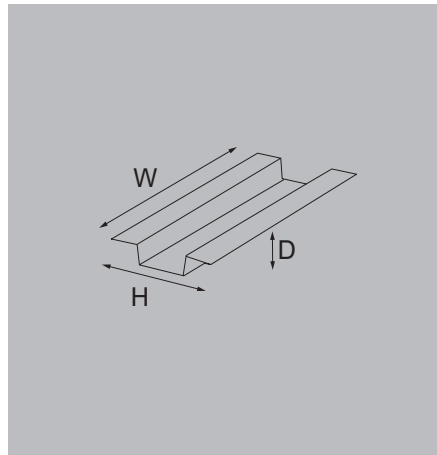

RS 16IO 2W H

H system, 2 wires

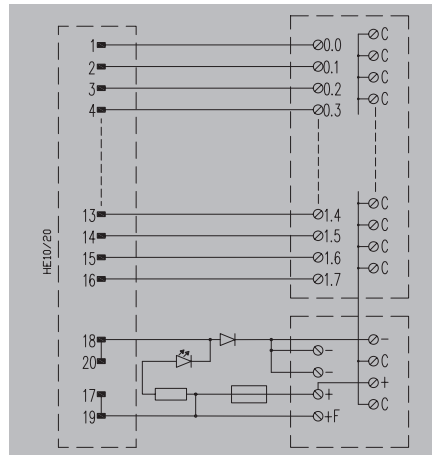

RS 16IO 2W L H

H system, 2 wires with LED

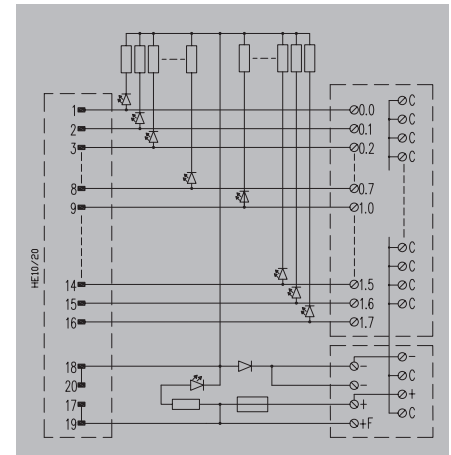

Technical data

Connection data and functionality	
Connection on control side	Plug-in connector in acc. with IEC60603-13 / DIN41651
Number of poles (control side)	20-pole plug
LED status display per channel	No
LED status of the supply voltage	yellow
Fuse per channel	No
Power supply fuse	3.15 A
Type of test point	No
Rated data	
Operating voltage	25 V AC / 50 V DC
Max. current per channel	1 A
Operating voltage (supply)	24 V DC ± 10%
Operating current (supply)	2 A
General data	
Ambient temperature (operational)	-25...50 °C
Storage temperature	-40...60 °C
Approvals	CE, EAC
Insulation coordination (EN50178)	
Rated insulation voltage	< 50 V AC
Surge voltage category	III
Pollution severity level	2
Pulse voltage test (1,2/50µs)	0.8 kV
Dimensions	
Clamping range, min./max.	0.13 mm ² / 6 mm ²
Clamping range, min./max.	0.13 mm ² / 6 mm ²
Rail	TS 35, TS 32
Width / Height	87 mm / 87 mm
Note	
The common C may carry up to 3 A if the external jumpers are not used	

Connection data and functionality	
Connection on control side	Plug-in connector in acc. with IEC60603-13 / DIN41651
Number of poles (control side)	20-pole plug
LED status display per channel	green
LED status of the supply voltage	yellow
Fuse per channel	No
Power supply fuse	3.15 A
Type of test point	No
Rated data	
Operating voltage	24 V DC ± 10%
Max. current per channel	1 A
Operating voltage (supply)	24 V DC ± 10%
Operating current (supply)	2 A
General data	
Ambient temperature (operational)	-25...50 °C
Storage temperature	-40...60 °C
Approvals	CE, EAC
Insulation coordination (EN50178)	
Rated insulation voltage	< 50 V AC
Surge voltage category	III
Pollution severity level	2
Pulse voltage test (1,2/50µs)	0.8 kV
Dimensions	
Clamping range, min./max.	0.13 mm ² / 6 mm ²
Clamping range, min./max.	0.13 mm ² / 6 mm ²
Rail	TS 35, TS 32
Width / Height	87 mm / 87 mm
Note	
The common C may carry up to 3 A if the external jumpers are not used	

Connection data and functionality	
Connection on control side	Plug-in connector in acc. with IEC60603-13 / DIN41651
Number of poles (control side)	20-pole plug
LED status display per channel	green
LED status of the supply voltage	yellow
Fuse per channel	No
Power supply fuse	3.15 A
Type of test point	No
Rated data	
Operating voltage	24 V DC ± 10%
Max. current per channel	1 A
Operating voltage (supply)	24 V DC ± 10%
Operating current (supply)	2 A
General data	
Ambient temperature (operational)	-25...50 °C
Storage temperature	-40...60 °C
Approvals	CE, EAC
Insulation coordination (EN50178)	
Rated insulation voltage	< 50 V AC
Surge voltage category	III
Pollution severity level	2
Pulse voltage test (1,2/50µs)	0.8 kV
Dimensions	
Clamping range, min./max.	0.13 mm ² / 6 mm ²
Clamping range, min./max.	0.13 mm ² / 6 mm ²
Rail	TS 35, TS 32
Width / Height	87 mm / 87 mm
Note	
The common C may carry up to 3 A if the external jumpers are not used	

Ordering data

Type	Depth	Order No.
Screw connection without LED	72 mm	9445720000
Screw connection with LED	72 mm	9445730000
Tension clamp connection without LED	72 mm	1311790000
Tension clamp connection with LED	72 mm	1311800000
Note		
The UL values only apply to the version with screw connection (UL recognised).		

Type	Depth	Order No.
RS 16IO 2W H S	72 mm	9445720000
RS 16IO 2W L H S	72 mm	9445730000
RS 16IO 2W H Z	72 mm	1311790000
RS 16IO 2W L H Z	72 mm	1311800000
Note		
The UL values only apply to the version with screw connection (UL recognised).		

Type	Depth	Order No.
RS 16IO 2W L H S	72 mm	9445730000
RS 16IO 2W L H Z	72 mm	1311800000
Note		
The UL values only apply to the version with screw connection (UL recognised).		

Accessories

Note

Note

Note

RS IO – Interface
for 16 digital signals 2-wire H system

Digital input/output passive interface

- 1, 2 or 3 wires
- With LED indicator (optional)
- With fuse or disconnection per channel (optional)
- Fuse powered protection
- Screw or tension clamp connection

RS 16IO 2W I H

H system, 2 wires with disconnection per channel



RS 16IO 2W I L H

H system, 2 wires with LED and disconnection per channel

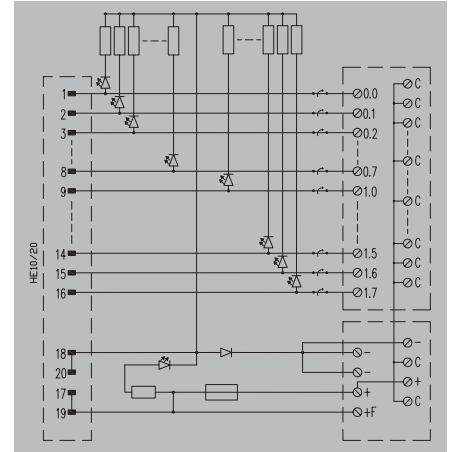
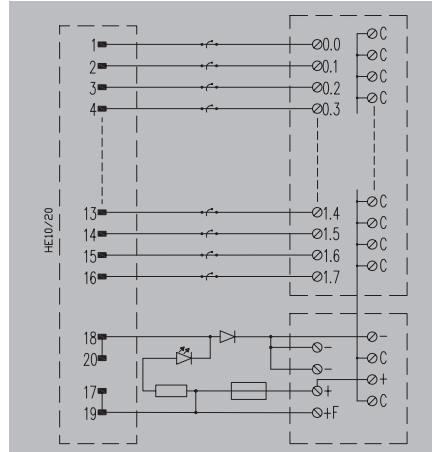
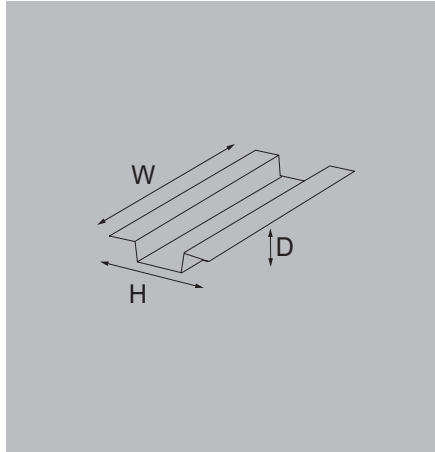

Technical data

Connection data and functionality	
Connection on control side	
Number of poles (control side)	
LED status display per channel	
LED status of the supply voltage	
Fuse per channel	
Power supply fuse	
Type of test point	
Rated data	
Operating voltage	
Max. current per channel	
Operating voltage (supply)	
Operating current (supply)	
General data	
Ambient temperature (operational)	
Storage temperature	
Approvals	
Insulation coordination (EN50178)	
Rated insulation voltage	
Surge voltage category	
Pollution severity level	
Pulse voltage test (1,2/50µs)	
Dimensions	
Clamping range, min./max.	
Clamping range, min./max.	
Rail	
Width / Height	
Note	

Plug-in connector in acc. with IEC60603-13 / DIN41651	
20-pole plug	
No	
yellow	
No	
3.15 A	
No	
CE	
25 V AC / 50 V DC	
1 A	
24 V DC ± 10%	
2 A	
CE	
-25...50 °C	
-40...60 °C	
CE; EAC	
< 50 V AC	
III	
2	
0.8 kV	
Screw connection	Tension-clamp connection
0.13 mm ² / 6 mm ²	0.13 mm ² / 2.5 mm ²
0.13 mm ² / 6 mm ²	0.13 mm ² / 2.5 mm ²
TS 35, TS 32	TS 35, TS 32
95 mm / 87 mm	95 mm / 87 mm
The common C may carry up to 3 A if the external jumpers are not used	

Plug-in connector in acc. with IEC60603-13 / DIN41651	
20-pole plug	
green	
yellow	
No	
3.15 A	
No	
CE	
24 V DC ± 10%	
1 A	
24 V DC ± 10%	
2 A	
CE	
-25...50 °C	
-40...60 °C	
CE; EAC	
< 50 V AC	
III	
2	
0.8 kV	
Screw connection	Tension-clamp connection
0.13 mm ² / 6 mm ²	0.13 mm ² / 2.5 mm ²
0.13 mm ² / 6 mm ²	0.13 mm ² / 2.5 mm ²
TS 35, TS 32	TS 35, TS 32
95 mm / 87 mm	95 mm / 87 mm
The common C may carry up to 3 A if the external jumpers are not used	

Ordering data

Screw connection without LED	
Screw connection with LED	
Tension clamp connection without LED	
Tension clamp connection with LED	
Note	

Type	Depth	Order No.
RS 16IO 2W I H S	72 mm	1311810000
RS 16IO 2W I H Z	72 mm	1311820000
The UL values only apply to the version with screw connection (UL recognised).		

Type	Depth	Order No.
RS 16IO 2W I L H S	72 mm	9445750000
RS 16IO 2W I L H Z	72 mm	1311830000
The UL values only apply to the version with screw connection (UL recognised).		

Accessories

Note	
------	--

Note	
------	--

Note	
------	--

RS IO – Interface
for 16 digital signals 2-wire H system

Digital input/output passive interface

- 1, 2 or 3 wires
- With LED indicator (optional)
- With fuse or disconnection per channel (optional)
- Fuse powered protection
- Screw or tension clamp connection

RS 16IO 2W HL 2H S

2 ribbon connectors for redundancy

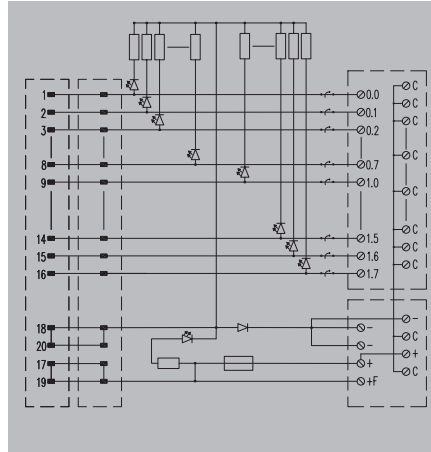
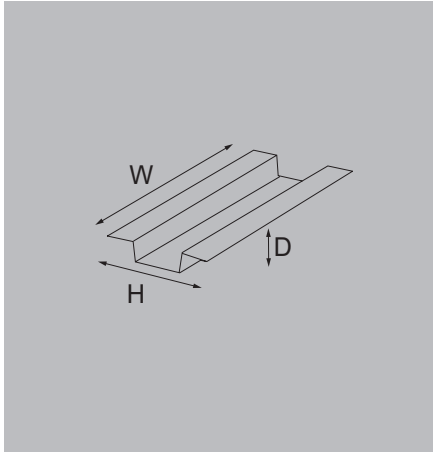

Technical data

Connection data and functionality
Connection on control side
Number of poles (control side)
LED status display per channel
LED status of the supply voltage
Fuse per channel
Power supply fuse
Type of test point
Rated data
Operating voltage
Max. current per channel
Operating voltage (supply)
Operating current (supply)
General data
Ambient temperature (operational)
Storage temperature
Approvals
Insulation coordination (EN50178)
Rated insulation voltage
Surge voltage category
Pollution severity level
Pulse voltage test (1,2/50µs)
Dimensions
Clamping range, min./max.
Clamping range, min./max.
Rail
Width / Height
Note

Plug-in connector in acc. with IEC60603-13 / DIN41651
20-pole plug
green
yellow
No
3.15 A
No
CE
24 V DC ± 10%
1 A
24 V DC ± 10%
2 A
CE
-25...50 °C
-40...60 °C
CE, EAC
< 50 V AC
III
2
0.8 kV
Screw connection
0.13 mm ² / 6 mm ²
0.13 mm ² / 6 mm ²
TS 35, TS 32
91 mm / 109 mm

Ordering data

Screw connection without LED
Screw connection with LED
Tension clamp connection without LED
Tension clamp connection with LED
Note

Type	Depth	Order No.
RS 16IO 2W HL 2H S	79 mm	1431700000
The UL values only apply to the version with screw connection (UL recognised).		

Accessories

Note

RS IO – Interface
for 16 digital signals 2-wire H system

Digital input/output passive interface

- 1, 2 or 3 wires
- With LED indicator (optional)
- With fuse or disconnection per channel (optional)
- Fuse powered protection
- Screw or tension clamp connection

RS 16IO 2W F H

H system, 2 wires with fuse per channel



RS 16IO 2W F-L H

H system, 2 wires with LED and fuse per channel

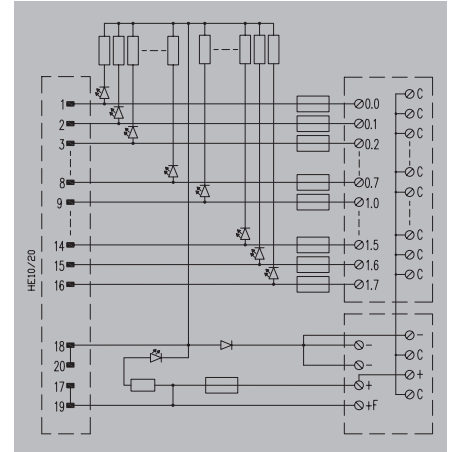
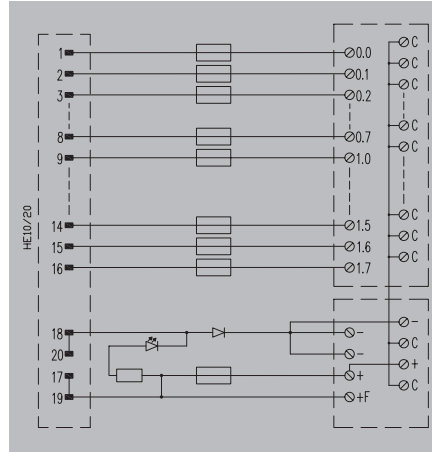
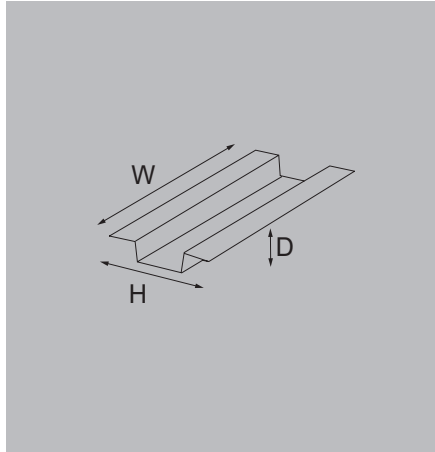

Technical data

Connection data and functionality	
Connection on control side	
Number of poles (control side)	
LED status display per channel	
LED status of the supply voltage	
Fuse per channel	
Power supply fuse	
Type of test point	
Rated data	
Operating voltage	
Max. current per channel	
Operating voltage (supply)	
Operating current (supply)	
General data	
Ambient temperature (operational)	
Storage temperature	
Approvals	
Insulation coordination (EN50178)	
Rated insulation voltage	
Surge voltage category	
Pollution severity level	
Pulse voltage test (1,2/50µs)	
Dimensions	
Clamping range, min./max.	
Clamping range, min./max.	
Rail	
Width / Height	
Note	

Plug-in connector in acc. with IEC60603-13 / DIN41651	
20-pole plug	
No	
yellow	
500 mA	
3.15 A	
No	
CE	
25 V AC / 50 V DC	
1 A	
24 V DC ± 10%	
2 A	
CE	
-25...50 °C	
-40...60 °C	
CE; EAC	
< 50 V AC	
III	
2	
0.8 kV	
Screw connection	Tension-clamp connection
0.13 mm ² / 6 mm ²	0.13 mm ² / 2.5 mm ²
0.13 mm ² / 6 mm ²	0.13 mm ² / 2.5 mm ²
TS 35, TS 32	TS 35, TS 32
122 mm / 87 mm	122 mm / 87 mm
The common C may carry up to 3 A if the external jumpers are not used	

Plug-in connector in acc. with IEC60603-13 / DIN41651	
20-pole plug	
green	
yellow	
500 mA	
3.15 A	
No	
CE	
24 V DC ± 10%	
1 A	
24 V DC ± 10%	
2 A	
CE	
-25...50 °C	
-40...60 °C	
CE; EAC	
< 50 V AC	
III	
2	
0.8 kV	
Screw connection	Tension-clamp connection
0.13 mm ² / 6 mm ²	0.13 mm ² / 2.5 mm ²
0.13 mm ² / 6 mm ²	0.13 mm ² / 2.5 mm ²
TS 35, TS 32	TS 35, TS 32
122 mm / 87 mm	122 mm / 87 mm
The common C may carry up to 3 A if the external jumpers are not used	

Ordering data

Screw connection without LED	
Screw connection with LED	
Tension clamp connection without LED	
Tension clamp connection with LED	
Note	

Type	Depth	Order No.
RS 16IO 2W F H S	72 mm	9445820000
RS 16IO 2W F H Z	72 mm	1311840000
The UL values only apply to the version with screw connection (UL recognised).		

Type	Depth	Order No.
RS 16IO 2W F-L H S	72 mm	1311850000
RS 16IO 2W F-L H Z	72 mm	1311870000
The UL values only apply to the version with screw connection (UL recognised).		

Accessories

Note

Note

Note

RS IO – Interface for 16 digital signals 3-wire H system

Digital input/output passive interface

- 1, 2 or 3 wires
- With LED indicator (optional)
- With fuse or disconnection per channel (optional)
- Fuse powered protection
- Screw or tension clamp connection

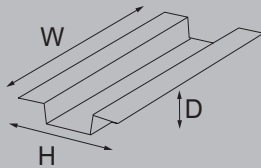
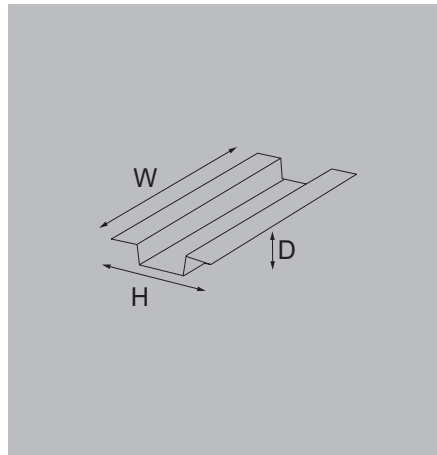

RS 16IO 3W H

H system, 3 wires

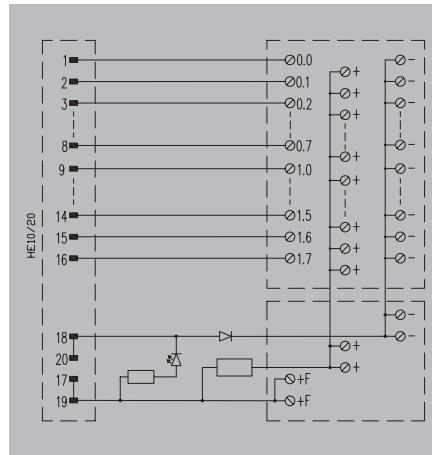

RS 16IO 3W L H

H system, 3 wires with LED

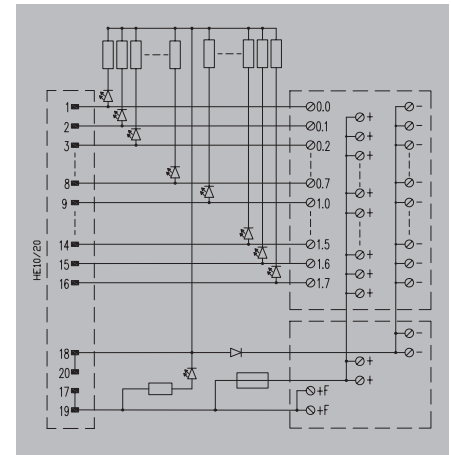

Technical data

Connection data and functionality	
Connection on control side	
Number of poles (control side)	
LED status display per channel	
LED status of the supply voltage	
Fuse per channel	
Power supply fuse	
Type of test point	
Rated data	
Operating voltage	
Max. current per channel	
Operating voltage (supply)	
Operating current (supply)	
General data	
Ambient temperature (operational)	
Storage temperature	
Approvals	
Insulation coordination (EN50178)	
Rated insulation voltage	
Surge voltage category	
Pollution severity level	
Pulse voltage test (1,2/50µs)	
Dimensions	
Clamping range, min./max.	
Clamping range, min./max.	
Rail	
Width / Height	
Note	

Ordering data

	Screw connection without LED
	Screw connection with LED
	Tension clamp connection without LED
	Tension clamp connection with LED
Note	

Accessories

Note	
------	--

Plug-in connector in acc. with IEC60603-13 / DIN41651	
20-pole plug	
No	
yellow	
No	
3.15 A	
No	
CE	
25 V AC / 50 V DC	
1 A	
24 V DC ± 10%	
2 A	
CE	
-25...50 °C	
-40...60 °C	
CE; EAC	
< 50 V AC	
III	
2	
0.8 kV	
Screw connection	
0.13 mm ² / 6 mm ²	
0.13 mm ² / 6 mm ²	
TS 35, TS 32	
90 mm / 87 mm	
Tension-clamp connection	
0.13 mm ² / 2.5 mm ²	
0.13 mm ² / 2.5 mm ²	
TS 35, TS 32	
90 mm / 87 mm	
The common C may carry up to 3 A if the external jumpers are not used	

Type	Depth	Order No.
RS 16IO 3W H S	72 mm	9445760000
RS 16IO 3W H Z	72 mm	1311880000
The UL values only apply to the version with screw connection (UL recognised).		

Plug-in connector in acc. with IEC60603-13 / DIN41651	
20-pole plug	
green	
yellow	
No	
3.15 A	
No	
CE	
24 V DC ± 10%	
1 A	
24 V DC ± 10%	
2 A	
CE	
-25...50 °C	
-40...60 °C	
CE; EAC	
< 50 V AC	
III	
2	
0.8 kV	
Screw connection	
0.13 mm ² / 6 mm ²	
0.13 mm ² / 6 mm ²	
TS 35, TS 32	
90 mm / 87 mm	
Tension-clamp connection	
0.13 mm ² / 2.5 mm ²	
0.13 mm ² / 2.5 mm ²	
TS 35, TS 32	
90 mm / 87 mm	
The common C may carry up to 3 A if the external jumpers are not used	

Type	Depth	Order No.
RS 16IO 3W L H S	72 mm	9445770000
RS 16IO 3W L H Z	72 mm	1311890000
The UL values only apply to the version with screw connection (UL recognised).		

RS IO – Interface
for 16 digital signals 1-wire R system

Digital input/output passive interface

- 1, 2 or 3 wires
- With LED indicator (optional)
- With fuse or disconnection per channel (optional)
- Fuse powered protection
- Screw or tension clamp connection

RS 16IO 1W R

R system, 1 wire

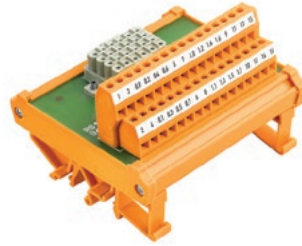

RS 16IO 1W I R

R system, 1 wire with disconnection per channel

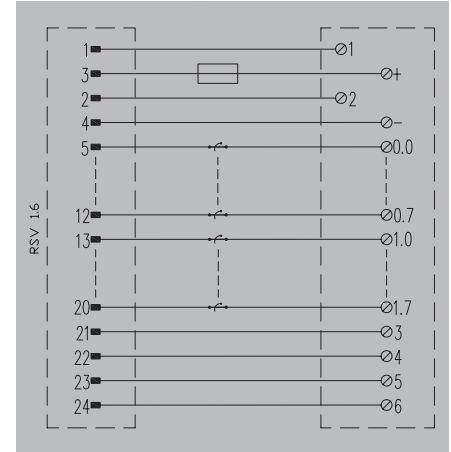
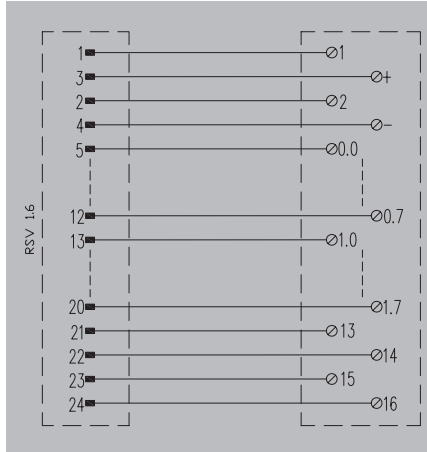
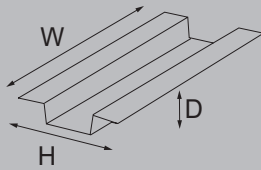
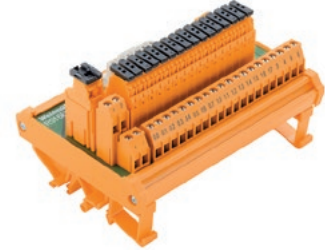

Technical data

Connection data and functionality	
Connection on control side	
Number of poles (control side)	
LED status display per channel	
LED status of the supply voltage	
Fuse per channel	
Power supply fuse	
Type of test point	
Rated data	
Operating voltage	
Max. current per channel	
Operating voltage (supply)	
Operating current (supply)	
General data	
Ambient temperature (operational)	
Storage temperature	
Approvals	
Insulation coordination (EN50178)	
Rated insulation voltage	
Surge voltage category	
Pollution severity level	
Pulse voltage test (1,2/50µs)	
Dimensions	
Clamping range, min./max.	
Clamping range, min./max.	
Rail	
Width / Height	
Note	

Connector RSV 1.6
24-pole female
No
No
No
No
No
No
CE
150 V UC
1 A
24 V DC ± 10%
3 A
CE
-25...50 °C
-40...60 °C
CE, EAC
< 150 V AC
II
2
1.5 kV
Screw connection
0.2 mm ² / 2.5 mm ²
0.2 mm ² / 2.5 mm ²
TS 35, TS 32
97 mm / 87 mm

Connector RSV 1.6
24-pole female
No
No
No
No
3.15 A
No
CE
250 V UC
1 A
24 V DC ± 10%
3 A
CE
-25...50 °C
-40...60 °C
CE, EAC
< 250 V AC
II
2
2.1 kV
Screw connection
0.13 mm ² / 6 mm ²
0.13 mm ² / 6 mm ²
TS 35, TS 32
127 mm / 87 mm

Ordering data

	Screw connection without LED
--	------------------------------

Type	Depth	Order No.
RS 16IO 1W R S	68 mm	9441500000

Type	Depth	Order No.
RS 16IO 1W I R S	72 mm	9441860000

Note	
-------------	--

The UL values only apply to the version with screw connection (UL recognised).
--

The UL values only apply to the version with screw connection (UL recognised).
--

Accessories

Note	
-------------	--

--

--

RS IO – Interface
for 16 digital signals 2-wire R system

Digital input/output passive interface

- 1, 2 or 3 wires
- With LED indicator (optional)
- With fuse or disconnection per channel (optional)
- Fuse powered protection
- Screw or tension clamp connection

RS 16IO 2W R

R system, 2 wires

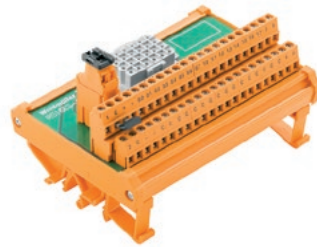

RS 16IO 2W F R

R system, 2 wires with fuse per channel

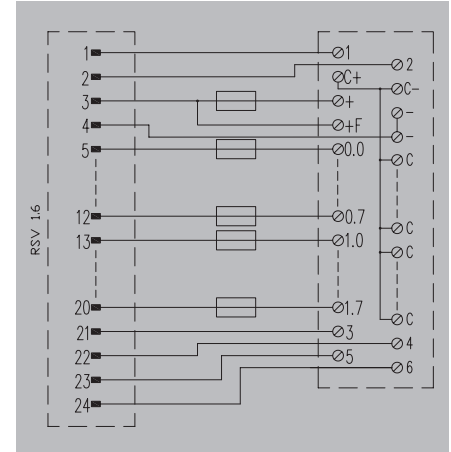
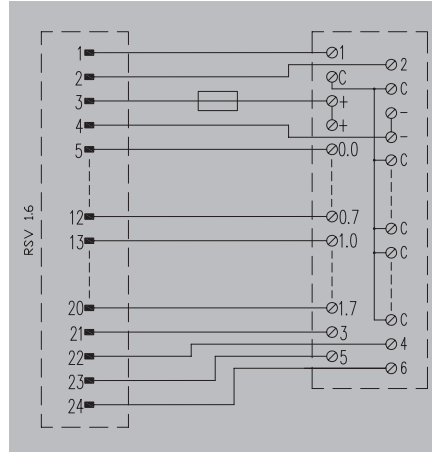
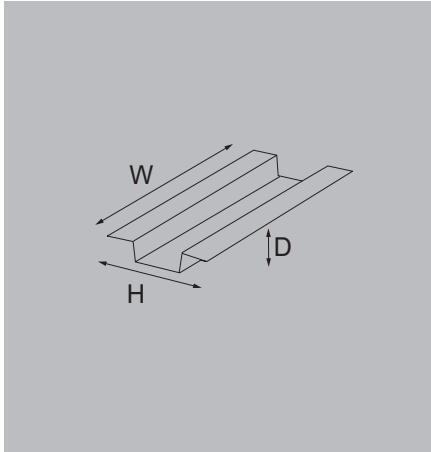

Technical data

Connection data and functionality	
Connection on control side	
Number of poles (control side)	
LED status display per channel	
LED status of the supply voltage	
Fuse per channel	
Power supply fuse	
Type of test point	
Rated data	
Operating voltage	
Max. current per channel	
Operating voltage (supply)	
Operating current (supply)	
General data	
Ambient temperature (operational)	
Storage temperature	
Approvals	
Insulation coordination (EN50178)	
Rated insulation voltage	
Surge voltage category	
Pollution severity level	
Pulse voltage test (1,2/50µs)	
Dimensions	
Clamping range, min./max.	
Clamping range, min./max.	
Rail	
Width / Height	
Note	

Connector RSV 1.6		
24-pole female		
No		
No		
No		
3.15 A		
No		
CE		
150 V UC		
1 A		
24 V DC ± 10%		
3 A		
CE		
-25...50 °C		
-40...60 °C		
CE, EAC		
< 150 V AC		
II		
2		
1.5 kV		
Screw connection		
0.2 mm ² / 2.5 mm ²		
0.2 mm ² / 2.5 mm ²		
TS 35, TS 32		
123 mm / 87 mm		
The common C may carry up to 3 A if the external jumpers are not used		

Connector RSV 1.6		
24-pole female		
No		
No		
1 A		
3.15 A		
No		
CE		
150 V UC		
1 A		
24 V DC ± 10%		
3 A		
CE		
-25...50 °C		
-40...60 °C		
CE, EAC		
< 150 V AC		
II		
2		
1.5 kV		
Screw connection		
0.2 mm ² / 2.5 mm ²		
0.2 mm ² / 2.5 mm ²		
TS 35, TS 32		
123 mm / 109 mm		
The common C may carry up to 3 A if the external jumpers are not used		

Ordering data

Screw connection without LED

Type	Depth	Order No.
RS 16IO 2W R S	72 mm	9441700000

Type	Depth	Order No.
RS 16IO 2W F R S	72 mm	9441560000

Note

The UL values only apply to the version with screw connection (UL recognised).

The UL values only apply to the version with screw connection (UL recognised).

Accessories

Note

RS IO – Interface
for 16 digital signals 3-wire R system

Digital input/output passive interface

- 1, 2 or 3 wires
- With LED indicator (optional)
- With fuse or disconnection per channel (optional)
- Fuse powered protection
- Screw or tension clamp connection

RS 16IO 3W I R

R system, 3 wires with disconnection per channel

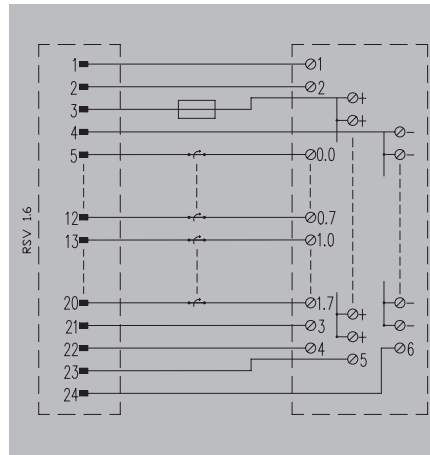
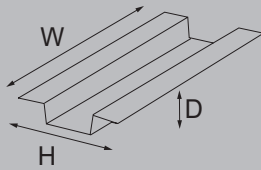

Technical data

Connection data and functionality
Connection on control side
Number of poles (control side)
LED status display per channel
LED status of the supply voltage
Fuse per channel
Power supply fuse
Type of test point
Rated data
Operating voltage
Max. current per channel
Operating voltage (supply)
Operating current (supply)
General data
Ambient temperature (operational)
Storage temperature
Approvals
Insulation coordination (EN50178)
Rated insulation voltage
Surge voltage category
Pollution severity level
Pulse voltage test (1,2/50µs)
Dimensions
Clamping range, min./max.
Clamping range, min./max.
Rail
Width / Height
Note

Connector RSV 1.6
24-pole female
No
No
No
3.15 A
No
CE
150 V UC
1 A
24 V DC ± 10%
3 A
CE
-25...50 °C
-40...60 °C
CE, EAC
250 V AC
II
2
1.5 kV
Screw connection
0.13 mm ² / 6 mm ²
0.13 mm ² / 6 mm ²
TS 35, TS 32
116 mm / 109 mm
The common C may carry up to 3 A if the external jumpers are not used

Ordering data

Screw connection without LED

Type	Depth	Order No.
RS 16IO 3W I R S	84 mm	9441600000

Note

The UL values only apply to the version with screw connection (UL recognised).
--

Accessories

Note

--

RS IO – Interface
for 32 digital signals 1-wire R system

Digital input/output passive interface

- 1, 2 or 3 wires
- With LED indicator (optional)
- With fuse or disconnection per channel (optional)
- Fuse powered protection
- Screw or tension clamp connection

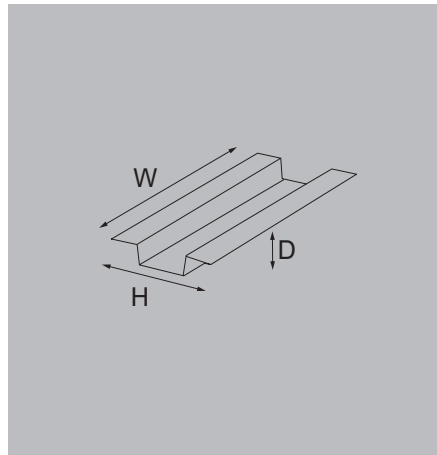

RS 32IO 1W R

R system, 1 wire

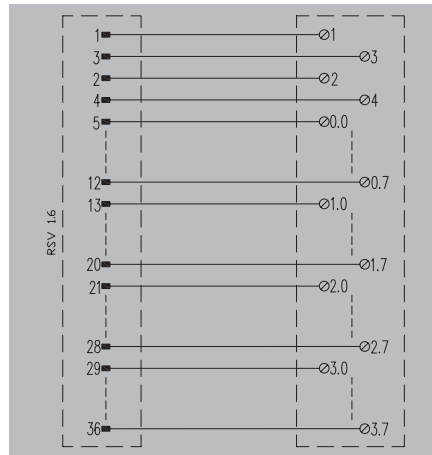

RS 32IO 1W I R

R system, 1 wire with disconnection per channel

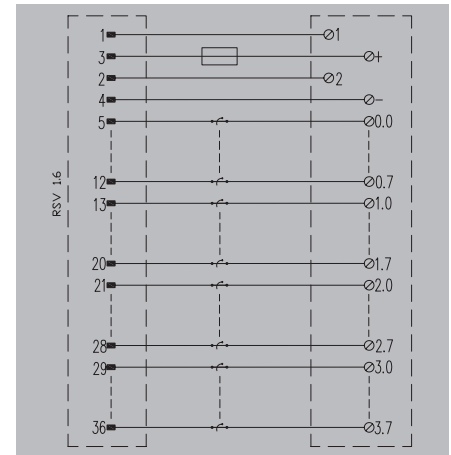
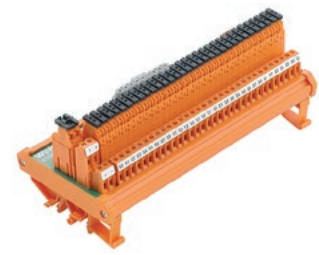

Technical data

Connection data and functionality	
Connection on control side	
Number of poles (control side)	
LED status display per channel	
LED status of the supply voltage	
Fuse per channel	
Power supply fuse	
Type of test point	
Rated data	
Operating voltage	
Max. current per channel	
Operating voltage (supply)	
Operating current (supply)	
General data	
Ambient temperature (operational)	
Storage temperature	
Approvals	
Insulation coordination (EN50178)	
Rated insulation voltage	
Surge voltage category	
Pollution severity level	
Pulse voltage test (1,2/50µs)	
Dimensions	
Clamping range, min./max.	
Clamping range, min./max.	
Rail	
Width / Height	
Note	

Connector RSV 1.6
36-pole female
No
No
No
No
No
No
CE
150 V UC
1 A
24 V DC ± 10%
3 A
CE
-25...50 °C
-40...60 °C
CE, EAC
< 150 V AC
II
2
1.5 kV
Screw connection
0.2 mm ² / 2.5 mm ²
0.13 mm ² / 2.5 mm ²
TS 35, TS 32
148 mm / 87 mm

Connector RSV 1.6
36-pole female
No
No
No
No
3.15 A
No
CE
250 V UC
1 A
24 V DC ± 10%
3 A
CE
-25...50 °C
-40...60 °C
CE, EAC
< 250 V AC
II
2
2.1 kV
Screw connection
0.13 mm ² / 6 mm ²
0.13 mm ² / 6 mm ²
TS 35, TS 32
188 mm / 87 mm

Ordering data

	Screw connection without LED
--	------------------------------

Type	Depth	Order No.
RS 32IO 1W R S	72 mm	9441510000

Type	Depth	Order No.
RS 32IO 1W I R S	72 mm	9441870000

Note	
-------------	--

The UL values only apply to the version with screw connection (UL recognised).
--

The UL values only apply to the version with screw connection (UL recognised).
--

Accessories

Note	
-------------	--

RS IO – Interface
for 32 digital signals 2-wire R system

Digital input/output passive interface

- 1, 2 or 3 wires
- With LED indicator (optional)
- With fuse or disconnection per channel (optional)
- Fuse powered protection
- Screw or tension clamp connection

RS 32IO 2W R

R system, 2 wires



RS 32IO 2W F R

R system, 2 wires with fuse per channel

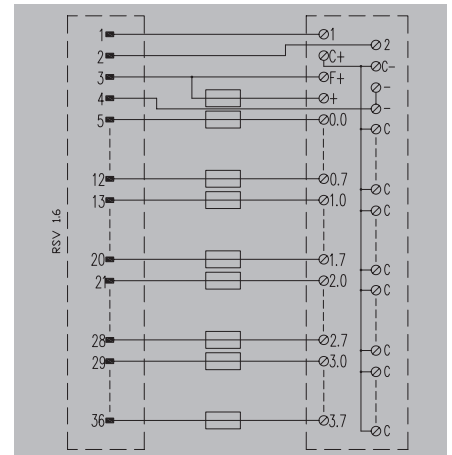
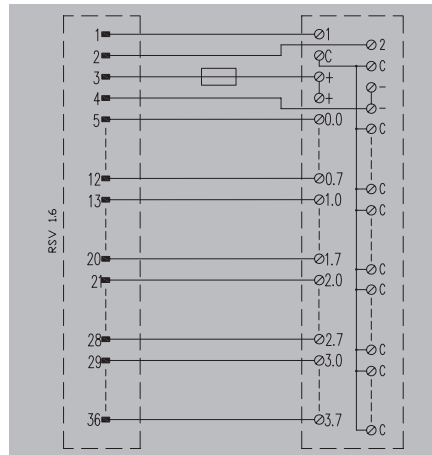
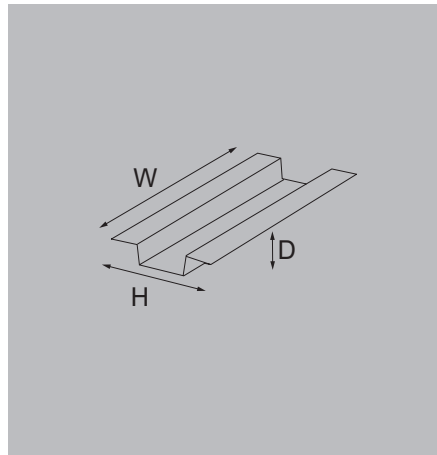

Technical data

Connection data and functionality	
Connection on control side	
Number of poles (control side)	
LED status display per channel	
LED status of the supply voltage	
Fuse per channel	
Power supply fuse	
Type of test point	
Rated data	
Operating voltage	
Max. current per channel	
Operating voltage (supply)	
Operating current (supply)	
General data	
Ambient temperature (operational)	
Storage temperature	
Approvals	
Insulation coordination (EN50178)	
Rated insulation voltage	
Surge voltage category	
Pollution severity level	
Pulse voltage test (1,2/50µs)	
Dimensions	
Clamping range, min./max.	
Clamping range, min./max.	
Rail	
Width / Height	
Note	

Connector RSV 1.6
36-pole female
No
No
No
3.15 A
No
CE
150 V UC
1 A
24 V DC ± 10%
3 A
CE
-25...50 °C
-40...60 °C
CE, EAC
< 150 V AC
II
2
1.5 kV
Screw connection
0.2 mm ² / 2.5 mm ²
0.2 mm ² / 2.5 mm ²
TS 35, TS 32
200 mm / 87 mm
The common C may carry up to 3 A if the external jumpers are not used

Connector RSV 1.6
36-pole female
No
No
2 A
3.15 A
No
CE
150 V UC
1 A
24 V DC ± 10%
3 A
CE
-25...50 °C
-40...60 °C
CE, EAC
< 150 V AC
II
2
1.5 kV
Screw connection
0.13 mm ² / 6 mm ²
0.13 mm ² / 6 mm ²
TS 35, TS 32
200 mm / 109 mm
The common C may carry up to 3 A if the external jumpers are not used

Ordering data

Screw connection without LED

Type	Depth	Order No.
RS 32IO 2W R S	72 mm	9441710000

Type	Depth	Order No.
RS 32IO 2W F R S	84 mm	9441570000

Note

The UL values only apply to the version with screw connection (UL recognised).
--

The UL values only apply to the version with screw connection (UL recognised).
--





















Accessories

Note

--

--

RS A – Selection guide for passive interfaces for analogue signals

Type of Interface		Features					Interfaces		
Number of channels	Family	Connection		Common distribution	Disconnectable	Test points	Order No.	Type	Page
		Screw connection	Tension clamp connection						
Universal	A15						8005201001	RS SD15S UNC 4.40 LP2N	D.8
							8537390000	RS SD15 SZ	D.8
	A25						8005181001	RS SD25S UNC 4.40 LP2N	D.8
							8537370000	RS SD25 SZ	D.8
	A37						8003881001	RS SD37S UNC 4.40 LP2N	D.8
							8537240000	RS SD37 SZ	D.8
A50						8005161001	RS SD50S UNC 4.40 LP2N	D.8	
						8537350000	RS SD50 SZ	D.8	
4-channels	A1504			TTTT			9448000000	RS 4AI0 DP SD S	A.54
				TTTT			1308230000	RS 4AI0 DP SD Z	A.54
				TTTT	(↔)	!	9448100000	RS 4AI0 I-M-DP SD S	A.54
				TTTT	(↔)	!	1308240000	RS 4AI0 I-M-DP SD Z	A.54
8-channel	A2508			TTTT			9448010000	RS 8AI0 DP SD S	A.55
				TTTT			1308250000	RS 8AI0 DP SD Z	A.55
				TTTT	(↔)	!	9448110000	RS 8AI0 I-M-DP SD S	A.55
				TTTT	(↔)	!	9449110000	RS 8AI0 I-M-DP SD Z	A.55
8-channel P	A2508P			TTTT	(↔)		9448030000	RS 8AI PREM/APR SD S	A.56
16-channel	A3716			TTTT			9448020000	RS 16AI0 DP SD S	A.57
				TTTT			1308270000	RS 16AI0 DP SD Z	A.57
				TTTT	(↔)	!	9448120000	RS 16AI0 I-M-DP SD S	A.57
				TTTT	(↔)	!	1308280000	RS 16AI0 I-M-DP SD Z	A.57
Note:	Coding of the interface descriptions								
	RS 4AI0: 4 inputs/outputs 8AI0: 8 inputs/outputs 8AI: 8 inputs 8AI1AO: 8 inputs/1 outputs 16AI0: 16 inputs/outputs	DP: Power distribution (empty)	I-M: Switch + Test point M258: For Schneider M258 PREM/APR: For Schneider Premium MICRO: For Schneider Micro (empty)	SD connector SUB-D	S: Screw connection Z: Tension clamp connection				

**RS A - Passive interface
for 4 analogue signals**

Analogue input/output passive interface:

- With test points or disconnection per channel (optional)
- Screw or tension clamp connection

RS 4AIO DP SD

4 channels



RS 4AIO I-M-DP SD

4 channels, test points and disconnection per channel

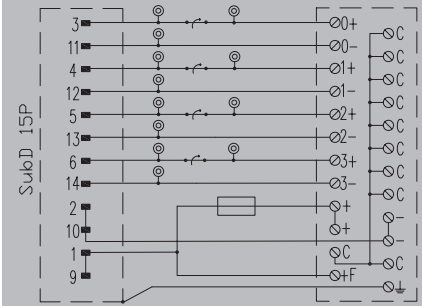
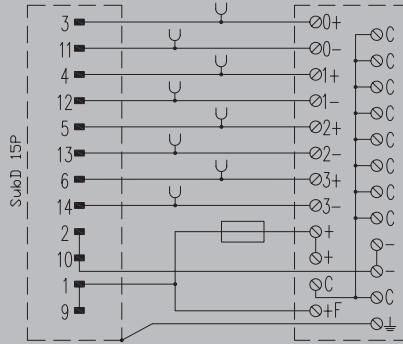
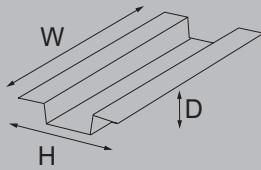

Technical data

Connection data and functionality	
Connection on control side	
Number of poles (control side)	
LED status display per channel	
LED status of the supply voltage	
Power supply fuse	
Type of test point	
Rated data	
Operating voltage	
Max. current per channel	
Operating voltage (supply)	
Operating current (supply)	
General data	
Ambient temperature (operational)	
Storage temperature	
Approvals	
Insulation coordination (EN50178)	
Rated insulation voltage	
Surge voltage category	
Pollution severity level	
Pulse voltage test (1,2/50µs)	
Dimensions	
Clamping range, min./max.	
Clamping range, min./max.	
Rail	
Width / Height	
Note	

D-sub connectors, acc. to IEC 60807 / DIN 41652			
15-pole plug			
No			
No			
3.15 A			
No			
CE			
≤ 25 V AC / 50 V DC			
0.5 A			
24 V DC ± 10%			
3 A			
-20...50 °C			
-40...60 °C			
CE; EAC			
< 50 V AC			
III			
2			
0.8 kV			
Screw connection		Tension clamp conn.	
0.13 mm ² / 6 mm ²		0.13 mm ² / 2.5 mm ²	
0.13 mm ² / 6 mm ²		0.13 mm ² / 2.5 mm ²	
TS 35, TS 32		TS 35, TS 32	
75 mm / 87 mm		75 mm / 87 mm	
The common C may carry up to 3 A if the external jumpers are not used			

D-sub connectors, acc. to IEC 60807 / DIN 41652			
15-pole plug			
No			
No			
3.15 A			
Diameter: 4 mm			
CE			
≤ 25 V AC / 50 V DC			
0.5 A			
24 V DC ± 10%			
3 A			
-20...50 °C			
-40...60 °C			
CE; EAC			
< 50 V AC			
III			
2			
0.8 kV			
Screw connection		Tension clamp conn.	
0.13 mm ² / 6 mm ²		0.13 mm ² / 2.5 mm ²	
0.13 mm ² / 6 mm ²		0.13 mm ² / 2.5 mm ²	
TS 35, TS 32		TS 35, TS 32	
73 mm / 109 mm		73 mm / 109 mm	
The common C may carry up to 3 A if the external jumpers are not used			

Ordering data

Type	Depth	Order No.
RS 4AIO DP SD S	72 mm	944800000
RS 4AIO DP SD Z	72 mm	1308230000

Type	Depth	Order No.
RS 4AIO I-M-DP SD S	81 mm	9448100000
RS 4AIO I-M-DP SD Z	81 mm	1308240000

Note

The UL values only apply to the version with screw connection (UL recognised).

The UL values only apply to the version with screw connection (UL recognised).

Accessories

Note

RS A – Interface
for 8 analogue signals

Analogue input/output passive interface:

- With test points or disconnection per channel (optional)
- Screw or tension clamp connection

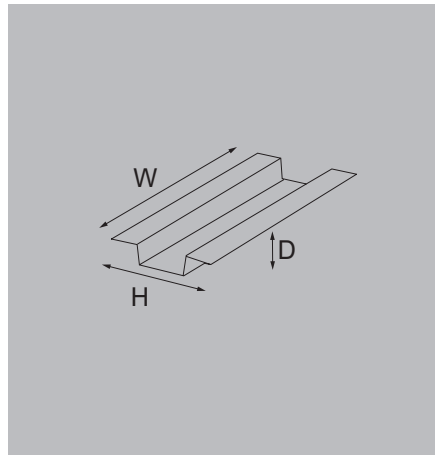

RS 8AIO DP SD

8 channels

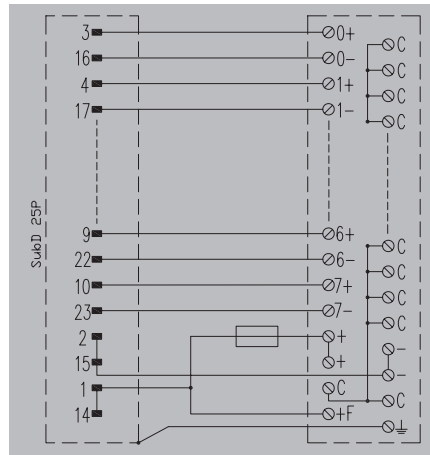
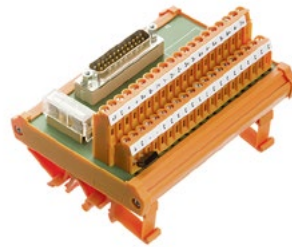

RS 8AIO I-M-DP SD

8 channels, test points and disconnection per channel

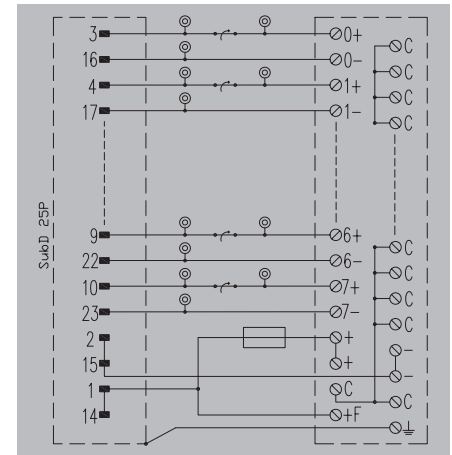

Technical data

Connection data and functionality	
Connection on control side	
Number of poles (control side)	
LED status display per channel	
LED status of the supply voltage	
Power supply fuse	
Type of test point	
Rated data	
Operating voltage	
Max. current per channel	
Operating voltage (supply)	
Operating current (supply)	
General data	
Ambient temperature (operational)	
Storage temperature	
Approvals	
Insulation coordination (EN50178)	
Rated insulation voltage	
Surge voltage category	
Pollution severity level	
Pulse voltage test (1,2/50µs)	
Dimensions	
Clamping range, min./max.	
Clamping range, min./max.	
Rail	
Width / Height	
Note	

D-sub connectors, acc. to IEC 60807 / DIN 41652	
25-pole plug	
No	
No	
3.15 A	
No	
CE	
≤ 25 V AC / 50 V DC	
0.5 A	
24 V DC ± 10%	
3 A	
Screw connection	
0.13 mm ² / 6 mm ²	
0.13 mm ² / 6 mm ²	
TS 35, TS 32	
117 mm / 87 mm	
Tension-clamp connection	
0.13 mm ² / 2.5 mm ²	
0.13 mm ² / 2.5 mm ²	
TS 35, TS 32	
117 mm / 87 mm	
The common C may carry up to 3 A if the external jumpers are not used	

D-sub connectors, acc. to IEC 60807 / DIN 41652	
25-pole plug	
No	
No	
3.15 A	
Diameter: 4 mm	
CE	
≤ 25 V AC / 50 V DC	
0.5 A	
24 V DC ± 10%	
3 A	
Screw connection	
0.13 mm ² / 6 mm ²	
0.13 mm ² / 6 mm ²	
TS 35, TS 32	
114 mm / 109 mm	
Tension-clamp connection	
0.13 mm ² / 2.5 mm ²	
0.13 mm ² / 2.5 mm ²	
TS 35, TS 32	
114 mm / 109 mm	
The common C may carry up to 3 A if the external jumpers are not used	

Ordering data

Screw connection	
Tension clamp connection	

Type	Depth	Order No.
RS 8AIO DP SD S	72 mm	9448010000
RS 8AIO DP SD Z	72 mm	1308250000

Type	Depth	Order No.
RS 8AIO I-M-DP SD S	81 mm	9448110000
RS 8AIO I-M-DP SD Z	81 mm	9449110000

Note

The UL values only apply to the version with screw connection (UL recognised).

The UL values only apply to the version with screw connection (UL recognised).

Accessories

Note

RS A - Interface
for 8 and 9 analogue signals for Schneider
Micro/Premium

Analogue input/output passive interface:

- With test points or disconnection per channel (optional)
- Screw or tension clamp connection

RS 8AI PREM/APR SD

8 channels for Premium (Schneider) config. by volt. or current

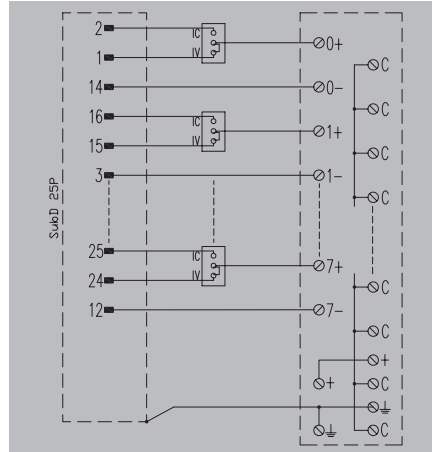
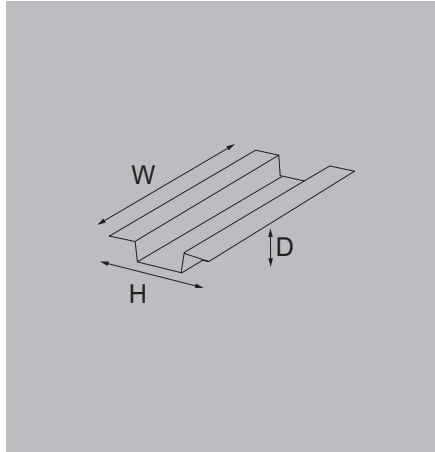
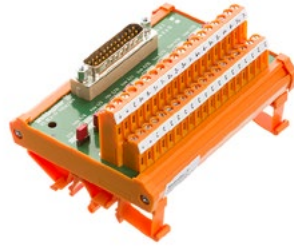

Technical data

Connection data and functionality	
Connection on control side	
Number of poles (control side)	
LED status display per channel	
LED status of the supply voltage	
Power supply fuse	
Type of test point	
Rated data	
Operating voltage	
Max. current per channel	
Operating voltage (supply)	
Operating current (supply)	
General data	
Ambient temperature (operational)	
Storage temperature	
Approvals	
Insulation coordination (EN50178)	
Rated insulation voltage	
Surge voltage category	
Pollution severity level	
Pulse voltage test (1,2/50µs)	
Dimensions	
Clamping range, min./max.	
Clamping range, min./max.	
Rail	
Width / Height	
Note	

Connection data and functionality	
D-sub connectors, acc. to IEC 60807 / DIN 41652	
25-pole plug	
No	
No	
No	
No	
CE	
≤ 25 V AC / 50 V DC	
0.5 A	
24 V DC ± 10%	
3 A	
Temperature	
-20...50 °C	
-40...60 °C	
CE; EAC	
Insulation coordination (EN50178)	
< 50 V AC	
III	
2	
0.8 kV	
Screw connection	
0.13 mm ² / 6 mm ²	
0.13 mm ² / 6 mm ²	
TS 35, TS 32	
116 mm / 87 mm	
The common C may carry up to 3 A if the external jumpers are not used	

Ordering data

Screw connection

Type	Depth	Order No.
RS 8AI PREM/APR SD S	72 mm	9448030000

Note

The UL values only apply to the version with screw connection (UL recognised).

Accessories

Note

RS A – Interface
for 16 analogue signals

Analogue input/output passive interface:

- With test points or disconnection per channel (optional)
- Screw or tension clamp connection

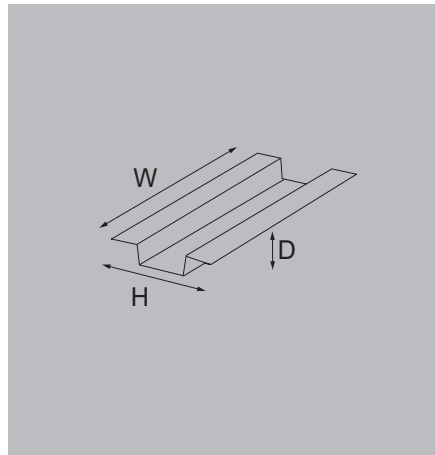

RS 16AIO DP SD

16 channels

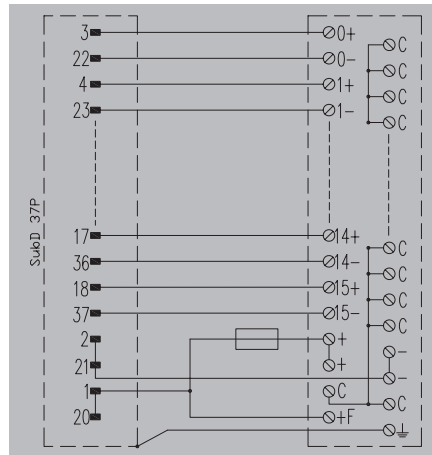

RS 16AIO I-M-DP SD

16 channels, test points and disconnection per channel

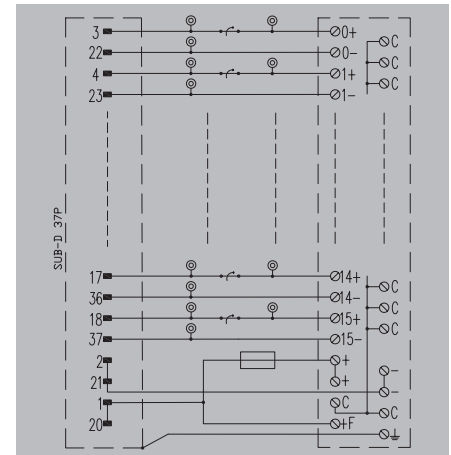
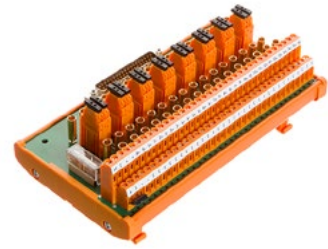

Technical data

Connection data and functionality	
Connection on control side	
Number of poles (control side)	
LED status display per channel	
LED status of the supply voltage	
Power supply fuse	
Type of test point	
Rated data	
Operating voltage	
Max. current per channel	
Operating voltage (supply)	
Operating current (supply)	
General data	
Ambient temperature (operational)	
Storage temperature	
Approvals	
Insulation coordination (EN50178)	
Rated insulation voltage	
Surge voltage category	
Pollution severity level	
Pulse voltage test (1,2/50µs)	
Dimensions	
Clamping range, min./max.	
Clamping range, min./max.	
Rail	
Width / Height	
Note	

D-sub connectors, acc. to IEC 60807 / DIN 41652	
37-pole plug	
No	
No	
3.15 A	
No	
CE	
≤ 25 V AC / 50 V DC	
0.5 A	
24 V DC ± 10%	
3 A	
Screw connection	
0.13 mm ² / 6 mm ²	
0.13 mm ² / 6 mm ²	
TS 35, TS 32	
205 mm / 87 mm	
Tension-clamp connection	
0.13 mm ² / 2.5 mm ²	
0.13 mm ² / 2.5 mm ²	
TS 35, TS 32	
205 mm / 87 mm	
The common C may carry up to 3 A if the external jumpers are not used	

D-sub connectors, acc. to IEC 60807 / DIN 41652	
37-pole plug	
No	
No	
3.15 A	
Diameter: 4 mm	
CE	
≤ 25 V AC / 50 V DC	
0.5 A	
24 V DC ± 10%	
3 A	
Screw connection	
0.13 mm ² / 6 mm ²	
0.13 mm ² / 6 mm ²	
TS 35, TS 32	
197 mm / 109 mm	
Tension-clamp connection	
0.13 mm ² / 2.5 mm ²	
0.13 mm ² / 2.5 mm ²	
TS 35, TS 32	
197 mm / 109 mm	
The common C may carry up to 3 A if the external jumpers are not used	

Ordering data

	Screw connection
	Tension clamp connection

Type	Depth	Order No.
RS 16AIO DP SD S	81 mm	9448020000
RS 16AIO DP SD Z	72 mm	1308270000

Type	Depth	Order No.
RS 16AIO I-M-DP SD S	81 mm	9448120000
RS 16AIO I-M-DP SD Z	81 mm	1308280000

Note



The UL values only apply to the version with screw connection (UL recognised).

The UL values only apply to the version with screw connection (UL recognised).

Accessories

Note

RSM – Selection guide for insulated interfaces for digital input signals

Type of Interface		Features			Interfaces			
Number of channels	Family	Design	Connection		Voltage	Order No.	Type	Page
			Screw connection	Tension clamp connection				
16-channel	I2016	>C<			24 V DC	1312000000	RSM-16DI 24VDC S	A.59
		>C<			24 V DC	1312010000	RSM-16DI 24VDC Z	A.59
		>C<			48 V DC	1312020000	RSM-16DI 48VDC S	A.60
Note								

**RSM – Isolated interfaces
for 16 digital input signals**

Relay digital input interface for transmitting electrical signals between the PLC and the field via pre-wired cables of Weidmüller's universal system:

- Electrical insulation using pluggable relays (interchangeable with solid-state relays; 6.1 mm RSS relays)

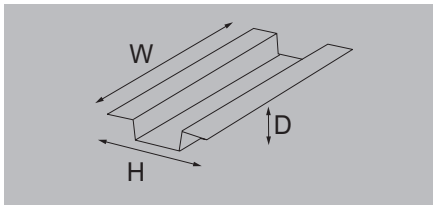

RSM-16 DI 24 V DC

6 mm relays; 24 VDC AU



Technical data

Connection data and functionality	
Connection on control side	
Number of poles (control side)	
Relay type	
LED status display per relay	
LED status of the supply voltage	
Power supply fuse	
Nominal input data	
Input voltage	
Input current	
Operating voltage (supply)	
Operating current (supply)	
Nominal output data	
Contact material	
Operating voltage	
Max. DC continuous current	
Minimum contact current	
Minimum contact voltage	
Mechanical service life	
General data	
Ambient temperature (operational)	
Storage temperature	
Approvals	
Insulation coordination (EN50178)	
Rated input insulation voltage	
Rated output insulation voltage	
Overvoltage category input/output	
Overvoltage category input/input	
Pollution severity level	
Pulse voltage test (1,2/50µs)	
Insulation test voltage	
Clearance input/output	
Dimensions	
Clamping range, min./max.	
Clamping range, min./max.	
Rail	
Width / Height	
Note	

Plug-in connector in acc. with IEC60603-13 / DIN41651	
20-pole plug	
RSS	
green	
yellow	
2 A	
CE	
24 V DC ± 10%	
13 mA	
24 V DC ± 10%	
2 A	
CE	
AgNi gold flashed	
24 V DC ± 10%	
0.1 A	
1 mA	
1 V	
5 x 10 ⁶ switching cycles	
CE	
-20...50 °C	
-20...70 °C	
CE; EAC	
≤ 50 V DC	
≤ 50 V DC	
III	
III	
2	
1.5 kV	
0.35 kVAC	
≥ 6 mm	
Screw connection	
0.13 mm ² / 6 mm ²	
0.13 mm ² / 6 mm ²	
TS 35, TS 32	
124 mm / 109 mm	
Tension clamp conn.	
0.13 mm ² / 2.5 mm ²	
0.13 mm ² / 2.5 mm ²	
TS 35, TS 32	
124 mm / 109 mm	

Ordering data

Screw connection without switch	
Tension clamp connection without switch	

Note

Accessories

Note	Relay 4061590000 RSS 24 V DC 1CD AU
-------------	-------------------------------------

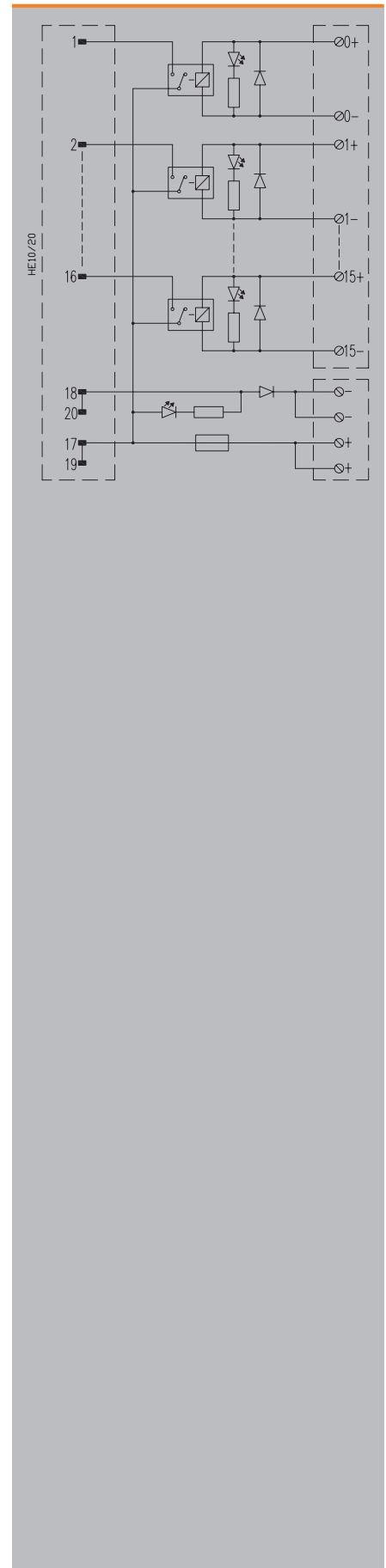

RSM – Isolated interfaces for digital input signals

RSM – Isolated interfaces for 16 digital input signals

Relay digital input interface for transmitting electrical signals between the PLC and the field via pre-wired cables of Weidmüller's universal system:

- Electrical insulation using pluggable relays (interchangeable with solid-state relays; 6.1 mm RSS relays)

RSM-16 DI 48 V DC

6 mm relays; 48 VDC AU

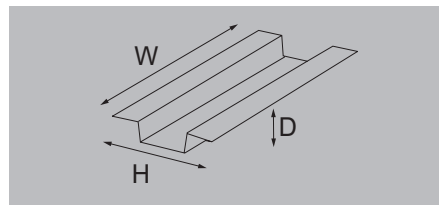

Technical data

Connection data and functionality	
Connection on control side	
Number of poles (control side)	
Relay type	
LED status display per relay	
LED status of the supply voltage	
Power supply fuse	
Nominal input data	
Input voltage	
Input current	
Operating voltage (supply)	
Operating current (supply)	
Nominal output data	
Contact material	
Operating voltage	
Max. DC continuous current	
Minimum contact current	
Minimum contact voltage	
Mechanical service life	
General data	
Ambient temperature (operational)	
Storage temperature	
Approvals	
Insulation coordination (EN50178)	
Rated input insulation voltage	
Rated output insulation voltage	
Overvoltage category input/output	
Overvoltage category input/input	
Pollution severity level	
Pulse voltage test (1,2/50µs)	
Insulation test voltage	
Clearance input/output	
Dimensions	
Clamping range, min./max.	
Clamping range, min./max.	
Rail	
Width / Height	
Note	

Plug-in connector in acc. with IEC60603-13 / DIN41651	
20-pole plug	
RSS	
green	
yellow	
2 A	
CE	
48 V DC ± 10%	
10 mA	
24 V DC ± 10%	
2 A	
CE	
AgNi gold flashed	
24 V DC ± 10%	
0.1 A	
2 mA	
5 V	
10 x 10 ⁶ switching cycles	
CE	
-20...50 °C	
-20...70 °C	
CE; EAC	
Screw connection	
0.13 mm ² / 6 mm ²	
0.13 mm ² / 6 mm ²	
TS 35, TS 32	
124 mm / 109 mm	

Ordering data

Screw connection without switch	
Tension clamp connection without switch	

Note

Accessories

Note

Type	Depth	Order No.
RSM-16DI 48VDC S	72 mm	1312020000

Relay 1313530000 48 V 1 CO AU

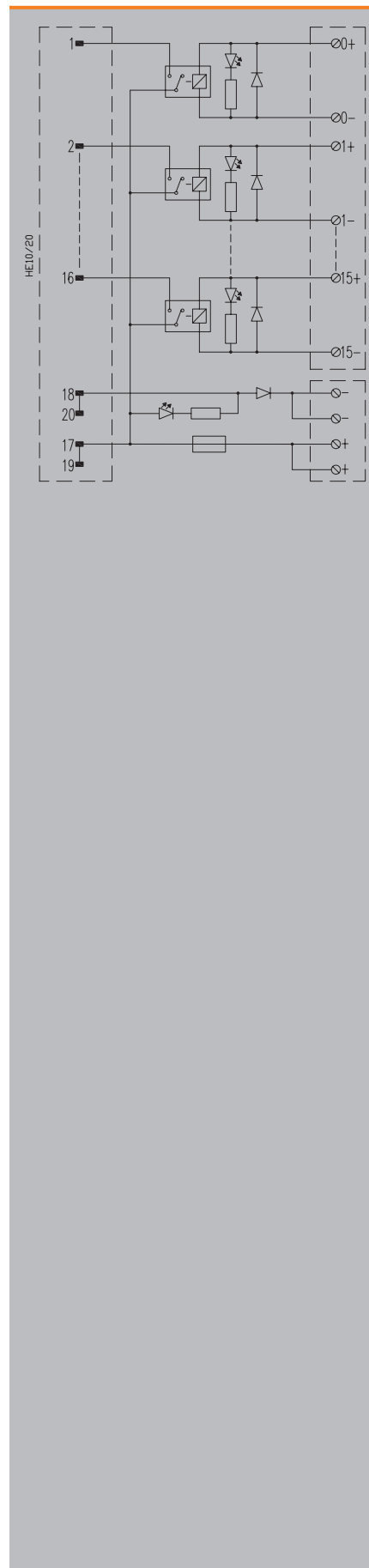

RSM – Selection guide for insulated interfaces for digital output signals

Universal solutions for PLC input/output cards

A

Type of Interface		Features								Interfaces			
Number of channels	Family	Design	Connection		Voltage	Type of contact	Fuse	Switch (coil)	Switch (contact)	Order No.	Type	Page	
			Screw	Tension clamp/PUSH IN									
8-channel	02008	>C<			24 V DC	1CO				1456540000	RSMS-8H 24V+ 1CO S	A.63	
		>C<			24 V DC	1CO				1456570000	RSMS-8H 24V+ 1CO Z	A.63	
		>C<			24 V DC	1CO					1128990000	RSM-8 PLC C SW 1CO S	A.64
		2 lines			24 V DC	1CO					9445000000	RSM-8 C 1CO S	A.65
		2 lines			24 V DC	1CO					9447000000	RSM-8 C 1CO Z	A.65
		1 line			24 V DC	1CO					1464780000	RSM-8H 24V+ 1CO S	A.66
		1 line			24 V DC	1CO					1464790000	RSM-8H 24V+ 1CO Z	A.66
		1 line			24 V DC	1NO					1457390000	RSM-8 24VDC 1NO + C S	A.67
1 line			24 V DC	1NO					1457400000	RSM-8 24VDC 1NO + C Z	A.67		
8-channel	02008N Negative switching	>C<			24 V DC	1CO				1456550000	RSMS-8H 24V- 1CO S	A.68	
		>C<			24 V DC	1CO				1456580000	RSMS-8H 24V- 1CO Z	A.68	
		1 line			24 V DC	1CO				1464800000	RSM-8H 24V- 1CO S	A.69	
		1 line			24 V DC	1CO				1464810000	RSM-8H 24V- 1CO Z	A.69	
16-channel	02016	>C<			24 V DC	1CO				1457300000	RSMS-16H 24V+ 1CO S	A.70	
		>C<			24 V DC	1CO				1457320000	RSMS-16H 24V+ 1CO Z	A.70	
		>C<			24 V DC	1CO					1129030000	RSM-16 PLC C SW 1CO S	A.71
		>C<			24 V DC	1CO					1129040000	RSM-16 PLC C SW 1CO Z	A.71
		1 line			24 V DC	1CO					1448280000	RSM-16 24V+ 1CO S	A.72
		1 line			24 V DC	1CO					1448300000	RSM-16 24V+ 1CO Z	A.72
		1 line			24 V DC (+/-)	1CO					1129120000	RSM-16 PLC SW 1CO S	A.73
		1 line			24 V DC (+/-)	1CO					1129130000	RSM-16 PLC SW 1CO Z	A.73
		2 lines			24 V DC	1CO					9445100000	RSM-16 C 1CO S	A.74
		2 lines			24 V DC	1CO					9447100000	RSM-16 C 1CO Z	A.74
		1 line			24 V DC	2CO					1449210000	RSM-16 24V+ 2CO S	A.75
		1 line			24 V DC	2CO					1449230000	RSM-16 24V+ 2CO Z	A.75
		1 line			24 V DC	1CO					9445120000	RSM-16 FUS 1CO S	A.76
		1 line			24 V DC	1CO					9447120000	RSM-16 FUS 1CO Z	A.76
		1 line			24 V DC	1CO					9445140000	RSM-16 FOR 1CO S	A.77
		1 line			24 V DC	1NO					1448450000	RSM-16 24VDC 1NO + C S	A.78
		1 line			24 V DC	1NO					1448470000	RSM-16 24VDC 1NO + C Z	A.78
		1 line			24 V DC	without relays					1448480000	RSM-16 24V+ BASE S	A.79
1 line			24 V DC	without relays					1448490000	RSM-16 24V+ BASE Z	A.79		
16-channel	02016N Negative switching	>C<			24 V DC	1CO				1457310000	RSMS-16H 24V- 1CO S	A.80	
		>C<			24 V DC	1CO				1457330000	RSMS-16H 24V- 1CO Z	A.80	
		1 line			24 V DC	1CO				1448290000	RSM-16 24V- 1CO S	A.81	
		1 line			24 V DC	1CO				1448310000	RSM-16 24V- 1CO Z	A.81	
		1 line			24 V DC	2CO				1449220000	RSM-16 24V- 2CO S	A.82	
		1 line			24 V DC	2CO				1449250000	RSM-16 24V- 2CO Z	A.82	

Note 1: Design: >C< 1 line 2 lines

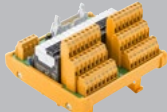

Relays with 6 mm relay



RCL Relays arranged in 1 single line

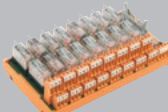

RCL relays (arranged in 2 rows)

Note 2: Voltage: Modules indicated with 24 V DC (+/-) can function as positive or negative and can function with negative logic PLC cards

RSM – Isolated interfaces for 8 digital output signals

Digital output relay interface for transmitting electrical signals between the PLC and the field via pre-wired cables of Weidmüller's universal system.

- Input/output reinforced insulation (basic between contacts)
- Positive switching

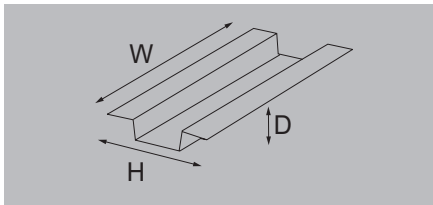

RSMS-8H 24V+ 1CO

6 mm relay with 1 CO contact and without switch

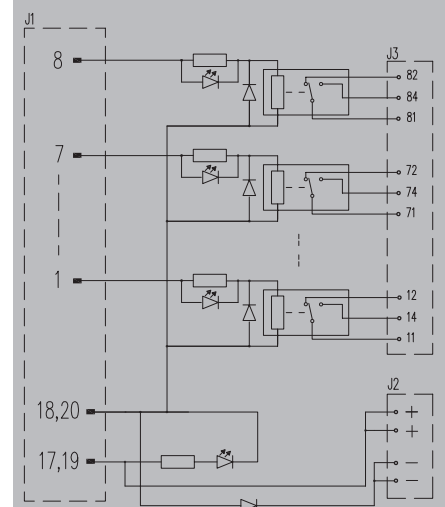

Technical data

Connection data and functionality	
Connection on control side	
Number of poles (control side)	
Relay type	
LED status display per relay	
LED status of the supply voltage	
Fuse per relay	
Power supply fuse	
Nominal input data	
Input voltage	
Input current	
Operating voltage (supply)	
Operating current (supply)	
Nominal output data	
Contact material	
Operating voltage	
Max. AC continuous current	
Minimum contact current	
Minimum contact voltage	
Mechanical service life	
General data	
Ambient temperature (operational)	
Storage temperature	
Approvals	
Insulation coordination (EN50178)	
Rated input insulation voltage	
Rated output insulation voltage	
Overvoltage category input/output	
Overvoltage category output/output	
Pollution severity level	
Pulse voltage test (1,2/50µs)	
Insulation test voltage	
Clearance input/output	
Dimensions	
Clamping range, min./max.	
Clamping range, min./max.	
Rail	
Width / Height	
Note	

Plug-in connector in acc. with IEC60603-13 / DIN41651, LL 5.08 mm	
20-pole plug	
RSS	
green	
yellow	
No	
No	
CE	
24 V DC ± 10%	
7.1 mA	
24 V DC ± 10%	
1 A	
CE	
AgNi 90/10	
250 V AC	
4.5 A	
100 mA	
5 V	
5 x 10 ⁶ switching cycles	
CE	
-25...50 °C	
-40...60 °C	
CE, EAC	
< 50 V AC	
250 V AC	
III	
II	
2	
6 kV	
1.2 kVAC	
≥ 5.5 mm	
Screw connection	
0.13 mm ² / 6 mm ²	
0.13 mm ² / 6 mm ²	
TS 35, TS 32	
61 mm / 109 mm	
Tension clamp conn.	
0.13 mm ² / 2.5 mm ²	
0.13 mm ² / 2.5 mm ²	
TS 35, TS 32	
72 mm / 109 mm	

Ordering data

Screw connection without switch	
Screw connection with switch	
Tension clamp connection without switch	
Note	

Type	Depth	Order No.
RSMS-8H 24V+ 1CO S	85 mm	1456540000
RSMS-8H 24V+ 1CO Z	61 mm	1456570000

Accessories

Relay 4060120000 RSS 24 V DC 1 CO

RSM – Isolated interfaces for digital output signals
**RSM – Isolated interfaces
for 8 digital output signals**

Digital output relay interface for transmitting electrical signals between the PLC and the field via pre-wired cables of Weidmüller's universal system.

- Input/output reinforced insulation (basic between contacts)
- Positive switching

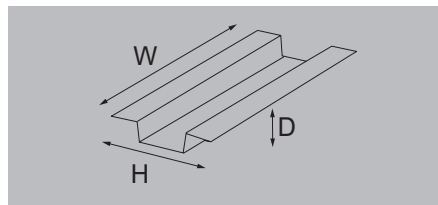
Technical data
Connection data and functionality

Connection on control side
Number of poles (control side)
Relay type
LED status display per relay
LED status of the supply voltage
Fuse per relay
Power supply fuse

Nominal input data

Input voltage
Input current
Operating voltage (supply)
Operating current (supply)

Nominal output data

Contact material
Operating voltage
Max. AC continuous current
Minimum contact current
Minimum contact voltage
Mechanical service life

General data

Ambient temperature (operational)
Storage temperature
Approvals

Insulation coordination (EN50178)

Rated input insulation voltage
Rated output insulation voltage
Overvoltage category input/output
Overvoltage category output/output
Pollution severity level
Pulse voltage test (1,2/50µs)
Insulation test voltage
Clearance input/output

Dimensions

Clamping range, min./max.
Clamping range, min./max.
Rail
Width / Height

Note
Ordering data

Screw connection without switch
Screw connection with switch
Tension clamp connection without switch

Note
Accessories
Note
RSM-8 PLC C 1CO

6 mm relay with 1 CO contact and switch

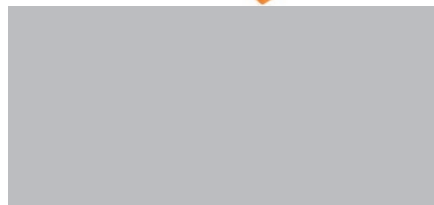

Plug-in connector in acc. with IEC60603-13 / DIN41651

20-pole plug

RSS

green

yellow

No

2.5 A

CE

24 V DC ± 10%

13 mA

24 V DC ± 10%

2 A

CE

AgNi 90/10

250 V AC

2.5 A

0.1 A

5 V

5 x 10⁶ switching cycles

CE

-25...50 °C

-40...60 °C

CE, EAC

< 50 V AC

250 V AC

III

II

2

6 kV

1.2 kVAC

≥ 5.5 mm

Screw connection

0.13 mm² / 6 mm²

0.13 mm² / 6 mm²

TS 35, TS 32

75 mm / 109 mm

Type	Depth	Order No.
RSM-8 PLC C SW 1CO S	85 mm	1128990000

Relay 4060120000 RSS 24 V DC 1CO

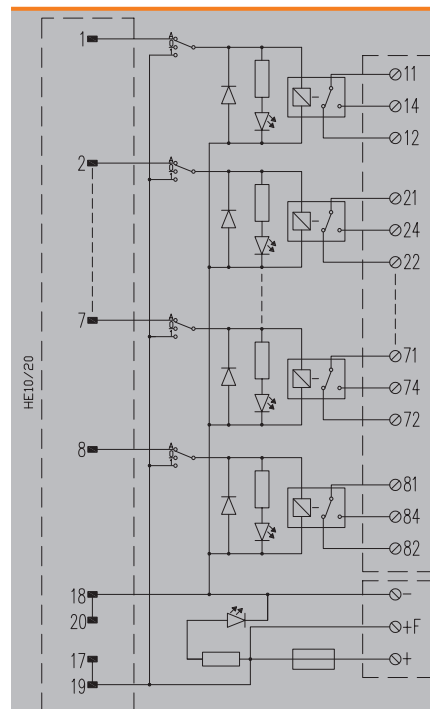

RSM – Isolated interfaces for 8 digital output signals

Digital output relay interface for transmitting electrical signals between the PLC and the field via pre-wired cables of Weidmüller's universal system.

- Input/output reinforced insulation (basic between contacts)
- Positive switching

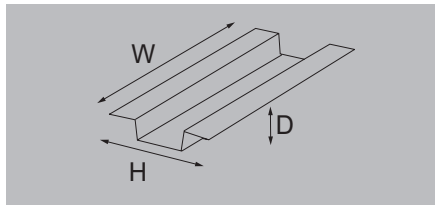

Technical data

Connection data and functionality	
Connection on control side	
Number of poles (control side)	
Relay type	
LED status display per relay	
LED status of the supply voltage	
Fuse per relay	
Power supply fuse	
Nominal input data	
Input voltage	
Input current	
Operating voltage (supply)	
Operating current (supply)	
Nominal output data	
Contact material	
Operating voltage	
Max. AC continuous current	
Minimum contact current	
Minimum contact voltage	
Mechanical service life	
General data	
Ambient temperature (operational)	
Storage temperature	
Approvals	
Insulation coordination (EN50178)	
Rated input insulation voltage	
Rated output insulation voltage	
Overvoltage category input/output	
Overvoltage category output/output	
Pollution severity level	
Pulse voltage test (1,2/50µs)	
Insulation test voltage	
Clearance input/output	
Dimensions	
Clamping range, min./max.	
Clamping range, min./max.	
Rail	
Width / Height	
Note	

Ordering data

Screw connection without switch
Tension clamp connection without switch

Note

Accessories

Note

RSM-8 C 1C

RCL relays (arranged in 2 rows) with 1 CO contact

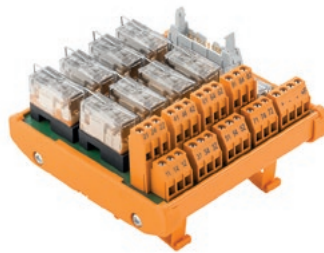

Plug-in connector in acc. with IEC60603-13 / DIN41651	
20-pole plug	
RCL	
green	
yellow	
No	
3.15 A	
CE	
24 V DC ± 10%	
20 mA	
24 V DC ± 10%	
2 A	
CE	
AgNi 90/10	
250 V AC	
5 A	
0.01 A	
10 V	
3 x 10 ⁷ switching cycles	
CE	
-25...50 °C	
-40...60 °C	
CE, EAC	
< 50 V AC	
< 250 V AC	
III	
II	
2	
6 kV	
1.2 kVAC	
≥ 5.5 mm	
Screw connection	Tension-clamp connection
0.13 mm ² / 6 mm ²	0.13 mm ² / 2.5 mm ²
0.13 mm ² / 6 mm ²	0.13 mm ² / 2.5 mm ²
TS 35, TS 32	TS 35, TS 32
110 mm / 109 mm	110 mm / 109 mm

Type	Depth	Order No.
RSM-8 C 1CO S	68 mm	9445000000
RSM-8 C 1CO Z	68 mm	9447000000

Note

Relay 8693260000 RCL314024 24 V DC 1CO
--

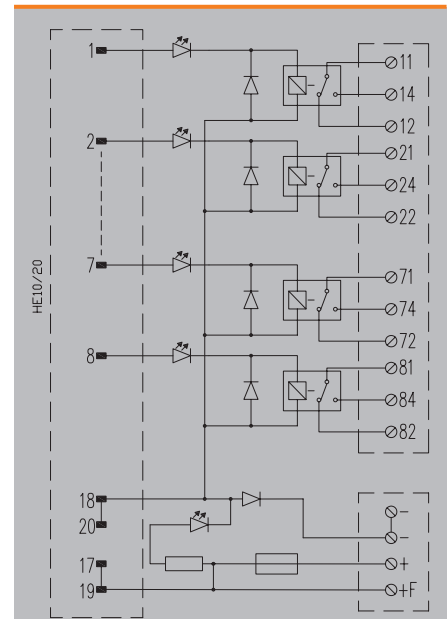

RSM – Interface
for 8 isolated digital output signals

Digital output relay interface for transmitting electrical signals between the PLC and the field via pre-wired cables of Weidmüller's universal system.

- Input/output reinforced insulation (basic between contacts)
- Positive switching

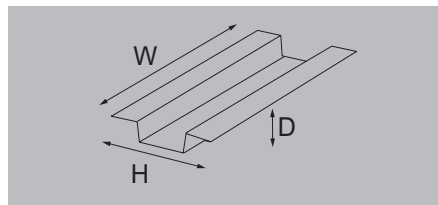

RSM-8H 24V+ 1CO

RCL relays (arranged in 1 row) with 1 CO contact

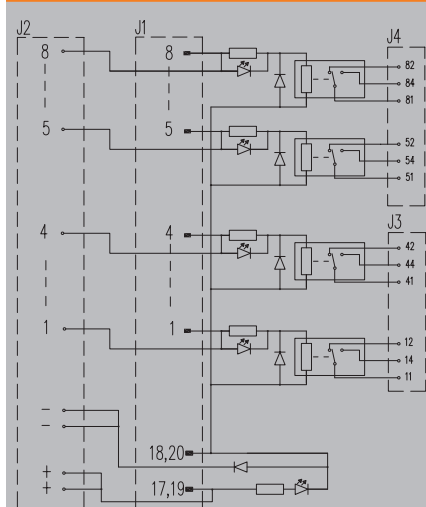

Technical data

Connection data and functionality	
Connection on control side	
Number of poles (control side)	
Relay type	
LED status display per relay	
LED status of the supply voltage	
Fuse per relay	
Power supply fuse	
Nominal input data	
Input voltage	
Input current	
Operating voltage (supply)	
Operating current (supply)	
Nominal output data	
Contact material	
Operating voltage	
Max. AC continuous current	
Minimum contact current	
Minimum contact voltage	
Mechanical service life	
General data	
Ambient temperature (operational)	
Storage temperature	
Approvals	
Insulation coordination (EN50178)	
Rated input insulation voltage	
Rated output insulation voltage	
Overvoltage category input/output	
Overvoltage category output/output	
Pollution severity level	
Pulse voltage test (1,2/50µs)	
Insulation test voltage	
Clearance input/output	
Dimensions	
Clamping range, min./max.	
Clamping range, min./max.	
Rail	
Width / Height	
Note	

LL 5.08 mm, Plug-in connector in acc. with IEC60603-13 / DIN41651, 20 p	
20-pole plug	
RCL	
green	
yellow	
No	
No	
CE	
24 V DC ± 10%	
16.7 mA	
24 V DC ± 10%	
1 A	
CE	
AgNi 90/10	
250 V AC	
6 A	
0.1 A	
5 V	
3 x 10 ⁷ switching cycles	
CE	
-25...50 °C	
-40...60 °C	
CE, EAC	
Screw connection	
0.5 mm ² / 6 mm ²	
0.13 mm ² / 6 mm ²	
TS 35, TS 32	
130 mm / 87 mm	
PUSH IN connection	
0.12 mm ² / 2.5 mm ²	
0.12 mm ² / 2.5 mm ²	
TS 35, TS 32	
130 mm / 87 mm	

Ordering data

Screw connection without switch
PUSH IN connection without switch

Note

Accessories

Note

Type	Depth	Order No.
RSM-8H 24V+ 1CO S	62 mm	1464780000
RSM-8H 24V+ 1CO Z	62 mm	1464790000

Relay 8693260000 RCL314024 24 V DC 1 CO

RSM – Interface
for 8 isolated digital output signals

Digital output relay interface for transmitting electrical signals between the PLC and the field via pre-wired cables of Weidmüller's universal system.

- Input/output reinforced insulation (basic between contacts)
- Positive switching

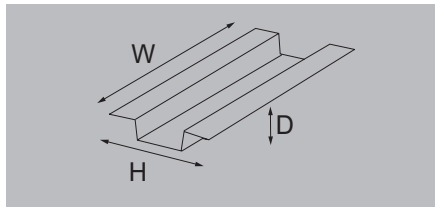

RSM-8 24 V DC 1NO + C

RCL relays (arranged in 1 row) with 1 NO contact

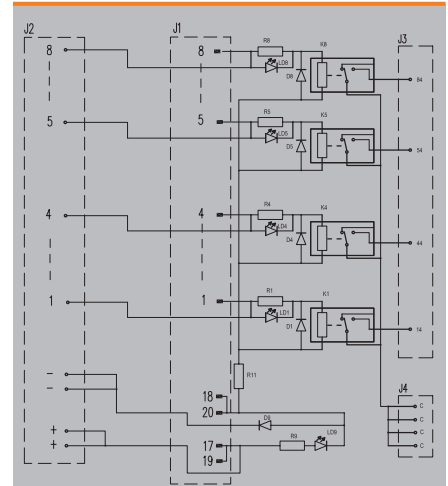

Technical data

Connection data and functionality	
Connection on control side	
Number of poles (control side)	
Relay type	
LED status display per relay	
LED status of the supply voltage	
Fuse per relay	
Power supply fuse	
Nominal input data	
Input voltage	
Input current	
Operating voltage (supply)	
Operating current (supply)	
Nominal output data	
Contact material	
Operating voltage	
Max. AC continuous current	
Minimum contact current	
Minimum contact voltage	
Mechanical service life	
General data	
Ambient temperature (operational)	
Storage temperature	
Approvals	
Insulation coordination (EN50178)	
Rated input insulation voltage	
Rated output insulation voltage	
Overvoltage category input/output	
Overvoltage category output/output	
Pollution severity level	
Pulse voltage test (1,2/50µs)	
Insulation test voltage	
Clearance input/output	
Dimensions	
Clamping range, min./max.	
Clamping range, min./max.	
Rail	
Width / Height	
Note	

LL 5.08 mm, Plug-in connector in acc. with IEC60603-13 / DIN41651, 20 p	
20-pole plug	
RCL	
green	
yellow	
No	
No	
CE	
24 V DC ± 10%	
16.7 mA	
24 V DC ± 10%	
1 A	
CE	
AgNi 90/10	
250 V AC	
6 A	
0.1 A	
5 V	
3 x 10 ⁷ switching cycles	
CE	
-25...50 °C	
-40...60 °C	
CE, EAC	
< 50 V AC	
250 V AC	
III	
II	
2	
6 kV	
1.2 kVAC	
≥ 5.5 mm	
Screw connection	
0.13 mm ² / 6 mm ²	
0.13 mm ² / 6 mm ²	
TS 35, TS 32	
130 mm / 87 mm	
PUSH IN connection	
0.12 mm ² / 2.5 mm ²	
0.12 mm ² / 2.5 mm ²	
TS 35, TS 32	
130 mm / 87 mm	

Ordering data

Screw connection without switch
PUSH IN connection without switch

Note

Accessories

Note

Type	Depth	Order No.
RSM-8 24VDC 1NO + C S	62 mm	1457390000
RSM-8 24VDC 1NO + C Z	62 mm	1457400000

Relay 8693260000 RCL314024 24 V DC 1 CO

**RSM – Interface
for 8 isolated digital output signals**

Digital output relay interface for transmitting electrical signals between the PLC and the field via pre-wired cables of Weidmüller's universal system.

- Input/output reinforced insulation (basic between contacts)
- Negative switching

RSMS-8H 24 V- 1CO

6 mm relay with 1 CO contact and without switch

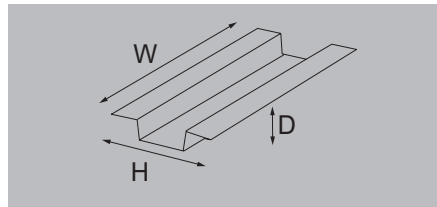

Technical data

Connection data and functionality	
Connection on control side	
Number of poles (control side)	
Relay type	
LED status display per relay	
LED status of the supply voltage	
Fuse per relay	
Power supply fuse	
Nominal input data	
Input voltage	
Input current	
Operating voltage (supply)	
Operating current (supply)	
Nominal output data	
Contact material	
Operating voltage	
Max. AC continuous current	
Minimum contact current	
Minimum contact voltage	
Mechanical service life	
General data	
Ambient temperature (operational)	
Storage temperature	
Approvals	
Insulation coordination (EN50178)	
Rated input insulation voltage	
Rated output insulation voltage	
Overvoltage category input/output	
Overvoltage category output/output	
Pollution severity level	
Pulse voltage test (1,2/50µs)	
Insulation test voltage	
Clearance input/output	
Dimensions	
Clamping range, min./max.	
Clamping range, min./max.	
Rail	
Width / Height	
Note	

Plug-in connector in acc. with IEC60603-13 / DIN41651, LL 5.08 mm			
20-pole plug			
RSS			
green			
yellow			
No			
No			
CE			
24 V DC ± 10%			
7.1 mA			
24 V DC ± 10%			
1 A			
CE			
AgNi 90/10			
250 V AC			
4.5 A			
100 mA			
5 V			
5 x 10 ⁶ switching cycles			
CE			
-25...50 °C			
-40...60 °C			
CE, EAC			
< 50 V AC			
250 V AC			
III			
II			
2			
6 kV			
1.2 kVAC			
≥ 5.5 mm			
Screw connection		Tension-clamp connection	
0.13 mm ² / 6 mm ²		0.13 mm ² / 2.5 mm ²	
0.13 mm ² / 6 mm ²		0.13 mm ² / 2.5 mm ²	
TS 35, TS 32		TS 35, TS 32	
61 mm / 109 mm		61 mm / 109 mm	

Ordering data

Screw connection without switch
Tension clamp connection without switch

Note

Accessories

Note

Type	Depth	Order No.
RSMS-8H 24V- 1CO S	85 mm	1456550000
RSMS-8H 24V- 1CO Z	76 mm	1456580000

Relay 4060120000 RSS V DC 1CO

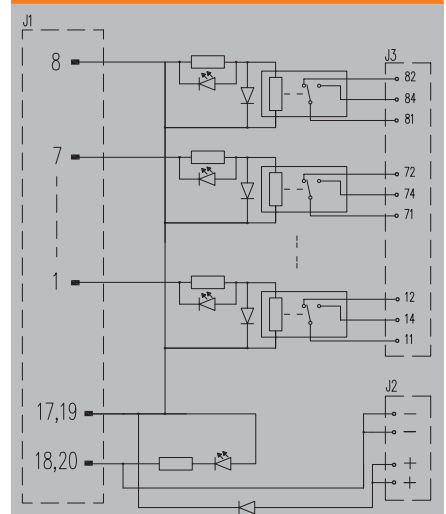

RSM – Interface
for 8 isolated digital output signals

Digital output relay interface for transmitting electrical signals between the PLC and the field via pre-wired cables of Weidmüller's universal system.

- Input/output reinforced insulation (basic between contacts)
- Negative switching

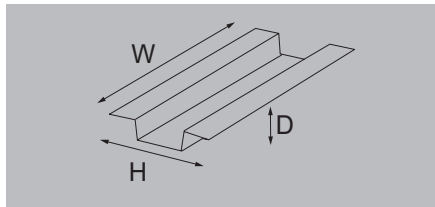

RSM-8H 24 V-1CO

RCL relays (arranged in 1 row) with 1 CO contact

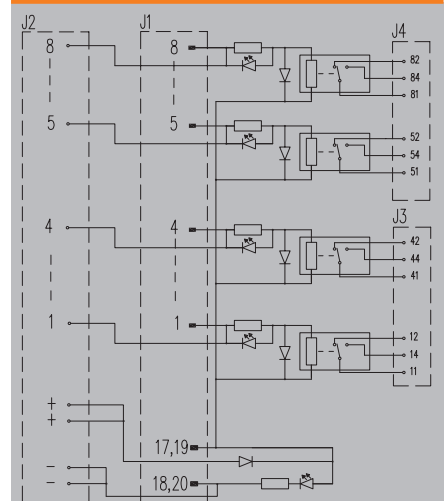

Technical data

Connection data and functionality	
Connection on control side	
Number of poles (control side)	
Relay type	
LED status display per relay	
LED status of the supply voltage	
Fuse per relay	
Power supply fuse	
Nominal input data	
Input voltage	
Input current	
Operating voltage (supply)	
Operating current (supply)	
Nominal output data	
Contact material	
Operating voltage	
Max. AC continuous current	
Minimum contact current	
Minimum contact voltage	
Mechanical service life	
General data	
Ambient temperature (operational)	
Storage temperature	
Approvals	
Insulation coordination (EN50178)	
Rated input insulation voltage	
Rated output insulation voltage	
Overvoltage category input/output	
Overvoltage category output/output	
Pollution severity level	
Pulse voltage test (1,2/50µs)	
Insulation test voltage	
Clearance input/output	
Dimensions	
Clamping range, min./max.	
Clamping range, min./max.	
Rail	
Width / Height	
Note	

LL 5.08 mm, Plug-in connector in acc. with IEC60603-13 / DIN41651, 20 p			
20-pole plug			
RCL			
green			
yellow			
No			
No			
CE			
24 V DC ± 10%			
16.7 mA			
24 V DC ± 10%			
1 A			
CE			
AgNi 90/10			
250 V AC			
6 A			
0.1 A			
5 V			
3 x 10 ⁷ switching cycles			
CE			
-25...50 °C			
-40...60 °C			
CE: EAC			
< 50 V AC			
250 V AC			
III			
II			
2			
6 kV			
1.2 kVAC			
≥ 5.5 mm			
Screw connection		PUSH IN connection	
0.5 mm ² / 6 mm ²		0.12 mm ² / 2.5 mm ²	
0.13 mm ² / 6 mm ²		0.12 mm ² / 2.5 mm ²	
TS 35, TS 32		TS 35, TS 32	
130 mm / 87 mm		130 mm / 87 mm	

Ordering data

	Screw connection without switch
	PUSH IN connection without switch

Type	Depth	Order No.
RSM-8H 24V- 1CO S	62 mm	1464800000
RSM-8H 24V- 1CO Z	62 mm	1464810000

Accessories

Note	Relay 8693260000 RCL314024 24 V DC 1 CO
------	---

RSM – Isolated interfaces for digital output signals

RSM – Isolated interfaces for 16 digital output signals

Digital output relay interface for transmitting electrical signals between the PLC and the field via pre-wired cables of Weidmüller's universal system.

- Input/output reinforced insulation (basic between contacts)
- Positive switching

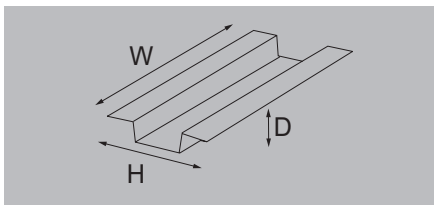

RSMS-16H 24V+ 1CO

6 mm relay with 1 CO contact and without switch

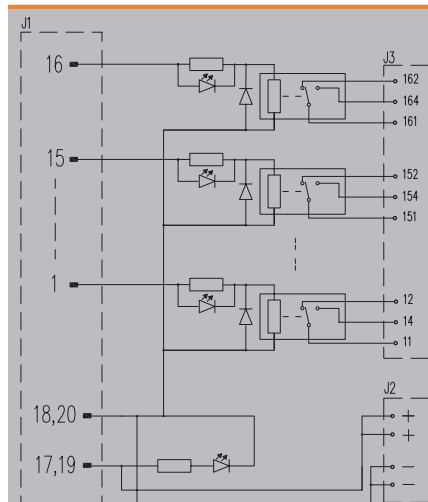

Technical data

Connection data and functionality	
Connection on control side	
Number of poles (control side)	
Relay type	
LED status display per relay	
LED status of the supply voltage	
Fuse per relay	
Power supply fuse	
Nominal input data	
Input voltage	
Input current	
Operating voltage (supply)	
Operating current (supply)	
Nominal output data	
Contact material	
Operating voltage	
Max. AC continuous current	
Minimum contact current	
Minimum contact voltage	
Mechanical service life	
General data	
Ambient temperature (operational)	
Storage temperature	
Approvals	
Insulation coordination (EN50178)	
Rated input insulation voltage	
Rated output insulation voltage	
Overvoltage category input/output	
Overvoltage category output/output	
Pollution severity level	
Pulse voltage test (1,2/50µs)	
Insulation test voltage	
Clearance input/output	
Dimensions	
Clamping range, min./max.	
Clamping range, min./max.	
Rail	
Width / Height	
Note	

Plug-in connector in acc. with IEC60603-13 / DIN41651, LL 5.08 mm			
20-pole plug			
RSS			
green			
yellow			
No			
No			
CE			
24 V DC ± 10%			
7.1 mA			
24 V DC ± 10%			
1 A			
CE			
AgNi 90/10			
250 V AC			
4.5 A			
100 mA			
5 V			
5 x 10 ⁶ switching cycles			
CE			
-25...50 °C			
-40...60 °C			
CE, EAC			
< 50 V AC			
250 V AC			
III			
II			
2			
6 kV			
1.2 kVAC			
≥ 5.5 mm			
Screw connection		Tension-clamp connection	
0.5 mm ² / 6 mm ²		0.13 mm ² / 2.5 mm ²	
0.13 mm ² / 6 mm ²		0.13 mm ² / 2.5 mm ²	
TS 35, TS 32		TS 35, TS 32	
112 mm / 109 mm		112 mm / 109 mm	

Ordering data

Screw connection without switch	
Screw connection with switch	
Tension clamp connection without switch	
Tension clamp connection with switch	
Note	

Type	Depth	Order No.
RSMS-16H 24V+ 1CO S	85 mm	1457300000
RSMS-16H 24V+ 1CO Z	76 mm	1457320000

Accessories

Note	
------	--

Relay 4060120000 RSS 24 V DC 1 CO

**RSM – Isolated interfaces
for 16 digital output signals**

Digital output relay interface for transmitting electrical signals between the PLC and the field via pre-wired cables of Weidmüller's universal system.

- Input/output reinforced insulation (basic between contacts)
- Positive switching

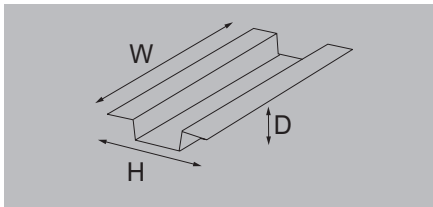

Technical data

Connection data and functionality	
Connection on control side	
Number of poles (control side)	
Relay type	
LED status display per relay	
LED status of the supply voltage	
Fuse per relay	
Power supply fuse	
Nominal input data	
Input voltage	
Input current	
Operating voltage (supply)	
Operating current (supply)	
Nominal output data	
Contact material	
Operating voltage	
Max. AC continuous current	
Minimum contact current	
Minimum contact voltage	
Mechanical service life	
General data	
Ambient temperature (operational)	
Storage temperature	
Approvals	
Insulation coordination (EN50178)	
Rated input insulation voltage	
Rated output insulation voltage	
Overvoltage category input/output	
Overvoltage category output/output	
Pollution severity level	
Pulse voltage test (1,2/50µs)	
Insulation test voltage	
Clearance input/output	
Dimensions	
Clamping range, min./max.	
Clamping range, min./max.	
Rail	
Width / Height	
Note	

Ordering data

	Screw connection without switch
	Screw connection with switch
	Tension clamp connection without switch
	Tension clamp connection with switch
Note	

Accessories

Note
Relay 4060120000 RSS 24 V DC 1CD

RSM-16 PLC C 1CO

6 mm relay with 1 CO contact and switch



Plug-in connector in acc. with IEC60603-13 / DIN41651	
20-pole plug	
RSS	
green	
yellow	
No	
2.5 A	
CE	
24 V DC ± 10%	
13 mA	
24 V DC ± 10%	
2 A	
CE	
AgNi 90/10	
250 V AC	
2.5 A	
0.1 A	
5 V	
5 x 10 ⁶ switching cycles	
CE	
-25...50 °C	
-40...60 °C	
CE, EAC	
< 50 V AC	
250 V AC	
III	
II	
2	
6 kV	
1.2 kVAC	
≥ 5.5 mm	
Screw connection	Tension-clamp connection
0.13 mm ² / 6 mm ²	0.13 mm ² / 2.5 mm ²
0.13 mm ² / 6 mm ²	0.13 mm ² / 2.5 mm ²
TS 35, TS 32	TS 35, TS 32
111 mm / 109 mm	111 mm / 109 mm

Type	Depth	Order No.
RSM-16 PLC C SW 1CO S	85 mm	1129030000
RSM-16 PLC C SW 1CO Z	80 mm	1129040000

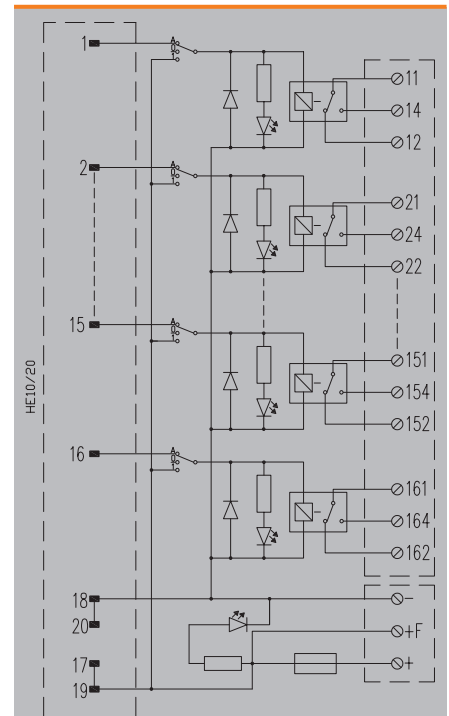

RSM – Isolated interfaces for digital output signals

RSM – Interface for 16 isolated digital output signals

Digital output relay interface for transmitting electrical signals between the PLC and the field via pre-wired cables of Weidmüller's universal system.

- Input/output reinforced insulation (basic between contacts)
- Positive switching

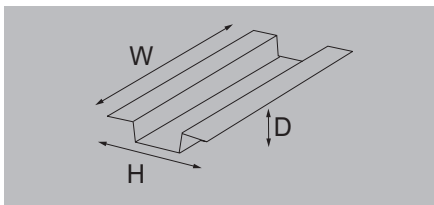

Technical data

Connection data and functionality	
Connection on control side	
Number of poles (control side)	
Relay type	
LED status display per relay	
LED status of the supply voltage	
Fuse per relay	
Power supply fuse	
Nominal input data	
Input voltage	
Input current	
Operating voltage (supply)	
Operating current (supply)	
Nominal output data	
Contact material	
Operating voltage	
Max. AC continuous current	
Minimum contact current	
Minimum contact voltage	
Mechanical service life	
General data	
Ambient temperature (operational)	
Storage temperature	
Approvals	
Insulation coordination (EN50178)	
Rated input insulation voltage	
Rated output insulation voltage	
Overvoltage category input/output	
Overvoltage category output/output	
Pollution severity level	
Pulse voltage test (1,2/50µs)	
Insulation test voltage	
Clearance input/output	
Dimensions	
Clamping range, min./max.	
Clamping range, min./max.	
Rail	
Width / Height	
Note	

Ordering data

Screw connection without switch
PUSH IN connection without switch

Note

Accessories

Note

RSM-16 24V+ 1CO

RCL relays (arranged in 1 rows) with 1 CO contacts

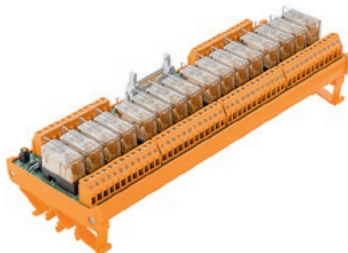

Plug-in connector in acc. with IEC60603-13 / DIN41651, LL 5.08 mm	
20-pole plug	
RCL	
green	
yellow	
No	
No	
CE	
24 V DC ± 10%	
16.7 mA	
24 V DC ± 10%	
1 A	
CE	
AgNi 90/10	
250 V AC	
6 A	
0.1 A	
5 V	
30 x 10 ⁶ switching cycles	
CE	
-25...50 °C	
-40...60 °C	
CE, EAC	
Screw connection	
0.5 mm ² / 6 mm ²	
0.13 mm ² / 6 mm ²	
TS 35, TS 32	
259 mm / 87 mm	
PUSH IN connection	
0.12 mm ² / 2.5 mm ²	
0.12 mm ² / 2.5 mm ²	
TS 35, TS 32	
259 mm / 87 mm	

Type	Depth	Order No.
RSM-16 24V+ 1CO S	66 mm	1448280000
RSM-16 24V+ 1CO Z	66 mm	1448300000

Note

Note
Relay 8693260000 RCL314024 24 V DC 1CO

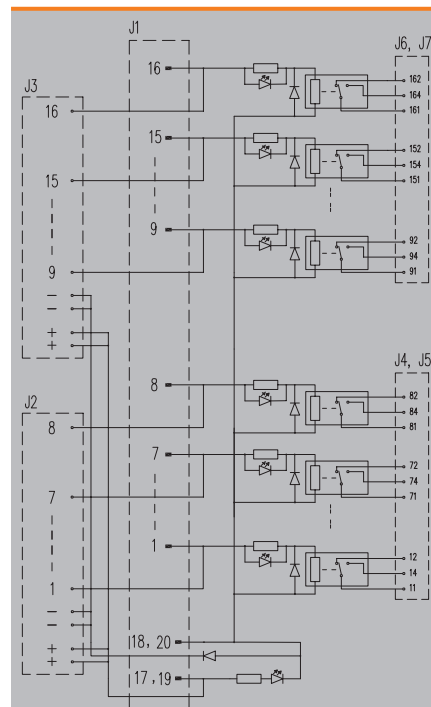

RSM – Interface
for 16 isolated digital output signals

Digital output relay interface for transmitting electrical signals between the PLC and the field via pre-wired cables of Weidmüller's universal system.

- Input/output reinforced insulation (basic between contacts)
- Positive switching

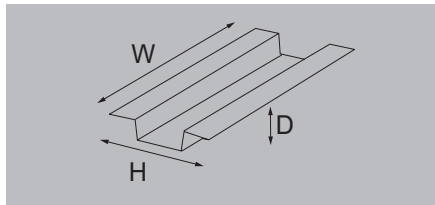

Technical data

Connection data and functionality	
Connection on control side	
Number of poles (control side)	
Relay type	
LED status display per relay	
LED status of the supply voltage	
Fuse per relay	
Power supply fuse	
Nominal input data	
Input voltage	
Input current	
Operating voltage (supply)	
Operating current (supply)	
Nominal output data	
Contact material	
Operating voltage	
Max. AC continuous current	
Minimum contact current	
Minimum contact voltage	
Mechanical service life	
General data	
Ambient temperature (operational)	
Storage temperature	
Approvals	
Insulation coordination (EN50178)	
Rated input insulation voltage	
Rated output insulation voltage	
Overvoltage category input/output	
Overvoltage category output/output	
Pollution severity level	
Pulse voltage test (1,2/50µs)	
Insulation test voltage	
Clearance input/output	
Dimensions	
Clamping range, min./max.	
Clamping range, min./max.	
Rail	
Width / Height	
Note	

Ordering data

	Screw connection with switch
	Tension clamp connection with switch

Note

Accessories

Note	Relay 8693260000 RCL314024 24 V DC 1CO
-------------	--

RSM-16 PLC 1CO

6 mm relay with 1 CO contact and switch



Plug-in connector in acc. with IEC60603-13 / DIN41651
20-pole plug
RCL
green
yellow
No
2.5 A
CE
24 V DC ± 10%
22 mA
24 V DC ± 10%
2 A
CE
AgNi 90/10
250 V AC
6 A
0.01 A
10 V
3 x 10 ⁷ switching cycles
CE
-25...50 °C
-40...60 °C
CE; EAC
< 50 V AC
250 V AC
III
II
2
6 kV
1.2 kVAC
≥ 5.5 mm
Tension-clamp connection
0.13 mm ² / 2.5 mm ²
0.13 mm ² / 2.5 mm ²
TS 35, TS 32
255 mm / 109 mm

Type	Depth	Order No.
RSM-16 PLC SW 1CO S	68 mm	1129120000
RSM-16 PLC SW 1CO Z	68 mm	1129130000

Note

Note	Relay 8693260000 RCL314024 24 V DC 1CO
-------------	--

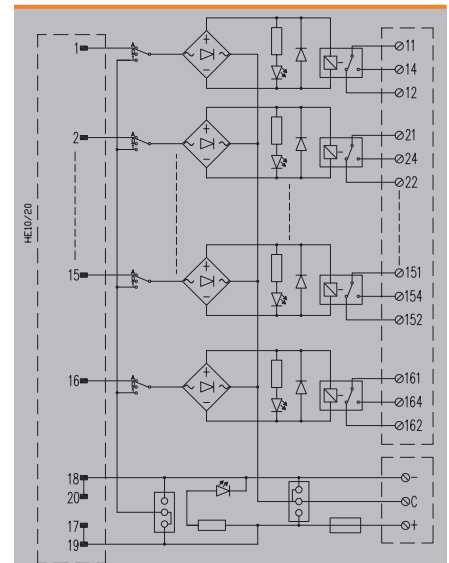

RSM – Isolated interfaces for digital output signals
**RSM – Interface
for 16 isolated digital output signals**

Digital output relay interface for transmitting electrical signals between the PLC and the field via pre-wired cables of Weidmüller's universal system.

- Input/output reinforced insulation (basic between contacts)
- Positive switching

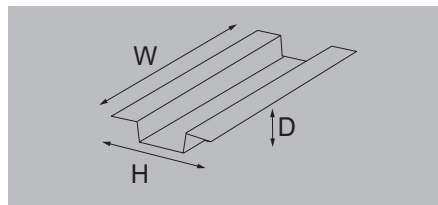
Technical data
Connection data and functionality

Connection on control side
Number of poles (control side)
Relay type
LED status display per relay
LED status of the supply voltage
Fuse per relay
Power supply fuse

Nominal input data

Input voltage
Input current
Operating voltage (supply)
Operating current (supply)

Nominal output data

Contact material
Operating voltage
Max. AC continuous current
Minimum contact current
Minimum contact voltage
Mechanical service life

General data

Ambient temperature (operational)
Storage temperature
Approvals

Insulation coordination (EN50178)

Rated input insulation voltage
Rated output insulation voltage
Overvoltage category input/output
Overvoltage category output/output
Pollution severity level
Pulse voltage test (1,2/50µs)
Insulation test voltage
Clearance input/output

Dimensions

Clamping range, min./max.
Clamping range, min./max.
Rail
Width / Height

Note
Ordering data

Screw connection without switch
Tension clamp connection without switch

Note
Accessories
Note
RSM-16 C 1CO

RCL relays (arranged in 2 rows) with 1 CO contact

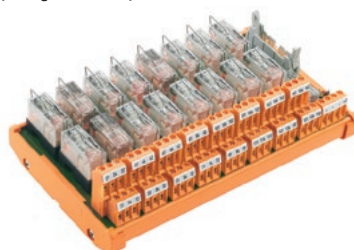

Plug-in connector in acc. with IEC60603-13 / DIN41651

20-pole plug

RCL

green

yellow

No

3.15 A

24 V DC ± 10%

20 mA

24 V DC ± 10%

2 A

AgNi 90/10

250 V AC

5 A

0.01 A

10 V

3 x 10⁷ switching cycles

-25...40 °C

-40...60 °C

CE, EAC

< 50 V AC

< 250 V AC

III

II

2

6 kV

1.2 kVAC

≥ 5.5 mm

Screw connection

0.13 mm² / 6 mm²

0.13 mm² / 6 mm²

TS 35, TS 32

185 mm / 109 mm

Type	Depth	Order No.
RSM-16 C 1CO S	68 mm	9445100000
RSM-16 C 1CO Z	68 mm	9447100000

Relay 8693260000 RCL314024 24 V DC 1CO

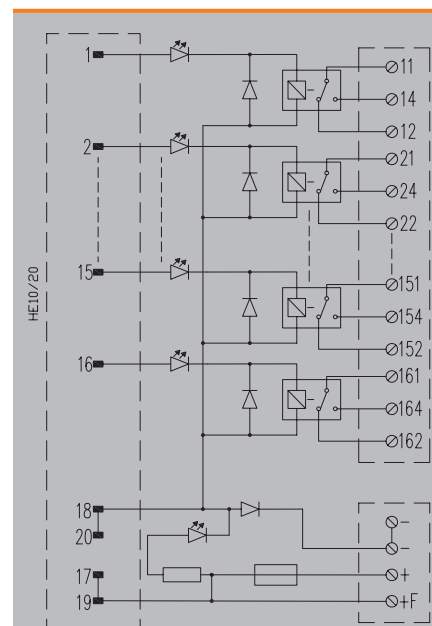

RSM – Interface
for 16 isolated digital output signals

Digital output relay interface for transmitting electrical signals between the PLC and the field via pre-wired cables of Weidmüller's universal system.

- Input/output reinforced insulation (basic between contacts)
- Positive switching

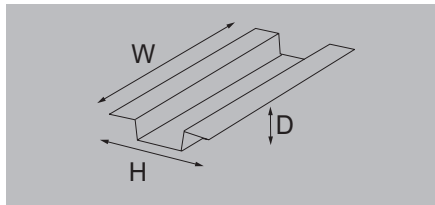

RSM-16 24V+ 2CO

RCL relays (arranged in 1 row) with 2 CO contacts

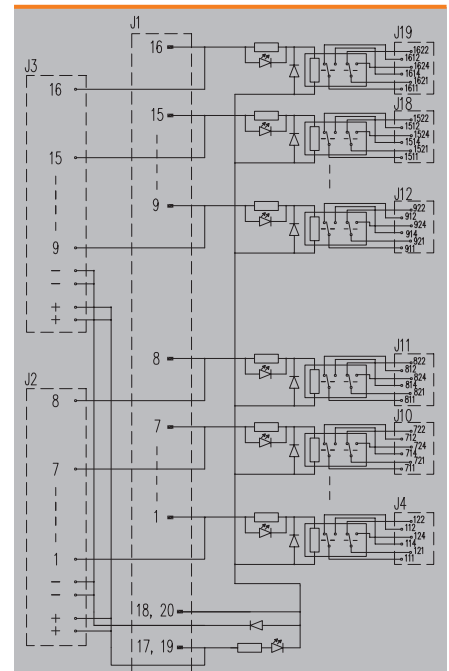

Technical data

Connection data and functionality	
Connection on control side	
Number of poles (control side)	
Relay type	
LED status display per relay	
LED status of the supply voltage	
Fuse per relay	
Power supply fuse	
Nominal input data	
Input voltage	
Input current	
Operating voltage (supply)	
Operating current (supply)	
Nominal output data	
Contact material	
Operating voltage	
Max. AC continuous current	
Minimum contact current	
Minimum contact voltage	
Mechanical service life	
General data	
Ambient temperature (operational)	
Storage temperature	
Approvals	
Insulation coordination (EN50178)	
Rated input insulation voltage	
Rated output insulation voltage	
Overvoltage category input/output	
Overvoltage category output/output	
Pollution severity level	
Pulse voltage test (1,2/50µs)	
Insulation test voltage	
Clearance input/output	
Dimensions	
Clamping range, min./max.	
Clamping range, min./max.	
Rail	
Width / Height	
Note	

Plug-in connector in acc. with IEC60603-13 / DIN41651, LL 5.08 mm	
20-pole plug	
RCL	
green	
yellow	
No	
No	
CE	
24 V DC ± 10%	
16.7 mA	
24 V DC ± 10%	
1 A	
CE	
AgNi 90/10	
250 V AC	
5 A	
0.1 A	
5 V	
30 x 10 ⁶ switching cycles	
CE	
-25...50 °C	
-40...60 °C	
CE, EAC	
Screw connection	
0.5 mm ² / 6 mm ²	
0.13 mm ² / 6 mm ²	
TS 35, TS 32	
290 mm / 109 mm	

Ordering data

Screw connection without switch	
Tension clamp connection without switch	

Type	Depth	Order No.
RSM-16 24V+ 2CO S	71 mm	1449210000
RSM-16 24V+ 2CO Z	66 mm	1449230000

Note

Accessories

Note	Relay 4058570000 RCL424024 24 V DC 2 CO
------	---

RSM – Interface
for 16 isolated digital output signals

Digital output relay interface for transmitting electrical signals between the PLC and the field via pre-wired cables of Weidmüller's universal system.

- Input/output reinforced insulation (basic between contacts)
- Positive switching

RSM-16 FUS 1C0

RCL relays, 1 CO contact with fuse relay contact

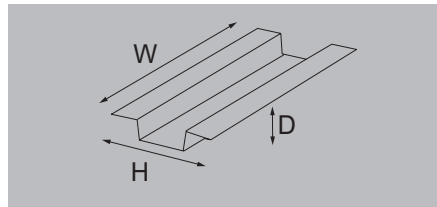
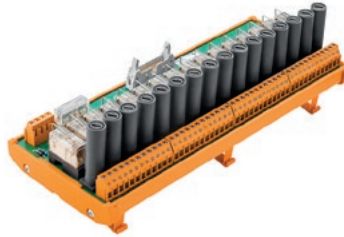

Technical data

Connection data and functionality	
Connection on control side	
Number of poles (control side)	
Relay type	
LED status display per relay	
LED status of the supply voltage	
Fuse per relay	
Power supply fuse	
Nominal input data	
Input voltage	
Input current	
Operating voltage (supply)	
Operating current (supply)	
Nominal output data	
Contact material	
Operating voltage	
Max. AC continuous current	
Minimum contact current	
Minimum contact voltage	
Mechanical service life	
General data	
Ambient temperature (operational)	
Storage temperature	
Approvals	
Insulation coordination (EN50178)	
Rated input insulation voltage	
Rated output insulation voltage	
Overvoltage category input/output	
Overvoltage category output/output	
Pollution severity level	
Pulse voltage test (1,2/50µs)	
Insulation test voltage	
Clearance input/output	
Dimensions	
Clamping range, min./max.	
Clamping range, min./max.	
Rail	
Width / Height	
Note	

Plug-in connector in acc. with IEC60603-13 / DIN41651
20-pole plug
RCL
green
yellow
5 A
3.15 A
CE
24 V DC ± 10%
20 mA
24 V DC ± 10%
2 A
CE
AgNi 90/10
250 V AC
5 A
0.01 A
10 V
3 x 10 ⁷ switching cycles
CE
-25...40 °C
-40...60 °C
CE, EAC
< 50 V AC
< 250 V AC
III
II
2
6 kV
1.2 kVAC
≥ 5.5 mm
Screw connection
0.13 mm ² / 6 mm ²
0.13 mm ² / 6 mm ²
TS 35, TS 32
261 mm / 109 mm

Ordering data

Screw connection without switch
Tension clamp connection without switch

Type	Depth	Order No.
RSM-16 FUS 1C0 S	75 mm	9445120000
RSM-16 FUS 1C0 Z	75 mm	9447120000

Note

Accessories

Note

Relay 8693260000 RCL314024 24 V DC 1C0
--



RSM – Interface
for 16 isolated digital output signals

Digital output relay interface for transmitting electrical signals between the PLC and the field via pre-wired cables of Weidmüller's universal system.

- Input/output reinforced insulation (basic between contacts)
- Positive switching

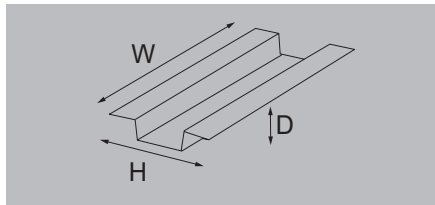

RSM-16 FOR 1CO

RCL relays, 1 CO contact and switch

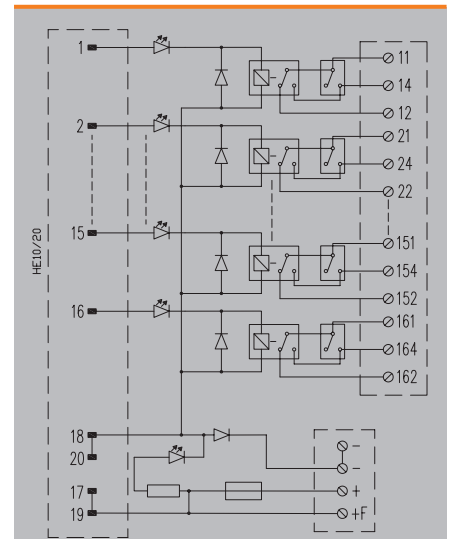

Technical data

Connection data and functionality	
Connection on control side	
Number of poles (control side)	
Relay type	
LED status display per relay	
LED status of the supply voltage	
Fuse per relay	
Power supply fuse	
Nominal input data	
Input voltage	
Input current	
Operating voltage (supply)	
Operating current (supply)	
Nominal output data	
Contact material	
Operating voltage	
Max. AC continuous current	
Minimum contact current	
Minimum contact voltage	
Mechanical service life	
General data	
Ambient temperature (operational)	
Storage temperature	
Approvals	
Insulation coordination (EN50178)	
Rated input insulation voltage	
Rated output insulation voltage	
Overvoltage category input/output	
Overvoltage category output/output	
Pollution severity level	
Pulse voltage test (1,2/50µs)	
Insulation test voltage	
Clearance input/output	
Dimensions	
Clamping range, min./max.	
Clamping range, min./max.	
Rail	
Width / Height	
Note	

Plug-in connector in acc. with IEC60603-13 / DIN41651	
20-pole plug	
RCL	
green	
yellow	
No	
3.15 A	
CE	
24 V DC ± 10%	
17 mA	
24 V DC ± 10%	
2 A	
CE	
AgNi 90/10	
250 V AC	
2 A	
0.01 A	
10 V	
3 x 10 ⁷ switching cycles	
CE	
-25...40 °C	
-40...60 °C	
CE, EAC	
< 50 V AC	
< 250 V AC	
III	
II	
2	
6 kV	
1.2 kVAC	
≥ 5.5 mm	
Screw connection	
0.13 mm ² / 6 mm ²	
0.13 mm ² / 6 mm ²	
TS 35, TS 32	
263 mm / 109 mm	

Ordering data

Screw connection without switch
Tension clamp connection without switch

Note

Accessories

Note

Type	Depth	Order No.
RSM-16 FOR 1CO S	75 mm	9445140000

Relay 8693260000 RCL314024 24 V DC 1CO
--

RSM – Isolated interfaces for digital output signals

RSM – Interface for 16 isolated digital output signals

Digital output relay interface for transmitting electrical signals between the PLC and the field via pre-wired cables of Weidmüller's universal system.

- Input/output reinforced insulation (basic between contacts)
- Positive switching

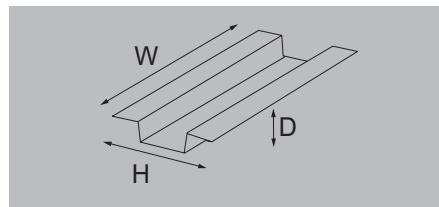

Technical data

Connection data and functionality	
Connection on control side	
Number of poles (control side)	
Relay type	
LED status display per relay	
LED status of the supply voltage	
Fuse per relay	
Power supply fuse	
Nominal input data	
Input voltage	
Input current	
Operating voltage (supply)	
Operating current (supply)	
Nominal output data	
Contact material	
Operating voltage	
Max. AC continuous current	
Minimum contact current	
Minimum contact voltage	
Mechanical service life	
General data	
Ambient temperature (operational)	
Storage temperature	
Approvals	
Insulation coordination (EN50178)	
Rated input insulation voltage	
Rated output insulation voltage	
Overvoltage category input/output	
Overvoltage category output/output	
Pollution severity level	
Pulse voltage test (1,2/50µs)	
Insulation test voltage	
Clearance input/output	
Dimensions	
Clamping range, min./max.	
Clamping range, min./max.	
Rail	
Width / Height	
Note	

RSM-16 24 V DC 1NO + C

RCL relays (arranged in 1 row) with 1 NO contact



LL 5.08 mm, Plug-in connector in acc. with IEC60603-13 / DIN41651, 20 p	
20-pole plug	
RCL	
green	
yellow	
No	
No	
CE	
24 V DC ± 10%	
16.7 mA	
24 V DC ± 10%	
1 A	
CE	
AgNi 90/10	
250 V AC	
6 A	
0.1 A	
5 V	
3 x 10 ⁷ switching cycles	
CE	
-25...50 °C	
-40...60 °C	
CE: EAC	
Screw connection	
0.5 mm ² / 6 mm ²	
0.13 mm ² / 6 mm ²	
TS 35, TS 32	
250 mm / 87 mm	
PUSH IN connection	
0.12 mm ² / 2.5 mm ²	
0.12 mm ² / 2.5 mm ²	
TS 35, TS 32	
250 mm / 87 mm	

Ordering data

Screw connection without switch
PUSH IN connection without switch

Type	Depth	Order No.
RSM-16 24VDC 1NO + C S	62 mm	1448450000
RSM-16 24VDC 1NO + C Z	62 mm	1448470000

Note

Accessories

Note

Relay 8693260000 RCL314024 24 V DC 1CO
--

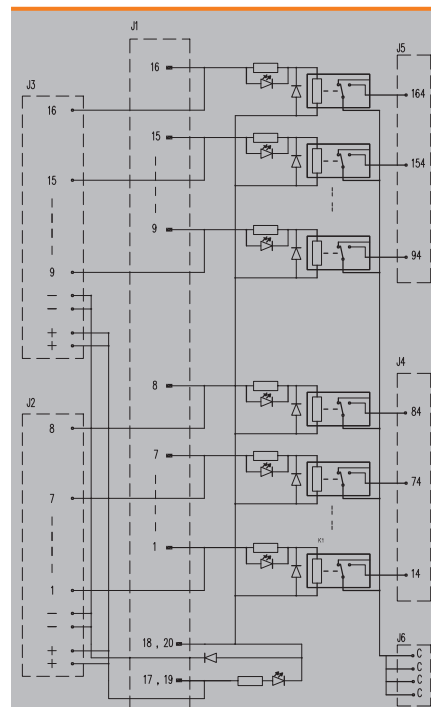

RSM – Interface
for 16 isolated digital output signals

Digital output relay interface for transmitting electrical signals between the PLC and the field via pre-wired cables of Weidmüller's universal system.

- Input/output reinforced insulation (basic between contacts)
- Positive switching

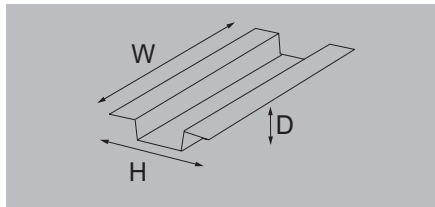

Technical data

Connection data and functionality	
Connection on control side	
Number of poles (control side)	
Relay type	
LED status display per relay	
LED status of the supply voltage	
Fuse per relay	
Power supply fuse	
Nominal input data	
Input voltage	
Input current	
Operating voltage (supply)	
Operating current (supply)	
Nominal output data	
Contact material	
Operating voltage	
Max. AC continuous current	
Minimum contact current	
Minimum contact voltage	
Mechanical service life	
General data	
Ambient temperature (operational)	
Storage temperature	
Approvals	
Insulation coordination (EN50178)	
Rated input insulation voltage	
Rated output insulation voltage	
Overvoltage category input/output	
Overvoltage category output/output	
Pollution severity level	
Pulse voltage test (1,2/50µs)	
Insulation test voltage	
Clearance input/output	
Dimensions	
Clamping range, min./max.	
Clamping range, min./max.	
Rail	
Width / Height	
Note	

Ordering data

	Screw connection without switch
	PUSH IN connection without switch

Note

Accessories

Note	Relay 8693260000 RCL314024 24 V DC 1C0; SSR 1132290000 24 V DC/max. 240 V AC 1 A; SSR 1132310000 24 V DC/0-24 V DC 3.5 A
-------------	--

RSM-16 24 V+ BASE

RCL relays (arranged in 1 row) without relays or SSR's

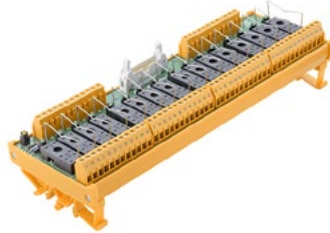

LL 5.08 mm, Plug-in connector in acc. with IEC60603-13 / DIN41651, 20 p	
20-pole plug	
RCL	
green	
yellow	
No	
No	
CE	
24 V DC ± 10%	
24 V DC ± 10%	
1 A	
CE	
AgNi 90/10	
250 V AC	
6 A	
0.1 A	
5 V	
3 x 10 ⁷ switching cycles	
CE	
-25...50 °C	
-40...60 °C	
CE; EAC	
< 50 V AC	
250 V AC	
III	
II	
2	
6 kV	
1.2 kVAC	
≥ 5,5 mm	
Screw connection	PUSH IN connection
0.5 mm ² / 6 mm ²	0.12 mm ² / 2.5 mm ²
0.13 mm ² / 6 mm ²	0.12 mm ² / 2.5 mm ²
TS 35, TS 32	TS 35, TS 32
259 mm / 87 mm	259 mm / 87 mm

Type	Depth	Order No.
RSM-16 24V+ BASE S	51 mm	1448480000
RSM-16 24V+ BASE Z	51 mm	1448490000

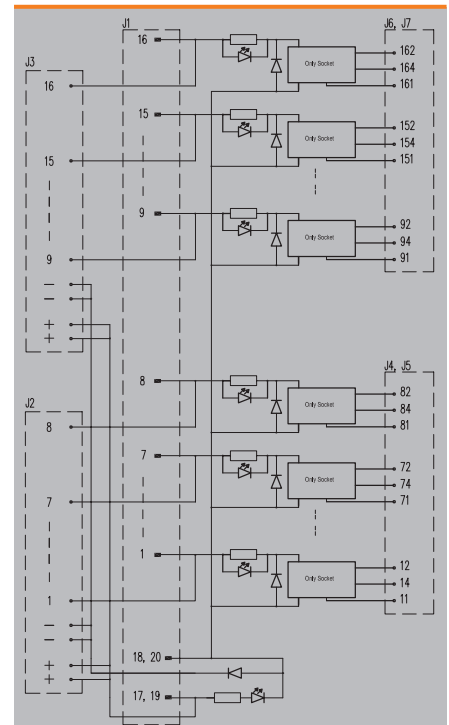

RSM – Interface
for 16 isolated digital output signals

Digital output relay interface for transmitting electrical signals between the PLC and the field via pre-wired cables of Weidmüller's universal system.

- Input/output reinforced insulation (basic between contacts)
- Negative switching

RSMS-16H 24V- 1CO

6 mm relay with 1 CO contact and without switch

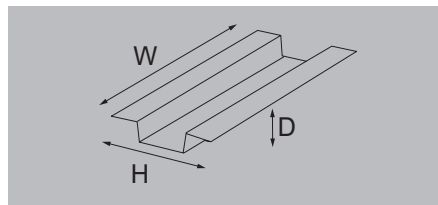

Technical data

Connection data and functionality	
Connection on control side	
Number of poles (control side)	
Relay type	
LED status display per relay	
LED status of the supply voltage	
Fuse per relay	
Power supply fuse	
Nominal input data	
Input voltage	
Input current	
Operating voltage (supply)	
Operating current (supply)	
Nominal output data	
Contact material	
Operating voltage	
Max. AC continuous current	
Minimum contact current	
Minimum contact voltage	
Mechanical service life	
General data	
Ambient temperature (operational)	
Storage temperature	
Approvals	
Insulation coordination (EN50178)	
Rated input insulation voltage	
Rated output insulation voltage	
Overvoltage category input/output	
Overvoltage category output/output	
Pollution severity level	
Pulse voltage test (1,2/50µs)	
Insulation test voltage	
Clearance input/output	
Dimensions	
Clamping range, min./max.	
Clamping range, min./max.	
Rail	
Width / Height	
Note	

Plug-in connector in acc. with IEC60603-13 / DIN41651, LL 5.08 mm	
20-pole plug	
RSS	
green	
yellow	
No	
No	
CE	
24 V DC ± 10%	
7.1 mA	
24 V DC ± 10%	
1 A	
CE	
AgNi 90/10	
250 V AC	
4.5 A	
100 mA	
5 V	
5 x 10 ⁶ switching cycles	
CE	
-25...50 °C	
-40...60 °C	
CE, EAC	
Screw connection	
0.13 mm ² / 6 mm ²	0.13 mm ² / 2.5 mm ²
0.13 mm ² / 6 mm ²	0.13 mm ² / 2.5 mm ²
Tension-clamp connection	
TS 35, TS 32	TS 35, TS 32
112 mm / 109 mm	112 mm / 109 mm

Ordering data

Screw connection without switch
Tension clamp connection without switch

Note

Accessories

Relay 4060120000 RSS 24 V DC 1 CO

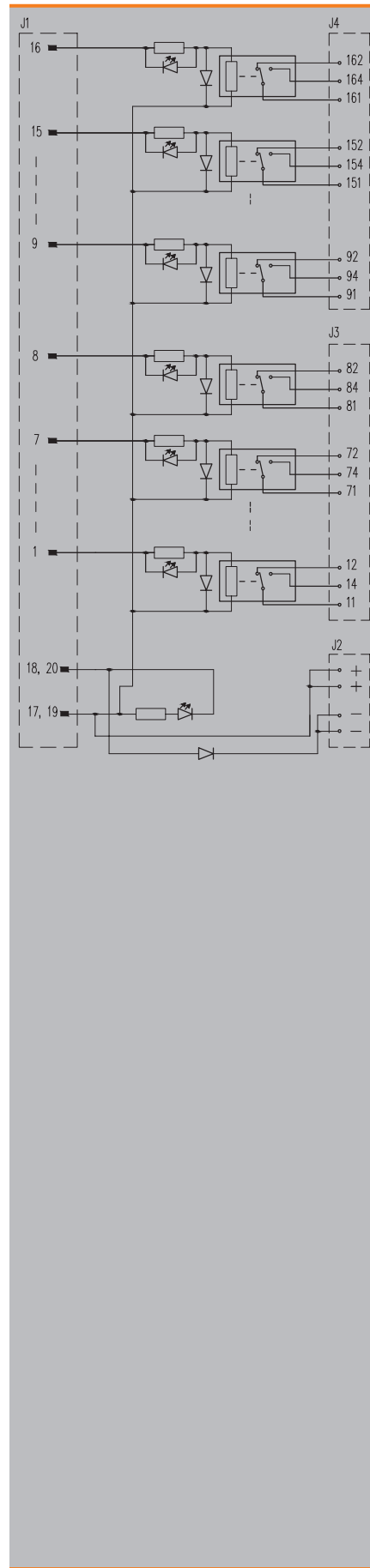

RSM – Interface
for 16 isolated digital output signals

Digital output relay interface for transmitting electrical signals between the PLC and the field via pre-wired cables of Weidmüller's universal system.

- Input/output reinforced insulation (basic between contacts)
- Negative switching

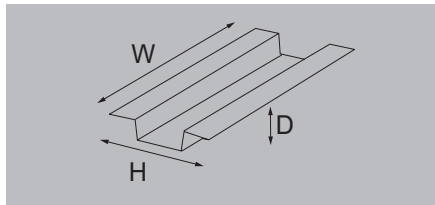

Technical data

Connection data and functionality	
Connection on control side	
Number of poles (control side)	
Relay type	
LED status display per relay	
LED status of the supply voltage	
Fuse per relay	
Power supply fuse	
Nominal input data	
Input voltage	
Input current	
Operating voltage (supply)	
Operating current (supply)	
Nominal output data	
Contact material	
Operating voltage	
Max. AC continuous current	
Minimum contact current	
Minimum contact voltage	
Mechanical service life	
General data	
Ambient temperature (operational)	
Storage temperature	
Approvals	
Insulation coordination (EN50178)	
Rated input insulation voltage	
Rated output insulation voltage	
Overvoltage category input/output	
Overvoltage category output/output	
Pollution severity level	
Pulse voltage test (1,2/50µs)	
Insulation test voltage	
Clearance input/output	
Dimensions	
Clamping range, min./max.	
Clamping range, min./max.	
Rail	
Width / Height	
Note	

Ordering data

	Screw connection without switch
	PUSH IN connection without switch

Note

Accessories

Note	Relay 8693260000 RCL314024 24 V DC 1C0
-------------	--

RSM-16 24V- 1C0

RCL relays (arranged in 1 rows) with 2 CO contacts

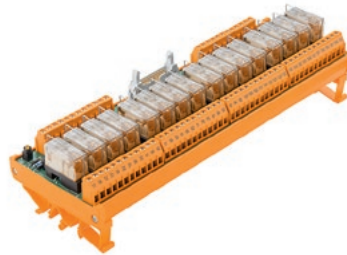

Plug-in connector in acc. with IEC60603-13 / DIN41651, LL 5.08 mm			
20-pole plug			
RCL			
green			
yellow			
No			
No			
CE			
24 V DC ± 10%			
16.7 mA			
24 V DC ± 10%			
1 A			
CE			
AgNi 90/10			
250 V AC			
6 A			
0.1 A			
5 V			
30 x 10 ⁶ switching cycles			
CE			
-25...50 °C			
-40...60 °C			
CE, EAC			
< 50 V AC			
250 V AC			
III			
II			
2			
6 kV			
1.2 kVAC			
≥ 5.5 mm			
Screw connection		PUSH IN connection	
0.5 mm ² / 6 mm ²		0.12 mm ² / 2.5 mm ²	
0.13 mm ² / 6 mm ²		0.12 mm ² / 2.5 mm ²	
TS 35, TS 32		TS 35, TS 32	
259 mm / 87 mm		259 mm / 87 mm	

Type	Depth	Order No.
RSM-16 24V- 1C0 S	66 mm	1448290000
RSM-16 24V- 1C0 Z	66 mm	1448310000

Note

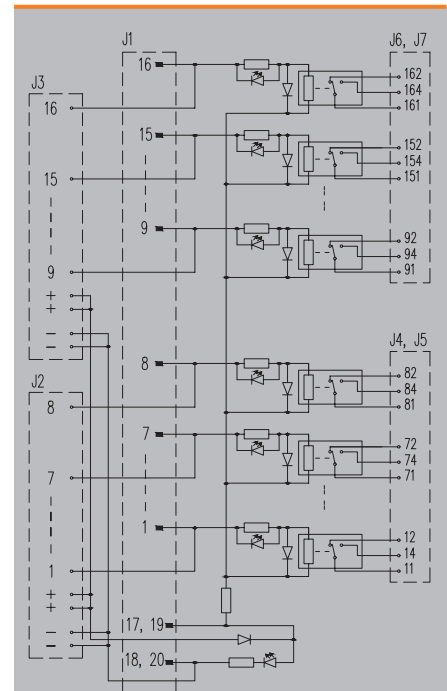

RSM – Isolated interfaces for digital output signals

RSM – Interface for 16 isolated digital output signals

Digital output relay interface for transmitting electrical signals between the PLC and the field via pre-wired cables of Weidmüller's universal system.

- Input/output reinforced insulation (basic between contacts)
- Negative switching

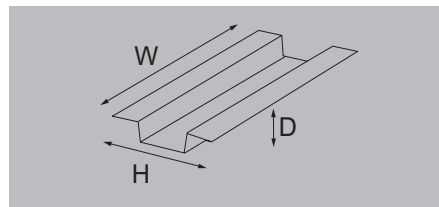

Technical data

Connection data and functionality	
Connection on control side	
Number of poles (control side)	
Relay type	
LED status display per relay	
LED status of the supply voltage	
Fuse per relay	
Power supply fuse	
Nominal input data	
Input voltage	
Input current	
Operating voltage (supply)	
Operating current (supply)	
Nominal output data	
Contact material	
Operating voltage	
Max. AC continuous current	
Minimum contact current	
Minimum contact voltage	
Mechanical service life	
General data	
Ambient temperature (operational)	
Storage temperature	
Approvals	
Insulation coordination (EN50178)	
Rated input insulation voltage	
Rated output insulation voltage	
Overvoltage category input/output	
Overvoltage category output/output	
Pollution severity level	
Pulse voltage test (1,2/50µs)	
Insulation test voltage	
Clearance input/output	
Dimensions	
Clamping range, min./max.	
Clamping range, min./max.	
Rail	
Width / Height	
Note	

Ordering data

Screw connection without switch
Tension clamp connection without switch

Note

Accessories

Note

RSM-16 24V- 2CO

RCL relays (arranged in 1 row) with 2 CO contacts



Plug-in connector in acc. with IEC60603-13 / DIN41651, LL 5.08 mm	
20-pole plug	
RCL	
green	
yellow	
No	
No	
CE	
24 V DC ± 10%	
16.7 mA	
24 V DC ± 10%	
1 A	
CE	
AgNi 90/10	
250 V AC	
5 A	
0.1 A	
5 V	
30 x 10 ⁶ switching cycles	
CE	
-25...50 °C	
-40...60 °C	
CE: EAC	
Screw connection	
0.5 mm ² / 6 mm ²	0.13 mm ² / 2.5 mm ²
0.13 mm ² / 6 mm ²	0.13 mm ² / 2.5 mm ²
Tension-clamp connection	
TS 35, TS 32	TS 35, TS 32
290 mm / 109 mm	290 mm / 109 mm

Type	Depth	Order No.
RSM-16 24V- 2CO S	71 mm	1449220000
RSM-16 24V- 2CO Z	66 mm	1449250000

Note

Note
Relay 4058570000 RCL424024 24 V DC 2 CO

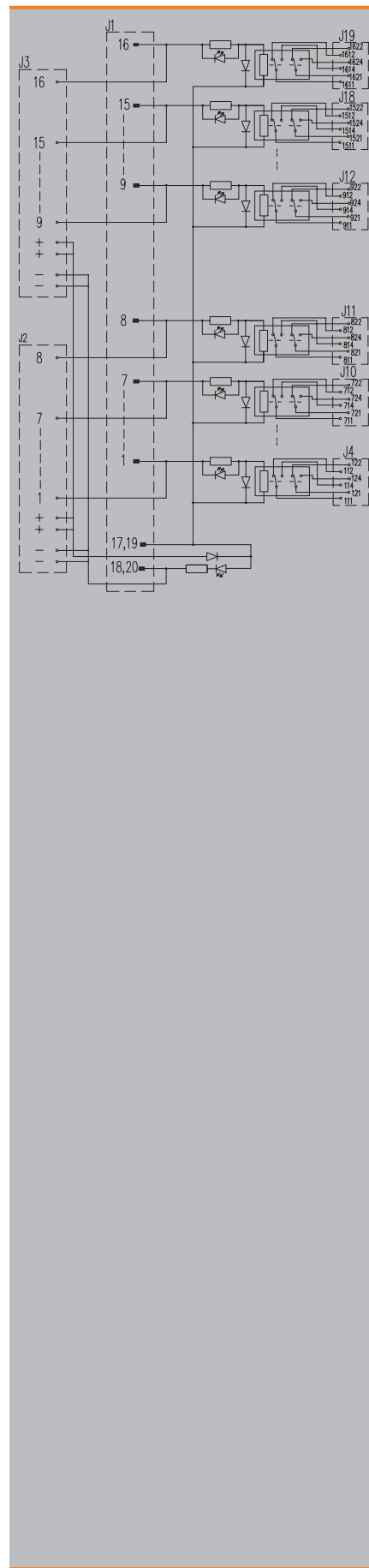

Dedicated solution for Honeywell C300

Dedicated solution for Honeywell C300	Honeywell C300 – General description	B.2
	Honeywell C300 – Selection guide	B.5
	Honeywell C300 – FTA C300 Input/output passive interface	B.6
	Honeywell C300 – FTA C300 Isolated interface per relay	B.11
	Honeywell C300 – Interconnection cables	B.13

Field Terminal Assembly (FTA)

New interfaces for the Honeywell Experion PKS C300 controller

Weidmüller's new interfaces and pre-assembled cables allow you to wire up I/O cards from Honeywell's C300 controller quickly and simply in the field.

The IOTAs (Input Output Terminal Assemblies) are designed using Weidmüller PCB connectors and terminals. This design gives you the flexibility to connect directly to the field cabling wire to wire or with a pre-assembled cable in combination with Weidmüller's FTAs. In comparison to traditional wire-to-wire cabling, the new Weidmüller FTAs and pre-cabling solution offer a highly efficient method of wiring between I/O modules and the field.

Concise wiring in the electrical cabinet is possible because multicore cables are used instead of individual wires. The cable harness can be delivered with double or single connectors and even with unterminated ends.

The housing provides easy handling as well as a safe, firm connection to the IOTA. It also allows you to use cables with large cross-sections.

Minimised wiring effort

Pluggable connectors and cables minimise the on site wiring effort.

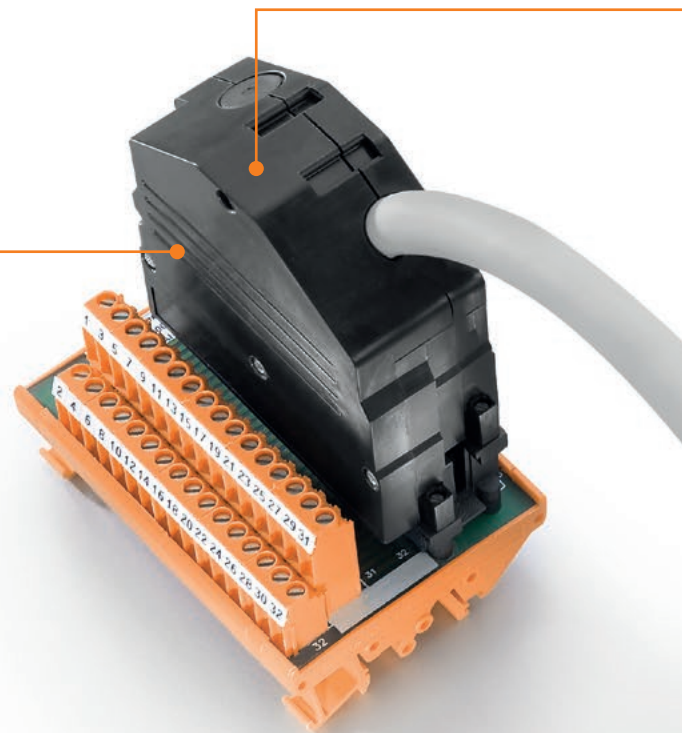

High current switching capability

The isolated digital output FTAs provide a high current switching capacity in a compact design.

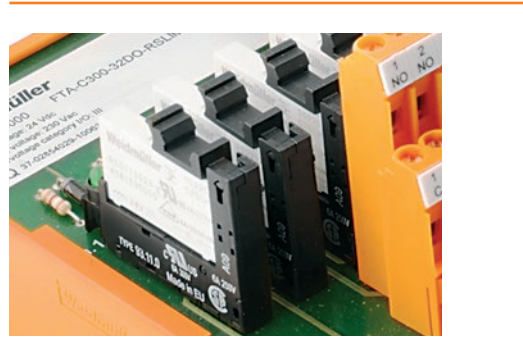

TERMSERIES interface adapter

Our pre-assembled plug-and-play solution with TERMSERIES interface adapter enables and minimised wiring effort. See Chapter E

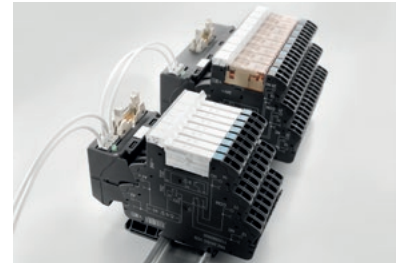

Clear identification

The IOTA and FTA are delivered with the same Weidmüller connectors and the same orientation.



Excellent flexibility

The pre-assembled cables can be manufactured with different cross sections and in different lengths of up to 50 m.



Wide range of Weidmüller interfaces (FTA)

Weidmüller interfaces offer a large variety of functions such as LED indicators, insulators, relays or fuses for all the C300 I/O cards.

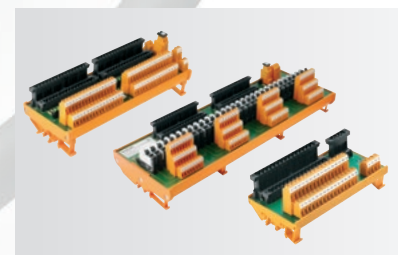

The following selection guides enable you to quickly and easily choose the correct products according to your application needs:

STEP 1: Choose the IOTA to be used.

STEP 2: In this column you can find the number and type of cable required to make the connection.

STEP 3: Choose the most suitable interface for the application.

Example: For CC-TDIL01 it's possible to select different options.

Solution 1: Pre-assembled cable C300-32B-320B (2 units)

Interface: 1221550000 (1 unit)

Solution 2: Pre-assembled cable C300-32B-320B (2 units)

Interface: 1222980000 (2 units)

Selection Guide for pre-assembled cables and FTA for Honeywell C300 IOTA's

STEP 1		STEP 2				STEP 3							Order No.	Type	Page
Honeywell IOTA		Pre-assembled cables				FTA (Weidmüller Interfaces)									
Kind of Card	Card	Cable Type	Units / IOTA	Channels	Connection	1 LED per channel	Disconnect + Test points	Fuse per channel	External power supply connector	Isolation	Units / IOTA				
32 DI	CC-TDIL01 CC-TDIL11 CC-TDIL51 CC-TDIL61	C300-32B-320B (Premium) or PAC-C300-3232 (Basic) page B.13	2	32					Yes		1	1221550000	FTA-C300-32DIOHV-S	B.6	
									Yes		1	1222940000	FTA-C300-32DHL-D-S	B.6	
									Yes	Relay Gold	1	1312040000	FTA-C300-32DI-24VDC-S	B.11	
									Yes		1	1221560000	FTA-C300-32DIOHV-Z	B.6	
									Yes		1	1222950000	FTA-C300-32DHL-D-Z	B.6	
									No		2	1222980000	FTA-C300-16AO-SH-S	B.9	
32 DI High voltage	CC-TDI110 CC-TDI120 CC-TDI220 CC-TDI230	C300-32B-320B (Premium) or PAC-C300-3232 (Basic) page B.13	2	32					Yes		1	1221550000	FTA-C300-32DIOHV-S	B.6	
									Yes		1	1221560000	FTA-C300-32DIOHV-Z	B.6	
									No		2	1222980000	FTA-C300-16AO-SH-S	B.9	
									No		2	1222990000	FTA-C300-16AO-SH-Z	B.9	
									No		2	1223010000	FTA-C300-16AO-SH-P	B.9	
									No		2	1223010000	FTA-C300-16AO-SH-P	B.9	
32 DO	CC-TDOB01 CC-TDOB11 CC-TDOD51 CC-TDOD61	C300-32B-320B (Premium) or PAC-C300-3232 (Basic) page B.13	2	32					Yes		1	1221550000	FTA-C300-32DIOHV-S	B.6	
									Yes		1	1221590000	FTA-C300-32DO-LD-S	B.7	
									Yes		1	1246910000	FTA-C300-32DO-FUSE-S	B.7	
									Yes	Relay 6A	1	1221570000	FTA-C300-32DO-SLIM-S	B.12	
									Yes		1	1221560000	FTA-C300-32DIOHV-Z	B.6	
									Yes		1	1221600000	FTA-C300-32DO-LD-Z	B.7	
									Yes	Relay 6A	1	1221580000	FTA-C300-32DO-SLIM-Z	B.12	
								No		2	1222980000	FTA-C300-16IO-SH-S	B.9		
								No		2	1223020000	FTA-C300-16AO-TEST-S	B.9		
								No		2	1222990000	FTA-C300-16AO-SH-Z	B.9		
								No		2	1223030000	FTA-C300-16AO-TEST-Z	B.9		
								No		2	2000020000	FTA-C300-16AO-TP-Z	B.10		
								No		2	1223010000	FTA-C300-16AO-SH-P	B.9		
				16 AO	CC-TAOX01 CC-TAOX11 CC-TAON01 CC-TAON11 CC-TAOX61	C300-32B-320B (Premium) or PAC-C300-3232 (Basic) page B.13	1	16					No		1
									No		1	1223020000	FTA-C300-16AO-TEST-S	B.9	
									No		1	1222990000	FTA-C300-16AO-SH-Z	B.9	
									No		1	1223030000	FTA-C300-16AO-TEST-Z	B.9	
									No		1	2000020000	FTA-C300-16AO-TP-Z	B.10	
									No		1	1223010000	FTA-C300-16AO-SH-P	B.9	
16 AI	CC-TAIX01 CC-TAIX11 CC-TAIX51 CC-TAIX61	C300-36B-324B (Premium) or PAC-C300-3636 (Basic) page B.14	1	16					No		1	1247120000	FTA-C300-16AI-SH-S	B.8	
									No		1	1247140000	FTA-C300-16AI-TEST-S	B.8	
									No		1	1247130000	FTA-C300-16AI-SH-Z	B.8	
									No		1	1247150000	FTA-C300-16AI-TEST-Z	B.8	
Universal IO	CC-TUIO01 CC-TUIO11 CC-TUIO31 CC-TUIO41	C300-32B-320B (Premium) or PAC-C300-3232 (Basic) page B.13	2	16					No		1	1415220000	FTA-C300-16DAI-SH-S	B.10	
									No		1	1415230000	FTA-C300-16DAI-SH-Z	B.10	

Note:
 = Screw connection
 = Tension clamp connection
 = Pluggable connection

Honeywell C300 - FTA C300 Input/output passive interface

Honeywell C300 - FTA C300

Input/output passive interface for digital cards

Passive interfaces (FTA) for connecting the Honeywell C300 digital IOTAs.

- Clearly labelled: same connector on the FTA and on the IOTA
- LED and fuse per channel (optional)
- Possibility of feeding the IOTA from the FTA (fuse protected)
- Screw or tension clamp connection

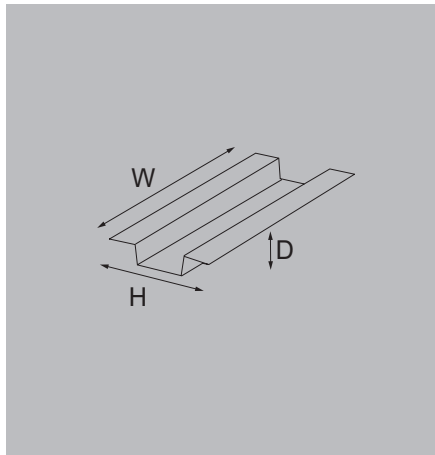

FTA-C300-32DI-LD

For: CC-TDIL01, CC-TDIL11

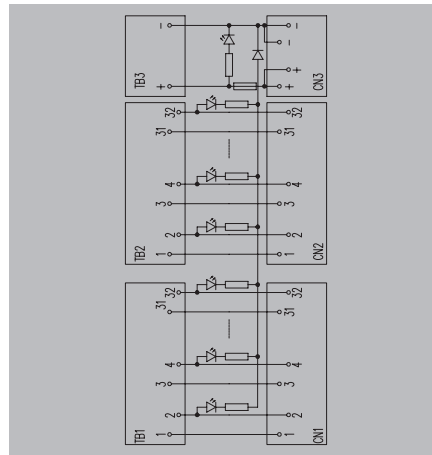
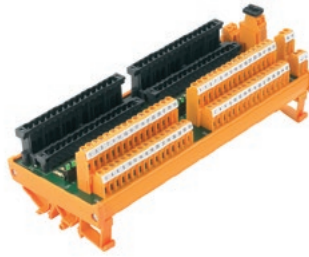

FTA-C300-32DIOHV

For: CC-TDIL01/11, CC-TDOB01/11, CC-TDI110/120/220/230

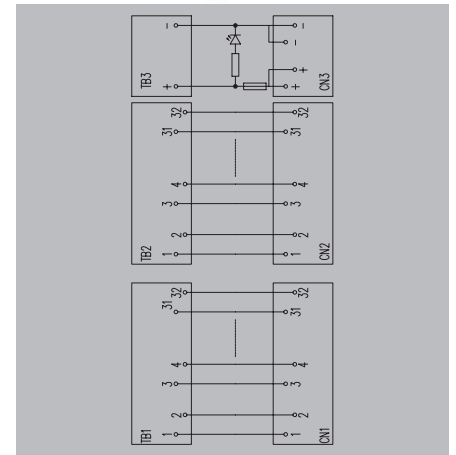

Technical data

Connection data and functionality	
Connection on control side	
LED status display per channel	
LED status of the supply voltage	
Fuse per channel	
Power supply fuse	
Type of test point	
Rated data	
Operating voltage	24 V DC ± 10%
Max. current per channel	1 A
Operating voltage (supply)	24 V DC ± 10%
General data	
Ambient temperature (operational)	-25...50 °C
Storage temperature	-40...60 °C
Approvals	CE, EAC
Insulation coordination (EN50178)	
Rated insulation voltage	< 50 V AC
Surge voltage category	III
Pollution severity level	2
Insulation test voltage	0.35 kVAC
Pulse voltage test (1,2/50µs)	0.8 kV
Dimensions	
Clamping range, min./max.	0.13 mm ² / 6 mm ²
Clamping range, min./max.	0.13 mm ² / 6 mm ²
Rail	TS 35, TS 32
Width / Height	216 mm / 87 mm
Note	

Ordering data

Type	Depth	Order No.
FTA-C300-32DI-LD-S	65 mm	1222940000
FTA-C300-32DI-LD-Z	65 mm	1222950000

Screw connection
 Tension clamp connection

Note

Accessories

Note

Connection data and functionality			
SLDV-THR 5.08			
green			
yellow			
No			
630 mA			
No			
Rated data			
Operating voltage	24 V DC ± 10%		
Max. current per channel	1 A		
Operating voltage (supply)	24 V DC ± 10%		
General data			
Ambient temperature (operational)	-25...50 °C		
Storage temperature	-40...60 °C		
Approvals	CE, EAC		
Insulation coordination (EN50178)			
Rated insulation voltage	< 50 V AC		
Surge voltage category	III		
Pollution severity level	2		
Insulation test voltage	0.35 kVAC		
Pulse voltage test (1,2/50µs)	0.8 kV		
Screw connection		Tension-clamp connection	
0.13 mm ² / 6 mm ²	0.13 mm ² / 6 mm ²	0.13 mm ² / 2.5 mm ²	0.13 mm ² / 2.5 mm ²
0.13 mm ² / 6 mm ²	0.13 mm ² / 6 mm ²	0.13 mm ² / 2.5 mm ²	0.13 mm ² / 2.5 mm ²
TS 35, TS 32	TS 35, TS 32	TS 35, TS 32	TS 35, TS 32
216 mm / 87 mm	216 mm / 87 mm	216 mm / 87 mm	216 mm / 87 mm
Note			

Type	Depth	Order No.
FTA-C300-32DIOHV-S	65 mm	1221550000
FTA-C300-32DIOHV-Z	65 mm	1221560000

Screw connection
 Tension-clamp connection

Note

Accessories

Note

Connection data and functionality			
SLDV-THR 5.08			
No			
yellow			
No			
630 mA			
No			
Rated data			
Operating voltage	≤ 250 V AC		
Max. current per channel	1 A		
Operating voltage (supply)	24 V DC ± 10%		
General data			
Ambient temperature (operational)	-25...50 °C		
Storage temperature	-40...60 °C		
Approvals	CE, EAC		
Insulation coordination (EN50178)			
Rated insulation voltage	< 250 V AC		
Surge voltage category	II		
Pollution severity level	2		
Insulation test voltage	1.2 kVAC		
Pulse voltage test (1,2/50µs)	2 kV		
Screw connection		Tension-clamp connection	
0.13 mm ² / 6 mm ²	0.13 mm ² / 6 mm ²	0.13 mm ² / 2.5 mm ²	0.13 mm ² / 2.5 mm ²
0.13 mm ² / 6 mm ²	0.13 mm ² / 6 mm ²	0.13 mm ² / 2.5 mm ²	0.13 mm ² / 2.5 mm ²
TS 35, TS 32	TS 35, TS 32	TS 35, TS 32	TS 35, TS 32
216 mm / 87 mm	216 mm / 87 mm	216 mm / 87 mm	216 mm / 87 mm
Note			

For digital outputs, replace the fuse as required (max. 5 A). TB3 can only be used for 24 VDC.

Type	Depth	Order No.
FTA-C300-32DIOHV-S	65 mm	1221550000
FTA-C300-32DIOHV-Z	65 mm	1221560000

Screw connection
 Tension-clamp connection

Note

Accessories

Note

FTA-C300-32D0-LD

For: CC-TD0B01, CC-TD0B11

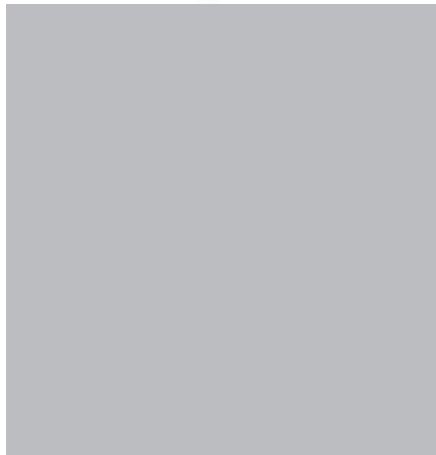
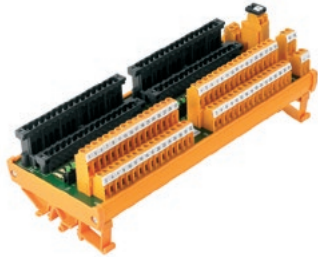

SLDV-THR 5.08
green
yellow
No
5 A
No
24 V DC ± 10%
1 A
24 V DC ± 10%
-25...50 °C
-40...60 °C
CE; EAC
< 50 V AC
III
2
0.35 kVAC
0.8 kV

Screw connection	Tension-clamp connection
0.13 mm ² / 6 mm ²	0.13 mm ² / 2.5 mm ²
0.13 mm ² / 6 mm ²	0.13 mm ² / 2.5 mm ²
TS 35, TS 32	TS 35, TS 32
216 mm / 87 mm	216 mm / 87 mm

Type	Depth	Order No.
FTA-C300-32D0-LD-S	65 mm	1221590000
FTA-C300-32D0-LD-Z	65 mm	1221600000

FTA-C300-32D0-FUSE

For: CC-TD0B01, CC-TD0B11

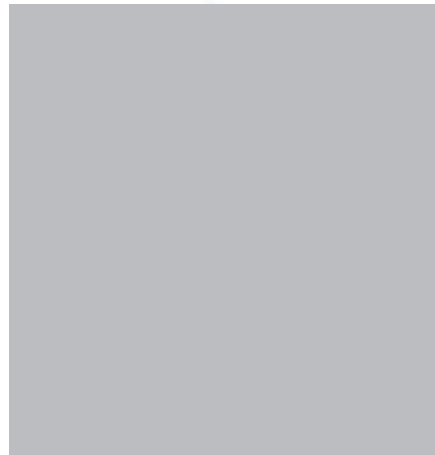
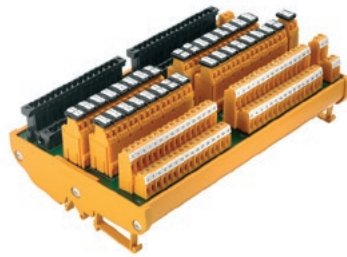

SLDV-THR 5.08
No
yellow
500 mA
5 A
No
24 V DC ± 10%
1 A
24 V DC ± 10%
-25...50 °C
-40...60 °C
CE; EAC
< 50 V AC
III
2
0.35 kVAC
0.8 kV

Screw connection	Tension-clamp connection
0.13 mm ² / 6 mm ²	0.13 mm ² / 2.5 mm ²
0.13 mm ² / 6 mm ²	0.13 mm ² / 2.5 mm ²
TS 35, TS 32	TS 35, TS 32
217 mm / 133 mm	217 mm / 133 mm

Type	Depth	Order No.
FTA-C300-32D0-FUSE-S	95 mm	1246910000
FTA-C300-32D0-FUSE-Z	95 mm	1246920000

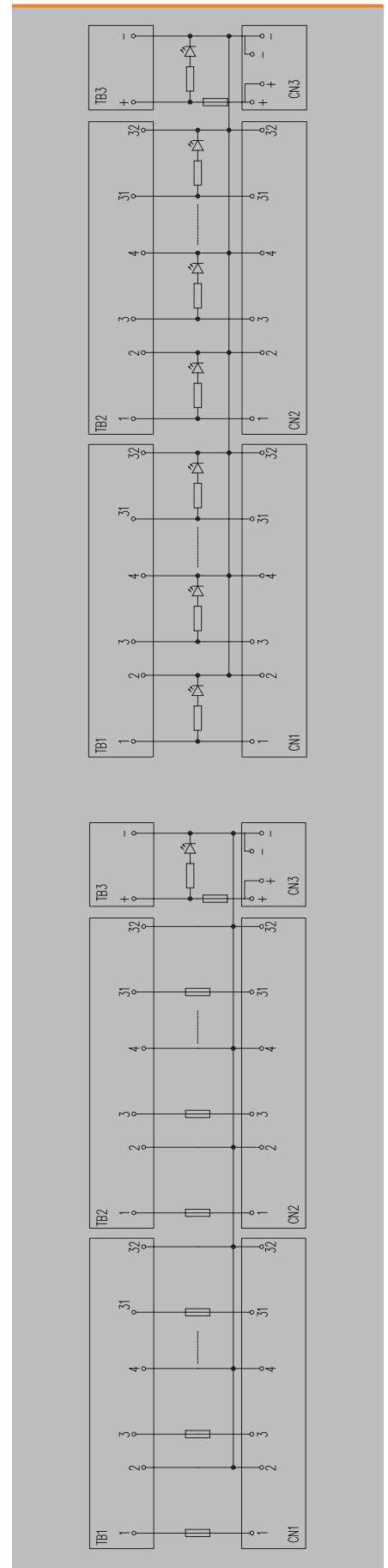

Honeywell C300 - FTA C300 Input/output passive interface

Honeywell C300 - FTA C300

Input/output passive interface for analogue and digital cards

Passive interfaces (FTA) for connecting the Honeywell C300 analogue IOTAs.

- Same connector and position on the FTA and on the IOTA
- 2 units can also be used for digital IOTAs
- Disconnecting plugs and test points (2 mm in diameter) for voltage and current measurements
- M4 connection for shielding

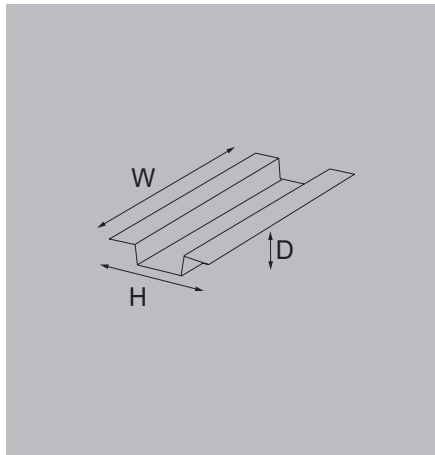

FTA-C300-16AI-SH

For: CC-TAIX01, CC-TAIX11, CC-TAIX51, CC-TAIX61

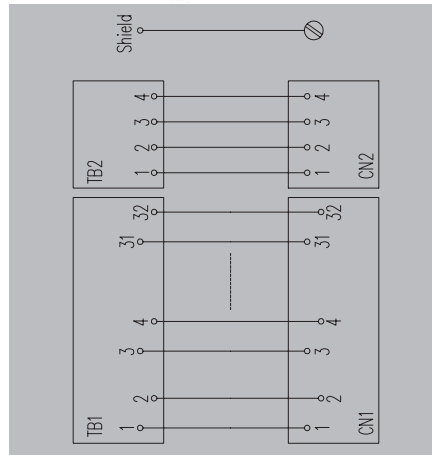
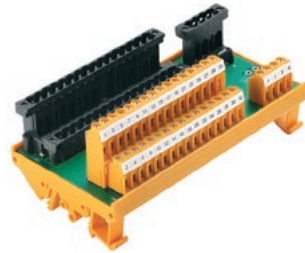

FTA-C300-16AI-TEST

For: CC-TAIX01, CC-TAIX11, CC-TAIX51, CC-TAIX61

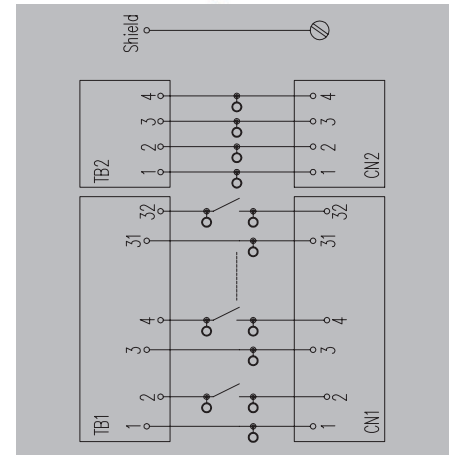

Technical data

Connection data and functionality	
Connection on control side	
LED status display per channel	
LED status of the supply voltage	
Fuse per channel	
Power supply fuse	
Type of test point	
Rated data	
Operating voltage	250 V AC / 350 V DC
Max. current per channel	1 A
Operating voltage (supply)	
General data	
Ambient temperature (operational)	-25...50 °C
Storage temperature	-40...60 °C
Approvals	CE, EAC
Insulation coordination (EN50178)	
Rated insulation voltage	< 250 V AC
Surge voltage category	II
Pollution severity level	2
Insulation test voltage	1.2 kVAC
Pulse voltage test (1,2/50µs)	2 kV
Dimensions	
Clamping range, min./max.	0.13 mm ² / 6 mm ²
Clamping range, min./max.	0.13 mm ² / 6 mm ²
Rail	TS 35, TS 32
Width / Height	135 mm / 70 mm
Note	

Ordering data

Type	Depth	Order No.
FTA-C300-16AI-SH-S	56 mm	1247120000
FTA-C300-16AI-SH-Z	56 mm	1247130000

Screw connection
 Tension clamp connection
 Plug-in connection

Note

Accessories

Note

SLDV-THR 5.08	
No	
No	
No	
No	
No	
Diameter: 2 mm	
250 V AC / 350 V DC	
1 A	
-25...50 °C	
-40...60 °C	
CE, EAC	
< 250 V AC	
II	
2	
1.2 kVAC	
2 kV	
Screw connection	Tension-clamp connection
0.13 mm ² / 6 mm ²	0.13 mm ² / 2.5 mm ²
0.13 mm ² / 6 mm ²	0.13 mm ² / 2.5 mm ²
TS 35, TS 32	TS 35, TS 32
135 mm / 70 mm	135 mm / 70 mm

SLDV-THR 5.08	
No	
No	
No	
No	
No	
Diameter: 2 mm	
24 V DC ± 10%	
1 A	
-25...50 °C	
-40...60 °C	
CE, EAC	
≤ 50 V DC	
III	
2	
0.35 kVAC	
0.8 kV	
Screw connection	Tension-clamp connection
0.13 mm ² / 6 mm ²	0.13 mm ² / 2.5 mm ²
0.13 mm ² / 6 mm ²	0.13 mm ² / 2.5 mm ²
TS 35, TS 32	TS 35, TS 32
141 mm / 133 mm	141 mm / 133 mm

Type	Depth	Order No.
FTA-C300-16AI-TEST-S	95 mm	1247140000
FTA-C300-16AI-TEST-Z	95 mm	1247150000

Note

Test plug PS 2.0 MC 0310000000

FTA-C300-16AO-SH

CC-TDI 110/120/220/230/L01/L11, TDOB01/11, TAOX 01/11; TUI01/11

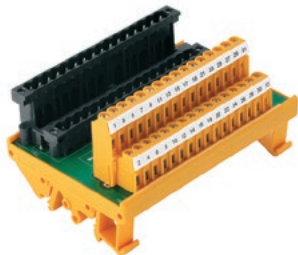

FTA-C300-16AO-TEST

For: CC-TDOB01, CC-TDOB11, CC-TAOX01, CC-TAOX11, CC-TAON01, CC-TAON11

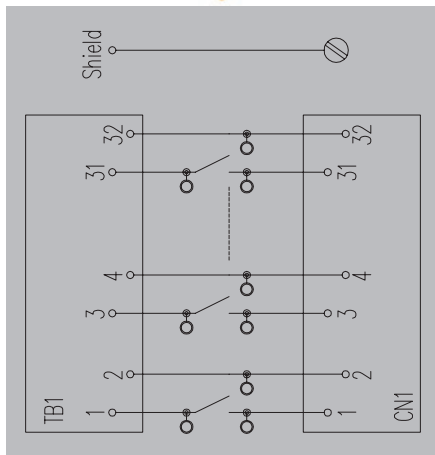
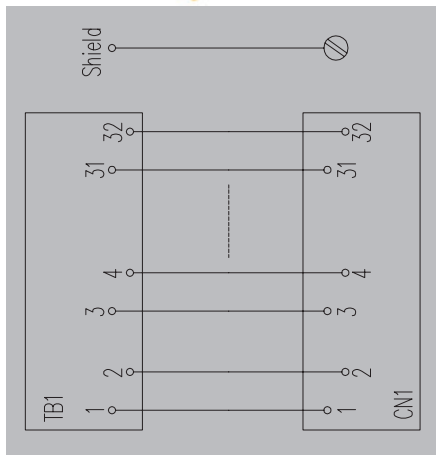
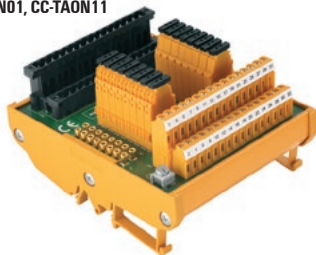

SLDV-THR 5.08
No
No
No
No
No
250 V AC / 350 V DC
1 A

-25...50 °C
-40...60 °C
CE; EAC
< 250 V AC
II
2
1.2 kVAC
2 kV

Screw connection	Tension-clamp connection
0.13 mm ² / 6 mm ²	0.13 mm ² / 2.5 mm ²
0.13 mm ² / 6 mm ²	0.13 mm ² / 2.5 mm ²
TS 35, TS 32	TS 35, TS 32
105 mm / 70 mm	105 mm / 70 mm

The power connector is not supplied in the interface for digital cards

Type	Depth	Order No.
FTA-C300-16AO-SH-S	56 mm	1222980000
FTA-C300-16AO-SH-Z	56 mm	1222990000
FTA-C300-16AO-SH-P	56 mm	1223010000

SLDV-THR 5.08
No
No
No
No
Diameter: 2 mm
24 V DC ± 10%
1 A

-25...50 °C
-40...60 °C
CE; EAC
≤ 50 V DC
III
2
0.35 kVAC
0.8 kV

Screw connection	Tension-clamp connection
0.13 mm ² / 6 mm ²	0.13 mm ² / 2.5 mm ²
0.13 mm ² / 6 mm ²	0.13 mm ² / 2.5 mm ²
TS 35, TS 32	TS 35, TS 32
110 mm / 133 mm	110 mm / 133 mm

The power connector is not supplied in the interface for digital cards

Type	Depth	Order No.
FTA-C300-16AO-TEST-S	95 mm	1223020000
FTA-C300-16AO-TEST-Z	95 mm	1223030000

Test plug PS 2.0 MC 0310000000

Honeywell C300 - FTA C300

Isolated input interface for digital cards

Passive interfaces (FTA) for connecting to Honeywell C300 analogue IOTAs.

- Clear identification: same connector and position on the FTA and on the IOTA
- Reinforced insulation at input/output (basic between contacts)
- Possibility of powering the IOTA from the FTA
- Screw or tension clamp connection

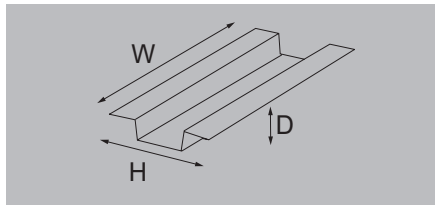

Technical data

Connection data and functionality

- Connection on control side
- Number of poles (control side)
- Relay type
- LED status display per relay
- LED status of the supply voltage
- Fuse per relay
- Power supply fuse

Nominal input data

- Input voltage
- Input current
- Operating voltage (supply)

Nominal output data

- Contact material
- Operating voltage
- Max. DC continuous current

General data

- Ambient temperature (operational)
- Storage temperature
- Approvals

Insulation coordination (EN50178)

- Rated input insulation voltage
- Rated output insulation voltage
- Overtoltage category input/output
- Overtoltage category output/output
- Pollution severity level
- Pulse voltage test (1,2/50µs)
- Insulation test voltage
- Clearance input/output

Dimensions

- Clamping range, min./max.
- Clamping range, min./max.
- Rail
- Width / Height

Note

Ordering data

Screw connection

Note

Accessories

Note

FTA-C300-32DI-24 V DC

For: CC-TDIL01, CC-TDIL11



Technical data

- SLDV-THR 5.08
- 64-pole
- RSS
- green
- yellow
- No
- 630 mA

- 24 V DC ± 10%
- 13 mA
- 24 V DC ± 10%

- AgNi gold flashed
- 24 V DC ± 10%
- 0.1 A

- 25...50 °C
- 40...60 °C
- CE, EAC

- < 50 V AC
- < 50 V AC
- III
- III
- 2
- 1.5 kV
- 0.35 kVAC
- ≥ 6 mm

Screw connection

- 0.13 mm² / 6 mm²
- 0.13 mm² / 6 mm²
- TS 35, TS 32
- 244 mm / 131 mm

Type	Depth	Order No.
FTA-C300-32DI-24VDC-S	65 mm	1312040000

Note

Note	Relay 4061590000 RSS 24 V DC 1 CD AU
-------------	--------------------------------------

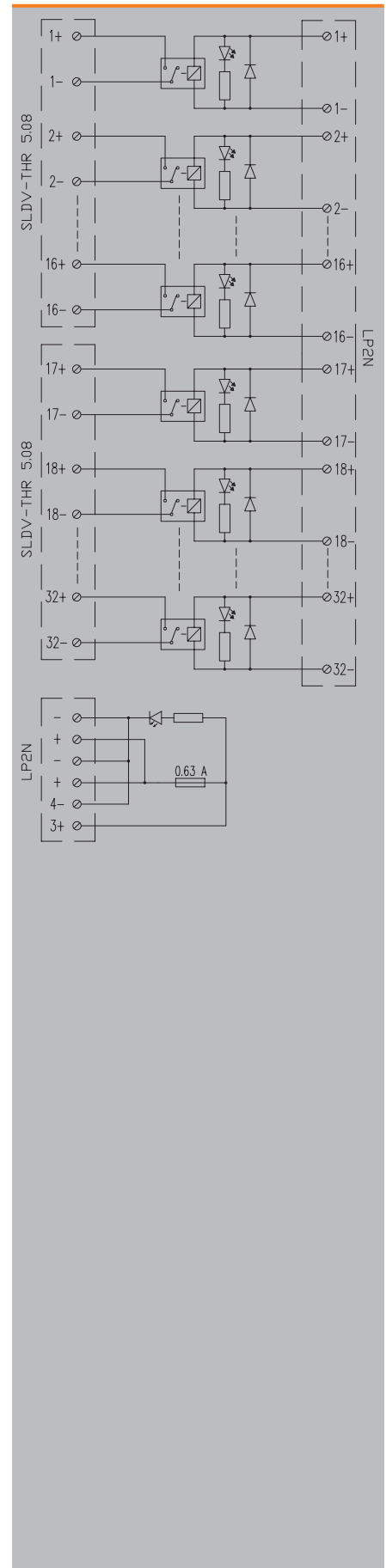

Honeywell C300 - FTA C300 Isolated interface per relay

Honeywell C300 - FTA C300

Isolated output interface for digital cards

Passive interfaces (FTA) for connecting the Honeywell C300 analogue IOTAs.

- Clearly labelled: same connector and position on the FTA and on the IOTA
- Input/output reinforced insulation (basic between contacts)
- Possibility of powering the IOTA from the FTA
- Screw or tension clamp connection

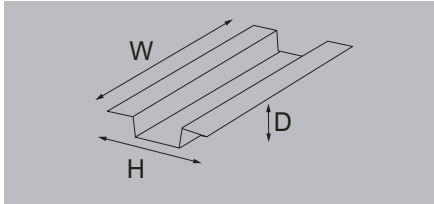

Technical data

Connection data and functionality

Connection on control side
 Number of poles (control side)
 Relay type
 LED status display per relay
 LED status of the supply voltage
 Fuse per relay
 Power supply fuse

Nominal input data

Input voltage
 Input current
 Operating voltage (supply)

Nominal output data

Contact material
 Operating voltage
 Max. DC continuous current

General data

Ambient temperature (operational)
 Storage temperature
 Approvals

Insulation coordination (EN50178)

Rated input insulation voltage
 Rated output insulation voltage
 Overvoltage category input/output
 Overvoltage category output/output
 Pollution severity level
 Pulse voltage test (1,2/50µs)
 Insulation test voltage
 Clearance input/output

Dimensions

Clamping range, min./max.
 Clamping range, min./max.
 Rail
 Width / Height

Note

Ordering data

Screw connection
 Tension clamp connection

Note

Accessories

Note

FTA-C300-32DO-RSLIM

For: CC-TD0B01, TD0B11

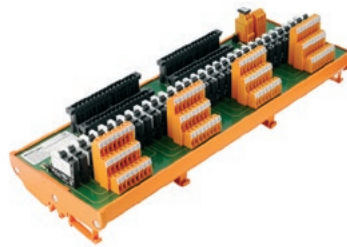

SLDV-THR 5.08
64-pole
RSS
green
yellow
No
5 A
24 V DC ± 10%
13 mA
24 V DC ± 10%
AgNi 90/10
250 V
-25...50 °C
-40...60 °C
CE, EAC
< 50 V AC
< 250 V AC
III
II
2
6 kV
1.2 kVAC
≥ 5.5 mm

Screw connection	Tension-clamp connection
0.13 mm ² / 6 mm ²	0.13 mm ² / 2.5 mm ²
0.13 mm ² / 6 mm ²	0.13 mm ² / 2.5 mm ²
TS 35, TS 32	TS 35, TS 32
368 mm / 133 mm	368 mm / 133 mm

Type	Depth	Order No.
FTA-C300-32DO-RSLIM-S	95 mm	1221570000
FTA-C300-32DO-RSLIM-Z	95 mm	1221580000

Relay 4060120000 RSS 24 V DC 1 CO

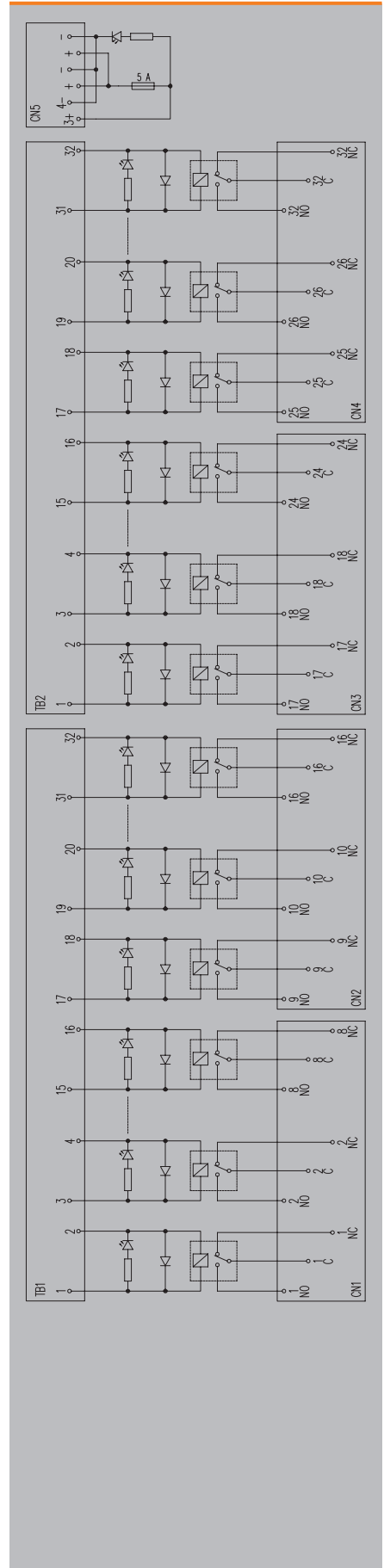

Honeywell C300 - Interconnection cables interconnection

Pre-assembled cables for connecting the C300 cards to the Weidmüller interfaces. 2 ranges:

- Premium: With housing for the connector
- Basic: Without housing for the connector

Shielded Cable Li YCY
 Colour code according DIN 47100
 Halogen free cables on demand

C300-32B-320B – Premium range

32 poles connector to 32 poles connector (with housing)



PAC-C300-3232 – Basic range

32 poles connector to 32 poles connector (without housing)

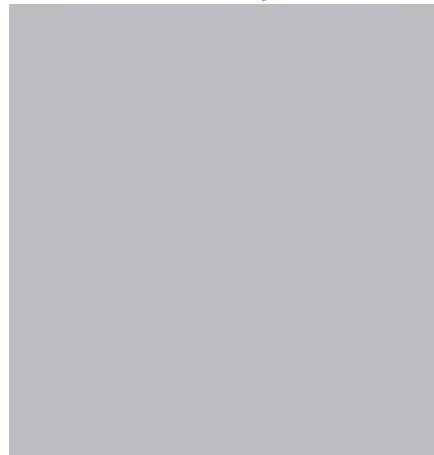
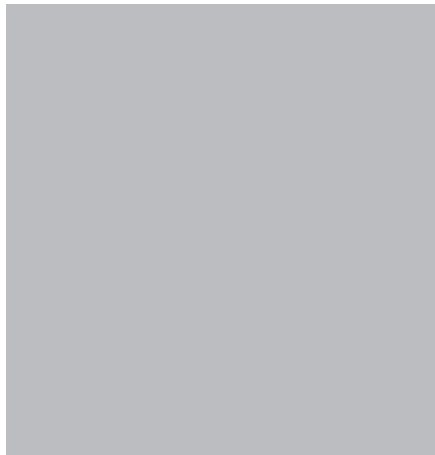

Technical data

Rated data	
Capacity wire / shield	
Capacity wire / wires	
Nominal rating, control cable	
Cable	
Material	
General data	
Ambient temperature (operational)	
Storage temperature	

Capacity wire / shield	300 pF/m
Capacity wire / wires	300 pF/m
Cable	Cable LiYCY
Material	PVC
Ambient temperature (operational)	-10...50 °C
Storage temperature	-10...60 °C

Capacity wire / shield	300 pF/m
Capacity wire / wires	300 pF/m
Cable	Cable LiYCY
Material	PVC
Ambient temperature (operational)	-10...50 °C
Storage temperature	-10...60 °C

Note

Resistance value according to the wire cross-section. See www.weidmueller.com
--

Resistance value according to the wire cross-section. See www.weidmueller.com
--

Ordering data

Division	Type	Qty.	Order No.
0.25 mm ²	C300-32B-320B-2S-M25-1M	1	7789828010
0.34 mm ²	C300-32B-320B-2S-M34-1M	1	7789888010
0.50 mm ²	C300-32B-320B-2S-M50-1M	1	7789838010

Type	Qty.	Order No.
C300-32B-320B-2S-M25-1M	1	7789828010
C300-32B-320B-2S-M34-1M	1	7789888010
C300-32B-320B-2S-M50-1M	1	7789838010

Type	Qty.	Order No.
PAC-C300-3232-25-1M	1	7789880010
PAC-C300-3232-34-1M	1	1498820010
PAC-C300-3232-50-1M	1	7789882010

Note

The last 3 digits of the cable code indicate its length. For example, if the code ends in 100, the cable would be 10 m long.
--

The last 3 digits of the cable code indicate its length. For example, if the code ends in 100, the cable would be 10 m long.
--

Accessories

Note

--

--

Honeywell C300 - Interconnection cables

Honeywell C300 - Interconnection cables interconnection

Pre-assembled cables for connecting the C300 cards to the Weidmüller interfaces. 2 ranges:

- Premium: With housing for the connector
- Basic: Without housing for the connector

Shielded Cable LI YCY

Colour code according DIN 47100

Halogen free cables on demand

C300-36B-324B – Premium range

32 + 4 poles connector to 32+4 poles connector (with housing)



PAC-C300-3636 – Basic range

32+4 poles connector to 32+4 poles connector (without housing)



B

Technical data

Rated data		
Capacity wire / shield	300 pF/m	300 pF/m
Capacity wire / wires	300 pF/m	300 pF/m
Nominal rating, control cable		
Cable	Cable LiYCY	Cable LiYCY
Material	PVC	PVC
General data		
Ambient temperature (operational)	-10...50 °C	-10...50 °C
Storage temperature	-10...60 °C	-10...60 °C

Note	Resistance value according to the wire cross-section. See www.weidmueller.com	Resistance value according to the wire cross-section. See www.weidmueller.com
------	--	--

Ordering data

Division	Type	Qty.	Order No.
0.25 mm ²	C300-36B-324B-2S-M25-1M	1	7789829010
0.34 mm ²	C300-36B-324B-2S-M34-1M	1	7789891010
0.50 mm ²	C300-36B-324B-2S-M50-1M	1	7789892010

Type	Qty.	Order No.
PAC-C300-3636-25-1M	1	7789884010
PAC-C300-3636-34-1M	1	7789885010
PAC-C300-3636-50-1M	1	7789837010

Note	The last 3 digits of the cable code indicate its length. For example, if the code ends in 100, the cable would be 10 m long.	The last 3 digits of the cable code indicate its length. For example, if the code ends in 100, the cable would be 10 m long.
------	--	--

Accessories

Note		
------	--	--

Honeywell C300 - Interconnection cables interconnection

Pre-assembled cables for connecting the C300 cards to the Weidmüller interfaces. 2 ranges:

- Premium: With housing for the connector
- Basic: Without housing for the connector

Shielded Cable LI YCY
 Colour code according DIN 47100
 Halogen free cables on demand

C300-32B-F - Premium range

32 poles connector to ferrules (with housing)

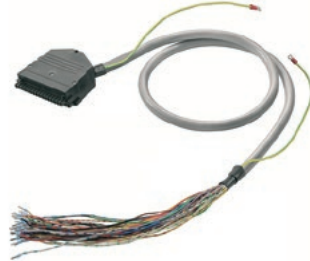

PAC-C300-32-F - Basic range

32 poles connector to ferrules (without housing)

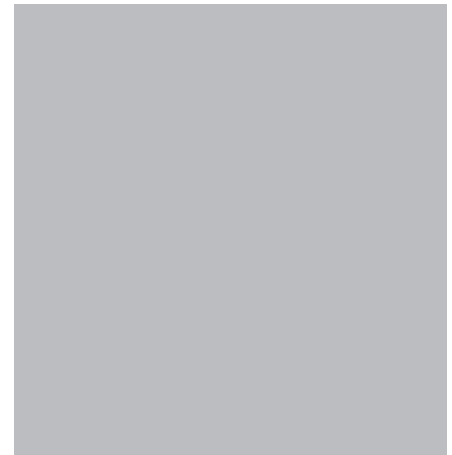
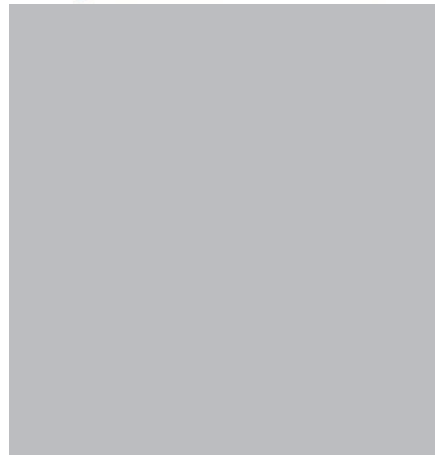
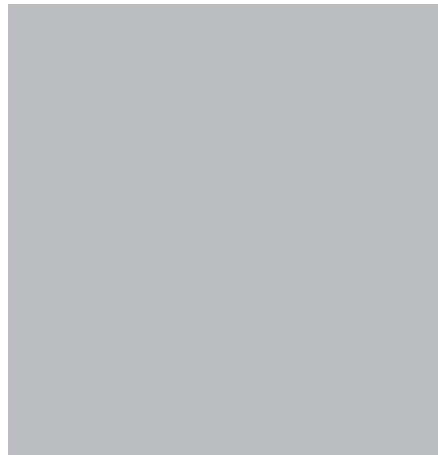

Technical data

Rated data
Capacity wire / shield
Capacity wire / wires
Nominal rating, control cable
Cable
Material
General data
Ambient temperature (operational)
Storage temperature

300 pF/m
300 pF/m
Cable LiYCY
PVC
-10...50 °C
-10...60 °C

300 pF/m
300 pF/m
Cable LiYCY
PVC
-10...50 °C
-10...60 °C

Note

Resistance value according to the wire cross-section. See www.weidmueller.com
--

Resistance value according to the wire cross-section. See www.weidmueller.com
--

Ordering data

Division	
0.25 mm ²	
0.34 mm ²	
0.50 mm ²	

Type	Qty.	Order No.
C300-32B-F-2S-M25-1M	1	1349350010
C300-32B-F-2S-M34-1M	1	7789617010
C300-32B-F-2S-M50-1M	1	7789895010

Type	Qty.	Order No.
PAC-C300-32-F-25-1M	1	1349330010
PAC-C300-32-F-34-1M	1	1373900010
PAC-C300-32-F-50-1M	1	1373940010

Note

The last 3 digits of the cable code indicate its length. For example, if the code ends in 100, the cable is 10 m long.
--

The last 3 digits of the cable code indicate its length. For example, if the code ends in 100, the cable is 10 m long.
--

Accessories

Note

--

--

Honeywell C300 - Interconnection cables

Honeywell C300 - Interconnection cables interconnection

Pre-assembled cables for connecting the C300 cards to the Weidmüller interfaces. 2 ranges:

- Premium: With housing for the connector
- Basic: Without housing for the connector

Shielded Cable LI YCY
 Colour code according DIN 47100
 Halogen free cables on demand

C300-36B-F - Premium range

32+4 poles connector to ferrules (with housing)



PAC-C300-36-F - Basic range

32+4 poles connector to ferrules (without housing)

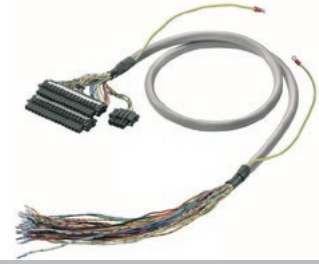

B

Technical data

Rated data
Capacity wire / shield
Capacity wire / wires
Nominal rating, control cable
Cable
Material
General data
Ambient temperature (operational)
Storage temperature

300 pF/m
300 pF/m
Cable LiYCY
PVC
-10...50 °C
-10...60 °C

300 pF/m
300 pF/m
Cable LiYCY
PVC
-10...50 °C
-10...60 °C

Note

Resistance value according to the wire cross-section. See www.weidmueller.com

Resistance value according to the wire cross-section. See www.weidmueller.com

Ordering data

Division	
0.25 mm ²	
0.34 mm ²	
0.50 mm ²	

Type	Qty.	Order No.
C300-36B-F-2S-M25-1M	1	1349370010
C300-36B-F-2S-M34-1M	1	1373780010
C300-36B-F-2S-M50-1M	1	1373820010

Type	Qty.	Order No.
PAC-C300-36-F-25-1M	1	1349340010
PAC-C300-36-F-34-1M	1	1373910010
PAC-C300-36-F-50-1M	1	1373950010

Note

The last 3 digits of the cable code indicate its length. For example, if the code ends in 100, the cable is 10 m long.

The last 3 digits of the cable code indicate its length. For example, if the code ends in 100, the cable is 10 m long.

Accessories

Note

Honeywell C300 - Interconnection cables interconnection

Pre-assembled cables for connecting the C300 cards to the Weidmüller interfaces. 2 ranges:

- Premium: With housing for the connector
- Basic: Without housing for the connector

Shielded Cable LI YCY
 Colour code according DIN 47100
 Halogen free cables on demand

C300-16B-160B – Premium range

16 poles connector to 16 poles connector (with housing)



PAC-C300-1616 – Basic range

16 poles connector to 16 poles connector (without housing)

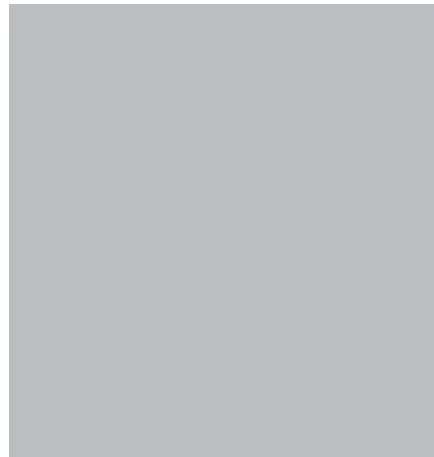
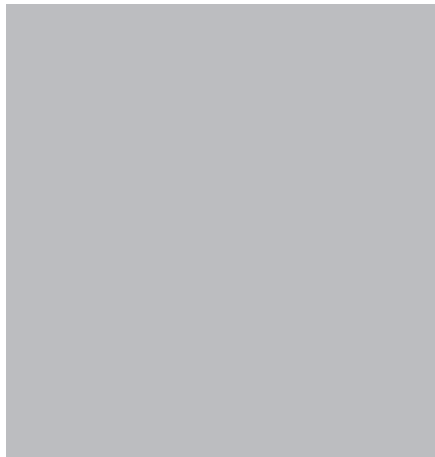

Technical data

Rated data	
Capacity wire / shield	300 pF/m
Capacity wire / wires	300 pF/m
Nominal rating, control cable	
Cable	Cable LiYCY
Material	PVC
General data	
Ambient temperature (operational)	-10...50 °C
Storage temperature	-10...60 °C

Rated data	
Capacity wire / shield	300 pF/m
Capacity wire / wires	300 pF/m
Nominal rating, control cable	
Cable	Cable LiYCY
Material	PVC
General data	
Ambient temperature (operational)	-10...50 °C
Storage temperature	-10...60 °C

Rated data	
Capacity wire / shield	300 pF/m
Capacity wire / wires	300 pF/m
Nominal rating, control cable	
Cable	Cable LiYCY
Material	PVC
General data	
Ambient temperature (operational)	-10...50 °C
Storage temperature	-10...60 °C

Note

Resistance value according to the wire cross-section. See www.weidmueller.com

Resistance value according to the wire cross-section. See www.weidmueller.com

Ordering data

Division	Type	Qty.	Order No.
0.25 mm ²	C300-16B-160B-2S-M25-1M	1	1481690010
0.34 mm ²	C300-16B-160B-2S-M34-1M	1	1481710010
0.50 mm ²	C300-16B-160B-2S-M50-1M	1	1481720010

Type	Qty.	Order No.
C300-16B-160B-2S-M25-1M	1	1481690010
C300-16B-160B-2S-M34-1M	1	1481710010
C300-16B-160B-2S-M50-1M	1	1481720010

Type	Qty.	Order No.
PAC-C300-1616-25-1M	1	1481610010
PAC-C300-1616-34-1M	1	1481620010
PAC-C300-1616-50-1M	1	1481630010

Note

The last 3 digits of the cable code indicate its length. For example, if the code ends in 100, the cable is 10 m long.

The last 3 digits of the cable code indicate its length. For example, if the code ends in 100, the cable is 10 m long.

Accessories

Note

Honeywell C300 - Interconnection cables

Honeywell C300 - Interconnection cables interconnection

Pre-assembled cables for connecting the C300 cards to the Weidmüller interfaces. 2 ranges:

- Premium: With housing for the connector
- Basic: Without housing for the connector

Shielded Cable LI YCY
 Colour code according DIN 47100
 Halogen free cables on demand

C300-16B-F - Premium range

16 poles connector to ferrules (with housing)



PAC-C300-16-F - Basic range

16 poles connector to ferrules (without housing)



B

Technical data

Rated data		
Capacity wire / shield	300 pF/m	300 pF/m
Capacity wire / wires	300 pF/m	300 pF/m
Nominal rating, control cable		
Cable	Cable LiYCY	Cable LiYCY
Material	PVC	PVC
General data		
Ambient temperature (operational)	-10...50 °C	-10...50 °C
Storage temperature	-10...60 °C	-10...60 °C

Note	Resistance value according to the wire cross-section. See www.weidmueller.com	Resistance value according to the wire cross-section. See www.weidmueller.com
------	--	--

Ordering data

Division	Type	Qty.	Order No.
0.25 mm ²	C300-16B-F-2S-M25-1M	1	1481740010
0.34 mm ²	C300-16B-F-2S-M34-1M	1	1481750010
0.50 mm ²	C300-16B-F-2S-M50-1M	1	1481760010

Type	Qty.	Order No.
PAC-C300-16-F-25-1M	1	1481650010
PAC-C300-16-F-34-1M	1	1481660010
PAC-C300-16-F-50-1M	1	1481670010

Note	The last 3 digits of the cable code indicate its length. For example, if the code ends in 100, the cable is 10 m long.	The last 3 digits of the cable code indicate its length. For example, if the code ends in 100, the cable is 10 m long.
------	--	--

Accessories

Note		
------	--	--

Honeywell C300 - Interconnection cables interconnection

Pre-assembled cables for connecting the C300 cards to the Weidmüller interfaces. 2 ranges:

- Premium: With housing for the connector
- Basic: Without housing for the connector

Shielded Cable LI YCY
 Colour code according DIN 47100
 Halogen free cables on demand

C300-32B-216B - Premium range

32 poles connector to 2X16 poles connector (with housing)



PAC-C300-32-1616 - Basic range

32 poles connector to 2X16 poles connector (without housing)

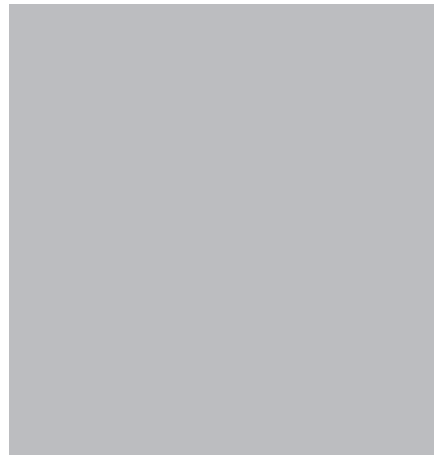
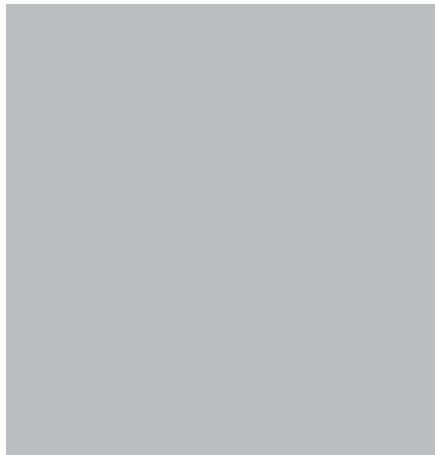

Technical data

Rated data	
Capacity wire / shield	
Capacity wire / wires	
Nominal rating, control cable	
Cable	
Material	
General data	
Ambient temperature (operational)	
Storage temperature	

	300 pF/m
	300 pF/m
	Cable LiYCY
	PVC
	-10...50 °C
	-10...60 °C

Note

Resistance value according to the wire cross-section. See www.weidmueller.com
--

Resistance value according to the wire cross-section. See www.weidmueller.com
--

Ordering data

Division	Type	Qty.	Order No.
0.25 mm ²	C300-32B-216B-2S-M25-1M	1	2699000010
0.34 mm ²	C300-32B-216B-2S-M34-1M	1	2699010010
0.50 mm ²	C300-32B-216B-2S-M50-1M	1	2699020010

Type	Qty.	Order No.
C300-32B-216B-2S-M25-1M	1	2699000010
C300-32B-216B-2S-M34-1M	1	2699010010
C300-32B-216B-2S-M50-1M	1	2699020010

Type	Qty.	Order No.
PAC-C300-32-1616-25-1M	1	1373880010
PAC-C300-32-1616-34-1M	1	7789893010
PAC-C300-32-1616-50-1M	1	1373920010

Note

The last 3 digits of the cable code indicate its length. For example, if the code ends in 100, the cable is 10 m long.
--

The last 3 digits of the cable code indicate its length. For example, if the code ends in 100, the cable is 10 m long.
--

Accessories

Note

--

--

Interface units for Yokogawa CS3000 and ProSafe

Interface units for Yokogawa CS3000 and ProSafe

Yokogawa CS3000 and ProSafe – General description	C.2
Yokogawa CS3000 – Selection guide	C.5
Yokogawa CS3000 – TBY Input/Output interfaces for CS3000	C.6
Yokogawa ProSafe – Selection guide	C.17
Yokogawa ProSafe – TBY Input/Output interfaces for ProSafe	C.18
MIL cables	C.26
Yokogawa backplane – SIL Backplane for digital outputs	C.28

Interface units for Yokogawa CS3000 and ProSafe

Secure and fast connection between Distributed Control Systems and the field

C

The goal is to provide a simple and clean connection between sensors/actuators and the Yokogawa controllers. This is achieved by using our interface units in the marshalling cabinets.

The main goals of the Yokogawa CS3000 and Prosafe interfaces are to prevent cabling errors, save space in the electronics cabinet and save time and costs in the construction of electronics cabinets.

This is where our interface units for the Yokogawa CS3000 and ProSafe controllers score: the compact interfaces minimise cabling costs and offer significant benefits such as the regulated power supply with control relay.

If required we supply the components with a coating according to corrosion class G3.

These benefits and more will enable you to establish the optimum connection between field elements and input/output cards from Yokogawa.



You are shaping the future of the process industry

Global competition and market dynamism are driving change in the process industry. New global strategies, mergers and takeovers, investments and spin-offs are all part of the change. Plant operators and manufacturers who ensure a higher standardisation of production processes are one step ahead of the market. The best conditions for efficient plant operation are secure connectivity and a cost- and space-saving connection when transmitting and converting signals.

Reliable connection

The interface units are provided with a screw or tension clamp connection on the field side and with compatible connectors to KS or AKB cables on the control side.



TERMSERIES interface adapter

Our pre-assembled plug-and-play solution with TERMSERIES interface adapter enables and minimised wiring effort. See Chapter E

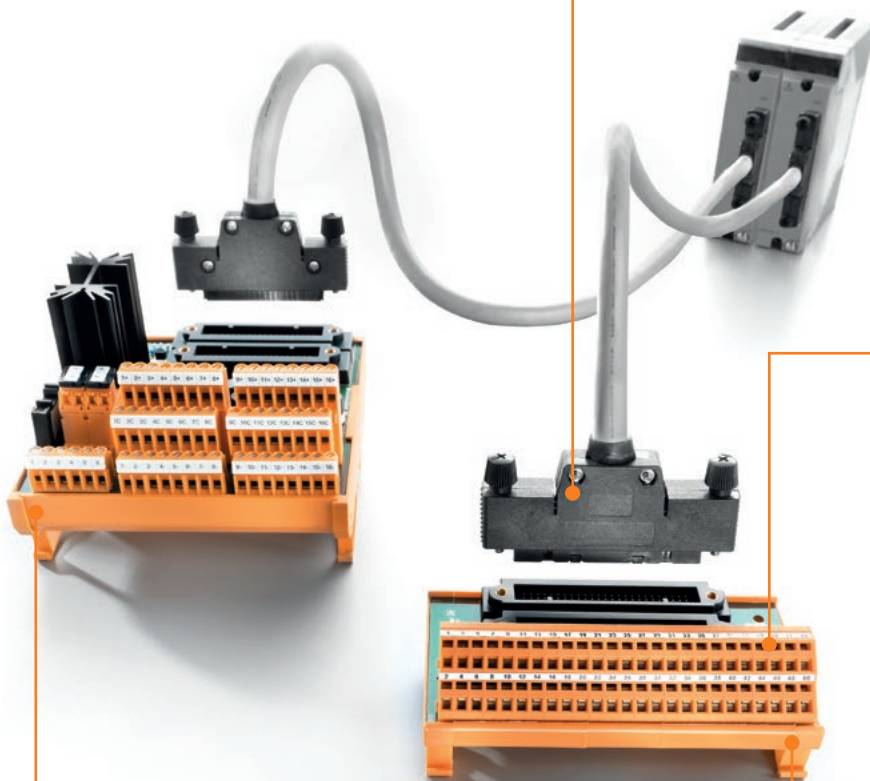
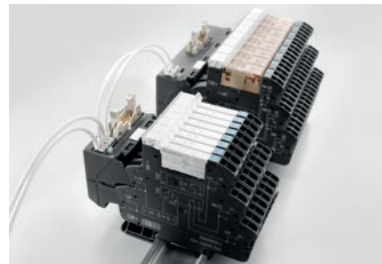

Numerous integral functions

Isolators, fuses with fault display, status LEDs: field sensors may be supplied with power within the individual modular terminal.

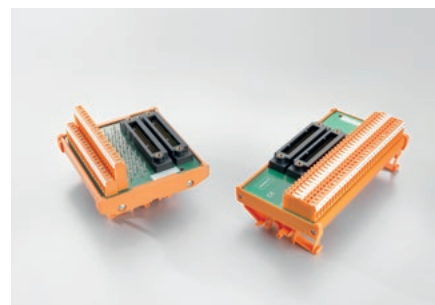

Redundancy supply control

Up to two power supplies can be connected to the interface units for Yokogawa systems. If one of the power supplies falls below approx. 12 V an alarm is activated and the power supply LED is extinguished.

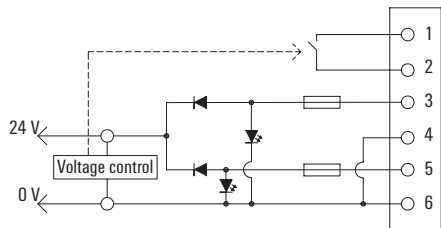

Wide temperature range

The interface can work in ambient temperatures ranging from -25 to +70 °C.

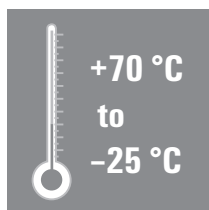

Wide range of interfaces

The range includes passive input/output interfaces for digital and analogue signals and isolated interfaces with relays incorporating a compact design.

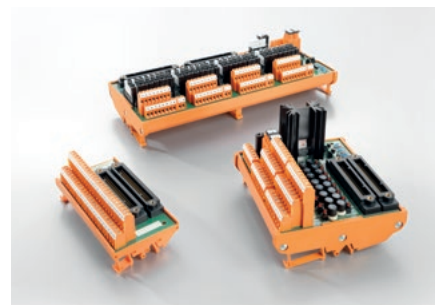

The following selection guides enable you to quickly and easily choose the correct products according to your application needs:

STEP 1: Choose the Yokogawa Card to be used.

STEP 2: Choose the most suitable interface for the application.

Example: For AAB841 it's possible to select different options:

* In screw: 1371470000, 1371600000, 1371640000

* In tension clamp: 1371500000, 1371610000, 1371650000

This is small selection of the most frequently used termination boards. Other termination boards are also available. G3 termination boards can also be provided under demand.

Yokogawa CS3000 – Selection guide

STEP 1		STEP 2												
Yokogawa Card		TBY (Weidmüller Interfaces for Yokogawa)												
Kind of Card	Card	Kind of connector	Redundancy Power supply	Fuses per channel	Disconnect + Test points	Forks for components	Led channel	Led fuse	Relay	Type	Order No. Screw	Order No. Tension clamp	Page	
8 analogue input/ 8 analogue output	AAB841	KS								TBY-C3-AIO-2KS	1371470000	1371500000	C.6	
		KS			↔					TBY-C3-AIO+2KS	1371600000	1371610000	C.8	
		KS				Y				TBY-C3-UNIV-SP-2KS	1371640000	1371650000	C.9	
8 analogue inputs	AAI135 AAP135	KS								TBY-C3-AIO-2KS	1371470000	1371500000	C.6	
		KS			↔					TBY-C3-AIO+2KS	1371600000	1371610000	C.8	
		KS				Y				TBY-C3-UNIV-SP-2KS	1371640000	1371650000	C.9	
16 analogue current input	AAI141 AAI143	KS								TBY-C3-AIO-2KS	1371470000	1371500000	C.6	
		KS								TBY-C3-16AI-2KS	1371530000	1371550000	C.6	
		KS			↔					TBY-C3-AIO+2KS	1371600000	1371610000	C.8	
4 analogue current input/ 4 analogue current output	AAI835	KS								TBY-C3-UNIV-SP-2KS	1371640000	1371650000	C.9	
		KS			↔					TBY-C3-AIO-2KS	1371470000	1371500000	C.6	
		KS								TBY-C3-AIO+2KS	1371600000	1371610000	C.8	
8 analogue input/ 8 analogue output	AAI841	KS								TBY-C3-AIO-2KS	1371470000	1371500000	C.6	
		KS			↔					TBY-C3-AIO+2KS-Z	1371600000	1371610000	C.8	
		KS				Y				TBY-C3-UNIV-SP-2KS	1371640000	1371650000	C.9	
16 analogue voltage input	AAV141 AAV142 AAV144	KS								TBY-C3-AIO-2KS	1371470000	1371500000	C.6	
		KS								TBY-C3-16AIO-2KS	1371580000	1371590000	C.6	
		KS			↔					TBY-C3-AIO+2KS-Z	1371600000	1371610000	C.8	
16 analogue output	AAV542 AAV544 AAI543	KS								TBY-C3-UNIV-SP-2KS	1371640000	1371650000	C.9	
		KS								TBY-C3-AIO-2KS	1371470000	1371500000	C.6	
		KS			↔					TBY-C3-16AIO-2KS	1371580000	1371590000	C.6	
16 RTD analogue input	AAR145	AKB							TBY-C3-AIO+2KS	1371600000	1371610000	C.8		
12 RTD input modules	AAR181	KS				Y			TBY-C3-UNIV-SP-2KS	1371640000	1371650000	C.9		
32 digital input	ADV151 ADV161 (Use 2 TBY per card)	AKB								TBY-C3-UNIV-2KB	1384090000	1384080000	C.10	
		AKB	2 A				⚡			TBY-ADV151-PS-L-2KB	1384350000	1384340000	C.11	
		AKB	2 A	100 mA				⚡			TBY-ADV151-PS-FL-2KB	1397820000	1397830000	C.12
		AKB	2 A	100 mA				⚡	24 V DC		TBY-ADV151-24-PS-2KB	1384330000	1384320000	C.13
32 digital output	ADV551 ADV561 (Use 2 TBY per card)	AKB								TBY-ADV151-48-PS-2KB	1384280000	1384250000	C.14	
		AKB	2 A	100 mA				⚡	48 V DC		TBY-ADV151-48-PS-2KB	1384280000	1384250000	C.14
		AKB	1 A					⚡	24 V DC		TBY-C3-UNIV-2KB	1384090000	1384080000	C.10
		AKB							TBY-ADV551-CF-PS-2KB	1379500000	1379510000	C.15		

Note:

Yokogawa CS3000 – TBY Input/Output interfaces for CS3000

TBY-CS3000 Input/Output interfaces for CS3000 analogue cards

Interface for 8 or 16 analogue signals (depend on marking)

- 2 KS connectors (40 poles) for redundancy
- Direct connection between the Yokogawa card and the field connectors.
- Basic module also without marking available and markers as accessory for customer flexibility
- Complete modules with marking available
- Screw and tension clamp connection

TBY-C3-

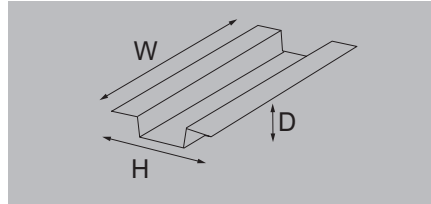

Technical data

Connected to	Connection to the card
Connection data and functionality	Connection on control side LED status display per channel LED status of the supply voltage Fuse per channel Power supply fuse Disconnection per channel Type of test point
Rated data	Operating voltage Max. current per channel Operating voltage (supply) Operating current (supply)
General data	Ambient temperature (operational) Storage temperature
Insulation coordination (EN50178)	Rated insulation voltage Surge voltage category Pollution severity level Insulation test voltage Pulse voltage test (1,2/50µs)
Dimensions	Clamping range, min./max. Clamping range, min./max. Rail Width / Height
Note	

	AAB841, AAI135, AAI141, AAI143, AAI543, AAI841, AAI835, AAP135, AAV141, AAV142, AAV144, AAV542, AAV544
	2 x KS (40P)
	No
	No
	No
	No
	No
	No
	50 V AC / 70 V DC
	1 A
	50 V AC / 70 V DC
	1 A
	-25...70 °C
	-40...85 °C
	< 50 V AC
	III
	2
	0.35 kVAC
	0.8 kV
Screw connection	Tension-clamp connection
0.13 mm ² / 6 mm ²	0.13 mm ² / 2.5 mm ²
0.13 mm ² / 6 mm ²	0.13 mm ² / 2.5 mm ²
TS 35, TS 32	TS 35, TS 32
90 mm / 70 mm	90 mm / 70 mm

Ordering data

Terminal block for:	Analogue signals without marking (S)	Analogue signals without marking (Z)
	AAI141, AAI143 (S)	AAI141, AAI143 (Z)
	AAI543, AAV141, AAV142, AAV144, AAV542, AAV544 (S)	AAI543, AAV141, AAV142, AAV144, AAV542, AAV544 (Z)
Note	Picture shows article number 1371530000 S (screw connection), Z (tension-clamp connection)	

Type	Depth	Order No.
TBY-C3-AIQ-2KS-S	56 mm	1371470000
TBY-C3-AIQ-2KS-Z	52 mm	1371500000
TBY-C3-16AI-2KS-S	56 mm	1371530000
TBY-C3-16AI-2KS-Z	52 mm	1371550000
TBY-C3-16AIQ-2KS-S	56 mm	1371580000
TBY-C3-16AIQ-2KS-Z	52 mm	1371590000

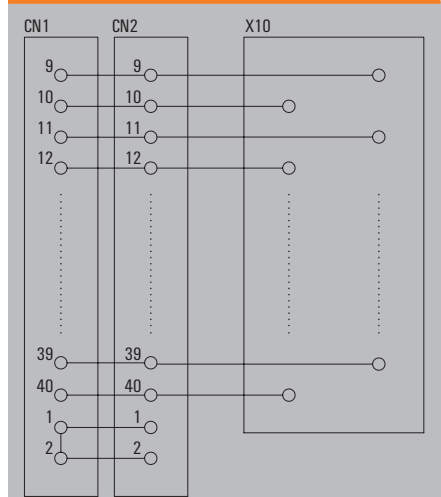

Schematic for 1371470000/1371500000

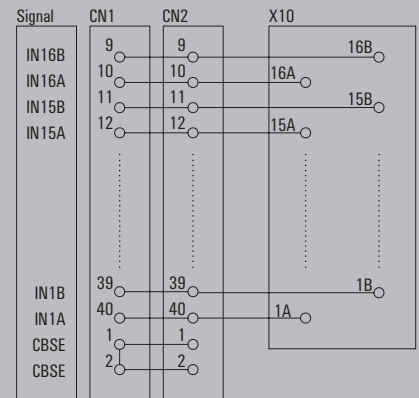

Schematic for 1371530000/1371550000 (AAI141, AAI143)

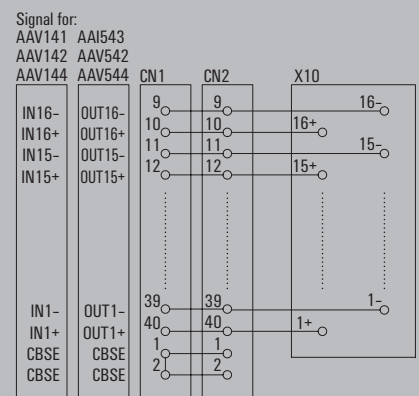

Schematic for 1371580000/1371590000
(AAV141, AAV142, AAV144, AAI543, AAV542, AAV544)

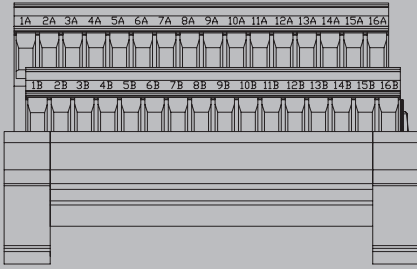

Field terminals view 1371530000 / 1371550000
(AAI141, AAI143)

Application note: With the markers showed as accessories, is possible to configurate the TBY for other cards

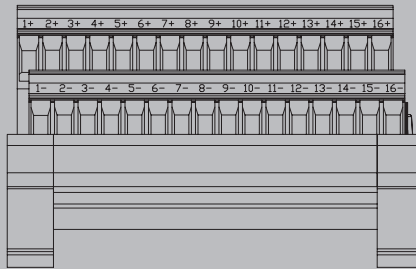

Field terminals view 1371580000 / 1371590000
(AAV141, AAV142, AAV144, AAI543, AAV542, AAV544)

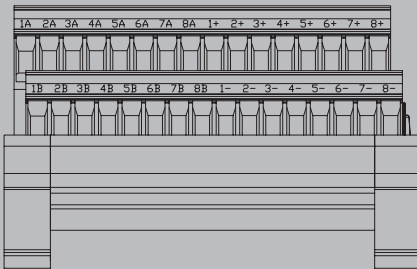

Connection for AAI841

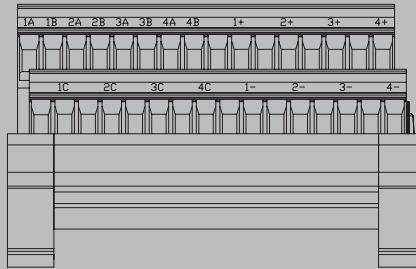

Connection for AAI835

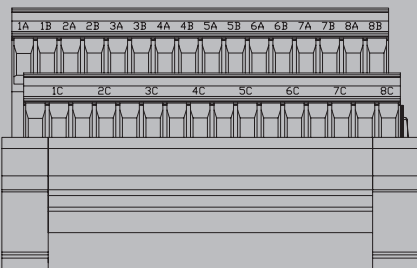

Connection for AAI135, AAP135

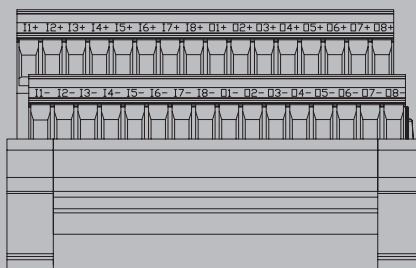

Connection for AAB841

TBY-CS3000 Input/Output interfaces for CS3000 analogue cards

Interface for 8 or 16 analogue signals

- 2 KS connectors (40 poles) for redundancy
- Disconnecting plugs and test points (2 mm diameter) for voltage or current measurement.
- The TBY is delivered with the marking for AAI141, AAI143 and it's compatible with other analogue cards.
- Marker available as accessory.
- Screw and tension clamp connection

TBY-C3-AIO-I-2KS

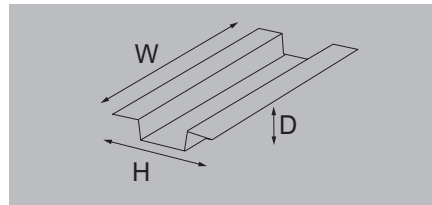

Technical data

Connected to	Connection to the card
Connection data and functionality	Connection on control side LED status display per channel LED status of the supply voltage Fuse per channel Power supply fuse Disconnection per channel Type of test point
Rated data	Operating voltage Max. current per channel Operating voltage (supply) Operating current (supply)
General data	Ambient temperature (operational) Storage temperature
Insulation coordination (EN50178)	Rated insulation voltage Surge voltage category Pollution severity level Insulation test voltage Pulse voltage test (1,2/50µs)
Dimensions	Clamping range, min./max. Clamping range, min./max. Rail Width / Height
Note	

AAB841, AAI135, AAI141, AAI143, AAI841, AAI543, AAI835, AAP135, AAV141, AAV142, AAV144, AAV542, AAV544	
2 x KS (40P)	
No	
No	
No	
No	
Yes	
Diameter: 2 mm	
50 V AC / 70 V DC	
1 A	
50 V AC / 70 V DC	
1 A	
-25...70 °C	
-40...85 °C	
< 50 V AC	
III	
2	
0.35 kVAC	
0.8 kV	
Screw connection	Tension-clamp connection
0.13 mm ² / 6 mm ²	0.13 mm ² / 2.5 mm ²
0.13 mm ² / 6 mm ²	0.13 mm ² / 2.5 mm ²
TS 35, TS 32	TS 35, TS 32
170 mm / 87 mm	170 mm / 87 mm

Ordering data

	Screw connection
	Tension clamp connection
Note	

Type	Depth	Order No.
TBY-C3-AIO+2KS-S	56 mm	1371600000
TBY-C3-AIO+2KS-Z	59 mm	1371610000

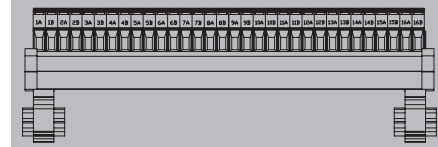
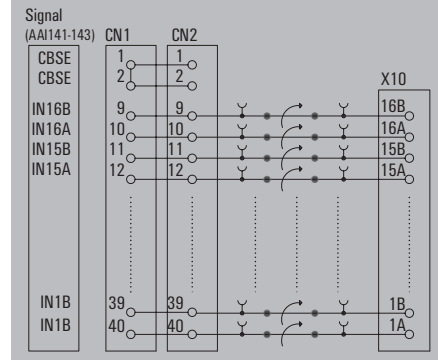

Connection for AAI141, AAI143

Application note: With the markers showed as accessories, it is possible to configure the TBY for other cards



Connection for AAV141, AAV142, AAV144, AAI543, AAV542, AAV544)

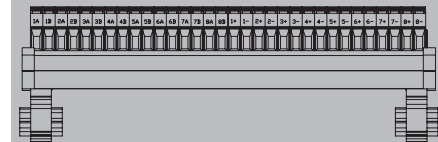

Connection for AAI841

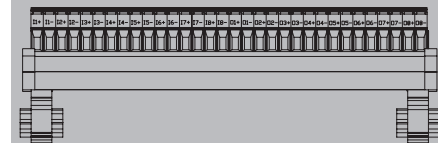

Connection for AAB841

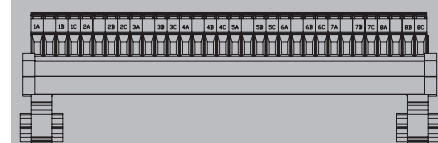

Connection for AAI135, AAP135

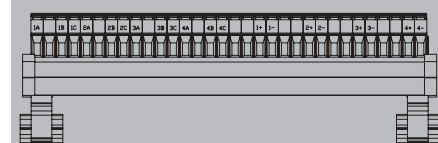

Connection for AAI835

TBY-CS3000 Input/Output interfaces for CS3000 analogue cards

Interface for analogue signals

- 2 KS connectors (40 poles) for redundancy
- Direct connection between the Yokogawa card and the field connectors.
- The soldering tags allows the mounting of external components: voltage conversion or monitorization of the current loop.
- Screw and tension clamp connection

TBY-C3-UNIV-SP-2KS

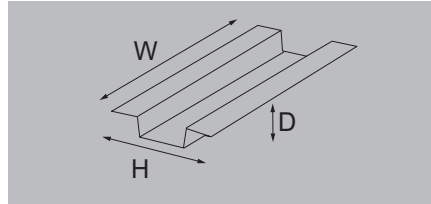
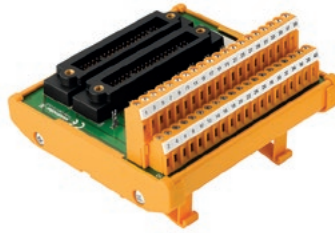

Technical data

Connected to	Connection to the card	
Connection data and functionality	AAI141, AAI143, AAV141, AAV142, AAV144, AAI841, AAB841, AAV542, AAI543, AAV544, AAR181, AAI135, AAP135, AAI835	
Connection on control side	2 x KS (40P)	
LED status display per channel	No	
LED status of the supply voltage	No	
Fuse per channel	No	
Power supply fuse	No	
Disconnection per channel	No	
Type of test point	Soldering tags	
Rated data	50 V AC / 70 V DC	
Operating voltage	1 A	
Max. current per channel	50 V AC / 70 V DC	
Operating voltage (supply)	1 A	
Operating current (supply)		
General data	-25...70 °C	
Ambient temperature (operational)	-40...85 °C	
Storage temperature	< 50 V AC	
Insulation coordination (EN50178)	III	
Rated insulation voltage	2	
Surge voltage category	0.35 kVAC	
Pollution severity level	0.8 kV	
Insulation test voltage		
Pulse voltage test (1,2/50µs)		
Dimensions	Screw connection	Tension-clamp connection
Clamping range, min./max.	0.13 mm ² / 6 mm ²	0.13 mm ² / 2.5 mm ²
Clamping range, min./max.	0.13 mm ² / 6 mm ²	0.13 mm ² / 2.5 mm ²
Rail	TS 35, TS 32	TS 35, TS 32
Width / Height	112 mm / 109 mm	112 mm / 109 mm
Note		

Ordering data

	Screw connection	Type	Depth	Order No.
	Tension clamp connection	TBY-C3-UNIV-SP-2KS-S	70 mm	1371640000
		TBY-C3-UNIV-SP-2KS-Z	65 mm	1371650000
Note				

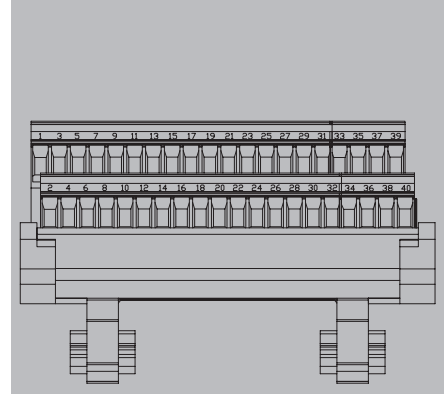
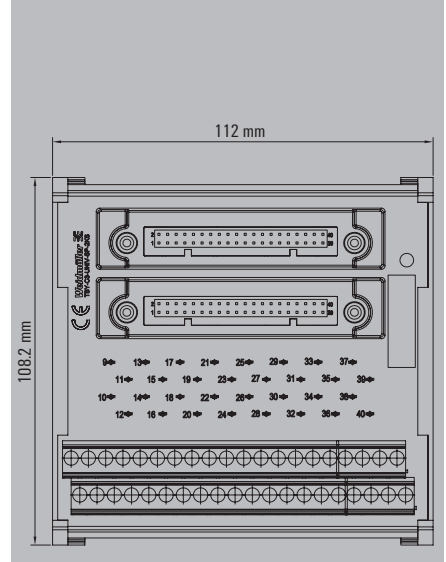
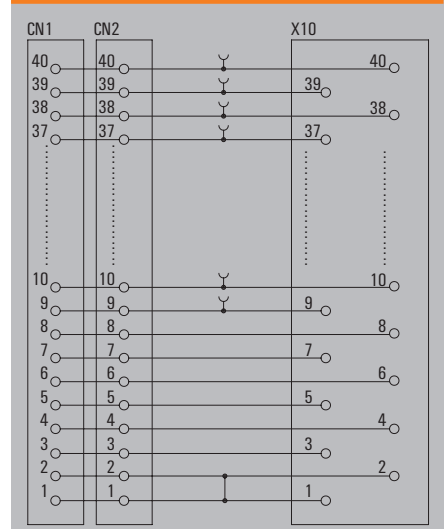

TBY-CS3000 Input/Output interfaces for CS3000 digital cards

Interface for Centum CS3000 digital Cards

- AKB connectors (50 poles) for redundancy
- Direct connection between the Yokogawa card and the field connectors.
- Screw and tension clamp connection

TBY-C3-UNIV-2KB

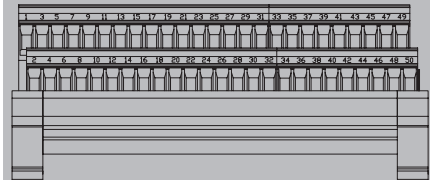
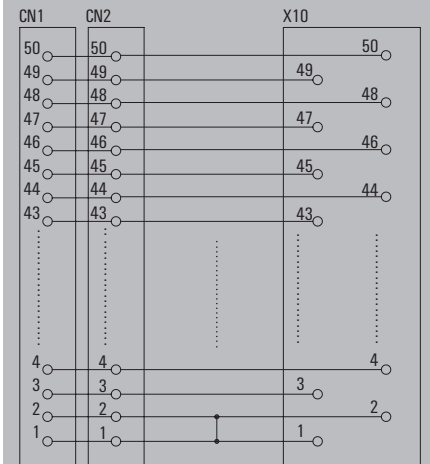
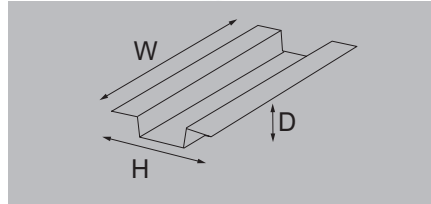

Technical data

Connected to	Connection to the card
Connection data and functionality	Connection on control side LED status display per channel LED status of the supply voltage Fuse per channel Power supply fuse Disconnection per channel Type of test point
Rated data	Operating voltage Max. current per channel Operating voltage (supply) Operating current (supply)
General data	Ambient temperature (operational) Storage temperature
Insulation coordination (EN50178)	Rated insulation voltage Surge voltage category Pollution severity level Insulation test voltage Pulse voltage test (1,2/50µs)
Dimensions	Clamping range, min./max. Clamping range, min./max. Rail Width / Height
Note	

	ADV151, ADV161, ADV551, ADV561, AAR145
	2 x AKB (50P)
	No
	No
	No
	No
	No
	No
	50 V AC / 70 V DC
	1 A
	50 V AC / 70 V DC
	1 A
	-25...70 °C
	-40...85 °C
	< 50 V AC
	III
	2
	0.35 kVAC
	0.8 kV
Screw connection	Tension-clamp connection
	0.13 mm ² / 6 mm ²
	0.13 mm ² / 6 mm ²
	TS 35, TS 32
	TS 35, TS 32
	135 mm / 70 mm
	135 mm / 70 mm

Ordering data

	Screw connection
	Tension clamp connection
Note	

Type	Depth	Order No.
TBY-C3-UNIV-2KB-S	56 mm	1384090000
TBY-C3-UNIV-2KB-Z	52 mm	1384080000

TBY-CS3000 Input/Output interfaces for CS3000 digital cards

- Interface for Centum ADV151 32 digital input card
- 2 AKB connectors (50 poles) for redundancy
- Green LED shows channel Status
- The Card can be configured with positive or negative common (see schematic)
- Monotorization of the Power supply status with green LED and alarm contact (24 V DC / 2...100 mA): close contact and led shinning means no supply fault.
- Screw and tension clamp connection

TBY-ADV151-PS-L-2KB

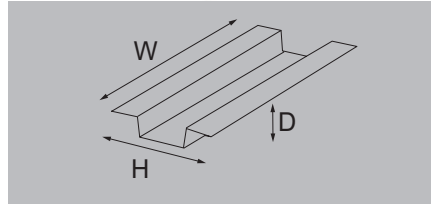

Technical data

Connected to	Connection to the card
Connection data and functionality	Connection on control side LED status display per channel LED status of the supply voltage Fuse per channel Power supply fuse Disconnection per channel Type of test point
Rated data	Operating voltage Max. current per channel Operating voltage (supply) Operating current (supply)
General data	Ambient temperature (operational) Storage temperature
Insulation coordination (EN50178)	Rated insulation voltage Surge voltage category Pollution severity level Insulation test voltage Pulse voltage test (1,2/50µs)
Dimensions	Clamping range, min./max. Clamping range, min./max. Rail Width / Height
Note	

ADV151, ADV161 (2 TBY by Card)	
2 x AKB (50P)	
green	
green	
No	
2 A	
No	
No	
24 V DC	
1 A	
24 V DC	
2 A	
-25...70 °C	
-40...85 °C	
< 50 V AC	
III	
2	
0.35 kVAC	
0.8 kV	
Screw connection	Tension-clamp connection
0.13 mm ² / 6 mm ²	0.13 mm ² / 2.5 mm ²
0.13 mm ² / 6 mm ²	0.13 mm ² / 2.5 mm ²
TS 35, TS 32	TS 35, TS 32
190 mm / 109 mm	190 mm / 109 mm

Ordering data

	Screw connection
	Tension clamp connection
Note	

Type	Depth	Order No.
TBY-ADV151-PS-L-2KB-S	85 mm	1384350000
TBY-ADV151-PS-L-2KB-Z	85 mm	1384340000

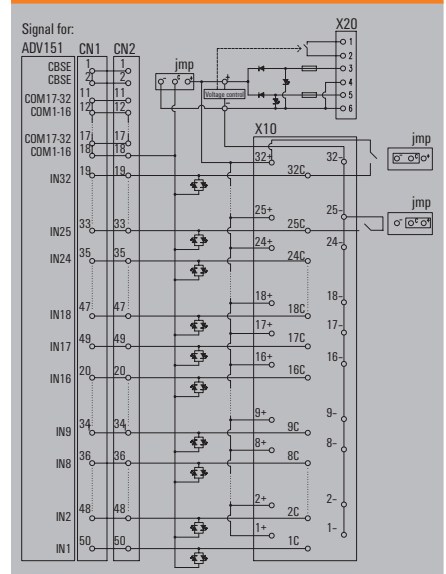

Field terminals view for 1384350000 (ADV151)



Field terminals view for ADV161 (Channels 33 to 64)

Yokogawa CS3000 – TBY Input/Output interfaces for CS3000

TBY-CS3000 Input/Output interfaces for CS3000 digital cards

- Interface for Centum ADV151 32 digital input card
- 2 AKB connectors (50 poles) for redundancy
 - The input sensors are connected to the card with fuses.
 - Green LED shows channel status
 - The Card can be configured with positive or negative common (see schematic)
 - Monotorization of the Power supply status with green LED and alarm contact (24 V DC / 2...100 mA); close contact and led shinning means no supply fault.
 - Screw and tension clamp connection

TBY-ADV151-PS-F-L-2KB

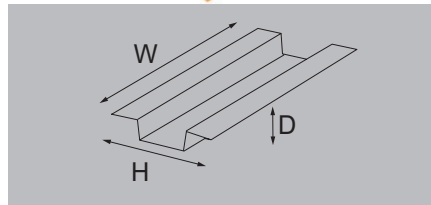

Technical data

Connected to	Connection to the card
Connection data and functionality	Connection on control side LED status display per channel LED status of the supply voltage Fuse per channel Power supply fuse Disconnection per channel Type of test point
Rated data	Operating voltage Max. current per channel Operating voltage (supply) Operating current (supply)
General data	Ambient temperature (operational) Storage temperature
Insulation coordination (EN50178)	Rated insulation voltage Surge voltage category Pollution severity level Insulation test voltage Pulse voltage test (1,2/50µs)
Dimensions	Clamping range, min./max. Clamping range, min./max. Rail Width / Height
Note	

ADV551, ADV561 (2 TBY by Card)	
2 x AKB (50P)	
green	
green	
100 mA	
2 A	
No	
No	
24 V DC	
1 A	
24 V DC	
2 A	
-25...70 °C	
-40...85 °C	
< 50 V AC	
III	
2	
0.35 kVAC	
0.8 kV	
Screw connection	Tension-clamp connection
0.13 mm ² / 6 mm ²	0.13 mm ² / 2.5 mm ²
0.13 mm ² / 6 mm ²	0.13 mm ² / 2.5 mm ²
TS 35, TS 32	TS 35, TS 32
190 mm / 131 mm	190 mm / 131 mm

Ordering data

	Screw connection
	Tension clamp connection
Note	

Type	Depth	Order No.
TBY-ADV151-PS-F-L-2KB-S	95 mm	1397820000
TBY-ADV151-PS-F-L-2KB-Z	95 mm	1397830000

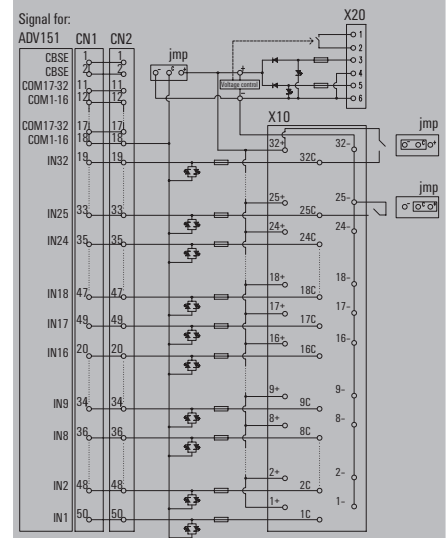

Field terminals view for 1397820000 (ADV151)



Field terminals view for ADV161 (Channels 33 to 64)

TBY-CS3000 Input/Output interfaces for CS3000 digital cards

- Interface for Centum ADV151 32 digital input card
- 2 AKB connectors (50 poles) for redundancy
- 100 mA fuse per channel
- Green LED shows relays switching status (control side).
- Red LED shows fuse blow
- The input sensors can be connected in 2 ways:
 - Powered by field terminals
 - Powered by the TBY with auxiliary voltage
- Monotization of the Power supply status with green LED and alarm contact (24 V DC / 2...100 mA): close contact and led shining means no supply fault.
- Screw and tension clamp connection

TBY-ADV151-24-PS-2KB

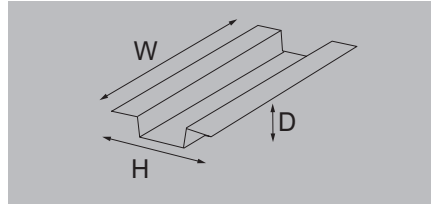

Technical data

Connected to	Connection to the card
Connection data and functionality	Connection on control side
	Relay type
	Power supply fuse
Nominal input data	
	Input voltage
	Input current
	Operating voltage (supply)
	Operating current (supply)
Nominal output data	
	Contact material
	Operating voltage
	Max. DC continuous current of the I/O card
	Minimum contact current
	Minimum contact voltage
	Mechanical service life
General data	
	Ambient temperature (operational)
	Storage temperature
Insulation coordination (EN50178)	
	Rated input insulation voltage
	Rated output insulation voltage
	Overvoltage category input/output
	Overvoltage category input/input
	Overvoltage category output/output
	Pollution severity level
	Pulse voltage test (1,2/50µs)
	Insulation test voltage
	Clearance input/output
Dimensions	
	Clamping range, min./max.
	Clamping range, min./max.
	Rail
	Width / Height
Note	

Ordering data

	Screw connection
	Tension clamp connection
Note	

ADV151, ADV161 (2 TBY by Card)	
2 x AKB (50P)	
RSS	
1 A	
24 V DC ± 10%	
7 mA (fuse on) / 0.5 mA (fuse off)	
24 V DC	
1 A	
AgNi gold-plated	
18 ... 26,4 V DC	
10 mA	
1 mA	
1 V	
5 x 10 ⁶ switching cycles	
-25...70 °C	
-40...85 °C	
≤ 50 V DC	
≤ 50 V DC	
III	
III	
III	
2	
1.5 kV	
0.35 kVAC	
≥ 5.5 mm	
Screw connection	Tension-clamp connection
0.13 mm ² / 6 mm ²	0.13 mm ² / 2.5 mm ²
0.13 mm ² / 6 mm ²	0.13 mm ² / 2.5 mm ²
TS 35, TS 32	TS 35, TS 32
317 mm / 131 mm	317 mm / 131 mm

Type	Depth	Order No.
TBY-ADV151-24-PS-2KB-S	95 mm	1384330000
TBY-ADV151-24-PS-2KB-Z	95 mm	1384320000

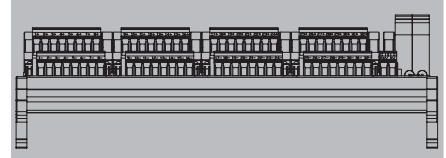
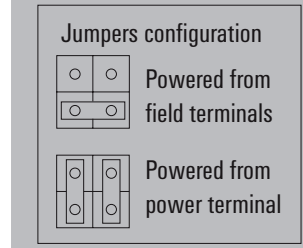
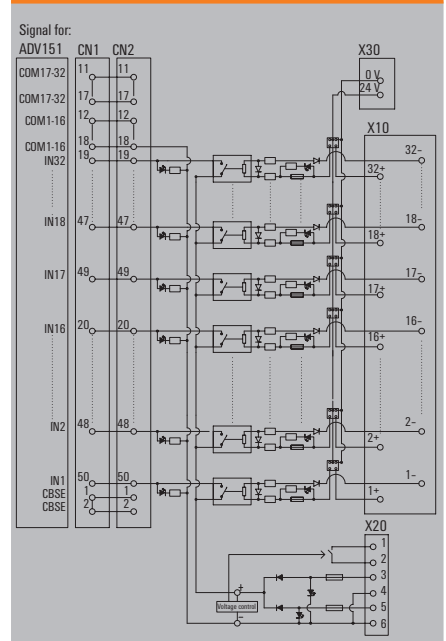

Field terminals view 1384330000 (ADV 151)

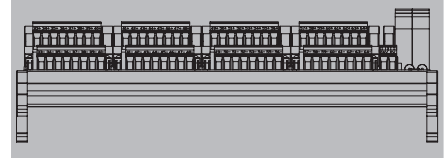

Field terminals view for ADV161 (Channels 33 to 64)

Yokogawa CS3000 – TBY Input/Output interfaces for CS3000

TBY-CS3000 Input/Output interfaces for CS3000 digital cards

Interface for Centum ADV151 32 digital input card

- 2 AKB connectors (50 poles) for redundancy
- 100 mA fuse per channel
- Green LED shows relays switching status (control side).
- Red LED shows fuse blow
- The input sensors can be connected in 2 ways:
 - Powered by field terminals
 - Powered by the TBY with auxiliary voltage
- Dual power supply can be connected to the TBY to supply sensors and Yokogawa Card.
- Monotorization of the Power supply status with green LED and alarm contact (24 V DC / 2...100 mA): close contact and led shinning means no supply fault.
- Screw and tension clamp connection

TBY-ADV151-48-PS-2KB

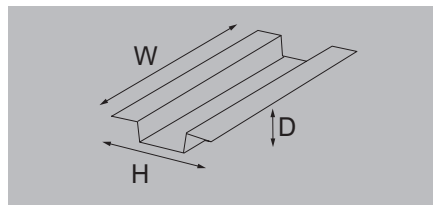

Technical data

Connected to	Connection to the card
Connection data and functionality	Connection on control side Relay type Power supply fuse
Nominal input data	Input voltage Input current Operating voltage (supply) Operating current (supply)
Nominal output data	Contact material Operating voltage Max. DC continuous current of the I/O card Minimum contact current Minimum contact voltage Mechanical service life
General data	Ambient temperature (operational) Storage temperature
Insulation coordination (EN50178)	Rated input insulation voltage Rated output insulation voltage Overvoltage category input/output Overvoltage category input/input Overvoltage category output/output Pollution severity level Pulse voltage test (1,2/50µs) Insulation test voltage Clearance input/output
Dimensions	Clamping range, min./max. Clamping range, min./max. Rail Width / Height
Note	

ADV151, ADV161 (2 TBY by Card)	
2 x AKB (50P)	
RSS	
1 A	
48 V DC ± 10%	
7 mA (fuse on) / 0.5 mA (fuse off)	
24 V DC	
1 A	
AgNi gold-plated	
18 ... 26,4 V DC	
10 mA	
1 mA	
1 V	
5 x 10 ⁶ switching cycles	
-25...70 °C	
-40...85 °C	
≤ 50 V DC	
≤ 50 V DC	
III	
III	
III	
2	
1.5 kV	
0.35 kVAC	
≥ 5.5 mm	
Screw connection	Tension-clamp connection
0.13 mm ² / 6 mm ²	0.13 mm ² / 2.5 mm ²
0.13 mm ² / 6 mm ²	0.13 mm ² / 2.5 mm ²
TS 35, TS 32	TS 35, TS 32
317 mm / 131 mm	317 mm / 131 mm

Ordering data

	Screw connection
	Tension clamp connection
Note	

Type	Depth	Order No.
TBY-ADV151-48-PS-2KB-S	95 mm	1384280000
TBY-ADV151-48-PS-2KB-Z	95 mm	1384250000

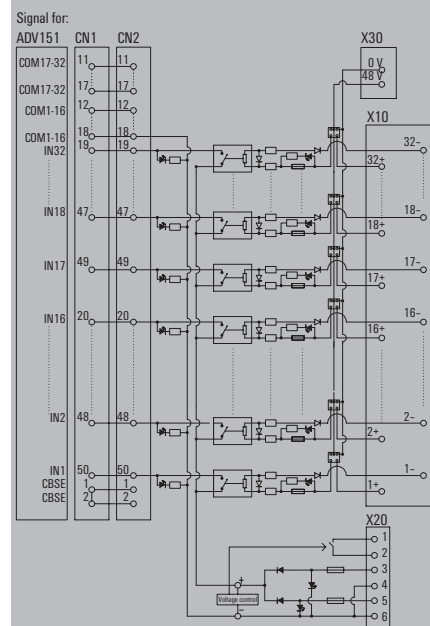

Jumpers configuration

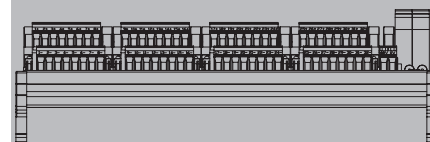
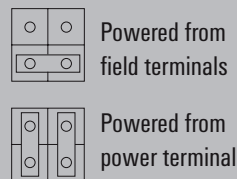

Field terminals view 1324280000 (ADV 151)

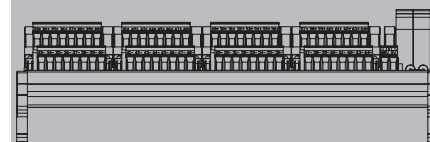

Field terminals view for ADV161 (Channels 33 to 64)

TBY-CS3000 Input/Output interfaces for CS3000 digital cards

Interface for Centum ADV551 32 digital output Card

- 2 AKB connectors (50 poles) for redundancy
- Green LED shows relays switching status (control side).
- The output sensors can be connected in 2 ways:
 - Powered by field terminals
 - Powered by the TBY with auxiliary voltage (groups of 8 channels)
- Monitorization of the Power supply status with green LED and alarm contact (24 V DC / 2...100 mA): close contact and led shining means no supply fault.
- Screw and tension clamp connection

TBY-ADV551-CF-PS-2KB

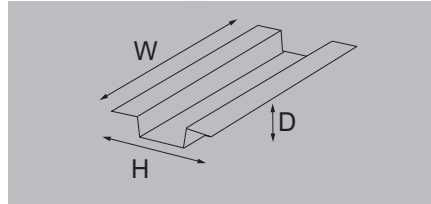
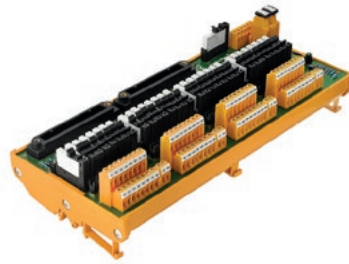

Technical data

Connected to	Connection to the card
Connection data and functionality	Connection on control side
	Relay type
	Fuse per channel
	Power supply fuse
Nominal input data	
	Input voltage
	Input current
	Operating voltage (supply)
	Operating current (supply)
Nominal output data	
	Contact material
	Operating voltage
	Max. AC continuous current
	Minimum contact current
	Minimum contact voltage
	Mechanical service life
General data	
	Ambient temperature (operational)
	Storage temperature
Insulation coordination (EN50178)	
	Rated input insulation voltage
	Rated output insulation voltage
	Overvoltage category input/output
	Overvoltage category input/input
	Overvoltage category output/output
	Pollution severity level
	Pulse voltage test (1,2/50µs)
	Insulation test voltage
	Clearance input/output
Dimensions	
	Clamping range, min./max.
	Clamping range, min./max.
	Rail
	Width / Height
Note	

ADV551, ADV561 (2 TBY by Card)	
2 x AKB (50P)	
RSS	
No	
1 A	
24 V DC ± 10%	
13 mA	
24 V DC	
1 A	
AgNi 90/10	
250 V AC	
2.5 A	
0.1 A	
5 V	
5 x 10 ⁶ switching cycles	
-25...70 °C	
-40...85 °C	
≤ 50 V DC	
250 V AC	
III	
II	
II	
2	
6 kV	
1.2 kVAC	
≥ 5.5 mm	
Screw connection	Tension-clamp connection
0.13 mm ² / 6 mm ²	0.13 mm ² / 2.5 mm ²
0.13 mm ² / 6 mm ²	0.13 mm ² / 2.5 mm ²
TS 35, TS 32	TS 35, TS 32
303 mm / 131 mm	303 mm / 131 mm

Ordering data

	Screw connection
	Tension clamp connection
Note	

Type	Depth	Order No.
TBY-ADV551-CF-PS-2KB-S	80 mm	1379500000
TBY-ADV551-CF-PS-2KB-Z	80 mm	1379510000

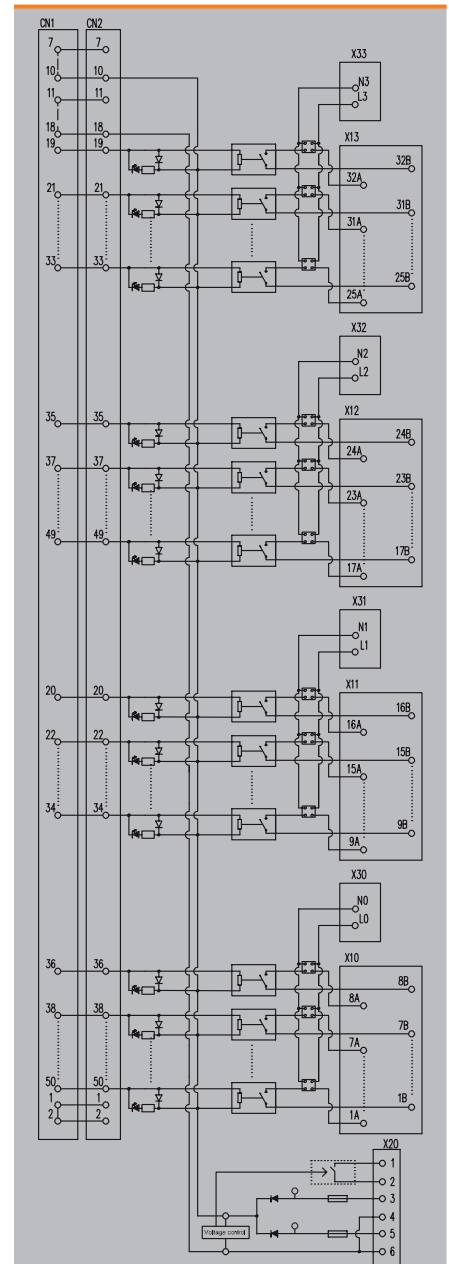

Jumpers configuration

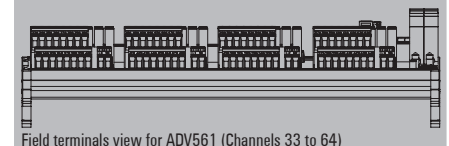
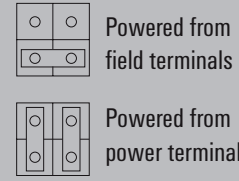

The following selection guides enable you to quickly and easily choose the correct products according to your application needs:

STEP 1: Choose the Yokogawa Card to be used.

STEP 2: Choose the most suitable interface for the application.

Example: For SAI143 it's possible to select different options:

* In screw: 1371130000,1371150000,1371220000,1371340000,1371240000

* In tension clamp: 1371140000,1371170000,1371230000,1371250000

This is small selection of the most frequently used termination boards. Other termination boards are also available. G3 termination boards can also be provided under demand.

Yokogawa Pro Safe – Selection guide

STEP 1		STEP 2											
Yokogawa Card		TBY (Weidmüller Interfaces for Yokogawa)											
Kind of Card	Card	Kind of connector	Redundancy Power supply	Fuses per channel	Disconnect + Test points	Forks for components	Led channel	Led fuse	Relay	Type	Order No. Screw	Order No. Tension clamp	Page
16 analogue current input	SAI143	KS								TBY-RS-AIO-2KS	1371130000	1371140000	C.18
		KS								TBY-SAI143-2KS	1371150000	1371170000	C.18
		KS			↔					TBY-RS-AIO4-2KS	1371220000	1371230000	C.20
		KS				Y				TBY-RS-UNIV-SP-2KS	1371340000	1371370000	C.21
		KS	6,3 A	1 A				Yes		TBY-SAI143-FL-PS-2KS	1371240000	1371250000	C.22
8 analogue current output	SAI533	KS								TBY-RS-AIO-2KS	1371130000	1371140000	C.18
		KS								TBY-SAI533-2KS	1371200000	1371210000	C.18
		KS			↔					TBY-RS-AIO4-2KS	1371220000	1371230000	C.20
		KS				Y				TBY-RS-UNIV-SP-2KS	1371340000	1371370000	C.21
16 analogue voltage input	SAV144	KS								TBY-RS-AIO-2KS	1371130000	1371140000	C.18
		KS								TBY-SAV144-2KS	1371180000	1371190000	C.18
		KS			↔					TBY-RS-AIO4-2KS	1371220000	1371230000	C.20
		KS				Y				TBY-RS-UNIV-SP-2KS	1371340000	1371370000	C.21
16 digital input	SDV144	AKB	2 A							TBY-SDV144-PS-2KB	1371390000	1371410000	C.24
		AKB	2 A	100 mA						TBY-SDV144-FPS-2KB	1395370000	1395380000	C.25
		AKB								TBY-RS-DIO-2KB	1371540000	1371570000	C.23
4 digital output	SDV521	AKB							TBY-RS-DIO-2KB	1371540000	1371570000	C.23	
8 digital output	SDV531	AKB							TBY-RS-DIO-2KB	1371540000	1371570000	C.23	
16 digital output	SDV541	AKB							TBY-RS-DIO-2KB	1371540000	1371570000	C.23	

Note:

TBY-RS Input/Output interfaces for ProSafe analogue cards

Interface for 8 or 16 analogue signals (depend on marking)

- 2 KS connectors (40 poles) for redundancy
- Direct connection between the Yokogawa card and the field connectors.
- Basic module also without marking available and markers as accessory for customer flexibility
- Complete modules with marking available
- Screw and tension clamp connection

TBY-

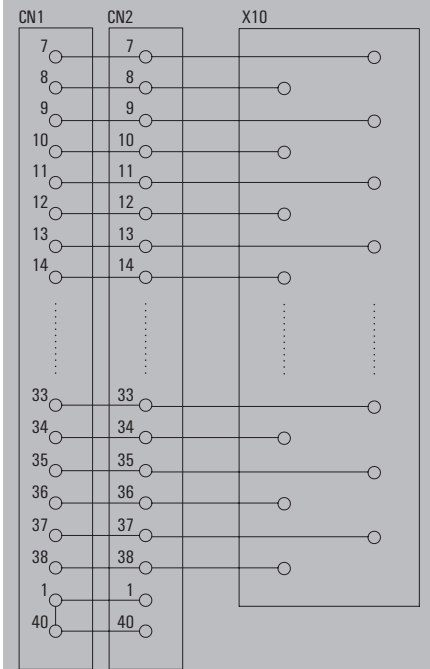
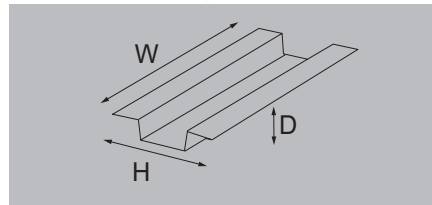

Schematic 1371130000/1371140000

Technical data

Connected to	Connection to the card
Connection data and functionality	Connection on control side LED status display per channel LED status of the supply voltage Fuse per channel Power supply fuse Disconnection per channel Type of test point
Rated data	Operating voltage Max. current per channel Operating voltage (supply) Operating current (supply)
General data	Ambient temperature (operational) Storage temperature
Insulation coordination (EN50178)	Rated insulation voltage Surge voltage category Pollution severity level Insulation test voltage Pulse voltage test (1,2/50µs)
Dimensions	Clamping range, min./max. Clamping range, min./max. Rail Width / Height
Note	

SAI143, SAV144, SAI553	
2 x KS (40P)	
No	
No	
No	
No	
No	
No	
50 V AC / 70 V DC	
1 A	
50 V AC / 70 V DC	
1 A	
-25...70 °C	
-40...85 °C	
< 50 V AC	
III	
2	
0.35 kVAC	
0.8 kV	
Screw connection	Tension-clamp connection
0.13 mm ² / 6 mm ²	0.13 mm ² / 2.5 mm ²
0.13 mm ² / 6 mm ²	0.13 mm ² / 2.5 mm ²
TS 35, TS 32	TS 35, TS 32
90 mm / 70 mm	90 mm / 70 mm

Ordering data

Terminal block for:	SAI143, SAV144, SAI533 without marking (S)
	SAI143, SAV144, SAI533 without marking (Z)
	SAI143 (S)
	SAI143 (Z)
	SAV144 (S)
	SAV144 (Z)
	SAI553 (S)
	SAI553 (Z)
Note	

Type	Depth	Order No.
TBY-RS-AIO-2KS-S	56 mm	1371130000
TBY-RS-AIO-2KS-Z	52 mm	1371140000
TBY-SAI143-2KS-S	56 mm	1371150000
TBY-SAI143-2KS-Z	52 mm	1371170000
TBY-SAV144-2KS-S	56 mm	1371180000
TBY-SAV144-2KS-Z	52 mm	1371190000
TBY-SAI533-2KS-S	56 mm	1371200000
TBY-SAI533-2KS-Z	52 mm	1371210000

S (screw connection), Z (tension-clamp connection)

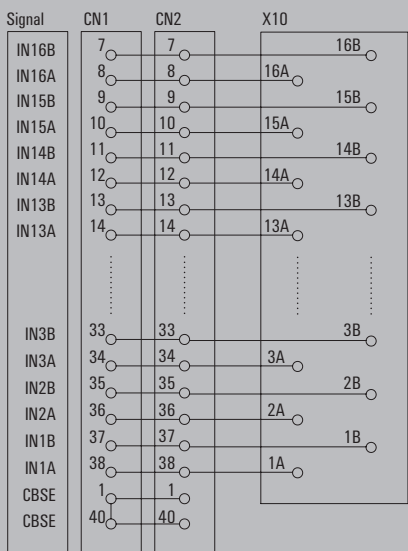

Schematic 1371150000/1371170000 (SAI143)

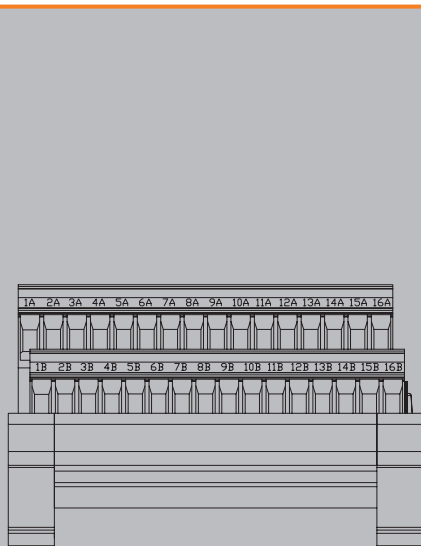

Field terminal view 1371150000

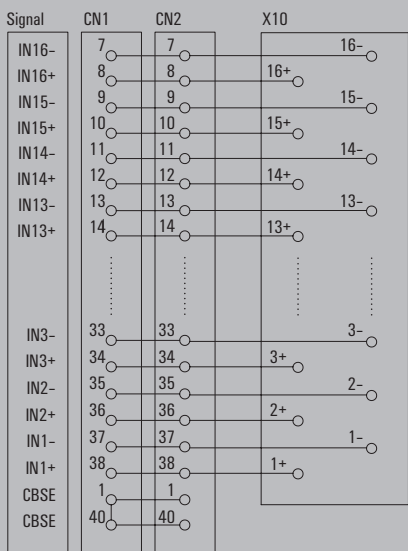

Schematic 1371180000/1371190000 (SAV144)

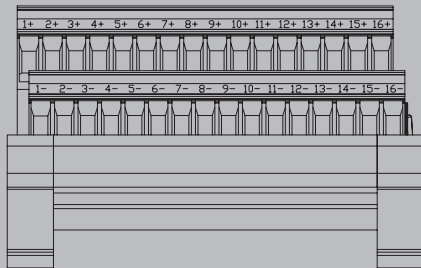

Field terminal view 1371180000

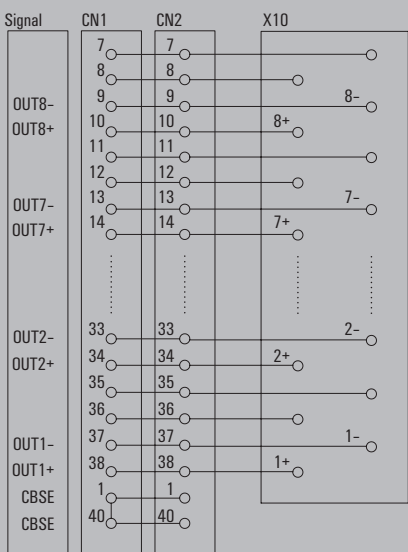

Schematic 1371200000/1371210000 (SAI533)

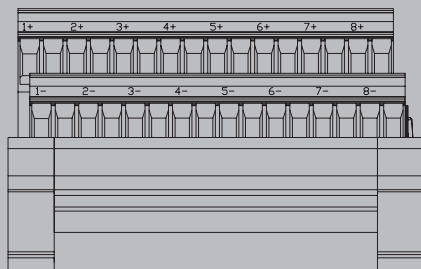

Field terminal view 1371200000

Yokogawa ProSafe - TBY Input/Output interfaces for ProSafe

TBY-RS Input/Output interfaces for ProSafe analogue cards

Interface for 8 or 16 analogue signals

- 2 KS connectors (40 poles) for redundancy
- Disconnecting plugs and test points (2 mm diameter) for voltage or current measurement.
- The TBY is delivered with the marking for SAI143 and it's compatible with cards SAV144 and SAI533. Marker available as accessory.
- Screw and tension clamp connection

TBY-RS-AIO-I-2KS

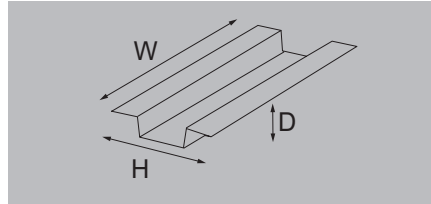

Technical data

Connected to	Connection to the card
Connection data and functionality	Connection on control side LED status display per channel LED status of the supply voltage Fuse per channel Power supply fuse Disconnection per channel Type of test point
Rated data	Operating voltage Max. current per channel Operating voltage (supply) Operating current (supply)
General data	Ambient temperature (operational) Storage temperature
Insulation coordination (EN50178)	Rated insulation voltage Surge voltage category Pollution severity level Insulation test voltage Pulse voltage test (1,2/50µs)
Dimensions	Clamping range, min./max. Clamping range, min./max. Rail Width / Height
Note	

Ordering data

	Screw connection
	Tension clamp connection
Note	

SAI143, SAV144, SAI533	
2 x KS (40P)	
No	
No	
No	
No	
Yes	
Diameter: 2 mm	
50 V AC / 70 V DC	
1 A	
50 V AC / 70 V DC	
1 A	
-25...70 °C	
-40...85 °C	
< 50 V AC	
III	
2	
0.35 kVAC	
0.8 kV	
Screw connection	Tension-clamp connection
0.13 mm ² / 6 mm ²	0.13 mm ² / 2.5 mm ²
0.13 mm ² / 6 mm ²	0.13 mm ² / 2.5 mm ²
TS 35, TS 32	TS 35, TS 32
170 mm / 87 mm	170 mm / 87 mm

Type	Depth	Order No.
TBY-RS-AIO-I-2KS-S	56 mm	1371220000
TBY-RS-AIO-I-2KS-Z	59 mm	1371230000

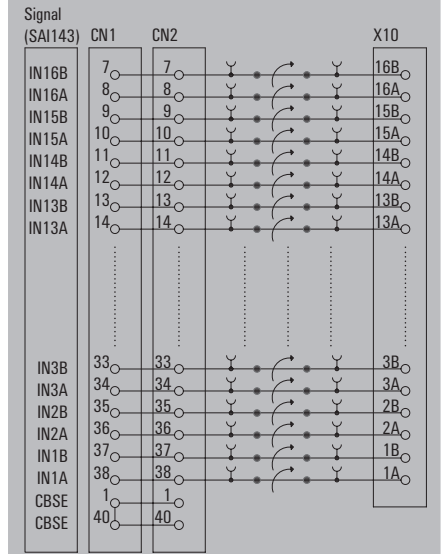

Connection for SAI143

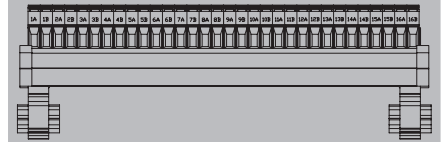

Field terminals view 1371220000

Application note: With the markers showed as accessories, is possible to configure the TBY for other cards

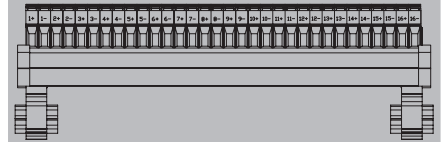

Field terminals view for SAV144

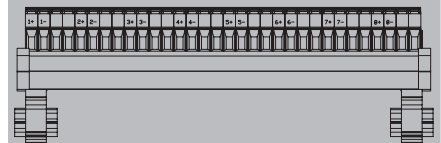

Field terminals view for SAI533

TBY-RS Input/Output interfaces for ProSafe analogue cards

Interface for analogue signals

- 2 KS connectors (40 poles) for redundancy
- Direct connection between the Yokogawa card and the field connectors.
- The soldering tags allows the mounting of external components: voltage conversion or monitorization of the current loop.
- Screw and tension clamp connection

TBY-RS-UNIV-SP-2KS

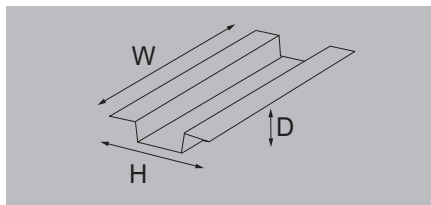

Technical data

Connected to	Connection to the card
Connection data and functionality	Connection on control side LED status display per channel LED status of the supply voltage Fuse per channel Power supply fuse Disconnection per channel Type of test point
Rated data	Operating voltage Max. current per channel Operating voltage (supply) Operating current (supply)
General data	Ambient temperature (operational) Storage temperature
Insulation coordination (EN50178)	Rated insulation voltage Surge voltage category Pollution severity level Insulation test voltage Pulse voltage test (1,2/50µs)
Dimensions	Clamping range, min./max. Clamping range, min./max. Rail Width / Height
Note	

SAI143, SAV144, SAI553	
2 x KS (40P)	
No	
No	
No	
No	
No	
Soldering tags	
50 V AC / 70 V DC	
1 A	
50 V AC / 70 V DC	
1 A	
-25...70 °C	
-40...85 °C	
< 50 V AC	
III	
2	
0.35 kVAC	
0.8 kV	
Screw connection	Tension-clamp connection
0.13 mm ² / 6 mm ²	0.13 mm ² / 2.5 mm ²
0.13 mm ² / 6 mm ²	0.13 mm ² / 2.5 mm ²
TS 35, TS 32	TS 35, TS 32
112 mm / 109 mm	112 mm / 109 mm

Ordering data

	Screw connection
	Tension clamp connection
Note	

Type	Depth	Order No.
TBY-RS-UNIV-SP-2KS-S	70 mm	1371340000
TBY-RS-UNIV-SP-2KS-Z	65 mm	1371370000

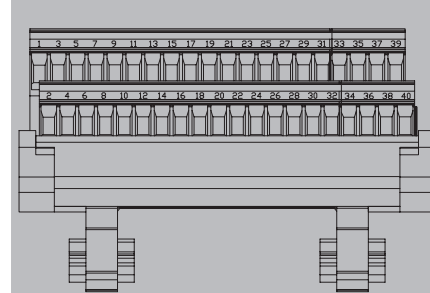
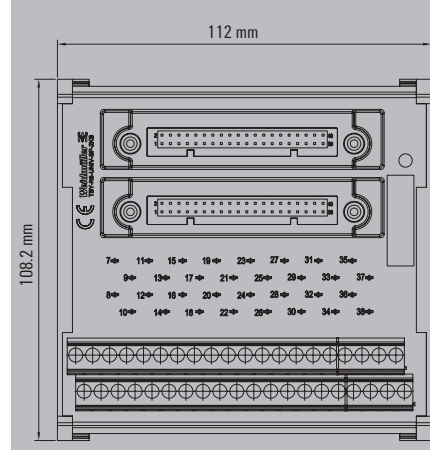
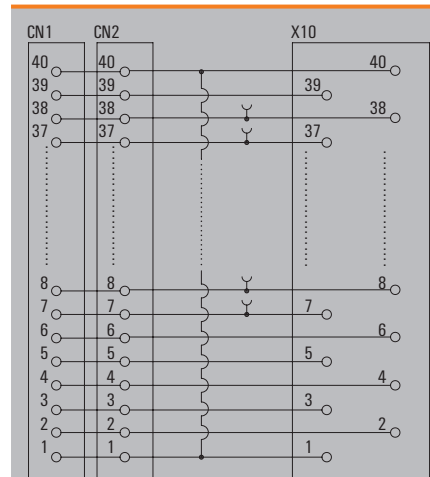

Yokogawa ProSafe - TBY Input/Output interfaces for ProSafe

TBY-RS Input/Output interfaces for ProSafe analogue cards

- Interface for Pro-safe SA143 analogue input Card
- 2 KS connectors (40 poles) for redundancy
 - The input sensors are connected to the card with fuses.
 - Red LED show fuses status
 - Dual power supply can be connected to the TBY to supply sensors and Yokogawa Card.
 - Monotorization of the Power supply status with green LED and alarm contact (24 V DC / 2...100 mA); close contact and led shinning means no supply fault.
 - Screw and tension clamp connection

TBY-SAI143-F-L-PS-2KS

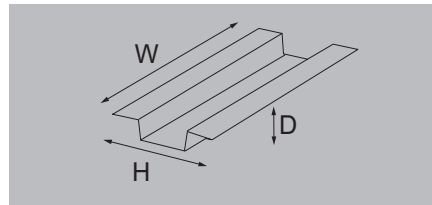

Technical data

Connected to	Connection to the card
Connection data and functionality	Connection on control side LED status display per channel LED status of the supply voltage Fuse per channel Power supply fuse Disconnection per channel Type of test point
Rated data	Operating voltage Max. current per channel Operating voltage (supply) Operating current (supply)
General data	Ambient temperature (operational) Storage temperature
Insulation coordination (EN50178)	Rated insulation voltage Surge voltage category Pollution severity level Insulation test voltage Pulse voltage test (1,2/50µs)
Dimensions	Clamping range, min./max. Clamping range, min./max. Rail Width / Height
Note	

SAI143	
2 x KS (40P)	
red	
green	
1 A	
6.3 A	
No	
No	
24 V DC	
1 A	
24 V DC	
6.3 A	
-25...70 °C	
-40...85 °C	
< 50 V AC	
III	
2	
0.35 kVAC	
0.8 kV	
Screw connection	Tension-clamp connection
0.13 mm ² / 6 mm ²	0.13 mm ² / 2.5 mm ²
0.13 mm ² / 6 mm ²	0.13 mm ² / 2.5 mm ²
TS 35, TS 32	TS 35, TS 32
131 mm / 107 mm	133 mm / 131 mm

Ordering data

Screw connection
Tension clamp connection
Note

Type	Depth	Order No.
TBY-SAI143-F-L-PS-2KS-S		1371240000
TBY-SAI143-F-L-PS-2KS-Z	107 mm	1371250000

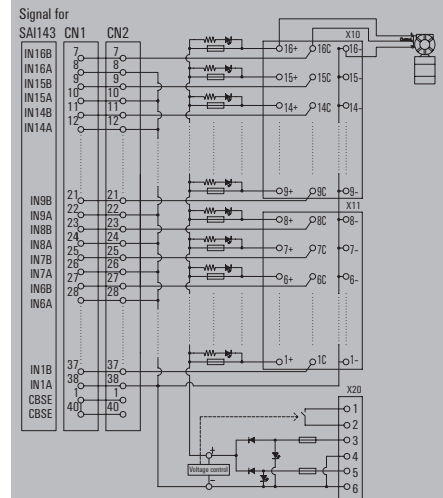

TBY-RS Input/Output interfaces for ProSafe digital cards

Interface for Pro-safe digital Cards

- AKB connectors (50 poles) for redundancy
- Direct connection between the Yokogawa card and the field connectors.
- Screw and tension clamp connection

TBY-RS-DIO-2KB

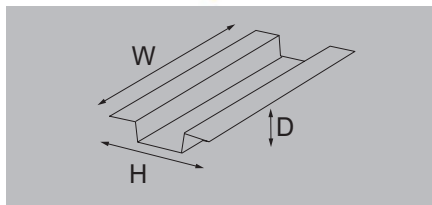

Technical data

Connected to	Connection to the card
Connection data and functionality	Connection on control side LED status display per channel LED status of the supply voltage Fuse per channel Power supply fuse Disconnection per channel Type of test point
Rated data	Operating voltage Max. current per channel Operating voltage (supply) Operating current (supply)
General data	Ambient temperature (operational) Storage temperature
Insulation coordination (EN50178)	Rated insulation voltage Surge voltage category Pollution severity level Insulation test voltage Pulse voltage test (1,2/50µs)
Dimensions	Clamping range, min./max. Clamping range, min./max. Rail Width / Height
Note	

SDV144, SDV521, SDV531, SDV541	
2 x AKB (50P)	
No	
No	
No	
No	
No	
No	
50 V AC / 70 V DC	
1 A	
50 V AC / 70 V DC	
1 A	
-25...70 °C	
-40...85 °C	
< 50 V AC	
III	
2	
0.35 kVAC	
0.8 kV	
Screw connection	Tension-clamp connection
0.13 mm ² / 6 mm ²	0.13 mm ² / 2.5 mm ²
0.13 mm ² / 6 mm ²	0.13 mm ² / 2.5 mm ²
TS 35, TS 32	TS 35, TS 32
135 mm / 70 mm	135 mm / 70 mm

Ordering data

Screw connection
Tension clamp connection
Note

Type	Depth	Order No.
TBY-RS-DIO-2KB-S	56 mm	1371540000
TBY-RS-DIO-2KB-Z	52 mm	1371570000

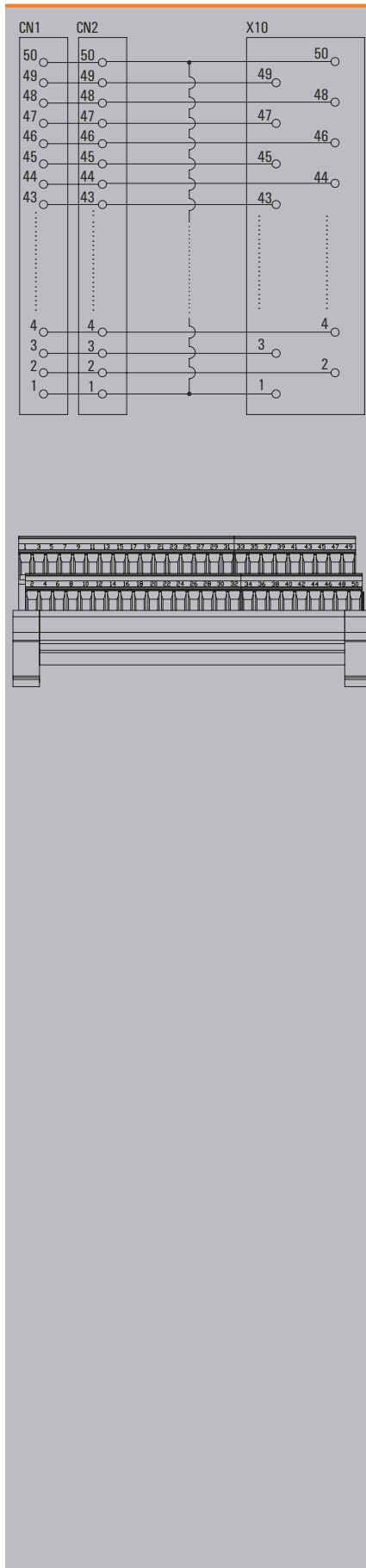

TBY-RS Input/Output interfaces for ProSafe digital cards

- Interface for Pro-safe SDV144 digital input Card
- 2 AKB connectors (50 poles) for redundancy
 - Dual power supply can be connected to the TBY to supply sensors and Yokogawa Card.
 - Monotorization of the Power supply status with green LED and alarm contact (24 V DC / 2...100 mA); close contact and led shining means no supply fault.
 - Screw and tension clamp connection

TBY-SDV144-PS-2KB

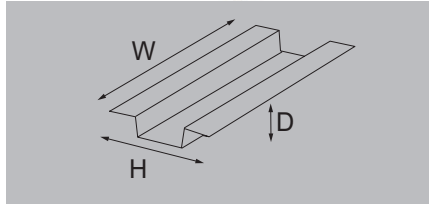
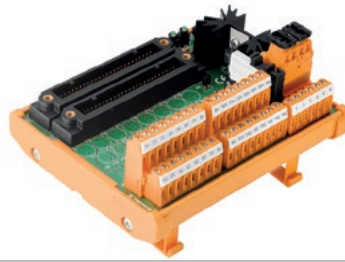

Technical data

Connected to	Connection to the card
Connection data and functionality	Connection on control side LED status display per channel LED status of the supply voltage Fuse per channel Power supply fuse Disconnection per channel Type of test point
Rated data	Operating voltage Max. current per channel Operating voltage (supply) Operating current (supply)
General data	Ambient temperature (operational) Storage temperature
Insulation coordination (EN50178)	Rated insulation voltage Surge voltage category Pollution severity level Insulation test voltage Pulse voltage test (1,2/50µs)
Dimensions	Clamping range, min./max. Clamping range, min./max. Rail Width / Height
Note	

SDV144	
2 x AKB (50P)	
No	
green	
No	
2 A	
No	
No	
24 V DC	
1 A	
24 V DC	
2 A	
< 50 V AC	
III	
2	
0.35 kVAC	
0.8 kV	
Screw connection	Tension-clamp connection
0.13 mm ² / 6 mm ²	0.13 mm ² / 2.5 mm ²
0.13 mm ² / 6 mm ²	0.13 mm ² / 2.5 mm ²
TS 35, TS 32	TS 35, TS 32
134 mm / 109 mm	134 mm / 109 mm

Ordering data

	Screw connection
	Tension clamp connection
Note	

Type	Depth	Order No.
TBY-SDV144-PS-2KB-S	80 mm	1371390000
TBY-SDV144-PS-2KB-Z	80 mm	1371410000

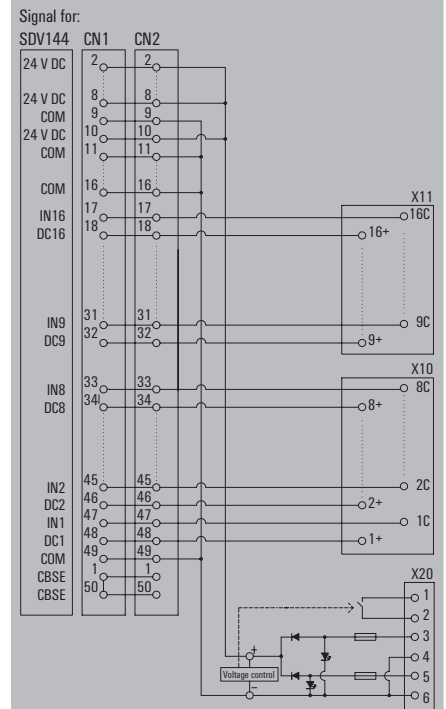

TBY-RS Input/Output interfaces for ProSafe digital cards

- Interface for Pro-safe SDV144 digital input Card
- 2 AKB connectors (50 poles) for redundancy
- The input sensors are connected to the card with fuses.
- Dual power supply can be connected to the TBY to supply sensors and Yokogawa Card.
- Monotorization of the Power supply status with green LED and alarm contact (24 V DC / 2...100 mA).

TBY-SDV144-F-PS-2KB

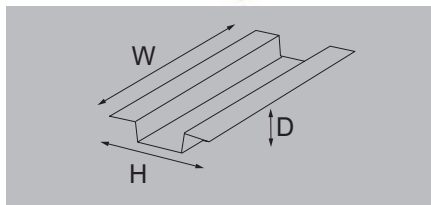
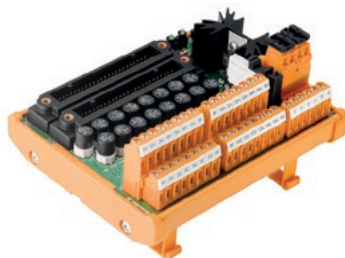

Technical data

Connected to	Connection to the card
Connection data and functionality	Connection on control side LED status display per channel LED status of the supply voltage Fuse per channel Power supply fuse Disconnection per channel Type of test point
Rated data	Operating voltage Max. current per channel Operating voltage (supply) Operating current (supply)
General data	Ambient temperature (operational) Storage temperature
Insulation coordination (EN50178)	Rated insulation voltage Surge voltage category Pollution severity level Insulation test voltage Pulse voltage test (1,2/50µs)
Dimensions	Clamping range, min./max. Clamping range, min./max. Rail Width / Height
Note	

SDV144, SDV521, SDV531, SDV541	
2 x AKB (50P)	
No	
green	
100 mA	
2 A	
No	
No	
24 V DC	
1 A	
24 V DC	
1 A	
-25...70 °C	
-40...85 °C	
< 50 V AC	
III	
2	
0.35 kVAC	
0.8 kV	
Screw connection	Tension-clamp connection
0.13 mm ² / 6 mm ²	0.13 mm ² / 2.5 mm ²
0.13 mm ² / 6 mm ²	0.13 mm ² / 2.5 mm ²
TS 35, TS 32	TS 35, TS 32
134 mm / 109 mm	134 mm / 109 mm

Ordering data

Screw connection
Tension clamp connection
Note

Type	Depth	Order No.
TBY-SDV144-F-PS-2KB-S	80 mm	1395370000
TBY-SDV144-F-PS-2KB-Z	80 mm	1395380000

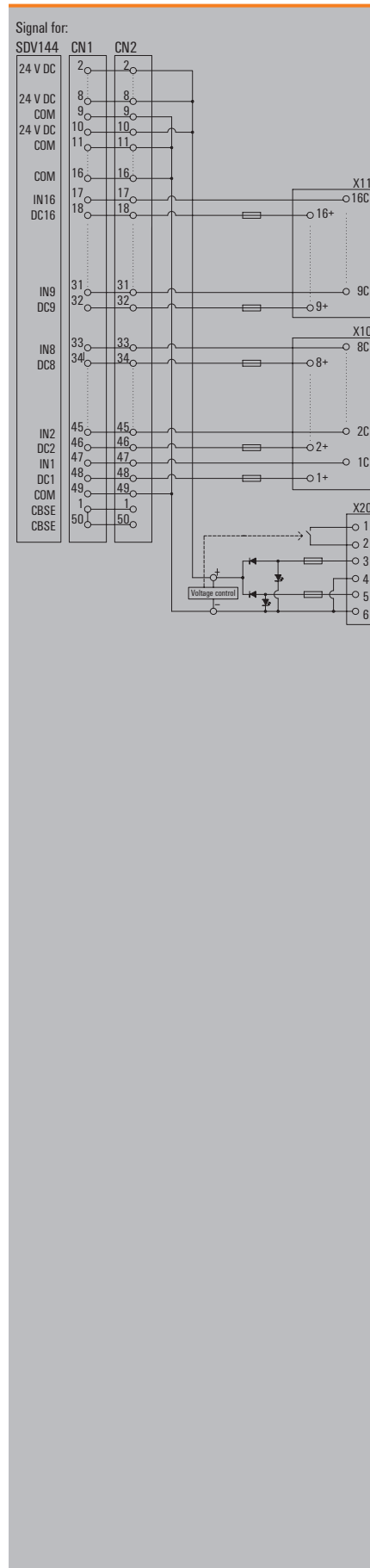

MIL cables

PAC-YOK - MIL Pre-made cables

Pre-built cable according:

- MIL connector - MIL connector
- MIL connector - ferrules
- Colour code according DIN47100

PAC-YOK-MIL-F

MIL connector to ferrules



PAC-YOK-MIL-V0

MIL connector to MIL connector

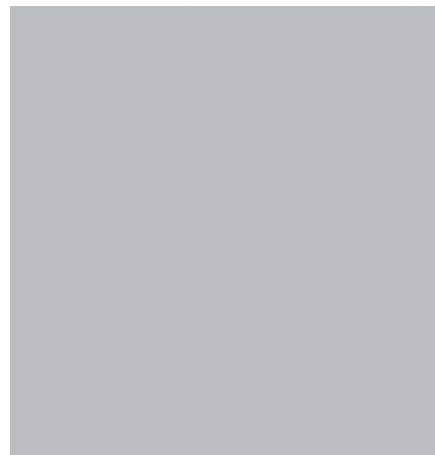
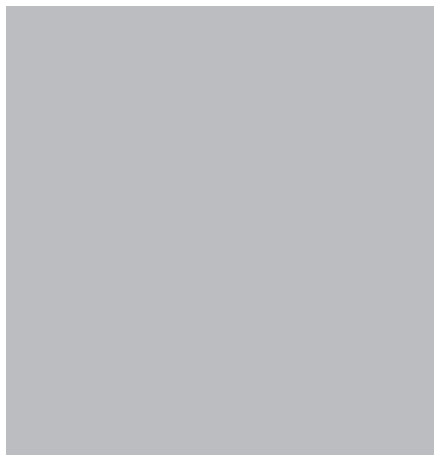
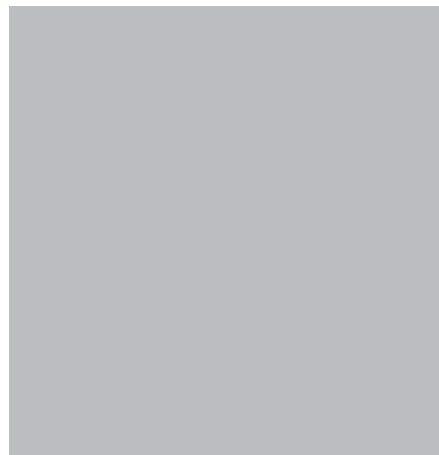

Technical data

Rated data	
Rated voltage	$\leq 60 \text{ Vdc} \leq 25 \text{ Vac}$
Permissible current strength per path, max.	1 A
Total current, max.	3 A
Resistance	$\leq 150 \text{ m}\Omega/\text{m}$
Capacity wire / wires	300 pF/m
Capacity wire / shield	300 pF/m
Nominal rating, control cable	
Cable	Cable LiYY
Material	PVC
Wire cross-section	0.14 mm ²
General data	
Ambient temperature (operational)	-10...50 °C
Storage temperature	-10...60 °C

Rated data	
Rated voltage	$\leq 60 \text{ Vdc} \leq 25 \text{ Vac}$
Permissible current strength per path, max.	1 A
Total current, max.	3 A
Resistance	$\leq 150 \text{ m}\Omega/\text{m}$
Capacity wire / wires	300 pF/m
Capacity wire / shield	300 pF/m
Nominal rating, control cable	
Cable	Cable LiYY
Material	PVC
Wire cross-section	0.14 mm ²
General data	
Ambient temperature (operational)	-10...50 °C
Storage temperature	-10...60 °C

Rated data	
Rated voltage	$\leq 60 \text{ Vdc} \leq 25 \text{ Vac}$
Permissible current strength per path, max.	1 A
Total current, max.	3 A
Resistance	$\leq 150 \text{ m}\Omega/\text{m}$
Capacity wire / wires	300 pF/m
Capacity wire / shield	300 pF/m
Nominal rating, control cable	
Cable	Cable LiYCY
Material	PVC
Wire cross-section	0.14 mm ²
General data	
Ambient temperature (operational)	-10...50 °C
Storage temperature	-10...60 °C

Note

--

--

Ordering data

	40-pole connector
	50-pole connector

Type	Qty.	Order No.
PAC-YOK-MIL40-F-1M	1	2420520010
PAC-YOK-MIL50-F-1M	1	2420530010

Type	Qty.	Order No.
PAC-YOK-MIL40-V0-1M	1	1536840010
PAC-YOK-MIL50-V0-1M	1	1536820010

Note

The last 3 digits of the cable code indicate its length. For example, if the code ends in 100, the cable is 10 m long.

The last 3 digits of the cable code indicate its length. For example, if the code ends in 100, the cable is 10 m long.

Accessories

Note

--

--

Connect DCS and PLS systems quickly and reliably

Backplane systems for integrating electronic components

C

The highly complex connections between DCS, PLC and other electrical components need to be wired as efficiently as possible. In some cases, additional functions also need to be integrated without taking up more space.

Backplane systems allow various electrical components, such as SIL relays or analogue converters, to be connected quickly and conveniently. This speeds up the installation and vastly simplifies the connection to the PLC or DCS.

The reinforced circuit board of our backplane allows various electrical components to be accommodated and makes it easier to add individual extra functions in a confined space. Certified pre-mounted cables simplify the connection to the DCS system and improve efficiency.



Backplane systems can help facilitate installation and wiring in the process industry - particularly when a large number of components need to be connected.

Your special advantages:

Simple integration of electrical equipment and components

Save time and costs: backplane systems simplify the installation and wiring of complex circuits and process systems. Using pre-mounted cables during installation can also effectively minimise incorrect wiring.

Integration of additional functions

If required, functions such as power supply alarms, diagnostic functions or HART connectivity can be integrated in the backplane without taking up extra space.



Fast and simple installation

Rigid printed circuit boards in combination with MTA mounting adapters for DIN rails ensure a robust system in the control cabinet.

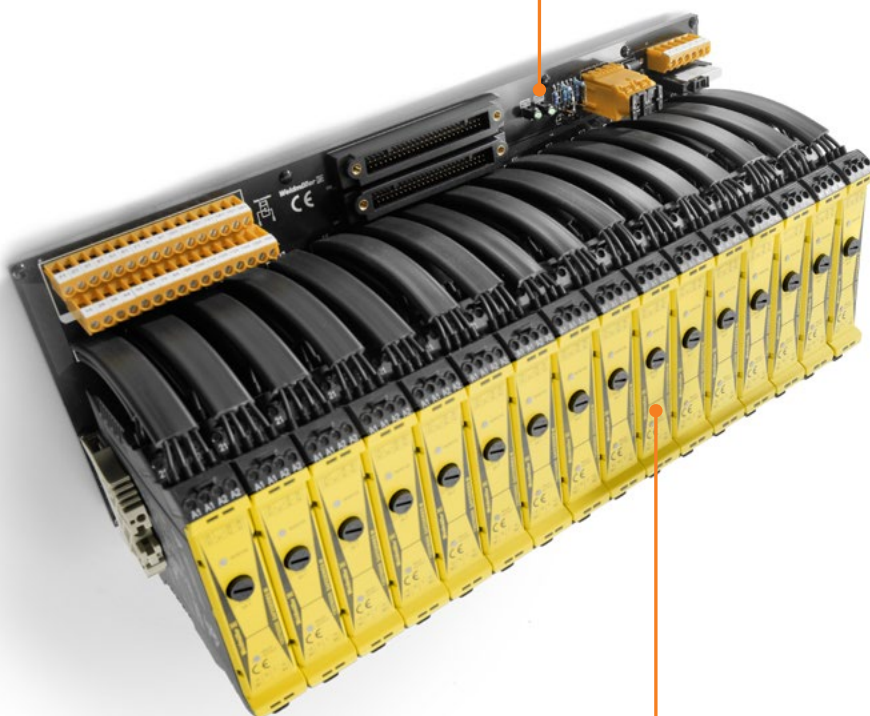

Universally usable system

The system can be combined with all major commercial PLC models according to customer requirements, including Yokogawa, Honeywell, Invensys, Emerson and Siemens.



Pre-mounted cables

Pre-mounted cables ensure error-free connections between the backplane and PLC/DCS system, and are available in a variety of lengths.



High compatibility

Thanks to clip-fit fixing to the DIN rail, modules and components can be installed, replaced and customised quickly and easily.



Yokogawa backplane – SIL Backplane for digital outputs

Backplane with SIL 3 relays for Yokogawa Prosafe SDV541

- 2 AKB connectors (50 poles) for redundancy
- Green LED indicator for relay switching status
- Monitoring the power supply status with green LED and alarm contact (24 V DC / 2 - 100 mA): close contact and LED lit means no supply fault
- 2 versions: de-energised to safe SIL relays with and without monitor
- Screw connection

BKP-16DO-SDV541



Technical data

Connected to	Connection to the card
Connection data and functionality	Connection on control side
	Relay type
	Power supply fuse
Input (safety circuit)	
	Rated control voltage
	Power consumption
	Guaranteed current consumption of 24 VDC -10%
	Status indicator
Output (safety circuit)	
	Base material of the contact / Contact design
	max. permitted switching voltage
	max. permitted switching current
	max. switching current, internal fuse
	max. switching current, external fuse
	Switching capacity, min./max.
	Internal fuse
	Short-circuit-proof
	Switch-on time / Switch-off time
General data	
	Ambient temperature (operational)
	Storage temperature
Insulation coordination	
	Rated input insulation voltage
	Rated output insulation voltage
	Overtoltage category input/output
	Overtoltage category input/input
	Overtoltage category output/output
	Pollution severity level
	Pulse voltage test (1,2/50µs)
	Insulation test voltage
	Clearance input/output
Dimensions	
	Clamping range, min./max.
	Clamping range, min./max.
	Rail
	Width / Height
Note	

SDV541	
2 x AKB (50P)	
SIL3	
2 A	
24 V DC ± 20%	
42 mA	
35 mA	
LED yellow	
AgNi 0.15 gold flashed / NO contact	
250 V AC / 30 V DC	
8 A	
5 A (refer to derating curve)	
5 A (refer to derating curve)	
12 V / 10 mA / 2000 VA	
5 A time-lag	
No	
typ. 7 ms / typ. 14 ms	
-25...50 °C	
-40...85 °C	
50 V AC / 70 V DC	
< 300 V AC	
III	
III	
III	
2	
6 kV	
1.2 kVAC	
≥ 5.5 mm	
Screw connection	
0.13 mm ² / 2.5 mm ²	
0.13 mm ² / 6 mm ²	
TS 35	
376 mm / 168 mm	
For more technical data about SIL relays 1303890000 and 1303760000 check catalog.weidmuller.com	

Ordering data

Potential-free for SIL3 relay without monitoring
Potential-free for SIL3 relay with monitoring
Note

Accessories

G-fuse cartridge, 5 x 20 mm (IEC 60127-2)	2#00 A fast
SIL relay without monitoring	
SIL relay with monitoring	
Relay (for alarm)	
Note	

Type	Depth	Order No.
BKP-16DO-SDV541-V0-S	125 mm	2461730000
BKP-16DO-SDV541-V1-S	125 mm	2436230000

Type	Qty.	Order No.
G 20/2.00A/F	10	0430900000
SCS 24VDC P1SIL3DS	1	1303890000
SCS 24VDC P1SIL3DS M	1	1303760000
RSS112024	20	4061590000

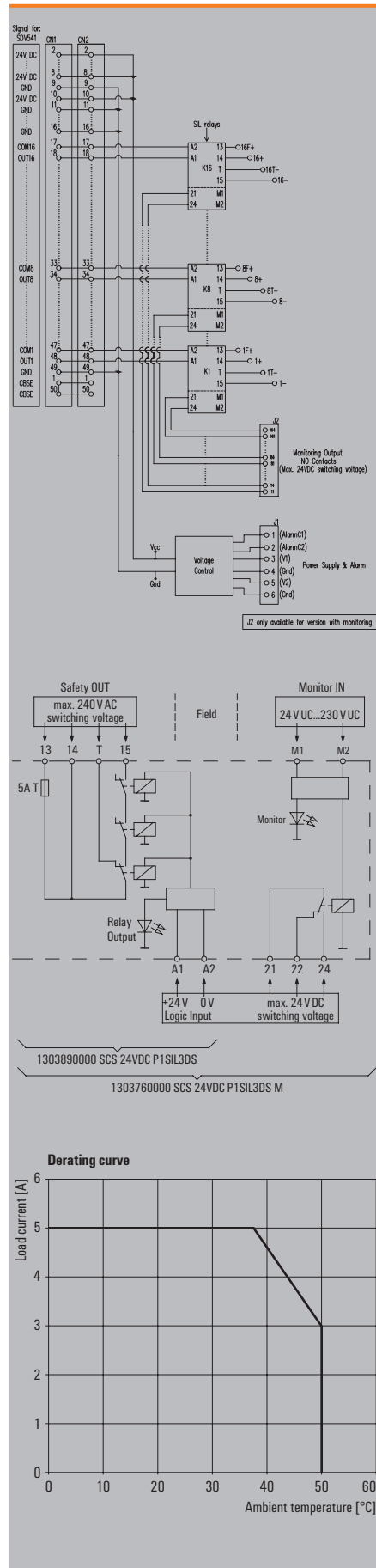

Passive interfaces for general applications

Passive interfaces for general applications	Introduction	D.2
	RS F - Interface for flat cable in accordance with IEC 60603-13 / DIN 41651	D.6
	RS SD - Interface for SUB-D connector in accordance with IEC 60807-2 / DIN 41652	D.8
	RS SD HD - Interface for connector SUB-D high density	D.10
	RS RJ45 - Interfaces with RJ45 connector	D.11
	RS ELCO - Interface with ELCO plug-in connectors	D.12
	RSX - Interface for soldering of components	D.17
	RS VERT - Supply voltage distributor modules	D.18
	RSD - Interfaces with diodes	D.21

Passive interfaces for general applications

Due to the need for cost reductions in the construction of electric cabinets, our interfaces for general applications offer an alternative to end-to-end wiring concepts. Their main function is as an adapter to enable a functional and safe operation between standard plug-in connectors connected to any controller or PLC, and printed circuit terminals connected to application sensors/activators.

Weidmüller's universal interfaces for applications have the following individual features:

- Extruded profile for inserting the PCB
- End plates for fitting on the mounting rail
- Clip-on feet for locking on standardised mounting rails TS 32 and TS 35
- Printed circuit board where the following elements can be identified:
 - Plug-in connectors
 - Weidmüller terminals for screw or tension clamp connection
 - Markings

The plug-in connectors used for interconnection can be divided into the following groups:

- Ribbon cable connector in accordance with IEC 60603-13/DIN 41651 (RSF)
- Miniature SUB-D plug-in connectors acc. to IEC 60807-2/DIN 41652
- RJ45 connectors for data lines
- Plug-in ELCO connectors for applications in high-demand industrial areas.

Pre-assembled cables with the corresponding plug-in connector systems are used in the connection between the controller and the interface. These pre-assembled cables allow maximum savings for the user, as they achieve a cost reduction in the materials, due to fewer individual cables, conductors and cable ducting.

Advantages of the interface units:

- Space savings thanks to the 2 and 3 floor interface terminals.
- Conventional end-to-end wiring is only needed on one side, therefore assembly and start-up times are reduced.
- Greater safety, preventing wiring errors
- Simplified setup and documentation

RS F – Interface for ribbon cable in accordance with IEC 60603-13/ DIN 41651

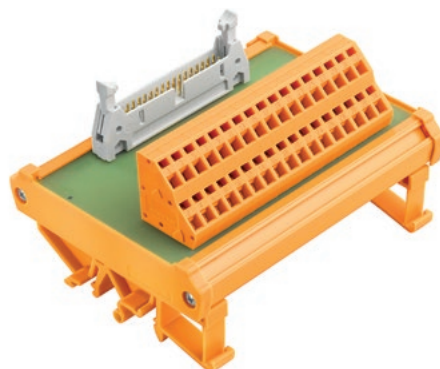

Passive interfaces for transmitting signals from a plug-in flat cable connector, based on IEC 60603-13 / DIN 41651, to a tension clamp or screw connection.

Connection between both connectors is 1 to 1 and the range includes male connectors with between 10 and 64-poles.

RS SD – Interface for connector SUB-D in accordance with IEC 60807-2/ DIN 41652

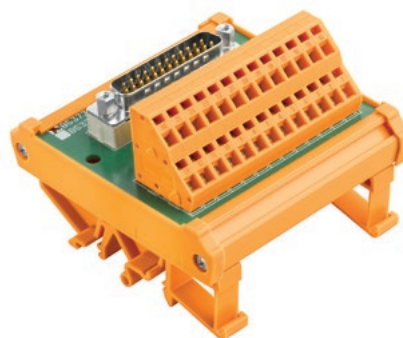

Passive interfaces for transmitting signals from a plug-in SUB-D connector based on IEC 60807-2 / DIN 41652, to a tension clamp connection or screw connection.

Thanks to the metal casing of the SUB-D these connectors are ideal for transmitting analogue signals or for connection with shielded cables.

Connection between both connectors is 1 to 1 and the range includes male and female connectors with between 9 and 50-poles.

Sub-d High density 15,26,44 and 62 poles also available in screw connection.

RS RJ45 - Interfaces with RJ45 connector

Passive interfaces transport signals from a modem, router, computer or any other communications equipment using RJ45 connectors to screw or tension clamp connections.

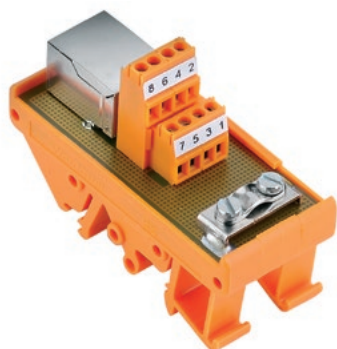

The modules can be fixed to standard TS32 and/or TS35 mounting rails.

RS ELCO – Interface with ELCO plug-in connectors

Passive interfaces that transport signals proceeding from a 20 to 90-pole male/female ELCO plug-in connector to screw or tension clamp connection techniques.

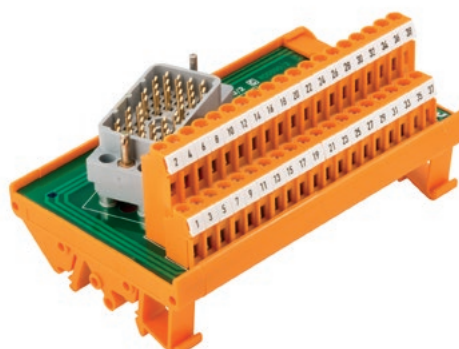

The ELCO connectors are used, for example, in electric power stations, refineries and in different processing applications in which a robust, reliable connection is needed for a large number of signals. The main feature of an ELCO connector is its reliability thanks to its hermaphrodite contact, which is shaped like a fork.

The diagonal disposition of the connector (from right to left) facilitates the wiring of the cables in the electrical cabinet and avoids them from crossing one other.

RSX – Interface for soldering of components

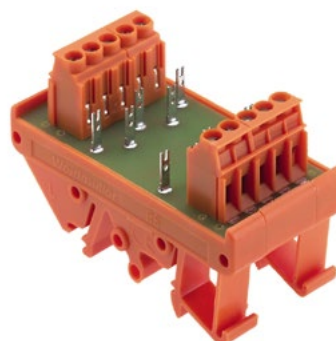

Axial components such as resistors, diodes and capacitors, can be soldered into the RSX component modules

Passive interfaces for general applications

RS VERT – Supply voltage distributor modules

Passive interfaces for the distribution of AC or DC voltage
These interfaces can distribute from 2 to 6 different voltages.
This allows distributing voltages of 230/400 V AC and DC control signals.

These interfaces provide an easy visualisation, and can be fixed to standard TS35 and/or TS32 assembly rails.

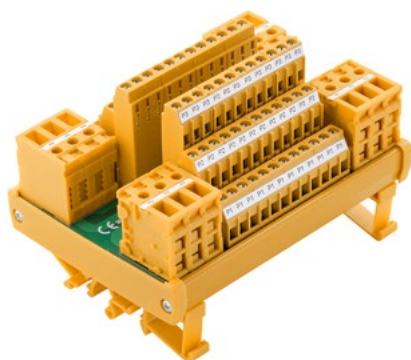

RSD – Interfaces with diodes

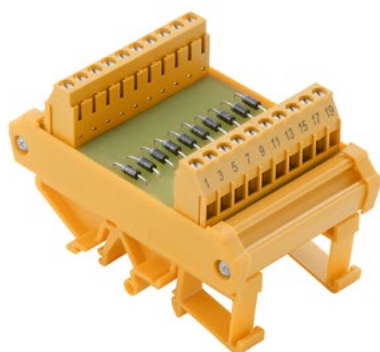

The diode interface is used for protection from surges, testing lamps or for preventing reverse polarity.

We therefore supply the following interfaces, namely:

- In common anode
- In common cathode
- Transverse diode

All come with screw connection and can be assembled onto TS-32 and TS-35 rails.

RS F - Interface for flat cable in accordance with IEC 60603-13 / DIN41651

**RS F - Interface for flat cable
in accordance with IEC 60603-13/DIN41651**

Interface for flat cable in accordance with IEC 60603-13/
DIN41651

- Connection 1:1
- 10 to 64 poles
- Screw or tension clamp connection

RSF Z

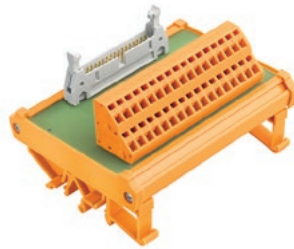

RSF S

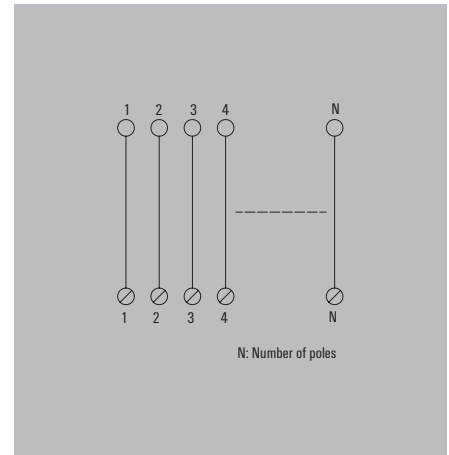
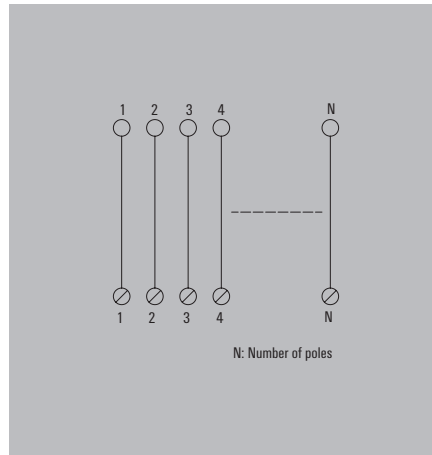
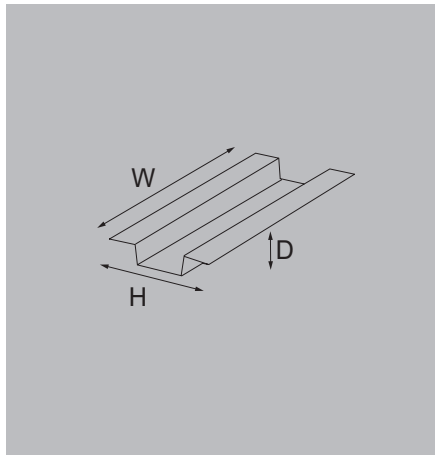

Technical data

Connection data	
Connection on control side	
Type of connection	
Rated data	
Rated voltage	
Rated current per connection	
General data	
Ambient temperature (operational)	
Storage temperature	
Approvals	
Insulation coordination (EN50178)	
Rated insulation voltage	
Surge voltage category	
Pollution severity level	
Pulse voltage test (1,2/50µs)	
Dimensions	
Clamping range, min./max.	
Rail	
Height / Depth	
Note	

Connection data	
Plug-in connector in acc. with IEC60603-13 / DIN41651	
Tension-clamp connection	
CE	
60 V AC / 75 V DC	
1 A	
CE	
0...55 °C	
-40...70 °C	
CE; EAC	
100 V	
II	
2	
0.8 kV	
0.13 mm ² / 2.5 mm ²	
TS 35, TS 32	
87 mm / 64 mm	

Connection data	
Plug-in connector in acc. with IEC60603-13 / DIN41651	
Screw connection	
CE	
60 V AC / 75 V DC	
1 A	
CE	
0...55 °C	
-40...60 °C	
CE; EAC	
100 V	
II	
2	
0.8 kV	
0.5 mm ² / 6 mm ²	
TS 35, TS 32	
87 mm / 70 mm	

Ordering data

10-pole plug	
14-pole plug	
16-pole plug	
20-pole plug	
26-pole plug	
34-pole plug	
40-pole plug	
50-pole plug	
60-pole plug	
64-pole plug	

Type	Width	Order No.
RS F10 Z	50 mm	8537190000
RS F14 Z	50 mm	8537200000
RS F20 Z	65 mm	8537110000
RS F26 Z	80 mm	8537180000
RS F34 Z	110 mm	8537130000
RS F40 Z	115 mm	8537140000
RS F50 Z	145 mm	8537150000

Type	Width	Order No.
RS F10 LP2N 5/10	50 mm	0224961001
RS F14 LP2N 5/14	50 mm	0225061001
RS F16 LP2N 5/16	55 mm	0225161001
RS F20 LP2N 5/20	65 mm	0224261001
RS F26 LP2N 5/26	80 mm	0224861001
RS F34 LP2N 5/34	110 mm	0224361001
RS F40 LP2N 5/40	115 mm	0224461001
RS F50 LP2N 5/50	145 mm	0224561001
RS F60 LP2N 5/60	180 mm	0224661001
RS F64 LP2N 5/64	180 mm	0224761001

Note

Accessories

Note

Note

Refer to the "Universal cables PAC-UNIV" section in chapter F

Note

Refer to the "Universal cables PAC-UNIV" section in chapter F

RSF S/ COMPACT



RSF S/ RS45

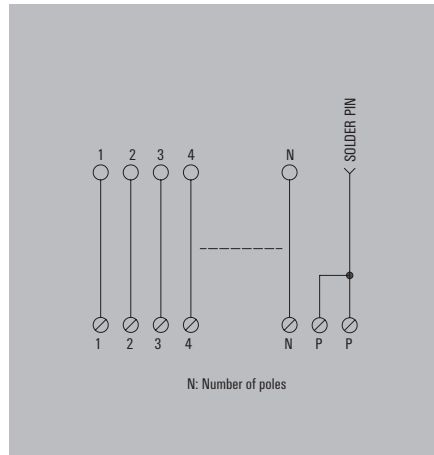
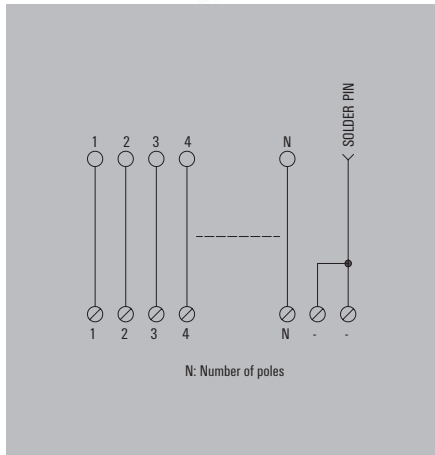

Plug-in connector in acc. with IEC60603-13 / DIN41651	
Screw connection	
CE	
60 V AC / 75 V DC	
1 A	
CE	
0...55 °C	
-40...70 °C	
CE; EAC	
100 V	
II	
2	
0.8 kV	
0.5 mm ² / 6 mm ²	
TS 35, TS 32	
87 mm / 76 mm	

Plug-in connector in acc. with IEC60603-13 / DIN41651	
Screw connection	
CE	
60 V AC / 75 V DC	
1 A	
CE	
0...55 °C	
-40...70 °C	
CE; EAC	
100 V	
II	
2	
0.8 kV	
0.15 mm ² / 1.5 mm ²	
TS 35, TS 32	
45 mm / 66 mm	

Type	Width	Order No.
RS F10 LP3R 3/12	40 mm	8012850000
RS F14 LP3R 3/14	45 mm	8012860000
RS F16 LP3R 3/18	50 mm	8012870000
RS F20 LP3R 3/21	50 mm	8012910000
RS F26 LP3R 3/27	55 mm	8012920000
RS F34 LP3R 3/36	70 mm	8012930000
RS F40 LP3R 3/42	80 mm	8012940000
RS F50 LP3R 3/51	95 mm	8012950000
RS F60 LP3R 3/63	115 mm	8012960000
RS F64 LP3R 3/66	120 mm	8012970000

Type	Width	Order No.
RS F10 LPK 2H/12	49 mm	8155610000
RS F14 LPK 2H/16	56 mm	8258980000
RS F16 LPK 2H/18	64 mm	8265540000
RS F20 LPK 2H/22	71 mm	8155600000
RS F26 LPK 2H/28	86 mm	8213470000
RS F34 LPK 2H/36	106 mm	8155590000
RS F40 LPK 2H/42	121 mm	8155580000
RS F50 LPK 2H/52	151 mm	8155570000
RS F60 LPK 2H/62	176 mm	8259000000
RS F64 LPK 2H/66	186 mm	8155550000

Refer to the "Universal cables PAC-UNIV" section in chapter F

Refer to the "Universal cables PAC-UNIV" section in chapter F

RS SD - Interface for SUB-D connector in accordance with IEC 60807-2 / DIN 41652
RS SD - Interface for SUB-D connector in accordance with IEC 60807-2 / DIN 41652

Interface for SUB-D connector in accordance with IEC 60807-2 / DIN 41652.

- Connection 1:1
- 9 to 50 poles
- Screw or tension clamp connection

RSSD Z

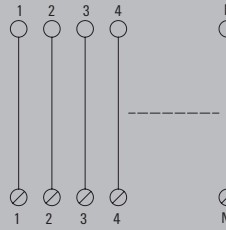
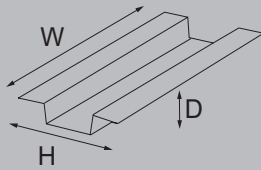
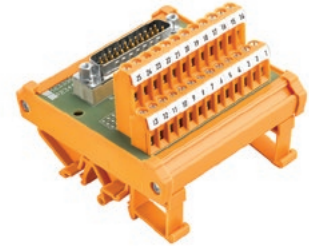
RSSD S

N: Number of poles

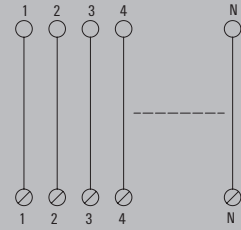

N: Number of poles

Technical data

Connection data
Connection on control side
Type of connection
Rated data
Rated voltage
Rated current per connection
General data
Ambient temperature (operational)
Storage temperature
Approvals
Insulation coordination (EN50178)
Rated insulation voltage
Surge voltage category
Pollution severity level
Pulse voltage test (1,2/50µs)
Dimensions
Clamping range, min./max.
Rail
Height / Depth
Note

Connection data
D-sub connectors, acc. to IEC 60807 / DIN 41652
Tension-clamp connection
CE
100 V
1.5 A
CE
0...55 °C
-40...70 °C
CE; EAC
Insulation coordination (EN50178)
100 V
II
2
0.8 kV
Dimensions
0.13 mm ² / 2.5 mm ²
TS 35, TS 32
87 mm / 64 mm
Note

Connection data
D-sub connectors, acc. to IEC 60807 / DIN 41652
Screw connection
CE
100 V
1.5 A
CE
0...55 °C
-40...70 °C
CE; EAC
Insulation coordination (EN50178)
100 V
II
2
0.8 kV
Dimensions
0.5 mm ² / 6 mm ²
TS 35, TS 32
87 mm / 76 mm
Note

Ordering data

9-pole male connector
15-pole male connector
25-pole male connector
37-pole male connector
50-pole male connector
9-pole female connector
15-pole female connector
25-pole female connector
37-pole female connector
50-pole female connector

Type	Width	Order No.
RS SD9 SZ	45 mm	8537260000
RS SD15 SZ	60 mm	8537390000
RS SD25 SZ	80 mm	8537370000
RS SD37 SZ	110 mm	8537240000
RS SD50 SZ	145 mm	8537350000
RS SD9 BZ	45 mm	8537320000
RS SD15 BZ	60 mm	8537400000
RS SD25 BZ	80 mm	8537380000
RS SD37 BZ	110 mm	8537250000
RS SD50 BZ	87 mm	8537360000

Type	Width	Order No.
RS SD9S UNC 4.40 LP2N	45 mm	8003901001
RS SD15S UNC 4.40 LP2N	60 mm	8005201001
RS SD25S UNC 4.40 LP2N	80 mm	8005181001
RS SD37S UNC 4.40 LP2N	110 mm	8003881001
RS SD50S UNC 4.40 LP2N	154 mm	8005161001
RS SD9B UNC 4.40 LP2N	45 mm	8003911001
RS SD15B UNC 4.40 LP2N	60 mm	8005211001
RS SD25B UNC 4.40 LP2N	80 mm	8005191001
RS SD37B UNC 4.40 LP2N	110 mm	8003891001
RS SD50B UNC 4.40 LP2N	154 mm	8005171001

Note

Note

Accessories

Note

Refer to the "Universal cables PAC-UNIV" section in chapter F

Refer to the "Universal cables PAC-UNIV" section in chapter F

RSSD/ COMPACT

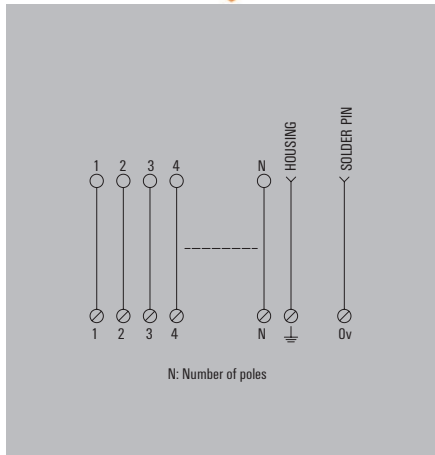

RSSD / RS45

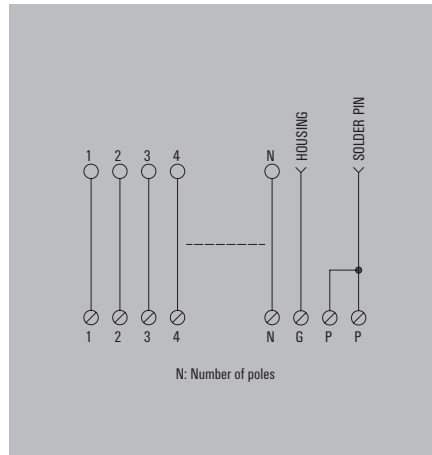

D-sub connectors, acc. to IEC 60807 / DIN 41652	
Screw connection	
CE	
100 V	
1.5 A	
CE	
0...55 °C	
-40...70 °C	
CE; EAC	
100 V	
II	
2	
0.8 kV	
0.5 mm ² / 6 mm ²	
TS 35, TS 32	
87 mm / 80 mm	

Type	Width	Order No.
RS SD9S LP3R	40 mm	8019930000
RS SD15S LP3R	45 mm	8019940000
RS SD25S LP3R	60 mm	8019950000
RS SD37S LP3R	80 mm	8019960000
RS SD50S LP3R	145 mm	8019970000
RS SD9B LP3R	40 mm	8019880000
RS SD15B LP3R	45 mm	8019890000
RS SD25B LP3R	60 mm	8019900000
RS SD37B LP3R	80 mm	8019910000
RS SD50B LP3R	100 mm	8019920000

Refer to the "Universal cables PAC-UNIV" section in chapter F

D-sub connectors, acc. to IEC 60807 / DIN 41652	
Screw connection	
CE	
100 V	
1.5 A	
CE	
0...55 °C	
-40...70 °C	
CE; EAC	
100 V	
II	
2	
0.8 kV	
0.15 mm ² / 1.5 mm ²	
TS 35, TS 32	
45 mm / 66 mm	

Type	Width	Order No.
RS SD9S UNC LPK2	50 mm	8259010000
RS SD15S UNC LPK2	61 mm	8233350000
RS SD25S UNC LPK2	86 mm	8155650000
RS SD37S UNC LPK2	116 mm	8155660000
RS SD50S UNC LPK2	154 mm	8155670000
RS SD9B UNC LPK2	50 mm	8216480000
RS SD15B UNC LPK2	61 mm	8209730000
RS SD25B UNC LPK2	86 mm	8155620000
RS SD37B UNC LPK2	116 mm	8155630000
RS SD50B UNC LPK2	45 mm	8155640000

Refer to the "Universal cables PAC-UNIV" section in chapter F

RS SD HD - Interface for connector SUB-D high density
**Interface for connector
SUB-D high-density**

- Connection 1:1
- 15,26,44,62 poles
- Screw connection

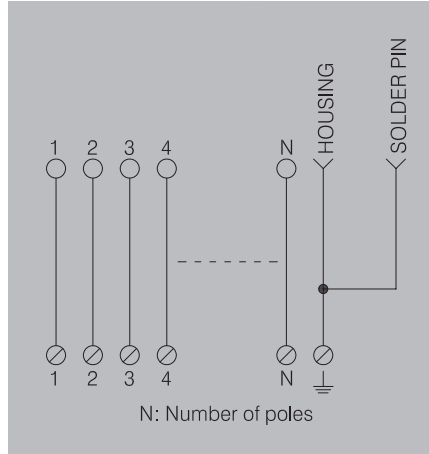
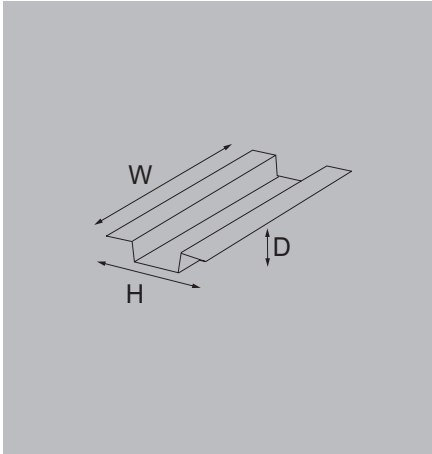
RS SD HD

Technical data
Connection data

Connection on control side
Type of connection

Rated data

Rated voltage
Rated current per connection

General data

Ambient temperature (operational)
Storage temperature
Approvals

Insulation coordination (EN50178)

Rated insulation voltage
Surge voltage category
Pollution severity level
Pulse voltage test (1,2/50µs)

Dimensions

Clamping range, min./max.
Rail
Height / Depth

Note

High-density SUB-D plug-in connectors
Screw connection

CE

125 V AC / 175 V DC
1 A

CE

-25...50 °C
-40...60 °C
CE; EAC

125V AC / 175 V DC
II
2
1.15 kV

0.5 mm² / 6 mm²
TS 35, TS 32
70 mm / 71 mm

Ordering data

15-pole male connector
26-pole male connector
44-pole male connector
62-pole male connector
15-pole female connector
26-pole female connector
44-pole female connector
62-pole female connector

Type	Width	Order No.
RS SD15M HD UNC4.40 S	40 mm	1428080000
RS SD26M HD UNC4.40 S	55 mm	1428090000
RS SD44M HD UNC4.40 S	95 mm	1428110000
RS SD62M HD UNC4.40 S	135 mm	1428120000
RS SD15F HD UNC4.40 S	40 mm	1428130000
RS SD26F HD UNC4.40 S	55 mm	1428140000
RS SD44F HD UNC4.40 S	95 mm	1428150000
RS SD62F HD UNC4.40 S	135 mm	1428160000

Note
Accessories
Note

Refer to the "Universal cables PAC-UNIV" section in chapter F

RS RJ45 - Interfaces with RJ45 connector

- Interface for the screw connection of communication devices
- Phosphor-bronze connector 6µ AU
- Data rate Cat5 100 Mbit

RS RJ45



RS RJ45 2WAY

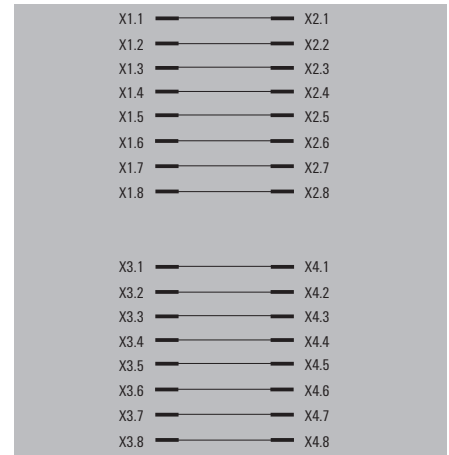
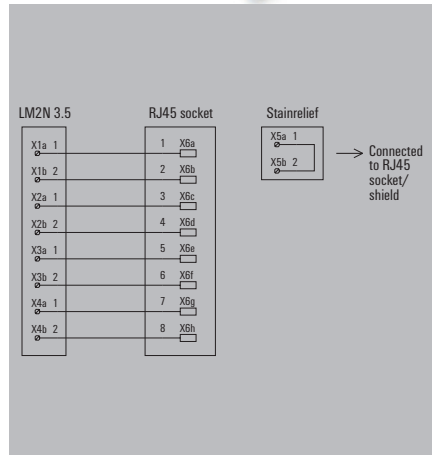
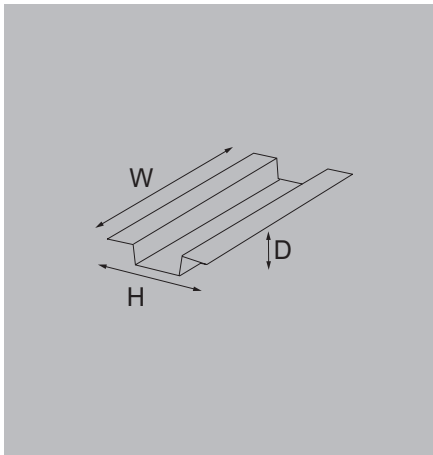

Technical data

Connection data
Connection on control side
Connection (field side)
Rated data
Rated voltage
Rated current per connection
General data
Ambient temperature (operational)
Storage temperature
Approvals
Insulation coordination (EN50178)
Rated insulation voltage
Surge voltage category
Pollution severity level
Pulse voltage test (1,2/50µs)
Dimensions
Clamping range, min./max.
Rail
Height / Depth
Note

RJ45 plug-in connectors
LM2N 3.5mm
CE
50 V
1 A
CE
0...55 °C
-40...70 °C
CE; EAC
< 50 V AC
III
2
0.8 kV
Screw connection
0.08 mm ² / 2.08 mm ²
TS 35, TS 32
70 mm / 48 mm
Connect shielding of data line to protective earth at one end

2 x RJ45 connector
2 x RJ45 plug-in connectors
CE
50 V
1 A
CE
0...55 °C
-40...70 °C
CE; EAC
< 50 V AC
III
2
0.8 kV
TS 35, TS 32
45 mm / 44 mm
Connect shielding of data line to protective earth at one end

Ordering data

Type	Width	Order No.
RS RJ45	30 mm	8611320000

Type	Width	Order No.
RS RJ45 2WAY	47 mm	8555440000

Note

Accessories

Note

RS ELCO - Interface with ELCO plug-in connectors
**RS ELCO - Interface
with male ELCO plug-in connectors**

Passive interface for transporting signals originating from a male ELCO plug-in connector to screw or tension clamp connection techniques.

- Family with male plug-in connectors with 20, 38, 56 and 90 poles
- The connector is polarised to avoid errors in the connection (Position 1)
- High resistance to vibration and low contact resistance

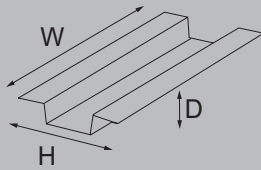
RS ELCO S

RS ELCO 90/90 S

Technical data
Rated data

Rated voltage
Rated current per connection

General data

Ambient temperature (operational)
Storage temperature
Approvals

Insulation coordination (EN50178)

Rated insulation voltage
Surge voltage category
Pollution severity level
Pulse voltage test (1,2/50µs)

150 V AC / 200 V DC
1.5 A

-25...50 °C
-40...60 °C
CE; EAC

< 150 V AC
II
2
2.5 kV

150 V AC / 200 V DC
0.5 A

-25...50 °C
-40...60 °C
CE; EAC

< 150 V AC
II
2
2.5 kV

Dimensions

Clamping range, min./max.
Rail
Height / Depth

Note
Screw connection

0.5 mm² / 6 mm²
TS 35, TS 32
70 mm / 60 mm

Polarizer in position 1

Screw connection

0.5 mm² / 6 mm²
TS 35, TS 32
109 mm / 76 mm

Polarizer in position 1

Ordering data

Type	Width	Order No.
20-pole right	60 mm	1126610000
20-pole left	60 mm	1126630000
38-pole right	105 mm	1126650000
38-pole left	105 mm	1126670000
56-pole right	95 mm	1126690000
56-pole left	95 mm	1126710000
56-pole right	155 mm	1126730000
56-pole left	155 mm	1126750000
56-pole right	155 mm	1126770000
56-pole left	155 mm	1126790000
90-pole right	242 mm	1126810000
90-pole left	242 mm	1126870000

Note

Type	Width	Order No.
RS ELCO 20/20RM S	60 mm	1126610000
RS ELCO 20/20LM S	60 mm	1126630000
RS ELCO 38/38RM S	105 mm	1126650000
RS ELCO 38/38LM S	105 mm	1126670000
RS ELCO 56/32RM S	95 mm	1126690000
RS ELCO 56/32LM S	95 mm	1126710000
RS ELCO 56/54RM S	155 mm	1126730000
RS ELCO 56/54LM S	155 mm	1126750000
RS ELCO 56/56RM S	155 mm	1126770000
RS ELCO 56/56LM S	155 mm	1126790000
RS ELCO 90/90RM S	242 mm	1126810000
RS ELCO 90/90LM S	242 mm	1126870000

Type	Width	Order No.
RS ELCO 20/20RM S	60 mm	1126610000
RS ELCO 20/20LM S	60 mm	1126630000
RS ELCO 38/38RM S	105 mm	1126650000
RS ELCO 38/38LM S	105 mm	1126670000
RS ELCO 56/32RM S	95 mm	1126690000
RS ELCO 56/32LM S	95 mm	1126710000
RS ELCO 56/54RM S	155 mm	1126730000
RS ELCO 56/54LM S	155 mm	1126750000
RS ELCO 56/56RM S	155 mm	1126770000
RS ELCO 56/56LM S	155 mm	1126790000
RS ELCO 90/90RM S	242 mm	1126810000
RS ELCO 90/90LM S	242 mm	1126870000

Accessories
Note

Refer to the "Universal cables PAC-ELCO" section in chapter F

Refer to the "Universal cables PAC-ELCO" section in chapter F

RS ELCO - Interface
with female ELCO plug-in connectors

Passive interfaces for transmitting signals from a plug-in ELCO female connector to a screw connection.

- Family of 20, 38, to 56-pole female plug-in connectors
- Polarisation of the connector to prevent errors in connection (position 1)
- High resistance to vibration and low contact resistance

RS ELCO F



RS ELCO F 56

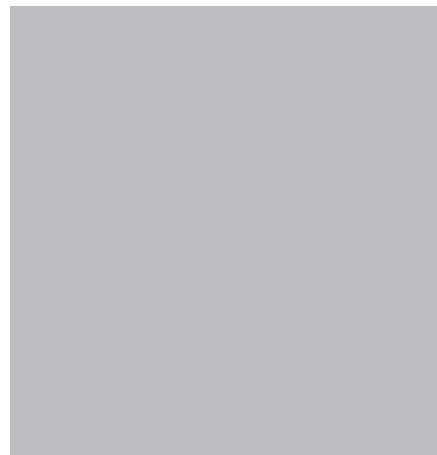
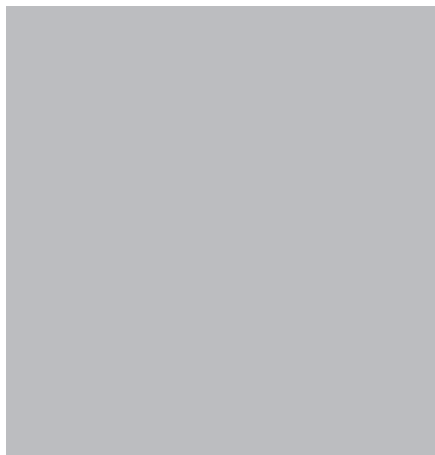
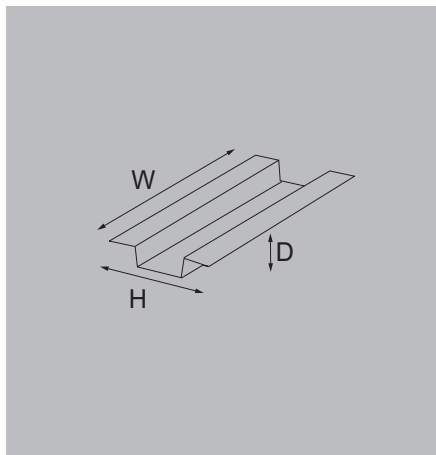

Technical data

Rated data
Rated voltage
Rated current per connection
General data
Ambient temperature (operational)
Storage temperature
Approvals
Insulation coordination (EN50178)
Rated insulation voltage
Surge voltage category
Pollution severity level
Pulse voltage test (1,2/50µs)

CE
150 V AC / 200 V DC
1.5 A
CE
-25...50 °C
-40...60 °C
CE
< 150 V AC
II
2
2.5 kV

CE
150 V AC / 200 V DC
5 A
CE
-25...50 °C
-40...60 °C
CE
< 150 V AC
II
2
2.5 kV

Dimensions
Clamping range, min./max.
Rail
Height / Depth
Note

0.13 mm ² / 6 mm ²
TS 35, TS 32
70 mm / 60 mm
Polariser in position 1

0.5 mm ² / 6 mm ²
TS 35, TS 32
70 mm / 60 mm
Polariser in position 1

Ordering data

20-pole right
20-pole left
38-pole right
38-pole left
56-pole right
56-pole left

Type	Width	Order No.
RS ELCOF 20/20RM S	60 mm	1480740000
RS ELCOF 20/20LM S	60 mm	1480750000
RS ELCOF 38/38RM S	105 mm	1480760000
RS ELCOF 38/38LM S	105 mm	1480770000

Type	Width	Order No.
RS ELCOF 56/56RM S	155 mm	1480780000
RS ELCOF 56/56LM S	155 mm	1480790000

Note

--

--

Accessories

Note

Refer to the "PAC-ELCO universal cables" section in this chapter
--

Refer to the "PAC-ELCO universal cables" section in this chapter
--

RS ELCO male connector: Dimensional Drawings

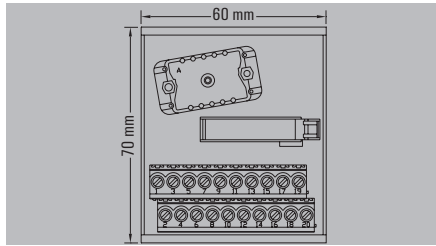

ELCO 20/20L LEFT

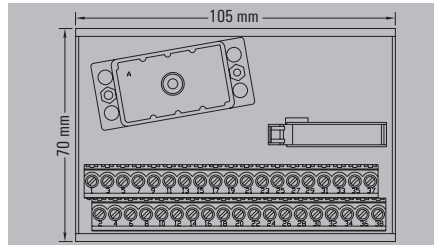

ELCO 38/38L LEFT

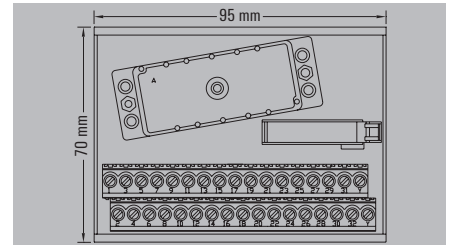

ELCO 56/32L LEFT

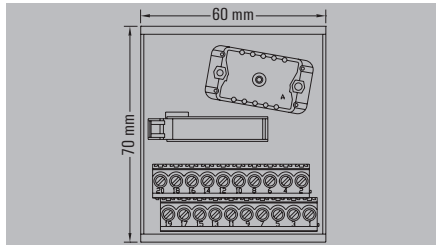

ELCO 20/20R RIGHT

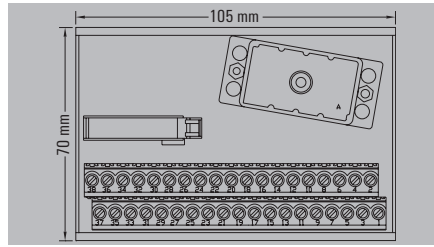

ELCO 38/38R RIGHT

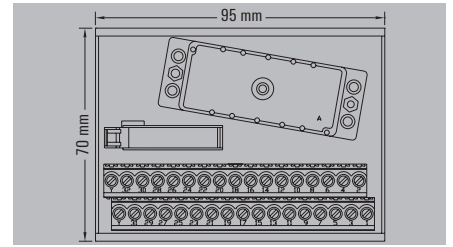

ELCO 56/32R RIGHT

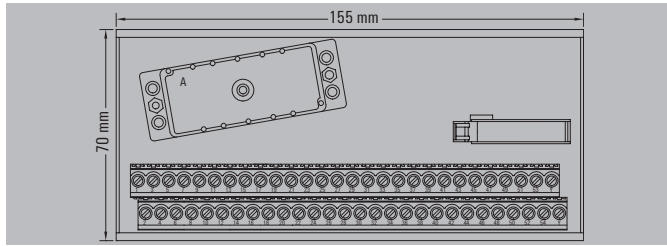

ELCO 56/54L LEFT

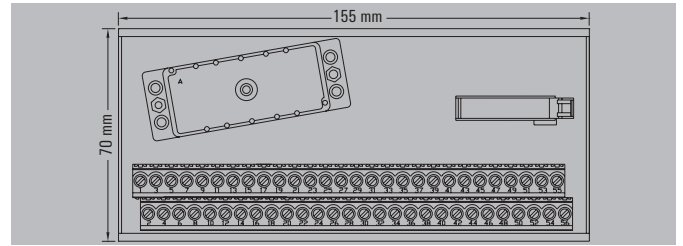

ELCO 56/56L LEFT

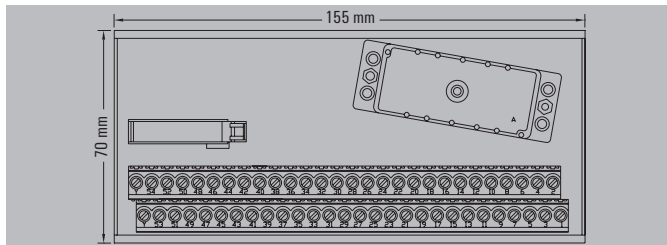

ELCO 56/54R RIGHT

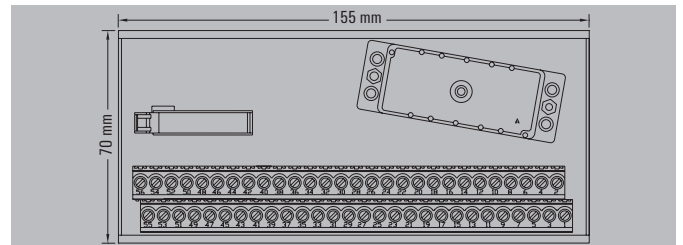

ELCO 56/56R RIGHT

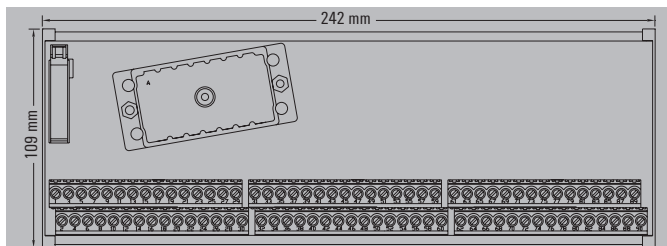

ELCO 90/90L LEFT

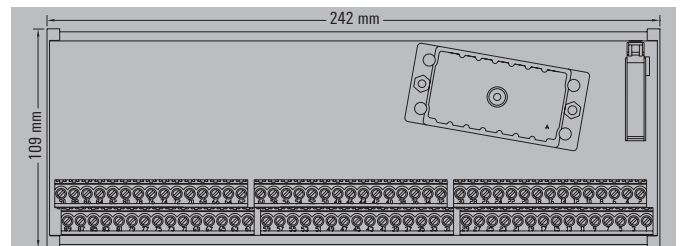

ELCO 90/90R RIGHT

RS ELCOF female connector: Dimensional Drawings

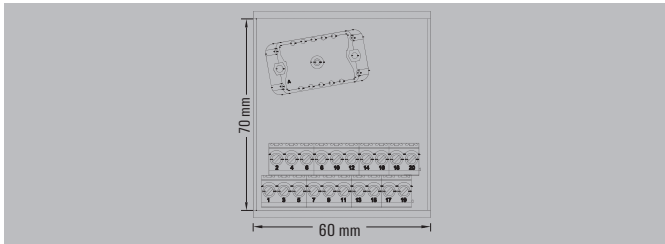

RS ELCOF 20/20LM S

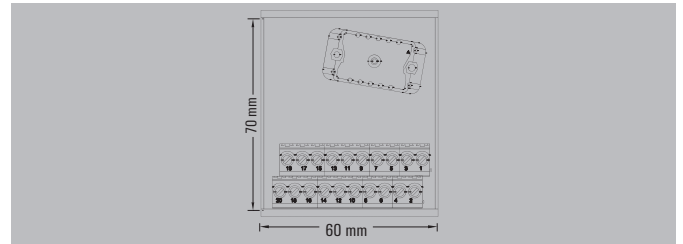

RS ELCOF 20/20RM S

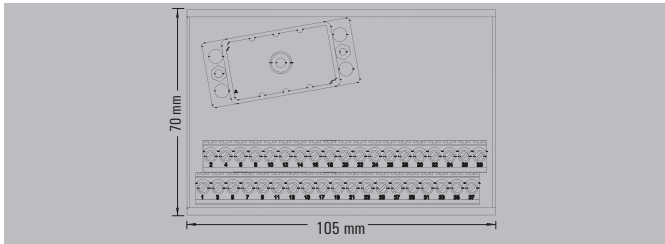

RS ELCOF 38/38LM S

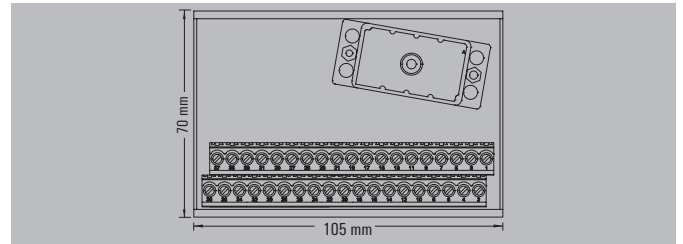

RS ELCOF 38/38RM S

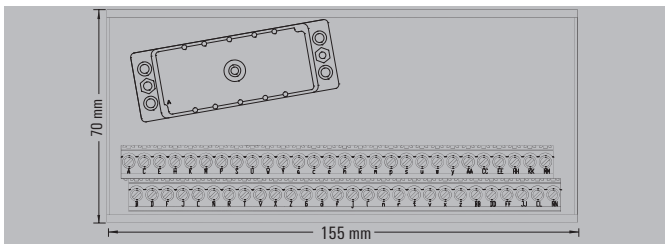

RS ELCOF 56/56LM S

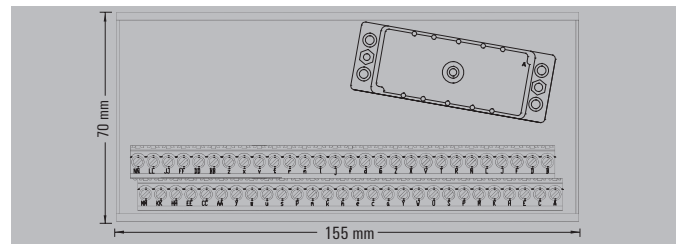

RS ELCOF 56/56RM S

RS ELCO - Interface with ELCO plug-in connectors

Pin assignment

ELCO connector 20-pole	RS ELCO 20/20RM S RS ELCO 20/20LM S RS ELCOF 20/20RM S RS ELCOF 20/20LM S
A	1
B	2
C	3
D	4
E	5
F	6
H	7
J	8
K	9
L	10
M	11
N	12
P	13
R	14
S	15
T	16
U	17
V	18
W	19
X	20
Note	

ELCO connector 38-pole	RS ELCO 38/38RM S RS ELCO 38/38LM S RS ELCOF 38/38RM S RS ELCOF 38/38LM S
A	1
B	2
C	3
D	4
E	5
F	6
H	7
J	8
K	9
L	10
M	11
N	12
P	13
R	14
S	15
T	16
U	17
V	18
W	19
X	20
Y	21
Z	22
AA	23
BB	24
CC	25
DD	26
EE	27
FF	28
HH	29
JJ	30
KK	31
LL	32
MM	33
NN	34
PP	35
RR	36
SS	37
TT	38
Note	

ELCO connector 56-pole	RS ELCO 56/32RM S RS ELCO 56/32LM S	RS ELCO 56/54RM S RS ELCO 56/54LM S	RS ELCO 56/56RM S RS ELCO 56/56LM S RS ELCOF 56/56RM S RS ELCOF 56/56LM S
A	1	1	1
B	2	2	2
C	3	3	3
D	4	4	4
E	5	5	5
F	6	6	6
H	7	7	7
J	8	8	8
K	9	9	9
L	10	10	10
M	11	11	11
N	12	12	12
P	13	13	13
R	14	14	14
S	15	15	15
T	16	16	16
U	17	17	17
V	18	18	18
W	19	19	19
X	20	20	20
Y	Y	YY	21
Z	21	-	22
a	22	21	23
b	23	22	24
c	24	23	25
d	25	24	26
e	26	25	27
f	27	26	28
h	28	27	29
j	29	28	30
k	30	29	31
l	31	30	32
m	32	31	33
n	-	32	34
p	-	33	35
r	-	34	36
s	-	35	37
t	-	36	38
u	-	37	39
v	-	38	40
w	-	39	41
x	-	40	42
y	-	41	43
z	-	42	44
AA	-	43	45
BB	-	44	46
CC	-	45	47
DD	-	46	48
EE	-	47	49
FF	-	48	50
HH	-	49	51
JJ	-	50	52
KK	-	51	53
LL	-	52	54
MM	-	53	55
NN	Y	54	56
Note			

ELCO connector 90-pole	RS ELCO 90/90RM S RS ELCO 90/90LM S
A	1
B	2
C	3
D	4
E	5
F	6
H	7
J	8
K	9
L	10
M	11
N	12
P	13
R	14
S	15
T	16
U	17
V	18
W	19
X	20
Y	21
Z	22
AA	23
AB	24
AC	25
AD	26
AE	27
AF	28
AH	29
AJ	30
AK	31
AL	32
AM	33
AN	34
AP	35
AR	36
AS	37
AT	38
AU	39
AV	40
AW	41
AX	42
AY	43
AZ	44
BA	45
BB	46
BC	47
BD	48
BE	49
BF	50
BH	51
BJ	52
BK	53
BL	54
BM	55
BN	56
BP	57
BR	58
BS	59
BT	60
BU	61
BV	62
BW	63
BX	64
BY	65
BZ	66
CA	67
CB	68
CC	69
CD	70
CE	71
CF	72
CH	73
CJ	74
CK	75
CL	76
CM	77
CN	78
CP	79
CR	80
CS	81
CT	82
CU	83
CV	84
CW	85
CX	86
CY	87
CZ	88
DA	89
DB	90
Note	

Interface for soldering of components

- For soldering 5 components
- Height of solder tabs: 6mm

RSX LOETST. LP

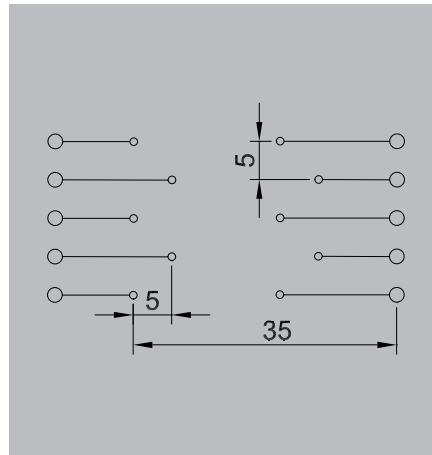
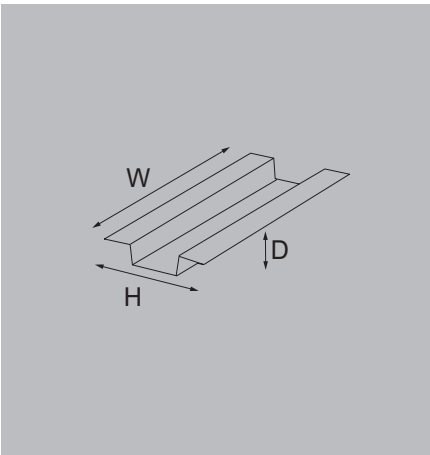

Technical data

Rated data
Rated control voltage
Total operating current
General data
Ambient temperature, min.
Storage temperature
Approvals
Insulation coordination (EN50178)
Rated insulation voltage
Surge voltage category

CE
250 V
5 A
CE
-25...50 °C
-40...60 °C
CE
< 250 V AC
II

Dimensions
Clamping range, min./max.
Rail
Height / Depth
Note

0.5 mm ² / 6 mm ²
TS 32, TS 35
70 mm / 42 mm

Ordering data

--

Type	Width	Order No.
RSX LOETST. LP	35 mm	0329761001

Note

--

Accessories

Note

--

RS VERT - Supply voltage distributor modules
RS VERT - 2 potentials

- Distribution module with 2, 4 or 6 potentials
- Distribution current from 10 to 120 A
- Screw or tension clamp connection

RS VERT 2P/ 8P1-8P2 S

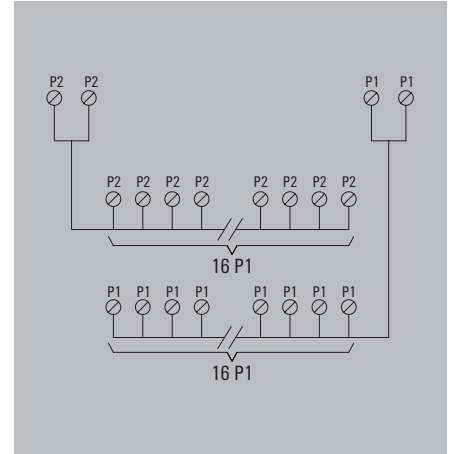
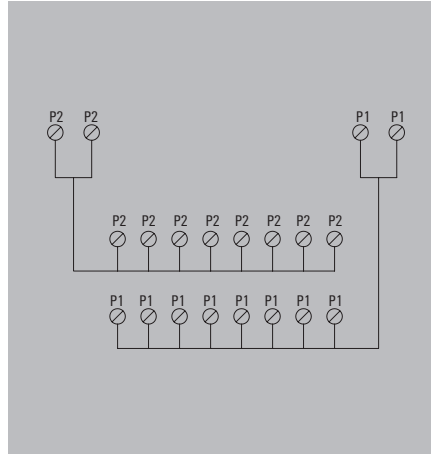
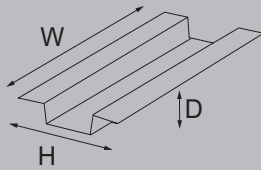
RS VERT 2P/ 16P1-16P2 S

Technical data
Rated data

Operating voltage
Maximum current per distributor connection
Maximum current per potential connection
Total operating current

General data

Ambient temperature (operational)
Storage temperature
Approvals

Insulation coordination (EN50178)

Rated insulation voltage
Surge voltage category
Pollution severity level
Pulse voltage test (1,2/50µs)

max. 30 V
5 A
5 A
10 A

0...55 °C
-40...60 °C
CE; EAC

< 50 V AC
III
2
0.8 kV

max. 30 V
5 A
5 A
10 A

0...55 °C
-40...60 °C
CE; EAC

< 50 V AC
III
2
0.8 kV

Dimensions

Clamping range, min./max.
Clamping range, min./max.
Rail
Width / Height

Note
Screw connection

0.15 mm ² / 1.5 mm ²
0.15 mm ² / 1.5 mm ²
TS 35, TS 32
52 mm / 45 mm

The module may be used for a nominal voltage of 250 V AC, considering an overvoltage category of II

Screw connection

0.15 mm ² / 1.5 mm ²
0.15 mm ² / 1.5 mm ²
TS 35, TS 32
93 mm / 45 mm

The module may be used for a nominal voltage of 250 V AC, considering an overvoltage category of II

Ordering data

Screw connection

Type	Depth	Order No.
RS VERT8 LPK2	64 mm	8252010000

Type	Depth	Order No.
RS VERT16 LPK2	64 mm	8234620000

Note
Accessories
Note

RS VERT - 2 potentials

- Current distributor interface with 8 channels, fuse status indicator, and alarm contact.
- Protection by 5x20mm fuse-links.
- Monitorization of each fuse status.
 - Visual: Normal operation of the fuse (Green) / Broken fuse (Red).
 - Remote: If all fuses in normal operation 11-14 continuity. If one of the fuses fail 11-14 open circuit.
- Fuse-links are not delivered with the product.

RS VERT 8P 24VDC Z UL V1

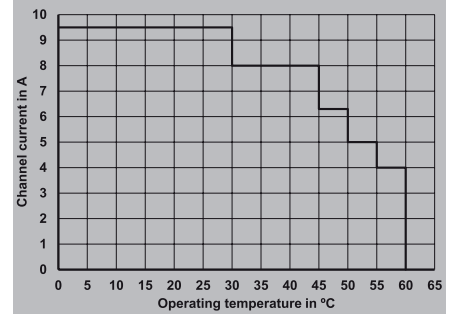
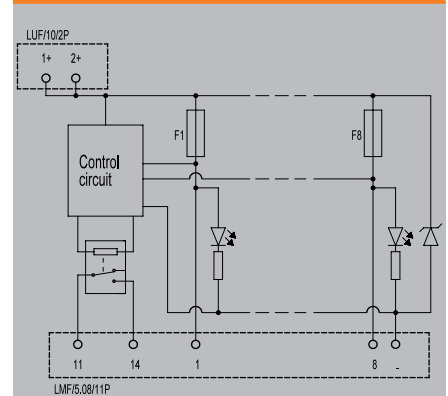
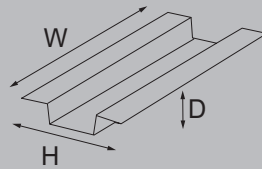

Technical data

Rated data	
Operating voltage	24 V DC ± 25%
Maximum current per distributor connection	9.5 A
Total operating current	76.5 A
Switching capacity (resistive) relay DC, max.	4.5 W @ 30 V
Switching power relay, min.	1 mA @ 1 V
Connection field	
Clamping range, min./max.	2.5...0.12 mm ²
Wire cross-section min./max. AWG	AWG 12...AWG 24
Type of connection	PUSH IN
Connection supply	
Clamping range, min./max.	0.5...16 mm ²
Wire cross-section min./max. AWG	AWG 20...AWG 6
Type of connection	PUSH IN
General data	
Ambient temperature (operational)	-25...60 °C
Storage temperature	-25...60 °C
Humidity at operating temperature	0...85% (no condensation)
Approvals	CE, cULus
Insulation coordination (EN50178)	
Rated insulation voltage	50 V AC / 70 V DC
Surge voltage category	II
Pollution severity	2

Screw connection	
Clamping range, min./max.	2.5 mm ² / 0.12 mm ²
Clamping range, min./max.	0.5 mm ² / 16 mm ²
Rail	TS 32, TS 35
Height / Width	78.2 mm / 108.2 mm

Dimensions

Clamping range, min./max.	2.5 mm ² / 0.12 mm ²
Clamping range, min./max.	0.5 mm ² / 16 mm ²
Rail	TS 32, TS 35
Height / Width	78.2 mm / 108.2 mm

Screw connection

Clamping range, min./max.	2.5 mm ² / 0.12 mm ²
Clamping range, min./max.	0.5 mm ² / 16 mm ²
Rail	TS 32, TS 35
Height / Width	78.2 mm / 108.2 mm

Ordering data

Screw connection	2727410000
------------------	------------

Type	Depth	Order No.
RS VERT 8P 24VDC Z UL V1	102 mm	2727410000

Note

Accessories

Note	*Fuses not included in the module. Ordering data: (FUSE 5X20 250V Type F): 2780640000 - 4 A; 2780730000 - 5 A; 2780740000 - 6.3 A; 2780750000 - 8 A; 2780760000 - 10 A
------	--

RS VERT - Supply voltage distributor modules
RS VERT - 4 and 6 potentials

- Distribution module with 4 or 6 potentials
- Distribution current from 10 to 120 A
- Screw or tension clamp connection

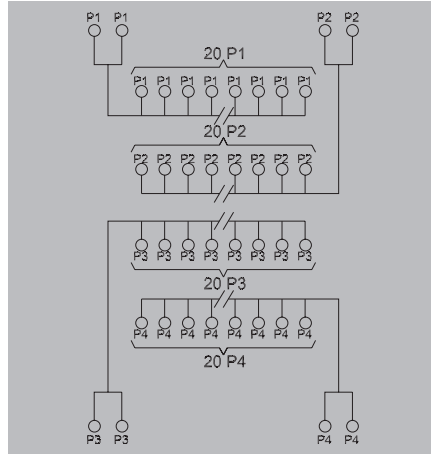
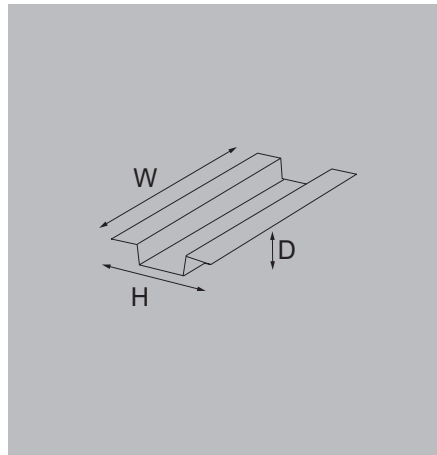
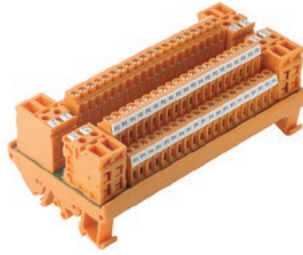
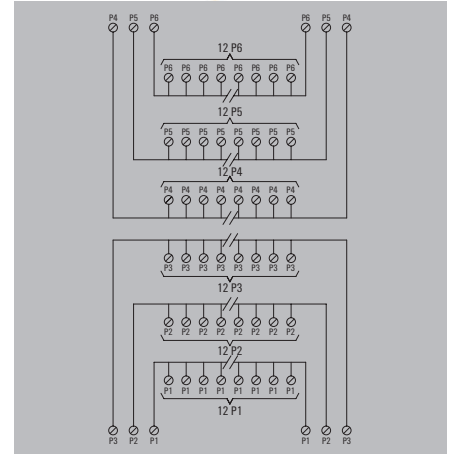
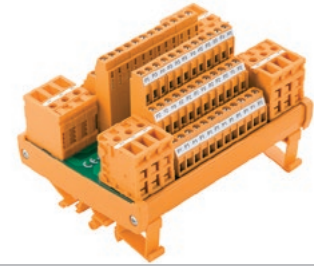
RS VERT 4P/4X20P S/Z

RS VERT 6P/6X12P S/Z

Technical data

Rated data
Operating voltage
Maximum current per distributor connection
Maximum current per potential connection
Total operating current
General data
Ambient temperature (operational)
Storage temperature
Approvals
Insulation coordination (EN50178)
Rated insulation voltage
Surge voltage category
Pollution severity level
Pulse voltage test (1,2/50µs)

CE
< 600 V AC
15 A
30 A
120 A
CE
-25...50 °C
-40...60 °C
CE; EAC
CE
< 600 V AC
III
2
6 kV

CE
250 V AC
15 A
20 A
120 A
CE
-25...50 °C
-40...60 °C
CE; EAC
CE
< 300 V AC
III
2
4 kV

Dimensions
Clamping range, min./max.
Clamping range, min./max.
Rail
Width / Height
Note

Screw connection	Tension clamp conn.
0.13 mm ² / 6 mm ²	0.13 mm ² / 2.5 mm ²
0.13 mm ² / 6 mm ²	0.13 mm ² / 6 mm ²
TS 35, TS 32	TS 35, TS 32
145 mm / 70 mm	145 mm / 70 mm
Note	Note

Screw connection	Tension clamp conn.
0.13 mm ² / 6 mm ²	0.13 mm ² / 2.5 mm ²
0.13 mm ² / 6 mm ²	0.13 mm ² / 6 mm ²
TS 35, TS 32	TS 35, TS 32
122 mm / 87 mm	122 mm / 87 mm
Note	Note

Ordering data

Type	Depth	Order No.
RS VERT 4P 20X4 S	55 mm	1128100000
RS VERT 4P 20X4 Z	52 mm	1128110000

Type	Depth	Order No.
RS VERT 6P 12X6 S	83 mm	1128120000
RS VERT 6P 12X6 Z	75 mm	1128130000

Type	Depth	Order No.
RS VERT 4P 20X4 S	55 mm	1128100000
RS VERT 4P 20X4 Z	52 mm	1128110000

Note

Note

Note

Accessories

Note

Note

Note

RSD - interfaces with diodes

Diode bases for current peak protection, lamp tests or preventing reverse polarity.

- Diode 1N4007
- Mounting on TS32/35

RSD A / RSD K

Common anode or cathode



RSD

Independent diodes

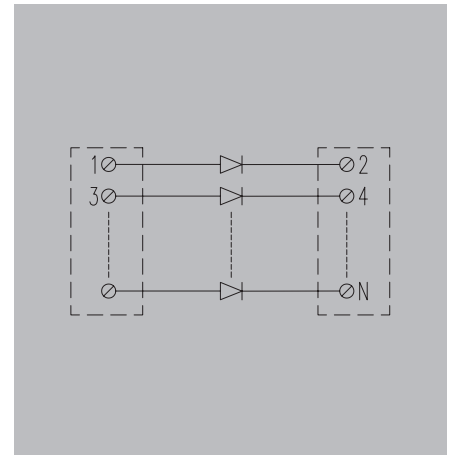
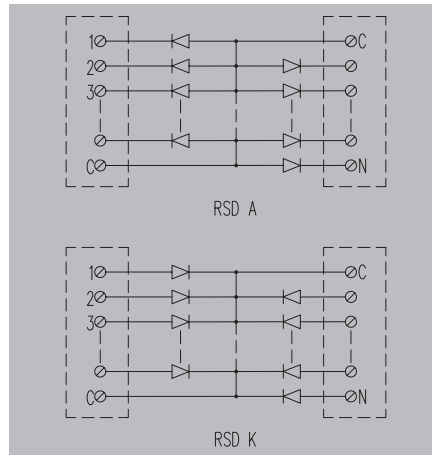
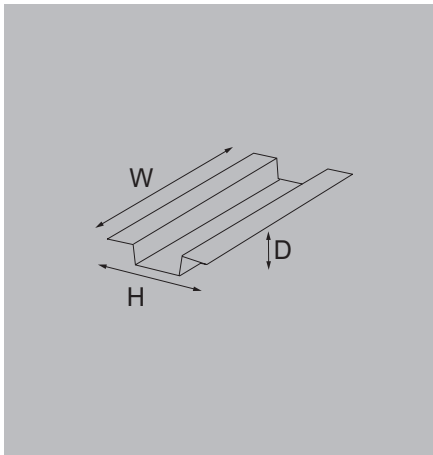

Technical data

Rated data
Operating voltage
Rated current per connection
General data
Ambient temperature (operational)
Storage temperature
Approvals
Insulation coordination
Rated insulation voltage
Surge voltage category
Pollution severity level
Pulse voltage test (1,2/50µs)

CE
230 V
1 A
CE
0...55 °C
-40...60 °C
CE; EAC
CE
230 V
II
2
2 kV

CE
230 V
1 A
CE
0...55 °C
-40...60 °C
CE; EAC
CE
230 V
II
2
2 kV

Dimensions

Clamping range, min./max.
Rail
Height / Depth
Note

0.5 mm ² / 6 mm ²
TS 35, TS 32
70 mm / 42 mm

0.5 mm ² / 6 mm ²
TS 35, TS 32
70 mm / 42 mm

Ordering data

10 independent diodes
12 independent diodes
20 independent diodes
40 independent diodes
5 A diodes (shared plus pole)
5 K diodes (shared negative pole)
10 A diodes (shared plus pole)
10 K diodes (shared negative pole)
20 A diodes (shared plus pole)
20 K diodes (shared negative pole)
22 A diodes (shared plus pole)
22 K diodes (shared negative pole)
Note

Type	Width	Order No.
RSD A5 LP/LP	20 mm	1312740000
RSD K5 LP/LP	20 mm	1312750000
RSD A10 LP/LP	35 mm	1312760000
RSD K10 LP/LP	35 mm	1312770000
RSD A20 LP/LP	60 mm	1312780000
RSD K20 LP/LP	60 mm	1312790000
RSD A22 LP/LP	65 mm	0180961001
RSD K22 LP/LP	65 mm	0181061001

Type	Width	Order No.
RSD 10 LP/LP	60 mm	8022901001
RSD 12 LP/LP	65 mm	0181461001
RSD 20 LP/LP	120 mm	8022911001
RSD 40 LP/LP	220 mm	8022921001

Accessories

Note

Note

Note

Isolated Interfaces and solutions for general applications

Isolated Interfaces and solutions for general applications	RSM/RSMS multiple relay modules - General description	E.2	
	RSM multiple relay modules - Interfaces with 12,5 mm relays (RCL)	E.5	
	RSMS multiple relay modules - Interfaces with 6,1 mm relays (RCL)	E.13	
	TERMSERIES PLC'S system cables - General description	E.16	
	TERMSERIES PLC'S system cables - Selection tables	E.18	
	PLC ABB S800	- Selection table	E.19
	PLC EMERSON DELTA V	- Selection table	E.20
	PLC GE FANUC RX3I	- Selection table	E.21
	PLC HONEYWELL C200	- Selection table	E.23
	PLC HONEYWELL C300	- Selection table	E.24
	PLC MITSUBISHI MELSEC Q	- Selection table	E.26
	PLC OMRON CJ1W	- Selection table	E.28
	PLC ROCKWELL COMPACT LOGIX	- Selection table	E.32
	PLC ROCKWELL CONTROL LOGIX	- Selection table	E.34
	PLC SCHNEIDER M340	- Selection table	E.36
	PLC SCHNEIDER QUANTUM	- Selection table	E.38
	PLC SCHNEIDER TM3	- Selection table	E.39
	PLC SIEMENS S7-300	- Selection table	E.40
	PLC SIEMENS S7-400	- Selection table	E.42
	PLC SIEMENS S7-1500	- Selection table	E.43
	PLC SIEMENS -ET 200SP	- Selection table	E.44
PLC SIEMENS -ET 200SP HA	- Selection table	E.45	
PLC YOKOGAWA CENTUM	- Selection table	E.46	
PLC YOKOGAWA STARDOM	- Selection table	E.47	
PLC WEIDMÜLLER u-remote	- Selection table	E.48	
TERMSERIES adapters	E.49		
TERMSERIES - relays modules from 6 mm width	E.53		

Connecting relay modules to controls in a compact fashion

It's child's play with our RSM multiple relay modules

You want relay modules that save space and can be wired with minimal effort. Our compact RSM modules save time and money.

A growing number of applications require dense wiring to be connected in a very small space, in a very short time. Our RSM relay modules form interfaces with 4, 8 or 16 electromechanical and/or solid-state relays.

E Our RSM modules are extremely compact. For quick wiring, the DC variants come with a shared positive or negative potential. An optional IEC 603-13 plug-in connector allows pre-assembled lines to be connected.

The RSM series comes in various functional variants, making it highly flexible. Available with 1 or 2 CO contacts and a 16/8 A relay (RCL), as a slim 6 A relay (RSS) or with a test button (RCI).

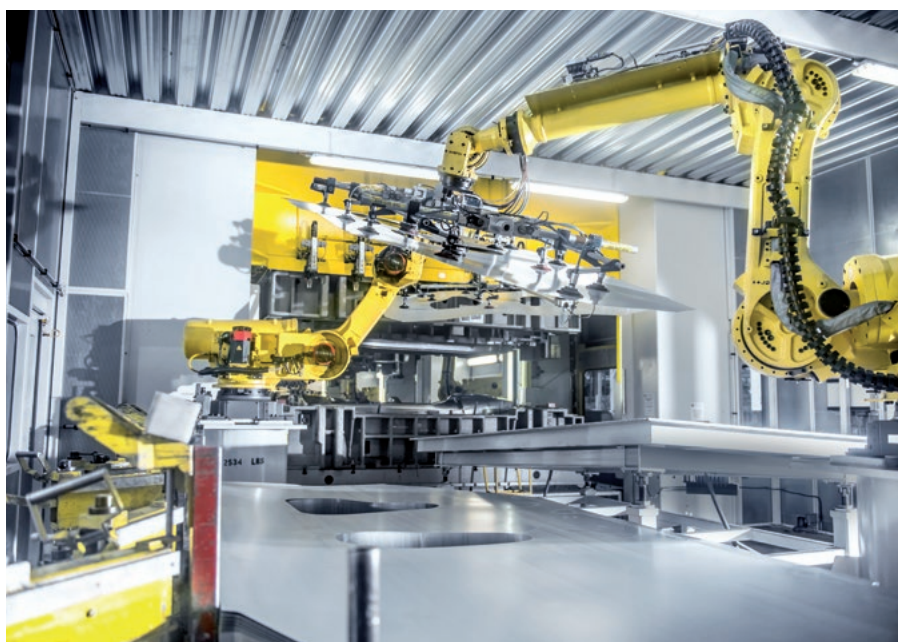

Relay modules that save a lot of space

A growing number of applications require dense wiring to be connected in a very small space, in a very short time – for instance in machinery, process and conventional power stations. RSM relay modules allow extremely compact solutions.

Fast, safe and easy connection.
With PAC-UNIV pre-assembled cables, it's easy to connect the interfaces to almost any controller on the market.

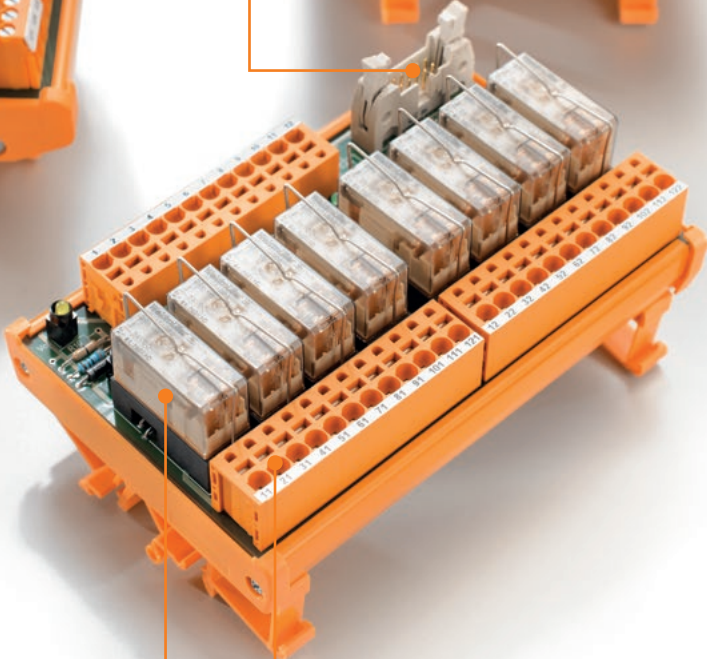
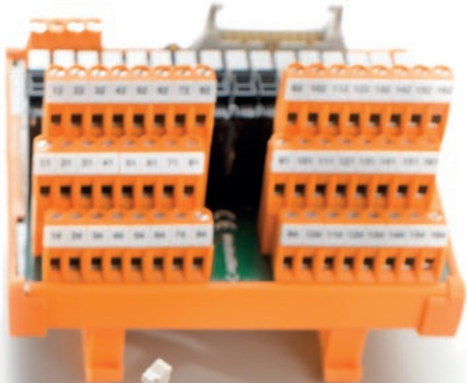

Clear marking
One green LED per channel ensures that each contact is clearly identified.

Excellent electrical properties
Galvanic isolation with electromechanical or solid-state relay allows the voltage of the controller to be adjusted to that of the field elements (e.g. sensors).

PUSH IN connection for 1 changeover version

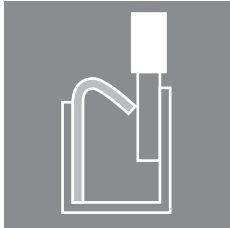

RSM 1C0/2C0 – Relay interface

1 or 2 changeover

- Interface from 4 to 16 electromechanical relays
- 1 or 2 changeover
- Positive or negative switching or AC
- With optional test button with latching function (RCL relays)
- Empty boards available (BASE)
- Flat-connector available to make easy the connection to PLC'S
- Compatible with solid-state relays
- Screw and "PUSH IN" for 1 changeover
- Screw and tension clamp for 2 changeover

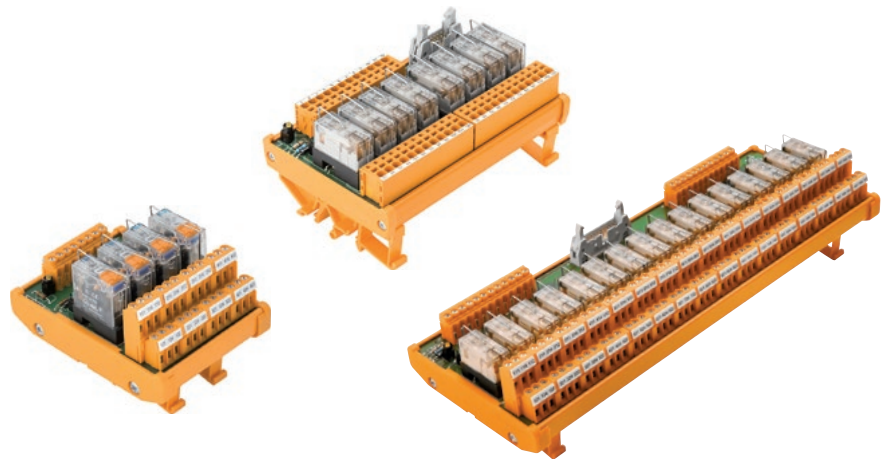

General technical data

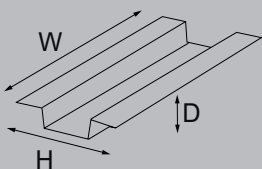
General features	
Relay	
LED status display per channel	
LED status of the supply voltage	
Nominal output data	
Contact material	
Operative voltage	
Max. AC continuous current	
Minimum contact current	
Minimum contact voltage	
Mechanical service life (dc coil)	
Mechanical service life (ac coil)	
Operating temperature	
Storage temperature	
Approvals	
Insulation coordination (EN 50178)	
Rated input insulation voltage	
Rated output insulation voltage	
Overvoltage category input/output	
Overvoltage category input/output	
Pollution severity level	
Impulse voltage test (1.2/50µs)	
Insulation test voltage	
Clearance input/output	
Dimensions	
Clamping range, min. [Field]/ Clamping range, max. [Field]	
Clamping range, min. [supply]/Clamping range, max. [supply]	
Mounting rail	
Height / Depth	mm
Height / Depth (RCL)	mm
Height / Depth (BASE)	mm
Note	
	

1 changeover																	
RCL (standard) / RCI (test button)																	
Green																	
Yellow																	
CE																	
AgNi 90/10																	
250 V AC																	
6 A																	
100 mA																	
5 V DC																	
30 x 10 ⁶ / 10 x 10 ⁶ (RCL) switchings																	
10 x 10 ⁶ / 5 x 10 ⁶ (RCL) switching cycles																	
-25...+50 °C																	
-40...+60 °C																	
CE, EAC																	
<table border="1"> <tr> <td>< 50 V AC</td> <td></td> </tr> <tr> <td>250 V AC</td> <td></td> </tr> <tr> <td>III</td> <td></td> </tr> <tr> <td>II</td> <td></td> </tr> <tr> <td>2</td> <td></td> </tr> <tr> <td>6 kV</td> <td></td> </tr> <tr> <td>1.2 kV AC</td> <td></td> </tr> <tr> <td>≥ 5,5 mm</td> <td></td> </tr> </table>		< 50 V AC		250 V AC		III		II		2		6 kV		1.2 kV AC		≥ 5,5 mm	
< 50 V AC																	
250 V AC																	
III																	
II																	
2																	
6 kV																	
1.2 kV AC																	
≥ 5,5 mm																	
Screw connection	PUSH IN																
0.13 mm ² / 6 mm ²	0.12 mm ² / 2.5 mm ²																
0.13 mm ² / 6 mm ²	0.12 mm ² / 2.5 mm ²																
TS 32 / TS 35	TS 32 / TS 35																
87 x 66	87 x 66																
87 x 77	87 x 77																
87 x 53	87 x 51																
<p>Electromechanical relays: 12 V DC: Spare relay RCL314012 8693240000; 24 V DC: Spare relay RCL314024 8693260000; 24 V AC/DC: Spare relay RCL314024 8693260000; 48 V DC: Spare relay RCL31404 8693380000; 115 V AC/DC: Spare relay RT314110 4058500000; 230 V AC: Spare relay RCL314730 8693320000.</p> <p>Solid-state relays: SSR 24 V DC/0-24 V DC 3.5 A 1132310000; SSR 24 V DC/max. 240 V AC 1 A 113229000.</p> <p>RCL relay: Spare relay RCI374024 8869960000</p>																	

2 changeover																	
RCL (standard) / RCI (test button)																	
Green																	
Yellow																	
CE																	
AgNi 90/10																	
250 V AC																	
5 A																	
100 mA																	
5 V DC																	
30 x 10 ⁶ / 10 x 10 ⁶ (RCL) switchings																	
5 x 10 ⁶ switching cycles																	
-25...+50 °C																	
-40...+60 °C																	
CE, EAC																	
<table border="1"> <tr> <td>< 50 V AC</td> <td></td> </tr> <tr> <td>250 V AC</td> <td></td> </tr> <tr> <td>III</td> <td></td> </tr> <tr> <td>III</td> <td></td> </tr> <tr> <td>2</td> <td></td> </tr> <tr> <td>6 kV</td> <td></td> </tr> <tr> <td>1.2 kV AC</td> <td></td> </tr> <tr> <td>≥ 5.5 mm</td> <td></td> </tr> </table>		< 50 V AC		250 V AC		III		III		2		6 kV		1.2 kV AC		≥ 5.5 mm	
< 50 V AC																	
250 V AC																	
III																	
III																	
2																	
6 kV																	
1.2 kV AC																	
≥ 5.5 mm																	
Screw connection	Tension clamp																
0.13 mm ² / 6 mm ²	0.13 mm ² / 2.5 mm ²																
0.13 mm ² / 6 mm ²	0.13 mm ² / 2.5 mm ²																
TS 32 / TS 35	TS 32 / TS 35																
109 x 71	109 x 66																
109 x 75	109 x 75																
<p>Electromechanical relays: 12 V DC: Spare relay RCL424012 4058560000; 24 V DC: Spare relay RCL424024 4058570000; 24 V AC/DC: Spare relay RCL424024 4058570000; 48 V DC: Spare relay RCL424048 4058750000; 115 V AC/DC: Spare relay RCL424110 4058590000; 230 V AC: Spare relay RCL424730 4058630000;</p> <p>RCL relay: Spare relay RCI484024 8870030000</p>																	

RSM multiple relay modules - Interfaces with 12,5 mm relays (RCL)

4 Relays - Screw/PUSH IN/Tension clamp

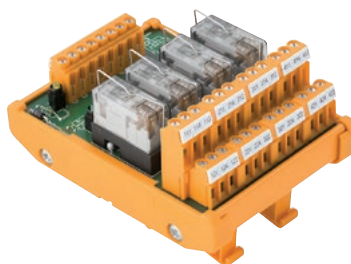
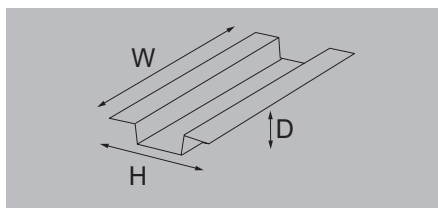

Technical data

Connection control side	Screw/Tension clamp/PUSH IN
Connection field side (1CO)	Screw/PUSH IN
Connection field side (2CO)	Screw/Tension clamp
Width	69 mm (1CO) / 75 mm (2CO)
12 V DC	
Operating voltage	12 V DC $\pm 10\%$
Rated current (dc)	33 mA
Free wheel diode	Yes
24 V DC	
Operating voltage	24 V DC $\pm 10\%$
Rated current (dc)	16.7 mA
Free wheel diode	Yes
24 V AC/DC	
Operating voltage	24 V AC/DC $\pm 10\%$
Rated current (dc)	22.9 mA
Rated current (ac)	13.9 mA
Free wheel diode	No
48 V DC	
Operating voltage	48 V DC $\pm 10\%$
Rated current (dc)	8.7 mA
Free wheel diode	Yes
115 V AC/DC	
Operating voltage	115 V AC/DC $\pm 10\%$
Rated current (dc)	4.8 mA
Rated current (ac)	3.3 mA
Free wheel diode	No
230 V AC	
Operating voltage	230 V AC $\pm 10\%$
Rated current (ac)	3.3 mA
Free wheel diode	No
Note	

Operating voltage	12 V DC $\pm 10\%$
Rated current (dc)	33 mA
Free wheel diode	Yes
Operating voltage	24 V DC $\pm 10\%$
Rated current (dc)	16.7 mA
Free wheel diode	Yes
Operating voltage	24 V AC/DC $\pm 10\%$
Rated current (dc)	22.9 mA
Rated current (ac)	13.9 mA
Free wheel diode	No
Operating voltage	48 V DC $\pm 10\%$
Rated current (dc)	8.7 mA
Free wheel diode	Yes
Operating voltage	115 V AC/DC $\pm 10\%$
Rated current (dc)	4.8 mA
Rated current (ac)	3.3 mA
Free wheel diode	No
Operating voltage	230 V AC $\pm 10\%$
Rated current (ac)	3.3 mA
Free wheel diode	No
Note	

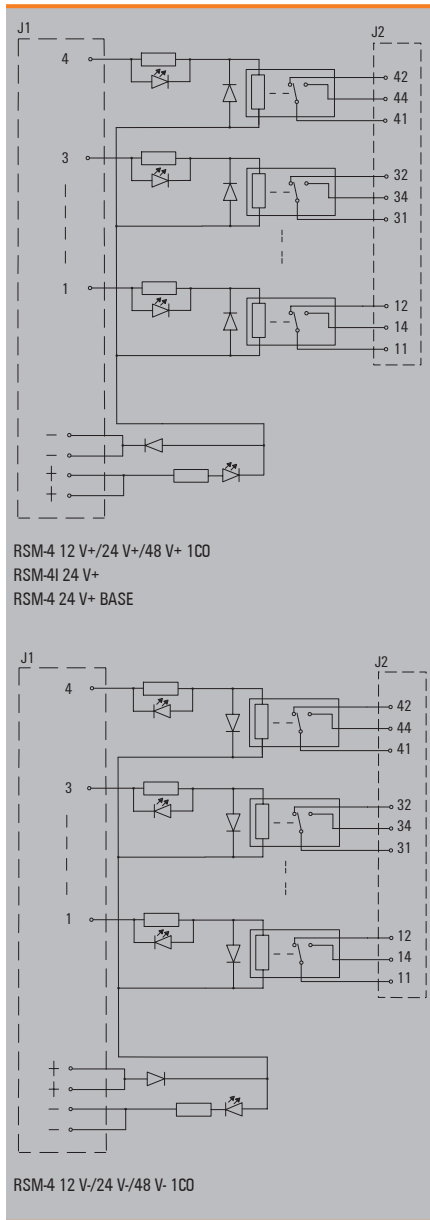

Ordering data

12 V DC	Type	Screw (S) 1CO	PUSH IN (Z) 1CO	Screw (S) 2CO	Tension clamp (Z) 2CO
12 V DC positive switching (negative common)	RSM-4 12V+	1447400000	1447420000	1448610000	1448630000
12 V DC negative switching (positive common)	RSM-4 12V-	1447410000	1447430000	1448620000	1448640000
24 V DC					
24 V DC positive switching (negative common)	RSM-4 24V+	1447440000	1447470000	1448650000	1448680000
24 V DC negative switching (positive common)	RSM-4 24V-	1447450000	1447480000	1448670000	1448690000
24 V DC positive switching (negative common) with test button	RSM-4I 24V+	1447740000	1447750000	1448820000	1448830000
24 V DC positive switching (negative common) without relays	RSM-4 24V+ BASE	1457430000	1457440000		
24 V AC/DC					
24 V AC/DC	RSM-4 24VAC/DC	1447540000	1447550000	1448740000	1448770000
48 V DC					
48 V DC positive switching (negative common)	RSM-4 48V+	1447500000	1447520000	1448700000	1448720000
48 V DC negative switching (positive common)	RSM-4 48V-	1447510000	1447530000	1448710000	1448730000
115 V AC/DC					
115 VAC/DC	RSM-4 115VAC/DC	1447570000	1447580000	1448780000	1448790000
230 V AC					
230 V AC	RSM-4 230Vac	1447600000	1447610000	1448800000	1448810000
Note					

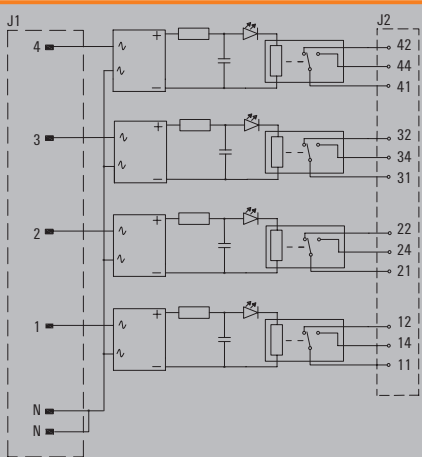

RSM-4 24 V AC/DC 1CO
RSM-4 115 V AC/DC 1CO

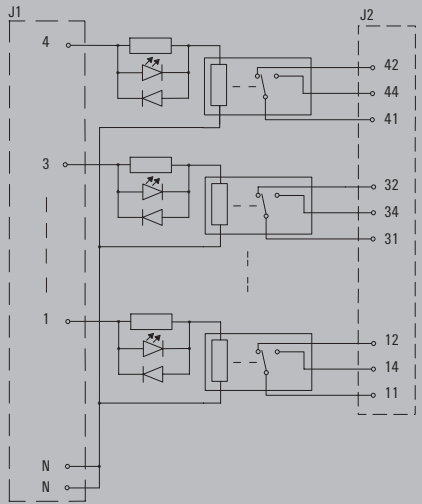

RSM-4 230 V AC 1CO

Note: Contact configuration for 2 changeover versions (2CO)

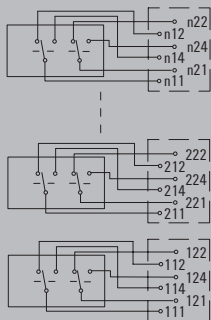

RSM multiple relay modules – Interfaces with 12,5 mm relays (RCL)

8 Relays – Screw/PUSH IN/Tension clamp

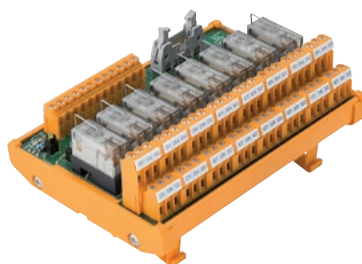
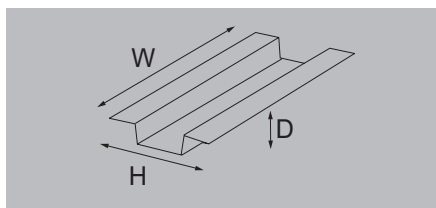

Technical data

Connection control side	Flat connector ¹⁾ 10 poles + Screw/ Tension clamp/PUSH IN
Connection field side (1CO)	Screw/PUSH IN
Connection field side (2CO)	Screw/Tension clamp
Width	130 mm (1CO) / 149 mm (2CO)
12 V DC	
Operating voltage	12 V DC ±10 %
Rated current (dc)	33 mA
Free wheel diode	Yes
24 V DC	
Operating voltage	24 V DC ±10 %
Rated current (dc)	16.7 mA
Free wheel diode	Yes
24 V AC/DC	
Operating voltage	24 V AC/DC ±10 %
Rated current (dc)	22.9 mA
Rated current (ac)	13.9 mA
Free wheel diode	No
48 V DC	
Operating voltage	48 V DC ±10 %
Rated current (dc)	8.7 mA
Free wheel diode	Yes
115 V AC/DC	
Operating voltage	115 V AC/DC ±10 %
Rated current (dc)	4.8 mA
Rated current (ac)	3.3 mA
Free wheel diode	No
230 V AC	
Operating voltage	230 V AC ±10 %
Rated current (ac)	3.3 mA
Free wheel diode	No
Note	1) Flat connector not mounted in 115 V AC/DC and 230 V AC

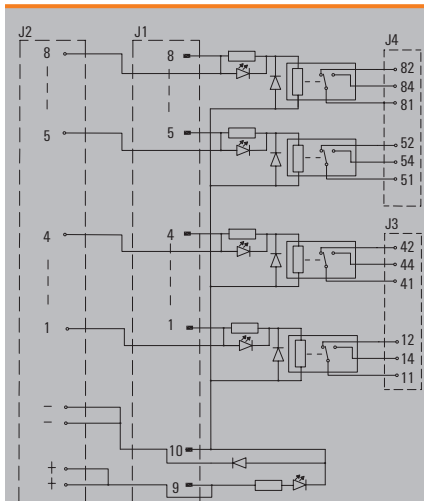

RSM-8 12 V+/24 V+/48 V+ 1CO
RSM-8I 24 V+
RSM-8 24 V+ BASE

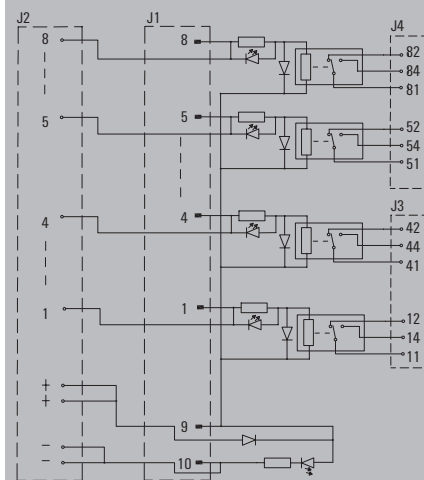

RSM-8 12 V-/24 V-/48 V- 1CO

Ordering data

12 V DC	Type	Screw (S) 1CO	PUSH IN (Z) 1CO	Screw (S) 2CO	Tension clamp (Z) 2CO
12 V DC positive switching (negative common)	RSM-8 12V+	1447820000	1447840000	1448890000	1448910000
12 V DC negative switching (positive common)	RSM-8 12V-	1447830000	1447850000	1448900000	1448920000
24 V DC					
24 V DC positive switching (negative common)	RSM-8 24V+	1447870000	1447890000	1448930000	1448950000
24 V DC negative switching (positive common)	RSM-8 24V-	1447880000	1447900000	1448940000	1448970000
24 V DC positive switching (negative common) with test button	RSM-8I 24V+	1448140000	1448170000	1449100000	1449110000
24 V DC positive switching (negative common) without relays	RSM-8 24V+ BASE	1457370000	1457380000		
24 V AC/DC					
24 V AC/DC	RSM-8 24VAC/DC	1447950000	1447970000	1449030000	1449040000
48 V DC					
48 V DC positive switching (negative common)	RSM-8 48V+	1447910000	1447930000	1448980000	1449010000
48 V DC negative switching (positive common)	RSM-8 48V-	1447920000	1447940000	1448990000	1449020000
115 V AC/DC					
115 VAC/DC	RSM-8 115VAC/DC	1447980000	1447990000	1449050000	1449070000
230 V AC					
230 V AC	RSM-8 230Vac	1448000000	1448010000	1449080000	1449090000
Note					

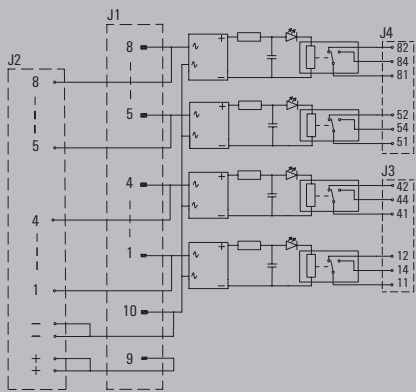

RSM-8 24 V AC/DC 1CO

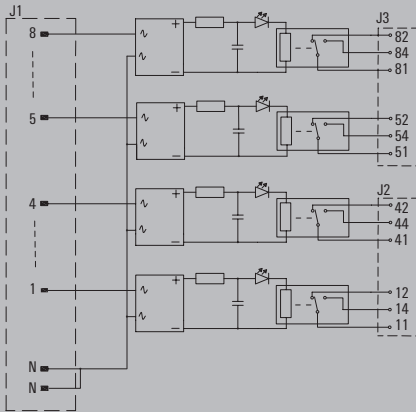

RSM-8 115 V AC/DC 1CO

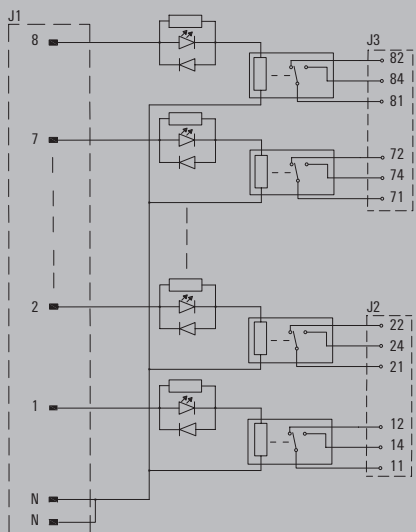

RSM-8 230 V AC 1CO

Note: Contact configuration for 2 changeover versions (2CO)

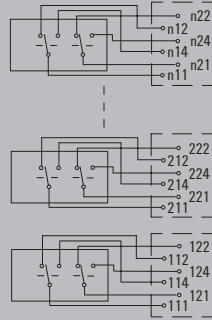

RSM multiple relay modules – Interfaces with 12,5 mm relays (RCL)

16 Relays – Screw/PUSH IN/Tension clamp

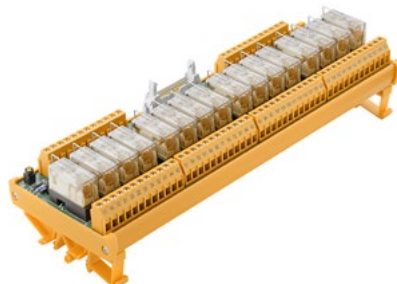
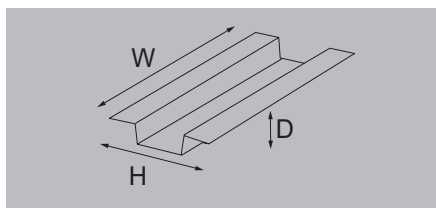

Technical data

Connection control side	
Connection field side (1CO)	
Connection field side (2CO)	
Width	
12 V DC	
Operating voltage	12 V DC ±10 %
Rated current (dc)	33 mA
Free wheel diode	Yes
24 V DC	
Operating voltage	24 V DC ±10 %
Rated current (dc)	16.7 mA
Free wheel diode	Yes
24 V AC/DC	
Operating voltage	24 V AC/DC ±10 %
Rated current (dc)	22.9 mA
Rated current (ac)	13.9 mA
Free wheel diode	No
48 V DC	
Operating voltage	48 V DC ±10 %
Rated current (dc)	8.7 mA
Free wheel diode	Yes
115 V AC/DC	
Operating voltage	115 V AC/DC ±10 %
Rated current (dc)	4.8 mA
Rated current (ac)	3.3 mA
Free wheel diode	No
230 V AC	
Operating voltage	230 V AC ±10 %
Rated current (ac)	3.3 mA
Free wheel diode	No
Note	1) Flat connector not mounted in 115 V AC/DC and 230 V AC

Flat connector ¹⁾ 20 poles + Screw/ Tension clamp/PUSH IN	
Screw/PUSH IN	
Screw/Tension clamp	
259 mm (1CO) / 290 mm (2CO)	

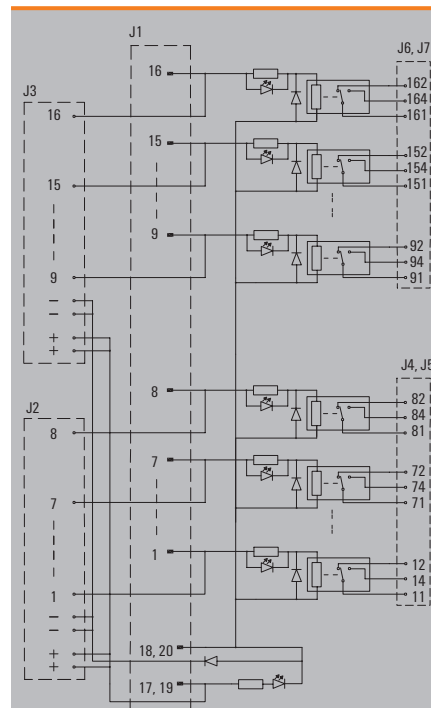

RSM-16 12 V+/24 V+/48 V+ 1CO
 RSM-16I 12 V+/24 V+/48 V+ 1CO
 RSM-16 24 V+ BASE

Ordering data

12 V DC	Type	Screw (S) 1CO	PUSH IN (Z) 1CO	Screw (S) 2CO	Tension clamp (Z) 2CO
12 V DC positive switching (negative common)	RSM-16 12V+	1448230000	1448250000	1449170000	1449190000
12 V DC negative switching (positive common)	RSM-16 12V-	1448240000	1448270000	1449180000	1449200000
24 V DC					
24 V DC positive switching (negative common)	RSM-16 24V+	1448280000	1448300000	1449210000	1449230000
24 V DC negative switching (positive common)	RSM-16 24V-	1448290000	1448310000	1449220000	1449250000
24 V DC positive switching (negative common) with test button	RSM-16I 24V+	1448540000	1448550000	1449380000	1449390000
24 V DC positive switching (negative common) without relays	RSM-16 24V+ BASE	1448480000	1448490000		
24 V AC/DC					
24 V AC/DC	RSM-16 24VAC/DC	1448370000	1448380000	1449310000	1449320000
48 V DC					
48 V DC positive switching (negative common)	RSM-16 48V+	1448320000	1448340000	1449270000	1449290000
48 V DC negative switching (positive common)	RSM-16 48V-	1448330000	1448350000	1449280000	1449300000
115 V AC/DC					
115 VAC/DC	RSM-16 115VAC/DC	1448390000	1448400000	1449330000	1449340000
230 V AC					
230 V AC	RSM-16 230Vac	1448410000	1448420000	1449350000	1449370000

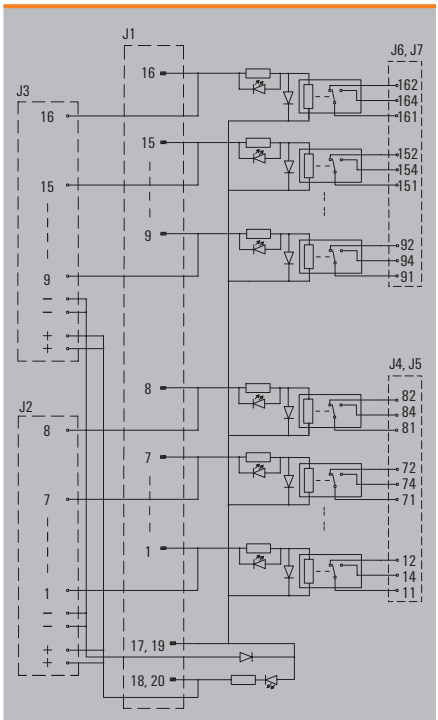

RSM-16 12 V-24 V-48 V-1C0

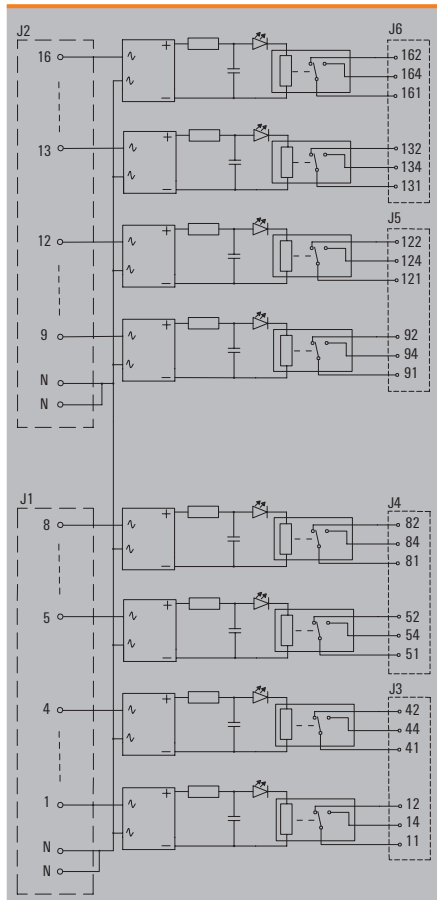

RSM-16 115 V AC/DC 1C0

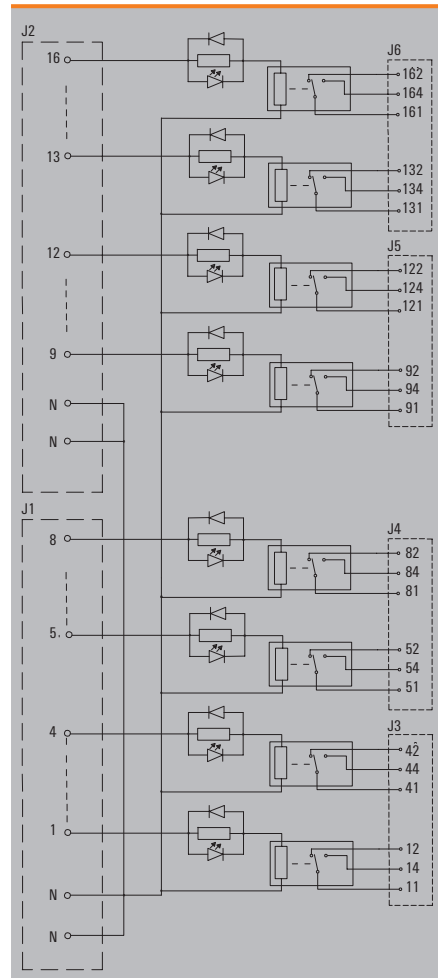

RSM-16 230 V AC 1C0

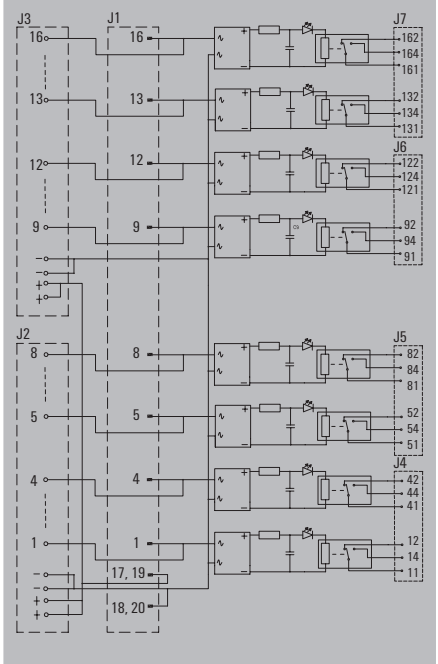

RSM-16 24 V AC/DC 1C0

Note: Contact configuration for 2 changeover versions (2C0)

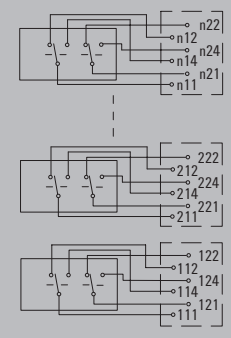

RSMS 1CO – Relay interface

1 changeover

- Interface from 8 to 16 electromechanical relays
- 1 changeover
- Positive or negative switching or ac/dc
- Flat-connector available to make easy the connection to PLC'S
- Compatible with solid-state relays
- With optional gold contact relay
- Screw and tension clamp

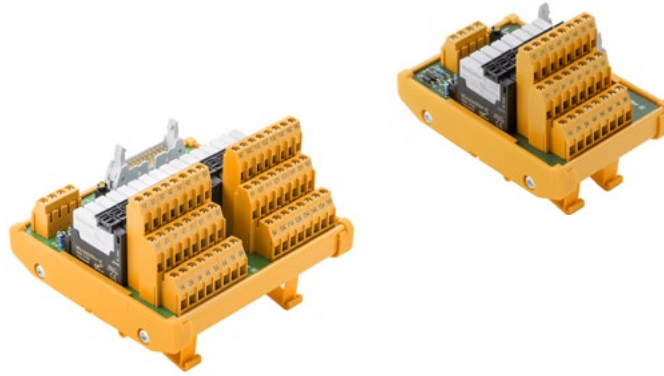

General technical data

General features

Relay
LED status display per channel
LED status of the supply voltage

Nominal output data

Contact material
Operative voltage
Max. AC continuous current
Minimum contact current standard / Gold
Minimum contact voltage standard / Gold
Mechanical service life (dc coil)
Operating temperature
Storage temperature

Insulation coordination (EN 50178)

Rated input insulation voltage
Rated output insulation voltage
Overvoltage category input/output
Overvoltage category output/input
Pollution severity level
Impulse voltage test (1.2/50µs)
Insulation test voltage
Clearance input/output

Dimensions

Clamping range, min. [Field]/ Clamping range, max. [Field]
Clamping range, min. [supply]/Clamping range, max. [supply]
Mounting rail
Height / Depth

mm

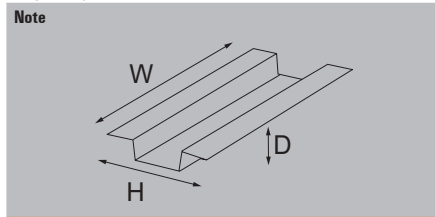

General features

RSS relay
Green
Yellow

AgNi 90/10 / AgNi 5µAu

250 V AC

4.5 A

100 mA / 1 mA

5 V / 1 V

5 x 10⁶ Switching cycles

-25...+50 °C

-40...+60 °C

< 50 V AC

250 V AC

III

II

2

6 kV

1.2 kV AC

≥ 5,5 mm

Screw connection

0.13 mm²/ 6 mm²

0.13 mm²/ 6 mm²

TS 32 / TS 35

109 x 85

Tension clamp

0.13 mm²/ 2.5 mm²

0.2 mm²/ 2.5 mm²

TS 32 / TS 35

109 x 76

Electromechanical relays:

5 V DC: Spare Relay RSS113005 4061580000;

12 V DC: Spare relay RSS113012 4061610000;

24 V DC: Spare relay RSS113024 4060120000;

24 V AC/DC: Spare relay RSS113024 4060120000;

48 V DC: Spare relay RSS113048 4061620000;

24 V DC Gold contact: Spare relay RSS112024 4061590000

Solid-state relays:

SSR 24 V DC/24 V DC 0.1 A 4061180000;

SSR 24 V DC/24 V DC 2 A 4061190000;

SSR 24 V DC/230 V AC 1 AC 4061210000.

RSMS multiple relay modules – Interfaces with 6,1 mm relays (RCL)

8-16 Relays – Screw/Tension clamp connection

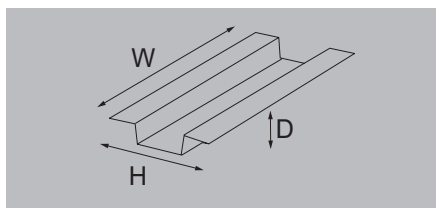

Technical data

Connection control side	Flat connector 20 poles
Connection field side	Screw/Tension clamp
Width (RSM-8 / RSM-16)	61 / 112 mm
24 V DC	
Operating voltage	24 V DC $\pm 10\%$
Rated current (dc)	7.1 mA
Free wheel diode	Yes
Note	

Ordering data

24 V DC		Type	Screw (S)	Tension clamp (Z)
8 Relays	24 V DC positive switching (negative common) with flat connector	RSMS-8H 24V+ 1C0	1456540000	1456570000
	24 V DC negative switching (positive common) with flat connector	RSMS-8H 24V- 1C0	1456550000	1456580000
16 Relays	24 V DC positive switching (negative common) with flat connector	RSMS-16H 24V+ 1C0	1457300000	1457320000
	24 V DC negative switching (positive common) with flat connector	RSMS-16H 24V- 1C0	1457310000	1457330000
Note				

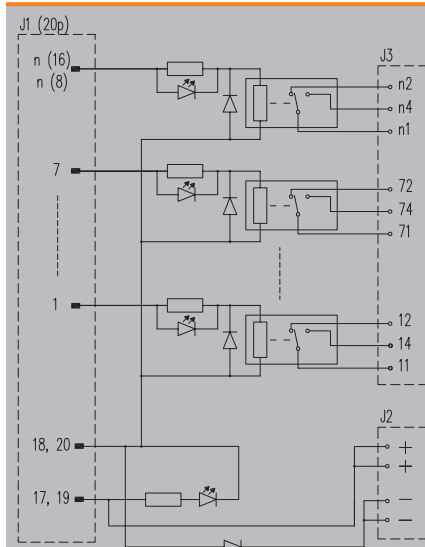

RSMS-8H 24 V+ 1C0
RSMS-16H 24 V+ 1C0

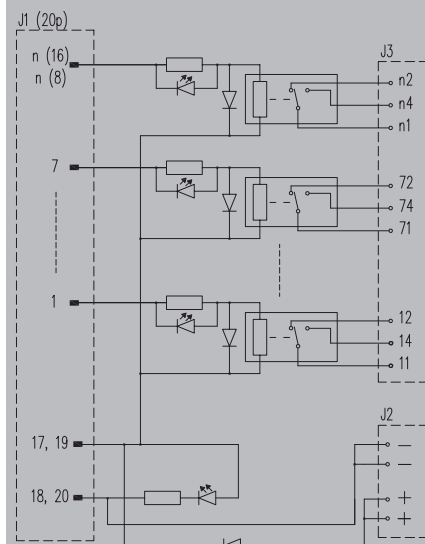

RSMS-8H 24 V- 1C0
RSMS-16H 24 V- 1C0

8-16 Relays – Screw/Tension clamp connection

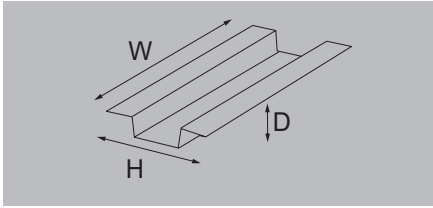

Technical data

Connection control side
 Connection field side
 Width (8 relays) / Length (16 relays)

12 V DC

Operating voltage
 Rated current (dc)
 Free wheel diode

24 V DC

Operating voltage
 Rated current (dc)
 Free wheel diode

24 V AC/DC

Operating voltage
 Rated current (dc)
 Rated current (ac)
 Free wheel diode

48 V DC

Operating voltage
 Rated current (dc)
 Free wheel diode

Note

Screw/Tension clamp
 Screw/Tension clamp
 61 / 112 mm

12 V DC ±10 %
 14.2 mA
 Yes

24 V DC ±10 %
 7.1 mA
 Yes

24 V AC/DC ±10 %
 6 mA
 15.6 mA
 No

48 V DC ±10 %
 4.5 mA
 Yes

Ordering data

12 V DC		Type	Screw (S)	Tension clamp (Z)
8 Relays	12 V DC positive switching (negative common)	RSMS-8 12V+ 1CO	1456590000	1456690000
	12 V DC negative switching (positive common)	RSMS-8 12V- 1CO	1456640000	1456730000
16 Relays	12 V DC positive switching (negative common)	RSMS-16 12V+ 1CO	1457000000	1457040000
	12 V DC negative switching (positive common)	RSMS-16 12V- 1CO	1457000000	1457090000
24 V DC				
8 Relays	24 V DC positive switching (negative common)	RSMS-8 24V+ 1CO	1456610000	1456700000
	24 V DC negative switching (positive common)	RSMS-8 24V- 1CO	1456650000	1456740000
16 Relays	24 V DC positive switching (negative common) without relays	RSMS-8 24V+ BASE	1456810000	
	24 V DC positive switching (negative common)	RSMS-16 24V+ 1CO	1456970000	1457050000
	24 V DC negative switching (positive common)	RSMS-16 24V- 1CO	1457010000	1457100000
	24 V DC positive switching (negative common) without relays	RSMS-16 24V+ BASE	1457170000	1457180000
24 V AC/DC				
8 Relays	24 V AC/DC	RSMS-8 24VAC/DC 1CO	1456830000	
	24 V AC/DC with Gold contact	RSMS-8 24VUC AU 1CO	1456840000	
16 Relays	24 V AC/DC	RSMS-16 24VAC/DC 1CO	1457190000	1457210000
	24 V AC/DC with Gold contact	RSMS-16 24VUC AU 1CO	1457200000	1457220000
48 V DC				
8 Relays	48 V DC positive switching (negative common)	RSMS-8 48V+ 1CO	1456620000	1456710000
	48 V DC negative switching (positive common)	RSMS-8 48V- 1CO	1456670000	1456750000
16 Relays	48 V DC positive switching (negative common)	RSMS-16 48V+ 1CO	1456980000	1457070000
	48 V DC negative switching (positive common)	RSMS-16 48V- 1CO	1457020000	1457110000

Note

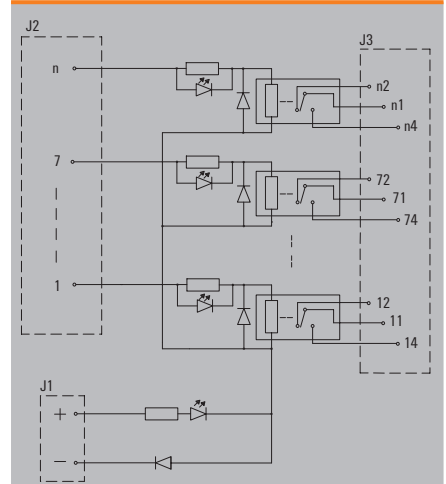

RSMS-8 12 V+/24 V+/48 V+ 1CO
 RSMS-16 12 V+/24 V+/48 V+ 1CO
 RSMS-8 24 V+ BASE
 RSMS-16 24 V+ BASE

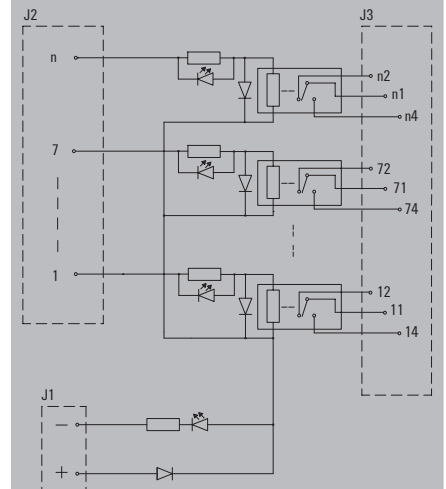

RSMS-8 12 V-/24 V-/48 V- 1CO
 RSMS-16 12 V-/24 V-/48 V- 1CO

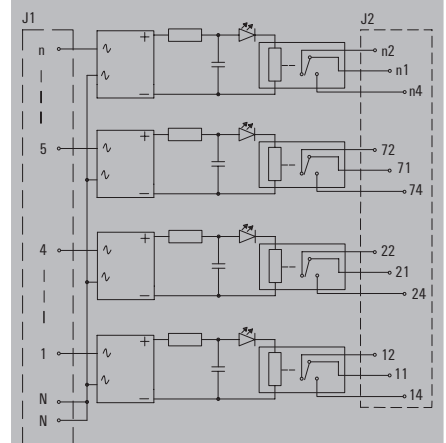

RSMS-8 24 V AC/DC 1CO
 RSMS-16 24 V AC/DC 1CO

Faster signal wiring taking up less space

Our interface adapters for TERMSERIES relays reduce wiring times thanks to plug-and-play

Extensive wiring complexity leads to high throughput times in electrical cabinets. Thanks to our TERMSERIES interface adapter, you benefit from the speed of our plug-and-play solution.

To reduce wiring times, pre-assembled lines are used between the controller and interface level and are simply connected to the TERMSERIES adapter. This enables electrical cabinet throughput times to be significantly reduced.

E

Our pre-assembled plug-and-play solution with TERMSERIES interface adapter minimises wiring complexity. The adapter has a universal fit and offers a genuine space advantage in conjunction with TERMSERIES products with identical contours.

Thanks to its symmetrical structure, the adapter can be connected to both TERMSERIES coil and contact connections. The use of positive and negative switching logic is also possible for the lower level with the aid of the potential changeover switch.

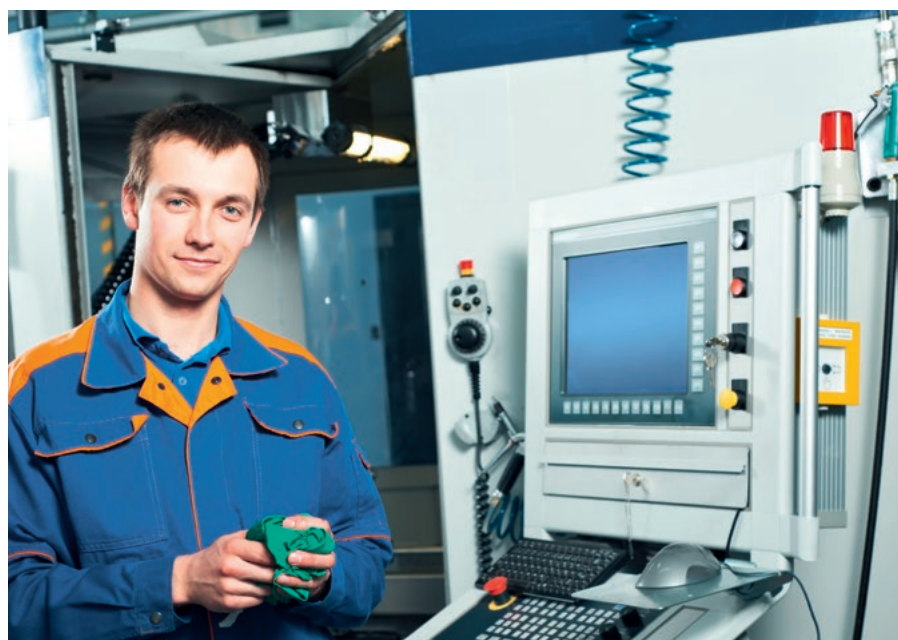

Configure wiring-intensive cabinets faster

Wiring complexity is especially high for electrical cabinets builders of standardised series cabinets in the field of machine construction and plant manufacture, process control technology and in shipbuilding. The wiring and throughput times of your machines can be reduced with the use of TERMSERIES interface adapters.

Connection to a variety of controllers
 The standardised ribbon cable plug-in connections enable connection of all the interface system's pre-assembled cable types.

Fast supply and bridging of the auxiliary voltage
 Quick and safe supply of the auxiliary voltage as a result of the TOP connection with "PUSH IN" technology. Simple bridging is also possible thanks to duplication of the connections.

Reliable and unambiguous wiring
 Installation is unambiguous and safe thanks to practical marking of the connections, assignment of the contacts and the option of individual marking using MultiCard.



Both types of logic with one device
 The potential switch for the lower level allows the adapter for plus and minus switching logic to be used.

Connection with our remote I/O system u-remote
 Use our perfectly matched cable harness for connecting our u-remote DI/DO sub assemblies and TERMSERIES relays.



PLC interface selection tables

The following Selection guides enable you to quickly and easily choose the correct products according to your application needs

Choose the PLC Card:

In the same row you can find the number of cable required, the TERMSERIES adapter and the TERMSERIES relays to make the connection with the selected PLC Card.

3 options are possible:

- 8 channels with TERMSERIES 6.4 mm
- 8 channels with TERMSERIES 12.8 mm
- 16 channels with TERMSERIES 6.4 mm

Note: Technical information about TERMSERIES Adapter and relays can be found in Weimüller Catalogue 4.2 Relays and solid-state relays

PLC ABB S800

8-channel solution

	PLC		Cables		Connection		TERMSERIES adapter				TERMSERIES adapter			
	Input/Output cards		Standard				TERMSERIES adapter (Relay 6.4 mm)				TERMSERIES adapter (Relay 12.8 mm)			
	Manufacturer code	Number/Type of channels	Order No.	Qty.	Screw connection	PUSH IN connection	TERMSERIES adapter		Inputs or outputs with relays		TERMSERIES adapter		Inputs or outputs with relays	
							Order No.	Qty.	Order No.	Qty.	Order No.	Qty.	Order No.	Qty.
DI	DI810	16 DI ^{B)}	1512410xxx	1			1463520000	2	1123000000 2618110000	16	1463540000	2	1123730000 2618530000	16
	DI814	16 DI ^{A)}	1512410xxx	1			1463520000	2	1123000000 2618110000	16	1463540000	2	1123730000 2618530000	16
	DI830	16 DI ^{B)}	1512410xxx	1			1463520000	2	1123000000 2618110000	16	1463540000	2	1123730000 2618530000	16
	DI840	16 DI ^{B)}	1512410xxx	1			1463520000	2	1123000000 2618110000	16	1463540000	2	1123730000 2618530000	16
	DI880	16 DI ^{B)}	1512410xxx	1			1463520000	2	1123000000 2618110000	16	1463540000	2	1123730000 2618530000	16
DO	DO810	16 DO ^{A)}	1512410xxx	1			1463520000	2	1122770000 2618000000	16	1463540000	2	1123490000 2618400000	16
	DO814	16 DO ^{B)}	1512410xxx	1			1463520000	2	1122780000 1122890000	16	1463540000	2	1123500000 1123620000	16
	DO815	8 DO ^{A)}	1512390xxx	1			1463520000	1	1122770000 2618000000	8	1463540000	1	1123490000 2618400000	8
	DO840	16 DO ^{A)}	1512410xxx	1			1463520000	2	1122770000 2618000000	16	1463540000	2	1123490000 2618400000	16
	DO880	16 DO ^{A)}	1512410xxx	1			1463520000	2	1122770000 2618000000	16	1463540000	2	1123490000 2618400000	16

Note
 A) The TERMSERIES adapter switch, should be positioned on the "A" side.
 B) The TERMSERIES adapter switch, should be positioned on the "B" side.

- The adapters should receive power from an external supply.
- The last 3 digits of the cable code indicates its length in decimeters. For example, if the code ends in 100, the cable would be 10 m long.
- The relays indicated in the table are chosen for 24 V DC control voltage. For digital input cards these can be replaced by TERMSERIES relays with control voltages from 5 V DC to 230 V AC.

PLC ABB S800

16-channel solution









	PLC		Cables		Connection		TERMSERIES adapter			
	Input/Output cards		Standard				TERMSERIES adapter (Relay 6.4 mm)			
	Manufacturer code	Number/Type of channels	Order No.	Qty.	Screw connection	PUSH IN connection	TERMSERIES adapter		Inputs or outputs with relays	
							Order No.	Qty.	Order No.	Qty.
DI	DI810	16 DI ^{B)}	7789641xxx	1			1463550000	1	1123000000 2618110000	16
	DI814	16 DI ^{A)}	7789641xxx	1			1463550000	1	1123000000 2618110000	16
	DI830	16 DI ^{B)}	7789641xxx	1			1463550000	1	1123000000 2618110000	16
	DI840	16 DI ^{B)}	7789641xxx	1			1463550000	1	1123000000 2618110000	16
	DI880	16 DI ^{B)}	7789641xxx	1			1463550000	1	1123000000 2618110000	16
DO	DO810	16 DO ^{A)}	7789641xxx	1			1463550000	1	1122770000 2618000000	16
	DO814	16 DO ^{B)}	7789641xxx	1			1463550000	1	1122780000 1122890000	16
	DO840	16 DO ^{A)}	7789641xxx	1			1463550000	1	1122770000 2618000000	16
	DO880	16 DO ^{A)}	7789641xxx	1			1463550000	1	1122770000 2618000000	16

Note
 A) The TERMSERIES adapter switch, should be positioned on the "A" side.
 B) The TERMSERIES adapter switch, should be positioned on the "B" side.

- The adapters should receive power from an external supply.
- The last 3 digits of the cable code indicates its length in decimeters. For example, if the code ends in 100, the cable would be 10 m long.
- The relays indicated in the table are chosen for 24 V DC control voltage. For digital input cards these can be replaced by TERMSERIES relays with control voltages from 5 V DC to 230 V AC.

PLC EMERSON DELTA V

8-channel solution









	PLC		Cables		Connection		TERMSERIES adapter				TERMSERIES adapter			
	Input/Output cards		Standard				TERMSERIES adapter (Relay 6.4 mm)				TERMSERIES adapter (Relay 12.8 mm)			
	Manufacturer code	Number/ Type of channels	Order No.	Qty.	Screw connection	PUSH IN connection	TERMSERIES adapter		Inputs or outputs with relays		TERMSERIES adapter		Inputs or outputs with relays	
							Order No.	Qty.	Order No.	Qty.	Order No.	Qty.	Order No.	Qty.
DI	VE4001S2T2B4	32 DI ^{A)}	1349730xxx	4			1463520000	4	1123000000 2618110000	32	1463540000	4	1123730000 2618530000	32
	VE4001S2T2B5	32 DI ^{A)}	1512370xxx	2			1463520000	4	1123000000 2618110000	32	1463540000	4	1123730000 2618530000	32
DO	VE4002S1T2B5	32 DO ^{A)}	134973xxx	4			1463520000	4	1122770000 2618000000	32	1463540000	4	1123490000 2618400000	32
	VE4002S1T2B6	32 DO ^{A)}	1512370xxx	2			1463520000	4	1122770000 2618000000	32	1463540000	4	1123490000 2618400000	32

Note
A) The TERMSERIES adapter switch, should be positioned on the "A" side.
B) The TERMSERIES adapter switch, should be positioned on the "B" side.

- The adapters should receive power from an external supply
- The last 3 digits of the cable code indicates its length in decimeters. For example, if the code ends in 100, the cable would be 10 m long
- The relays indicated in the table are chosen for 24 V DC control voltage. For digital input cards these can be replaced by TERMSERIES relays with control voltages from 5 V DC to 230 V AC.

PLC EMERSON DELTA V

16-channel solution





































	PLC		Cables		Connection		TERMSERIES adapter			
	Input/Output cards		Standard				TERMSERIES adapter (Relay 6.4 mm)			
	Manufacturer code	Number/ Type of channels	Order No.	Qty.	Screw connection	PUSH IN connection	TERMSERIES adapter		Inputs or outputs with relays	
							Order No.	Qty.	Order No.	Qty.
DI	VE4001S2T2B4	32 DI ^{A)}	7789100xxx	2			1463550000	2	1123000000 2618110000	32
	VE4001S2T2B5	32 DI ^{A)}	7789301xxx	2			1463550000	2	1123000000 2618110000	32
DO	VE4002S1T2B5	32 DO ^{A)}	7789100xxx	2			1463550000	2	1122770000 2618000000	32
	VE4002S1T2B6	32 DO ^{A)}	7789301xxx	2			1463550000	2	1122770000 2618000000	32

Note
A) The TERMSERIES adapter switch, should be positioned on the "A" side.
B) The TERMSERIES adapter switch, should be positioned on the "B" side.

- The adapters should receive power from an external supply
- The last 3 digits of the cable code indicates its length in decimeters. For example, if the code ends in 100, the cable would be 10 m long
- The relays indicated in the table are chosen for 24 V DC control voltage. For digital input cards these can be replaced by TERMSERIES relays with control voltages from 5 V DC to 230 V AC.

PLC GE FANUC RX3I

8-channel solution































	PLC		Cables		Connection		TERMSERIES adapter				TERMSERIES adapter			
	Input/Output cards		Standard				TERMSERIES adapter (Relay 6.4 mm)		TERMSERIES adapter (Relay 12.8 mm)					
	Manufacturer code	Number/ Type of channels	Order No.	Qty.	Screw connection	PUSH IN connection	TERMSERIES adapter		Inputs or outputs with relays		TERMSERIES adapter		Inputs or outputs with relays	
							Order No.	Qty.	Order No.	Qty.	Order No.	Qty.	Order No.	Qty.
DI	IC694MDL241	16 DI, DC positive logic ^{B)}	2680860xxx	1			1463520000	2	1123000000	16	1463540000	2	1123730000	16
		16 DI, DC negative logic ^{A)}	2680870xxx	1			1463520000	2	1123000000	16	1463540000	2	1123730000	16
	IC694MDL634	8 DI, positive logic ^{B)}	2680890xxx	1			1463520000	1	1123000000	8	1463540000	1	1123730000	8
		8 DI, negative logic ^{A)}	2680900xxx	1			1463520000	1	1123000000	8	1463540000	1	1123730000	8
	IC694MDL645	16 DI, positive logic ^{B)}	2680860xxx	1			1463520000	2	1123000000	16	1463540000	2	1123730000	16
		16 DI, negative logic ^{A)}	2680870xxx	1			1463520000	2	1123000000	16	1463540000	2	1123730000	16
	IC694MDL646	16 DI, positive logic ^{B)}	2680860xxx	1			1463520000	2	1123000000	16	1463540000	2	1123730000	16
		16 DI, negative logic ^{A)}	2680870xxx	1			1463520000	2	1123000000	16	1463540000	2	1123730000	16
	IC694MDL655	32 DI, positive logic ^{B)}	1511540xxx	2			1463520000	4	1123000000	32	1463540000	4	1123730000	32
		32 DI, negative logic ^{A)}	1511570xxx	2			1463520000	4	1123000000	32	1463540000	4	1123730000	32
	IC694MDL660	32 DI, positive logic ^{B)}	1511840xxx	1			1463520000	4	1123000000	32	1463540000	4	1123730000	32
	DO	IC694MDL732	8 DO, 24 V DC ^{A)}	2680910xxx	1			1463520000	1	1122770000	8	1463540000	1	1123490000
IC694MDL740		16 DO, 24 V DC ^{A)}	2680880xxx	1			1463520000	2	1122770000	16	1463540000	2	1123490000	16
IC694MDL741		16 DO, 24 V DC ^{B)}	2680880xxx	1			1463520000	2	1122780000	16	1463540000	2	1123500000	16
IC694MDL742		16 DO, 24 V DC ^{A)}	2680880xxx	1			1463520000	2	1122770000	16	1463540000	2	1123490000	16
IC694MDL752		32 DO, 24 V DC ^{B)}	1511620xxx	2			1463520000	4	1122780000	32	1463540000	4	1123500000	32
IC694MDL753		32 DO, 24 V DC ^{A)}	1511620xxx	2			1463520000	4	1122770000	32	1463540000	4	1123490000	32
IC694MDL754		32 DO, 24 V DC ^{A)}	1512670xxx	1			1463520000	4	1122770000	32	1463540000	4	1123490000	32

Note
 A) The TERMSERIES adapter switch, should be positioned on the "A" side.
 B) The TERMSERIES adapter switch, should be positioned on the "B" side.

- The adapters should receive power from an external supply.
- The last 3 digits of the cable code indicates its length in decimeters. For example, if the code ends in 100, the cable would be 10 m long.
- The relays indicated in the table are chosen for 24 V DC control voltage. For digital input cards these can be replaced by TERMSERIES relays with control voltages from 5 V DC to 230 V AC.

PLC GE FANUC RX3I

16-channel solution













	PLC		Cables		Connection		TERMSERIES adapter			
	Input/Output cards		Standard				TERMSERIES adapter (Relay 6.4 mm)			
	Manufacturer code	Number/ Type of channels	Order No.	Qty.	Screw connection	PUSH IN connection	TERMSERIES adapter		Inputs or outputs with relays	
							Order No.	Qty.	Order No.	Qty.
DI	IC694MDL241	16 DI, DC positive logic ^{B)}	2680630xxx	1			1463550000	1	1123000000	16
		16 DI, DC negative logic ^{A)}	2680680xxx	1			1463550000	1	1123000000	16
	IC694MDL645	16 DI, positive logic ^{B)}	2680630xxx	1			1463550000	1	1123000000	16
		16 DI, negative logic ^{A)}	2680680xxx	1			1463550000	1	1123000000	16
	IC694MDL646	16 DI, positive logic ^{B)}	2680630xxx	1			1463550000	1	1123000000	16
		16 DI, negative logic ^{A)}	2680680xxx	1			1463550000	1	1123000000	16
	IC694MDL655	32 DI, positive logic ^{B)}	7789066xxx	2			1463550000	2	1123000000	32
		32 DI, negative logic ^{A)}	2680680xxx	2			1463550000	2	1123000000	32
	IC694MDL660	32 DI, positive logic ^{B)}	7789619xxx	1			1463550000	2	1123000000	32
	DO	IC694MDL740	16 DO, 24 V DC ^{A)}	2680640xxx	1			1463550000	1	1122770000
IC694MDL741		16 DO, 24 V DC ^{B)}	2680640xxx	1			1463550000	1	1122780000	16
IC694MDL742		16 DO, 24 V DC ^{A)}	2680640xxx	1			1463550000	1	1122770000	16
IC694MDL752		32 DO, 24 V DC ^{B)}	7789066xxx	1			1463550000	2	1122780000	32
IC694MDL753		32 DO, 24 V DC ^{A)}	7789066xxx	1			1463550000	2	1122770000	32
IC694MDL754		32 DO, 24 V DC ^{A)}	7789618xxx	1			1463550000	2	1122770000	32

Note A) The TERMSERIES adapter switch, should be positioned on the "N" side.
 B) The TERMSERIES adapter switch, should be positioned on the "N+" side.

- The adapters should receive power from an external supply.
- The last 3 digits of the cable code indicates its length in decimeters. For example, if the code ends in 100, the cable would be 10 m long.
- The relays indicated in the table are chosen for 24 V DC control voltage. For digital input cards these can be replaced by TERMSERIES relays with control voltages from 5 V DC to 230 V AC.

PLC HONEYWELL C200

8-channel solution













	PLC		Cables		Connection		TERMSERIES adapter				TERMSERIES adapter			
	Input/Output cards		Standard				TERMSERIES adapter (Relay 6.4 mm)				TERMSERIES adapter (Relay 12.8 mm)			
	Manufacturer code	Number/Type of channels	Order No.	Qty.	Screw connection	PUSH IN connection	TERMSERIES adapter		Inputs or outputs with relays		TERMSERIES adapter		Inputs or outputs with relays	
							Order No.	Qty.	Order No.	Qty.	Order No.	Qty.	Order No.	Qty.
DI	TC-IDX161/ TK-IDX161	16 DI ^{B)}	1511990xxx	1			1463520000	2	1123000000 2618110000	16	1463540000	2	1123730000 2618530000	16
	TC-IDJ161/ TK-IDJ161	16 DI ^{B)}	1511990xxx	1			1463520000	2	1123000000 2618110000	16	1463540000	2	1123730000 2618530000	16
	TC-IDD321/ TK-IDD321	32 DI ^{B)}	1512010xxx	1			1463520000	4	1123000000 2618110000	32	1463540000	4	1123730000 2618530000	32
DO	TC-ODX161/ TK-ODX161	16 DO ^{A)}	1512030xxx	1			1463520000	2	1122770000 2618000000	16	1463540000	2	1123490000 2618400000	16
	TC-ODJ161/ TK-ODJ161	16 DO ^{A)}	1512070xxx	1			1463520000	2	1122770000 2618000000	16	1463540000	2	1123490000 2618400000	16
	TC-ODD321/ TK-ODD321	32 DO ^{A)}	1512020xxx	1			1463520000	4	1122770000 2618000000	32	1463540000	4	1123490000 2618400000	32

Note
 A) The TERMSERIES adapter switch, should be positioned on the "–" side.
 B) The TERMSERIES adapter switch, should be positioned on the "+ " side.

- The adapters should receive power from an external supply
- The last 3 digits of the cable code indicates its length in decimeters. For example, if the code ends in 100, the cable would be 10 m long
- The relays indicated in the table are chosen for 24 V DC control voltage. For digital input cards these can be replaced by TERMSERIES relays with control voltages from 5 V DC to 230 V AC.

PLC HONEYWELL C200

16-channel solution









	PLC		Cables		Connection		TERMSERIES adapter			
	Input/Output cards		Standard				TERMSERIES adapter (Relay 6.4 mm)			
	Manufacturer code	Number/Type of channels	Order No.	Qty.	Screw connection	PUSH IN connection	TERMSERIES adapter		Inputs or outputs with relays	
							Order No.	Qty.	Order No.	Qty.
DI	TC-IDX161/ TK-IDX161	16 DI ^{B)}	7789049xxx	1			1463550000	1	1123000000 2618110000	16
	TC-IDJ161/ TK-IDJ161	16 DI ^{B)}	7789049xxx	1			1463550000	1	1123000000 2618110000	16
	TC-IDD321/ TK-IDD321	32 DI ^{B)}	7789041xxx	1			1463550000	2	1123000000 2618110000	32
DO	TC-ODX161/ TK-ODX161	16 DO ^{A)}	7789040xxx	1			1463550000	1	1122770000 2618000000	16
	TC-ODJ161/ TK-ODJ161	16 DO ^{A)}	7789059xxx	1			1463550000	1	1122770000 2618000000	16
	TC-ODD321/ TK-ODD321	32 DO ^{A)}	7789042xxx	1			1463550000	2	1122770000 2618000000	32

Note
 A) The TERMSERIES adapter switch, should be positioned on the "–" side.
 B) The TERMSERIES adapter switch, should be positioned on the "+ " side.

- The adapters should receive power from an external supply
- The last 3 digits of the cable code indicates its length in decimeters. For example, if the code ends in 100, the cable would be 10 m long
- The relays indicated in the table are chosen for 24 V DC control voltage. For digital input cards these can be replaced by TERMSERIES relays with control voltages from 5 V DC to 230 V AC.

PLC HONEYWELL C300

8-channel solution









	PLC		Cables		Connection		TERMSERIES adapter				TERMSERIES adapter			
	Input/Output cards		Standard				TERMSERIES adapter (Relay 6.4 mm)				TERMSERIES adapter (Relay 12.8 mm)			
	Manufacturer code	Number/ Type of channels	Order No.	Qty.			TERMSERIES adapter		Inputs or outputs with relays		TERMSERIES adapter		Inputs or outputs with relays	
							Order No.	Qty.	Order No.	Qty.	Order No.	Qty.	Order No.	Qty.
DI	CC-TDIL01	32 DI, 24 Vdc ^{B)}	2065090xxx	2			1463520000	4	1123000000 2618110000	32	1463540000	4	1123730000 2618530000	32
	CC-TDIL11	32 DI, 24 Vdc ^{B)}	2065090xxx	2			1463520000	4	1123000000 2618110000	32	1463540000	4	1123730000 2618530000	32
DO	CC-TDOB01	32 DO, 24 Vdc ^{A)}	2065080xxx	2			1463520000	4	1122770000 2618000000	32	1463540000	4	1123490000 2618400000	32
	CC-TDOB11	32 DO, 24 Vdc ^{A)}	2065080xxx	2			1463520000	4	1122780000 1122890000	32	1463540000	4	1123490000 2618400000	32

Note
A) The TERMSERIES adapter switch, should be positioned on the "+" side.
B) The TERMSERIES adapter switch, should be positioned on the "+-" side.

- The adapters should receive power from an external supply.
- The last 3 digits of the cable code indicates its length in decimeters. For example, if the code ends in 100, the cable would be 10 m long.
- The relays indicated in the table are 24 V DC for the digital input cards. These relays can be replaced by MICROSERIES relays with other voltages, from 5 V DC to 230 V DC.
- The TIAL has a LED for supply indication. The LED is not relevant in this application for the operation.

PLC HONEYWELL C300

16-channel solution









	PLC		Cables		Connection		TERMSERIES adapter			
	Input/Output cards		Standard				TERMSERIES adapter (Relay 6.4 mm)			
	Manufacturer code	Number/ Type of channels	Order No.	Qty.			TERMSERIES adapter		Inputs or outputs with relays	
							Order No.	Qty.	Order No.	Qty.
DI	CC-TDIL01	32 DI, 24 Vdc ^{B)}	2421450xxx	2			1463550000	2	1123000000 2618110000	32
	CC-TDIL11	32 DI, 24 Vdc ^{B)}	2421450xxx	2			1463550000	2	1123000000 2618110000	32
DO	CC-TDOB01	32 DO, 24 Vdc ^{A)}	2421440xxx	2			1463550000	2	1122770000 2618000000	32
	CC-TDOB11	32 DO, 24 Vdc ^{A)}	2421440xxx	2			1463550000	2	1122780000 1122890000	32

Note
A) The TERMSERIES adapter switch, should be positioned on the "+" side.
B) The TERMSERIES adapter switch, should be positioned on the "+-" side.

- The adapters should receive power from an external supply.
- The last 3 digits of the cable code indicates its length in decimeters. For example, if the code ends in 100, the cable would be 10 m long.
- The relays indicated in the table are 24 V DC for the digital input cards. These relays can be replaced by MICROSERIES relays with other voltages, from 5 V DC to 230 V DC.
- The TIAL has a LED for supply indication. The LED is not relevant in this application for the operation.

PLC HONEYWELL C300

8-channel solution (Sub-d connector)

	PLC		Cables		Connection		TERMSERIES adapter			
	Input/Output cards		Standard				TERMSERIES adapter (Relay 6.4 mm)			
	Manufacturer code	Number/ Type of channels	Order No.	Qty.	Screw connection	PUSH IN connection	TERMSERIES adapter		Inputs or outputs with relays	
							Order No.	Qty.	Order No.	Qty.
DI	CC-TDIL01	32 DI, 24 Vdc ^{B)}	2065110xxx	2			1463530000	4	1123000000	32
	CC-TDIL11	32 DI, 24 Vdc ^{B)}	2065110xxx	2			1463530000	4	1123000000 2618110000	
DO	CC-TDOB01	32 DO, 24 Vdc ^{A)}	2065100xxx	2			1463530000	4	1122770000	32
	CC-TDOB11	32 DO, 24 Vdc ^{A)}	2065100xxx	2			1463530000	4	1122780000 1122890000	
Note A) The TERMSERIES adapter switch, should be positioned on the "N" side. B) The TERMSERIES adapter switch, should be positioned on the "L" side.										

- The adapters should receive power from an external supply.
- The last 3 digits of the cable code indicates its length in decimeters. For example, if the code ends in 100, the cable would be 10 m long.
- The relays indicated in the table are 24 V DC for the digital input cards. These relays can be replaced by MICROSERIES relays with other voltages, from 5 V DC to 230 V DC.
- The TIAL has a LED for supply indication. The LED is not relevant in this application for the operation.

PLC MITSUBISHI MELSEC Q

8-channel solution







































	PLC		Cables		Connection		TERMSERIES adapter				TERMSERIES adapter			
	Input/Output cards		Standard				TERMSERIES adapter (Relay 6.4 mm)				TERMSERIES adapter (Relay 12.8 mm)			
	Manufacturer code	Number/ Type of channels	Order No.	Qty.	Screw connection	PUSH IN connection	TERMSERIES adapter		Inputs or outputs with relays		TERMSERIES adapter		Inputs or outputs with relays	
							Order No.	Qty.	Order No.	Qty.	Order No.	Qty.	Order No.	Qty.
DI	QX40	16 DI ^{A)}	1349730xxx	2			1463520000	2	1123000000 2618110000	16	1463540000	2	1123730000 2618530000	16
	QX40-S1	16 DI ^{A)}	1349730xxx	2			1463520000	2	1123000000 2618110000	16	1463540000	2	1123730000 2618530000	16
	QX41	32 DI ^{A)}	1512290xxx	1			1463520000	4	1123000000 2618110000	32	1463540000	4	1123730000 2618530000	32
	QX41-S1	32 DI ^{A)}	1512290xxx	1			1463520000	4	1123000000 2618110000	32	1463540000	4	1123730000 2618530000	32
	QX42	64 DI ^{A)}	1512290xxx	2			1463520000	8	1123000000 2618110000	64	1463540000	8	1123730000 2618530000	64
	QX42-S1	64 DI ^{A)}	1512290xxx	2			1463520000	8	1123000000 2618110000	64	1463540000	8	1123730000 2618530000	64
	QX80	16 DI ^{B)}	1349730xxx	2			1463520000	2	1123000000 2618110000	16	1463540000	2	1123730000 2618530000	16
	QX81	32 DI ^{B)}	1512320xxx	1			1463520000	4	1123000000 2618110000	32	1463540000	4	1123730000 2618530000	32
	QX82	64 DI ^{B)}	1512330xxx	2			1463520000	8	1123000000 2618110000	64	1463540000	8	1123730000 2618530000	64
	QX82-S1	64 DI ^{B)}	1512330xxx	2			1463520000	8	1123000000 2618110000	64	1463540000	8	1123730000 2618530000	64
DO	QY40P	16 DO ^{B)}	1349730xxx	2			1463520000	2	1122780000 1122890000	16	1463540000	2	1123500000 1123620000	16
	QY41P	32 DO ^{B)}	1512310xxx	1			1463520000	4	1122780000 1122890000	32	1463540000	4	1123500000 1123620000	32
	QY42P	64 DO ^{B)}	1512310xxx	2			1463520000	8	1122780000 1122890000	64	1463540000	8	1123500000 1123620000	64
	QY50	16 DO ^{B)}	1349730xxx	2			1463520000	2	1122780000 1122890000	16	1463540000	2	1123500000 1123620000	16
	QY80	16 DO ^{A)}	1349730xxx	2			1463520000	2	1122770000 2618000000	16	1463540000	2	1123490000 2618400000	16
DI/DO	QH42P	32 DI ^{A)}	1512290xxx	1			1463520000	4	1123000000 2618110000	32	1463540000	4	1123730000 2618530000	32
		32 DO ^{B)}	1512310xxx	1			1463520000	4	1122780000 1122890000	32	1463540000	4	1123500000 1123620000	32
	QX41Y41P	32 DI ^{A)}	1512290xxx	1			1463520000	4	1123000000 2618110000	32	1463540000	4	1123730000 2618530000	32
		32 DO ^{B)}	1512290xxx	1			1463520000	4	1122780000 1122890000	32	1463540000	4	1123500000 1123620000	32

Note
 A) The TERMSERIES adapter switch, should be positioned on the "A" side.
 B) The TERMSERIES adapter switch, should be positioned on the "B" side.

- The adapters should receive power from an external supply.
- The last 3 digits of the cable code indicates its length in decimeters. For example, if the code ends in 100, the cable would be 10 m long.
- The relays indicated in the table are chosen for 24 V DC control voltage. For digital input cards these can be replaced by TERMSERIES relays with control voltages from 5 V DC to 230 V AC.
- The use of cables longer than 20 m is not recommended for this application.

PLC MITSUBISHI MELSEC Q

16-channel solution

	PLC		Cables		Connection		TERMSERIES adapter			
	Input/Output cards		Standard				TERMSERIES adapter (Relay 6.4 mm)			
	Manufacturer code	Number/ Type of channels	Order No.	Qty.	Screw connection	PUSH IN connection	TERMSERIES adapter		Inputs or outputs with relays	
							Order No.	Qty.	Order No.	Qty.
DI	QX40	16 DI ^{A)}	7789100xxx	1			1463550000	1	1123000000	16
	QX40-S1	16 DI ^{A)}	7789100xxx	1			1463550000	1	2618110000	16
	QX41	32 DI ^{A)}	7789681xxx	2			1463550000	2	1123000000	32
	QX41-S1	32 DI ^{A)}	7789681xxx	2			1463550000	2	2618110000	32
	QX42	64 DI ^{A)}	7789681xxx	4			1463550000	4	1123000000	64
	QX42-S1	64 DI ^{A)}	7789681xxx	4			1463550000	4	2618110000	64
	QX80	16 DI ^{B)}	7789100xxx	1			1463550000	1	1123000000	16
	QX81	32 DI ^{B)}	1512340xxx	1			1463550000	2	2618110000	32
	QX82	64 DI ^{B)}	7789683xxx	4			1463550000	4	1123000000	64
	QX82-S1	64 DI ^{B)}	7789683xxx	4			1463550000	4	2618110000	64
DO	QY40P	16 DO ^{B)}	7789100xxx	1			1463550000	1	1122780000	16
	QY41P	32 DO ^{B)}	7789708xxx	2			1463550000	2	1122890000	32
	QY42P	64 DO ^{B)}	7789708xxx	4			1463550000	4	1122780000	64
	QY50	16 DO ^{B)}	7789100xxx	2			1463550000	1	1122890000	16
	QY80	16 DO ^{A)}	7789100xxx	2			1463550000	1	1122770000	16
DI/DO	QH42P	32 DI ^{A)}	7789681xxx	2			1463550000	2	1123000000	32
		32 DO ^{B)}	7789708xxx	2			1463550000	2	2618110000	32
	QX41Y41P	32 DI ^{A)}	7789681xxx	2			1463550000	2	1122780000	32
		32 DO ^{B)}	7789708xxx	2			1463550000	2	2618110000	32

Note
 A) The TERMSERIES adapter switch, should be positioned on the "A" side.
 B) The TERMSERIES adapter switch, should be positioned on the "B" side.

- The adapters should receive power from an external supply.
- The last 3 digits of the cable code indicates its length in decimeters. For example, if the code ends in 100, the cable would be 10 m long.
- The relays indicated in the table are chosen for 24 V DC control voltage. For digital input cards these can be replaced by TERMSERIES relays with control voltages from 5 V DC to 230 V AC.
- The use of cables longer than 20 m is not recommended for this application.

PLC OMRON CJ1W

8-channel solution































	PLC		Cables		Connection		TERMSERIES adapter				TERMSERIES adapter			
	Input/Output cards		Standard		Screw connection	PUSH IN connection	TERMSERIES adapter (Relay 6.4 mm)				TERMSERIES adapter (Relay 12.8 mm)			
	Manufacturer code	Number/ Type of channels	Order No.	Qty.			TERMSERIES adapter		Inputs or outputs with relays		TERMSERIES adapter		Inputs or outputs with relays	
					Order No.	Qty.	Order No.	Qty.	Order No.	Qty.	Order No.	Qty.		
DI	ID211	16 DI, positive logic ^{B)}	1511070xxx	1			1463520000	2	1123000000 2618110000	16	1463540000	2	1123730000 2618530000	16
		16 DI, negative logic ^{A)}	1511090xxx	1			1463520000	2	1123000000 2618110000	16	1463540000	2	1123730000 2618530000	16
	ID212	16 DI, positive logic ^{B)}	1511070xxx	1			1463520000	2	1123000000 2618110000	16	1463540000	2	1123730000 2618530000	16
		16 DI, negative logic ^{A)}	1511090xxx	1			1463520000	2	1123000000 2618110000	16	1463540000	2	1123730000 2618530000	16
	ID231	32 DI, positive logic ^{B)}	1511270xxx	1			1463520000	4	1123000000 2618110000	32	1463540000	4	1123730000 2618530000	32
		32 DI, negative logic ^{A)}	1511290xxx	1			1463520000	4	1123000000 2618110000	32	1463540000	4	1123730000 2618530000	32
	ID232	32 DI, positive logic ^{B)}	1511320xxx	1			1463520000	4	1123000000 2618110000	32	1463540000	4	1123730000 2618530000	32
		32 DI, negative logic ^{A)}	1511330xxx	1			1463520000	4	1123000000 2618110000	32	1463540000	4	1123730000 2618530000	32
	ID233	32 DI, positive logic ^{B)}	1511320xxx	1			1463520000	4	1123000000 2618110000	32	1463540000	4	1123730000 2618530000	32
		32 DI, negative logic ^{A)}	1511330xxx	1			1463520000	4	1123000000 2618110000	32	1463540000	4	1123730000 2618530000	32
	ID261	64 DI, positive logic ^{B)}	1511270xxx	2			1463520000	8	1123000000 2618110000	64	1463540000	8	1123730000 2618530000	64
		64 DI, negative logic ^{A)}	1511290xxx	2			1463520000	8	1123000000 2618110000	64	1463540000	8	1123730000 2618530000	64
ID262	64 DI, positive logic ^{B)}	1511320xxx	2			1463520000	8	1123000000 2618110000	64	1463540000	8	1123730000 2618530000	64	
	64 DI, negative logic ^{A)}	1511330xxx	2			1463520000	8	1123000000 2618110000	64	1463540000	8	1123730000 2618530000	64	
DO	OD201	8 DO ^{B)}	1511390xxx	1			1463520000	1	1122780000 1122890000	8	1463540000	1	1123500000 1123620000	8
	OD202	8 DO ^{A)}	1511390xxx	1			1463520000	1	1122770000 2618000000	8	1463540000	1	1123490000 2618400000	8
	OD203	8 DO ^{B)}	1511420xxx	1			1463520000	1	1122780000 1122890000	8	1463540000	1	1123500000 1123620000	8
	OD204	8 DO ^{A)}	1511420xxx	1			1463520000	1	1122770000 2618000000	8	1463540000	1	1123490000 2618400000	8
	OD211	16 DO ^{B)}	1511120xxx	1			1463520000	2	1122780000 1122890000	16	1463540000	2	1123500000 1123620000	16
	OD212	16 DO ^{A)}	1511120xxx	1			1463520000	2	1122770000 2618000000	16	1463540000	2	1123490000 2618400000	16
	OD213	16 DO ^{B)}	1511120xxx	1			1463520000	2	1122780000 1122890000	16	1463540000	2	1123500000 1123620000	16
	OD231	32 DO ^{B)}	1511340xxx	1			1463520000	4	1122780000 1122890000	32	1463540000	4	1123500000 1123620000	32
	OD232	32 DO ^{A)}	1511370xxx	1			1463520000	4	1122770000 2618000000	32	1463540000	4	1123490000 2618400000	32
	OD233	32 DO ^{B)}	1511370xxx	1			1463520000	4	1122780000 1122890000	32	1463540000	4	1123500000 1123620000	32
	OD234	32 DO ^{B)}	1511370xxx	1			1463520000	4	1122780000 1122890000	32	1463540000	4	1123500000 1123620000	32
	OD261	64 DO ^{B)}	1511340xxx	2			1463520000	8	1122780000 1122890000	64	1463540000	8	1123500000 1123620000	64
	OD262	64 DO ^{A)}	1511370xxx	2			1463520000	8	1122770000 2618000000	64	1463540000	8	1123490000 2618400000	64
	OD263	64 DO ^{B)}	1511370xxx	2			1463520000	8	1122780000 1122890000	64	1463540000	8	1123500000 1123620000	64

Note
A) The TERMSERIES adapter switch, should be positioned on the "N" side.
B) The TERMSERIES adapter switch, should be positioned on the "N+" side.

- The adapters should receive power from an external supply.
- The last 3 digits of the cable code indicates its length in decimeters. For example, if the code ends in 100, the cable would be 10 m long.
- The relays indicated in the table are chosen for 24 V DC control voltage. For digital input cards these can be replaced by TERMSERIES relays with control voltages from 5 V DC to 230 V AC.

PLC OMRON CJ1W

8-channel solution

















































	PLC		Cables		Connection		TERMSERIES adapter				TERMSERIES adapter			
	Input/Output cards		Standard				TERMSERIES adapter (Relay 6.4 mm)				TERMSERIES adapter (Relay 12.8 mm)			
	Manufacturer code	Number/ Type of channels	Order No.	Qty.	Screw connection	PUSH IN connection	TERMSERIES adapter		Inputs or outputs with relays		TERMSERIES adapter		Inputs or outputs with relays	
							Order No.	Qty.	Order No.	Qty.	Order No.	Qty.	Order No.	Qty.
DI/DO	MD231	16 DI, positive logic ^{B)}	1511130xxx	1			1463520000	2	1123000000	16	1463540000	2	1123730000	16
								2618110000		2618530000				
		16 DI, negative logic ^{A)}	1511140xxx	1			1463520000	2	1123000000	16	1463540000	2	1123730000	16
									2618110000		2618530000			
		16 DO ^{B)}	1511170xxx	1			1463520000	2	1122780000	16	1463540000	2	1123500000	16
									1122890000		1123620000			
	MD232	16 DI, positive logic ^{B)}	1511190xxx	1			1463520000	2	1123000000	16	1463540000	2	1123730000	16
									2618110000		2618530000			
		16 DI, negative logic ^{A)}	1511220xxx	1			1463520000	2	1123000000	16	1463540000	2	1123730000	16
									2618110000		2618530000			
		16 DO ^{A)}	1511240xxx	1			1463520000	2	1122770000	16	1463540000	2	1123490000	16
									2618000000		2618400000			
	MD233	16 DI, positive logic ^{B)}	1511190xxx	1			1463520000	2	1123000000	16	1463540000	2	1123730000	16
									2618110000		2618530000			
		16 DI, negative logic ^{A)}	1511220xxx	1			1463520000	2	1123000000	16	1463540000	2	1123730000	16
									2618110000		2618530000			
		16 DO ^{B)}	1511230xxx	1			1463520000	2	1122780000	16	1463540000	2	1123500000	16
									1122890000		1123620000			
MD261	32 DI, positive logic ^{B)}	1511270xxx	1			1463520000	4	1123000000	32	1463540000	4	1123730000	32	
								2618110000		2618530000				
	32 DI, negative logic ^{A)}	1511290xxx	1			1463520000	4	1123000000	32	1463540000	4	1123730000	32	
								2618110000		2618530000				
	32 DO ^{B)}	1511340xxx	1			1463520000	4	1122780000	32	1463540000	4	1123500000	32	
								1122890000		1123620000				
MD263	32 DI, positive logic ^{B)}	1511320xxx	1			1463520000	4	1123000000	32	1463540000	4	1123730000	32	
								2618110000		2618530000				
	32 DI, negative logic ^{A)}	1511330xxx	1			1463520000	4	1123000000	32	1463540000	4	1123730000	32	
								2618110000		2618530000				
	32 DO ^{B)}	1511370xxx	1			1463520000	4	1122780000	32	1463540000	4	1123500000	32	
								1122890000		1123620000				

Note
 A) The TERMSERIES adapter switch, should be positioned on the "N" side.
 B) The TERMSERIES adapter switch, should be positioned on the "N+" side.

- The adapters should receive power from an external supply.
- The last 3 digits of the cable code indicates its length in decimeters. For example, if the code ends in 100, the cable would be 10 m long.
- The relays indicated in the table are chosen for 24 V DC control voltage. For digital input cards these can be replaced by TERMSERIES relays with control voltages from 5 V DC to 230 V AC.

PLC OMRON CJ1W

16-channel solution































	PLC		Cables		Connection		TERMSERIES adapter				
	Input/Output cards		Standard				TERMSERIES adapter (Relay 6.4 mm)				
	Manufacturer code	Number/ Type of channels	Order No.	Qty.	Screw connection	PUSH IN connection	TERMSERIES adapter		Inputs or outputs with relays		
							Order No.	Qty.	Order No.	Qty.	
DI	ID211	16 DI, positive logic ^{B)}	7789645xxx	1			1463550000	1	1123000000	16	
		16 DI, negative logic ^{A)}	7789833xxx	1			1463550000	1	1123000000	16	
	ID212	16 DI, positive logic ^{B)}	7789645xxx	1			1463550000	1	1123000000	16	
		16 DI, negative logic ^{A)}	7789833xxx	1			1463550000	1	1123000000	16	
	ID231	32 DI, positive logic ^{B)}	7789771xxx	1			1463550000	2	1123000000	32	
		32 DI, negative logic ^{A)}	7789768xxx	1			1463550000	2	1123000000	32	
	ID232	32 DI, positive logic ^{B)}	7789772xxx	1			1463550000	2	1123000000	32	
		32 DI, negative logic ^{A)}	7789767xxx	1			1463550000	2	1123000000	32	
	ID233	32 DI, positive logic ^{B)}	7789772xxx	1			1463550000	2	1123000000	32	
		32 DI, negative logic ^{A)}	7789767xxx	1			1463550000	2	1123000000	32	
	ID261	64 DI, positive logic ^{B)}	7789771xxx	2			1463550000	4	1123000000	64	
		64 DI, negative logic ^{A)}	7789768xxx	2			1463550000	4	1123000000	64	
	ID262	64 DI, positive logic ^{B)}	7789772xxx	2			1463550000	4	1123000000	64	
		64 DI, negative logic ^{A)}	7789767xxx	2			1463550000	4	1123000000	64	
	DO	OD211	16 DO ^{B)}	7789794xxx	1			1463550000	1	1122780000	16
		OD212	16 DO ^{A)}	7789794xxx	1			1463550000	1	1122770000	16
2618000000											
OD213		16 DO ^{B)}	7789794xxx	1			1463550000	1	1122780000	16	
									1122890000		
OD231		32 DO ^{B)}	7789793xxx	1			1463550000	2	1122780000	32	
									1122890000		
OD232		32 DO ^{A)}	7789373xxx	1			1463550000	2	1122770000	32	
									2618000000		
OD233		32 DO ^{B)}	7789373xxx	1			1463550000	2	1122780000	32	
									1122890000		
OD234	32 DO ^{B)}	7789373xxx	1			1463550000	2	1122780000	32		
								1122890000			
OD261	64 DO ^{B)}	7789793xxx	2			1463550000	4	1122780000	64		
								1122890000			
OD262	64 DO ^{A)}	7789373xxx	1			1463550000	4	1122770000	64		
								2618000000			
OD263	64 DO ^{B)}	7789373xxx	1			1463550000	4	1122780000	64		
								1122890000			

Note
A) The TERMSERIES adapter switch, should be positioned on the "A" side.
B) The TERMSERIES adapter switch, should be positioned on the "B" side.

- The adapters should receive power from an external supply.
- The last 3 digits of the cable code indicates its length in decimeters. For example, if the code ends in 100, the cable would be 10 m long.
- The relays indicated in the table are chosen for 24 V DC control voltage. For digital input cards these can be replaced by TERMSERIES relays with control voltages from 5 V DC to 230 V AC.

PLC OMRON CJ1W

16-channel solution

	PLC		Cables		Connection		TERMSERIES adapter			
	Input/Output cards		Standard				TERMSERIES adapter (Relay 6.4 mm)			
	Manufacturer code	Number/ Type of channels	Order No.	Qty.	Screw connection	PUSH IN connection	TERMSERIES adapter		Inputs or outputs with relays	
							Order No.	Qty.	Order No.	Qty.
DI/DO	MD231	16 DI, positive logic ^{B)}	1511430xxx	1			1463550000	1	1123000000	16
		16 DI, negative logic ^{A)}	1511440xxx	1			1463550000	1	1123000000	16
		16 DO ^{B)}	1511470xxx	1			1463550000	1	1122780000	16
	MD232	16 DI, positive logic ^{B)}	7789328xxx	1			1463550000	1	1123000000	16
		16 DI, negative logic ^{A)}	7789329xxx	1			1463550000	1	1123000000	16
		16 DO ^{A)}	7789329xxx	1			1463550000	1	1122770000	16
	MD233	16 DI, positive logic ^{B)}	7789328xxx	1			1463550000	1	1123000000	16
		16 DI, negative logic ^{A)}	7789329xxx	1			1463550000	1	1123000000	16
		16 DO ^{B)}	7789329xxx	1			1463550000	1	1122780000	16
	MD261	32 DI, positive logic ^{B)}	7789771xxx	1			1463550000	2	1123000000	32
		32 DI, negative logic ^{A)}	7789768xxx	1			1463550000	2	1123000000	32
		32 DO ^{B)}	7789793xxx	1			1463550000	2	1122780000	32
	MD263	32 DI, positive logic ^{B)}	7789772xxx	1			1463550000	2	1123000000	32
		32 DI, negative logic ^{A)}	7789767xxx	1			1463550000	2	1123000000	32
		32 DO ^{B)}	7789373xxx	1			1463550000	2	1122780000	32

Note A) The TERMSERIES adapter switch, should be positioned on the "N+" side.
 B) The TERMSERIES adapter switch, should be positioned on the "N-" side.

- The adapters should receive power from an external supply.
- The last 3 digits of the cable code indicates its length in decimeters. For example, if the code ends in 100, the cable would be 10 m long.
- The relays indicated in the table are chosen for 24 V DC control voltage. For digital input cards these can be replaced by TERMSERIES relays with control voltages from 5 V DC to 230 V AC.

PLC ROCKWELL COMPACT LOGIX

8-channel solution





























	PLC		Cables		Connection		TERMSERIES adapter				TERMSERIES adapter				
	Input/Output cards		Standard				TERMSERIES adapter (Relay 6.4 mm)				TERMSERIES adapter (Relay 12.8 mm)				
	Manufacturer code	Number/ Type of channels	Order No.	Qty.	Screw connection	PUSH IN connection	TERMSERIES adapter		Inputs or outputs with relays		TERMSERIES adapter		Inputs or outputs with relays		
							Order No.	Qty.	Order No.	Qty.	Order No.	Qty.	Order No.	Qty.	
DI	1769-IQ16	16 DI, positive logic ^{B)}	1511730xxx	1			1463520000	2	1123000000	16	1463540000	2	1123730000	16	
		16 DI, negative logic ^{A)}	1511740xxx	1			1463520000	2	1123000000	16	1463540000	2	1123730000	16	
	1769-IQ16F	16 DI, positive logic ^{B)}	1511730xxx	1			1463520000	2	1123000000	16	1463540000	2	1123730000	16	
		16 DI, negative logic ^{A)}	1511740xxx	1			1463520000	2	1123000000	16	1463540000	2	1123730000	16	
	1769-IQ32	32 DI, positive logic ^{B)}	1511730xxx	1			1463520000	4	1123000000	32	1463540000	4	1123730000	32	
		32 DI, positive logic ^{B)}	1511770xxx	1			1463520000	4	1123000000	32	1463540000	4	1123730000	32	
		32 DI, negative logic ^{A)}	1511820xxx	1			1463520000	4	1123000000	32	1463540000	4	1123730000	32	
	1769-IQ32T	32 DI, positive logic ^{B)}	1511890xxx	1			1463520000	4	1123000000	32	1463540000	4	1123730000	32	
		32 DI, negative logic ^{A)}	1511910xxx	1			1463520000	4	1123000000	32	1463540000	4	1123730000	32	
	DO	1769-OB8	8 DO ^{A)}	1511930xxx	1			1463520000	1	1122770000	8	1463540000	1	1123490000	8
		1769-OB16	16 DO ^{A)}	1511830xxx	1			1463520000	2	1122770000	16	1463540000	2	1123490000	16
				1511800xxx	1			1463520000	2	1122770000	16	1463540000	2	1123490000	16
1769-OB32		32 DO ^{A)}	1511830xxx	1			1463520000	4	1122770000	32	1463540000	4	1123490000	32	
			1511870xxx	1			1463520000	4	1122770000	32	1463540000	4	1123490000	32	
1769-OB32T		32 DO ^{A)}	1511920xxx	1			1463520000	4	1122770000	32	1463540000	4	1123490000	32	
1769-OV16	16 DO ^{B)}	1511830xxx	1			1463520000	4	1122780000	32	1463540000	4	1123500000	32		

Note
 A) The TERMSERIES adapter switch, should be positioned on the "A" side.
 B) The TERMSERIES adapter switch, should be positioned on the "B" side.

- The adapters should receive power from an external supply.
- The last 3 digits of the cable code indicates its length in decimeters. For example, if the code ends in 100, the cable would be 10 m long.
- The relays indicated in the table are chosen for 24 V DC control voltage. For digital input cards these can be replaced by TERMSERIES relays with control voltages from 5 V DC to 230 V AC.

PLC ROCKWELL COMPACT LOGIX

16-channel solution

	PLC		Cables		Connection		TERMSERIES adapter				
	Input/Output cards		Standard				TERMSERIES adapter (Relay 6.4 mm)				
	Manufacturer code	Number/ Type of channels	Order No.	Qty.	Screw connection	PUSH IN connection	TERMSERIES adapter		Inputs or outputs with relays		
							Order No.	Qty.	Order No.	Qty.	
DI	1769-IQ16	16 DI, positive logic ^{B)}	7789770xxx	1			1463550000	1	1123000000	16	
		16 DI, negative logic ^{A)}	7789831xxx	1			1463550000	1	1123000000	16	
	1769-IQ16F	16 DI, positive logic ^{B)}	7789770xxx	1			1463550000	1	1123000000	16	
		16 DI, negative logic ^{A)}	7789831xxx	1			1463550000	1	1123000000	16	
	1769-IQ32	32 DI, positive logic ^{B)}	7789770xxx	1			1463550000	2	1123000000	32	
		32 DI, negative logic ^{A)}	7789831xxx	1			1463550000	2	1123000000	32	
	1769-IQ32T	32 DI, positive logic ^{B)}	1489160xxx	1			1463550000	2	1123000000	32	
		32 DI, negative logic ^{A)}	1489180xxx	1			1463550000	2	1123000000	32	
	DO	1769-OB16	16 DO ^{A)}	7789769xxx	1			1463550000	1	1122770000	16
		1769-OB16P	16 DO ^{A)}	7789769xxx	1			1463550000	1	1122770000	16
1769-OB32		32 DO ^{A)}	7789769xxx	1			1463550000	2	1122770000	32	
			7789697xxx	1			1463550000	2	1122770000	32	
1769-OB32T		32 DO ^{A)}	1489170xxx	1			1463550000	2	1122770000	32	
1769-OV16	16 DO ^{B)}	7789769xxx	1			1463550000	1	1122800000	16		

Note A) The TERMSERIES adapter switch, should be positioned on the "A" side.
 B) The TERMSERIES adapter switch, should be positioned on the "B" side.

- The adapters should receive power from an external supply.
- The last 3 digits of the cable code indicates its length in decimeters. For example, if the code ends in 100, the cable would be 10 m long.
- The relays indicated in the table are chosen for 24 V DC control voltage. For digital input cards these can be replaced by TERMSERIES relays with control voltages from 5 V DC to 230 V AC.



PLC ROCKWELL CONTROL LOGIX

8-channel solution





















	PLC		Cables		Connection		TERMSERIES adapter				TERMSERIES adapter			
	Input/Output cards		Standard				TERMSERIES adapter (Relay 6.4 mm)				TERMSERIES adapter (Relay 12.8 mm)			
	Manufacturer code	Number/ Type of channels	Order No.	Qty.	Screw connection	PUSH IN connection	TERMSERIES adapter		Inputs or outputs with relays		TERMSERIES adapter		Inputs or outputs with relays	
							Order No.	Qty.	Order No.	Qty.	Order No.	Qty.	Order No.	Qty.
DI	1756-IB16	16 DI ^{B)}	1511970xxx	1			1463520000	2	1123000000 2618110000	16	1463540000	2	1123730000 2618530000	16
	1756-IB16D	16 DI ^{B)}	1511990xxx	1			1463520000	2	1123000000 2618110000	16	1463540000	2	1123730000 2618530000	16
	1756-IB16I	16 DI ^{B)}	1511990xxx	1			1463520000	2	1123000000 2618110000	16	1463540000	2	1123730000 2618530000	16
	1756-IB32	32 DI ^{B)}	1512010xxx	1			1463520000	4	1123000000 2618110000	32	1463540000	4	1123730000 2618530000	32
DO	1756-OB16D	16 DO ^{A)}	1512030xxx	1			1463520000	2	1122770000 2618000000	16	1463540000	2	1123490000 2618400000	16
	1756-OB16E	16 DO ^{A)}	1512040xxx	1			1463520000	2	1122770000 2618000000	16	1463540000	2	1123490000 2618400000	16
	1756-OB16I	16 DO ^{A)}	1512070xxx	1			1463520000	2	1122770000 2618000000	16	1463540000	2	1123490000 2618400000	16
	1756-OB32	32 DO ^{A)}	1512020xxx	1			1463520000	4	1122770000 2618000000	32	1463540000	4	1123490000 2618400000	32
	1756-OB8	8 DO ^{A)}	1512090xxx	1			1463520000	1	1122770000 2618000000	8	1463540000	1	1123490000 2618400000	8
	1756-OB8EI	8 DO ^{A)}	1512110xxx	1			1463520000	1	1122770000 2618000000	8	1463540000	1	1123490000 2618400000	8
	1756-OV16E	16 DO ^{B)}	1512040xxx	1			1463520000	2	1122780000 1122890000	16	1463540000	2	1123500000 1123620000	16
	1756-OV32E	32 DO ^{B)}	1512020xxx	1			1463520000	4	1122780000 1122890000	32	1463540000	4	1123500000 1123620000	32

Note A) The TERMSERIES adapter switch, should be positioned on the "A" side.
 B) The TERMSERIES adapter switch, should be positioned on the "B" side.

- The adapters should receive power from an external supply.
- The last 3 digits of the cable code indicates its length in decimeters. For example, if the code ends in 100, the cable would be 10 m long.
- The relays indicated in the table are chosen for 24 V DC control voltage. For digital input cards these can be replaced by TERMSERIES relays with control voltages from 5 V DC to 230 V AC.

PLC ROCKWELL CONTROL LOGIX

16-channel solution

	PLC		Cables		Connection		TERMSERIES adapter			
	Input/Output cards		Standard				TERMSERIES adapter (Relay 6.4 mm)			
	Manufacturer code	Number/ Type of channels	Order No.	Qty.	Screw connection	PUSH IN connection	TERMSERIES adapter		Inputs or outputs with relays	
							Order No.	Qty.	Order No.	Qty.
DI	1756-IB16	16 DI ^{B)}	7789039xxx	1			1463550000	1	1123000000	16
	1756-IB16D	16 DI ^{B)}	7789049xxx	1			1463550000	1	1123000000	16
	1756-IB16I	16 DI ^{B)}	7789049xxx	1			1463550000	1	1123000000	16
	1756-IB32	32 DI ^{B)}	7789041xxx	1			1463550000	2	1123000000	32
DO	1756-OB16D	16 DO ^{A)}	7789040xxx	1			1463550000	1	1122770000	16
	1756-OB16E	16 DO ^{A)}	7789058xxx	1			1463550000	1	1122770000	16
	1756-OB16I	16 DO ^{A)}	7789059xxx	1			1463550000	1	1122770000	16
	1756-OB32	32 DO ^{A)}	7789042xxx	1			1463550000	2	1122770000	32
	1756-OV16E	16 DO ^{B)}	7789058xxx	1			1463550000	1	1122800000	16
	1756-OV32E	32 DO ^{B)}	7789042xxx	1			1463550000	2	1122800000	32



























Note
 A) The TERMSERIES adapter switch, should be positioned on the "A" side.
 B) The TERMSERIES adapter switch, should be positioned on the "B" side.

- The adapters should receive power from an external supply.
- The last 3 digits of the cable code indicates its length in decimeters. For example, if the code ends in 100, the cable would be 10 m long.
- The relays indicated in the table are chosen for 24 V DC control voltage. For digital input cards these can be replaced by TERMSERIES relays with control voltages from 5 V DC to 230 V AC.



PLC SCHNEIDER M340

8-channel solution























	PLC		Cables		Connection		TERMSERIES adapter				TERMSERIES adapter			
	Input/Output cards		Standard				TERMSERIES adapter (Relay 6.4 mm)				TERMSERIES adapter (Relay 12.8 mm)			
	Manufacturer code	Number/ Type of channels	Order No.	Qty.	Screw connection	PUSH IN connection	TERMSERIES adapter		Inputs or outputs with relays		TERMSERIES adapter		Inputs or outputs with relays	
							Order No.	Qty.	Order No.	Qty.	Order No.	Qty.	Order No.	Qty.
DI	BMX DAI 1602	16 DI, DC positive logic ^{B)}	1512120xxx	1			1463520000	2	1123000000 2618110000	16	1463540000	2	1123730000 2618530000	16
		16 DI, DC negative logic ^{A)}	1512130xxx	1			1463520000	2	1123000000 2618110000	16	1463540000	2	1123730000 2618530000	16
	BMX DDI 1602	16 DI ^{B)}	1512120xxx	1			1463520000	2	1123000000 2618110000	16	1463540000	2	1123730000 2618530000	16
	BMX DDI 3202K	32 DI ^{B)}	1512170xxx	1			1463520000	4	1123000000 2618110000	32	1463540000	4	1123730000 2618530000	32
	BMX DDI 6402K	64 DI ^{B)}	1512170xxx	2			1463520000	8	1123000000 2618110000	64	1463540000	8	1123730000 2618530000	16
DO	BMX DDO 1602	16 DO ^{A)}	1512120xxx	1			1463520000	2	1122770000 2618000000	16	1463540000	2	1123490000 2618400000	16
	BMX DDO 1612	16 DO ^{B)}	1512120xxx	1			1463520000	2	1122780000 1122890000	16	1463540000	2	1123500000 1123620000	16
	BMX DDO 3202K	32 DO ^{A)}	1512170xxx	1			1463520000	4	1122770000 2618000000	32	1463540000	4	1123490000 2618400000	32
	BMX DDO 6402K	64 DO ^{A)}	1512170xxx	2			1463520000	8	1122770000 2618000000	64	1463540000	8	1123490000 2618400000	64
DI/DO	BMX DDM 16022	8 DI ^{B)}	1512140xxx	1			1463520000	1	1123000000 2618110000	8	1463540000	1	1123730000 2618530000	8
		8 DO ^{A)}					1463520000	1	1122770000 2618000000	8	1463540000	1	1123490000 2618400000	8
	BMX DDM 3202K	16 DI ^{B)}	1512170xxx	1			1463520000	2	1123000000 2618110000	16	1463540000	2	1123730000 2618530000	16
		16 DO ^{A)}					1463520000	2	1122770000 2618000000	16	1463540000	2	1123490000 2618400000	16

Note A) The TERMSERIES adapter switch, should be positioned on the "H" side.
 B) The TERMSERIES adapter switch, should be positioned on the "L" side.

- The adapters should receive power from an external supply.
- The last 3 digits of the cable code indicates its length in decimeters. For example, if the code ends in 100, the cable would be 10 m long.
- The relays indicated in the table are chosen for 24 V DC control voltage. For digital input cards these can be replaced by TERMSERIES relays with control voltages from 5 V DC to 230 V AC.

PLC SCHNEIDER M340

16-channel solution

	PLC		Cables		Connection		TERMSERIES adapter			
	Input/Output cards		Standard				TERMSERIES adapter (Relay 6.4 mm)			
	Manufacturer code	Number/ Type of channels	Order No.	Qty.	Screw connection	PUSH IN connection	TERMSERIES adapter		Inputs or outputs with relays	
							Order No.	Qty.	Order No.	Qty.
DI	BMX DAI 1602	16 DI, DC positive logic ^{B)}	7789380xxx	1			1463550000	1	1123000000	16
		16 DI, DC negative logic ^{A)}	7789630xxx	1			1463550000	1	1123000000	16
	BMX DDI 1602	16 DI ^{B)}	7789380xxx	1			1463550000	1	1123000000	16
	BMX DDI 3202K	32 DI ^{B)}	7789387xxx	1			1463550000	2	1123000000	32
	BMX DDI 6402K	64 DI ^{B)}	7789387xxx	2			1463550000	4	1123000000	64
DO	BMX DDO 1602	16 DO ^{A)}	7789380xxx	1			1463550000	1	1122770000	16
	BMX DDO 1612	16 DO ^{B)}	7789380xxx	1			1463550000	1	1122780000	16
	BMX DDO 3202K	32 DO ^{A)}	7789387xxx	1			1463550000	2	1122770000	32
	BMX DDO 6402K	64 DO ^{A)}	7789387xxx	2			1463550000	4	1122770000	64
DI/DO	BMX DDM 3202K	16 DI ^{B)}	7789387xxx	1			1463550000	1	1123000000	16
		16 DO ^{A)}					1463550000	1	1122770000	16











Note A) The TERMSERIES adapter switch, should be positioned on the "A" side.
 B) The TERMSERIES adapter switch, should be positioned on the "B" side.

- The adapters should receive power from an external supply.
- The last 3 digits of the cable code indicates its length in decimeters. For example, if the code ends in 100, the cable would be 10 m long.
- The relays indicated in the table are chosen for 24 V DC control voltage. For digital input cards these can be replaced by TERMSERIES relays with control voltages from 5 V DC to 230 V AC.



PLC SCHNEIDER QUANTUM

16-channel solution















	PLC		Cables		Connection		TERMSERIES adapter			
	Input/Output cards		Standard		Screw connection	PUSH IN connection	TERMSERIES adapter (Relay 6.4 mm)			
	Manufacturer code	Number/Type of channels	Order No.	Qty.			TERMSERIES adapter		Inputs or outputs with relays	
					Order No.	Qty.	Order No.	Qty.		
DI	140 DDI 353 00	32 DI ^{B)}	2460880xxx	1			1463550000	2	1123000000	32
	140 DDI 364 00	96 DI ^{B)}	7789301xxx	6			1463550000	6	1123000000 2618110000	
	140 DDI 853 00	32 DI ^{B)}	2460880xxx	1			1463550000	2	1123000000 2618110000	32
DO	140 DDO 353 00	32 DO ^{A)}	2460880xxx	1			1463550000	2	1122770000 2618000000	32
	140 DDO 364 00	96 DO ^{A)}	7789301xxx	6			1463550000	6	1122770000 2618000000	

Note A) The TERMSERIES adapter switch, should be positioned on the "L" side.
 B) The TERMSERIES adapter switch, should be positioned on the "N+" side.

- The adapters should receive power from an external supply.
- The last 3 digits of the cable code indicates its length in decimeters. For example, if the code ends in 100, the cable would be 10 m long.
- The relays indicated in the table are 24 V DC for the digital input cards. These relays can be replaced by MICROSERIES relays with other voltages, from 5 V DC to 230 V DC.

PLC SCHNEIDER TM3

16-channel solution

	PLC		Cables		Connection		TERMSERIES adapter			
	Input/Output cards		Standard				TERMSERIES adapter (Relay 6.4 mm)			
	Manufacturer code	Number/ Type of channels	Order No.	Qty.	Screw connection	PUSH IN connection	TERMSERIES adapter		Inputs or outputs with relays	
							Order No.	Qty.	Order No.	Qty.
DI	TM3DI16 / TM3DI16G	16DI, positive logic	2857920xxx	1			1463550000	1	1123000000	16
	TM3DI16K	16DI, positive logic	2534060xxx	1			1463550000	1	1123000000 2618110000	16
	TM3DI32K	32DI, positive logic	2534060xxx	2			1463550000	2	1123000000 2618110000	32
DO	TM3DQ16R / TM3DQ16RG ^{A)}	16DO, positive logic	2857960xxx	1			1463550000	1	1122770000 2618000000	16
	TM3DQ16T / TM3DQ16TG	16DO	2857970xxx	1			1463550000	1	1122770000 2618000000	16
	TM3DQ16TK	16DO	7789329xxx	1			1463550000	1	1122770000 2618000000	16
	TM3DQ32TK	32DO	7789329xxx	2			1463550000	2	1122770000 2618000000	32

Note A) Only possible if configured at 24 V DC

- All interfaces which are connected with an pre-assembled cable with starting Terminal block the supply voltage has to be connected in the interface.
- Please, always take into account the characteristics of the PLC card (voltage, current...) when selecting interfaces. In some cases, the card can work at higher voltages than those indicated in the interface.
- The interfaces are intended to be used inside an IP20 enclosure at least.
- The last 3 digits of the cable code indicate its length in decimetres. For example, if the code ends in 100, the cable would be 10 m long.

* In the case that an input/output card does not appear in this table, you can check our on-line PLC selection guide at www.weidmueller.com where you will always find the most up-to-date information.



PLC SIEMENS S7-300

8-channel solution











































	PLC		Cables		Connection		TERMSERIES adapter				TERMSERIES adapter				
	Input/Output cards		Standard		Screw connection	PUSH IN connection	TERMSERIES adapter (Relay 6.4 mm)				TERMSERIES adapter (Relay 12.8 mm)				
	Manufacturer code	Number/ Type of channels	Order No.	Qty.			TERMSERIES adapter		Inputs or outputs with relays		TERMSERIES adapter		Inputs or outputs with relays		
					Order No.	Qty.	Order No.	Qty.	Order No.	Qty.	Order No.	Qty.			
DI	6ES7321-1BH00-0AA0	16 DI ^{B)}	1512620xxx	1			1463520000	2	1123000000 2618110000	16	1463540000	2	1123730000 2618530000	16	
	6ES7321-1BH01-0AA0	16 DI ^{B)}	1512620xxx	1			1463520000	2	1123000000 2618110000	16	1463540000	2	1123730000 2618530000	16	
	6ES7321-1BH02-0AA0	16 DI ^{B)}	1512620xxx	1			1463520000	2	1123000000 2618110000	16	1463540000	2	1123730000 2618530000	16	
	6ES7321-1BH50-0AA0	16 DI ^{A)}	1512620xxx	1			1463520000	2	1123000000 2618110000	16	1463540000	2	1123730000 2618530000	16	
	6ES7321-1BH80-0AA0	16 DI ^{B)}	1512620xxx	1			1463520000	2	1123000000 2618110000	16	1463540000	2	1123730000 2618530000	16	
	6ES7321-1BH81-0AA0	16 DI ^{B)}	1512620xxx	1			1463520000	2	1123000000 2618110000	16	1463540000	2	1123730000 2618530000	16	
	6ES7321-1BH81-0AA0	16 DI ^{B)}	1512620xxx	1			1463520000	2	1123000000 2618110000	16	1463540000	2	1123730000 2618530000	16	
	6ES7321-1BL00-0AA0	32 DI ^{B)}	1512640xxx	1			1463520000	4	1123000000 2618110000	32	1463540000	4	1123730000 2618530000	32	
	6ES7321-1BL80-0AA0	32 DI ^{B)}	1512640xxx	1			1463520000	4	1123000000 2618110000	32	1463540000	4	1123730000 2618530000	32	
	6ES7321-1BP00-0AA0	64 DI, positive logic ^{B)}	1512650xxx	2			1463520000	8	1123000000 2618110000	64	1463540000	8	1123730000 2618530000	64	
	6ES7321-1BP00-0AA0	64 DI, negative logic ^{A)}	1512680xxx	2			1463520000	8	1123000000 2618110000	64	1463540000	8	1123730000 2618530000	64	
	6ES7321-7BH00-0AB0	16 DI ^{B)}	1512630xxx	1			1463520000	2	1123000000 2618110000	16	1463540000	2	1123730000 2618530000	16	
	6ES7321-7BH01-0AB0	16 DI ^{B)}	1512630xxx	1			1463520000	2	1123000000 2618110000	16	1463540000	2	1123730000 2618530000	16	
	6ES7321-7BH80-0AB0	16 DI ^{B)}	1512630xxx	1			1463520000	2	1123000000 2618110000	16	1463540000	2	1123730000 2618530000	16	
	DO	6ES7322-1BF00-0AA0	8 DO ^{A)}	1512600xxx	1			1463520000	1	1122770000 2618000000	8	1463540000	1	1123490000 2618400000	8
		6ES7322-1BF01-0AA0	8 DO ^{A)}	1512600xxx	1			1463520000	1	1122770000 2618000000	8	1463540000	1	1123490000 2618400000	8
6ES7322-1BH00-0AA0		16 DO ^{A)}	1512620xxx	1			1463520000	2	1122770000 2618000000	16	1463540000	2	1123490000 2618400000	16	
6ES7322-1BH01-0AA0		16 DO ^{A)}	1512620xxx	1			1463520000	2	1122770000 2618000000	16	1463540000	2	1123490000 2618400000	16	
6ES7322-1BH10-0AA0		16 DO ^{A)}	1512620xxx	1			1463520000	2	1122770000 2618000000	16	1463540000	2	1123490000 2618400000	16	
6ES7322-1BH81-0AA0		16 DO ^{A)}	1512620xxx	1			1463520000	2	1122770000 2618000000	16	1463540000	2	1123490000 2618400000	16	
6ES7322-1BL00-0AA0		32 DO ^{A)}	1512640xxx	1			1463520000	4	1122770000 2618000000	32	1463540000	4	1123490000 2618400000	32	
6ES7322-1BP00-0AA0		64 DO ^{A)}	1513340xxx	2			1463520000	8	1122770000 2618000000	64	1463540000	8	1123490000 2618400000	64	
6ES7322-1BP50-0AA0		64 DO ^{B)}	1513340xxx	2			1463520000	8	1122780000 1122890000	64	1463540000	8	1123500000 1123620000	64	

Note A) The TERMSERIES adapter switch, should be positioned on the "A" side.
 B) The TERMSERIES adapter switch, should be positioned on the "B" side.

- The adapters should receive power from an external supply.
- The last 3 digits of the cable code indicates its length in decimeters. For example, if the code ends in 100, the cable would be 10 m long.
- The relays indicated in the table are chosen for 24 V DC control voltage. For digital input cards these can be replaced by TERMSERIES relays with control voltages from 5 V DC to 230 V AC.

PLC SIEMENS S7-300

16-channel solution

	PLC		Cables		Connection		TERMSERIES adapter				
	Input/Output cards		Standard				TERMSERIES adapter (Relay 6.4 mm)				
	Manufacturer code	Number/ Type of channels	Order No.	Qty.	Screw connection	PUSH IN connection	TERMSERIES adapter		Inputs or outputs with relays		
							Order No.	Qty.	Order No.	Qty.	
DI	6ES7321-1BH00-0AA0	16 DI ^{B)}	7789234xxx	1			1463550000	1	1123000000	16	
	6ES7321-1BH01-0AA0	16 DI ^{B)}	7789234xxx	1			1463550000	1	1123000000	16	
	6ES7321-1BH02-0AA0	16 DI ^{B)}	7789234xxx	1			1463550000	1	1123000000	16	
	6ES7321-1BH50-0AA0	16 DI ^{A)}	7789234xxx	1			1463550000	1	1123000000	16	
	6ES7321-1BH80-0AA0	16 DI ^{B)}	7789234xxx	1			1463550000	1	1123000000	16	
	6ES7321-1BH81-0AA0	16 DI ^{B)}	7789234xxx	1			1463550000	1	1123000000	16	
	6ES7321-1BH82-0AA0	16 DI ^{B)}	7789234xxx	1			1463550000	1	1123000000	16	
	6ES7321-1BL00-0AA0	32 DI ^{B)}	7789236xxx	1			1463550000	2	1123000000	32	
	6ES7321-1BL80-0AA0	32 DI ^{B)}	7789236xxx	1			1463550000	2	1123000000	32	
	6ES7321-1BP00-0AA0	64 DI, positive logic ^{B)}	7789771xxx	2			1463550000	4	1123000000	64	
		64 DI, negative logic ^{A)}	7789768xxx	2			1463550000	4	1123000000	64	
	6ES7321-7BH00-0AB0	16 DI ^{B)}	7789192xxx	1			1463550000	1	1123000000	16	
	6ES7321-7BH01-0AB0	16 DI ^{B)}	7789192xxx	1			1463550000	1	1123000000	16	
	6ES7321-7BH80-0AB0	16 DI ^{B)}	7789192xxx	1			1463550000	1	1123000000	16	
	DO	6ES7322-1BH00-0AA0	16 DO ^{A)}	7789234xxx	1			1463550000	1	1122770000	16
		6ES7322-1BH01-0AA0	16 DO ^{A)}	7789234xxx	1			1463550000	1	1122770000	16
6ES7322-1BH10-0AA0		16 DO ^{A)}	7789234xxx	1			1463550000	1	1122770000	16	
6ES7322-1BH81-0AA0		16 DO ^{A)}	7789234xxx	1			1463550000	1	1122770000	16	
6ES7322-1BL00-0AA0		32 DO ^{A)}	7789236xxx	1			1463550000	2	1122770000	32	
6ES7322-1BP00-0AA0		64 DO ^{A)}	7789246xxx	1			1463550000	4	1122770000	64	
6ES7322-1BP50-0AA0		64 DO ^{B)}	7789246xxx	1			1463550000	4	1122800000	64	
									1122890000		















Note A) The TERMSERIES adapter switch, should be positioned on the "A" side.
 B) The TERMSERIES adapter switch, should be positioned on the "B" side.

- The adapters should receive power from an external supply.
- The last 3 digits of the cable code indicates its length in decimeters. For example, if the code ends in 100, the cable would be 10 m long.
- The relays indicated in the table are chosen for 24 V DC control voltage. For digital input cards these can be replaced by TERMSERIES relays with control voltages from 5 V DC to 230 V AC.



PLC SIEMENS S7-400















8-channel solution

	PLC		Cables		Connection		TERMSERIES adapter				TERMSERIES adapter			
	Input/Output cards		Standard				TERMSERIES adapter (Relay 6.4 mm)				TERMSERIES adapter (Relay 12.8 mm)			
	Manufacturer code	Number/ Type of channels	Order No.	Qty.	Screw connection	PUSH IN connection	TERMSERIES adapter		Inputs or outputs with relays		TERMSERIES adapter		Inputs or outputs with relays	
							Order No.	Qty.	Order No.	Qty.	Order No.	Qty.	Order No.	Qty.
DI	6ES7421-1BL00-0AA0	32 DI ^{A)}	1512490xxx	1			1463520000	4	1123000000	32	1463540000	4	1123730000	32
	6ES7421-1BL01-0AA0	32 DI ^{A)}	1512490xxx	1			1463520000	4	1123000000 2618110000	32	1463540000	4	1123730000 2618530000	32
DO	6ES7422-1BH10-0AA0	16 DO ^{B)}	1512510xxx	1			1463520000	2	1122770000 2618000000	16	1463540000	2	1123490000 2618400000	16
	6ES7422-1BH11-0AA0	16 DO ^{B)}	1512510xxx	1			1463520000	2	1122770000 2618000000	16	1463540000	2	1123490000 2618400000	16
	6ES7422-1BL00-0AA0	32 DO ^{B)}	1512490xxx	1			1463520000	4	1122770000 2618000000	32	1463540000	4	1123490000 2618400000	32
	6ES7422-5EH10-0AB0	16 DO ^{B)}	1512520xxx	1			1463520000	2	1122770000 2618000000	16	1463540000	2	1123490000 2618400000	16
	6ES7422-7BL00-0AB0	32 DO ^{B)}	1512490xxx	1			1463520000	4	1122770000 2618000000	32	1463540000	4	1123490000 2618400000	32
	Note A) The TERMSERIES adapter switch, should be positioned on the "A" side. B) The TERMSERIES adapter switch, should be positioned on the "B" side.													

- The adapters should receive power from an external supply.
- The last 3 digits of the cable code indicates its length in decimeters. For example, if the code ends in 100, the cable would be 10 m long.
- The relays indicated in the table are chosen for 24 V DC control voltage. For digital input cards these can be replaced by TERMSERIES relays with control voltages from 5 V DC to 230 V AC.

PLC SIEMENS S7-400

16-channel solution

	PLC		Cables		Connection		TERMSERIES adapter			
	Input/Output cards		Standard				TERMSERIES adapter (Relay 6.4 mm)			
	Manufacturer code	Number/ Type of channels	Order No.	Qty.	Screw connection	PUSH IN connection	TERMSERIES adapter		Inputs or outputs with relays	
							Order No.	Qty.	Order No.	Qty.
DI	6ES7421-1BL00-0AA0	32 DI ^{A)}	7789292xxx	1			1463550000	2	1123000000 2618110000	32
	6ES7421-1BL01-0AA0	32 DI ^{A)}	7789292xxx	1			1463550000	2	1123000000 2618110000	32
DO	6ES7422-1BH10-0AA0	16 DO ^{B)}	7789291xxx	1			1463550000	1	1122770000 2618000000	16
	6ES7422-1BH11-0AA0	16 DO ^{B)}	7789291xxx	1			1463550000	1	1122770000 2618000000	16
	6ES7422-1BL00-0AA0	32 DO ^{B)}	7789292xxx	1			1463550000	2	1122770000 2618000000	32
	6ES7422-5EH10-0AB0	16 DO ^{B)}	7789291xxx	1			1463550000	1	1122770000 2618000000	16
	6ES7422-7BL00-0AB0	32 DO ^{B)}	7789292xxx	1			1463550000	2	1122770000 2618000000	32
	Note A) The TERMSERIES adapter switch, should be positioned on the "A" side. B) The TERMSERIES adapter switch, should be positioned on the "B" side.									

- The adapters should receive power from an external supply.
- The last 3 digits of the cable code indicates its length in decimeters. For example, if the code ends in 100, the cable would be 10 m long.
- The relays indicated in the table are chosen for 24 V DC control voltage. For digital input cards these can be replaced by TERMSERIES relays with control voltages from 5 V DC to 230 V AC.

PLC SIEMENS S7-1500

8-channel solution

	PLC		Cables		Connection		TERMSERIES adapter				TERMSERIES adapter			
	Input/Output cards		Standard				TERMSERIES adapter (Relay 6.4 mm)				TERMSERIES adapter (Relay 12.8 mm)			
	Manufacturer code	Number/ Type of channels	Order No.	Qty.	Screw connection	PUSH IN connection	TERMSERIES adapter		Inputs or outputs with relays		TERMSERIES adapter		Inputs or outputs with relays	
							Order No.	Qty.	Order No.	Qty.	Order No.	Qty.	Order No.	Qty.
DI	6ES7521-1BH00-0AB0	16 DI ^{B)}	1512530xxx	1			1463520000	2	1123000000 2618110000	16	1463540000	2	1123730000 2618530000	16
	6ES7521-1BL00-0AB0 6ES7521-1BL01-0AB0	32 DI ^{B)}	1512590xxx	1			1463520000	4	1123000000 2618110000	32	1463540000	4	1123730000 2618530000	32
	6ES7521-1BH50-0AA0	16 DI ^{A)}	1512540xxx	1			1463520000	2	1123000000 2618110000	16	1463540000	2	1123730000 2618530000	16
DO	6ES7522-1BF00-0AB0	8 DO ^{A)}	1512570xxx	1			1463520000	1	1122770000 2618000000	8	1463540000	1	1123490000 2618400000	8
	6ES7522-1BH00-0AB0 6ES7522-1BH01-0AB0	16 DO ^{A)}	1512530xxx	1			1463520000	2	1122770000 2618000000	16	1463540000	2	1123490000 2618400000	16
	6ES7522-1BL00-0AB0	32 DO ^{A)}	1512590xxx	1			1463520000	4	1122770000 2618000000	32	1463540000	4	1123490000 2618400000	32
	Note A) The TERMSERIES adapter switch, should be positioned on the "–" side. B) The TERMSERIES adapter switch, should be positioned on the "+ " side.													

- The adapters should receive power from an external supply.
- The last 3 digits of the cable code indicates its length in decimeters. For example, if the code ends in 100, the cable would be 10 m long.
- The relays indicated in the table are chosen for 24 V DC control voltage. For digital input cards these can be replaced by TERMSERIES relays with control voltages from 5 V DC to 230 V AC.

PLC SIEMENS S7-1500

















16-channel solution

	PLC		Cables		Connection		TERMSERIES adapter			
	Input/Output cards		Standard				TERMSERIES adapter (Relay 6.4 mm)			
	Manufacturer code	Number/ Type of channels	Order No.	Qty.	Screw connection	PUSH IN connection	TERMSERIES adapter		Inputs or outputs with relays	
							Order No.	Qty.	Order No.	Qty.
DI	6ES7521-1BH00-0AB0	16 DI ^{B)}	1462090xxx	1			1463550000	1	1123000000 2618110000	16
	6ES7521-1BL00-0AB0 6ES7521-1BL01-0AB0	32 DI ^{B)}	1462040xxx	1			1463550000	2	1123000000 2618110000	32
	6ES7521-1BL10-0AA0	32 DI	1994500xxx	1			1463550000	2	1123000000 2618110000	32
	6ES7521-1BH50-0AA0	16 DI ^{A)}	1462100xxx	1			1463550000	1	1123000000 2618110000	16
DO	6ES7522-1BH00-0AB0 6ES7522-1BH01-0AB0	16 DO ^{A)}	1462090xxx	1			1463550000	1	1122770000 2618000000	16
	6ES7522-1BL00-0AB0	32 DO ^{A)}	1462040xxx	1			1463550000	2	1122770000 2618000000	32
	6ES7522-1BL10-0AA0	32 DI	1994500xxx	1			1463550000	2	1122770000 2618000000	32
	6ES7522-1BL10-0AB0	32 DO	1994500xxx	1			1463550000	2	1122770000 2618000000	32
Note A) The TERMSERIES adapter switch, should be positioned on the "–" side. B) The TERMSERIES adapter switch, should be positioned on the "+ " side.										

- The adapters should receive power from an external supply.
- The last 3 digits of the cable code indicates its length in decimeters. For example, if the code ends in 100, the cable would be 10 m long.
- The relays indicated in the table are chosen for 24 V DC control voltage. For digital input cards these can be replaced by TERMSERIES relays with control voltages from 5 V DC to 230 V AC.

PLC SIEMENS -ET 200SP

8-channel solution

	PLC		Cables		Connection		TERMSERIES adapter				TERMSERIES adapter			
	Input/Output cards		Standard				TERMSERIES adapter (Relay 6.4 mm)				TERMSERIES adapter (Relay 12.8 mm)			
	Manufacturer code	Number/ Type of channels	Order No.	Qty.	Screw connection	PUSH IN connection	TERMSERIES adapter		Inputs or outputs with relays		TERMSERIES adapter		Inputs or outputs with relays	
							Order No.	Qty.	Order No.	Qty.	Order No.	Qty.	Order No.	Qty.
DI	6ES7131-6BF01-0AA0	DI 8x24VDC BA	2870170xxx ¹⁾	1			1463520000	1	1123000000	8	1463540000	1	1123730000	8
									2618110000				2618530000	
	6ES7131-6BF01-0BA0	DI 8x24VDC ST	2870170xxx ¹⁾	1			1463520000	1	1123000000	8	1463540000	1	1123730000	8
									2618110000				2618530000	
DO	6ES7131-6BF00-0CA0	DI 08x24Vdc HF	2870170xxx ¹⁾	1			1463520000	1	1123000000	8	1463540000	1	1123730000	8
									2618110000				2618530000	
	6ES7132-6BF01-0AA0	DQ 8x24VDC/0.5A BA	2870170xxx ¹⁾	1			1463520000	1	1122770000	8	1463540000	1	1123490000	8
									2618000000				2618400000	
	6ES7132-6BD20-0BA0	DQ 4x24VDC/2A ST	2870180xxx ¹⁾	1			1463520000	1	1122770000	4	1463540000	1	1123490000	4
									2618000000				2618400000	
DO	6ES7132-6BF01-0BA0	DQ 8x24VDC/0.5A ST	2870170xxx ¹⁾	1			1463520000	1	1122770000	8	1463540000	1	1123490000	8
									2618000000				2618400000	
	6ES7132-6BD20-0CA0	DQ 4x24VDC/2A HF	2870180xxx ¹⁾	1			1463520000	1	1122770000	4	1463540000	1	1123490000	4
									2618000000				2618400000	
	6ES7132-6BF00-0CA0	DQ 8x24VDC/0.5A HF	2870170xxx ¹⁾	1			1463520000	1	1122770000	8	1463540000	1	1123490000	8
									2618000000				2618400000	







Note 1) Starting Terminal block 6ES7193-6BP00-0DA0 included with the cable.

- All interfaces which are connected with an pre-assembled cable with starting Terminal block the supply voltage has to be connected in the interface.
- Please, always take into account the characteristics of the PLC card (voltage, current...) when selecting interfaces. In some cases, the card can work at higher voltages than those indicated in the interface.
- The interfaces are intended to be used inside an IP20 enclosure at least.
- The last 3 digits of the cable code indicate its length in decimetres. For example, if the code ends in 100, the cable would be 10 m long.

* In the case that an input/output card does not appear in this table, you can check our on-line PLC selection guide at www.weidmueller.com where you will always find the most up-to-date information.

PLC SIEMENS -ET 200SP

16-channel solution

	PLC		Cables		Connection		TERMSERIES adapter			
	Input/Output cards		Standard				TERMSERIES adapter (Relay 6.4 mm)			
	Manufacturer code	Number/ Type of channels	Order No.	Qty.	Screw connection	PUSH IN connection	TERMSERIES adapter		Inputs or outputs with relays	
							Order No.	Qty.	Order No.	Qty.
DI	6ES7131-6BF01-0BA0	DI 16x24VDC ST	2732130xxx ¹⁾	1			1463550000	1	1123000000	16
DO	6ES7132-6BH00-0AA0	DQ 16x24VDC/0.5A BA	2732130xxx ¹⁾	1			1463550000	1	1122770000	16
									2618000000	
	6ES7132-6BH01-0BA0	DQ 16x24VDC/0.5A ST	2732130xxx ¹⁾	1			1463550000	1	1122770000	16
									2618000000	



Note 1) Starting Terminal block 6ES7193-6BP00-0DA0 included with the cable.

- All interfaces which are connected with an pre-assembled cable with starting Terminal block the supply voltage has to be connected in the interface.
- Please, always take into account the characteristics of the PLC card (voltage, current...) when selecting interfaces. In some cases, the card can work at higher voltages than those indicated in the interface.
- The interfaces are intended to be used inside an IP20 enclosure at least.
- The last 3 digits of the cable code indicate its length in decimetres. For example, if the code ends in 100, the cable would be 10 m long.

* In the case that an input/output card does not appear in this table, you can check our on-line PLC selection guide at www.weidmueller.com where you will always find the most up-to-date information.

PLC SIEMENS ET 200SP-HA

8-channel solution











	PLC		Cables		Connection		TERMSERIES adapter				TERMSERIES adapter			
	Input/Output cards		Standard				TERMSERIES adapter (Relay 6.4 mm)				TERMSERIES adapter (Relay 12.8 mm)			
	Manufacturer code	Number/ Type of channels	Order No.	Qty.	Screw connection	PUSH IN connection	TERMSERIES adapter		Inputs or outputs with relays		TERMSERIES adapter		Inputs or outputs with relays	
							Order No.	Qty.	Order No.	Qty.	Order No.	Qty.	Order No.	Qty.
DI	6DL1131-6DF00-0PK0 ^{A)}	DI 8x24 ...125VDC HA	2870190xxx ³⁾	1			1463520000	1	1123000000 2618110000	8	1463540000	1	1123730000 2618530000	8
Note A) Only possible if configured at 24 V DC 3) Starting Terminal block 6DL1193-6TP00-0DK0 included with the cable														

- All interfaces which are connected with an pre-assembled cable with starting Terminal block the supply voltage has to be connected in the interface.
- Please, always take into account the characteristics of the PLC card (voltage, current...) when selecting interfaces. In some cases, the card can work at higher voltages than those indicated in the interface.
- The interfaces are intended to be used inside an IP20 enclosure at least.
- The last 3 digits of the cable code indicate its length in decimetres. For example, if the code ends in 100, the cable would be 10 m long.

* In the case that an input/output card does not appear in this table, you can check our on-line PLC selection guide at www.weidmueller.com where you will always find the most up-to-date information.

PLC SIEMENS ET 200SP-HA

16-channel solution













	PLC		Cables		Connection		TERMSERIES adapter			
	Input/Output cards		Standard				TERMSERIES adapter (Relay 6.4 mm)			
	Manufacturer code	Number/ Type of channels	Order No.	Qty.	Screw connection	PUSH IN connection	TERMSERIES adapter		Inputs or outputs with relays	
							Order No.	Qty.	Order No.	Qty.
DI	6DL1131-6BH00-0PH1	DI 16x24VDC (1-wire)	2856330xxx ¹⁾	1			1463550000	1	1123000000	16
			2765980xxx ²⁾						2618110000	
	6DL1131-6BL00-0PH1	DI 32x24VDC (1-wire)	2856330xxx ¹⁾	2			1463550000	2	1123000000	32
			2765980xxx ²⁾						2618110000	
6DL1133-6EW00-0PH1	AI-DI16/DQ16x24VDC HART (digital mode, 1-wire)	2856330xxx ¹⁾	1			1463550000	1	1123000000	16	
		2765980xxx ²⁾						2618110000		
DO	6DL1132-6BH00-0PH1	DQ 16x24VDC/0.5A (1-wire)	2856330xxx ¹⁾	1			1463550000	1	1122770000	16
			2765980xxx ²⁾						2618000000	
	6DL1132-6BL00-0PH1	DQ 32x24VDC/0.5A	2856380xxx ¹⁾	2			1463550000	2	1122770000	32
			2757820xxx ²⁾						2618000000	
Note In the case that in the Order No. appear 2 or more part-numbers, recommendation is to use option 1) 1) Sub-D Terminal block 6DL1193-6TC00-0DH0 NOT included with the cable. Recommended cable for this card 2) Starting Terminal block 6DL1193-6TP00-0DH1 included with the cable										

- All interfaces which are connected with an pre-assembled cable with starting Terminal block the supply voltage has to be connected in the interface.
- Please, always take into account the characteristics of the PLC card (voltage, current...) when selecting interfaces. In some cases, the card can work at higher voltages than those indicated in the interface.
- The interfaces are intended to be used inside an IP20 enclosure at least.
- The last 3 digits of the cable code indicate its length in decimetres. For example, if the code ends in 100, the cable would be 10 m long.

* In the case that an input/output card does not appear in this table, you can check our on-line PLC selection guide at www.weidmueller.com where you will always find the most up-to-date information.

PLC YOKOGAWA CENTUM

8-channel solution













	PLC		Cables		Connection		TERMSERIES adapter				TERMSERIES adapter			
	Input/Output cards		Standard				TERMSERIES adapter (Relay 6.4 mm)				TERMSERIES adapter (Relay 12.8 mm)			
	Manufacturer code	Number/ Type of channels	Order No.	Qty.			TERMSERIES adapter		Inputs or outputs with relays		TERMSERIES adapter		Inputs or outputs with relays	
							Order No.	Qty.	Order No.	Qty.	Order No.	Qty.	Order No.	Qty.
DI	ADV151	32 DI, positive logic ^{B)}	1512190xxx	1			1463520000	4	1123000000	32	1463540000	4	1123730000	32
		32 DI, negative logic ^{A)}	1512210xxx	1			1463520000	4	1123000000 2618110000	32	1463540000	4	1123730000 2618530000	32
	ADV161	64 DI, positive logic ^{B)}	1512190xxx	2			1463520000	8	1123000000	64	1463540000	8	1123730000	64
		64 DI, negative logic ^{A)}	1512210xxx	2			1463520000	8	1123000000 2618110000	64	1463540000	8	1123730000 2618530000	64
DO	ADV551	32 DO ^{B)}	1512220xxx	1			1463520000	4	1122780000 1122890000	32	1463540000	8	1123500000 1123620000	32
	ADV561	64 DO ^{B)}	1512220xxx	2			1463520000	8	1122780000 1122890000	64	1463540000	8	1123500000 1123620000	64

Note
 A) The TERMSERIES adapter switch, should be positioned on the "++" side.
 B) The TERMSERIES adapter switch, should be positioned on the "++" side.

- The adapters should receive power from an external supply.
- The last 3 digits of the cable code indicates its length in decimeters. For example, if the code ends in 100, the cable would be 10 m long.
- The relays indicated in the table are chosen for 24 V DC control voltage. For digital input cards these can be replaced by TERMSERIES relays with control voltages from 5 V DC to 230 V AC.

PLC YOKOGAWA CENTUM

16-channel solution













	PLC		Cables		Connection		TERMSERIES adapter			
	Input/Output cards		Standard				TERMSERIES adapter (Relay 6.4 mm)			
	Manufacturer code	Number/ Type of channels	Order No.	Qty.			TERMSERIES adapter		Inputs or outputs with relays	
							Order No.	Qty.	Order No.	Qty.
DI	ADV151	32 DI, positive logic ^{B)}	1512230xxx	1			1463550000	2	1123000000	32
		32 DI, negative logic ^{A)}	1512240xxx	1			1463550000	2	1123000000 2618110000	32
	ADV161	64 DI, positive logic ^{B)}	1512230xxx	2			1463550000	4	1123000000	64
		64 DI, negative logic ^{A)}	1512240xxx	2			1463550000	4	1123000000 2618110000	64
DO	ADV551	32 DO ^{B)}	1512270xxx	1			1463550000	2	1122780000 1122890000	32
	ADV561	64 DO ^{B)}	1512270xxx	2			1463550000	4	1122780000 1122890000	64

Note
 A) The TERMSERIES adapter switch, should be positioned on the "++" side.
 B) The TERMSERIES adapter switch, should be positioned on the "++" side.

- The adapters should receive power from an external supply.
- The last 3 digits of the cable code indicates its length in decimeters. For example, if the code ends in 100, the cable would be 10 m long.
- The relays indicated in the table are chosen for 24 V DC control voltage. For digital input cards these can be replaced by TERMSERIES relays with control voltages from 5 V DC to 230 V AC.

PLC YOKOGAWA STARDOM

8-channel solution













	PLC		Cables		Connection		TERMSERIES adapter				TERMSERIES adapter			
	Input/Output cards		Standard				TERMSERIES adapter (Relay 6.4 mm)				TERMSERIES adapter (Relay 12.8 mm)			
	Manufacturer code	Number/Type of channels	Order No.	Qty.			TERMSERIES adapter		Inputs or outputs with relays		TERMSERIES adapter		Inputs or outputs with relays	
							Order No.	Qty.	Order No.	Qty.	Order No.	Qty.	Order No.	Qty.
DI	NFDV151	32 DI, positive logic ^{B)}	1512190xxx	1			1463520000	4	1123000000	32	1463540000	4	1123730000	32
		32 DI, negative logic ^{A)}	1512210xxx	1			1463520000	4	1123000000	32	1463540000	4	1123730000	32
	NFDV161	64 DI, positive logic ^{B)}	1512190xxx	2			1463520000	8	1123000000	64	1463540000	8	1123730000	64
		64 DI, negative logic ^{A)}	1512210xxx	2			1463520000	8	1123000000	64	1463540000	8	1123730000	64
DO	NFDV551	32 DO ^{B)}	1512220xxx	1			1463520000	4	1122780000	32	1463540000	8	1123500000	32
	NFDV561	64 DO ^{B)}	1512220xxx	2			1463520000	8	1122780000	64	1463540000	8	1123500000	64

Note
 A) The TERMSERIES adapter switch, should be positioned on the "–" side.
 B) The TERMSERIES adapter switch, should be positioned on the "+ " side.

- The adapters should receive power from an external supply.
- The last 3 digits of the cable code indicates its length in decimeters. For example, if the code ends in 100, the cable would be 10 m long.
- The relays indicated in the table are chosen for 24 V DC control voltage. For digital input cards these can be replaced by TERMSERIES relays with control voltages from 5 V DC to 230 V AC.

PLC YOKOGAWA STARDOM





16-channel solution

	PLC		Cables		Connection		TERMSERIES adapter			
	Input/Output cards		Standard				TERMSERIES adapter (Relay 6.4 mm)			
	Manufacturer code	Number/Type of channels	Order No.	Qty.			TERMSERIES adapter		Inputs or outputs with relays	
							Order No.	Qty.	Order No.	Qty.
DI	NFDV151	32 DI, positive logic ^{B)}	1512230xxx	1			1463550000	2	1123000000	32
		32 DI, negative logic ^{A)}	1512240xxx	1			1463550000	2	1123000000	32
	NFDV161	64 DI, positive logic ^{B)}	1512230xxx	2			1463550000	4	1123000000	64
		64 DI, negative logic ^{A)}	1512240xxx	2			1463550000	4	1123000000	64
DO	NFDV551	32 DO ^{B)}	1512270xxx	1			1463550000	2	1122780000	32
	NFDV561	64 DO ^{B)}	1512270xxx	2			1463550000	4	1122780000	64

Note
 A) The TERMSERIES adapter switch, should be positioned on the "–" side.
 B) The TERMSERIES adapter switch, should be positioned on the "+ " side.

- The adapters should receive power from an external supply.
- The last 3 digits of the cable code indicates its length in decimeters. For example, if the code ends in 100, the cable would be 10 m long.
- The relays indicated in the table are chosen for 24 V DC control voltage. For digital input cards these can be replaced by TERMSERIES relays with control voltages from 5 V DC to 230 V AC.





PLC WEIDMÜLLER u-remote 8-channel solution

	PLC		Cables		Connection		TERMSERIES adapter				TERMSERIES adapter			
	Input/Output cards		Standard				TERMSERIES adapter (Relay 6.4 mm)				TERMSERIES adapter (Relay 12.8 mm)			
	Manufacturer code	Number/ Type of channels	Order No.	Qty.	Screw connection	PUSH IN connection	TERMSERIES adapter		Inputs or outputs with relays		TERMSERIES adapter		Inputs or outputs with relays	
							Order No.	Qty.	Order No.	Qty.	Order No.	Qty.	Order No.	Qty.
DI	UR20-16DI-P-PLC-INT ^{B)}	16 DI	1512470xxx	1			1463520000	2	1123000000 2618110000	16	1463540000	2	1123730000 2618530000	16
DO	UR20-16DO-P-PLC-INT ^{A)}	16 DO	1512470xxx	1			1463520000	2	1122770000 2618000000	16	1463540000	2	1123490000 2618400000	16
Note														
A) The TERMSERIES adapter switch, should be positioned on the "A" side. B) The TERMSERIES adapter switch, should be positioned on the "B" side.														

- The adapters should receive power from an external supply.
- The last 3 digits of the cable code indicates its length in decimeters. For example, if the code ends in 100, the cable would be 10 m long.
- The relays indicated in the table are 24 V DC for the digital input cards. These relays can be replaced by TERMSERIES relays with other voltages, from 5 V DC to 230 V DC.

E

PLC WEIDMÜLLER u-remote 16-channel solution

	PLC		Cables		Connection		TERMSERIES adapter			
	Input/Output cards		Standard				TERMSERIES adapter (Relay 6.4 mm)			
	Manufacturer code	Number/ Type of channels	Order No.	Qty.	Screw connection	PUSH IN connection	TERMSERIES adapter		Inputs or outputs with relays	
							Order No.	Qty.	Order No.	Qty.
DI	UR20-16DI-P-PLC-INT ^{B)}	16 DI	1349670xxx	1			1463550000	1	1123000000 2618110000	16
DO	UR20-16DO-P-PLC-INT ^{A)}	16 DO	1349670xxx	1			1463550000	1	1122770000 2618000000	16
Note										
A) The TERMSERIES adapter switch, should be positioned on the "A" side. B) The TERMSERIES adapter switch, should be positioned on the "B" side.										

- The adapters should receive power from an external supply.
- The last 3 digits of the cable code indicates its length in decimeters. For example, if the code ends in 100, the cable would be 10 m long.
- The relays indicated in the table are 24 V DC for the digital input cards. These relays can be replaced by TERMSERIES relays with other voltages, from 5 V DC to 230 V DC.

TERMSERIES adapters

- Suitable for input and output logic
- Version for 6.4 mm TERMSERIES socket
- Supply connections (PUSH IN) in double version for supply voltage bridging
- User-friendly and clear marking
- 10-pole connecting plug according to DIN EN 60603-13

TIA F10

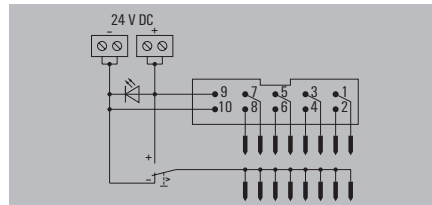

Potential change-over switch

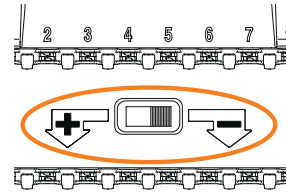

The potential change-over switch is located between contact rows of the TERMSERIES adaptor. It is used to switch the potential of the lower contact row to "+" or "-" potential of the supply voltage.

Installation input

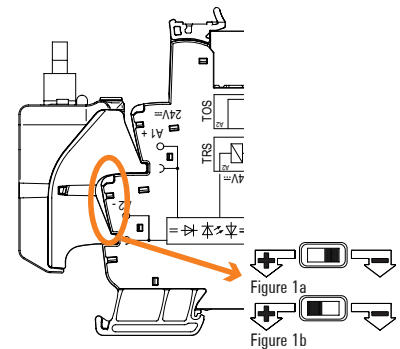

Figure 1a: **Positive-switching logic:** Potential change-over switch to "-", installation on **24 V DC input (A1/A2)**.
 Figure 1b: **Negative-switching logic:** Potential change-over switch to "+", installation on **24 V UC input (A1/A2)**.

Installation output

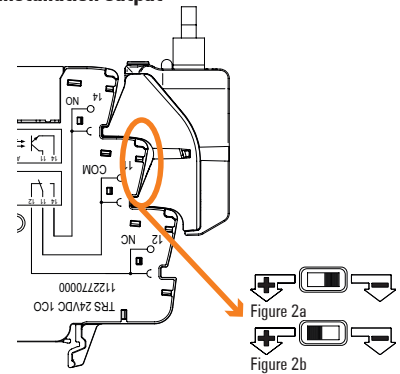

Figure 2a: **Positive-switching logic:** Potential change-over switch to "+", installation on output (11/14).
 Figure 2b: **Negative-switching logic:** Potential change-over switch to "-", installation on output (11/14).

Technical data

Supply	
Voltage supply	24 V DC ± 20 %
Status display	Green LED
Signals	
Rated voltage	24 V DC
Voltage, max.	30 V DC
Rated current (per signal path)	125 mA
Current (per signal path), max.	1 A
Total current of all signals, max.	1 A
Number of signal paths	8
Connection data (supply)	
Wire connection method	PUSH IN
Clamping range, rated connection, min.	0.13 mm ²
Clamping range, rated connection, max.	1.5 mm ²
Number of terminals	4 (+, +, -, -)
Connection data (signal)	
Plug type	10-pole plug according to DIN EN 60603-13, long locking lever
General data	
Ambient temperature (operational)	-40 °C...60 °C
Storage temperature	-40 °C...85 °C
Humidity	5...95% (indoor), T _v = 40°C, without condensation
UL 94 flammability rating	V-0
Approvals	CE; cULus; DNVGL; RS
Insulation coordination	
Pollution degree	2
Overvoltage category	III
Impulse withstand voltage	1.5 kV
Rated voltage	32 V
Protection degree	IP20 in installed state

Supply	
Voltage supply	24 V DC ± 20 %
Status display	Green LED
Signals	
Rated voltage	24 V DC
Voltage, max.	30 V DC
Rated current (per signal path)	125 mA
Current (per signal path), max.	1 A
Total current of all signals, max.	1 A
Number of signal paths	8
Connection data (supply)	
Wire connection method	PUSH IN
Clamping range, rated connection, min.	0.13 mm ²
Clamping range, rated connection, max.	1.5 mm ²
Number of terminals	4 (+, +, -, -)
Connection data (signal)	
Plug type	10-pole plug according to DIN EN 60603-13, long locking lever
General data	
Ambient temperature (operational)	-40 °C...60 °C
Storage temperature	-40 °C...85 °C
Humidity	5...95% (indoor), T _v = 40°C, without condensation
UL 94 flammability rating	V-0
Approvals	CE; cULus; DNVGL; RS
Insulation coordination	
Pollution degree	2
Overvoltage category	III
Impulse withstand voltage	1.5 kV
Rated voltage	32 V
Protection degree	IP20 in installed state

Dimensions	
Depth x width x height	62 / 51 / 43 mm

Dimensions	
Depth x width x height	62 / 51 / 43 mm

Note	
-------------	--

Note	
-------------	--

Ordering data

Type	Qty.	Order No.
TIA F10	1	1463520000

Note	Suitable for 6.4 mm wide TERMSERIES socket
-------------	--

Note	Suitable for 6.4 mm wide TERMSERIES socket
-------------	--

TERMSERIES adapters

TERMSERIES adapters

- Suitable for input and output logic
- Version for 6.4 mm TERMSERIES socket
- User-friendly and clear marking
- 15-pole Sub-D plug-in connector according to DIN 41652 / IEC 60807

TIA SUBD 15S

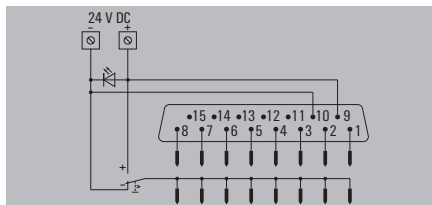

Technical data

Supply	
Voltage supply	24 V DC ± 20 %
Status display	Green LED
Signals	
Rated voltage	24 V DC
Voltage, max.	30 V DC
Rated current (per signal path)	125 mA
Current (per signal path), max.	1 A
Total current of all signals, max.	1 A
Number of signal paths	8
Connection data (supply)	
Wire connection method	PUSH IN
Clamping range, rated connection, min.	0.13 mm ²
Clamping range, rated connection, max.	1.5 mm ²
Number of terminals	2 (+,-)
Connection data (signal)	
Plug type	Sub-D, 15-pole, DIN 41652 / IEC 60807
General data	
Ambient temperature (operational)	-40 °C...60 °C
Storage temperature	-40 °C...85 °C
Humidity	5...95% (indoor), T _a = 40°C, without condensation
UL 94 flammability rating	V-0
Approvals	CE; cULus; DNVGL; RS
Insulation coordination	
Pollution degree	2
Overvoltage category	III
Impulse withstand voltage	1.5 kV
Rated voltage	32 V
Protection degree	IP20 in installed state

Supply	
Voltage supply	24 V DC ± 20 %
Status display	Green LED
Signals	
Rated voltage	24 V DC
Voltage, max.	30 V DC
Rated current (per signal path)	125 mA
Current (per signal path), max.	1 A
Total current of all signals, max.	1 A
Number of signal paths	8
Connection data (supply)	
Wire connection method	PUSH IN
Clamping range, rated connection, min.	0.13 mm ²
Clamping range, rated connection, max.	1.5 mm ²
Number of terminals	2 (+,-)
Connection data (signal)	
Plug type	Sub-D, 15-pole, DIN 41652 / IEC 60807
General data	
Ambient temperature (operational)	-40 °C...60 °C
Storage temperature	-40 °C...85 °C
Humidity	5...95% (indoor), T _a = 40°C, without condensation
UL 94 flammability rating	V-0
Approvals	CE; cULus; DNVGL; RS
Insulation coordination	
Pollution degree	2
Overvoltage category	III
Impulse withstand voltage	1.5 kV
Rated voltage	32 V
Protection degree	IP20 in installed state

Dimensions	
Depth x width x height	mm 52 / 51 / 43

Dimensions	
Depth x width x height	mm 52 / 51 / 43

Note	
------	--

Note	
------	--

Ordering data

Type	Qty.	Order No.
TIA SUBD 15S	1	1463530000

Type	Qty.	Order No.
TIA SUBD 15S	1	1463530000

Note	
Suitable for 6.4 mm wide TERMSERIES socket	

Note	
Suitable for 6.4 mm wide TERMSERIES socket	

Potential change-over switch

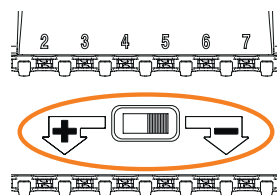

The potential change-over switch is located between contact rows of the TERMSERIES adaptor. It is used to switch the potential of the lower contact row to "+" or "-" potential of the supply voltage.

Installation input

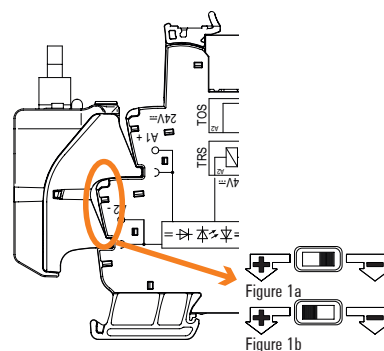

Figure 1a: **Positive-switching logic:** Potential change-over switch to "-", installation on **24 V DC input** (A1/A2).

Figure 1b: **Negative-switching logic:** Potential change-over switch to "+", installation on **24 V UC input** (A1/A2).

Installation output

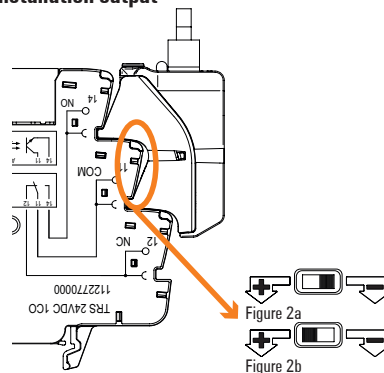

Figure 2a: **Positive-switching logic:** Potential change-over switch to "+", installation on **output** (11/14).

Figure 2b: **Negative-switching logic:** Potential change-over switch to "-", installation on **output** (11/14).

TERMSERIES adapters

- Suitable for input and output logic
- Version for 12.8 mm TERMSERIES socket
- Supply connections (PUSH IN) in double version for supply voltage bridging
- User-friendly and clear marking
- 10-pole connecting plug according to DIN EN 60603-13

TIAL F10

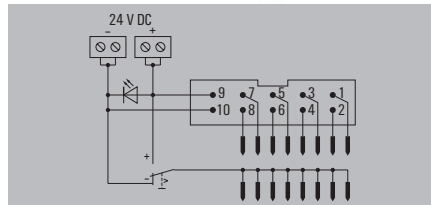

Potential change-over switch

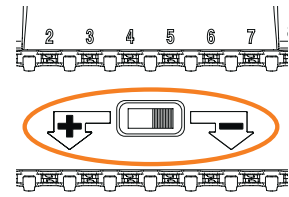

The potential change-over switch is located between contact rows of the TERMSERIES adaptor. It is used to switch the potential of the lower contact row to "+" or "-" potential of the supply voltage.

Installation input

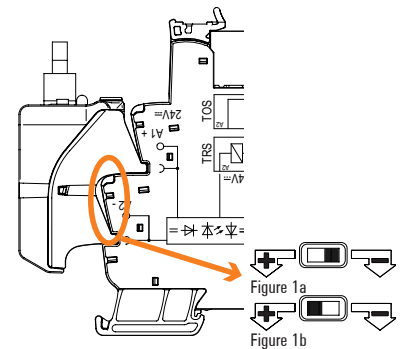

Figure 1a: **Positive-switching logic:** Potential change-over switch to "-", installation on **24 V DC input** (A1/A2).
 Figure 1b: **Negative-switching logic:** Potential change-over switch to "+", installation on **24 V UC input** (A1/A2).

Installation output

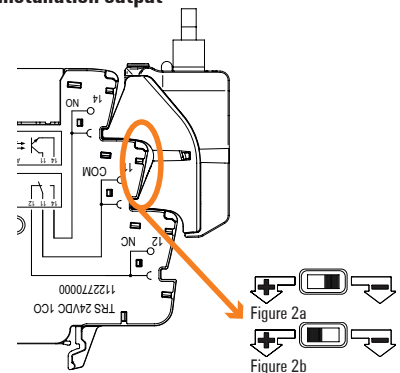

Figure 2a: **Positive-switching logic:** Potential change-over switch to "+", installation on output (11/14).
 Figure 2b: **Negative-switching logic:** Potential change-over switch to "-", installation on output (11/14).

Technical data

Supply	
Voltage supply	24 V DC ± 20 %
Status display	Green LED
Signals	
Rated voltage	24 V DC
Voltage, max.	30 V DC
Rated current (per signal path)	125 mA
Current (per signal path), max.	1 A
Total current of all signals, max.	1 A
Number of signal paths	8
Connection data (supply)	
Wire connection method	PUSH IN
Clamping range, rated connection, min.	0.13 mm ²
Clamping range, rated connection, max.	1.5 mm ²
Number of terminals	4 (+, +, -, -)
Connection data (signal)	
Plug type	10-pole plug according to DIN EN 60603-13, long locking lever
General data	
Ambient temperature (operational)	-40 °C...60 °C
Storage temperature	-40 °C...85 °C
Humidity	5...95% (indoor), T _v = 40°C, without condensation
UL 94 flammability rating	V-0
Approvals	CE; cULus; DNVGL; RS
Insulation coordination	
Pollution degree	2
Overvoltage category	III
Impulse withstand voltage	1.5 kV
Rated voltage	32 V
Protection degree	IP20 in installed state

Dimensions	
Depth x width x height	62 / 102 / 43 mm

Note

Ordering data

Type	Qty.	Order No.
TIAL F10	1	1463540000

Note

Suitable for 12.8 mm wide TERMSERIES socket

TERMSERIES adapters

TERMSERIES adapters

- Suitable for input and output logic
- Version for 6.4 mm TERMSERIES socket
- Supply connections (PUSH IN) in double version for supply voltage bridging
- User-friendly and clear marking
- 20-pole connecting plug according to DIN EN 60603-13

TIAL F20

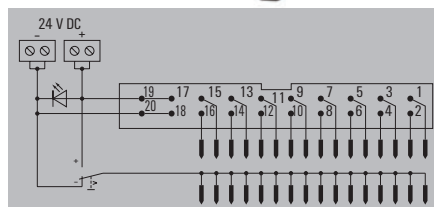

Technical data

Supply	
Voltage supply	24 V DC ± 20 %
Status display	Green LED
Signals	
Rated voltage	24 V DC
Voltage, max.	30 V DC
Rated current (per signal path)	60 mA
Current (per signal path), max.	1 A
Total current of all signals, max.	1 A
Number of signal paths	16
Connection data (supply)	
Wire connection method	PUSH IN
Clamping range, rated connection, min.	0.13 mm ²
Clamping range, rated connection, max.	1.5 mm ²
Number of terminals	4 (+, +, -, -)
Connection data (signal)	
Plug type	20-pole plug according to DIN EN 60603-13, long locking lever
General data	
Ambient temperature (operational)	-40 °C...60 °C
Storage temperature	-40 °C...85 °C
Humidity	5...95% (indoor), T _a = 40°C, without condensation
UL 94 flammability rating	V-0
Approvals	CE; cULus; DNVGL; RS
Insulation coordination	
Pollution degree	2
Overvoltage category	III
Impulse withstand voltage	1.5 kV
Rated voltage	32 V
Protection degree	IP20 in installed state

Dimensions	
Depth x width x height	62 / 102 / 43 mm

Note	
------	--

Ordering data

Type	Qty.	Order No.
TIAL F20	1	1463550000

Note	
Suitable for 6.4 mm wide TERMSERIES socket	

Potential change-over switch

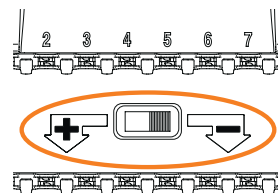

The potential change-over switch is located between contact rows of the TERMSERIES adaptor. It is used to switch the potential of the lower contact row to "+" or "-" potential of the supply voltage.

Installation input

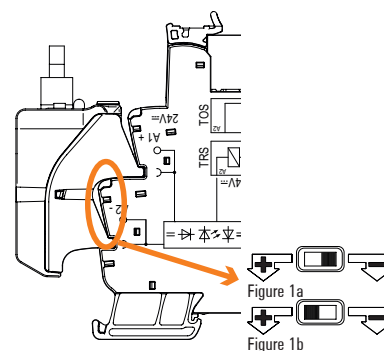

Figure 1a: **Positive-switching logic:** Potential change-over switch to "-", installation on 24 V DC input (A1/A2).

Figure 1b: **Negative-switching logic:** Potential change-over switch to "+", installation on 24 V UC input (A1/A2).

Installation output

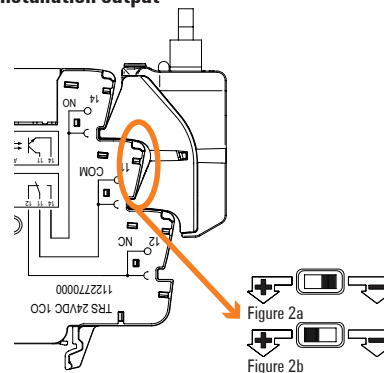
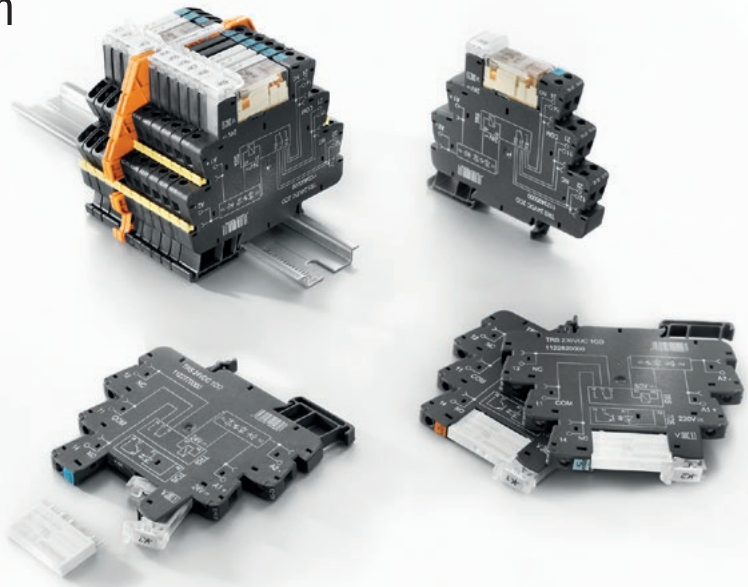

Figure 2a: **Positive-switching logic:** Potential change-over switch to "+", installation on output (11/14).

Figure 2b: **Negative-switching logic:** Potential change-over switch to "-", installation on output (11/14).

TERMSERIES

Relay modules from 6 mm width



Number of contacts / Type of contact		1 NO		1 CO		2 CO		1 CO	
		AgSnO	AgSnO + W	AgNi	AgNi	AgNi + 5µAu	AgNi	AgNi + 5µAu	
		16 A	16 A	16 A	8 A		6 A		
5 V DC	Screw			1479650000	1123470000	1123710000	1122740000	1122980000	
	PUSH IN			2618130000	2614840000	2618580000	2614830000	2618060000	
12 V DC	Screw			1479670000	1123480000	1123720000	1122750000	1122990000	
	PUSH IN			2618040000	2618550000	2618310000	2618180000	2618120000	
24 V DC	Screw	1479780000	1479810000	1479680000	1123490000	1123730000	1122770000	1123000000	
	PUSH IN	2618090000	2617930000	2618100000	2618400000	2618530000	2618000000	2618110000	
Input UC									
24 V UC	Screw			1479690000	1123500000	1123740000	1122780000	1123010000	
	PUSH IN			2617910000	2618320000	2618540000	2618220000	2618160000	
48 V UC	Screw			1479700000	1123510000	1123750000	1122790000	1123020000	
	PUSH IN			2617960000	2618520000	2618560000	2618240000	2618170000	
60 V UC	Screw			1479710000	1123520000	1123770000	1122800000	1123030000	
	PUSH IN			2617970000	2618290000	2618360000	2618140000	2618070000	
120 V UC	Screw			1479730000	1123530000	1123780000	1122810000	1123170000	
	PUSH IN			2618280000	2618570000	2618590000	2618010000	2618080000	
230 V UC	Screw			1479740000	1123540000	1123790000	1122820000	1123050000	
	PUSH IN			2618260000	2618440000	2618300000	2618050000	2618210000	
24 - 230 V UC new ED2 version	Screw	2662970000	2662980000	2662960000	2662880000	2662890000	2662850000	2662860000	
	PUSH IN	2663130000	2663140000	2663120000	2663040000	2663050000	2663010000	2663020000	
Input AC									
120 V AC RC	Screw			1479750000	1123550000	1123800000	1122830000	1123070000	
	PUSH IN			2618270000	2618470000	2618490000	2618150000	2618030000	
230 V AC RC	Screw			1479760000	1123570000	1123810000	1122840000	1123080000	
	PUSH IN			2618190000	2618330000	2618500000	2618200000	2617950000	
Note		Selection of preferred types, other modules upon request							

Pre-assembled cables for general applications

Pre-assembled cables for general applications	Introduction	F.2
	PAC-UNIV-HE - Universal pre-assembled cables for ribbon connectors according IEC 60603-13	F.3
	PAC-UNIV-D - Universal pre-assembled cables for SUB-D connectors according IEC 60807	F.4
	PAC-HD - Universal pre-assembled cables for High density SUB-D connectors	F.6
	PAC-ELCO - Pre-assembled cables for RS ELCO interfaces	F.8
	Selection guide - PLC Universal pre-assembled cables	F.9

Pre-assembled cables for general applications

Pre-assembled cables with the corresponding plug-in connector systems are used in the connection between the controller and the interface. These pre-assembled cables allow maximum savings for the user, as they achieve a cost reduction in the materials, due to fewer individual cables, conductors and cable ducting.

PAC-UNIV Pre-assembled cables for RS F and RS SD interfaces



This range of pre-assembled cables for ribbon cabling complies with IEC 60603-13/DIN 41651 SUB-D in accordance with IEC 60807-2/DIN 41652 and SUB-D High density.

One end of the cable is prepared for connecting with the RS-F or RS SD interfaces and the other end for wire-end ferrules or to a SUB-D connector or ribbon cable.

Colour code acc. To DIN 47,100 and available in different lengths.

PAC-ELCO Pre-assembled cables for RS ELCO interfaces



With pre-assembled cables for ELCO connectors, one end of the cable is prepared for connecting with the RS-ELCO interfaces. The other end is connected to a wire-end ferrule or to a female ELCO connector. Colour code acc. To DIN 47,100 and available in different lengths.

PAC-UNIV Pre-assembled cables with PLC original connector

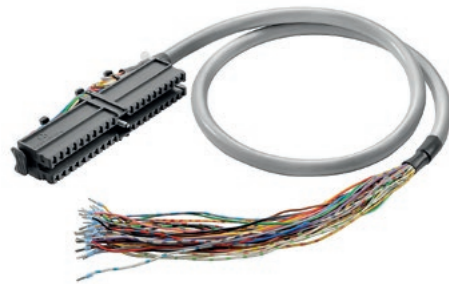

These range of pre-assembled cables are provided with the original PLC connector in one end of the cables and with ferrules in the other.

Colour code acc. To DIN 47,100 and available in different lengths.

Available for main PLC's of the market. More options on demand.

PAC-UNIV-HE – Universal pre-assembled cables for ribbon connectors according IEC 60603-13

Pre-assembled ribbon cable according to IEC-60603-13/DIN 41651.

- Ribbon cable - ribbon cable
 - Ribbon cable - wire-end ferrules
- Cable
- Halogen free cables
 - No halogen-free cables: LIYY
 - Colour code according DIN 47100

Technical data

Rated data
Operating voltage
Permissible current strength per path, max.
Total current, max.
Resistance
Nominal rating, control cable
Wire cross-section
General data
Ambient temperature (operational)
Storage temperature

PAC-UNIV-HE-F / PAC-HE-F-HF

Ribbon cable to wire-end ferrules connector



≤ 60 V DC ≤ 25 V AC
1 A
3 A
≤ 150 m Ω /m
0.14 mm ²
-10...50 °C
-10...60 °C

PAC-UNIV-HE-HE / PAC-HE-HE-HF

Ribbon cable to ribbon cable connector



≤ 60 V DC ≤ 25 V AC
1 A
3 A
≤ 150 m Ω /m
0.14 mm ²
-10...50 °C
-10...60 °C

Note

Ordering data

No halogen-free cables	
10-pole connector	
14-pole connector	
16-pole connector	
20-pole connector	
26-pole connector	
34-pole connector	
40-pole connector	
50-pole connector	
Halogen-free cables	
10-pole connector	
14-pole connector	
16-pole connector	
20-pole connector	
26-pole connector	
34-pole connector	
40-pole connector	

Type	Qty.	Order No.
PAC-UNIV-HE10-F-1M	1	1349730010
PAC-UNIV-HE14-F-1M	1	1349740010
PAC-UNIV-HE16-F-1M	1	1349770010
PAC-UNIV-HE20-F-1M	1	1349790010
PAC-UNIV-HE26-F-1M	1	1349820010
PAC-UNIV-HE34-F-1M	1	1349840010
PAC-UNIV-HE40-F-1M	1	1349880010
PAC-HE10-F-HF-1M	1	2420540010
PAC-HE14-F-HF-1M	1	2425650010
PAC-HE16-F-HF-1M	1	2425710010
PAC-HE20-F-HF-1M	1	2425660010
PAC-HE26-F-HF-1M	1	2425720010
PAC-HE34-F-HF-1M	1	2425690010
PAC-HE40-F-HF-1M	1	2425680010

Type	Qty.	Order No.
PAC-UNIV-HE10-HE10-1M	1	1349630010
PAC-UNIV-HE14-HE14-1M	1	1349640010
PAC-UNIV-HE16-HE16-1M	1	1349650010
PAC-UNIV-HE20-HE20-1M	1	1349670010
PAC-UNIV-HE26-HE26-1M	1	1349680010
PAC-UNIV-HE34-HE34-1M	1	1349690010
PAC-UNIV-HE40-HE40-1M	1	1349700010
PAC-UNIV-HE50-HE50-1M	1	1349720010
PAC-HE10-HE10-HF-1M	1	2420550010
PAC-HE14-HE14-HF-1M	1	2425940010
PAC-HE16-HE16-HF-1M	1	2425700010
PAC-HE20-HE20-HF-1M	1	2425730010
PAC-HE26-HE26-HF-1M	1	2425740010
PAC-HE34-HE34-HF-1M	1	2425950010
PAC-HE40-HE40-HF-1M	1	2425960010

Note

The last 3 digits of the cable code indicate its length. For example, if the code ends in 100, the cable would be 10 m long.

The last 3 digits of the cable code indicate its length. For example, if the code ends in 100, the cable would be 10 m long.

PAC-UNIV-D – Universal pre-assembled cables for SUB-D connectors according IEC 60807

Pre-assembled SUB-D cable according to IEC-60807/DIN 41652.

- SUB-D to SUB-D connector
 - SUB-D to wire-end ferrules
 - Shielded cable
- Cable
- Halogen free cables
 - No halogen-free cables: LIYcY
 - Colour code according DIN 47100

Technical data

Rated data	
Operating voltage	≤ 60 V DC ≤ 25 V AC
Permissible current strength per path, max.	1 A
Total current, max.	3 A
Resistance	≤ 80 mΩ/m
Nominal rating, control cable	
Wire cross-section	0.25 mm ²
General data	
Ambient temperature (operational)	-10...50 °C
Storage temperature	-10...60 °C

PAC-UNIV-D-F/ PAC-D-F-HF

SUB-D to wire-end ferrules



Operating voltage	≤ 60 V DC ≤ 25 V AC
Permissible current strength per path, max.	1 A
Total current, max.	3 A
Resistance	≤ 80 mΩ/m
Wire cross-section	0.25 mm ²
Ambient temperature (operational)	-10...50 °C
Storage temperature	-10...60 °C

PAC-UNIV-D-D /PAC-D-D-HF

SUB-D male to male or SUB-D female to female connector



Operating voltage	≤ 60 V DC ≤ 25 V AC
Permissible current strength per path, max.	1 A
Total current, max.	3 A
Resistance	≤ 80 mΩ/m
Wire cross-section	0.25 mm ²
Ambient temperature (operational)	-10...50 °C
Storage temperature	-10...60 °C

Note

Ordering data

No halogen-free cables	
9-pole male connector	PAC-UNIV-D9M-F-1M
15-pole male connector	PAC-UNIV-D15M-F-1M
25-pole male connector	PAC-UNIV-D25M-F-1M
37-pole male connector	PAC-UNIV-D37M-F-1M
50-pole male connector	PAC-UNIV-D50M-F-1M
9-pole female connector	PAC-UNIV-D9F-F-1M
15-pole female connector	PAC-UNIV-D15F-F-1M
25-pole female connector	PAC-UNIV-D25F-F-1M
37-pole female connector	PAC-UNIV-D37F-F-1M
50-pole female connector	PAC-UNIV-D50F-F-1M
Halogen-free cables	
9-pole male connector	PAC-D9M-F-HF-1M
15-pole male connector	PAC-D15M-F-HF-1M
25-pole male connector	PAC-D25M-F-HF-1M
37-pole male connector	PAC-D37M-F-HF-1M
9-pole female connector	PAC-D9F-F-HF-1M
15-pole female connector	PAC-D15F-F-HF-1M
25-pole female connector	PAC-D25F-F-HF-1M
37-pole female connector	PAC-D37F-F-HF-1M

Type	Qty.	Order No.
PAC-UNIV-D9M-F-1M	1	1350400010
PAC-UNIV-D15M-F-1M	1	1350420010
PAC-UNIV-D25M-F-1M	1	1350430010
PAC-UNIV-D37M-F-1M	1	1350440010
PAC-UNIV-D50M-F-1M	1	1350450010
PAC-UNIV-D9F-F-1M	1	1350470010
PAC-UNIV-D15F-F-1M	1	1350480010
PAC-UNIV-D25F-F-1M	1	1350490010
PAC-UNIV-D37F-F-1M	1	1350500010
PAC-UNIV-D50F-F-1M	1	1350520010
PAC-D9M-F-HF-1M	1	2420560010
PAC-D15M-F-HF-1M	1	2425980010
PAC-D25M-F-HF-1M	1	2425990010
PAC-D37M-F-HF-1M	1	2426000010
PAC-D9F-F-HF-1M	1	2426020010
PAC-D15F-F-HF-1M	1	2426030010
PAC-D25F-F-HF-1M	1	2426040010
PAC-D37F-F-HF-1M	1	2426050010

Type	Qty.	Order No.
PAC-UNIV-D9M-D9M-1M	1	1349750010
PAC-UNIV-D15M-D15M-1M	1	1349780010
PAC-UNIV-D25M-D25M-1M	1	1349800010
PAC-UNIV-D37M-D37M-1M	1	1349830010
PAC-UNIV-D50M-D50M-1M	1	1349850010
PAC-UNIV-D9F-D9F-1M	1	1349870010
PAC-UNIV-D15F-D15F-1M	1	1349890010
PAC-UNIV-D25F-D25F-1M	1	1349920010
PAC-UNIV-D37F-D37F-1M	1	1349930010
PAC-UNIV-D50F-D50F-1M	1	1349940010
PAC-D9M-D9M-HF-1M	1	2420570010
PAC-D15M-D15M-HF-1M	1	2426070010
PAC-D25M-D25M-HF-1M	1	2426080010
PAC-D37M-D37M-HF-1M	1	2426090010
PAC-D9F-D9F-HF-1M	1	2426110010
PAC-D15F-D15F-HF-1M	1	2426180010
PAC-D25F-D25F-HF-1M	1	2426120010
PAC-D37F-D37F-HF-1M	1	2426130010

Note

The last 3 digits of the cable code indicate its length. For example, if the code ends in 100, the cable would be 10 m long.

The last 3 digits of the cable code indicate its length. For example, if the code ends in 100, the cable would be 10 m long.

PAC-UNIV-D – Universal pre-assembled cables for SUB-D connectors according IEC 60807

Pre-assembled SUB-D cable according to IEC-60807/DIN 41652.

- SUB-D to SUB-D connector
- SUB-D to wire-end ferrules
- Shielded cable

Cable

- Halogen free cables
- No halogen-free cables: LIYcY
- Colour code according DIN 47100

PAC-UNIV-DxM-DxF/PAC-DxM-DxF-HF

SUB-D male-female connector



Technical data

Rated data	
Operating voltage	≤ 60 V DC ≤ 25 V AC
Permissible current strength per path, max.	1 A
Total current, max.	3 A
Resistance	≤ 80 mΩ/m
Nominal rating, control cable	
Wire cross-section	0.25 mm ²
General data	
Ambient temperature (operational)	-10...50 °C
Storage temperature	-10...60 °C

Note

Ordering data

No halogen-free cables		Type	Qty.	Order No.
	9-pole male/female connector	PAC-UNIV-D9M-D9F-1M	1	1349950010
	15-pin male/female connector	PAC-UNIV-D15M-D15F-1M	1	1349970010
	25-pin male/female connector	PAC-UNIV-D25M-D25F-1M	1	1349980010
	37-pin male/female connector	PAC-UNIV-D37M-D37F-1M	1	1349990010
	50-pin male/female connector	PAC-UNIV-D50M-D50F-1M	1	1350000010
Halogen-free cables				
	9-pole male/female connector	PAC-D9M-D9F-HF-1M	1	2420580010
	15-pin male/female connector	PAC-D15M-D15F-HF-1M	1	2426150010
	25-pin male/female connector	PAC-D25M-D25F-HF-1M	1	2426160010
	37-pin male/female connector	PAC-D37M-D37F-HF-1M	1	2426190010

Note

The last 3 digits of the cable code indicate its length. For example, if the code ends in 100, the cable would be 10 m long.

PAC-HD – Universal pre-assembled cables for High density SUB-D connectors

Pre-assembled high density SUB-D cable

- HD SUB-D to HD SUB-D connector
- HD SUB-D to wire-end ferrules

Shielded cable LiYcY:

- 15-26 poles: 0.25 mm² (resistance ≤ 80 mΩ/m)
- 44-62 poles: 0.14 mm² (resistance ≤ 150 mΩ/m)
- Colour code according DIN 47100

PAC-HD-F

HD SUB-D to wire-end ferrules



PAC-HD-HD

HD SUB-D male to male or HD SUB-D female to female connector



Technical data

Rated data
Operating voltage
Permissible current strength per path, max.
Total current, max.
Capacity wire / wires
Capacity wire / shield
Nominal rating, control cable
Cable
Material
General data
Ambient temperature (operational)
Storage temperature

≤ 60 V DC ≤ 25 V AC
1 A
3 A
300 pF/m
300 pF/m
Cable LiYcY
PVC
-10...50 °C
-10...60 °C

≤ 60 V DC ≤ 25 V AC
1 A
3 A
300 pF/m
300 pF/m
Cable LiYcY
PVC
-10...50 °C
-10...60 °C

Note

Ordering data

15-pole male connector
26-pole male connector
44-pole male connector
62-pole male connector
15-pole female connector
26-pole female connector
44-pole female connector
62-pole female connector

Type	Qty.	Order No.
PAC-HD15M-F-V0-1M	1	1440810010
PAC-HD26M-F-V0-1M	1	2093680010
PAC-HD44M-F-V0-1M	1	2093910010
PAC-HD15F-F-V0-1M	1	1440780010
PAC-HD26F-F-V0-1M	1	2093080010
PAC-HD44F-F-V0-1M	1	2093090010

Type	Qty.	Order No.
PAC-HD15M-HD15M-V0-1M	1	1440740010
PAC-HD26M-HD26M-V0-1M	1	2094720010
PAC-HD44M-HD44M-V0-1M	1	2094730010
PAC-HD62M-HD62M-V0-1M	1	2094770010
PAC-HD15F-HD15F-V0-1M	1	1440750010
PAC-HD26F-HD26F-V0-1M	1	2094140010
PAC-HD44F-HD44F-V0-1M	1	2094180010
PAC-HD62F-HD62F-V0-1M	1	1988930010

Note

The last 3 digits of the cable code indicate its length. For example, if the code ends in 100, the cable is 10 m long.

The last 3 digits of the cable code indicate its length. For example, if the code ends in 100, the cable is 10 m long.

PAC-HD – Universal pre-assembled cables for High density SUB-D connectors

Pre-assembled high density SUB-D cable

- HD SUB-D to HD SUB-D connector
- HD SUB-D to wire-end ferrules

Shielded cable LiYcY:

- 15-26 poles: 0.25 mm² (resistance ≤ 80 mΩ/m)
- 44-62 poles: 0.14 mm² (resistance ≤ 150 mΩ/m)
- Colour code according DIN 47100

PAC-HDxM-HDxF

HD SUB-D male-female connector



Technical data

Rated data
Operating voltage
Permissible current strength per path, max.
Total current, max.
Capacity wire / wires
Capacity wire / shield
Nominal rating, control cable
Cable
Material
General data
Ambient temperature (operational)
Storage temperature

≤ 60 V DC ≤ 25 V AC
1 A
3 A
300 pF/m
300 pF/m
Cable LiYcY
PVC
-10...50 °C
-10...60 °C

Note

Ordering data

15-pin male/female connector
26-pin male/female connector
44-pin male/female connector
62-pin male/female connector

Type	Qty.	Order No.
PAC-HD15M-HD15F-V0-1M	1	1440770010
PAC-HD26M-HD26F-V0-1M	1	2003420010
PAC-HD44M-HD44F-V0-1M	1	1989360010
PAC-HD62M-HD62F-V0-1M	1	2094800010

Note

The last 3 digits of the cable code indicate its length. For example, if the code ends in 100, the cable is 10 m long.

**PAC-ELCO Pre-assembled cables
for RS ELCO interfaces**

- Pre-assembled ELCO female cable
- ELCO to ELCO connector
 - ELCO to wire-end ferrules
 - Polarizer in position 1
- Shielded cable LiYcY

PAC-ELCO



Technical data

Rated data	
Operating voltage	250 V
Permissible current strength per path, max.	1 A
Total current, max.	3 A
Resistance	≤ 80 mΩ/m
Capacity wire / wires	300 pF/m
Capacity wire / shield	300 pF/m
Cable features	
Cable	Cable LiYcY
Material	PVC
Wire cross-section	0.25 mm ²
General data	
Ambient temperature (operational)	-10...50 °C
Storage temperature	-10...60 °C

Note

Ordering data

Type	Qty.	Order No.
20-pole socket / 20-pole socket	1	7789760010
20-pole socket / wire-end ferrules	1	7789761010
38-pole socket / 38-pole socket	1	7789762010
38-pole socket / wire-end ferrules	1	7789763010
56-pole socket / 56-pole socket (only 32 poles connected)	1	7789773010
56-pole socket / wire-end ferrules (only 32 poles connected)	1	7789774010
56-pole socket / 56-pole socket (only 54 poles connected)	1	7789775010
56-pole socket / wire-end ferrules (only 54 poles connected)	1	7789776010
56-pole socket / 56-pole socket	1	7789764010
56-pole socket / wire-end ferrules	1	7789765010

Note

The last 3 digits of the cable code indicate its length. For example, if the code ends in 100, the cable would be 10 m long.

PLC Universal pre-assembled cables



Pre-assembled cables for general applications

Cables	PLC Connector	Cable type	To use with
Universal cables for Siemens S7-300			
7789606xxx	Siemens S7-300 20 poles crimping connector	Unshielded LIYY 0,25 mm ²	Siemens S7-300 digital cards with Siemens 20 poles connector
1323930xxx	Siemens S7-300 20 poles crimping connector	Unshielded 0,5 mm ²	Siemens S7-300 digital cards with Siemens 20 poles connector
7789607xxx	Siemens S7-300 20 poles crimping connector	Shielded LIYCY 0,25 mm ²	Siemens S7-300 analog cards with Siemens 20 poles connector
7789608xxx	Siemens S7-300 40 poles crimping connector	Unshielded LIYY 0,25 mm ²	Siemens S7-300 digital cards with Siemens 40 poles connector
1323960xxx	Siemens S7-300 40 poles crimping connector	Unshielded 0,5 mm ²	Siemens S7-300 digital cards with Siemens 40 poles connector
7789609xxx	Siemens S7-300 40 poles crimping connector	Shielded LIYCY 0,25 mm ²	Siemens S7-300 analog cards with Siemens 40 poles connector
1452610xxx	40 poles connector FCN	Unshielded LIYY 0,25 mm ²	Siemens S7-300 digital cards with 40 poles connector
Universal cables for Siemens S7-400			
1504020xxx	Siemens S7-400 48 poles	Shielded LIYCY 0,25 mm ²	Siemens S7-400 analog cards with Siemens 48 poles connector
Universal cables for Siemens S7-1500			
1466230xxx	Siemens S7-1500 35mm 40 poles	Unshielded LIYY 0,25 mm ²	Siemens S7-1500 digital cards with 35 mm Siemens 40 poles connector
1466240xxx	Siemens S7-1500 35mm 40 poles	Shielded LIYCY 0,25 mm ²	Siemens S7-1500 analog cards with 35 mm Siemens 40 poles connector
2000150xxx	Siemens S7-1500 35mm 40 poles	Unshielded 0,5 mm ²	Siemens S7-1500 digital cards with 35 mm Siemens 40 poles connector
2579210xxx	Siemens S7-1500 25mm 40 poles	Unshielded LIYY 0,25 mm ²	Siemens S7-1500 digital cards with 25 mm Siemens 40 poles connector
2579220xxx	Siemens S7-1500 25mm 40 poles	Shielded LIYCY 0,25 mm ²	Siemens S7-1500 analog cards with 25 mm Siemens 40 poles connector
2579230xxx	Siemens S7-1500 25mm 40 poles	Unshielded 0,5 mm ²	Siemens S7-1500 digital cards with 25 mm Siemens 40 poles connector
Universal cables for Siemens ET200SP			
2732170xxx	Starting base 6ES7193-6BP00-0DA0 16P	Shielded LIYCY 0,25 mm ²	Siemens ET200SP digital cards with Starting base 6ES7193-6BP00-0DA0 16P
2732180xxx	Bridge base 6ES7193-6BP00-0BA0 16P	Shielded LIYCY 0,25 mm ²	Siemens ET200SP digital cards with Starting base 6ES7193-6BP00-0BA0 16P
Universal cables for Rockwell Control Logix			
7789731xxx	Rockwell 1756-TBNH 20 poles	Unshielded LIYY 0,25 mm ²	Rockwell Control Logix digital cards with Rockwell 20 poles connector
7789732xxx	Rockwell 1756-TBNH 20 poles	Shielded LIYCY 0,25 mm ²	Rockwell Control Logix analog cards with Rockwell 20 poles connector
7789733xxx	Rockwell 1756-TBCH 36 poles	Unshielded LIYY 0,25 mm ²	Rockwell Control Logix digital cards with Rockwell 36 poles connector
7789734xxx	Rockwell 1756-TBCH 36 poles	Shielded LIYCY 0,25 mm ²	Rockwell Control Logix analog cards with Rockwell 36 poles connector
Universal cables for Rockwell Compact Logix			
1350250xxx	Rockwell 1769-RTBN18 18 poles	Unshielded LIYY 0,25 mm ²	Rockwell Compact Logix digital cards with Rockwell 18 poles connector
1350270xxx	Rockwell 1769-RTBN18 18 poles	Shielded LIYCY 0,25 mm ²	Rockwell Compact Logix analog cards with Rockwell 18 poles connector
1349880xxx	IDC connector 40 poles	Unshielded LIYY 0,14 mm ²	Rockwell Compact Logix cards with DIN 41651 type 40 poles connector
Universal cables for Schneider M340			
1355950xxx	Schneider BMX FTB 2000 20 poles	Unshielded LIYY 0,25 mm ²	Schneider M340 digital cards with Schneider 20 poles connector
2426750xxx	Schneider BMX FTB 2000 20 poles	Shielded LIYCY 0,25 mm ²	Schneider M340 analog cards with Schneider 20 poles connector
2426760xxx	Schneider BMX FTB 2820 28 poles	Shielded LIYCY 0,25 mm ²	Schneider M340 analog cards with Schneider 28 poles connector
1452610xxx	40 poles connector FCN	Unshielded LIYY 0,25 mm ²	Schneider M340 digital cards with 40 poles connector
2509360xxx	40 poles connector FCN	Shielded LIYCY 0,25 mm ²	Schneider M340 digital cards with 40 poles connector
Universal cables for Mitsubishi Melsec Q			
1452610xxx	40 poles connector FCN	Unshielded LIYY 0,25 mm ²	Mitsubishi Melsec Q digital cards with 40 poles connector
Universal cables for Omron CJ1W			
2426780xxx	Omron CJ-OD507-18P 18 poles	Unshielded LIYY 0,25 mm ²	Omron CJ1W digital cards with Omron 18 poles connector
2426790xxx	Omron CJ-OD507-18P 18 poles	Shielded LIYCY 0,25 mm ²	Omron CJ1W analog cards with Omron 18 poles connector
1452610xxx	40 poles connector FCN	Unshielded LIYY 0,25 mm ²	Omron CJ1W digital cards with 40 poles connector
Universal cables for Gefanuc RX3i			
2680830xxx	Gefanuc IC694ACC311 20 poles	Unshielded LIYY 0,25 mm ²	RX3i digital cards with Gefanuc 28 poles connector
2680840xxx	Gefanuc IC694ACC311 20 poles	Shielded LIYCY 0,25 mm ²	RX3i analog cards with Gefanuc 20 poles connector
7789842xxx	Gefanuc IC694TBS032 36 poles	Unshielded LIYY 0,25 mm ²	RX3i digital cards with Gefanuc 38 poles connector
2435780xxx	Gefanuc IC694TBS032 36 poles	Shielded LIYCY 0,25 mm ²	RX3i analog cards with Gefanuc 38 poles connector
Universal cables for Weidmüller u-remote			
1349790xxx	IDC connector 20 poles	Unshielded LIYY 0,14 mm ²	Weidmüller U-Remote cards with DIN 41651 type 20 poles connector

F

Migration Systems

Migration Systems	Introduction - Bridge System	G.2
	Migration from Siemens S5-115 - Bridge System	G.4
	Migration from Siemens S5-135 - Bridge System	G.6
	Migration from Schneider TSX - Bridge System	G.8
	PAC - Pre-assembled cables from Siemens S5-115/S5-135 Schneider TSX/Premium Rockwell PLC-5 to ferrules	G.10
	FAD - front adapters for migrations from Siemens S5-115 - Bridge System	G.12
	FAD - front adapters for migrations from Siemens S5-135 - Bridge System	G.16
	FAD - front adapters for migrations from Schneider TSX47 - Bridge System	G.20
	FAD - front adapters for migrations from Schneider Premium - Bridge System	G.26
	FAD - front adapters for migrations from Rockwell PLC-5 - Bridge System	G.29
	Migration RACK - Migration accessories	G.33
	Accessories selection table	G.35
	Introduction - Card System	G.36
	FAD - front adapters for migrations from Rockwell PLC-5 - Card System	G.39
	FAD - front adapters for migrations from Honeywell IPC620 - Card System	G.44
	FAD - front adapters for migrations from Schneider Quantum - Card System	G.47
	FAD - front adapters for migrations from Siemens APAC migration module - Card System	G.48
	RS F20 X - Redundancy interfaces	G.49

Replace PLC systems without any downtimes

Our PLC Migration Bridge System affords maximum flexibility when no space in the cabinet

When industrial systems age or are no longer state-of-the-art, or when there is a limited supply of support and/or spare parts, systems need to be updated at a process industry plant's control level.

When replacing PLC systems, it is vital to avoid cabling errors and to keep plant downtimes to a minimum during the migration process.

PLC migration interfaces from Weidmüller provide you with a secure way of replacing the control level. Even adaptations or changes to the infrastructure can be performed simply and quickly without any need to intervene in the field cabling.



In many fields, such as the process, chemical, cement or automotive industry, and in the energy sector, plant operators need to perform PLC system updates without any downtimes. In situations such as these ones, PLC migration interfaces from Weidmüller are the perfect solution

Retrofitting made easy – the migration process



Step 1

The new rack system takes the place of the old control so that no additional space is required in the panel.



Step 2

The relevant front adapter is used in the rack system so that the existing PLC cable connections and an end of the new pre-mounted cables can be inserted as the next step.



Step 3

In the last step, the rail with the new control is placed and connected to the other end of the pre-mounted cable.

Your special advantages:

Reach your goal faster

With Weidmüller PLC migration interfaces, there's no need to make any changes to the field cabling, so this shortens the amount of time needed to upgrade the entire plant. Indeed, what used to be a PLC migration process that lasted a good few weeks is now an update that can be completed in just a few hours – including the system tests. Production facilities can return to operating as normal even after the briefest of downtimes.

Use independent of the manufacturer

Irrespective of the PLC manufacturer, at Weidmüller you'll find the perfect portfolio of migration components to suit your purpose.

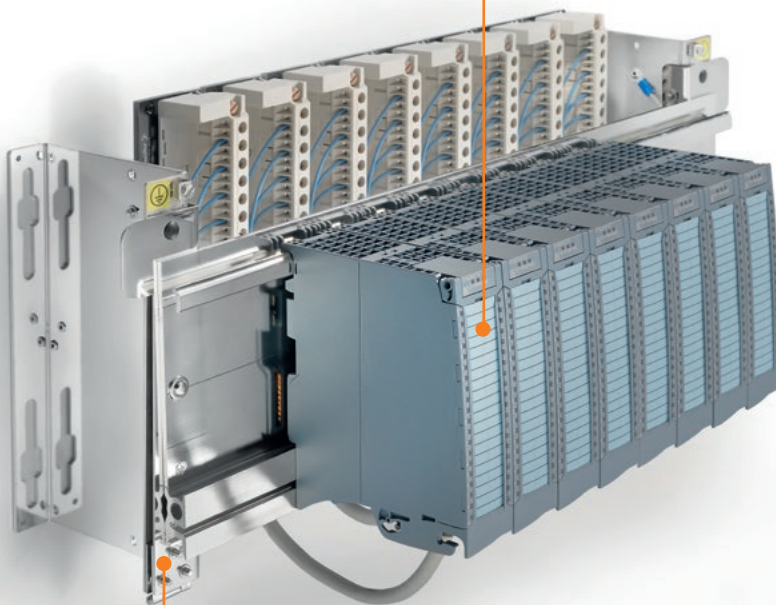

Less space required

With our new migration interfaces, PLC migration doesn't automatically translate into you suddenly having less free space in your cabinet. The rack system replaces the old control and combines connection levels and the new control to create one compact unit. Due to the possibility of easily turning down the upper deck the connection components are accessible without any difficulty.

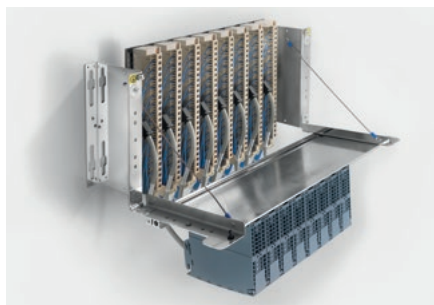

Error-free migration

Easy-to choose migration components and the possibility of combining tested, pre-assembled cables and front plug-in adapters make for error-free connection of the new PLC.



Make choices specific to your application

Simple configuration tables from Weidmüller make it easier for you to choose all the elements you need. The lists are based on the ratio of old to new PLC cards and precisely describe the rack system, the front adapters and the pre-assembled cables. See our Online Selection Tool for Migration

New system: Weidmüller u-remote

Siemens S7-150	Module quantity	Card type	Number of signals	PLC	Power supply	PSU	PSU No.	PSU	PSU No.	PSU	PSU No.
6ES7 311-1CG03-0AB0	1	PSU	1	6ES7 311-1CG03-0AB0	1	6ES7 311-1CG03-0AB0	1	6ES7 311-1CG03-0AB0	1	6ES7 311-1CG03-0AB0	1
6ES7 311-1CG03-0AB0	1	PSU	1	6ES7 311-1CG03-0AB0	1	6ES7 311-1CG03-0AB0	1	6ES7 311-1CG03-0AB0	1	6ES7 311-1CG03-0AB0	1
6ES7 311-1CG03-0AB0	1	PSU	1	6ES7 311-1CG03-0AB0	1	6ES7 311-1CG03-0AB0	1	6ES7 311-1CG03-0AB0	1	6ES7 311-1CG03-0AB0	1
6ES7 311-1CG03-0AB0	1	PSU	1	6ES7 311-1CG03-0AB0	1	6ES7 311-1CG03-0AB0	1	6ES7 311-1CG03-0AB0	1	6ES7 311-1CG03-0AB0	1
6ES7 311-1CG03-0AB0	1	PSU	1	6ES7 311-1CG03-0AB0	1	6ES7 311-1CG03-0AB0	1	6ES7 311-1CG03-0AB0	1	6ES7 311-1CG03-0AB0	1

New system: Siemens S7-1500

Siemens S7-150	Siemens S7-1500	Card type	Number of signals	PLC	Power supply	PSU	PSU No.	PSU	PSU No.	PSU	PSU No.
6ES7 311-1CG03-0AB0	6ES7 311-1CG03-0AB0	PSU	1	6ES7 311-1CG03-0AB0	1	6ES7 311-1CG03-0AB0	1	6ES7 311-1CG03-0AB0	1	6ES7 311-1CG03-0AB0	1
6ES7 311-1CG03-0AB0	6ES7 311-1CG03-0AB0	PSU	1	6ES7 311-1CG03-0AB0	1	6ES7 311-1CG03-0AB0	1	6ES7 311-1CG03-0AB0	1	6ES7 311-1CG03-0AB0	1
6ES7 311-1CG03-0AB0	6ES7 311-1CG03-0AB0	PSU	1	6ES7 311-1CG03-0AB0	1	6ES7 311-1CG03-0AB0	1	6ES7 311-1CG03-0AB0	1	6ES7 311-1CG03-0AB0	1
6ES7 311-1CG03-0AB0	6ES7 311-1CG03-0AB0	PSU	1	6ES7 311-1CG03-0AB0	1	6ES7 311-1CG03-0AB0	1	6ES7 311-1CG03-0AB0	1	6ES7 311-1CG03-0AB0	1
6ES7 311-1CG03-0AB0	6ES7 311-1CG03-0AB0	PSU	1	6ES7 311-1CG03-0AB0	1	6ES7 311-1CG03-0AB0	1	6ES7 311-1CG03-0AB0	1	6ES7 311-1CG03-0AB0	1

Needs-based solution

Our adapters and interfaces are the easiest way of combining old plants with new PLC systems. There are no limits to the potential uses of our retrofitting components.



Selection Table for migration between SIEMENS S5-115 to Weidmüller u-remote/ SIEMENS S7-1500 and S7-300

The following selection tables help you to choose the FAD and pre-assembled cables to migrate from S5-115 to other systems.

1. Select the right table, depending on the new systems you need to migrate
2. Select the combination of "old Card" / "new card" you need to migrate from the corresponding table. For example: 6ES5 420-7LA11 to 1315210000
UR20-16DI-P-PLC-INT
3. Select the order number of the FAD to be ordered:
 - FAD code 1991730000
 - Quantity: 1 unit (by card)
4. Generate the order number of the cable to be ordered:
 - Cable code 1349670xxx
 - Quantity: 2 unit (by card)The last 3 digits indicate the length:
For example 015 indicates 1.5 m

Please always take into account the characteristics of the new PLC card so that it is able to provide enough current to your existing application to act the field elements.

New system: Weidmüller u-remote

Siemens S5-115 Old Card	Weidmüller u-remote New Card	Card type	Number of signals	FAD			CABLES		
				Order No.	Type	Qty.	Order No.	Type	Qty.
6ES5 420-7LA11	1315210000 UR20-16DI-P-PLC-INT (2 uds)	Digital Input	32	1991730000 ^{A)}	FAD S5115 2XHE20 32IO M	1	1349670xxx	PAC-UNIV-HE20-HE20-LLLM	2
6ES5 430-7LA11	1315210000 UR20-16DI-P-PLC-INT (2 uds)	Digital Input	32	1991730000 ^{A)}	FAD S5115 2XHE20 32IO M	1	1349670xxx	PAC-UNIV-HE20-HE20-LLLM	2
6ES5 441-7LA12	1315270000 UR20-16DO-P-PLC-INT (2 uds)	Digital Output	32	1991730000 ^{A)}	FAD S5115 2XHE20 32IO M	1	1349670xxx	PAC-UNIV-HE20-HE20-LLLM	2
6ES5 451-7LA11	1315270000 UR20-16DO-P-PLC-INT (2 uds)	Digital Output	32	1991730000 ^{A)}	FAD S5115 2XHE20 32IO M	1	1349670xxx	PAC-UNIV-HE20-HE20-LLLM	2
6ES5 451-7LA12	1315270000 UR20-16DO-P-PLC-INT (2 uds)	Digital Output	32	1991730000 ^{A)}	FAD S5115 2XHE20 32IO M	1	1349670xxx	PAC-UNIV-HE20-HE20-LLLM	2
6ES5 451-7LA21	1315270000 UR20-16DO-P-PLC-INT (2 uds)	Digital Output	32	1991730000 ^{A)}	FAD S5115 2XHE20 32IO M	1	1349670xxx	PAC-UNIV-HE20-HE20-LLLM	2
6ES5 454-7LA12	1315270000 UR20-16DO-P-PLC-INT	Digital Output	16	1986010000 ^{A)}	FAD S5115 HE20 16IO M	1	1349670xxx	PAC-UNIV-HE20-HE20-LLLM	1

Note: A) FAD designed to work with only one power supply. Please contact us for information on other solution.
B) Cable designed to work with only power supply. Please contact us for information on other solution.
C) A maximum of 9 FAD's can be placed in the migration rack 1993530000. The use of the Weidmüller Migration rail 2003740000 is needed too

New system: Siemens S7-1500

Siemens S5-115 Old Card	Siemens S7-1500 New Card	Card type	Number of signals	FAD			CABLES		
				Order No.	Type	Qty.	Order No.	Type	Qty.
6ES5 420-7LA11	6ES7521-1BL00-0AB0	Digital Input	32	1991730000 ^{A)}	FAD S5115 2XHE20 32IO M	1	1462040xxx	PAC-S1500-HE20-V0-LLLM	1
6ES5 430-7LA12	6ES7521-1BL00-0AB0	Digital Input	32	1991730000 ^{A)}	FAD S5115 2XHE20 32IO M	1	1462040xxx	PAC-S1500-HE20-V0-LLLM	1
6ES5 431-7LA11	6ES7521-1BH00-0AB0 (only 24 V DC)	Digital Input	16	1986010000 ^{A)}	FAD S5115 HE20 16IO M	1	1462090xxx	PAC-S1500-HE20-V1-LLLM	1
6ES5 435-7LA11	6ES7521-1FH00-0AA0	Digital Input	16	1985980000	FAD S5115 SL24 M	1	2004530xxx	PAC-S1500-SL24-AR1-LLLM	1
6ES5 436-7LA11	6ES7521-1FH00-0AA0	Digital Input	16	1985980000	FAD S5115 SL24 M	1	2004530xxx	PAC-S1500-SL24-AR1-LLLM	1
6ES5 441-7LA12	6ES7522-1BL00-0AB0	Digital Output	32	1991730000 ^{A)}	FAD S5115 2XHE20 32IO M	1	1462040xxx	PAC-S1500-HE20-V0-LLLM	1
6ES5 451-7LA11	6ES7522-1BL00-0AB0	Digital Output	32	1991730000 ^{A)}	FAD S5115 2XHE20 32IO M	1	1462040xxx	PAC-S1500-HE20-V0-LLLM	1
6ES5 451-7LA12	6ES7522-1BL00-0AB0	Digital Output	32	1991730000 ^{A)}	FAD S5115 2XHE20 32IO M	1	1462040xxx	PAC-S1500-HE20-V0-LLLM	1
6ES5 451-7LA21	6ES7522-1BL00-0AB0	Digital Output	32	1991730000 ^{A)}	FAD S5115 2XHE20 32IO M	1	1462040xxx	PAC-S1500-HE20-V0-LLLM	1
6ES5 454-7LA12	6ES7522-1BH00-0AB0	Digital Output	16	1986010000 ^{A)}	FAD S5115 HE20 16IO M	1	1462090xxx	PAC-S1500-HE20-V1-LLLM	1
6ES5 458-7LC11	6ES7522-5HF00-0AB0 (2 units)	Digital Output	16	1985980000	FAD S5115 SL24 M	1	2004540xxx ^{B)}	PAC-S1500-SL24-AY0-LLLM	1

Note: A) FAD designed to work with only one power supply. Please contact us for information on other solution.
B) Cable designed to work with only power supply. Please contact us for information on other solution.
C) A maximum of 9 FAD's can be placed in the migration rack 1993530000. The use of the Siemens rail for S7-1500 6ES7590-1AE80-0AA0 is needed too

New system: Siemens S7-300

Siemens S5-115 Old Card	Siemens S7-300 New Card	Card type	Number of signals	FAD			CABLES		
				Order No.	Type	Qty.	Order No.	Type	Qty.
6ES5 420-7LA11	6ES7321-1BL00-0AA0	Digital Input	32	1991730000 ^{A)}	FAD S5115 2XHE20 32IO M	1	7789236xxx	PAC-S300-HE20-V4-LLLM	1
6ES5 430-7LA12	6ES7321-1BL00-0AA0	Digital Input	32	1991730000 ^{A)}	FAD S5115 2XHE20 32IO M	1	7789236xxx	PAC-S300-HE20-V4-LLLM	1
6ES5 435-7LA11	6ES7321-1FH00-0AA0	Digital Input	16	1985980000	FAD S5115 SL24 M	1	2004620xxx	PAC-S300-SL24-AR0-LLLM	1
6ES5 435-7LC11	6ES7321-1FF10-0AA0	Digital Input	8	1985980000	FAD S5115 SL24 M	1	2004630xxx	PAC-S300-SL24-AR1-LLLM	1
6ES5 436-7LA11	6ES7321-1FH00-0AA0	Digital Input	16	1985980000	FAD S5115 SL24 M	1	2004620xxx	PAC-S300-SL24-AR0-LLLM	1
6ES5 436-7LC11	6ES7321-1FF10-0AA0	Digital Input	8	1985980000	FAD S5115 SL24 M	1	2004630xxx	PAC-S300-SL24-AR1-LLLM	1
6ES5 441-7LA12	6ES7322-1BL00-0AA0	Digital Output	32	1991730000 ^{A)}	FAD S5115 2XHE20 32IO M	1	7789236xxx	PAC-S300-HE20-V4-LLLM	1
6ES5 451-7LA11	6ES7322-1BL00-0AA0	Digital Output	32	1991730000 ^{A)}	FAD S5115 2XHE20 32IO M	1	7789236xxx	PAC-S300-HE20-V4-LLLM	1
6ES5 451-7LA12	6ES7322-1BL00-0AA0	Digital Output	32	1991730000 ^{A)}	FAD S5115 2XHE20 32IO M	1	7789236xxx	PAC-S300-HE20-V4-LLLM	1
6ES5 451-7LA21	6ES7322-1BL00-0AA0	Digital Output	32	1991730000 ^{A)}	FAD S5115 2XHE20 32IO M	1	7789236xxx	PAC-S300-HE20-V4-LLLM	1
6ES5 454-7LA12	6ES7322-1BH00-0AA0	Digital Output	16	1986010000 ^{A)}	FAD S5115 HE20 16IO M	1	7789234xxx	PAC-S300-HE20-V3-LLLM	1
6ES5 458-7LB11	6ES7322-1HF10-0AA0	Digital Output	8	1985980000	FAD S5115 SL24 M	1	2004640xxx	PAC-S300-SL24-AY2-LLLM	1
6ES5460-7LA12 (current, voltage and TC)	6ES7331-7KF02-0AB0	Analogue Input	8	2045120000	FAD S5115 SL46 A M	1	2045970xxx	PAC-S300-SL46-AJ0-LLLM	1
6ES5470-7LC12	6ES7332-5HF00-0AB0	Analogue Output	8	2045120000	FAD S5115 SL46 A M	1	2045910xxx	PAC-S300-SL46-AM0-LLLM	1

Note: A) FAD designed to work with only one power supply. Please contact us for information on other solution.
B) Cable designed to work with only power supply. Please contact us for information on other solution.
C) A maximum of 9 FAD's can be placed in the migration rack 1993530000. The use of the Siemens rail for S7-300 6ES7390-1AE80-0AA0 is needed too

Solutions on demand

Our retrofit front-panel adapters and interfaces are the easiest way to connect old PLCs with new PLC systems.

The possible uses of our retrofit components are unlimited. Weidmüller has developed many products for migration systems.

We look forward to provide you with professional advice on the needed conversion for your system. Any customised solution is available on demand.

Selection Table for migration between SIEMENS S5-135 to Weidmüller u-remote/ SIEMENS S7-1500 and S7-300

The following selection tables help you to choose the FAD and pre-assembled cables to migrate from S5-135 to other systems.

1. Select the right table, depending on the new systems you need to migrate
2. Select the combination of "old Card" / "new card" you need to migrate from the corresponding table. For example: 6ES5 420-4UA13 to 1315210000 UR20-16DI-P-PLC-INT
3. Select the order number of the FAD to be ordered:
 - FAD code 1986050000
 - Quantity: 1 unit (by card)
4. Generate the order number of the cable to be ordered:
 - Cable code 1349670xxx
 - Quantity: 2 unit (by card)The last 3 digits indicate the length:
For example 015 indicates 1.5 m

Please always take into account the characteristics of the new PLC card so that it is able to provide enough current to your existing application to act the field elements.

New system: Weidmüller u-remote

Siemens S5-135 Old Card	Weidmüller u-remote New Card	Card type	Number of signals	FAD			CABLES		
				Order No.	Type	Qty.	Order No.	Type	Qty.
6ES5 420-4UA13	1315210000 UR20-16DI-P-PLC-INT (2 uds)	Digital Input	32	1986050000 ^{A)}	FAD S5135 2XHE20 32IO R	1	1349670xxx	PAC-UNIV-HE20-HE20-LLLM	2
6ES5 420-4UA14	1315210000 UR20-16DI-P-PLC-INT (2 uds)	Digital Input	32	1986050000 ^{A)}	FAD S5135 2XHE20 32IO R	1	1349670xxx	PAC-UNIV-HE20-HE20-LLLM	2
6ES5 430-4UA13	1315210000 UR20-16DI-P-PLC-INT (2 uds)	Digital Input	32	1986050000 ^{A)}	FAD S5135 2XHE20 32IO R	1	1349670xxx	PAC-UNIV-HE20-HE20-LLLM	2
6ES5 430-4UA14	1315210000 UR20-16DI-P-PLC-INT (2 uds)	Digital Input	32	1986050000 ^{A)}	FAD S5135 2XHE20 32IO R	1	1349670xxx	PAC-UNIV-HE20-HE20-LLLM	2
6ES5 432-4UA12	1315210000 UR20-16DI-P-PLC-INT (2 uds)	Digital Input	32	1986050000 ^{A)}	FAD S5135 2XHE20 32IO R	1	1349670xxx	PAC-UNIV-HE20-HE20-LLLM	2
6ES5 441-4UA13	1315270000 UR20-16DO-P-PLC-INT (2 uds)	Digital Output	32	1986050000 ^{A)}	FAD S5135 2XHE20 32IO R	1	1349670xxx	PAC-UNIV-HE20-HE20-LLLM	2
6ES5 441-4UA14	1315270000 UR20-16DO-P-PLC-INT (2 uds)	Digital Output	32	1986050000 ^{A)}	FAD S5135 2XHE20 32IO R	1	1349670xxx	PAC-UNIV-HE20-HE20-LLLM	2
6ES5 451-4UA13	1315270000 UR20-16DO-P-PLC-INT (2 uds)	Digital Output	32	1986050000 ^{A)}	FAD S5135 2XHE20 32IO R	1	1349670xxx	PAC-UNIV-HE20-HE20-LLLM	2
6ES5 451-4UA14	1315270000 UR20-16DO-P-PLC-INT (2 uds)	Digital Output	32	1986050000 ^{A)}	FAD S5135 2XHE20 32IO R	1	1349670xxx	PAC-UNIV-HE20-HE20-LLLM	2

Note: A) FAD designed to work with only one power supply. Please contact us for information on other solution.
 B) Cable designed to work with only power supply. Please contact us for information on other solution.
 C) A maximum of 20 FAD's can be placed in the migration rack 1993500000. The use of the Weidmüller Migration rail 2003740000 is needed too

New system: Siemens S7-1500

Siemens S5-135 Old Card	Siemens S7-1500 New Card	Card type	Number of signals	FAD			CABLES		
				Order No.	Type	Qty.	Order No.	Type	Qty.
6ES5 420-4UA13	6ES7521-1BL00-0AB0	Digital Input	32	1986050000 ^{A)}	FAD S5135 2XHE20 32IO R	1	1462040xxx	PAC-S1500-HE20-V0-LLLM	1
6ES5 420-4UA14	6ES7521-1BL00-0AB0	Digital Input	32	1986050000 ^{A)}	FAD S5135 2XHE20 32IO R	1	1462040xxx	PAC-S1500-HE20-V0-LLLM	1
6ES5 430-4UA13	6ES7521-1BL00-0AB0	Digital Input	32	1986050000 ^{A)}	FAD S5135 2XHE20 32IO R	1	1462040xxx	PAC-S1500-HE20-V0-LLLM	1
6ES5 430-4UA14	6ES7521-1BL00-0AB0	Digital Input	32	1986050000 ^{A)}	FAD S5135 2XHE20 32IO R	1	1462040xxx	PAC-S1500-HE20-V0-LLLM	1
6ES5 432-4UA12	6ES7521-1BL00-0AB0	Digital Input	32	1986050000 ^{A)}	FAD S5135 2XHE20 32IO R	1	1462040xxx	PAC-S1500-HE20-V0-LLLM	1
6ES5 436-4UA12	6ES7521-1FH00-0AA0	Digital Input	16	1986030000	FAD S5135 SL20 R	1	2004590xxx	PAC-S1500-SL20-ARO-LLLM	1
6ES5 441-4UA13	6ES7522-1BL00-0AB0	Digital Output	32	1986050000 ^{A)}	FAD S5135 2XHE20 32IO R	1	1462040xxx	PAC-S1500-HE20-V0-LLLM	1
6ES5 441-4UA14	6ES7522-1BL00-0AB0	Digital Output	32	1986050000 ^{A)}	FAD S5135 2XHE20 32IO R	1	1462040xxx	PAC-S1500-HE20-V0-LLLM	1
6ES5 451-4UA13	6ES7522-1BL00-0AB0	Digital Output	32	1986050000 ^{A)}	FAD S5135 2XHE20 32IO R	1	1462040xxx	PAC-S1500-HE20-V0-LLLM	1
6ES5 451-4UA14	6ES7522-1BL00-0AB0	Digital Output	32	1986050000 ^{A)}	FAD S5135 2XHE20 32IO R	1	1462040xxx	PAC-S1500-HE20-V0-LLLM	1
6ES5 456-4UB12	6ES7522-5FF00-0AB0	Digital Output	8	1986030000	FAD S5135 SL20 R	1	2004600xxx	PAC-S1500-SL20-AYO-LLLM	1

Note: A) FAD designed to work with only one power supply. Please contact us for information on other solution.
 B) Cable designed to work with only power supply. Please contact us for information on other solution.
 C) A maximum of 20 FAD's can be placed in the migration rack 1993500000. The use of the Siemens rail for S7-1500 6ES7590-1AE80-0AA0 is needed too

New system: Siemens S7-300

Siemens S5-135 Old Card	Siemens S7-300 New Card	Card type	Number of signals	FAD			CABLES		
				Order No.	Type	Qty.	Order No.	Type	Qty.
6ES5 420-4UA13	6ES7321-1BL00-0AA0	Digital Input	32	1986050000 ^{A)}	FAD S5135 2XHE20 32IO R	1	7789236xxx	PAC-S300-HE20-V4-LLLM	1
6ES5 420-4UA14	6ES7321-1BL00-0AA0	Digital Input	32	1986050000 ^{A)}	FAD S5135 2XHE20 32IO R	1	7789236xxx	PAC-S300-HE20-V4-LLLM	1
6ES5 430-4UA13	6ES7321-1BL00-0AA0	Digital Input	32	1986050000 ^{A)}	FAD S5135 2XHE20 32IO R	1	7789236xxx	PAC-S300-HE20-V4-LLLM	1
6ES5 430-4UA14	6ES7321-1BL00-0AA0	Digital Input	32	1986050000 ^{A)}	FAD S5135 2XHE20 32IO R	1	7789236xxx	PAC-S300-HE20-V4-LLLM	1
6ES5 432-4UA12	6ES7321-1BL00-0AA0	Digital Input	32	1986050000 ^{A)}	FAD S5135 2XHE20 32IO R	1	1349670xxx	PAC-UNIV-HE20-HE20-LLLM	1
6ES5 436-4UA12	6ES7321-1FH00-0AA0	Digital Input	16	1986030000	FAD S5135 SL20 R	1	2004880xxx	PAC-S300-SL20-ARO-LLLM	1
6ES5 436-4UB12	6ES7321-1FF10-0AA0	Digital Input	8	1986030000	FAD S5135 SL20 R	1	2004870xxx	PAC-S300-SL20-AR1-LLLM	1
6ES5 441-4UA13	6ES7322-1BL00-0AA0	Digital Output	32	1986050000 ^{A)}	FAD S5135 2XHE20 32IO R	1	1349670xxx	PAC-UNIV-HE20-HE20-LLLM	1
6ES5 441-4UA14	6ES7322-1BL00-0AA0	Digital Output	32	1986050000 ^{A)}	FAD S5135 2XHE20 32IO R	1	1349670xxx	PAC-UNIV-HE20-HE20-LLLM	1
6ES5 451-4UA13	6ES7322-1BL00-0AA0	Digital Output	32	1986050000 ^{A)}	FAD S5135 2XHE20 32IO R	1	7789236xxx	PAC-S300-HE20-V4-LLLM	1
6ES5 451-4UA14	6ES7322-1BL00-0AA0	Digital Output	32	1986050000 ^{A)}	FAD S5135 2XHE20 32IO R	1	7789236xxx	PAC-S300-HE20-V4-LLLM	1
6ES5 454-4UA13	6ES7322-1BH00-0AA0	Digital Output	16	1986040000 ^{A)}	FAD S5135 HE20 16IO R	1	7789234xxx	PAC-S300-HE20-V3-LLLM	1
6ES5 454-4UA14	6ES7322-1BH00-0AA0	Digital Output	16	1986040000 ^{A)}	FAD S5135 HE20 16IO R	1	7789234xxx	PAC-S300-HE20-V3-LLLM	1
6ES5 456-4UA12	6ES7322-1HH01-0AA0	Digital Output	16	1986030000	FAD S5135 SL20 R	1	2004860xxx	PAC-S300-SL20-AYO-LLLM	1
6ES5 456-4UB12	6ES7322-1HF10-0AA0	Digital Output	8	1986030000	FAD S5135 SL20 R	1	2004850xxx	PAC-S300-SL20-AY1-LLLM	1

Note: A) FAD designed to work with only one power supply. Please contact us for information on other solution.
 B) Cable designed to work with only power supply. Please contact us for information on other solution.
 C) A maximum of 20 FAD's can be placed in the migration rack 1993500000. The use of the Siemens rail for S7-300 6ES7390-1AE80-0AA0 is needed too

Solutions on demand

Our retrofit front-panel adapters and interfaces are the easiest way to connect old PLCs with new PLC systems.

The possible uses of our retrofit components are unlimited. Weidmüller has developed many products for migration systems.

We look forward to provide you with professional advice on the needed conversion for your system. Any customised solution is available on demand.

Selection Table for migration between Schneider TSX 7 to Weidmüller u-remote/ SIEMENS S7-1500 and S7-300

The following selection tables help you to choose the FAD and pre-assembled cables to migrate from TSX 7 to other systems.

1. Select the right table, depending on the new systems you need to migrate
2. Select the combination of "old Card" / "new card" you need to migrate from the corresponding table. For example: TSX DET 16 12 to 1315210000
UR20-16DI-P-PLC-INT
3. Select the order number of the FAD to be ordered:
 - FAD code 1985940000
 - Quantity: 1 unit (by card)
4. Generate the order number of the cable to be ordered:
 - Cable code 1349670xxx
 - Quantity: 1 unit (by card)The last 3 digits indicate the length:
For example 015 indicates 1.5 m

Please always take into account the characteristics of the new PLC card so that it is able to provide enough current to your existing application to act the field elements.

New system: Weidmüller u-remote

Schneider TSX7 Old Card	Weidmüller u-remote New Card	Card type	Number of signals	FAD			CABLES		
				Order No.	Type	Qty.	Order No.	Type	Qty.
TSX DET 16 12	1315210000 UR20-16DI-P-PLC-INT	Digital Input	16	1985940000 ^{A)}	FAD BLK 1 HE20 16I M	1	1349670xxx	PAC-UNIV-HE20-HE20-LLLM	1
TSX DET 32 52	1315210000 UR20-16DI-P-PLC-INT (2 uds)	Digital Input	32	1985960000	FAD BLK 7 2XHE20 M	1	1349670xxx	PAC-UNIV-HE20-HE20-LLLM	2
TSX DET 32 42	1315210000 UR20-16DI-P-PLC-INT (2 uds)	Digital Input	32	1985960000	FAD BLK 7 2XHE20 M	1	1349670xxx	PAC-UNIV-HE20-HE20-LLLM	2
TSX DET 32 32	1315210000 UR20-16DI-P-PLC-INT (2 uds)	Digital Input	32	1985960000	FAD BLK 7 2XHE20 M	1	1349670xxx	PAC-UNIV-HE20-HE20-LLLM	2
TSX DST 16 82	1315270000 UR20-16DO-P-PLC-INT	Digital Output	16	1985950000	FAD BLK 1 HE20 16O M	1	1349670xxx	PAC-UNIV-HE20-HE20-LLLM	1
TSX DST 32 92	1315270000 UR20-16DO-P-PLC-INT (2 uds)	Digital Output	32	1985970000	FAD BLK 9 2XHE20 M	1	1349670xxx	PAC-UNIV-HE20-HE20-LLLM	2
TSX DST 16 32	1315270000 UR20-16DO-P-PLC-INT	Digital Output	16	1985950000 ^{A)}	FAD BLK 1 HE20 16O M	1	1349670xxx	PAC-UNIV-HE20-HE20-LLLM	1

Note: A) FAD designed to work with only one power supply. Please contact us for information on other solution.
 B) Cable designed to work with only power supply. Please contact us for information on other solution.
 C) A maximum of 8 FAD's can be placed in the migration rack 1993520000. The use of the Weidmüller Migration rail 2003740000 is needed too

New system: Siemens S7-1500

Schneider TSX7 Old Card	Siemens S7-1500 New Card	Card type	Number of signals	FAD			CABLES		
				Order No.	Type	Qty.	Order No.	Type	Qty.
TSX DET 16 12	6ES7521-1BH00-0AA0	Digital Input	16	1985940000 ^{A)}	FAD BLK 1 HE20 16I M	1	1462090xxx	PAC-S1500-HE20-V1-LLLM	1
TSX DET 16 04	6ES7521-1FH00-0AA0	Digital Input	16	1985930000	FAD BLK 1 SL24 M	1	2004610xxx	PAC-S1500-SL24-ARO-LLLM	1
TSX DET 32 52	6ES7521-1BL00-0AB0	Digital Input	32	1985960000	FAD BLK 7 2XHE20 M	1	1462040xxx	PAC-S1500-HE20-V0-LLLM	1
TSX DET 32 42	6ES7521-1BL00-0AB0	Digital Input	32	1985960000	FAD BLK 7 2XHE20 M	1	1462040xxx	PAC-S1500-HE20-V0-LLLM	1
TSX DET 32 32	6ES7521-1BL00-0AB0	Digital Input	32	1985960000	FAD BLK 7 2XHE20 M	1	1462040xxx	PAC-S1500-HE20-V0-LLLM	1
TSX DST 32 92	6ES7522-1BL00-0AB0	Digital Output	32	1985970000	FAD BLK 9 2XHE20 M	1	1462040xxx	PAC-S1500-HE20-V0-LLLM	1
TSX DST 16 32	6ES7522-1BH00-0AB0	Digital Output	16	1985950000	FAD BLK 1 HE20 16O M	1	1462090xxx	PAC-S1500-HE20-V1-LLLM	1

Note: A) FAD designed to work with only one power supply. Please contact us for information on other solution.
 B) Cable designed to work with only power supply. Please contact us for information on other solution.
 C) A maximum of 8 FAD's can be placed in the migration rack 1993520000. The use of the Siemens rail for S7-1500 6ES7590-1AE80-0AA0 is needed too

New system: Siemens S7-300

Schneider TSX7 Old Card	Siemens S7-300 New Card	Card type	Number of signals	FAD			CABLES		
				Order No.	Type	Qty.	Order No.	Type	Qty.
TSX DET 16 12	6ES7321-1BH00-0AA0	Digital Input	16	1985940000 ^{A)}	FAD BLK 1 HE20 16I M	1	7789234xxx	PAC-S300-HE20-V3-LLLM	1
TSX DET 16 12	6ES7321-1BH01-0AA0	Digital Input	16	1985940000 ^{A)}	FAD BLK 1 HE20 16I M	1	7789234xxx	PAC-S300-HE20-V3-LLLM	1
TSX DET 16 12	6ES7321-1BH02-0AA0	Digital Input	16	1985940000 ^{A)}	FAD BLK 1 HE20 16I M	1	7789234xxx	PAC-S300-HE20-V3-LLLM	1
TSX DET 16 04	6ES7 321-1FH00-0AA0	Digital Input	16	1985930000	FAD BLK 1 SL24 M	1	2004650xxx	PAC-S300-SL24-AR2-LLLM	1
TSX DET 8 05	6ES7 321-1FF10-0AA0	Digital Input	8	1985930000	FAD BLK 1 SL24 M	1	2004660xxx	PAC-S300-SL24-AR3-LLLM	1
TSX DET 32 52	6ES7 321-1BL00-0AA0	Digital Input	32	1985960000	FAD BLK 7 2XHE20 M	1	7789236xxx	PAC-S300-HE20-V4-LLLM	1
TSX DET 32 52	6ES7 321-1BL80-0AA0	Digital Input	32	1985960000	FAD BLK 7 2XHE20 M	1	7789236xxx	PAC-S300-HE20-V4-LLLM	1
TSX DET 32 42	6ES7 321-1BL00-0AA0	Digital Input	32	1985960000	FAD BLK 7 2XHE20 M	1	7789236xxx	PAC-S300-HE20-V4-LLLM	1
TSX DET 32 42	6ES7 321-1BL80-0AA0	Digital Input	32	1985960000	FAD BLK 7 2XHE20 M	1	7789236xxx	PAC-S300-HE20-V4-LLLM	1
TSX DET 32 32	6ES7 321-1BL00-0AA0	Digital Input	32	1985960000	FAD BLK 7 2XHE20 M	1	7789236xxx	PAC-S300-HE20-V4-LLLM	1
TSX DET 32 32	6ES7 321-1BL80-0AA0	Digital Input	32	1985960000	FAD BLK 7 2XHE20 M	1	7789236xxx	PAC-S300-HE20-V4-LLLM	1
TSX DST 16 82	6ES7322-1BL00-0AA0	Digital Output	16	1985950000	FAD BLK 1 HE20 16O M	1	7789234xxx	PAC-S300-HE20-V3-LLLM	1
TSX DST 32 92	6ES7322-1BH00-0AA0	Digital Output	32	1985970000	FAD BLK 9 2XHE20 M	1	7789236xxx	PAC-S300-HE20-V4-LLLM	1
TSX DST 16 32	6ES7322-1BL00-0AA0	Digital Output	16	1985950000	FAD BLK 1 HE20 16O M	1	7789234xxx	PAC-S300-HE20-V3-LLLM	1

Note: A) FAD designed to work with only one power supply. Please contact us for information on other solution.
 B) Cable designed to work with only power supply. Please contact us for information on other solution.
 C) A maximum of 8 FAD's can be placed in the migration rack 1993520000. The use of the Siemens rail for S7-300 6ES7390-1AE80-0AA0 is needed too

Solutions on demand

Our retrofit front-panel adapters and interfaces are the easiest way to connect old PLCs with new PLC systems.

The possible uses of our retrofit components are unlimited. Weidmüller has developed many products for migration systems.

We look forward to provide you with professional advice on the needed conversion for your system. Any customised solution is available on demand.

Selection Table for migration between Siemens S5-115/S5-135 Schneider TSX/Premium /Rockwell PLC-5 to Ferrules

The following selection tables help you to choose the pre-assembled cables to migrate from Siemens S5-115/S5-135 / Schneider TSX /Premium / Rockwell PLC 5 to other PLC platforms through cables with ferrules

	Front-adaptor FAD		Pre-assembled cables			
	Order No.	Type	Order No.	Type	Type of cable	Number of cables /FAD
SIEMENS S5-115	1986010000	FAD S5115 HE20 16IO M	1349790XXX	PAC-UNIV-HE20-F-XXXX	unshielded cable 0.14 mm ²	1
SIEMENS S5-115	1991730000	FAD S5115 2XHE20 32IO M	1349790XXX	PAC-UNIV-HE20-F-XXXX	unshielded cable 0.14 mm ²	2
SIEMENS S5-115	1985980000	FAD S5115 SL24 M	2789780XXX	PAC-BL24-F-M50-XXXX	shielded cable 0.5 mm ²	1
SIEMENS S5-115	2045120000	FAD S5115 SL46 A M	2789800XXX	PAC-BL46-F-M50-XXXX	shielded cable 0.5 mm ²	1
SIEMENS S5-135	1986040000	FAD S5135 HE20 16IO R	1349790XXX	PAC-UNIV-HE20-F-XXXX	unshielded cable 0.14 mm ²	1
SIEMENS S5-135	1986050000	FAD S5135 2XHE20 32IO R	1349790XXX	PAC-UNIV-HE20-F-XXXX	unshielded cable 0.14 mm ²	2
SIEMENS S5-135	1986030000	FAD S5135 SL20 R	2789770XXX	PAC-BL20-F-M50-XXXX	shielded cable 0.5 mm ²	1
SIEMENS S5-135	2435110000	FAD S5135 SL42 A R	2789790XXX	PAC-BL42-F-M50-XXXX	shielded cable 0.5 mm ²	1
SCHNEIDER TSX7	1985940000	FAD BLK1 HE20 16I M	1349790XXX	PAC-UNIV-HE20-F-XXXX	unshielded cable 0.14 mm ²	1
SCHNEIDER TSX7	1985950000	FAD BLK1 HE20 16O M	1349790XXX	PAC-UNIV-HE20-F-XXXX	unshielded cable 0.14 mm ²	1
SCHNEIDER TSX7	1985930000	FAD BLK1 SL24 M	2789780XXX	PAC-BL24-F-M50-XXXX	shielded cable 0.5 mm ²	1
SCHNEIDER TSX7	1985960000	FAD BLK7 2XHE20 M	1349790XXX	PAC-UNIV-HE20-F-XXXX	unshielded cable 0.14 mm ²	2
SCHNEIDER TSX7	1985970000	FAD BLK9 2XHE20 M	1349790XXX	PAC-UNIV-HE20-F-XXXX	unshielded cable 0.14 mm ²	2
SCHNEIDER TSX7	2494590000	FAD BLK4 2XSL20	2830380XXX	PAC-2BLZF20-F-C50-V1-XXXX	shielded cable 0.5 mm ²	1
SCHNEIDER PREMIUM	8000070313	FAD PREM BLY01	2830390XXX	PAC-2B2CF10-F-XXXX	shielded cable 0.5 mm ²	1
SCHNEIDER PREMIUM	8000070314	FAD PREM 4HE20	2865890XXX	PAC-B2CF20-F-XXXX	unshielded cable 0.14 mm ²	4
SCHNEIDER PREMIUM	8000070315	FAD PREM 2SD25F	2865900XXX	PAC-B2CF26-F-XXXX	shielded cable 0.5 mm ²	2
ROCKWELL PLC-5	2448650000	FAD 1771-WA/WC BL10 M	2679940XXX	PAC-BLZF10-F-C50-XXXX	single cable 0.5 mm ²	1
ROCKWELL PLC-5	2448680000	FAD 1771-WB/WD BL12 M	2679960XXX	PAC-BLZF12-F-C50-XXXX	single cable 0.5 mm ²	1
ROCKWELL PLC-5	2448660000	FAD 1771-WH BL21 M	2679980XXX	PAC-2BLZF11-F-C50-XXXX	single cable 0.5 mm ²	1
ROCKWELL PLC-5	2563110000	FAD 1771-WG BL21 M	2820530XXX	PAC-2BLZF11-F-C50-V1-XXXX	single cable 0.5 mm ²	1
ROCKWELL PLC-5	2448690000	FAD 1771-WF BL18 M	2679970XXX	PAC-BLZF18-F-C50-XXXX	single cable 0.5 mm ²	1
ROCKWELL PLC-5	2448670000	FAD 1771-WN 2BL20 M	2679950XXX	PAC-2BLZF20-F-C50-XXXX	single cable 0.5 mm ²	1

FAD – front adapters for migrations from Siemens S5-115

The FAD S5-115 front adapters with pre-assembled cables provide safe migration from the old S5-115 to other PLC systems or to the u-remote system from Weidmüller.

- Clip-in foot for TS35
- S5-115 card is powered by a single power supply

FAD S5115 HE20 16IO M

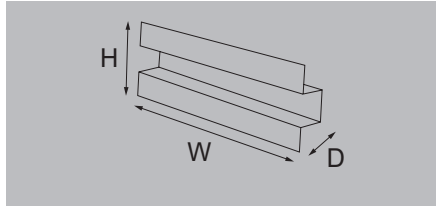

Technical data

Connection data	
Connection (field side)	Plug-in connectors according to IEC 60603-13 / DIN 41651 20p
Rated data	
Operating voltage	30 V AC / 60 V DC
Max. current per channel	1 A
Max. current per byte	2 A
Total operating current	3 A
General data	
Ambient temperature (operational)	-25...50 °C
Storage temperature	-40...60 °C
Approvals	CE, EAC
Insulation coordination (EN50178)	
Rated insulation voltage	< 50 V AC
Surge voltage category	III
Pollution severity level	2
Insulation test voltage	0.35 kVAC

Dimensions		
Width / Height / Depth	46 mm / 280 mm / 36 mm	
Note		
Ordering data		
Type	Qty.	Order No.
FAD S5115 HE20 16IO M	1	1986010000
Note		
Accessories		
Note		

Dimensions
Width / Height / Depth

46 mm / 280 mm / 36 mm

Note

Ordering data

Type	Qty.	Order No.
FAD S5115 HE20 16IO M	1	1986010000

Note

Accessories

Note

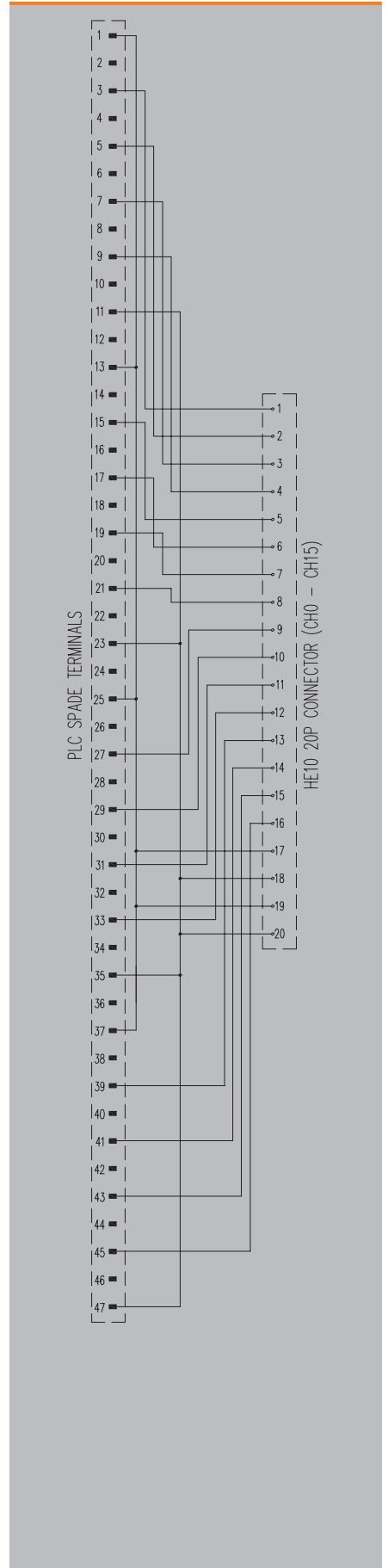

FAD – front adapters for migrations from Siemens S5-115

The FAD S5-115 front adapters with pre-assembled cables provide safe migration from the old S5-115 to other PLC systems or to the u-remote system from Weidmüller.

- Clip-in foot for TS35
- S5-115 card is powered by a single power supply

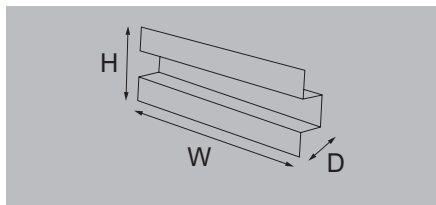

FAD S5115 2XHE20 32IO M



Technical data

Connection data	
Connection (field side)	
Rated data	
Operating voltage	
Max. current per channel	
Max. current per byte	
Total operating current	
General data	
Ambient temperature (operational)	
Storage temperature	
Approvals	
Insulation coordination (EN50178)	
Rated insulation voltage	
Surge voltage category	
Pollution severity level	
Insulation test voltage	

	2 x Connector according IEC60603-13/DIN41651 20 p
	30 V AC / 60 V DC
	1 A
	2 A
	6 A
	-25...50 °C
	-40...60 °C
	CE, EAC
	< 50 V AC
	III
	2
	0.35 kVAC

Dimensions	
Width / Height / Depth	

	46 mm / 280 mm / 36 mm
--	------------------------

Note	
-------------	--

Ordering data

--	--

Type	Qty.	Order No.
FAD S5115 2XHE20 32IO M	1	1991730000

Note	
-------------	--

Accessories

Note	
-------------	--

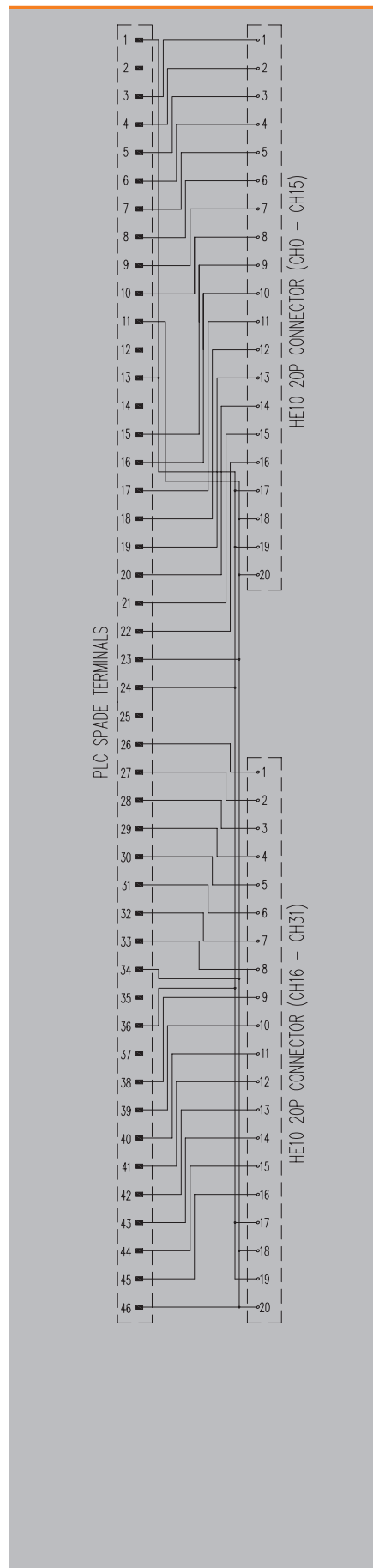

FAD – front adapters for migrations from Siemens S5-115 – Bridge System

FAD – front adapters for migrations from Siemens S5-115

The FAD S5-115 front adapters with pre-assembled cables provide safe migration from the old S5-115 to other PLC systems or to the u-remote system from Weidmüller.

- Clip-in foot for TS35
- S5-115 card is powered by a single power supply

FAD S5115 SL24 M

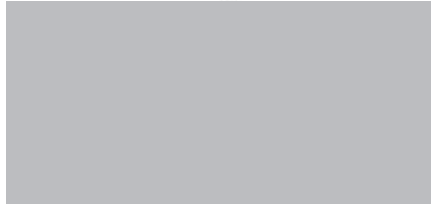
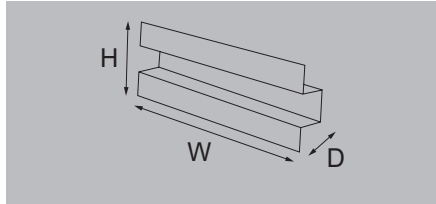

Technical data

Connection data	
Connection (field side)	SL 5.08 mm
Rated data	
Operating voltage	250 V AC
Max. current per channel	6 A
Max. current per byte	
Total operating current	32 A
General data	
Ambient temperature (operational)	-25...50 °C
Storage temperature	-40...60 °C
Approvals	CE; EAC
Insulation coordination (EN50178)	
Rated insulation voltage	< 250 V AC
Surge voltage category	II
Pollution severity level	2
Insulation test voltage	1.2 kVAC

Dimensions	
Width / Height / Depth	46 mm / 280 mm / 25 mm

Note	

Ordering data

Type	Qty.	Order No.
FAD S5115 SL24 M	1	1985980000

Note	

Accessories

Note	
	1610590000 - BLC 5.08/12/180R OR BX (2 units)

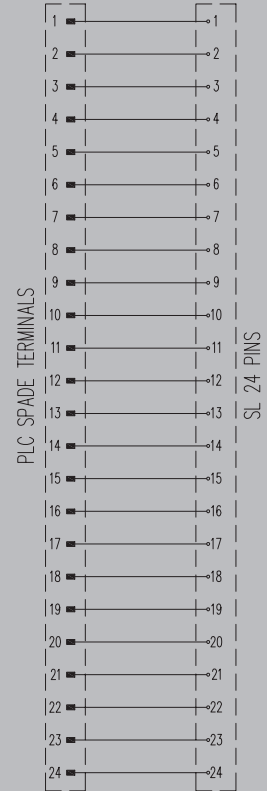

FAD – front adapters for migrations from Siemens S5-115

The FAD S5-115 front adapters with pre-assembled cables provide safe migration from the old S5-115 to other PLC systems or to the u-remote system from Weidmüller.

- Clip-in foot for TS35
- S5-115 card is powered by a single power supply

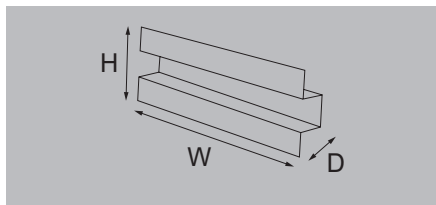

FAD S5115 SL46 A M

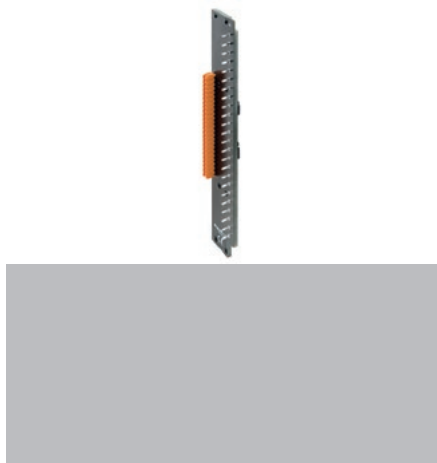

Technical data

Connection data	
Connection (field side)	SL 5.08 mm
Rated data	
Operating voltage	250 V AC
Max. current per channel	6 A
Max. current per byte	
Total operating current	32 A
General data	
Ambient temperature (operational)	-25...50 °C
Storage temperature	-40...60 °C
Approvals	CE, EAC
Insulation coordination (EN50178)	
Rated insulation voltage	< 250 V AC
Surge voltage category	II
Pollution severity level	2
Insulation test voltage	1.2 kVAC

Dimensions	
Width / Height / Depth	46 mm / 280 mm / 25 mm

Dimensions

Width / Height / Depth

Note	
-------------	--

Note

Ordering data

Type	Qty.	Order No.
FAD S5115 SL46 A M	1	2045120000

Note

Accessories

Note	1610630000 - BLC 5.08/16/180R OR BX (2 units)+1610610000 - CON. BLC 5.08/14/180R OR BX
-------------	--

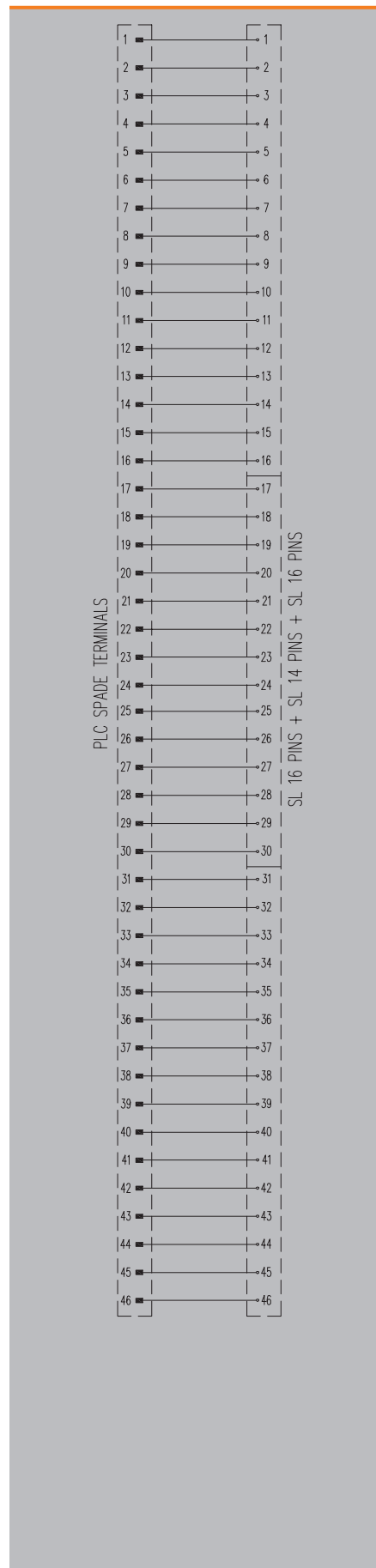

FAD – front adapters for migrations from Siemens S5-135 – Bridge System

FAD – front adapters for migrations from Siemens S5-135

The FAD S5-135 front adapters with pre-assembled cables provide safe migration from the old S5-135 to other PLC systems or to the u-remote system from Weidmüller.

- S5-135 card is powered by a single power supply

FAD S5135 HE20 16IO M

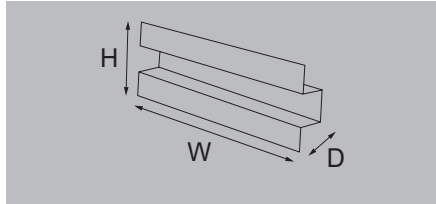

Technical data

Connection data

Connection (field side)

Rated data

Operating voltage
 Max. current per channel
 Max. current per byte
 Total operating current

General data

Ambient temperature (operational)
 Storage temperature
 Approvals

Insulation coordination (EN50178)

Rated insulation voltage
 Surge voltage category
 Pollution severity level
 Insulation test voltage

Plug-in connectors according to IEC 60603-13 / DIN 41651 20p

30 V AC / 60 V DC

1 A

2 A

3 A

-25...50 °C

-40...60 °C

CE; EAC

< 50 V AC

III

2

0.35 kVAC

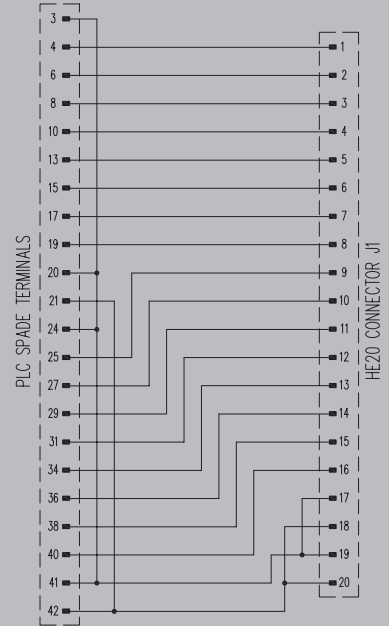

PINS 1-2-5-7-9-11-12-14-16-18-22-23-26-28-30-32-33-35-37-39 ON PLC SIDE ARE NOT CONNECTED

Dimensions

Width / Height / Depth

20 mm / 283 mm / 30 mm

Note

Ordering data

Type	Qty.	Order No.
FAD S5135 HE20 16IO R	1	1986040000

Note

Accessories

Note

FAD – front adapters for migrations from Siemens S5-135

The FAD S5-135 front adapters with pre-assembled cables provide safe migration from the old S5-135 to other PLC systems or to the u-remote system from Weidmüller.

- S5-135 card is powered by a single power supply

FAD S5135 2XHE20 32IO M

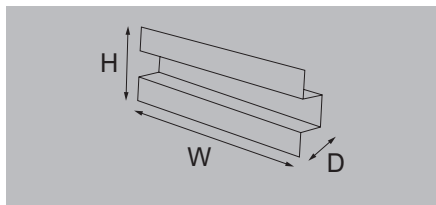

Technical data

Connection data	
Connection (field side)	
Rated data	
Operating voltage	
Max. current per channel	
Max. current per byte	
Total operating current	
General data	
Ambient temperature (operational)	
Storage temperature	
Approvals	
Insulation coordination (EN50178)	
Rated insulation voltage	
Surge voltage category	
Pollution severity level	
Insulation test voltage	

2 x Connector according IEC60603-13/DIN41651 20 p	
30 V AC / 60 V DC	
1 A	
2 A	
6 A	
-25...50 °C	
-40...60 °C	
CE; EAC	
< 50 V AC	
III	
2	
0.35 kVAC	

Dimensions	
Width / Height / Depth	

20 mm / 283 mm / 36 mm

Note

Ordering data

--

Type	Qty.	Order No.
FAD S5135 2XHE20 32IO R	1	1986050000

Note

Accessories

Note

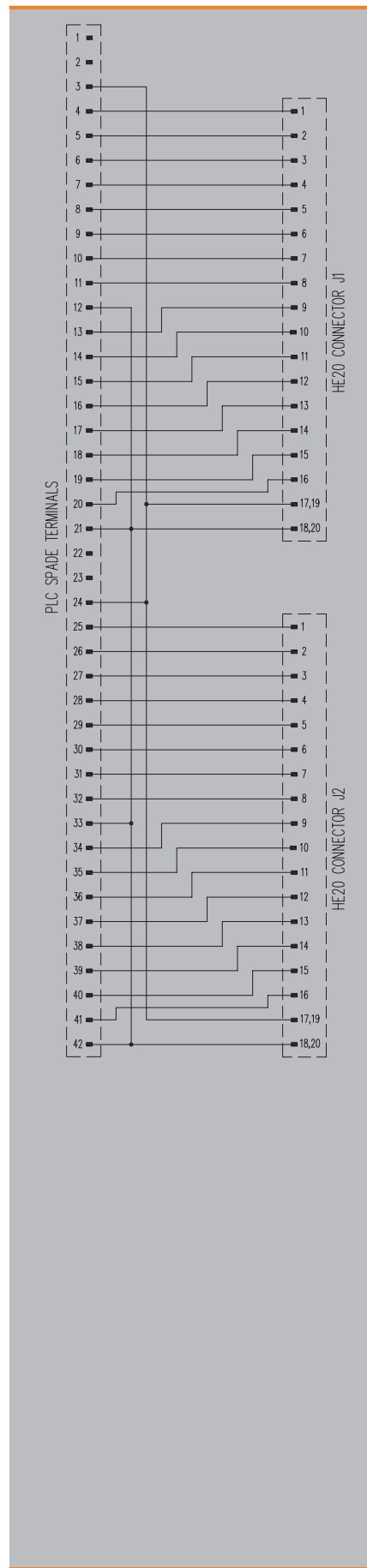

FAD – front adapters for migrations from Siemens S5-135 – Bridge System

FAD – front adapters for migrations from Siemens S5-135

The FAD S5-135 front adapters with pre-assembled cables provide safe migration from the old S5-135 to other PLC systems or to the u-remote system from Weidmüller.

- S5-135 card is powered by a single power supply

FAD S5135 SL20 M

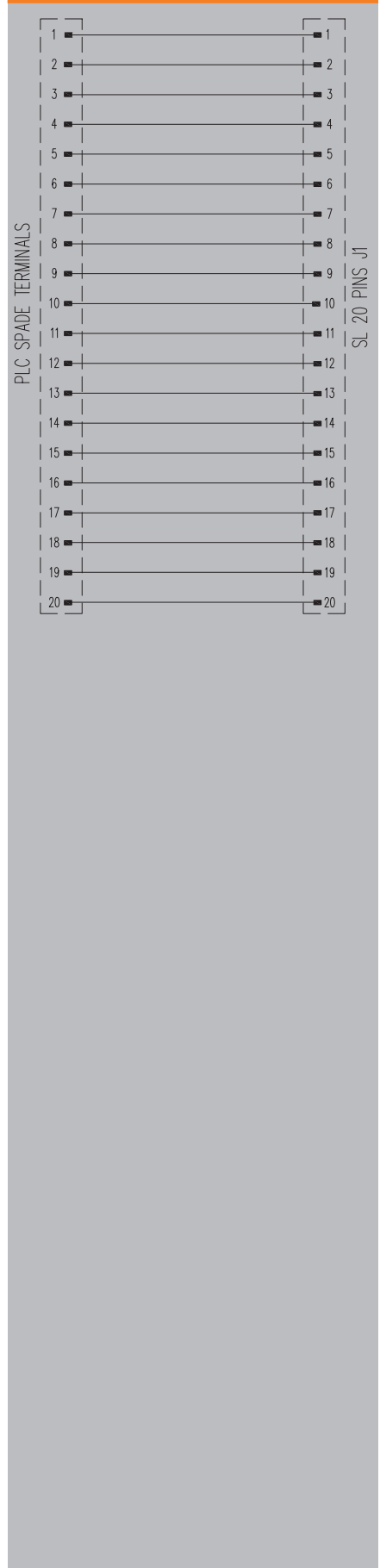
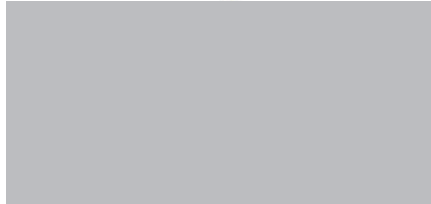
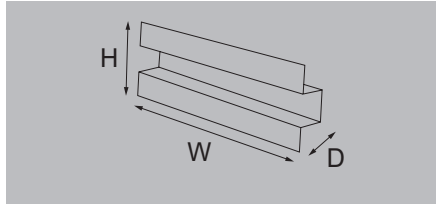

Technical data

Connection data	
Connection (field side)	SL 5.08 mm
Rated data	
Operating voltage	250 V AC
Max. current per channel	6 A
Max. current per byte	
Total operating current	32 A
General data	
Ambient temperature (operational)	-25...50 °C
Storage temperature	-40...60 °C
Approvals	CE
Insulation coordination (EN50178)	
Rated insulation voltage	< 250 V AC
Surge voltage category	II
Pollution severity level	2
Insulation test voltage	1.2 kVAC

Dimensions	
Width / Height / Depth	20 mm / 283 mm / 23 mm

Note	
-------------	--

Ordering data

Type	Qty.	Order No.
FAD S5135 SL20 R	1	1986030000

Note	
-------------	--

Accessories

Note	1610570000 - BLC 5.08/10/180R OR BX (2 units)
-------------	---

FAD – front adapters for migrations from Siemens S5-135

The FAD S5-135 front adapters with pre-assembled cables provide safe migration from the old S5-135 to other PLC systems or to the u-remote system from Weidmüller.

- S5-135 card is powered by a single power supply

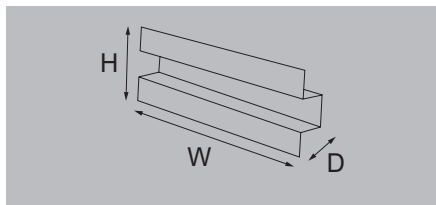

FAD S5135 SL42 R

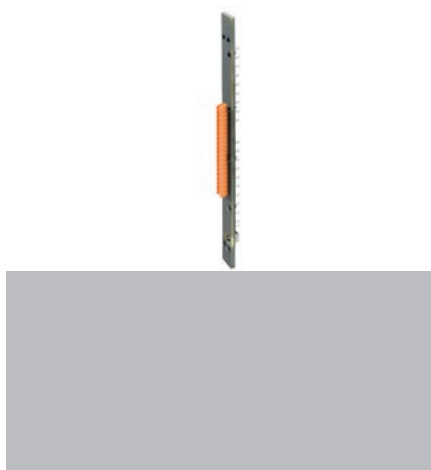

Technical data

Connection data	
Connection (field side)	SL 5.08 mm
Rated data	
Operating voltage	250 V AC
Max. current per channel	4 A
Max. current per byte	
Total operating current	32 A
General data	
Ambient temperature (operational)	-25...50 °C
Storage temperature	-40...60 °C
Approvals	CE, EAC
Insulation coordination (EN50178)	
Rated insulation voltage	< 250 V AC
Surge voltage category	II
Pollution severity level	2
Insulation test voltage	1.2 kVAC

Dimensions	
Width / Height / Depth	20 mm / 283 mm / 23 mm

Dimensions

Width / Height / Depth	20 mm / 283 mm / 23 mm
------------------------	------------------------

Note

Ordering data

Type	Qty.	Order No.
FAD S5135 SL42 A R	1	2435110000

Note

Accessories

Note	1610610000 - BLC 5.08/14/180R OR BX (3 units)
------	---

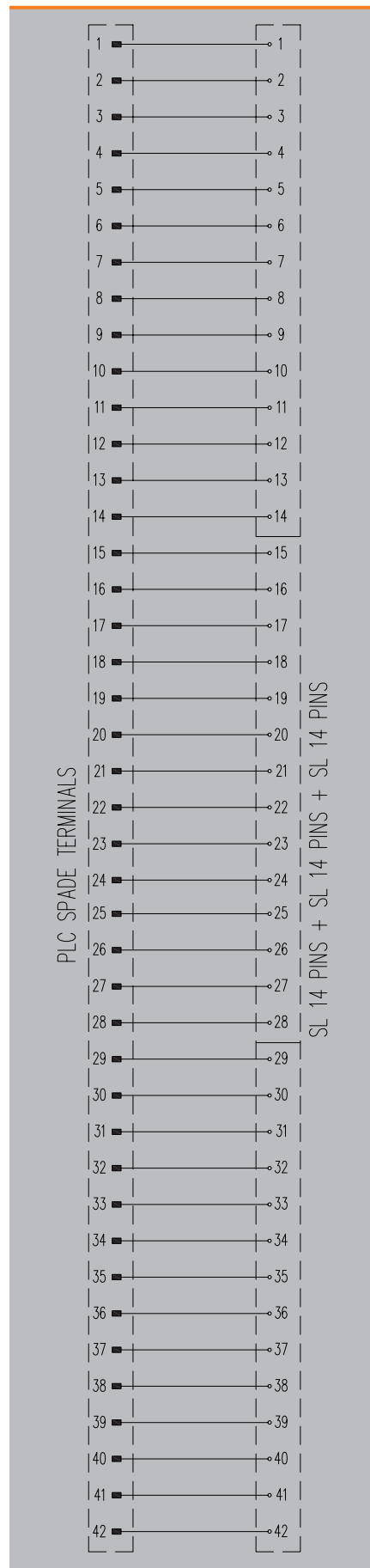

FAD – front adapters for migrations from Schneider TSX

The Weidmüller FAD BLK front adapters with pre-assembled cables provide safe migration from the old TSX47 to other PLC systems or to the u-remote system from Weidmüller.

- Clip-in foot for TS35

FAD BLK1 HE20 16I M

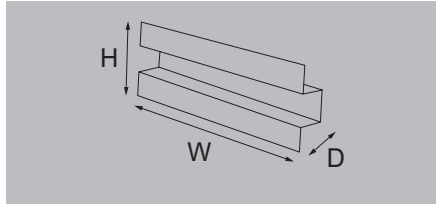

Technical data

Connection data	
Connection (field side)	
Rated data	
Operating voltage	
Max. current per channel	
Max. current per byte	
Total operating current	
General data	
Ambient temperature (operational)	
Storage temperature	
Approvals	
Insulation coordination (EN50178)	
Rated insulation voltage	
Surge voltage category	
Pollution severity level	
Insulation test voltage	

Plug-in connectors according to IEC 60603-13 / DIN 41651 20p	
30 V AC / 60 V DC	
1 A	
2 A	
3 A	
-25...50 °C	
-40...60 °C	
CE; EAC	
< 50 V AC	
III	
2	
0.35 kVAC	

Dimensions	
Width / Height / Depth	

54 mm / 218 mm / 40 mm

Note	
-------------	--

Ordering data

--	--	--

Type	Qty.	Order No.
FAD BLK1 HE20 16I M	1	1985940000

Note	
-------------	--

Accessories

Note	
-------------	--



FAD – front adapters for migrations from Schneider TSX

The Weidmüller FAD BLK front adapters with pre-assembled cables provide safe migration from the old TSX47 to other PLC systems or to the u-remote system from Weidmüller.

- Clip-in foot for TS35

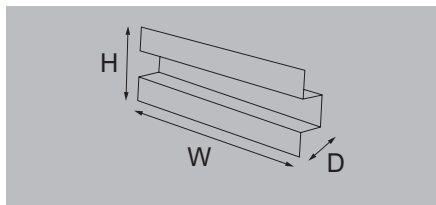

FAD BLK1 HE20 160 M

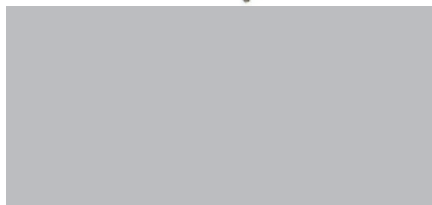

Technical data

Connection data	
Connection (field side)	
Rated data	
Operating voltage	
Max. current per channel	
Max. current per byte	
Total operating current	
General data	
Ambient temperature (operational)	
Storage temperature	
Approvals	
Insulation coordination (EN50178)	
Rated insulation voltage	
Surge voltage category	
Pollution severity level	
Insulation test voltage	

Plug-in connectors according to IEC 60603-13 / DIN 41651 20p	
30 V AC / 60 V DC	
1 A	
2 A	
3 A	
-25...50 °C	
-40...60 °C	
CE; EAC	
< 50 V AC	
III	
2	
0.35 kVAC	

Dimensions	
Width / Height / Depth	

54 mm / 218 mm / 36 mm

Note	
-------------	--

Ordering data

--	--	--

Type	Qty.	Order No.
FAD BLK1 HE20 160 M	1	1985950000

Note	
-------------	--

Accessories

Note	
-------------	--

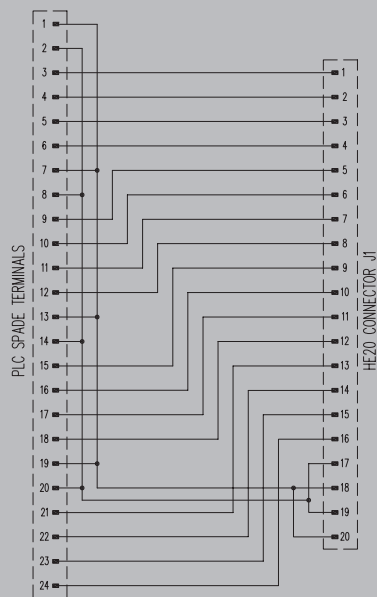

FAD – front adapters for migrations from Schneider TSX

The Weidmüller FAD BLK front adapters with pre-assembled cables provide safe migration from the old TSX47 to other PLC systems or to the u-remote system from Weidmüller.

- Clip-in foot for TS35

FAD BLK1 SL24 M

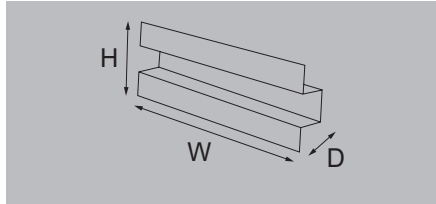

Technical data

Connection data

Connection (field side)

SL 5.08 mm

Rated data

Operating voltage

250 V AC

Max. current per channel

6 A

Max. current per byte

32 A

Total operating current

General data

Ambient temperature (operational)

-25...50 °C

Storage temperature

-40...60 °C

Approvals

CE, EAC

Insulation coordination (EN50178)

Rated insulation voltage

< 250 V AC

Surge voltage category

II

Pollution severity level

2

Insulation test voltage

1.2 kVAC

Dimensions

Width / Height / Depth

54 mm / 218 mm / 36 mm

Note

Ordering data

Type	Qty.	Order No.
FAD BLK1 SL24 M	1	1985930000

Note

Accessories

Note

1610590000 - BLC 5.08/12/180R OR BX (2 units)

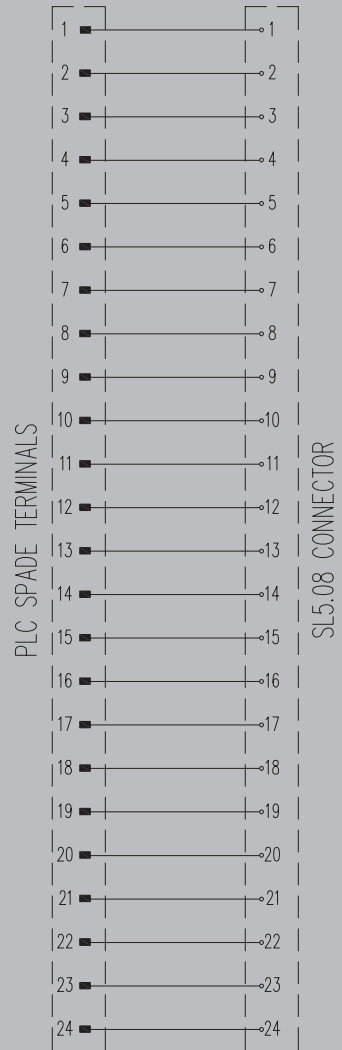

FAD – front adapters for migrations from Schneider TSX

The Weidmüller FAD BLK front adapters with pre-assembled cables provide safe migration from the old TSX47 to other PLC systems or to the u-remote system from Weidmüller.

- Clip-in foot for TS35

FAD BLK7 2XHE20 M

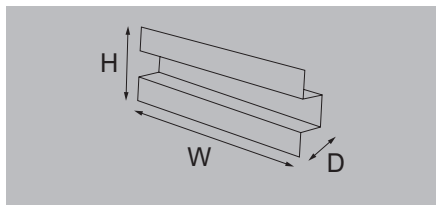

Technical data

Connection data	
Connection (field side)	
Rated data	
Operating voltage	
Max. current per channel	
Max. current per byte	
Total operating current	
General data	
Ambient temperature (operational)	
Storage temperature	
Approvals	
Insulation coordination (EN50178)	
Rated insulation voltage	
Surge voltage category	
Pollution severity level	
Insulation test voltage	

Connection data	
2 x Connector according IEC60603-13/DIN41651 20 p	
Rated data	
30 V AC / 60 V DC	
Max. current per channel	1 A
Max. current per byte	2 A
Total operating current	6 A
General data	
Ambient temperature (operational)	-25...50 °C
Storage temperature	-40...60 °C
Approvals	CE, EAC
Insulation coordination (EN50178)	
Rated insulation voltage	< 250 V AC
Surge voltage category	III
Pollution severity level	2
Insulation test voltage	1.2 kVAC

Dimensions	
Width / Height / Depth	54 mm / 218 mm / 36 mm

Note	
-------------	--

Ordering data

Type	Qty.	Order No.
FAD BLK7 2XHE20 M	1	1985960000

Note	
-------------	--

Accessories

Note	
-------------	--

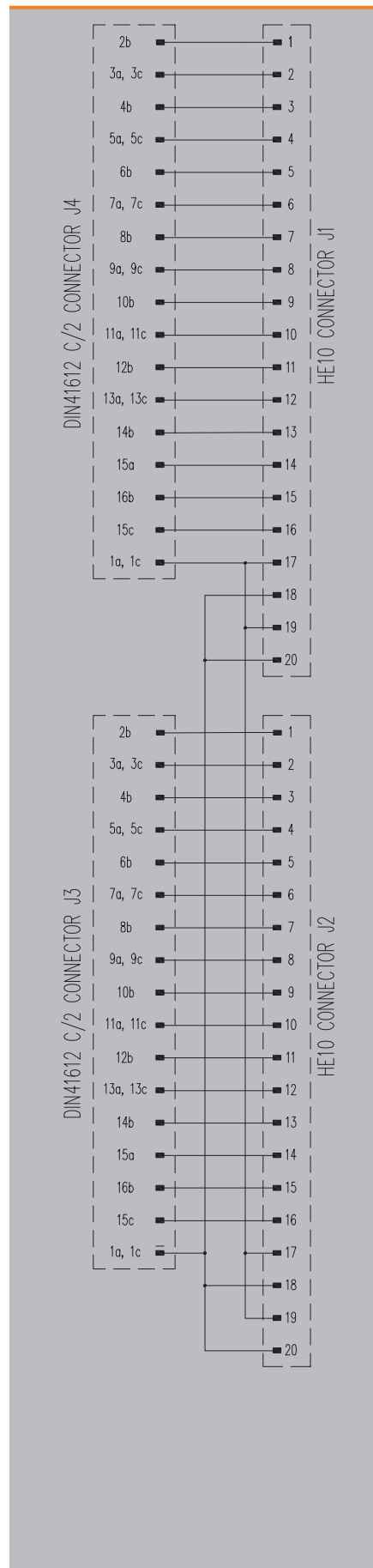

FAD – front adapters for migrations from Schneider TSX

The Weidmüller FAD BLK front adapters with pre-assembled cables provide safe migration from the old TSX47 to other PLC systems or to the u-remote system from Weidmüller.

- Clip-in foot for TS35

FAD BLK9 2XHE20 M

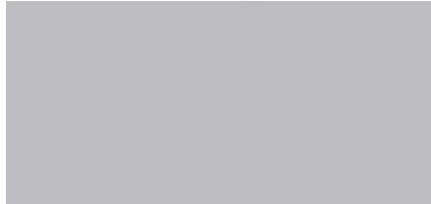
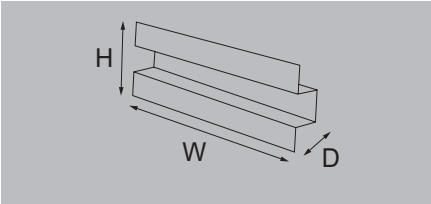

Technical data

Connection data	
Connection (field side)	2 x Connector according IEC60603-13/DIN41651 20 p
Rated data	
Operating voltage	30 V AC / 60 V DC
Max. current per channel	1 A
Max. current per byte	2 A
Total operating current	6 A
General data	
Ambient temperature (operational)	-25...50 °C
Storage temperature	-40...60 °C
Approvals	CE, EAC
Insulation coordination (EN50178)	
Rated insulation voltage	< 250 V AC
Surge voltage category	III
Pollution severity level	2
Insulation test voltage	1.2 kVAC

Dimensions	
Width / Height / Depth	54 mm / 218 mm / 36 mm

Dimensions	
Width / Height / Depth	54 mm / 218 mm / 36 mm

Note	
-------------	--

Ordering data

Type	Qty.	Order No.
FAD BLK9 2XHE20 M	1	1985970000

Note	
-------------	--

Accessories

Note	
-------------	--

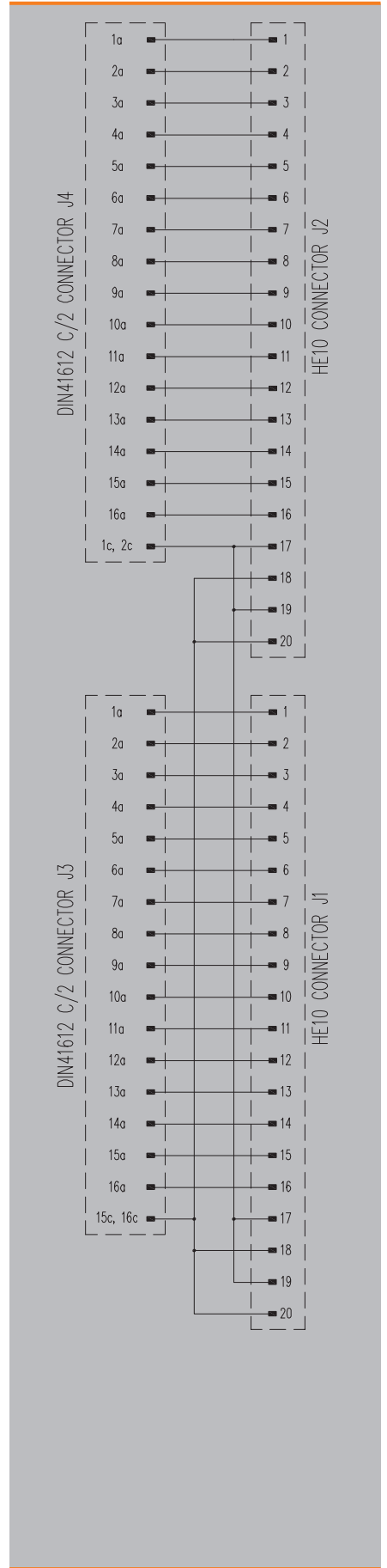

FAD – front adapters for migrations from Schneider TSX

The Weidmüller FAD BLK front adapters with pre-assembled cables provide safe migration from the old TSX47 to other PLC systems or to the u-remote system from Weidmüller.

- Clip-in foot for TS35

FAD BLK4 2XSL20

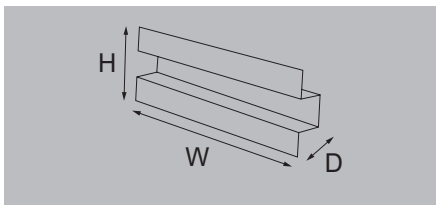

Technical data

Connection data	
Connection (field side)	
Rated data	
Operating voltage	
Max. current per channel	
Max. current per byte	
Total operating current	
General data	
Ambient temperature (operational)	
Storage temperature	
Approvals	
Insulation coordination (EN50178)	
Rated insulation voltage	
Surge voltage category	
Pollution severity level	
Insulation test voltage	

Connection data	
2 x Connector according IEC60603-13/DIN41651 20 p	
Rated data	
30 V AC / 60 V DC	
Max. current per channel	3 A
Max. current per byte	2 A
Total operating current	6 A
General data	
Ambient temperature (operational)	-25...50 °C
Storage temperature	-40...60 °C
Approvals	CE, EAC
Insulation coordination (EN50178)	
Rated insulation voltage	50 V AC / 71 V DC
Surge voltage category	III
Pollution severity level	2
Insulation test voltage	0.56 kVAC

Dimensions	
Width / Height / Depth	54 mm / 218 mm / 24 mm

Note	
-------------	--

Ordering data

Type	Qty.	Order No.
FAD BLK4 2XSL20	1	2494590000

Note	
-------------	--

Accessories

Note	1690370000 - BLZF 3.50/20/180 SN OR BX (2 units)
-------------	--

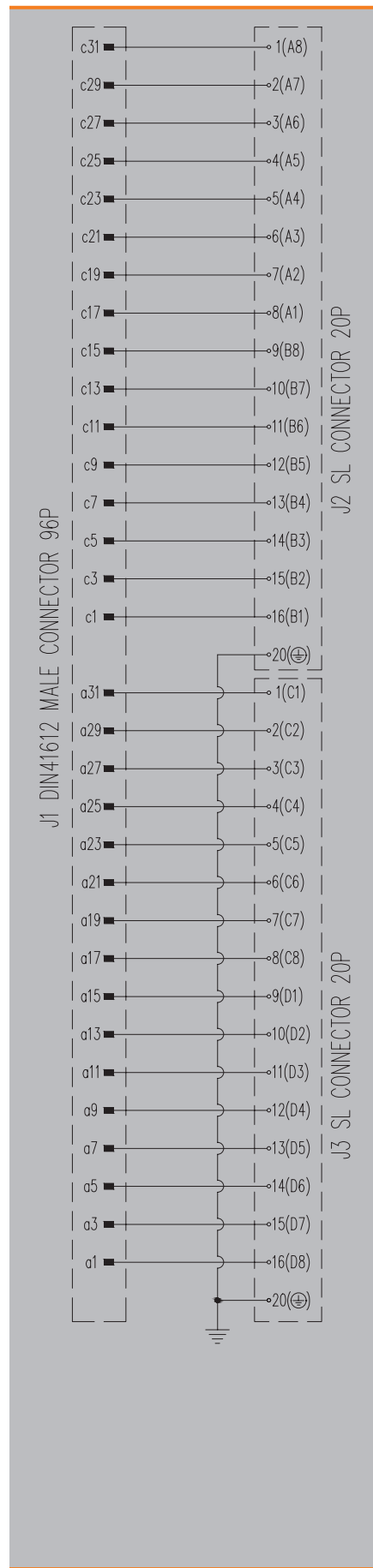

FAD – front adapters for migrations from Schneider Premium

FAD PREM BLY01

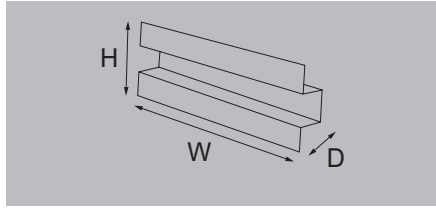

Technical data

Connection data	
Connection (field side)	S2C-SMT 3.5 mm
Rated data	
Operating voltage	230 V AC ± 10%
Max. current per channel	4 A
Total operating current	80 A
General data	
Ambient temperature (operational)	-25...50 °C
Storage temperature	-25...60 °C
Approvals	CE, EAC
Insulation coordination (EN50178)	
Rated insulation voltage	255V AC / 360 V DC
Surge voltage category	II
Pollution severity level	2
Insulation test voltage	1.15 kVAC
Insulation coordination (IEC/UL61010-1 & IEC/UL61010-2-201)	
Rated insulation voltage	255V AC / 360 V DC
Surge voltage category	II
Pollution severity level	2
Insulation test voltage	1.01

Dimensions	
Width / Height / Depth	37 mm / 151 mm / 33 mm

Note	
-------------	--

Ordering data

Type	Qty.	Order No.
FAD PREM BLY01	1	8000070313

Note	
-------------	--

Accessories

Note	
-------------	--

CONNECTORS WITH PIN ASSIGNMENTS

S2C-SMT 3.50/10P CONNECTOR J2		S2C-SMT 3.50/10P CONNECTOR J1	
12	11	2	1
14	13	4	3
16	15	6	5
18	17	8	7
20	19	10	9

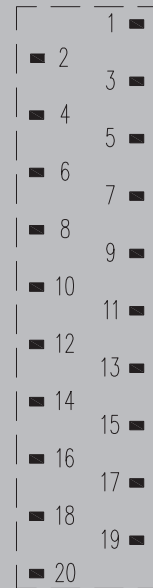

PLC SPADE TERMINALS

SCHEMATIC TABLE

PLC SPADE TERMINALS	S2C-SMT 3.50/10P J1-J2
1	1
2	2
3	3
4	4
5	5
6	6
7	7
8	8
9	9
10	10
11	11
12	12
13	13
14	14
15	15
16	16
17	17
18	18
19	19
20	20

CONNECTOR J1

CONNECTOR J2

FAD – front adapters for migrations from Schneider Premium

FAD PREM 4HE20

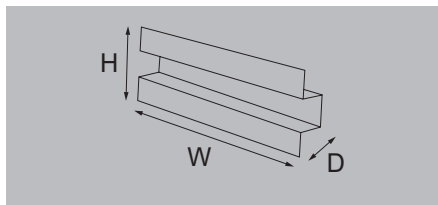

Technical data

Connection data	
Connection (field side)	S2C-SMT 3.5 mm
Rated data	
Operating voltage	48 V AC + 10%
Max. current per channel	200 mA
Total operating current	5 A
General data	
Ambient temperature (operational)	-25...50 °C
Storage temperature	-25...60 °C
Approvals	CE, EAC
Insulation coordination (EN50178)	
Rated insulation voltage	50 V AC / 70 V DC
Surge voltage category	II
Pollution severity level	2
Insulation test voltage	0.35 kVAC
Insulation coordination (IEC/UL61010-1 & IEC/UL61010-2-201)	
Rated insulation voltage	50 V AC / 70 V DC
Surge voltage category	II
Pollution severity level	2
Insulation test voltage	0.86

Dimensions	
Width / Height / Depth	37 mm / 151 mm / 40 mm

Note	
-------------	--

Ordering data

Type	Qty.	Order No.
FAD PREM 4HE20	1	8000070314

Note	
-------------	--

Accessories

Note	1277360000 B2CF 3.50/20/180 SN OR BX (4 units)
-------------	--

CONNECTORS WITH PIN ASSIGNMENTS

S2C-SMT 3.50/20P CONNECTOR J1	19 17	3 1
S2C-SMT 3.50/20P CONNECTOR J2	20 18	4 2
S2C-SMT 3.50/20P CONNECTOR J3	39 37	23 21
S2C-SMT 3.50/20P CONNECTOR J4	40 38	24 22
S2C-SMT 3.50/20P CONNECTOR J1	59 57	43 41
S2C-SMT 3.50/20P CONNECTOR J2	60 58	44 42
S2C-SMT 3.50/20P CONNECTOR J3	79 77	63 61
S2C-SMT 3.50/20P CONNECTOR J4	80 78	64 62

HE10 20P CONNECTOR C	41 42	1 2
HE10 20P CONNECTOR D	43 44	3 4
HE10 20P CONNECTOR A	57 58	17 18
HE10 20P CONNECTOR B	59 60	19 20
HE10 20P CONNECTOR C	61 62	21 22
HE10 20P CONNECTOR D	63 64	23 24
HE10 20P CONNECTOR A	77 78	37 38
HE10 20P CONNECTOR B	79 80	39 40

SCHEMATIC TABLE

HE10 20P A-B-C-D	S2C-SMT 3.50/20P J1-J2-J3-J4
CONNECTOR A	1 2
CONNECTOR B	21 22
CONNECTOR C	41 42
CONNECTOR D	61 62

FAD – front adapters for migrations from Schneider Premium

FAD PREM 2SD25F

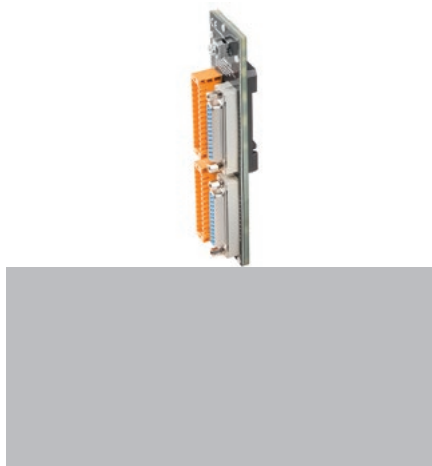
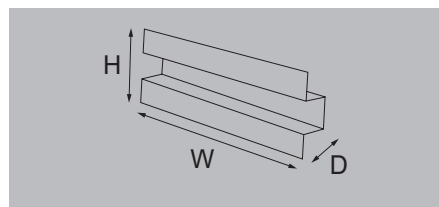

Technical data

Connection data	
Connection (field side)	S2C-SMT 3.5 mm
Rated data	
Operating voltage	24 V DC ± 25%
Max. current per channel	200 mA
Total operating current	5 A
General data	
Ambient temperature (operational)	-25...50 °C
Storage temperature	-25...60 °C
Approvals	CE, EAC
Insulation coordination (EN50178)	
Rated insulation voltage	50 V AC / 70 V DC
Surge voltage category	II
Pollution severity level	2
Insulation test voltage	0.35 kVAC
Insulation coordination (IEC/UL61010-1 & IEC/UL61010-2-201)	
Rated insulation voltage	50 V AC / 70 V DC
Surge voltage category	II
Pollution severity level	2
Insulation test voltage	0.86

Dimensions	
Width / Height / Depth	37 mm / 151 mm / 28 mm

Note	
-------------	--

Ordering data

Type	Qty.	Order No.
FAD PREM 2SD25F	1	8000070315

Note	
-------------	--

Accessories

Note	1277790000 B2CF 3.50/26/180F SN OR BX (2 units)
-------------	---

CONNECTORS WITH PIN ASSIGNMENTS

S2C-SMT 3.50/26P CONNECTOR J1	S2C-SMT 3.50/26P CONNECTOR J3	SUB-D 25P F CONNECTOR J2	SUB-D 25P F CONNECTOR J4																																
<table border="1" style="margin: auto;"> <tr><td>1</td><td>14</td></tr> <tr><td>2</td><td>15</td></tr> <tr><td>12</td><td>25</td></tr> <tr><td>13</td><td>⊕</td></tr> </table>	1	14	2	15	12	25	13	⊕	<table border="1" style="margin: auto;"> <tr><td>26</td><td>39</td></tr> <tr><td>27</td><td>40</td></tr> <tr><td>37</td><td>50</td></tr> <tr><td>38</td><td>⊕</td></tr> </table>	26	39	27	40	37	50	38	⊕	<table border="1" style="margin: auto;"> <tr><td>1</td><td>14</td></tr> <tr><td>2</td><td>15</td></tr> <tr><td>12</td><td>24</td></tr> <tr><td>13</td><td>25</td></tr> </table>	1	14	2	15	12	24	13	25	<table border="1" style="margin: auto;"> <tr><td>26</td><td>39</td></tr> <tr><td>27</td><td>40</td></tr> <tr><td>37</td><td>49</td></tr> <tr><td>38</td><td>50</td></tr> </table>	26	39	27	40	37	49	38	50
1	14																																		
2	15																																		
12	25																																		
13	⊕																																		
26	39																																		
27	40																																		
37	50																																		
38	⊕																																		
1	14																																		
2	15																																		
12	24																																		
13	25																																		
26	39																																		
27	40																																		
37	49																																		
38	50																																		

SCHEMATIC TABLE

S2C-SMT 3.50/26P		SUB-D 25P F	
J1-J3		J2-J4	
CONNECTOR J1	1 2	CONNECTOR J2	1 2
CONNECTOR J3	24 25 ⊕	CONNECTOR J4	24 25 ⊕
Solder to Sub-D connector		Solder to Sub-D connector	

FAD – Front adapters for migration - Rockwell PLC-5

The FAD PLC-5 front adapters with pre-assembled cables provide safe migration from the PLC-5 cards to other PLC systems or to the U-REMOTE modules from Weidmüller.

- Can be plugged into TS35 terminal rail

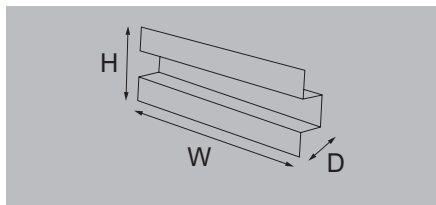

FAD 1771-WA/WC/WB/WD



Technical data

Rated data	
Operating voltage, max.	< 300 V AC
Max. current per channel	2 A
Total operating current	8 A
General data	
Ambient temperature (operational)	0...50 °C
Storage temperature	0...50 °C
Approvals	CE, UR

< 300 V AC
2 A
8 A
0...50 °C
0...50 °C
CE, UR

Dimensions	
Width / Height / Depth	32 mm / 269 mm / 53 mm

32 mm / 269 mm / 53 mm

Note	

--

Ordering data

FAD for wiring-arm WA-WC	Type	Qty.	Order No.
FAD for wiring-arm WB-WD	FAD 1771-WA/WC SL10 M US	1	7940125447
	FAD 1771-WB/WD SL12 M US	1	7940125450

Type	Qty.	Order No.
FAD 1771-WA/WC SL10 M US	1	7940125447
FAD 1771-WB/WD SL12 M US	1	7940125450

Note	

--

Accessories

Note	
7940125447: 1690960000 - BLZF 3.50/10/180F SN OR BX	
7940125450: 1690980000 - BLZF 3.50/12/180F SN OR BX	

7940125447: 1690960000 - BLZF 3.50/10/180F SN OR BX
7940125450: 1690980000 - BLZF 3.50/12/180F SN OR BX

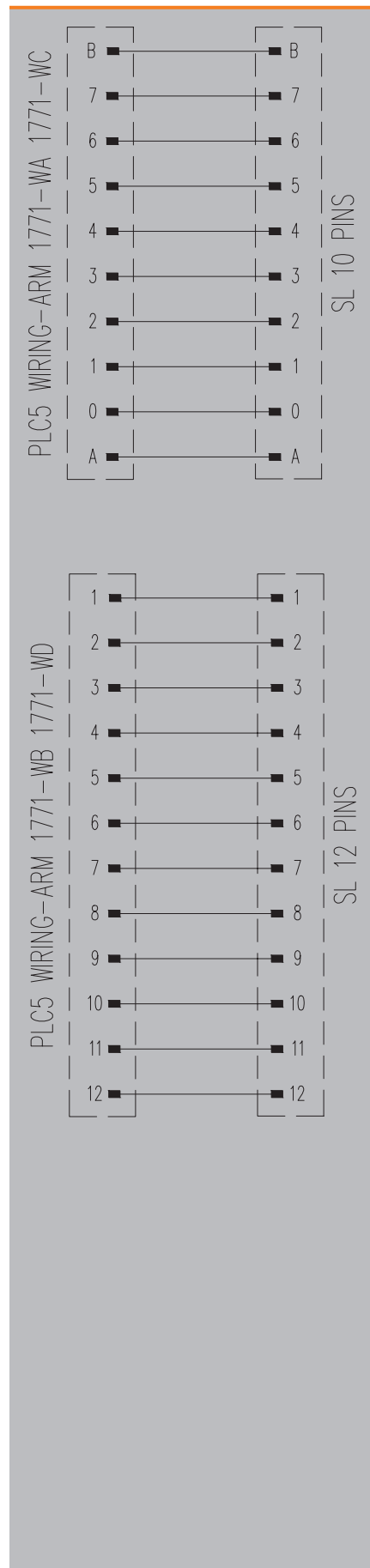

FAD – front adapters for migrations from Rockwell PLC-5 – Bridge System

FAD – Front adapters for migration - Rockwell PLC-5

The FAD PLC-5 front adapters with pre-assembled cables provide safe migration from the PLC-5 cards to other PLC systems or to the U-REMOTE modules from Weidmüller.

- Can be plugged into TS35 terminal rail

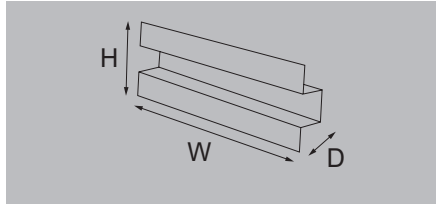

Technical data

Rated data

Operating voltage, max.
Max. current per channel
Total operating current

General data

Ambient temperature (operational)
Storage temperature
Approvals

FAD 1771-WG/WH



< 250 V AC
2 A
8 A
0...50 °C
0...50 °C
CE, UR

Dimensions

Width / Height / Depth

32 mm / 269 mm / 33 mm

Note

Ordering data

FAD for wiring-arm WH/WHF/WHFR
FAD for wiring-arm WG

Type	Qty.	Order No.
FAD 1771-WH SL21 M US	1	7940125448
FAD 1771-WG SL21 M US	1	7940125452

Note

Accessories

Note

1690970000 - BLZF 3.50/11/180F SN OR BX (2 units)

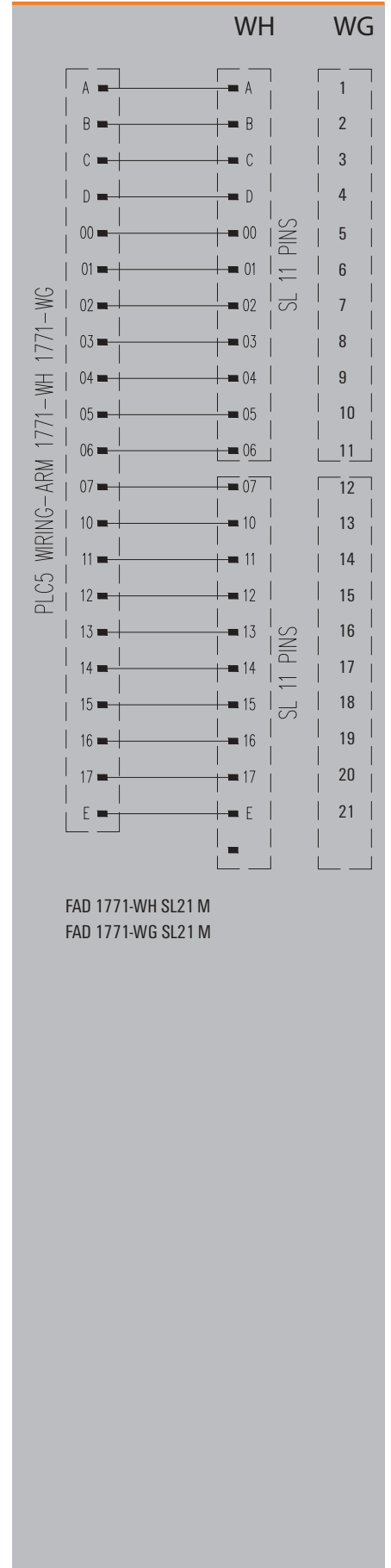

FAD – Front adapters for migration - Rockwell PLC-5

The FAD PLC-5 front adapters with pre-assembled cables provide safe migration from the PLC-5 cards to other PLC systems or to the U-REMOTE modules from Weidmüller.

- Can be plugged into TS35 terminal rail

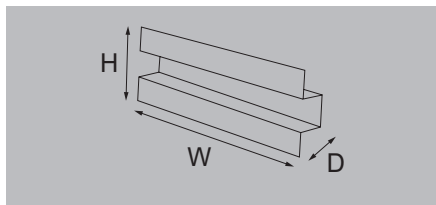

FAD 1771-WF



Technical data

Rated data	
Operating voltage, max.	< 300 V AC
Max. current per channel	2 A
Total operating current	8 A
General data	
Ambient temperature (operational)	0...50 °C
Storage temperature	0...50 °C
Approvals	CE, UR

< 300 V AC
2 A
8 A
0...50 °C
0...50 °C
CE, UR

Dimensions
Width / Height / Depth

32 mm / 269 mm / 53 mm

Note

Ordering data

FAD for wiring-arm WE/WF/WI

Type	Qty.	Order No.
FAD 1771-WF SL18 M US	1	7940125451

Note

Accessories

Note
1691040000 - BLZF 3.50/18/180F SN OR BX

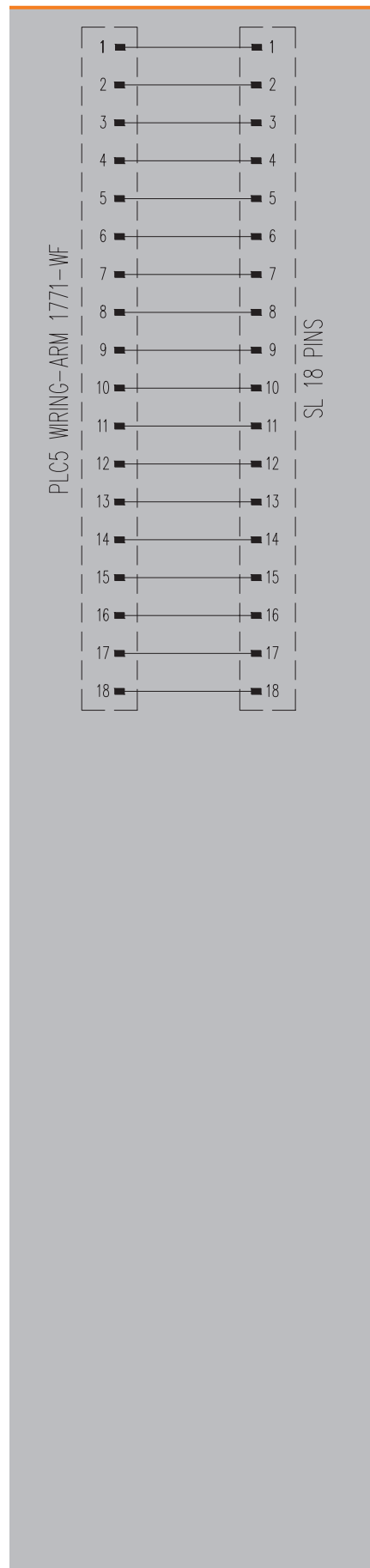

FAD – front adapters for migrations from Rockwell PLC-5 – Bridge System

FAD – Front adapters for migration - Rockwell PLC-5

The FAD PLC-5 front adapters with pre-assembled cables provide safe migration from the PLC-5 cards to other PLC systems or to the U-REMOTE modules from Weidmüller.

- Can be plugged into TS35 terminal rail

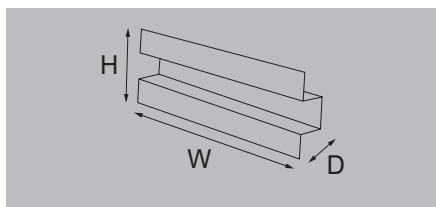

Technical data

Rated data

Operating voltage, max.
Max. current per channel
Total operating current

General data

Ambient temperature (operational)
Storage temperature
Approvals

FAD 1771-WN



< 300 V AC

2 A

8 A

0...50 °C

0...50 °C

CE, UR

Dimensions

Width / Height / Depth

32 mm / 269 mm / 33 mm

Note

Ordering data

FAD for wiring-arm WN

Type	Qty.	Order No.
FAD 1771-WN S2L20 M US		7940125449

Note

Accessories

1690370000 - BLZF 3.50/20/180 SN OR BX (2 units)

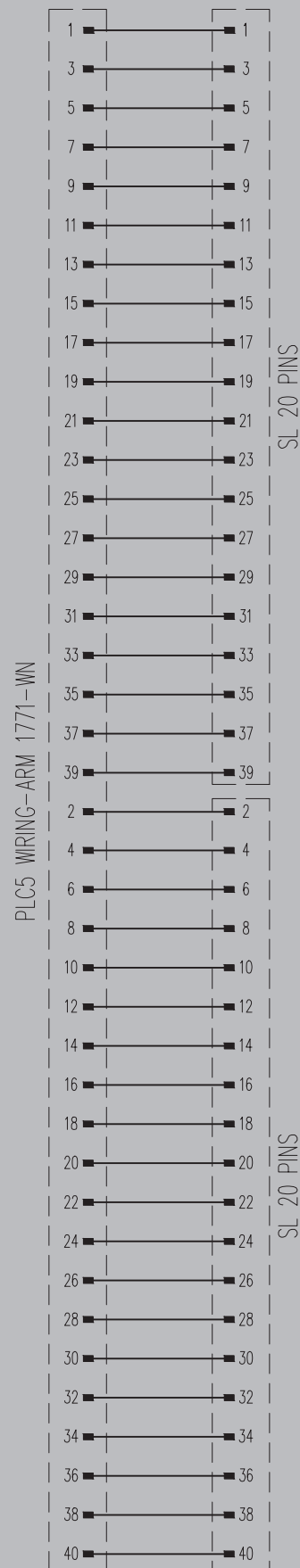

MIGRATION RACK – Migration accessories

- The 19" racks have the same dimensions as the original Siemens or Schneider racks
- The front adapters (FAD) are installed in the bottom section of the rack while the new PLC is located in the top section
- The racks are fitted with a hinge that provides access to the old cabling

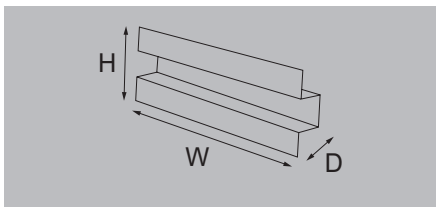

Technical data

Material
Material

MIGRATION RACK S5 115 H



Material
Stainless steel, rust-proof

MIGRATION RACK S5 135 H



Material
Stainless steel, rust-proof

Dimensions
Height / Depth

Height / Depth
221 mm / 134 mm

Height / Depth
221 mm / 134 mm

Note

Note

Note

Ordering data

Type	Width	Order No.
MIGRATION RACK S5 115 H	532 mm	1993530000

Type	Width	Order No.
MIGRATION RACK S5 115 H	532 mm	1993530000

Type	Width	Order No.
MIGRATION RACK S5 135 H	532 mm	1993500000

Note

Note

Note

Accessories

Note

Note
19" Rails: S7-1500 6ES7590-1AE80-0AA0, S7-300 6ES7390-1AE80-0AA0, Premium TSX RKY 12, Weidmüller TS35 8000075320

Note
19" Rails: S7-1500 6ES7590-1AE80-0AA0, S7-300 6ES7390-1AE80-0AA0, Premium TSX RKY 12, Weidmüller TS35 8000075320

Migration RACK – Migration accessories

MIGRATION RACK – Migration accessories

- The 19" racks have the same dimensions as the original Siemens or Schneider racks
- The front adapters (FAD) are installed in the bottom section of the rack while the new PLC is located in the top section
- The racks are fitted with a hinge that provides access to the old cabling

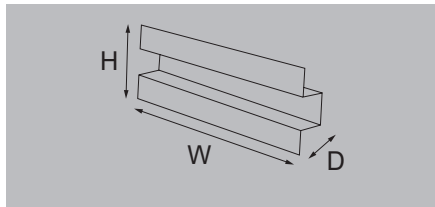

Technical data

Material
Material

MIGRATION RACK TSX7 H



Material
Stainless steel, rust-proof

MIGRATION RACK PLC5 H



Material
Stainless steel, rust-proof

G

Dimensions
Height / Depth

221 mm / 121 mm

315 mm / 130 mm

Note

--

--

Ordering data

Type	Width	Order No.
MIGRATION RACK TSX7 H	532 mm	1993520000

Type	Width	Order No.
MIGRATION RACK PLC5-8S H	356 mm	8000074896
MIGRATION RACK PLC5-12S H	483 mm	8000075319
MIGRATION RACK PLC5-16S H	610 mm	8000074897

Type	Width	Order No.
MIGRATION RACK PLC5-8S H	356 mm	8000074896
MIGRATION RACK PLC5-12S H	483 mm	8000075319
MIGRATION RACK PLC5-16S H	610 mm	8000074897

Note

--

--

Accessories

Note
19" Rails: S7-1500 6ES7590-1AE80-0AA0, S7-300 6ES7390-1AE80-0AA0, Premium TSX RKY 12, Weidmüller TS35 8000075320

19" Rails: S7-1500 6ES7590-1AE80-0AA0, S7-300 6ES7390-1AE80-0AA0, Premium TSX RKY 12, Weidmüller TS35 8000075320
--

Please see accessories selection table for migration between PLC5 to Weidmüller/Siemens/Schneider/ControlLogix/ControlEdge PLC's in this chapter.

Accessories selection table for migration between PLC-5 to Weidmüller/Siemens/Schneider/ControlLogix/ControlEdge PLC's

RACK PLC-5 OLD RACK PLC		MIGRATION SYSTEM							
Manufacturer code	Description	MIGRATION RACK		NEW RACK PLC			MIGRATION ACCESSORIES		
		Order Number	Type	Manufacturer	Family	Type	Order Number	Type	
1771-A2B	CHASSIS PLC-5 SERIES B 8 SLOTS	8000074896	MIGRATION RACK PLC5-8S H	WEIDMÜLLER	U-REMOTE		8000074840	PLATE PLC5-8S DIN RAIL TS35	
					ET 200SP		8000074840	PLATE PLC5-8S DIN RAIL TS35	
				SIEMENS	ET 200SP HA	6DL1193-6MD00-0AA0 ^(A)			not accessory needed
					S7-1500	6ES7590-1BC00-0AA0 ^(A)			not accessory needed
					S7-300 / ET200M	6ES7390-1BC00-0AA0 ^(A)			not accessory needed
						6ES7195-1GC00-0XA0 ^(A)			not accessory needed
				SCHNEIDER	MODICON TM3		8000074840	PLATE PLC5-8S DIN RAIL TS35	
					MODICON M340	BMX-XBP-0400	8000074841	PLATE PLC5-8S BMX-E 4-6S	
						BMX-XBP-0600			
						BMX-XBP-0800		not accessory needed	
					MODICON M580	BME-XBP-0400	8000074841	PLATE PLC5-8S BMX-E 4-6S	
				BME-XBP-0600					
				BME-XBP-0800	not accessory needed				
				ROCKWELL	CONTROL LOGIX	1756-A4 1756-A7	8000074842	PLATE PLC5-8S CTIX A4-7	
HONEYWELL	CONTROL EDGE	900R04 900R08	8000074843	PLATE PLC5-8S CTEDGE 4-8S					
1771-A3B1	CHASSIS PLC-5 SERIES B 12 SLOTS	8000075319	MIGRATION RACK PLC5-12S H	WEIDMÜLLER	U-REMOTE		8000075320	PLATE DIN RAIL TS35 19INCH	
					ET 200SP		8000075320	PLATE DIN RAIL TS35 19INCH	
				SIEMENS	ET 200SP HA	6DL1193-6MC00-0AA0 ^(B)			not accessory needed
					S7-1500	6ES7590-1AE80-0AA0 ^(B)			not accessory needed
					S7-300 / ET200M	6ES7390-1AE80-0AA0 ^(B)			not accessory needed
						6ES7195-1GA00-0XA0 ^(B)			not accessory needed
				SCHNEIDER	MODICON TM3		8000075320	PLATE DIN RAIL TS35 19INCH	
					MODICON M340	BMX-XBP-0400	8000073869	PLATE BMX-E 4-6-8S 19INCH	
						BMX-XBP-0600			
						BMX-XBP-0800		not accessory needed	
					MODICON M580	BME-XBP-0400	8000073869	PLATE BMX-E 4-6-8S 19INCH	
				BME-XBP-0600					
				BME-XBP-0800	not accessory needed				
				ROCKWELL	CONTROL LOGIX	1756-A4 1756-A7 1756-A10 1756-A13	8000074062	PLATE PLC5-12S CTIX A4-7-10-13	
HONEYWELL	CONTROL EDGE	900R04 900R08 900R12	8000074063	PLATE PLC5-12S CTEDGE 4-8-12S					
		900R08R	8000074064	PLATE PLC5-12S CTEDGE 8S+RPS					
			8000074845	PLATE PLC5-16S DIN RAIL TS35					
1771-A4B	CHASSIS PLC-5 SERIES B 16 SLOTS	8000074897	MIGRATION RACK PLC5-16S H	WEIDMÜLLER	U-REMOTE		8000074845	PLATE PLC5-16S DIN RAIL TS35	
					ET 200SP		8000074845	PLATE PLC5-16S DIN RAIL TS35	
				SIEMENS	ET 200SP HA	6DL1193-6MD00-0AA0 ^(A)			not accessory needed
					S7-1500	6ES7590-1BC00-0AA0 ^(A)			not accessory needed
					S7-300 / ET200M	6ES7390-1BC00-0AA0 ^(A)			not accessory needed
						6ES7195-1GG30-0XA0 ^(B)			not accessory needed
				SCHNEIDER	MODICON TM3		8000074845	PLATE PLC5-16S DIN RAIL TS35	
					MODICON M340	BMX-XBP-0400	8000074846	PLATE PLC5-16S BMX-E 4-6-8-12S	
						BMX-XBP-0600			
						BMX-XBP-0800		not accessory needed	
					MODICON M580	BME-XBP-0400	8000074846	PLATE PLC5-16S BMX-E 4-6-8-12S	
				BME-XBP-0600					
				BME-XBP-0800	not accessory needed				
				ROCKWELL	CONTROL LOGIX	1756-A4 1756-A7 1756-A10 1756-A13	8000074847	PLATE PLC5-16S CTIX A4-7-10-13	
		1756-A17	8000074848	PLATE PLC5-16S CTIX A17					
HONEYWELL	CONTROL EDGE	900R04 900R08 900R12	8000074849	PLATE PLC5-16S CTEDGE 4-8-12S					
		900R08R	8000074850	PLATE PLC5-16S CTEDGE 8-12S+RPS					
		900R12R							

Note: (A) Accessory has to be bought to Siemens and cutted.
(B) Accessory has to be bought to Siemens.

Migrate IPC620 / PLC 5 / QUANTUM / MOORE systems in the shortest time possible

Simple control system conversion with IPC620 / PLC 5 / QUANTUM / MOORE Card system

When upgrading obsolete PLC/DCS systems, an increasing number of users are opting to keep their existing wiring. This allows the migration to be performed considerably faster, more efficiently and with fewer errors.

Many users will soon have to upgrade their controls. With the system-specific migration system from Weidmüller, the migration to a new system can be completed in just a few hours.

The particular advantage of the Weidmüller migration platform is its clever concept: using a system-specific front adapter, the new PLC/DCS can be connected to the existing field wiring, eliminating the need for time-consuming and costly rewiring.



In many industries, plant operators need to perform PLC system updates without any downtimes. In situations such as these, PLC migration adapters from Weidmüller are the perfect solution.

Your special advantages:

Straightforward PLC/DCS conversion within a few short hours

All components are immediately ready for use following the conversion, and existing field terminations remain grounded. Interlocking plug-in connectors prevent cabling errors. The old rack remain in place simplifying the installation time.

Minimal number of components

Weidmüller's migration solution includes a small number of card adapters with different poles.



PLC interface cables

The Card-Adapters are compatible with PLC/DCS systems from several manufacturers, and can be connected using pre-mounted cables.

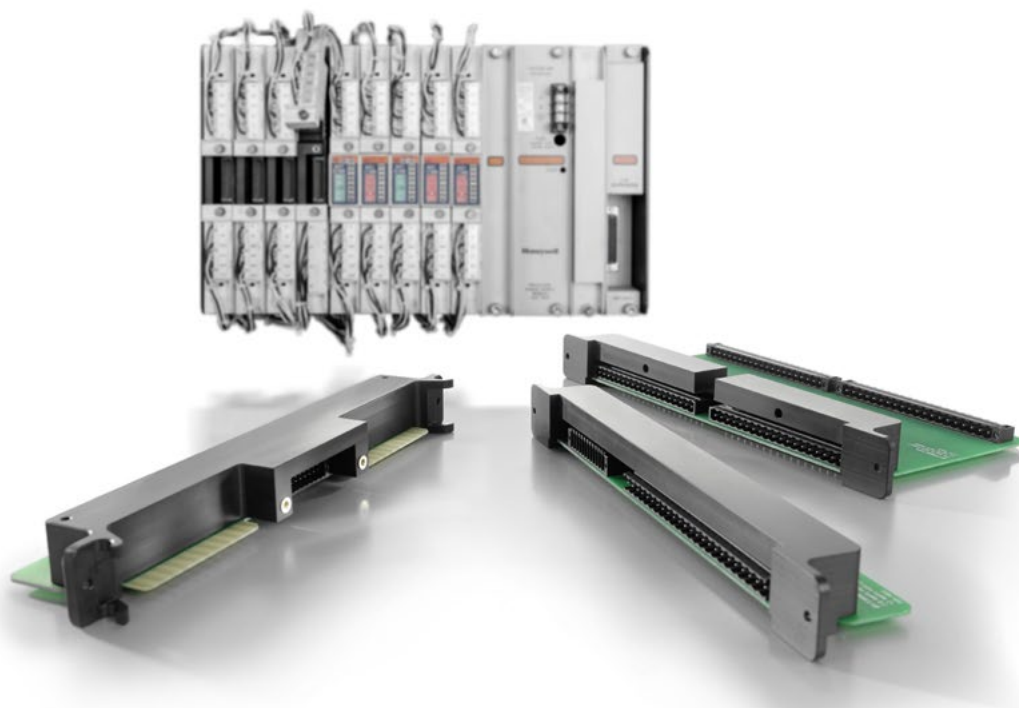

Straightforward migration process

The entire migration process can be performed in just five simple steps.

Global approvals

The card adapters are cURus approved.

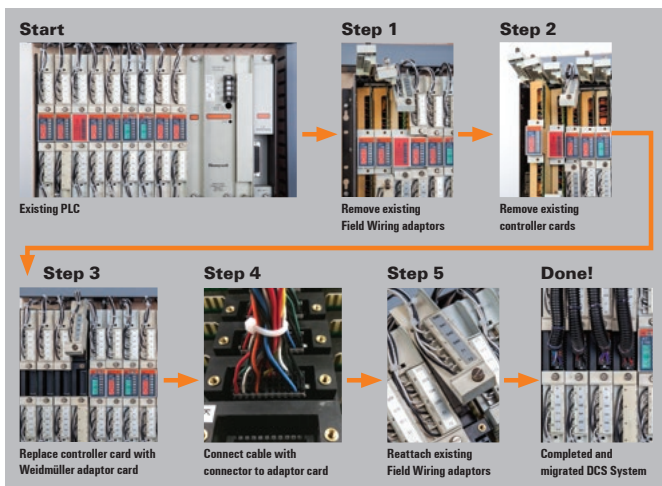

Selection Table for migration between Rockwell PLC-5 and Honeywell IPC620 to ferrules

The following selection tables help you to choose the pre-assembled cables to migrate from Rockwell PLC-5 and Honeywell IPC620 to other PLC platforms through cables with ferrules.

PLC-5 Card (Cardsystem) Wiring-arms	Front-adaptor FAD		Pre-assembled cable			
	Order No	Type	Order No	Type	Type of cable	Number of cables /FAD
WA/WC	6720001398	SP-RS PLC PLC5 1771-WA/WC	2757730XXX	PAC-BL12-F-C50-V0-XXXX	single cable 0.5 mm ²	1
WB/WD	6720001397	SP-RS PLC PLC5 1771-WB/WD	2757740XXX	PAC-BL12-F-C50-XXXX	single cable 0.5 mm ²	1
WE/WF/WI	6720001399	SP-RS PLC PLC5 1771-WI 18CH	2757750XXX	PAC-B2CF22-F-C50-V0-XXXX	single cable 0.5 mm ²	1
WH/WHF/WHFB	7940125460	SP-RS PLC PLC5 1771-H/F/FB	2757760XXX	PAC-B2CF22-F-C50-V1-XXXX	single cable 0.5 mm ²	1
WG	7940125466	SP-RS PLC PLC5 1771-G	2757760XXX	PAC-B2CF22-F-C50-V1-XXXX	single cable 0.5 mm ²	1
WN	6720001400	SP-RS PLC PLC5 1771-WN 40CH	2757770XXX	PAC-2B2CF22-F-C50-XXXX	single cable 0.5 mm ²	1

G

IPC620 Card (Cardsystem)	Front-adaptor FAD		Pre-assembled cable			
	Order No	Type	Order No	Type	Type of cable	Number of cables /FAD
12-point IPC-620	6720000787	RS PLC IPC-620 12-POINTS	2757780XXX	PAC-B2L22-F-C50-V0-XXXX	single cable 0.5 mm ²	1
22-point IPC-620	6720000788	RS PLC IPC-620 22-POINTS	2757790XXX	PAC-B2L22-F-C50-XXXX	single cable 0.5 mm ²	1
24-point IPC-620	6720001226	RS PLC IPC-620 24-POINTS	2757810XXX	PAC-B2CF24-F-C50-XXXX	single cable 0.5 mm ²	1
34-point IPC-620	6720001328	RS PLC IPC-620 34-POINTS	2830400XXX	PAC-2BLZP20-F-C50-V0-XXXX	single cable 0.5 mm ²	1
38-point IPC-620	6720001225	RS PLC IPC-620 38-POINTS	2757800XXX	PAC-2BLZP20-F-C50-XXXX	single cable 0.5 mm ²	1

Universal card adapters

- Feed through connection
- PLC-5 1771 conversion to pluggable connector(s)
- 10-, 12-, 18-, 21- or 40-point cards

SP-RS PLC PLC5 1771-WA/WC

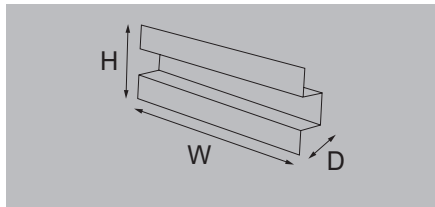

Technical data

Rated data

Operating voltage
 Max. current per channel
 Ambient temperature (operational)
 Storage temperature

Approvals

Approvals

150 V
5 A
0...50 °C
0...50 °C
UR

Dimensions

Width / Height / Depth

30 mm / 254 mm / 144 mm

Note

Ordering data

Type	Qty.	Order No.
SP-RS PLC PLC5 1771-WA/WC	1	6720001398

Note

Accessories

Note

Pluggable connector: 1606740000 - BL 3.50/12/180° SN OR BX



FAD – front adapters for migrations from Rockwell PLC-5 – Card System

Universal card adapters

- Feed through connection
- PLC-5 1771 conversion to pluggable connector(s)
- 10-, 12-, 18-, 21- or 40-point cards

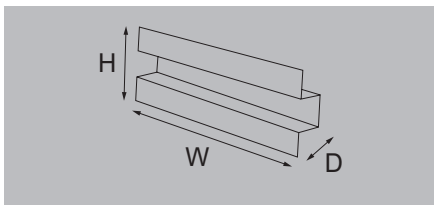

Technical data

Rated data

Operating voltage
 Max. current per channel
 Ambient temperature (operational)
 Storage temperature

Approvals

Approvals

SP-RS PLC PLC5 1771-WB/WD

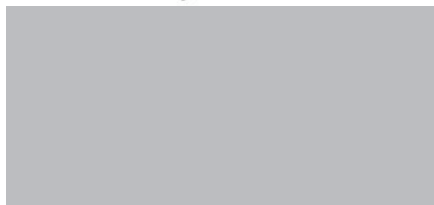

Operating voltage	150 V
Max. current per channel	5 A
Ambient temperature (operational)	0...50 °C
Storage temperature	0...50 °C
Approvals	UR

Dimensions

Width / Height / Depth

30 mm / 254 mm / 144 mm

Note

Ordering data

Type	Qty.	Order No.
SP-RS PLC PLC5 1771-WB/WD	1	6720001397

Note

Accessories

Note

Pluggable connector: 1606740000 - BL 3.50/12/180F SN OR BX

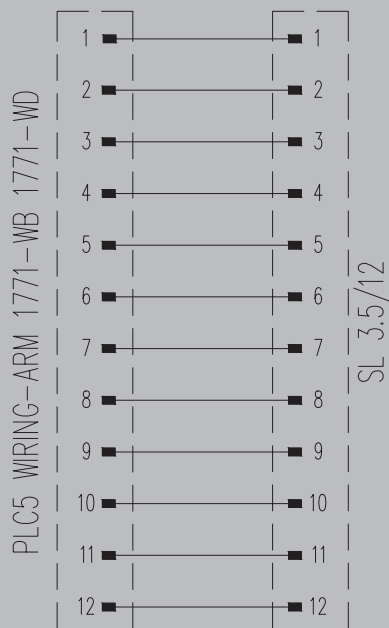

Universal card adapters

- Feed through connection
- PLC-5 1771 conversion to pluggable connector(s)
- 10-, 12-, 18-, 21- or 40-point cards

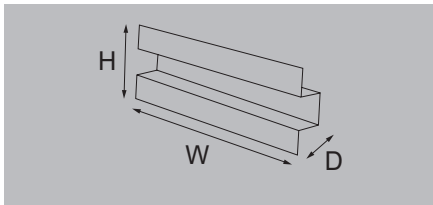

Technical data

Rated data	
Operating voltage	150 V
Max. current per channel	5 A
Ambient temperature (operational)	0...50 °C
Storage temperature	0...50 °C
Approvals	
Approvals	UR

SP-RS PLC PLC5 1771-WE/WF/WI



150 V
5 A
0...50 °C
0...50 °C
UR

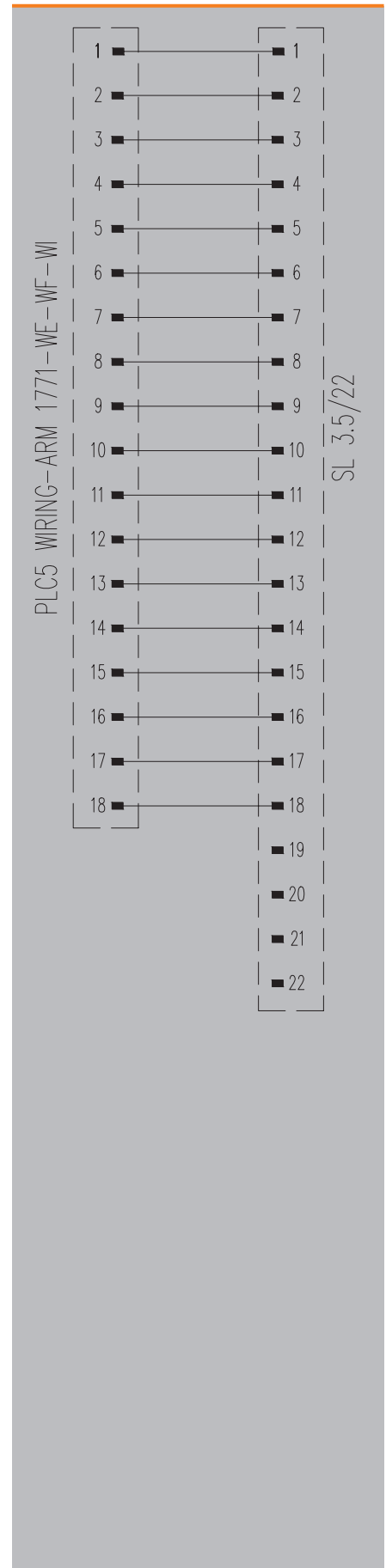

Dimensions
Width / Height / Depth

30 mm / 254 mm / 144 mm

Note
Max. current 10 A per whole assembly

Ordering data

Type	Qty.	Order No.
SP-RS PLC PLC5 1771-WI 18CH	1	6720001399

Note

Accessories

Note
Pluggable connector: 1277950000 - B2CF 3.50/22/180F SN BK BX

FAD – front adapters for migrations from Rockwell PLC-5 – Card System

Universal card adapters

- Feed through connection
- PLC-5 1771 conversion to pluggable connector(s)
- 10-, 12-, 18-, 21- or 40-point cards
- UR file E141197: 16 A total max., 120/240 V max. (split phase)

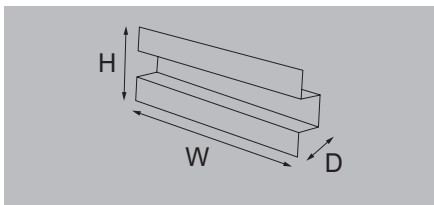

Technical data

Rated data	
Operating voltage	240 V
Max. current per channel	3 A
Ambient temperature (operational)	0...50 °C
Storage temperature	0...50 °C
Approvals	
Approvals	cURus

SP-RS PLC PLC5 1771-WG/WH/WHF/WHFB

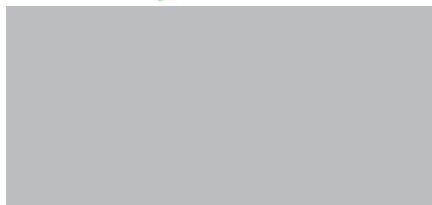

Operating voltage	240 V
Max. current per channel	3 A
Ambient temperature (operational)	0...50 °C
Storage temperature	0...50 °C
Approvals	
Approvals	cURus

PLC5 WIRING-ARM 1771-WG/H/F/FB

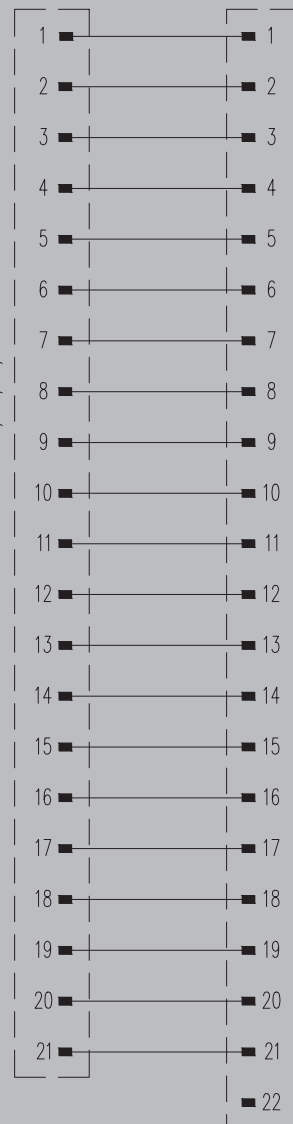

Dimensions
Width / Height / Depth

30 mm / 254 mm / 144 mm

Note

Ordering data

For WH/WHF/WHFB	SP-RS PLC5 1771-WH/WHF/WHFB 21CH, TIN+GO	7940125460
For WG	SP-RS PLC5 1771-WG 21CH, GOLD, WM	7940125466

Type	Qty.	Order No.
SP-RS PLC5 1771-WH/WHF/WHFB 21CH, TIN+GO		7940125460
SP-RS PLC5 1771-WG 21CH, GOLD, WM		7940125466

Note

Accessories

Note
Pluggable connector: 1277950000 - B2CF 3.50/22/180F SN BK BX

Pluggable connector: 1277950000 - B2CF 3.50/22/180F SN BK BX
--

Universal card adapters

- Feed through connection
- PLC-5 1771 conversion to pluggable connector(s)
- 10-, 12-, 18-, 21- or 40-point cards

SP-RS PLC PLC5 1771-WN

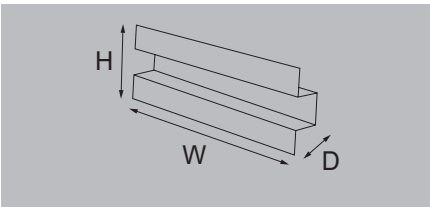

Technical data

Rated data	
Operating voltage	150 V
Max. current per channel	5 A
Ambient temperature (operational)	0...50 °C
Storage temperature	0...50 °C
Approvals	
Approvals	UR

150 V
5 A
0...50 °C
0...50 °C
UR

Dimensions
Width / Height / Depth

30 mm / 254 mm / 142 mm

Note
Max. current 10 A per whole assembly

Ordering data

Type	Qty.	Order No.
SP-RS PLC PLC5 1771-WN 40CH	1	6720001400

Note

Accessories

Note
Pluggable connectors: 1277950000 - B2CF 3.50/22/180F SN BK BX; 1277930000 - B2CF 3.50/18/180F SN BK BX

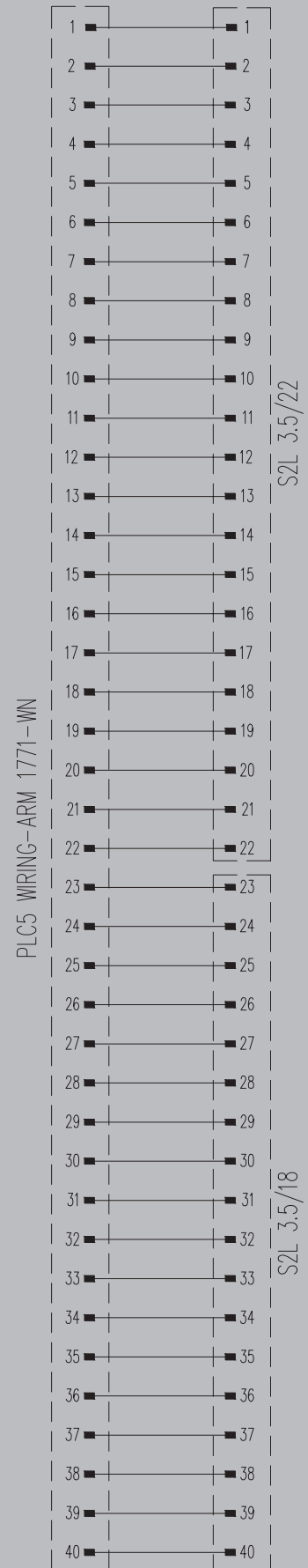

FAD – front adapters for migrations from Honeywell IPC620 – Card system

Front adapters for migration - Honeywell IPC620

Point-to-point connection

- Conversion between the IPC-620 connector to plug-in connector
- 12 and 22 points

IPC620 carrier

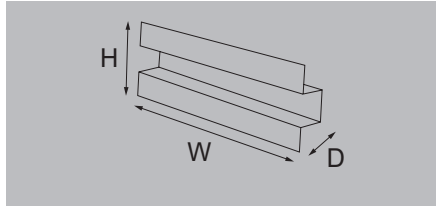

Technical data

Rated data	
Operating voltage	150 V
Max. current per channel	5 A
General data	
Ambient temperature (operational)	0...50 °C
Storage temperature	0...50 °C
Approvals	
Approvals	CE, UR

	150 V
	5 A
	0...50 °C
	0...50 °C
	CE, UR

Dimensions	
Width / Height / Depth	29 mm / 266 mm / 61 mm

	29 mm / 266 mm / 61 mm
--	------------------------

Note	
-------------	--

Ordering data

12-pole (reference Honeywell TB 621-9949)	Type	Qty.	Order No.
22-pole (Reference Honeywell TB 621-9950)	RS PLC IPC-620 12-POINTS	1	6720000787
	RS PLC IPC-620 22-POINTS	1	6720000788

	Type	Qty.	Order No.
	RS PLC IPC-620 12-POINTS	1	6720000787
	RS PLC IPC-620 22-POINTS	1	6720000788

Note	
-------------	--

Accessories

Note	Pluggable connector: 1748250000 - B2L 3.50/22/180F SN BK BX
-------------	---

--	--

	Pluggable connector: 1748250000 - B2L 3.50/22/180F SN BK BX
--	---

12-points IPC620 card adapter

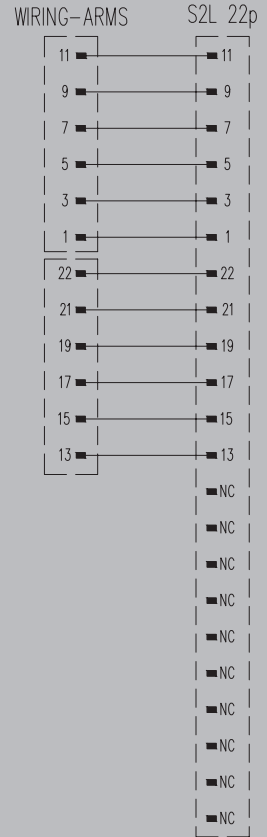

22-points IPC620 card adapter

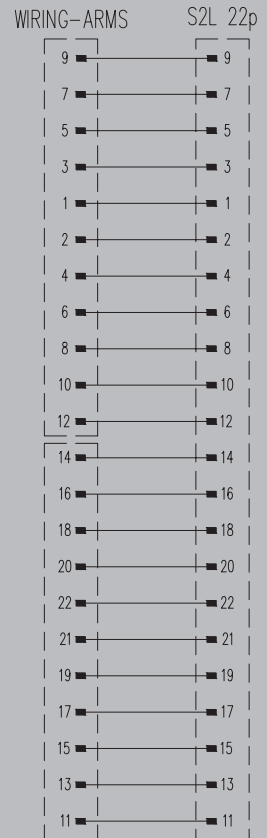

Front adapters for migration - Honeywell IPC620

Point-to-point connection

- Conversion between the IPC-620 connector to plug-in connector
- 38 points
- 12 A total max.

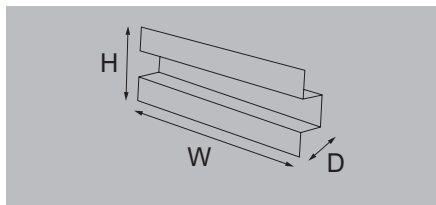

IPC620 carrier



Technical data

Rated data
Operating voltage
Max. current per channel
General data
Ambient temperature (operational)
Storage temperature
Approvals
Approvals

125 V
3 A
0...50 °C
0...50 °C
CE, UR

Dimensions
Width / Height / Depth

29 mm / 266 mm / 126 mm

Note

Ordering data

38-pole (reference Honeywell TB 621-9977 or -9976)
--

Type	Qty.	Order No.
RS PLC IPC-620 38-POINTS	1	6720001225

Note

Accessories

Note

Note

Pluggable connector: 1944510000 - BLZP 5.08HC/20/180F SN BK BX (2 units)
--

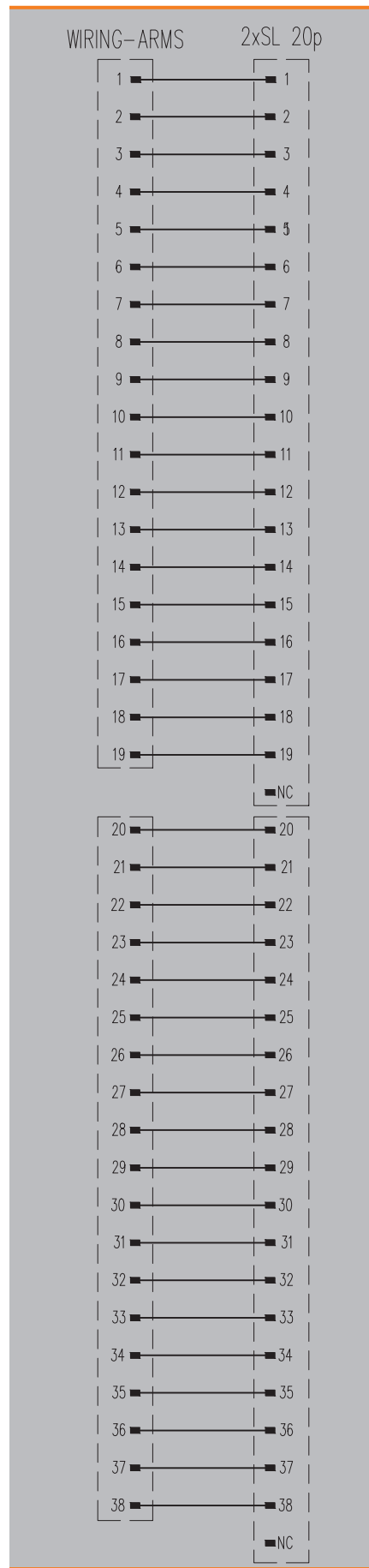

FAD – front adapters for migrations from Honeywell IPC620 – Card system

Front adapters for migration - Honeywell IPC620

Point-to-point connection

- Conversion between the IPC-620 connector to plug-in connector
- 24 points
- 12 A total max.

IPC620 carrier

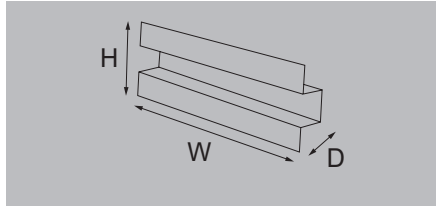

Technical data

Rated data
Operating voltage
Max. current per channel
General data
Ambient temperature (operational)
Storage temperature
Approvals
Approvals

50 V
3 A
0...50 °C
0...50 °C
CE, UR

Dimensions
Width / Height / Depth

266 mm / 29 mm / 50 mm

Note

Ordering data

24-pole (reference Honeywell TB 621-9954)

Type	Qty.	Order No.
RS PLC IPC-620 24-POINTS	1	6720001226

Note

Accessories

Note

Pluggable connector (not include with the Front adaptor): 1277970000 - B2CF 3.50/24/180F SN BK BX

WIRING-ARM

S2L 24p

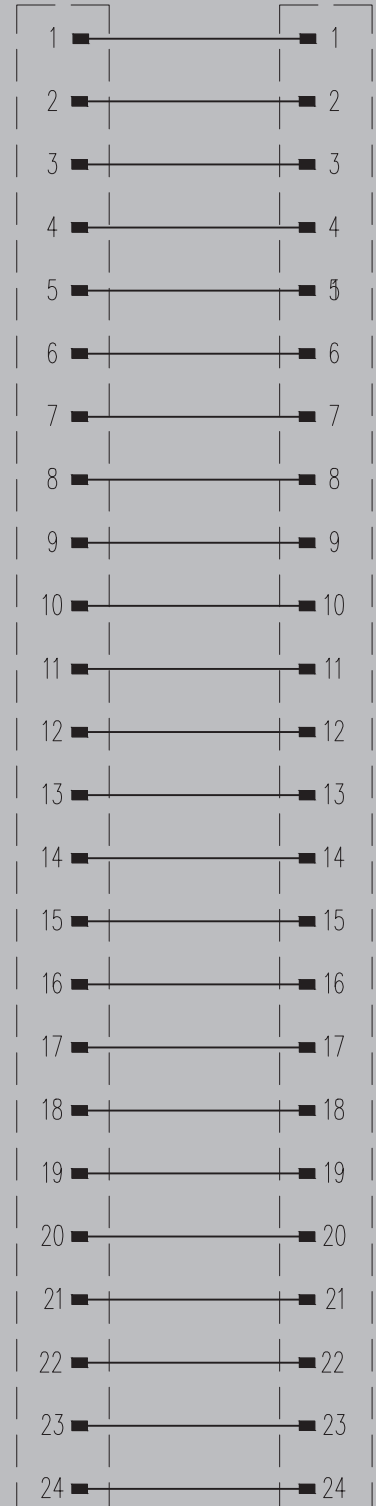

FAD – Front adapters for migrations - Schneider Quantum module

Point-to-point connection

- Conversion between the Quantum connector to connector S2CD-THR 3.5/20 (2 units)
- 40 points
- UR file 141197: 4 A per channel/point max., 32 A total max., 125 V max.

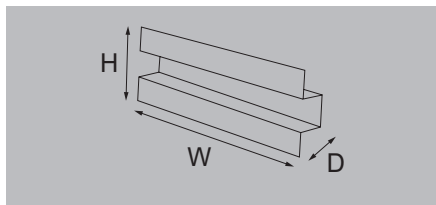

MODICON QUANTUM MIG MOD,40 POL



Technical data

General data
Ambient temperature (operational)
Storage temperature
Approvals
Approvals

0...50 °C
0...50 °C
CE, CURUS

Dimensions
Width / Height / Depth

41 mm / 250 mm / 76 mm

Note

UL File Number: E141197

Ordering data

--

Type	Qty.	Order No.
MODICON QUANTUM MIG MOD,40 POL	1	6720001822

Note

--

Accessories

Note

--

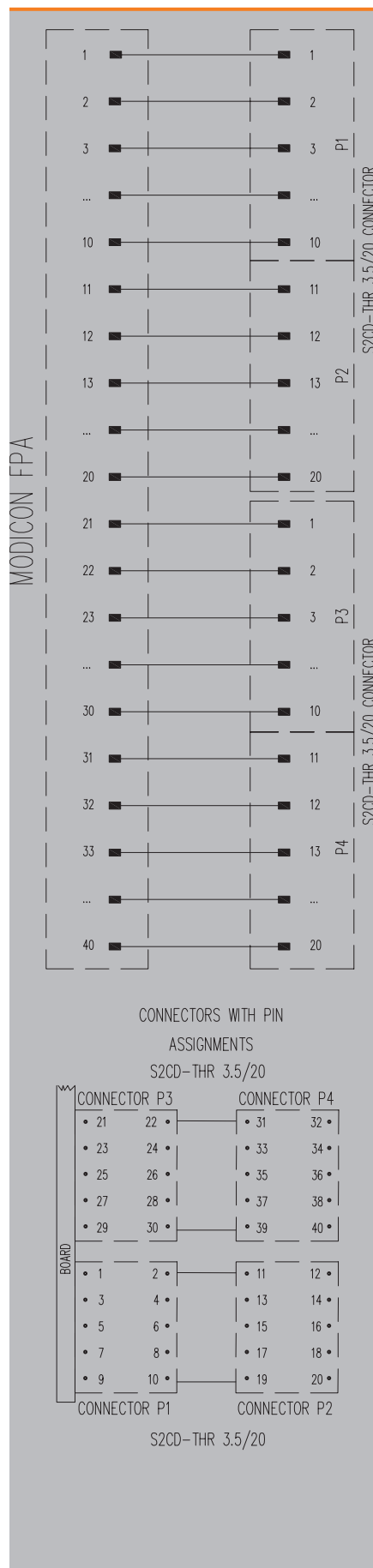

FAD – front adapters for migrations from Siemens APAC migration module – Card System

FAD – Front adapters for migrations - Siemens APAC migration module

Point-to-point connection

- Conversion between the Moore connector to 2 pluggable connectors 3.5 mm
- UR file 141197: 3 A per channel/point max. (12 channels), 36 A total max, 125 V max.
- C1 D2/Z2 T4A: 3 A per channel/point max. (8 channels), 24 A total max., 125 V max.
- 24 points

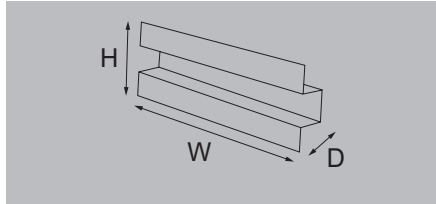

Technical data

General data	
Ambient temperature (operational)	0...50 °C
Storage temperature	0...50 °C
Approvals	
Approvals	CE, cURus

SP-Siemens APACs Migration Mod

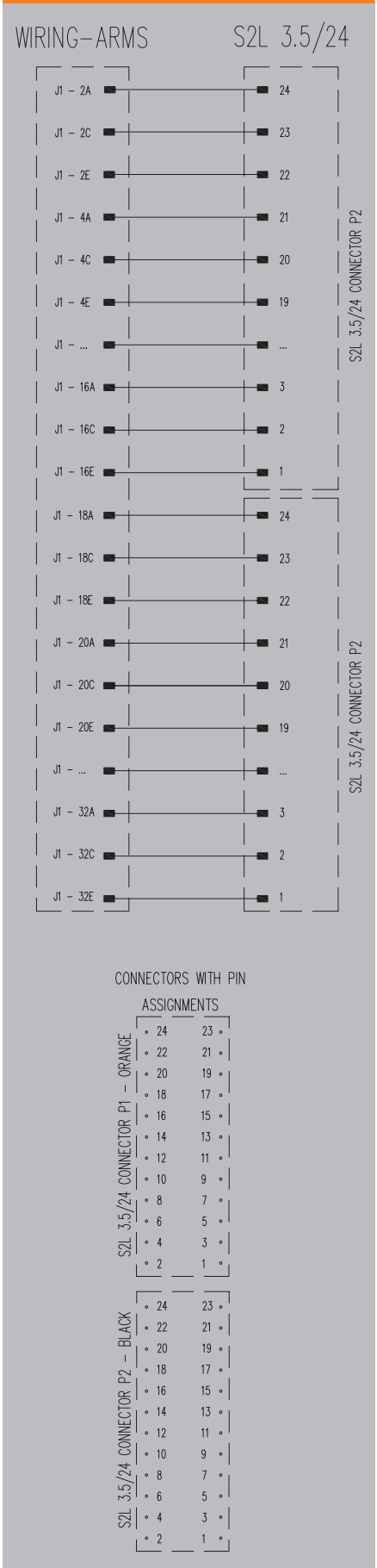
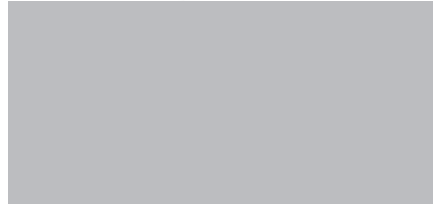

Dimensions
Width / Height / Depth

41 mm / 127 mm / 44 mm

Note
UL File Number: E141197; UL File Number Class 1 Div 2: E324123

Ordering data

Type	Qty.	Order No.
SP-Siemens APACs Migration Mod	1	7940121185

Note

Accessories

Note
To be used with 7508002174 rack. Pluggable connector (not include with the Front adaptor): 1277780000 - B2CF 3.50/24/180F SN OR BX (2 units)

RS F20 X – Redundancy interfaces

- Connection 1 to 1 for input interfaces
- Diode protection for output interfaces

RS F20 X3 IN

RS F20 X3 OUT

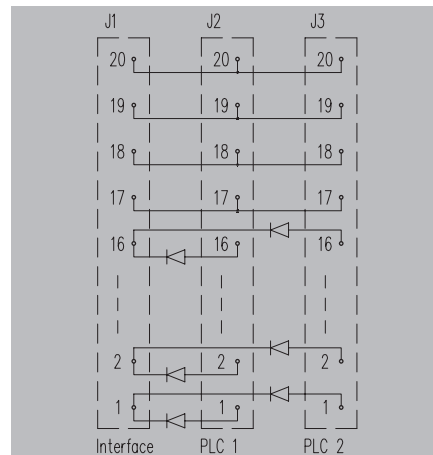
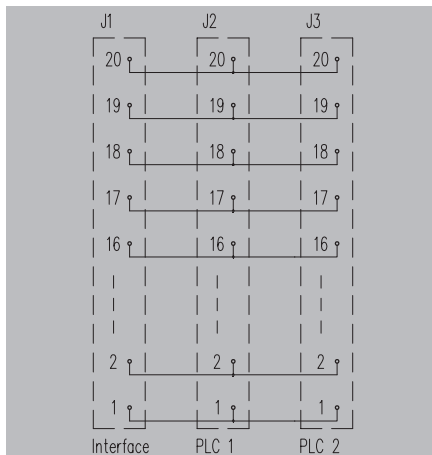
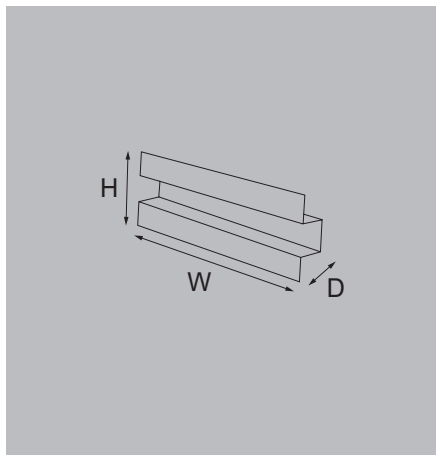

Technical data

Connection data	
Connection on control side	
Number of poles (control side)	20-pole
Earthing	No
Rated data	
Rated voltage	50 V AC / 70 V DC
Rated current per connection	0.5 A
Total operating current	3 A
General data	
Ambient temperature (operational)	-25...50 °C
Storage temperature	-40...60 °C
Approvals	CE
Insulation coordination (EN50178)	
Rated insulation voltage	50 V AC / 70 V DC
Surge voltage category	II
Pollution severity level	2
Insulation test voltage	0.35 kVAC

Connection data	
3 x plug-in connectors in acc. with IEC60603-13 / DIN41651	
20-pole	
Earthing	No
Rated data	
Rated voltage	50 V AC / 70 V DC
Rated current per connection	0.5 A
Total operating current	3 A
General data	
Ambient temperature (operational)	-25...50 °C
Storage temperature	-40...60 °C
Approvals	CE
Insulation coordination (EN50178)	
Rated insulation voltage	50 V AC / 70 V DC
Surge voltage category	II
Pollution severity level	2
Insulation test voltage	0.35 kVAC

Connection data	
3 x plug-in connectors in acc. with IEC60603-13 / DIN41651	
20-pole	
Earthing	No
Rated data	
Rated voltage	50 V AC / 70 V DC
Rated current per connection	0.5 A
Total operating current	3 A
General data	
Ambient temperature (operational)	-25...50 °C
Storage temperature	-40...60 °C
Approvals	CE
Insulation coordination (EN50178)	
Rated insulation voltage	50 V AC / 70 V DC
Surge voltage category	II
Pollution severity level	2
Insulation test voltage	0.35 kVAC

Dimensions

Rail	TS 35, TS 32
Width / Height	40 / 70 mm

Rail	TS 35, TS 32
Width / Height	40 / 70 mm

Rail	TS 35, TS 32
Width / Height	40 / 70 mm

Note

Ordering data

Type	Width	Order No.
without diode	40 mm	1461210000
with diode		

Type	Width	Order No.
RS F20 X3 IN	40 mm	1461210000

Type	Width	Order No.
RS F20 X3 OUT	40 mm	1461220000

Note

Accessories

Note	
------	--

Note

Note	
------	--

Note

Note	
------	--

Card holders

Card holders	Introduction	H.2
	Card holders	H.4

Card holders



Card holders are used for adapting Euro 19" format (100 x 160 mm) cards to plug-in connectors acc. to IEC 603/DIN 41612 and DIN 41617.

Cardholders can be used in industrial applications when:

- Adapting several 19" cards: As well as saving on the cost of a rack, accessibility is improved, because usually racks are only accessible from behind.
- The PCB card is in a remote position, making it difficult to install the cabling.
- It is necessary to extend legacy systems by adding more electronic modules.
- There are processes where quick replacement of the printed circuit and easy handling of connections is important.

Card holders have the following individual components:

- Snap-fit base and mechanism for securing the card
- Assembly plate and feet for direct assembly or for locking on DIN rails
- Printed circuit board where the following features can be identified:
 - Plug-in connectors acc. IEC 603/DIN 41612 and DIN 41617
 - Weidmüller terminals for screw connection



Card holders

SKH2 Card holders

Card holders are used for adapting Euro cards (19") to plug connectors to IEC 603/DIN 41612 and DIN 41617.

- Screw connection
- Installed on rail TS 35 with accessories

SKH2 31



SKH2 D32 LP

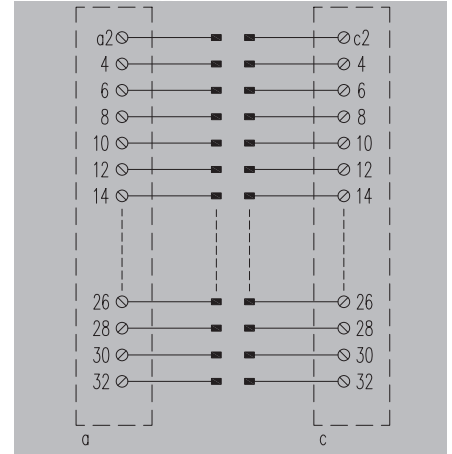
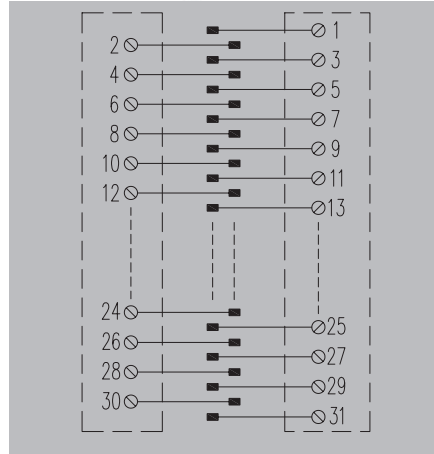
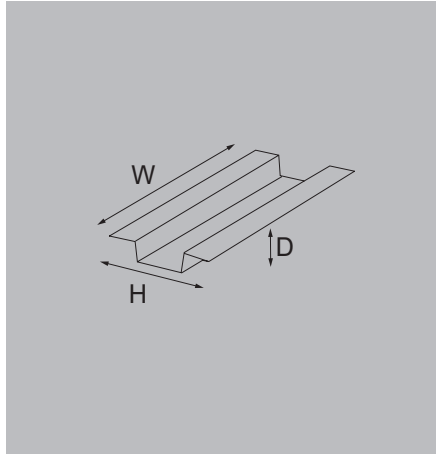

Technical data

Connection data	
Connection on control side	Plug-in connector, acc. to DIN 41617 female
Type (control side)	31-pole female
Number of poles (control side)	a and b
Contact assembly	100x160 mm euro format for 19" racks
Design of the pluggable board	
Rated data	
Rated voltage	125V AC / 150V DC
Rated current per connection	4 A
General data	
Ambient temperature (operational)	0...55 °C
Storage temperature	-40...60 °C
Approvals	CE
Insulation coordination	
Rated insulation voltage	< 150 V AC
Surge voltage category	II
Pollution severity level	2
Pulse voltage test (1,2/50µs)	1.5 kV

Connection data	
Connection on control side	Plug-in connector, acc. to DIN 41612 female
Type (control side)	32D
Number of poles (control side)	32-pole female
Contact assembly	a and c
Design of the pluggable board	100x160 mm euro format for 19" racks
Rated data	
Rated voltage	250 V UC
Rated current per connection	4 A
General data	
Ambient temperature (operational)	0...55 °C
Storage temperature	-40...60 °C
Approvals	CE
Insulation coordination	
Rated insulation voltage	250 V
Surge voltage category	II
Pollution severity level	2
Pulse voltage test (1,2/50µs)	2.1 kV

Dimensions

Clamping range, min./max.	0.5 mm ² / 6 mm ² 160 mm / 192.5 mm
---------------------------	--

Clamping range, min./max.	0.5 mm ² / 6 mm ² 160 mm / 192.5 mm
---------------------------	--

Note

Ordering data

Type	Qty.	Order No.
SKH2 31 LP	1	8174800000

Type	Qty.	Order No.
SKH2 D32 LP	1	8174830000

Note

Accessories

Note	Kit for connection to TS35 8209340000
------	---------------------------------------

Note	Kit for connection to TS35 8209340000
------	---------------------------------------

SKH2 F32 Z+B

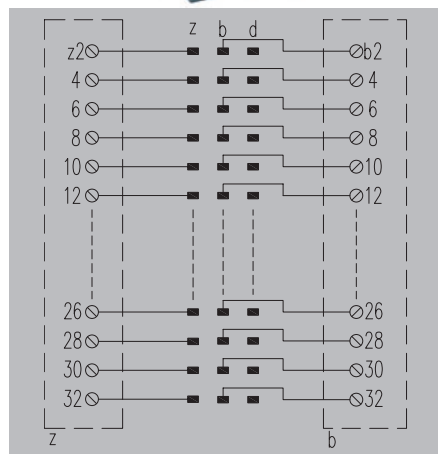

SKH2 F32 Z+D

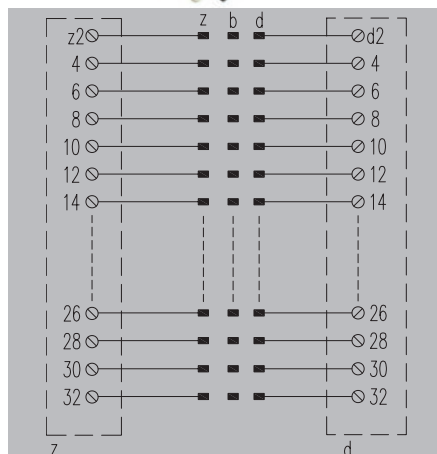

Plug-in connector, acc. to DIN 41612 female
32F
32-pole female
z and b
100x160 mm euro format for 19" racks
250 V UC
4 A
0...55 °C
-40...60 °C
CE
250 V
II
2
2.1 kV

Plug-in connector, acc. to DIN 41612 female
32F
32-pole female
z and d
100x160 mm euro format for 19" racks
250 V UC
4 A
0...55 °C
-40...60 °C
CE
250 V
II
2
2.1 kV

0.5 mm ² / 6 mm ²
160 mm / 192.5 mm

0.5 mm ² / 6 mm ²
160 mm / 192.5 mm

Type	Qty.	Order No.
SKH2 F32 (Z+B) LPP	1	8174850000

Type	Qty.	Order No.
SKH2 F32 (Z+D) LP	1	8174860000

Kit for connection to TS35 8209340000

Kit for connection to TS35 8209340000

Card holders

SKH

Card holders are used for adapting Euro cards (19") to plug connectors to IEC 603/DIN 41612 and DIN 41617.

- Screw connection
- Installed on rail TS 35 with accessories

SKH31



SKH31 250VAC

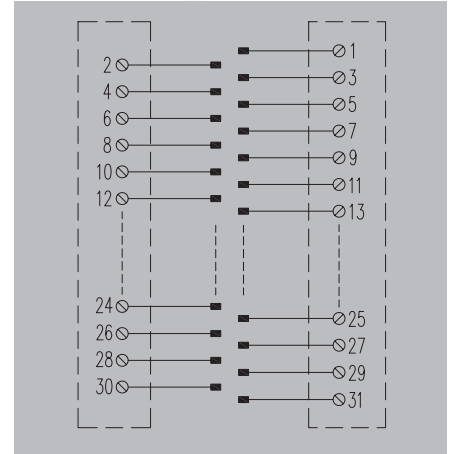
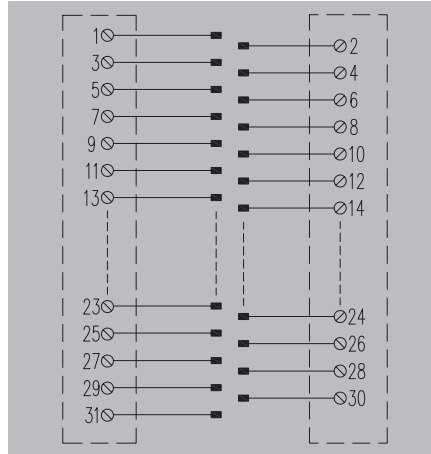
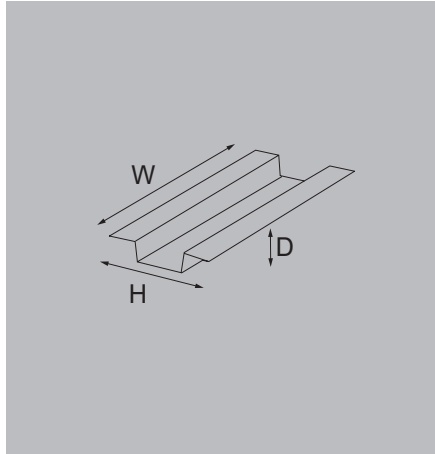

Technical data

Connection data	
Connection on control side	
Type (control side)	
Number of poles (control side)	
Contact assembly	
Design of the pluggable board	
Rated data	
Rated voltage	
Rated current per connection	
General data	
Ambient temperature (operational)	
Storage temperature	
Approvals	
Insulation coordination	
Rated insulation voltage	
Surge voltage category	
Pollution severity level	
Pulse voltage test (1,2/50µs)	

Plug-in connector, acc. to DIN 41617 female
31-pole female
a and b
100x160 mm euro format for 19" racks
125V AC / 150V DC
4 A
0...55 °C
-40...60 °C
CE
< 150 V AC
II
2
1.5 kV

Plug-in connector, acc. to DIN 41617 female
31-pole female
a and b
100x160 mm euro format for 19" racks
250 V UC
4 A
0...55 °C
-40...60 °C
CE
250 V
II
2
2.1 kV

Dimensions

Clamping range, min./max.	
---------------------------	--

0.5 mm ² / 6 mm ²
131 mm / 144 mm

0.5 mm ² / 6 mm ²
131 mm / 144 mm

Note

Ordering data

1 clamping bracket	
2 clamping brackets	

Type	Qty.	Order No.
SKH 31 LP RH1	1	0586661001

Type	Qty.	Order No.
SKH 31 LP 250VAC RH1	1	0648661001

Note

Accessories

Note	
------	--

Kit for connection to TS35. Installation motherboard 2054280000 and mounting foot to TS35 0687900000
--

Kit for connection to TS35. Installation motherboard 2054280000 and mounting foot to TS35 0687900000
--

SKH B64

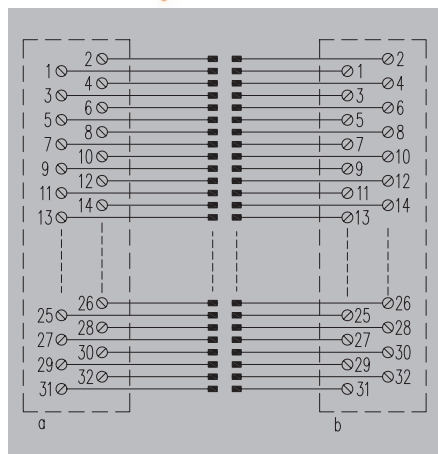

SKH C64

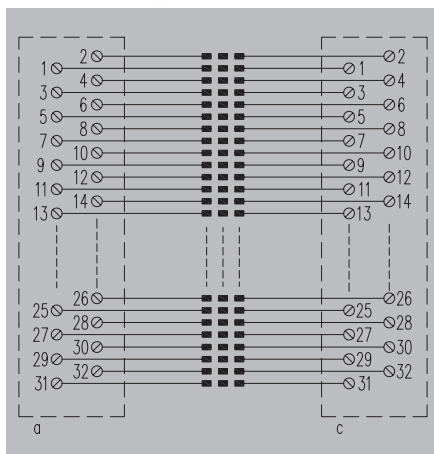

SKH D32

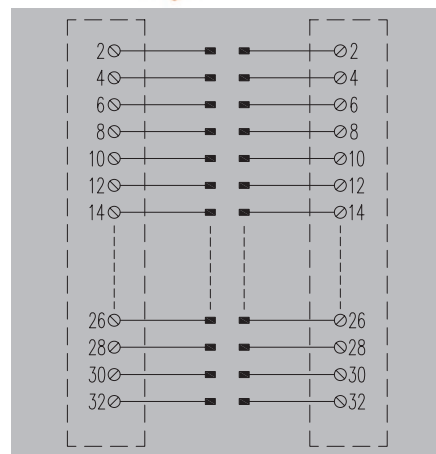

Plug-in connector, acc. to DIN 41612 female
B64
64-pole female
a and b
100x160 mm euro format for 19" racks
125V AC / 150V DC
1 A
0...55 °C
-40...60 °C
CE
< 150 V AC
II
2
1.5 kV

Plug-in connector, acc. to DIN 41612 female
64C
64-pole female
a and c
100x160 mm euro format for 19" racks
125V AC / 150V DC
1 A
0...55 °C
-40...60 °C
CE
< 150 V AC
II
2
1.5 kV

Plug-in connector, acc. to DIN 41612 female
32D
32-pole female
a and c
100x160 mm euro format for 19" racks
250 V UC
4 A
0...55 °C
-40...60 °C
CE
250 V
II
2
2.1 kV

0.5 mm ² / 6 mm ²
131 mm / 144 mm

0.5 mm ² / 6 mm ²
131 mm / 144 mm

0.5 mm ² / 6 mm ²
131 mm / 144 mm

Type	Qty.	Order No.
SKH B64 RH2	1	0577360000

Type	Qty.	Order No.
SKH C64 RH2	1	0646660000
SKH C64 RH2	1	0178960000

Type	Qty.	Order No.
SKH D32 LP 5/16 RH2	1	0586761001

Kit for connection to TS35: Installation motherboard 2054280000 and mounting foot to TS35 0687900000

Kit for connection to TS35: Installation motherboard 2054280000 and mounting foot to TS35 0687900000

Kit for connection to TS35: Installation motherboard 2054280000 and mounting foot to TS35 0687900000

Card holders

SKH

Card holders are used for adapting Euro cards (19") to plug connectors to IEC 603/DIN 41612 and DIN 41617.

- Screw connection
- Installed on rail TS 35 with accessories

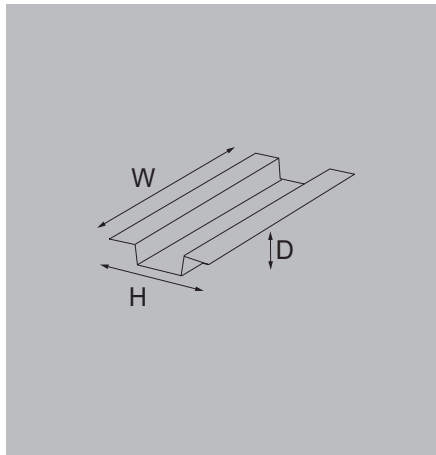

SKH E48

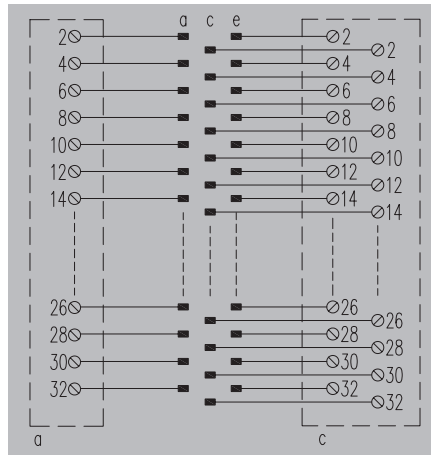

SKF F32 Z+B

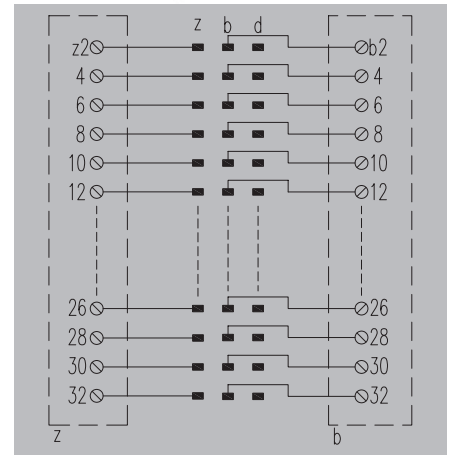

Technical data

Connection data	
Connection on control side	
Type (control side)	
Number of poles (control side)	
Contact assembly	
Design of the pluggable board	
Rated data	
Rated voltage	
Rated current per connection	
General data	
Ambient temperature (operational)	
Storage temperature	
Approvals	
Insulation coordination	
Rated insulation voltage	
Surge voltage category	
Pollution severity level	
Pulse voltage test (1,2/50µs)	

Plug-in connector, acc. to DIN 41612 female
48E
48-pole female
e, c, a
100x160 mm euro format for 19" racks
125V AC / 150V DC
4 A
0...55 °C
-40...60 °C
CE
< 150 V AC
II
2
1.5 kV

Plug-in connector, acc. to DIN 41612 female
32F
32-pole female
z and b
100x160 mm euro format for 19" racks
250 V UC
4 A
0...55 °C
-40...60 °C
CE
250 V
II
2
2.1 kV

Dimensions

Clamping range, min./max.

0.5 mm ² / 6 mm ²
131 mm / 144 mm

0.5 mm ² / 6 mm ²
131 mm / 144 mm

Note

Ordering data

1 clamping bracket
2 clamping brackets

Type	Qty.	Order No.
SKH E48 LP2/LP	1	0690660000

Type	Qty.	Order No.
SKH F32 (Z&B) LP RH2	1	0586861001

Note

Accessories

Note

Kit for connection to TS35. Installation motherboard 2054280000 and mounting foot to TS35 0687900000
--

Kit for connection to TS35. Installation motherboard 2054280000 and mounting foot to TS35 0687900000
--

SKF F32 Z+D

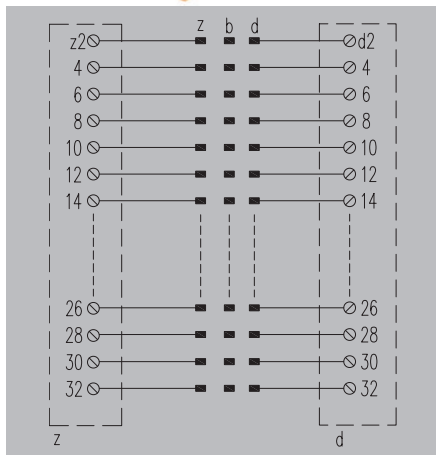

Plug-in connector, acc. to DIN 41612 female
32F
32-pole female
z and d
100x160 mm euro format for 19" racks
250 V UC
4 A
0...55 °C
-40...60 °C
CE
250 V
II
2
2.1 kV

0.5 mm ² / 6 mm ²
131 mm / 144 mm

Type	Qty.	Order No.
SKH F32 (Z&D) LP RH2	1	0586961001

Kit for connection to TS35: Installation motherboard 2054280000 and mounting foot to TS35 0687900000

SKH F48

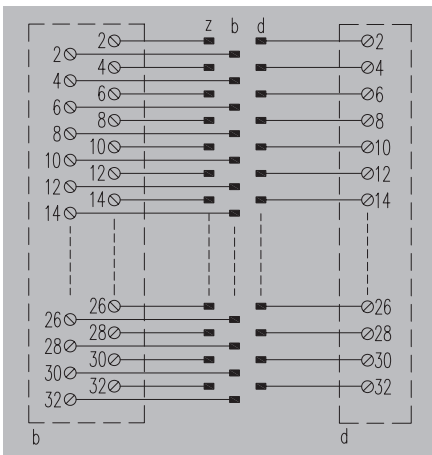

Plug-in connector, acc. to DIN 41612 female
48F
48-pole female
z, b, d
100x160 mm euro format for 19" racks
125V AC / 150V DC
4 A
0...55 °C
-40...60 °C
CE
< 150 V AC
II
2
1.5 kV

0.5 mm ² / 6 mm ²
131 mm / 144 mm

Type	Qty.	Order No.
SKH F48	1	0587060000

Kit for connection to TS35: Installation motherboard 2054280000 and mounting foot to TS35 0687900000

Card holders

SKH

Card holders are used for adapting Euro cards (19") to plug connectors to IEC 603/DIN 41612 and DIN 41617.

- Screw connection
- Installed on rail TS 35 with accessories

SKH H15

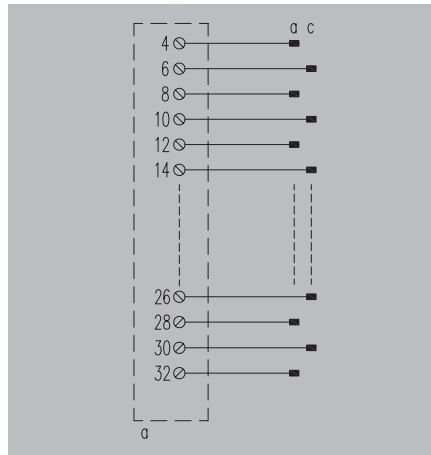
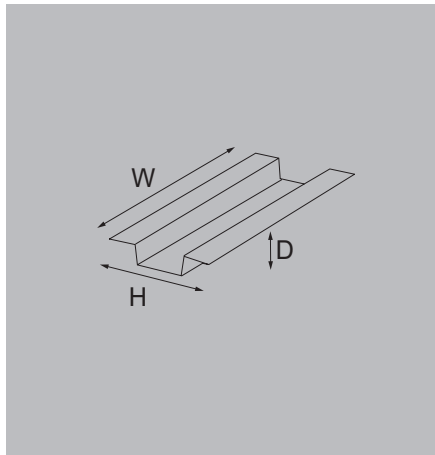

Technical data

Connection data

Connection on control side
 Type (control side)
 Number of poles (control side)
 Contact assembly
 Design of the pluggable board

Plug-in connector, acc. to DIN 41612 female
 15H
 15-pole female
 a and c
 100x160 mm euro format for 19" racks

Rated data

Rated voltage
 Rated current per connection

250 V UC
 10 A

General data

Ambient temperature (operational)
 Storage temperature
 Approvals

0...55 °C
 -40...60 °C
 CE

Insulation coordination

Rated insulation voltage
 Surge voltage category
 Pollution severity level
 Pulse voltage test (1,2/50µs)

250 V
 II
 2
 2.1 kV

Dimensions

Clamping range, min./max.

0.5 mm² / 6 mm²
 131 mm / 144 mm

Note

Ordering data

1 clamping bracket
 2 clamping brackets

Type	Qty.	Order No.
SKH H15S	1	8051300000

Note

Accessories

Note

Kit for connection to TS35: Installation motherboard 2054280000 and mounting foot to TS35 0687900000

SKH x 2

Card holders are used for adapting Euro cards (19") to plug connectors to IEC 603/DIN 41612 and DIN 41617.

- Screw connection
- Installed on rail TS 35 with accessories

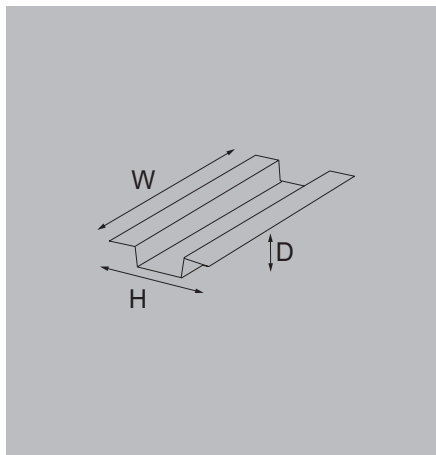

SKH 2XC64 A+C

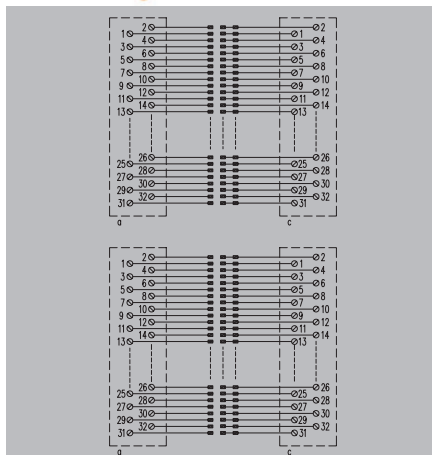

SKH 2XD32 A+C

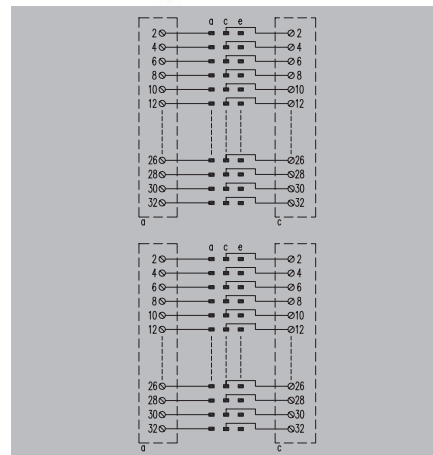

Technical data

Connection data	
Connection on control side	Plug-in connector, acc. to DIN 41612 female
Type (control side)	64C
Number of poles (control side)	64-pole female
Contact assembly	a and c
Design of the pluggable board	233x160 mm double euro format for 19" enclosures
Rated data	
Rated voltage	125V AC / 150V DC
Rated current per connection	1 A
General data	
Ambient temperature (operational)	0...55 °C
Storage temperature	-40...70 °C
Approvals	CE
Insulation coordination	
Rated insulation voltage	125 V AC
Surge voltage category	II
Pollution severity level	2
Pulse voltage test (1,2/50µs)	1.1 kV

Connection data	
Connection on control side	Plug-in connector, acc. to DIN 41612 female
Type (control side)	32D
Number of poles (control side)	32-pole female
Contact assembly	a and c
Design of the pluggable board	233x160 mm double euro format for 19" enclosures
Rated data	
Rated voltage	125V AC / 150V DC
Rated current per connection	4 A
General data	
Ambient temperature (operational)	0...55 °C
Storage temperature	-40...70 °C
Approvals	CE
Insulation coordination	
Rated insulation voltage	125 V AC
Surge voltage category	II
Pollution severity level	2
Pulse voltage test (1,2/50µs)	1.1 kV

Connection data	
Connection on control side	Plug-in connector, acc. to DIN 41612 female
Type (control side)	32D
Number of poles (control side)	32-pole female
Contact assembly	a and c
Design of the pluggable board	233x160 mm double euro format for 19" enclosures
Rated data	
Rated voltage	125V AC / 150V DC
Rated current per connection	4 A
General data	
Ambient temperature (operational)	0...55 °C
Storage temperature	-40...70 °C
Approvals	CE
Insulation coordination	
Rated insulation voltage	125 V AC
Surge voltage category	II
Pollution severity level	2
Pulse voltage test (1,2/50µs)	1.1 kV

Dimensions

Clamping range, min./max.	0.5 mm ² / 6 mm ² 286 mm / 144 mm
---------------------------	--

Clamping range, min./max.	0.5 mm ² / 6 mm ² 286 mm / 144 mm
---------------------------	--

Clamping range, min./max.	0.5 mm ² / 6 mm ² 286 mm / 144 mm
---------------------------	--

Note

Ordering data

1 clamping bracket

Type	Qty.	Order No.
SKH C64*2 (A&C) RH2	1	8013120000

Type	Qty.	Order No.
SKH D32*2 LP5.08/16 RH2	1	8050981001

Note

Accessories

Note

Kit for connection to TS35: Installation motherboard 2051430000 and mounting foot TS35 0687900000

Kit for connection to TS35: Installation motherboard 2051430000 and mounting foot TS35 0687900000

Service and support

Service and support	Service connects - worldwide	V.2
	Engineering services and customised products	V.3
	easyConnect - Your Industrial Service Platform	V.4
	Support Center	V.6
	Additional support services	V.7
	Weidmüller Configurator: intuitive, uncomplicated & fast digital engineering	V.8
	Information regarding the product images in this catalogue	V.10

Our expertise for your requirements

Service connects – worldwide



Automation technology functions are becoming more complex in a globally-oriented world facing ambitious targets in terms of energy efficiency and smart production. We are your equal partners for the best connections in Industrial Connectivity.

Our personal support answers all questions reliably and expertly. During planning, installation or operation our service and support offer is your best companion.

In short: Weidmüller's global service combines our expertise with your requirements.

V



Your way to our service
www.weidmueller.com/service

Engineering services and customised products

Automation engineering and connectivity consulting belongs to our services as well as assembly of engineered products. We also support the process from the idea to the product with our Weidmüller Configurator and the Configure-to-Order process.



Consulting and engineering

The challenge for you is reducing costs and increasing efficiency. This requires intelligent, individual solutions. Whether it is modified products, pre-fitted mounting rails or complete small cabinets – our application centres provide a highly qualified custom-made engineering and production service.



Connectivity Consulting

Increase your competitiveness - supported by our experts. Our drive is to optimise your competitiveness. That's why our team of experts supports you in significantly increasing your efficiency in electrical machine design and control cabinet construction. With proven products and services from the Weidmüller portfolio – and with the experience gained from over 300 projects worldwide.



Assembled terminal rails - Flexibly designed to suit your requirements

Your processes in panel building have to be fast, flexible and productive. This is the only way you can cut your costs and increase efficiency. Depending on the application in question, you will have different requirements with respect to the engineering service, delivery speed and flexibility to be provided.



Modified and assembled enclosures - Competitive advantages included

To compete internationally, your plants need to satisfy high standards of safety, quality and performance. The smart combination of consultation, application expertise and industry know-how is our key to finding a custom-fit solution for your application. Reduce costs and increase efficiency.

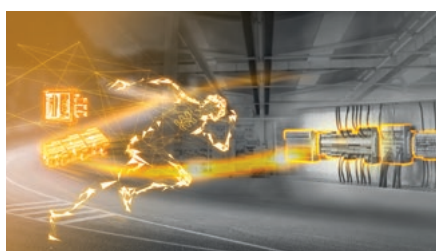

Fast Delivery Service - Your ideas deserve a quick realisation

Obtain offers 24/7 and within minutes, including directly orderable article numbers with our Fast Delivery Service. The Weidmüller Configurator (WMC) for planning and configuration is key for consistent processes. Dispatch your orders in 5 days. Assemble individual terminal strips and enclosures from batch size 1!

Your ticket to the world of digital service

easyConnect – Your Industrial Service Platform



Our cloud-based platform is your ticket to the world of digital services from Weidmüller, and the intuitive and future-proof tool for your way to the Industrial IoT. Realise your use cases easily, consistently and without any relevant prior knowledge, thanks to the perfect interaction of platform, devices and diverse software services.

As an open, modular and perfectly integrable system, the platform is your enabler for a wide range of use cases. Increase your efficiency and unleash your full innovation potential with easyConnect.

V



Interested in using easyConnect?

Learn how to get started with easyConnect step-by-step.

www.weidmueller.com/easyconnect

Why should you use easyConnect?

- You want to enter your digital transformation step-by-step?
- You want to make the step into Industrial IOT, but have no or little IT expertise?
- You want to use your digital data for smart & scalable services?
- You want to offer digital services (such as customised dashboard) to your customers?
- You want to improve your service offering and efficiency, e.g. through remote access?
- You feel Weidmüller's digital services are interesting, but you have „your cloud“ already?



Weidmüller comes up with the solution: easyConnect, the new digitalisation platform. It bundles Weidmüller's digital services at one place in the cloud and connects them with various Weidmüller devices.

With easyConnect you start digitalising your application step-by-step without ballast in a secure way.

The following services are initially available on easyConnect:

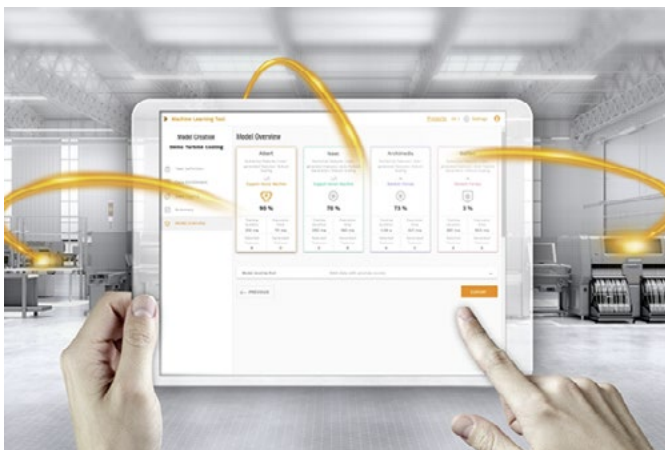

Device management

Adding and managing cloud-connected devices is typically the first step in any Industrial IoT use case.

Asset management

The asset management service is a modelling tool that allows users to model their assets and processes and link them to relevant time series data.

Remote access (u-link)

u-link guarantees a quick and secure access to machines and plants while also allowing for efficient management.

Data visualisation

easyConnect data visualisation services enable users to view, monitor and display live and historical data.

AutoML

With Weidmüller Industrial AutoML, you can optimize operations, increase product quality and develop new business models by benefiting from advanced analytics.

Expand the possibilities of our products

Our Support Center provides you with comprehensive, clear and personal assistance



Receive fast and intuitive support to get the most out of our products in your application. In our new Support Center you can search or navigate to the many application notes, product information, video tutorials or software downloads of our products.

- **Everything at a glance** – One central support hub, where all relevant information is available
- **Powerful search** – Provides filter functions for various types of information and products
- **Different views and navigations** – Content provided in views product information, engineering support or software downloads
- **More than 170,000 downloads** – Application notes, video tutorials, templates and examples, user documentation, engineering data, ...
- **Personal contact** – Direct access to your personal technical contact in your country



Explore the world of our new Support Center
support.weidmueller.com

Additional support services

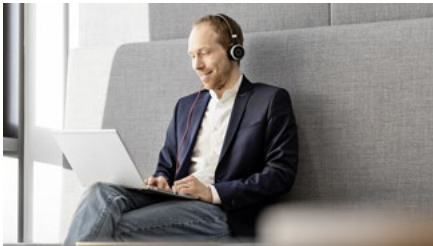

Training and Webinars

Stay tuned in a world that is accelerating. In our entertaining interactive webinars, we offer you the opportunity to learn about new products and technology topics and to interact with our experts.



Repairs and replacement parts

We offer repair and components for our Workplace Solutions as well as assistance for other Weidmüller products. Find out how our experts can help you with your repair request.



Security advisory board

Our Product Security Incident Response Team (PSIRT) continuously informs you about possible security-related vulnerabilities of our products.



Engineering data

For the quick integration of our products into your design, there are a lot of digital product data for engineering systems like EPLAN, Zuken E3.series, WSCAD and many others available for download.

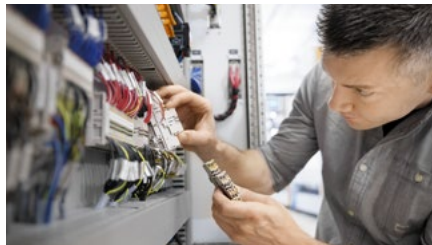

Product change notifications

Technical modifications of our products always available online.



Technical product catalogues

Technical data for our entire program in Industrial Connectivity for download in PDF-format.

From the idea to the finished solution

Weidmüller Configurator: intuitive, uncomplicated & fast digital engineering

Digital engineering can be so easy – with the Weidmüller Configurator!

It's a **free to use** software application to easily configure industrial solutions. It features more than **12,000 articles** from multiple product families including rail-mounted components, industrial and ex-certified enclosures, Heavy Duty Connectors, remote I/O-systems and PCB connectors.

Unleash the full power of digital engineering:

Our application wizards help you choose the right articles.

Place, mark or modify them to your needs and get your solution **visualized in 3D** – what you see is what you get!

Our promise: Speed up your solution planning process by up to 70%!

Your benefits:

- **Proven configuration designs in real 3D:** The plausibility and collision check with the complete digital documentation ensures that you can rely 100% on your configuration.
- **Seamless E-CAD Roundtrip:** Interfaces enable the simple exchange of product data between the WMC and all common engineering tools, such as Zuken E3 or EPLAN Electric P8.
- **Sample Service & Fast Delivery Service:** to support your design-in process, we offer a **3-day sample service** for many products. Inquire them directly online – for free!
You want your solution right away? Our **Fast Delivery Service** guarantees delivery of individually assembled terminal strips or enclosures within a few days.

Get started online now!

The Weidmüller Configurator makes solution planning easy. Visit our website for more information, tutorials and download it for free:



www.weidmueller.com/wmc



or register on easyconnect.weidmueller.com and use it online.



Wizards:

Design complete applications within few clicks – even without detailed product knowledge – for signal wiring, load monitoring, instrument transformers, enclosures, remote I/O-systems and many more.

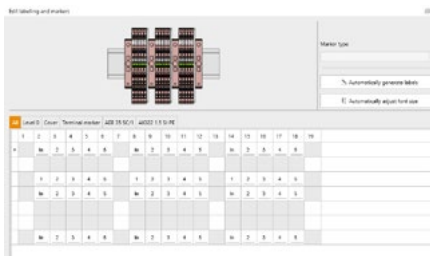

Assistants:

Finalize your solutions with supporting assistants to add cross-connectors, markers or colors and verify the faultlessness. Automatic modes save valuable time!



1-click documentation:

Get assembly drawings for production – only 1 click. Bill of material – only 1 click. The complete solution documentation including all component data sheets – you’re right, only 1 click!



Information regarding the product images in this catalogue

This catalogue has been developed while upgrading most of our SCREW interfaces to new PCB connectors. For this reason, some images in the catalogue might have slightly differences as described below.

Until now, most of the products were delivered with DEKAFIX/WS. This marker type will be replaced by tampoprint technology or in some cases by KSW strip markers.

DEKAFIX/WS

Flexible connector markers – print, clip, finished



Tampo printed

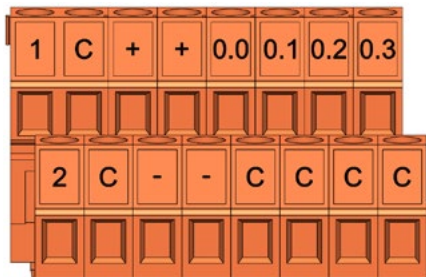

KSW

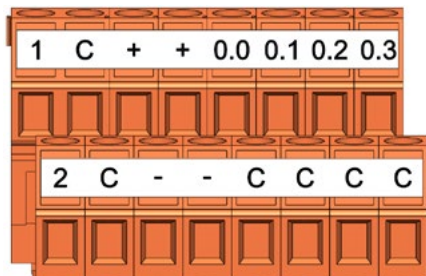

Index

Index	Index Type	X.2
	Index Order No.	X.6
	Addresses worldwide	X.10

Type	Order No.	Page
------	-----------	------

B

BKP-16D0-SDV541-V0-S	2461730000	C.30
BKP-16D0-SDV541-V1-S	2436230000	C.30

C

C300-16B-160B-2S-M25-1M	1481690010	B.17
C300-16B-160B-2S-M34-1M	1481710010	B.17
C300-16B-160B-2S-M50-1M	1481720010	B.17
C300-16B-F-2S-M25-1M	1481740010	B.18
C300-16B-F-2S-M34-1M	1481750010	B.18
C300-16B-F-2S-M50-1M	1481760010	B.18
C300-32B-216B-2S-M25-1M	2699000010	B.19
C300-32B-216B-2S-M34-1M	2699010010	B.19
C300-32B-216B-2S-M50-1M	2699020010	B.19
C300-32B-320B-2S-M25-1M	7789829010	B.13
C300-32B-320B-2S-M34-1M	7789898010	B.13
C300-32B-320B-2S-M50-1M	7789838010	B.13
C300-32B-F-2S-M25-1M	1349350010	B.15
C300-32B-F-2S-M34-1M	7789617010	B.15
C300-32B-F-2S-M50-1M	7789895010	B.15
C300-36B-324B-2S-M25-1M	7789829010	B.14
C300-36B-324B-2S-M34-1M	7789891010	B.14
C300-36B-324B-2S-M50-1M	7789892010	B.14
C300-36B-F-2S-M25-1M	1349370010	B.16
C300-36B-F-2S-M34-1M	1373780010	B.16
C300-36B-F-2S-M50-1M	1373820010	B.16

F

FAD 1771-WA/WC SL10 M	2448650000	G.10
FAD 1771-WA/WC SL10 M US	7940125447	G.29
FAD 1771-WB/WD SL12 M	2448680000	G.10
FAD 1771-WB/WD SL12 M US	7940125450	G.29
FAD 1771-WF SL18 M	2448690000	G.10
FAD 1771-WF SL18 M US	7940125451	G.31
FAD 1771-WG SL21 M	2563110000	G.10
FAD 1771-WG SL21 M US	7940125452	G.30
FAD 1771-WH SL21 M	2448660000	G.10
FAD 1771-WH SL21 M US	7940125448	G.10
FAD 1771-WN S2L20 M	2448670000	G.10
FAD 1771-WN S2L20 M US	7940125449	G.32
FAD BLK1 HE20 16I M	1985940000	G.9
FAD BLK1 HE20 16I M US	1985940000	G.9
FAD BLK1 HE20 16I M	1985940000	G.20
FAD BLK1 HE20 16I M US	1985950000	G.20
FAD BLK1 HE20 16I M	1985950000	G.10
FAD BLK1 HE20 16I M US	1985950000	G.21
FAD BLK1 SL24 M	1985930000	G.10
FAD BLK1 SL24 M US	1985930000	G.10
FAD BLK1 SL24 M	1985930000	G.22
FAD BLK4 2XSL20	24494590000	G.10
FAD BLK4 2XSL20	24494590000	G.25
FAD BLK7 2XHE20 M	1985960000	G.9
FAD BLK7 2XHE20 M US	1985960000	G.10
FAD BLK7 2XHE20 M	1985960000	G.23
FAD BLK9 2XHE20 M	1985970000	G.9
FAD BLK9 2XHE20 M US	1985970000	G.10
FAD BLK9 2XHE20 M	1985970000	G.24
FAD PREM 2SD25F	8000070315	G.28
FAD PREM 2SD25F	8000070315	G.28
FAD PREM 4HE20	8000070314	G.27
FAD PREM 4HE20	8000070314	G.27
FAD PREM BLY01	8000070313	G.26
FAD PREM BLY01	8000070313	G.26
FAD S5115 2XHE20 32I0 M	1991730000	G.5
FAD S5115 2XHE20 32I0 M US	1991730000	G.5
FAD S5115 2XHE20 32I0 M	1991730000	G.13
FAD S5115 HE20 16I0 M	1986010000	G.5
FAD S5115 HE20 16I0 M US	1986010000	G.5
FAD S5115 HE20 16I0 M	1986010000	G.12
FAD S5115 SL24 M	1985980000	G.5
FAD S5115 SL24 M US	1985980000	G.10
FAD S5115 SL24 M	1985980000	G.14
FAD S5115 SL46 A M	2045120000	G.5
FAD S5115 SL46 A M US	2045120000	G.5
FAD S5115 SL46 A M	2045120000	G.15
FAD S5135 2XHE20 32I0 R	1986050000	G.7
FAD S5135 2XHE20 32I0 R US	1986050000	G.7
FAD S5135 2XHE20 32I0 R	1986050000	G.17
FAD S5135 HE20 16I0 R	1986040000	G.7
FAD S5135 HE20 16I0 R US	1986040000	G.10
FAD S5135 HE20 16I0 R	1986040000	G.16
FAD S5135 SL20 R	1986030000	G.7
FAD S5135 SL20 R US	1986030000	G.10
FAD S5135 SL20 R	1986030000	G.18
FAD S5135 SL42 A R	2435110000	G.10
FAD S5135 SL42 A R US	2435110000	G.15
FTA-C300-16AI-SH-S	1247120000	B.9
FTA-C300-16AI-SH-S	1247120000	B.8
FTA-C300-16AI-SH-Z	1247130000	B.8
FTA-C300-16AI-SH-Z	1247130000	B.5
FTA-C300-16AI-TEST-S	1247140000	B.8
FTA-C300-16AI-TEST-S	1247140000	B.8
FTA-C300-16AI-TEST-Z	1247150000	B.8
FTA-C300-16AI-TEST-Z	1247150000	B.5
FTA-C300-16AO-SHP	1223010000	B.5
FTA-C300-16AO-SHP	1223010000	B.9

Type	Order No.	Page
------	-----------	------

FTA-C300-16AO-SH-S	1222980000	B.5
FTA-C300-16AO-SH-S	1222980000	B.9
FTA-C300-16AO-SH-Z	1222990000	B.5
FTA-C300-16AO-SH-Z	1222990000	B.9
FTA-C300-16AO-TEST-S	1223020000	B.5
FTA-C300-16AO-TEST-S	1223020000	B.9
FTA-C300-16AO-TEST-Z	1223030000	B.5
FTA-C300-16AO-TEST-Z	1223030000	B.9
FTA-C300-16AO-TP-Z	2000020000	B.5
FTA-C300-16AO-TP-Z	2000020000	B.10
FTA-C300-16DAI-SH-S	1415220000	B.5
FTA-C300-16DAI-SH-S	1415220000	B.10
FTA-C300-16DAI-SH-Z	1415230000	B.5
FTA-C300-16DAI-SH-Z	1415230000	B.10
FTA-C300-32DI-24VDC-S	1312040000	B.5
FTA-C300-32DI-24VDC-S	1312040000	B.11
FTA-C300-32DI-LD-S	1222940000	B.5
FTA-C300-32DI-LD-S	1222940000	B.6
FTA-C300-32DI-LD-Z	1222950000	B.5
FTA-C300-32DI-LD-Z	1222950000	B.6
FTA-C300-32DIOHV-S	1221550000	B.5
FTA-C300-32DIOHV-S	1221550000	B.6
FTA-C300-32DIOHV-Z	1221560000	B.5
FTA-C300-32DIOHV-Z	1221560000	B.6
FTA-C300-32DO-FUSE-S	1246910000	B.5
FTA-C300-32DO-FUSE-S	1246910000	B.7
FTA-C300-32DO-FUSE-Z	1246920000	B.5
FTA-C300-32DO-FUSE-Z	1246920000	B.7
FTA-C300-32DO-LD-S	1221590000	B.5
FTA-C300-32DO-LD-S	1221590000	B.7
FTA-C300-32DO-LD-Z	1221600000	B.5
FTA-C300-32DO-LD-Z	1221600000	B.7
FTA-C300-32DO-RSLM-S	1221570000	B.5
FTA-C300-32DO-RSLM-S	1221570000	B.12
FTA-C300-32DO-RSLM-Z	1221580000	B.5
FTA-C300-32DO-RSLM-Z	1221580000	B.12

G

G 20/2.00A/F	0430900000	C.30
--------------	------------	------

M

MIGRATION RACK PLC5-12S H	8000075319	G.34
MIGRATION RACK PLC5-16S H	8000074897	G.34
MIGRATION RACK PLC5-8S H	8000074896	G.34
MIGRATION RACK S5 115 H	1983530000	G.33
MIGRATION RACK S5 135 H	1983530000	G.33
MIGRATION RACK TSX7 H	1983520000	G.34
MODICON QUANTUM MIG MOD.40 POL	6720001822	G.47

P

PAC-C300-16-F-25-1M	1481650010	B.18
PAC-C300-16-F-34-1M	1481660010	B.18
PAC-C300-16-F-50-1M	1481670010	B.18
PAC-C300-1616-25-1M	1481610010	B.17
PAC-C300-1616-34-1M	1481620010	B.17
PAC-C300-1616-50-1M	1481630010	B.17
PAC-C300-32-1616-25-1M	1373880010	B.19
PAC-C300-32-1616-34-1M	7789893010	B.19
PAC-C300-32-1616-50-1M	1373920010	B.19
PAC-C300-32-F-25-1M	1349330010	B.15
PAC-C300-32-F-34-1M	1373900010	B.15
PAC-C300-32-F-50-1M	1373940010	B.15
PAC-C300-3232-25-1M	7789880010	B.13
PAC-C300-3232-34-1M	149820010	B.13
PAC-C300-3232-50-1M	7789882010	B.13
PAC-C300-36-F-25-1M	1349340010	B.16
PAC-C300-36-F-34-1M	1373910010	B.16
PAC-C300-36-F-50-1M	1373950010	B.16
PAC-C300-3636-25-1M	7789894010	B.14
PAC-C300-3636-34-1M	7789895010	B.14
PAC-C300-3636-50-1M	7789897010	B.14
PAC-D15F-D15F-HF-1M	2426180010	F.4
PAC-D15F-F-HF-1M	2426030010	F.4
PAC-D15M-D15M-HF-1M	2426150010	F.5
PAC-D15M-D15M-HF-1M	2426070010	F.4
PAC-D15M-F-HF-1M	2425980010	F.4
PAC-D25F-D25F-HF-1M	2426120010	F.4
PAC-D25F-F-HF-1M	2426040010	F.4
PAC-D25M-D25M-HF-1M	2426160010	F.5
PAC-D25M-D25M-HF-1M	2426080010	F.4
PAC-D25M-F-HF-1M	2425990010	F.4
PAC-D37F-D37F-HF-1M	2426130010	F.4
PAC-D37F-F-HF-1M	2426050010	F.4
PAC-D37M-D37M-HF-1M	2426190010	F.5
PAC-D37M-D37M-HF-1M	2426090010	F.4
PAC-D37M-F-HF-1M	2426000010	F.4
PAC-D9F-D9F-HF-1M	2426110010	F.4
PAC-D9F-F-HF-1M	2426020010	F.4
PAC-D9M-D9M-HF-1M	2425080010	F.5
PAC-D9M-D9M-HF-1M	2420570010	F.4
PAC-D9M-F-HF-1M	2425060010	F.4
PAC-ELCO 56-F56-F-1M	7789765010	F.8
PAC-ELCO20-F20-F-1M	7789761010	F.8
PAC-ELCO20-F20-F20-1M	7789760010	F.8
PAC-ELCO38-F38-F-1M	7789763010	F.8
PAC-ELCO38-F38-F38-1M	7789762010	F.8

Type	Order No.	Page
------	-----------	------

PAC-ELCO56-F32-F-1M	7789774010	F.8
PAC-ELCO56-F32-F32-1M	7789773010	F.8
PAC-ELCO56-F54-F-1M	7789776010	F.8
PAC-ELCO56-F54-F54-1M	778975010	F.8
PAC-ELCO56-F56-F56-1M	7789764010	F.8
PAC-HD15F-F-V0-1M	1440780010	F.6
PAC-HD15F-HD15F-V0-1M	1440750010	F.6
PAC-HD15M-F-V0-1M	1440810010	F.6
PAC-HD15M-HD15F-V0-1M	1440770010	F.7
PAC-HD15M-HD15M-V0-1M	1440740010	F.6
PAC-HD26F-F-V0-1M	2093080010	F.6
PAC-HD26F-HD26F-V0-1M	2094140010	F.6
PAC-HD26M-F-V0-1M	2093680010	F.6
PAC-HD26M-HD26F-V0-1M	2003420010	F.7
PAC-HD26M-HD26M-V0-1M	2094720010	F.6
PAC-HD44F-F-V0-1M	2093090010	F.6
PAC-HD44F-HD44F-V0-1M	2094180010	F.6
PAC-HD44M-F-V0-1M	2093910010	F.6
PAC-HD44M-HD44F-V0-1M	1989360010	F.7
PAC-HD44M-HD44M-V0-1M	2094730010	F.6
PAC-HD62F-HD62F-V0-1M	1988930010	F.6
PAC-HD62M-HD62F-V0-1M	2094800010	F.7
PAC-HD62M-HD62M-V0-1M	2094770010	F.6
PAC-HE10-F-HF-1M	2420540010	F.3
PAC-HE10-HE10-HF-1M	2420550010	F.3
PAC-HE14-F-HF-1M	2425650010	F.3
PAC-HE14-HE14-HF-1M	2425940010	F.3
PAC-HE16-F-HF-1M	2425710010	F.3
PAC-HE16-HE16-HF-1M	2425700010	F.3
PAC-HE20-F-HF-1M	2425660010	F.3
PAC-HE20-HE20-HF-1M	2425730010	F.3
PAC-HE26-F-HF-1M	2425720010	F.3
PAC-HE26-HE26-HF-1M	2425740010	F.3
PAC-HE34-F-HF-1M	2425690010	F.3
PAC-HE34-HE34-HF-1M	2425950010	F.3
PAC-HE40-F-HF-1M	2425680010	F.3
PAC-HE40-HE40-HF-1M	2425960010	F.3
PAC-UNIV-D15F-D15F-1M	1348990010	F.4
PAC-UNIV-D15F-F-1M	1350480010	F.4
PAC-UNIV-D15M-D15M-1M	1349970010	F.5
PAC-UNIV-D15M-D15M-1M	1349780010	F.4
PAC-UNIV-D15M-F-1M	1350420010	F.4
PAC-UNIV-D25F-D25F-1M	1349920010	F.4
PAC-UNIV-D25F-F-1M	1350490010	F.4
PAC-UNIV-D25M-D25M-1M	1349980010	F.5
PAC-UNIV-D25M-D25M-1M	1349800010</	

Type	Order No.	Page
TRZ 24VUC 1C0	1122890000	E.33
TRZ 24VUC 1C0	1122890000	E.34
TRZ 24VUC 1C0	1122890000	E.35
TRZ 24VUC 1C0	1122890000	E.36
TRZ 24VUC 1C0	1122890000	E.37
TRZ 24VUC 1C0	1122890000	E.40
TRZ 24VUC 1C0	1122890000	E.41
TRZ 24VUC 1C0	1122890000	E.46
TRZ 24VUC 1C0	1122890000	E.47
TRZ 24VUC 2C0	1123620000	E.19
TRZ 24VUC 2C0	1123620000	E.21
TRZ 24VUC 2C0	1123620000	E.26
TRZ 24VUC 2C0	1123620000	E.28
TRZ 24VUC 2C0	1123620000	E.29
TRZ 24VUC 2C0	1123620000	E.32
TRZ 24VUC 2C0	1123620000	E.34
TRZ 24VUC 2C0	1123620000	E.36
TRZ 24VUC 2C0	1123620000	E.40
TRZ 24VUC 2C0	1123620000	E.46
TRZ 24VUC 2C0	1123620000	E.47

Order No.	Type	Page
-----------	------	------

0170000000

0178960000	SKH C64 RH2	H.7
------------	-------------	-----

0180000000

0180961001	RSD A22 LP/LP	D.21
0181061001	RSD K22 LP/LP	D.21
0181461001	RSD 12 LP/LP	D.21

0220000000

0224261001	RS F20 LP2N 5/20	A.39
0224261001	RS F20 LP2N 5/20	D.6
0224361001	RS F34 LP2N 5/34	D.6
0224461001	RS F40 LP2N 5/40	A.39
0224461001	RS F40 LP2N 5/40	D.6
0224561001	RS F50 LP2N 5/50	D.6
0224661001	RS F60 LP2N 5/60	D.6
0224761001	RS F64 LP2N 5/64	D.6
0224861001	RS F26 LP2N 5/26	D.6
0224961001	RS F10 LP2N 5/10	D.6
0225061001	RS F14 LP2N 5/14	D.6
0225161001	RS F16 LP2N 5/16	D.6

0320000000

0329761001	RSX LOETST. LP	D.17
------------	----------------	------

0430000000

0430900000	G 20/2.00A/F	C.30
------------	--------------	------

0570000000

0577360000	SKH B64 RH2	H.7
------------	-------------	-----

0580000000

0586661001	SKH 31 LP RH1	H.6
0586761001	SKH D32 LP 5/16 RH2	H.7
0586861001	SKH F32 (Z&B) LP RH2	H.8
0586961001	SKH F32 (Z&D) LP RH2	H.9
0587060000	SKH F48	H.9

0640000000

0646660000	SKH C64 RH2	H.7
0648661001	SKH 31 LP 250VAC RH1	H.6

0690000000

0690660000	SKH E48 LP2/LP	H.8
------------	----------------	-----

1120000000

1122770000	TRS 24VDC 1C0	E.19
1122770000	TRS 24VDC 1C0	E.20
1122770000	TRS 24VDC 1C0	E.21
1122770000	TRS 24VDC 1C0	E.22
1122770000	TRS 24VDC 1C0	E.23
1122770000	TRS 24VDC 1C0	E.24
1122770000	TRS 24VDC 1C0	E.25
1122770000	TRS 24VDC 1C0	E.26
1122770000	TRS 24VDC 1C0	E.27
1122770000	TRS 24VDC 1C0	E.28
1122770000	TRS 24VDC 1C0	E.29
1122770000	TRS 24VDC 1C0	E.30
1122770000	TRS 24VDC 1C0	E.31
1122770000	TRS 24VDC 1C0	E.32
1122770000	TRS 24VDC 1C0	E.33
1122770000	TRS 24VDC 1C0	E.34
1122770000	TRS 24VDC 1C0	E.35
1122770000	TRS 24VDC 1C0	E.36
1122770000	TRS 24VDC 1C0	E.37
1122770000	TRS 24VDC 1C0	E.38
1122770000	TRS 24VDC 1C0	E.39
1122770000	TRS 24VDC 1C0	E.40
1122770000	TRS 24VDC 1C0	E.41
1122770000	TRS 24VDC 1C0	E.42
1122770000	TRS 24VDC 1C0	E.43
1122770000	TRS 24VDC 1C0	E.44
1122770000	TRS 24VDC 1C0	E.45
1122770000	TRS 24VDC 1C0	E.46
1122770000	TRS 24VDC 1C0	E.47
1122770000	TRS 24VDC 1C0	E.48
1122770000	TRS 24VDC 1C0	E.49
1122770000	TRS 24VDC 1C0	E.50
1122770000	TRS 24VDC 1C0	E.51
1122770000	TRS 24VDC 1C0	E.52
1122770000	TRS 24VDC 1C0	E.53
1122770000	TRS 24VDC 1C0	E.54
1122770000	TRS 24VDC 1C0	E.55

Order No.	Type	Page
-----------	------	------

1122780000	TRS 24VUC 1C0	E.36
1122780000	TRS 24VUC 1C0	E.37
1122780000	TRS 24VUC 1C0	E.40
1122780000	TRS 24VUC 1C0	E.41
1122780000	TRS 24VUC 1C0	E.46
1122780000	TRS 24VUC 1C0	E.47
1122890000	TRZ 24VUC 1C0	E.19
1122890000	TRZ 24VUC 1C0	E.21
1122890000	TRZ 24VUC 1C0	E.22
1122890000	TRZ 24VUC 1C0	E.24
1122890000	TRZ 24VUC 1C0	E.25
1122890000	TRZ 24VUC 1C0	E.26
1122890000	TRZ 24VUC 1C0	E.27
1122890000	TRZ 24VUC 1C0	E.28
1122890000	TRZ 24VUC 1C0	E.29
1122890000	TRZ 24VUC 1C0	E.30
1122890000	TRZ 24VUC 1C0	E.31
1122890000	TRZ 24VUC 1C0	E.32
1122890000	TRZ 24VUC 1C0	E.33
1122890000	TRZ 24VUC 1C0	E.34
1122890000	TRZ 24VUC 1C0	E.35
1122890000	TRZ 24VUC 1C0	E.36
1122890000	TRZ 24VUC 1C0	E.37
1122890000	TRZ 24VUC 1C0	E.40
1122890000	TRZ 24VUC 1C0	E.41
1122890000	TRZ 24VUC 1C0	E.46
1122890000	TRZ 24VUC 1C0	E.47
1123000000	TRS 24VDC 1C0 AU	E.19
1123000000	TRS 24VDC 1C0 AU	E.20
1123000000	TRS 24VDC 1C0 AU	E.21
1123000000	TRS 24VDC 1C0 AU	E.22
1123000000	TRS 24VDC 1C0 AU	E.23
1123000000	TRS 24VDC 1C0 AU	E.24
1123000000	TRS 24VDC 1C0 AU	E.25
1123000000	TRS 24VDC 1C0 AU	E.26
1123000000	TRS 24VDC 1C0 AU	E.27
1123000000	TRS 24VDC 1C0 AU	E.28
1123000000	TRS 24VDC 1C0 AU	E.29
1123000000	TRS 24VDC 1C0 AU	E.30
1123000000	TRS 24VDC 1C0 AU	E.31
1123000000	TRS 24VDC 1C0 AU	E.32
1123000000	TRS 24VDC 1C0 AU	E.33
1123000000	TRS 24VDC 1C0 AU	E.34
1123000000	TRS 24VDC 1C0 AU	E.35
1123000000	TRS 24VDC 1C0 AU	E.36
1123000000	TRS 24VDC 1C0 AU	E.37
1123000000	TRS 24VDC 1C0 AU	E.38
1123000000	TRS 24VDC 1C0 AU	E.39
1123000000	TRS 24VDC 1C0 AU	E.40
1123000000	TRS 24VDC 1C0 AU	E.41
1123000000	TRS 24VDC 1C0 AU	E.42
1123000000	TRS 24VDC 1C0 AU	E.43
1123000000	TRS 24VDC 1C0 AU	E.44
1123000000	TRS 24VDC 1C0 AU	E.45
1123000000	TRS 24VDC 1C0 AU	E.46
1123000000	TRS 24VDC 1C0 AU	E.47
1123000000	TRS 24VDC 1C0 AU	E.48
1123490000	TRS 24VDC 2C0	E.19
1123490000	TRS 24VDC 2C0	E.20
1123490000	TRS 24VDC 2C0	E.21
1123490000	TRS 24VDC 2C0	E.22
1123490000	TRS 24VDC 2C0	E.23
1123490000	TRS 24VDC 2C0	E.24
1123490000	TRS 24VDC 2C0	E.26
1123490000	TRS 24VDC 2C0	E.28
1123490000	TRS 24VDC 2C0	E.29
1123490000	TRS 24VDC 2C0	E.32
1123490000	TRS 24VDC 2C0	E.34
1123490000	TRS 24VDC 2C0	E.36
1123490000	TRS 24VDC 2C0	E.40
1123490000	TRS 24VDC 2C0	E.42
1123490000	TRS 24VDC 2C0	E.43
1123490000	TRS 24VDC 2C0	E.44
1123490000	TRS 24VDC 2C0	E.48
1123500000	TRS 24VUC 2C0	E.19
1123500000	TRS 24VUC 2C0	E.21
1123500000	TRS 24VUC 2C0	E.26
1123500000	TRS 24VUC 2C0	E.28
1123500000	TRS 24VUC 2C0	E.29
1123500000	TRS 24VUC 2C0	E.32
1123500000	TRS 24VUC 2C0	E.33
1123500000	TRS 24VUC 2C0	E.34
1123500000	TRS 24VUC 2C0	E.36
1123500000	TRS 24VUC 2C0	E.40
1123500000	TRS 24VUC 2C0	E.44
1123500000	TRS 24VUC 2C0	E.46
1123500000	TRS 24VUC 2C0	E.47
1123500000	TRS 24VUC 2C0	E.48
1123500000	TRS 24VUC 2C0	E.49
1123620000	TRZ 24VUC 2C0	E.19
1123620000	TRZ 24VUC 2C0	E.21
1123620000	TRZ 24VUC 2C0	E.26
1123620000	TRZ 24VUC 2C0	E.28
1123620000	TRZ 24VUC 2C0	E.29
1123620000	TRZ 24VUC 2C0	E.32
1123620000	TRZ 24VUC 2C0	E.33
1123620000	TRZ 24VUC 2C0	E.36
1123620000	TRZ 24VUC 2C0	E.40
1123620000	TRZ 24VUC 2C0	E.46
1123620000	TRZ 24VUC 2C0	E.47
1123620000	TRZ 24VUC 2C0	E.48
1123620000	TRZ 24VUC 2C0	E.49
1123730000	TRS 24VDC 2C0 AU	E.19
1123730000	TRS 24VDC 2C0 AU	E.20
1123730000	TRS 24VDC 2C0 AU	E.21
1123730000	TRS 24VDC 2C0 AU	E.23

Order No.	Type	Page
-----------	------	------

1123730000	TRS 24VDC 2C0 AU	E.24
1123730000	TRS 24VDC 2C0 AU	E.26
1123730000	TRS 24VDC 2C0 AU	E.28
1123730000	TRS 24VDC 2C0 AU	E.29
1123730000	TRS 24VDC 2C0 AU	E.32
1123730000	TRS 24VDC 2C0 AU	E.34
1123730000	TRS 24VDC 2C0 AU	E.36
1123730000	TRS 24VDC 2C0 AU	E.40
1123730000	TRS 24VDC 2C0 AU	E.42
1123730000	TRS 24VDC 2C0 AU	E.43
1123730000	TRS 24VDC 2C0 AU	E.44
1123730000	TRS 24VDC 2C0 AU	E.45
1123730000	TRS 24VDC 2C0 AU	E.46
1123730000	TRS 24VDC 2C0 AU	E.47
1123730000	TRS 24VDC 2C0 AU	E.48
1126610000	RS ELCO 20/20RM S	D.12
1126630000	RS ELCO 20/20LM S	D.12
1126650000	RS ELCO 38/38RM S	D.12
1126670000	RS ELCO 38/38LM S	D.12
1126690000	RS ELCO 56/32RM S	D.12
1126710000	RS ELCO 56/32LM S	D.12
1126730000	RS ELCO 56/54RM S	D.12
1126750000	RS ELCO 56/54LM S	D.12
1126770000	RS ELCO 56/56RM S	D.12
1126790000	RS ELCO 56/56LM S	D.12
1126810000	RS ELCO 90/90RM S	D.12
1126870000	RS ELCO 90/90LM S	D.12
1128100000	RS VERT 4P 20X4 Z	D.20
1128110000	RS VERT 4P 20X4 Z	D.20
1128120000	RS VERT 6P 12X6 Z	D.20
1128130000	RS VERT 6P 12X6 Z	D.20
1128990000	RSM-8 PLC C SW 1C0 S	A.62
1128990000	RSM-8 PLC C SW 1C0 S	A.64
1129030000	RSM-16 PLC C SW 1C0 S	A.62
1129030000	RSM-16 PLC C SW 1C0 S	A.71
1129040000	RSM-16 PLC C SW 1C0 Z	A.62
1129040000	RSM-16 PLC C SW 1C0 Z	A.71
1129120000	RSM-16 PLC SW 1C0 S	A.62
1129120000	RSM-16 PLC SW 1C0 S	A.73
1129130000	RSM-16 PLC SW 1C0 Z	A.62
1129130000	RSM-16 PLC SW 1C0 Z	A.73

1220000000

1221550000	FTA-C300-32DIOHV-S	B.5
1221550000	FTA-C300-32DIOHV-S	B.6
1221560000	FTA-C300-32DIOHV-Z	B.5
1221560000	FTA-C300-32DIOHV-Z	B.6
1221570000	FTA-C300-32D0-RSLM-S	B.5
1221570000	FTA-C300-32D0-RSLM-S	B.12
1221580000	FTA-C300-32D0-RSLM-Z	B.5
1221580000	FTA-C300-32D0-RSLM-Z	B.12
1221590000	FTA-C300-32D0-LD-S	B.5
1221590000	FTA-C300-32D0-LD-S	B.7
1221600000	FTA-C300-32D0-LD-Z	B.5
1221600000	FTA-C300-32D0-LD-Z	B.7
1222940000	FTA-C300-32D1L-D-S	B.5
1222940000	FTA-C300-32D1L-D-S	B.6
1222950000	FTA-C300-32D1L-D-Z	B.5
1222950000	FTA-C300-32D1L-D-Z	B.6
1222980000	FTA-C300-16A0-SH-S	B.5
1222980000	FTA-C300-16A0-SH-S	B.9
1222990000	FTA-C300-16A0-SH-Z	B.5
1222990000	FTA-C300-16A0-SH-Z	B.9
1223010000	FTA-C300-16A0-SH-P	B.5
1223010000	FTA-C300-16A0-SH-P	B.9
1223020000	FTA-C300-16A0-TEST-S	B.5
1223020000	FTA-C300-16A0-TEST-S	B.9
1223030000	FTA-C300-16A0-TEST-Z	B.5
1223030000	FTA-C300-16A0-TEST-Z	B.9

1240000000

1246910000	FTA-C300-32D0-FUSE-S	B.5
1246910000	FTA-C300-32D0-FUSE-S	B.7
1246920000	FTA-C300-32D0-FUSE-Z	B.5
1246920000	FTA-C300-32D0-FUSE-Z	B.7
1247120000	FTA-C300-16A1-SH-S	B.5
1247120000	FTA-C300-16A1-SH-S	B.8
1247130000	FTA-C300-16A1-SH-Z	B.5
1247130000	FTA-C300-16A1-SH-Z	B.8
1247140000	FTA-C300-16A1-TEST	

Order No.	Type	Page
1371140000	TBY-RS-A10-2KS-Z	C.17
1371140000	TBY-RS-A10-2KS-Z	C.18
1371150000	TBY-SAI143-2KS-S	C.17
1371150000	TBY-SAI143-2KS-S	C.18
1371170000	TBY-SAI143-2KS-Z	C.17
1371170000	TBY-SAI143-2KS-Z	C.18
1371180000	TBY-SAV144-2KS-S	C.17
1371180000	TBY-SAV144-2KS-S	C.18
1371190000	TBY-SAV144-2KS-Z	C.17
1371190000	TBY-SAV144-2KS-Z	C.18
1371200000	TBY-SAI533-2KS-S	C.17
1371200000	TBY-SAI533-2KS-S	C.18
1371210000	TBY-SAI533-2KS-Z	C.17
1371210000	TBY-SAI533-2KS-Z	C.18
1371220000	TBY-RS-A10-4-2KS-S	C.17
1371220000	TBY-RS-A10-4-2KS-S	C.20
1371230000	TBY-RS-A10-4-2KS-Z	C.17
1371230000	TBY-RS-A10-4-2KS-Z	C.20
1371240000	TBY-SAI143-F-L-PS-2KS-S	C.17
1371240000	TBY-SAI143-F-L-PS-2KS-S	C.22
1371250000	TBY-SAI143-F-L-PS-2KS-Z	C.17
1371250000	TBY-SAI143-F-L-PS-2KS-Z	C.22
1371340000	TBY-RS-UNIV-SP-2KS-S	C.17
1371340000	TBY-RS-UNIV-SP-2KS-S	C.21
1371370000	TBY-RS-UNIV-SP-2KS-Z	C.17
1371370000	TBY-RS-UNIV-SP-2KS-Z	C.21
1371390000	TBY-SDV144-F-PS-2KB-S	C.17
1371390000	TBY-SDV144-F-PS-2KB-S	C.24
1371410000	TBY-SDV144-F-PS-2KB-Z	C.17
1371410000	TBY-SDV144-F-PS-2KB-Z	C.24
1371470000	TBY-C3-A10-2KS-S	C.5
1371470000	TBY-C3-A10-2KS-S	C.6
1371500000	TBY-C3-A10-2KS-Z	C.5
1371500000	TBY-C3-A10-2KS-Z	C.6
1371530000	TBY-C3-16AI-2KS-S	C.5
1371530000	TBY-C3-16AI-2KS-S	C.6
1371540000	TBY-RS-D10-2KB-S	C.17
1371540000	TBY-RS-D10-2KB-S	C.23
1371550000	TBY-C3-16AI-2KS-Z	C.5
1371550000	TBY-C3-16AI-2KS-Z	C.6
1371570000	TBY-RS-D10-2KB-Z	C.17
1371570000	TBY-RS-D10-2KB-Z	C.23
1371590000	TBY-C3-16AI0-2KS-S	C.5
1371590000	TBY-C3-16AI0-2KS-S	C.6
1371590000	TBY-C3-16AI0-2KS-Z	C.5
1371590000	TBY-C3-16AI0-2KS-Z	C.6
1371600000	TBY-C3-A10-4-2KS-S	C.5
1371600000	TBY-C3-A10-4-2KS-S	C.8
1371610000	TBY-C3-A10-4-2KS-Z	C.5
1371610000	TBY-C3-A10-4-2KS-Z	C.8
1371640000	TBY-C3-UNIV-SP-2KS-S	C.5
1371640000	TBY-C3-UNIV-SP-2KS-S	C.9
1371650000	TBY-C3-UNIV-SP-2KS-Z	C.5
1371650000	TBY-C3-UNIV-SP-2KS-Z	C.9
1373780010	C300-36B-F-2S-M34-1M	B.16
1373820010	C300-36B-F-2S-M50-1M	B.16
1373880010	PAC-C300-32-1616-25-1M	B.19
1373900010	PAC-C300-32-F-34-1M	B.15
1373910010	PAC-C300-36-F-34-1M	B.16
1373920010	PAC-C300-32-1616-50-1M	B.19
1373940010	PAC-C300-32-F-50-1M	B.15
1373950010	PAC-C300-36-F-50-1M	B.16
1373950000	TBY-ADV551-CF-PS-2KB-S	C.5
1373950000	TBY-ADV551-CF-PS-2KB-S	C.15
1373951000	TBY-ADV551-CF-PS-2KB-Z	C.5
1373951000	TBY-ADV551-CF-PS-2KB-Z	C.15

1380000000

1384080000	TBY-C3-UNIV-2KB-Z	C.5
1384080000	TBY-C3-UNIV-2KB-Z	C.10
1384090000	TBY-C3-UNIV-2KB-S	C.5
1384090000	TBY-C3-UNIV-2KB-S	C.10
1384250000	TBY-ADV151-48-PS-2KB-Z	C.5
1384250000	TBY-ADV151-48-PS-2KB-Z	C.14
1384280000	TBY-ADV151-48-PS-2KB-S	C.5
1384280000	TBY-ADV151-48-PS-2KB-S	C.14
1384320000	TBY-ADV151-24-PS-2KB-Z	C.5
1384320000	TBY-ADV151-24-PS-2KB-Z	C.13
1384330000	TBY-ADV151-24-PS-2KB-S	C.5
1384330000	TBY-ADV151-24-PS-2KB-S	C.13
1384340000	TBY-ADV151-PS-L-2KB-Z	C.5
1384340000	TBY-ADV151-PS-L-2KB-Z	C.11
1384350000	TBY-ADV151-PS-L-2KB-S	C.5
1384350000	TBY-ADV151-PS-L-2KB-S	C.11

1390000000

1395370000	TBY-SDV144-F-PS-2KB-S	C.17
1395370000	TBY-SDV144-F-PS-2KB-S	C.25
1395380000	TBY-SDV144-F-PS-2KB-Z	C.17
1395380000	TBY-SDV144-F-PS-2KB-Z	C.25
1397820000	TBY-ADV151-PS-F-L-2KB-S	C.5
1397820000	TBY-ADV151-PS-F-L-2KB-S	C.12
1397830000	TBY-ADV151-PS-F-L-2KB-Z	C.5
1397830000	TBY-ADV151-PS-F-L-2KB-Z	C.12

Order No.	Type	Page
1410000000		
1415220000	FTA-C300-16DAI-SH-S	B.5
1415220000	FTA-C300-16DAI-SH-S	B.10
1415230000	FTA-C300-16DAI-SH-Z	B.5
1415230000	FTA-C300-16DAI-SH-Z	B.10
1420000000		
1428080000	RS SD15M HD UNCA.40 S	D.10
1428090000	RS SD26M HD UNCA.40 S	D.10
1428110000	RS SD44M HD UNCA.40 S	D.10
1428120000	RS SD62M HD UNCA.40 S	D.10
1428130000	RS SD15F HD UNCA.40 S	D.10
1428140000	RS SD26F HD UNCA.40 S	D.10
1428150000	RS SD44F HD UNCA.40 S	D.10
1428160000	RS SD62F HD UNCA.40 S	D.10
1430000000		
1431700000	RS 1610 2W I-L 2H S	A.39
1431700000	RS 1610 2W I-L 2H S	A.45
1440000000		
1440740010	PAC-HD15M-HD15M-VO-1M	F.6
1440750010	PAC-HD15F-HD15F-VO-1M	F.6
1440770010	PAC-HD15M-HD15F-VO-1M	F.7
1440780010	PAC-HD15F-F-VO-1M	F.6
1440810010	PAC-HD15M-F-VO-1M	F.6
1447400000	RSM-4 12V+ 1CD S	E.6
1447410000	RSM-4 12V+ 1CD S	E.6
1447420000	RSM-4 12V+ 1CD Z	E.6
1447430000	RSM-4 12V+ 1CD S	E.6
1447440000	RSM-4 24V+ 1CD S	E.6
1447450000	RSM-4 24V+ 1CD S	E.6
1447470000	RSM-4 24V+ 1CD Z	E.6
1447480000	RSM-4 24V+ 1CD Z	E.6
1447500000	RSM-4 48V+ 1CD S	E.6
1447510000	RSM-4 48V+ 1CD S	E.6
1447520000	RSM-4 48V+ 1CD Z	E.6
1447530000	RSM-4 48V+ 1CD Z	E.6
1447540000	RSM-4 24VAC/DC 1CD S	E.6
1447550000	RSM-4 24VAC/DC 1CD S	E.6
1447560000	RSM-4 115VAC/DC 1CD S	E.6
1447570000	RSM-4 115VAC/DC 1CD S	E.6
1447580000	RSM-4 115VAC/DC 1CD Z	E.6
1447590000	RSM-4 230VAC 1CD Z	E.6
1447610000	RSM-4 230VAC 1CD Z	E.6
1447740000	RSM-41 24V+ 1CD S	E.6
1447750000	RSM-41 24V+ 1CD Z	E.6
1447820000	RSM-8 12V+ 1CD S	E.8
1447830000	RSM-8 12V+ 1CD S	E.8
1447840000	RSM-8 12V+ 1CD Z	E.8
1447850000	RSM-8 12V+ 1CD Z	E.8
1447870000	RSM-8 24V+ 1CD S	E.8
1447880000	RSM-8 24V+ 1CD S	E.8
1447890000	RSM-8 24V+ 1CD Z	E.8
1447900000	RSM-8 24V+ 1CD Z	E.8
1447910000	RSM-8 48V+ 1CD S	E.8
1447920000	RSM-8 48V+ 1CD S	E.8
1447930000	RSM-8 48V+ 1CD Z	E.8
1447940000	RSM-8 48V+ 1CD Z	E.8
1447950000	RSM-8 24VAC/DC 1CD S	E.8
1447970000	RSM-8 24VAC/DC 1CD Z	E.8
1447980000	RSM-8 115VAC/DC 1CD S	E.8
1447990000	RSM-8 115VAC/DC 1CD Z	E.8
1448000000	RSM-8 230VAC 1CD S	E.8
1448010000	RSM-8 230VAC 1CD Z	E.8
1448140000	RSM-81 24V+ 1CD S	E.8
1448170000	RSM-81 24V+ 1CD Z	E.8
1448230000	RSM-16 12V+ 1CD S	E.10
1448240000	RSM-16 12V+ 1CD S	E.10
1448250000	RSM-16 12V+ 1CD Z	E.10
1448270000	RSM-16 12V+ 1CD Z	E.10
1448280000	RSM-16 24V+ 1CD S	A.62
1448280000	RSM-16 24V+ 1CD S	A.72
1448280000	RSM-16 24V+ 1CD S	E.10
1448290000	RSM-16 24V+ 1CD S	A.62
1448290000	RSM-16 24V+ 1CD S	A.81
1448290000	RSM-16 24V+ 1CD S	E.10
1448300000	RSM-16 24V+ 1CD Z	A.62
1448300000	RSM-16 24V+ 1CD Z	A.72
1448300000	RSM-16 24V+ 1CD Z	E.10
1448300000	RSM-16 24V+ 1CD Z	E.10
1448310000	RSM-16 24V+ 1CD Z	A.62
1448310000	RSM-16 24V+ 1CD Z	A.81
1448310000	RSM-16 24V+ 1CD Z	E.10
1448320000	RSM-16 48V+ 1CD S	E.10
1448330000	RSM-16 48V+ 1CD S	E.10
1448340000	RSM-16 48V+ 1CD Z	E.10
1448350000	RSM-16 48V+ 1CD Z	E.10
1448370000	RSM-16 24VAC/DC 1CD S	E.10
1448380000	RSM-16 24VAC/DC 1CD S	E.10
1448390000	RSM-16 115VAC/DC 1CD S	E.10
1448400000	RSM-16 115VAC/DC 1CD Z	E.10
1448410000	RSM-16 230VAC 1CD S	E.10
1448420000	RSM-16 230VAC 1CD Z	E.10
1448450000	RSM-16 24VDC 1NO + C S	A.62
1448450000	RSM-16 24VDC 1NO + C S	A.78
1448470000	RSM-16 24VDC 1NO + C Z	A.62

Order No.	Type	Page
1448470000	RSM-16 24VDC 1NO + C Z	A.78
1448480000	RSM-16 24V+ BASE S	A.62
1448480000	RSM-16 24V+ BASE S	A.79
1448480000	RSM-16 24V+ BASE S	E.10
1448490000	RSM-16 24V+ BASE Z	A.62
1448490000	RSM-16 24V+ BASE Z	A.79
1448490000	RSM-16 24V+ BASE Z	E.10
1448540000	RSM161+ 24V+ 1CD S	E.10
1448550000	RSM161+ 24V+ 1CD Z	E.10
1448610000	RSM-4 12V+ 2CD S	E.6
1448620000	RSM-4 12V+ 2CD S	E.6
1448630000	RSM-4 12V+ 2CD Z	E.6
1448640000	RSM-4 12V+ 2CD Z	E.6
1448650000	RSM-4 24V+ 2CD S	E.6
1448660000	RSM-4 24V+ 2CD Z	E.6
1448670000	RSM-4 24V+ 2CD Z	E.6
1448680000	RSM-4 24V+ 2CD Z	E.6
1448690000	RSM-4 24V+ 2CD Z	E.6
1448700000	RSM-4 48V+ 2CD S	E.6
1448710000	RSM-4 48V+ 2CD S	E.6
1448720000	RSM-4 48V+ 2CD Z	E.6
1448730000	RSM-4 48V+ 2CD Z	E.6
1448740000	RSM-4 24VAC/DC 2CD S	E.6
1448770000	RSM-4 24VAC/DC 2CD Z	E.6
1448780000	RSM-4 115VAC/DC 2CD S	E.6
1448790000	RSM-4 115VAC/DC 2CD Z	E.6
1448800000	RSM-4 230VAC 2CD S	E.6
1448810000	RSM-4 230VAC 2CD S	E.6
1448820000	RSM-41 24V+ 2CD S	E.6
1448830000	RSM-41 24V+ 2CD Z	E.6
1448890000	RSM-8 12V+ 2CD S	E.8
1448900000	RSM-8 12V+ 2CD S	E.8
1448910000	RSM-8 12V+ 2CD Z	E.8
1448920000	RSM-8 12V+ 2CD Z	E.8
1448930000	RSM-8 24V+ 2CD S	E.8
1448940000	RSM-8 24V+ 2CD S	E.8
1448950000	RSM-8 24V+ 2CD Z	E.8
1448970000	RSM-8 24V+ 2CD Z	E.8
1448980000	RSM-8 48V+ 2CD S	E.8
1448990000	RSM-8 48V+ 2CD S	E.8
1449010000	RSM-8 48V+ 2CD Z	E.8
1449020000	RSM-8 48V+ 2CD Z	E.8
1449030000	RSM-8 24VAC/DC 2CD S	E.8
1449040000	RSM-8 24VAC/DC 2CD Z	E.8
1449050000	RSM-8 115VAC/DC 2CD S	E.8
1449070000	RSM-8 115VAC/DC 2CD Z	E.8
1449080000	RSM-8 230VAC 2CD S	E.8
1449090000	RSM-8 230VAC 2CD Z	E.8
1449100000	RSM-81 24V+ 2CD S	E.8
1449110000	RSM-81 24V+ 2CD Z	E.8
1449170000	RSM-16 12V+ 2CD S	E.10
1449180000	RSM-16 12V+ 2CD S	E.10
1449190000	RSM-16 12V+ 2CD Z	E.10
1449200000	RSM-16 12V+ 2CD Z	E.10
1449210000	RSM-16 24V+ 2CD S	A.62
1449210000	RSM-16 24V+ 2CD S	A.75
1449210000	RSM-16 24V+ 2CD S	E.10
1449220000	RSM-16 24V+ 2CD Z	A.62
1449220000	RSM-16 24V+ 2CD Z	A.82
1449220000	RSM-16 24V+ 2CD Z	E.10
1449230000	RSM-16 24V+ 2CD Z	A.62
1449230000	RSM-16 24V+ 2CD Z	A.75
1449230000	RSM-16 24V+ 2CD Z	E.10
1449250000	RSM-16 24V+ 2CD Z	A.62
1449250000	RSM-16 24V+ 2CD Z	A.82
1449250000	RSM-16 24V+ 2CD Z	E.10
1449270000	RSM-16 48V+ 2CD S	E.10
1449280000	RSM-16 48V+ 2CD S	E.10
1449290000	RSM-16 48V+ 2CD Z	E.10
1449300000	RSM-16 48V+ 2CD Z	E.10
1449310000	RSM-16 24VAC/DC 2CD S	E.10
1449320000	RSM-16 24VAC/DC 2CD Z	E.10
1449330000	RSM-16 115VAC/DC 2CD S	E.10
1449340000	RSM-16 115VAC/DC 2CD Z	E.10
1449350000	RSM-16 230VAC 2CD S	E.10
1449370000	RSM-16 230VAC 2CD Z	E.10
1449380000	RSM-161 24V+ 2CD S	E.10
1449390000	RSM-161 24V+ 2CD Z	E.10
1450000000		
1456540000	RSMS-8H 24V+ 1CD S	A.62

Order No.	Type	Page
1463550000	TIAL F20	E.30
1463550000	TIAL F20	E.31
1463550000	TIAL F20	E.33
1463550000	TIAL F20	E.35
1463550000	TIAL F20	E.37
1463550000	TIAL F20	E.38
1463550000	TIAL F20	E.39
1463550000	TIAL F20	E.41
1463550000	TIAL F20	E.42
1463550000	TIAL F20	E.43
1463550000	TIAL F20	E.44
1463550000	TIAL F20	E.45
1463550000	TIAL F20	E.46
1463550000	TIAL F20	E.47
1463550000	TIAL F20	E.48
1463550000	TIAL F20	E.49
1464780000	RSM-8H 24V+ 1CD S	A.62
1464780000	RSM-8H 24V+ 1CD S	A.66
1464790000	RSM-8H 24V+ 1CD Z	A.62
1464790000	RSM-8H 24V+ 1CD Z	A.66
1464800000	RSM-8H 24V- 1CD S	A.62
1464800000	RSM-8H 24V- 1CD S	A.69
1464810000	RSM-8H 24V- 1CD Z	A.62
1464810000	RSM-8H 24V- 1CD Z	A.69

1480000000

1480740000	RS ELCOF 20/20RM S	D.13
1480750000	RS ELCOF 20/20LM S	D.13
1480760000	RS ELCOF 38/38RM S	D.13
1480770000	RS ELCOF 38/38LM S	D.13
1480780000	RS ELCOF 56/56RM S	D.13
1480790000	RS ELCOF 56/56LM S	D.13
1481610010	PAC-C300-1616-25-1M	B.17
1481620010	PAC-C300-1616-34-1M	B.17
1481630010	PAC-C300-1616-50-1M	B.17
1481650010	PAC-C300-16-F-25-1M	B.18
1481660010	PAC-C300-16-F-34-1M	B.18
1481670010	PAC-C300-16-F-50-1M	B.18
1481690010	C300-16B-160B-2S-M25-1M	B.17
1481710010	C300-16B-160B-2S-M34-1M	B.17
1481720010	C300-16B-160B-2S-M50-1M	B.17
1481740010	C300-16B-F-2S-M25-1M	B.18
1481750010	C300-16B-F-2S-M34-1M	B.18
1481760010	C300-16B-F-2S-M50-1M	B.18

1490000000

1498820010	PAC-C300-3232-34-1M	B.13
------------	---------------------	------

1530000000

1538820010	PAC-YOK-MIL50-V0-1M	C.26
1538840010	PAC-YOK-MIL40-V0-1M	C.26

1980000000

1985930000	FAD BLK1 SL24 M	G.9
1985930000	FAD BLK1 SL24 M	G.10
1985930000	FAD BLK1 SL24 M	G.22
1985940000	FAD BLK1 HE20 161M	G.9
1985940000	FAD BLK1 HE20 161M	G.10
1985940000	FAD BLK1 HE20 161M	G.20
1985950000	FAD BLK1 HE20 160 M	G.9
1985950000	FAD BLK1 HE20 160 M	G.10
1985950000	FAD BLK1 HE20 160 M	G.21
1985960000	FAD BLK7 2XHE20 M	G.9
1985960000	FAD BLK7 2XHE20 M	G.10
1985960000	FAD BLK7 2XHE20 M	G.23
1985970000	FAD BLK9 2XHE20 M	G.9
1985970000	FAD BLK9 2XHE20 M	G.10
1985970000	FAD BLK9 2XHE20 M	G.24
1985980000	FAD S5115 SL24 M	G.5
1985980000	FAD S5115 SL24 M	G.10
1985980000	FAD S5115 SL24 M	G.14
1986010000	FAD S5115 HE20 1610 M	G.5
1986010000	FAD S5115 HE20 1610 M	G.10
1986010000	FAD S5115 HE20 1610 M	G.12
1986030000	FAD S5135 SL20 R	G.7
1986030000	FAD S5135 SL20 R	G.10
1986030000	FAD S5135 SL20 R	G.18
1986040000	FAD S5135 HE20 1610 R	G.7
1986040000	FAD S5135 HE20 1610 R	G.10
1986040000	FAD S5135 HE20 1610 R	G.16
1986050000	FAD S5135 2XHE20 3210 R	G.7
1986050000	FAD S5135 2XHE20 3210 R	G.10
1986050000	FAD S5135 2XHE20 3210 R	G.17
1988930010	PAC-HD62F-HD62F-V0-1M	F.6
1989360010	PAC-HD44M-HD44F-V0-1M	F.7

1990000000

1991730000	FAD S5115 2XHE20 3210 M	G.5
1991730000	FAD S5115 2XHE20 3210 M	G.10
1991730000	FAD S5115 2XHE20 3210 M	G.13
1993500000	MIGRATION RACK S5 135 H	G.34
1993520000	MIGRATION RACK TSX7 H	G.33
1993530000	MIGRATION RACK S5 115 H	G.33

Order No.	Type	Page
-----------	------	------

2000000000

2000020000	FTA-C300-16A0-TP-Z	B.5
2000020000	FTA-C300-16A0-TP-Z	B.10
2003420010	PAC-HD26M-HD26F-V0-1M	F.7

2040000000

2045120000	FAD S5115 SL46 A M	G.5
2045120000	FAD S5115 SL46 A M	G.10
2045120000	FAD S5115 SL46 A M	G.15

2090000000

2093080010	PAC-HD26F-F-V0-1M	F.6
2093090010	PAC-HD44F-F-V0-1M	F.6
2093680010	PAC-HD26M-F-V0-1M	F.6
2093910010	PAC-HD44M-F-V0-1M	F.6
2094140010	PAC-HD26F-HD26F-V0-1M	F.6
2094180010	PAC-HD44F-HD44F-V0-1M	F.6
2094720010	PAC-HD26M-HD26M-V0-1M	F.6
2094730010	PAC-HD44M-HD44M-V0-1M	F.6
2094770010	PAC-HD62M-HD62M-V0-1M	F.6
2094800010	PAC-HD62M-HD62F-V0-1M	F.7

2420000000

2420520010	PAC-YOK-MIL40-F-1M	C.26
2420530010	PAC-YOK-MIL50-F-1M	C.26
2420540010	PAC-HE10-F-HF-1M	F.3
2420550010	PAC-HE10-HE10-HF-1M	F.3
2420560010	PAC-D9M-F-HF-1M	F.4
2420570010	PAC-D9M-D9M-HF-1M	F.4
2420580010	PAC-D9M-D9F-HF-1M	F.5
2425650010	PAC-HE14-F-HF-1M	F.3
2425660010	PAC-HE20-F-HF-1M	F.3
2425680010	PAC-HE40-F-HF-1M	F.3
2425690010	PAC-HE34-F-HF-1M	F.3
2425700010	PAC-HE16-HE16-HF-1M	F.3
2425710010	PAC-HE16-F-HF-1M	F.3
2425720010	PAC-HE26-F-HF-1M	F.3
2425730010	PAC-HE20-HE20-HF-1M	F.3
2425740010	PAC-HE26-HE26-HF-1M	F.3
2425940010	PAC-HE14-HE14-HF-1M	F.3
2425950010	PAC-HE34-HE34-HF-1M	F.3
2425960010	PAC-HE40-HE40-HF-1M	F.3
2425980010	PAC-D15M-F-HF-1M	F.4
2425990010	PAC-D25M-F-HF-1M	F.4
2426000010	PAC-D37M-F-HF-1M	F.4
2426020010	PAC-D9F-F-HF-1M	F.4
2426030010	PAC-D15F-F-HF-1M	F.4
2426040010	PAC-D25F-F-HF-1M	F.4
2426050010	PAC-D37F-F-HF-1M	F.4
2426070010	PAC-D15M-D15M-HF-1M	F.4
2426080010	PAC-D25M-D25M-HF-1M	F.4
2426090010	PAC-D37M-D37M-HF-1M	F.4
2426110010	PAC-D9F-D9F-HF-1M	F.4
2426120010	PAC-D25F-D25F-HF-1M	F.4
2426130010	PAC-D37F-D37F-HF-1M	F.4
2426150010	PAC-D15M-D15F-HF-1M	F.5
2426160010	PAC-D25M-D25F-HF-1M	F.5
2426180010	PAC-D15F-D15F-HF-1M	F.4
2426190010	PAC-D37M-D37F-HF-1M	F.5

2430000000

2435110000	FAD S5135 SL42 A R	G.10
2435110000	FAD S5135 SL42 A R	G.19
2436230000	BKP-16D0-SDV541-V1-S	C.30

2440000000

2448650000	FAD 1771-WA/WC SL10 M	G.10
2448660000	FAD 1771-WH SL21 M	G.10
2448670000	FAD 1771-WN 2SL20 M	G.10
2448680000	FAD 1771-WB/WD SL12 M	G.10
2448690000	FAD 1771-WF SL18 M	G.10

2460000000

2461730000	BKP-16D0-SDV541-V0-S	C.30
------------	----------------------	------

2490000000

2494590000	FAD BLK4 2XSL20	G.10
2494590000	FAD BLK4 2XSL20	G.25

2560000000

2563110000	FAD 1771-WG SL21 M	G.10
------------	--------------------	------

2610000000

2618000000	TRP 24VDC 1C0	E.19
2618000000	TRP 24VDC 1C0	E.20
2618000000	TRP 24VDC 1C0	E.21
2618000000	TRP 24VDC 1C0	E.22
2618000000	TRP 24VDC 1C0	E.23
2618000000	TRP 24VDC 1C0	E.24

Order No.	Type	Page
-----------	------	------

2618000000	TRP 24VDC 1C0	E.25
2618000000	TRP 24VDC 1C0	E.26
2618000000	TRP 24VDC 1C0	E.27
2618000000	TRP 24VDC 1C0	E.28
2618000000	TRP 24VDC 1C0	E.29
2618000000	TRP 24VDC 1C0	E.30
2618000000	TRP 24VDC 1C0	E.31
2618000000	TRP 24VDC 1C0	E.32
2618000000	TRP 24VDC 1C0	E.33
2618000000	TRP 24VDC 1C0	E.34
2618000000	TRP 24VDC 1C0	E.35
2618000000	TRP 24VDC 1C0	E.36
2618000000	TRP 24VDC 1C0	E.37
2618000000	TRP 24VDC 1C0	E.38
2618000000	TRP 24VDC 1C0	E.39
2618000000	TRP 24VDC 1C0	E.40
2618000000	TRP 24VDC 1C0	E.41
2618000000	TRP 24VDC 1C0	E.42
2618000000	TRP 24VDC 1C0	E.43
2618000000	TRP 24VDC 1C0	E.44
2618000000	TRP 24VDC 1C0	E.45
2618000000	TRP 24VDC 1C0	E.48
2618110000	TRP 24VDC 1C0 AU	E.19
2618110000	TRP 24VDC 1C0 AU	E.20
2618110000	TRP 24VDC 1C0 AU	E.21
2618110000	TRP 24VDC 1C0 AU	E.22
2618110000	TRP 24VDC 1C0 AU	E.23
2618110000	TRP 24VDC 1C0 AU	E.24
2618110000	TRP 24VDC 1C0 AU	E.25
2618110000	TRP 24VDC 1C0 AU	E.26
2618110000	TRP 24VDC 1C0 AU	E.27
2618110000	TRP 24VDC 1C0 AU	E.28
2618110000	TRP 24VDC 1C0 AU	E.29
2618110000	TRP 24VDC 1C0 AU	E.30
2618110000	TRP 24VDC 1C0 AU	E.31
2618110000	TRP 24VDC 1C0 AU	E.32
2618110000	TRP 24VDC 1C0 AU	E.33
2618110000	TRP 24VDC 1C0 AU	E.34
2618110000	TRP 24VDC 1C0 AU	E.35
2618110000	TRP 24VDC 1C0 AU	E.36
2618110000	TRP 24VDC 1C0 AU	E.37
2618110000	TRP 24VDC 1C0 AU	E.38
2618110000	TRP 24VDC 1C0 AU	E.39
2618110000	TRP 24VDC 1C0 AU	E.40
2618110000	TRP 24VDC 1C0 AU	E.41
2618110000	TRP 24VDC 1C0 AU	E.42
2618110000	TRP 24VDC 1C0 AU	E.43
2618110000	TRP 24VDC 1C0 AU	E.44
2618110000	TRP 24VDC 1C0 AU	E.45
2618110000	TRP 24VDC 1C0 AU	E.46
2618110000	TRP 24VDC 1C0 AU	E.47
2618110000	TRP 24VDC 1C0 AU	E.48
2618400000	TRP 24VDC 2C0	E.19
2618400000	TRP 24VDC 2C0	E.20
2618400000	TRP 24VDC 2C0	E.21
2618400000	TRP 24VDC 2C0	E.22
2618400000	TRP 24VDC 2C0	E.23
2618400000	TRP 24VDC 2C0	E.24
2618400000	TRP 24VDC 2C0	E.26
2618400000	TRP 24VDC 2C0	E.28
2618400000	TRP 24VDC 2C0	E.29
2618400000	TRP 24VDC 2C0	E.32
2618400000	TRP 24VDC 2C0	E.34
2618400000	TRP 24VDC 2C0	E.36
2618400000	TRP 24VDC 2C0	E.40
2618400000	TRP 24VDC 2C0	E.42
2618400000	TRP 24VDC 2C0	E.43
2618400000	TRP 24VDC 2C0	E.44
2618400000	TRP 24VDC 2C0	E.48
2618530000	TRP 24VDC 2C0 AU	E.19
2618530000	TRP 24VDC 2C0 AU	E.20
2618530000	TRP 24VDC 2C0 AU	E.21
2618530000	TRP 24VDC 2C0 AU	E.23
2618530000	TRP 24VDC 2C0 AU	E.24
2618530000	TRP 24VDC 2C0 AU	E.26
2618530000	TRP 24VDC 2C0 AU	E.28
2618530000	TRP 24VDC 2C0 AU	E.29
2618530000	TRP 24VDC 2C0 AU	E.32
2618530000	TRP 24VDC 2C0 AU	E.34
2618530000	TRP 24VDC 2C0 AU	E.36
2618530000	TRP 24VDC 2C0 AU	E.40
2618530000	TRP 24VDC 2C0 AU	E.42
2618530000	TRP 24VDC 2C0 AU	E.43
2618530000	TRP 24VDC 2C0 AU	E.45
2618530000	TRP 24VDC 2C0 AU	

Order No.	Type	Page
8012930000	RS F34 LP3R 3/36	D.7
8012940000	RS F40 LP3R 3/42	D.7
8012950000	RS F50 LP3R 3/51	D.7
8012960000	RS F60 LP3R 3/63	D.7
8012970000	RS F64 LP3R 3/66	D.7
8013120000	SKH C64*2 (A&C) RH2	H.11
8019880000	RS SD9B LP3R	D.9
8019890000	RS SD15B LP3R	D.9
8019900000	RS SD25B LP3R	D.9
8019910000	RS SD37B LP3R	D.9
8019920000	RS SD50B LP3R	D.9
8019930000	RS SD9S LP3R	D.9
8019940000	RS SD15S LP3R	D.9
8019950000	RS SD25S LP3R	D.9
8019960000	RS SD37S LP3R	D.9
8019970000	RS SD50S LP3R	D.9

8020000000

8022901001	RSD 10 LP/LP	D.21
8022911001	RSD 20 LP/LP	D.21
8022921001	RSD 40 LP/LP	D.21

8050000000

8050981001	SKH D32*2 LP5.08/16 RH2	H.11
8051300000	SKH H15S	H.10

8150000000

8155550000	RS F64 LPK 2H/66	D.7
8155570000	RS F50 LPK 2H/52	D.7
8155580000	RS F40 LPK 2H/42	D.7
8155590000	RS F34 LPK 2H/36	D.7
8155600000	RS F20 LPK 2H/22	D.7
8155610000	RS F10 LPK 2H/12	D.7
8155620000	RS SD25B UNCLPK2	D.9
8155630000	RS SD37B UNCLPK2	D.9
8155640000	RS SD50B UNCLPK2	D.9
8155650000	RS SD25S UNCLPK2	D.9
8155660000	RS SD37S UNCLPK2	D.9
8155670000	RS SD50S UNCLPK2	D.9

8170000000

8174800000	SKH2 31 LP	H.4
8174830000	SKH2 D32 LP	H.4
8174850000	SKH2 F32 (Z-B) LPP	H.5
8174860000	SKH2 F32 (Z-D) LP	H.5

8200000000

8209730000	RS SD15B UNCLPK2	D.9
------------	------------------	-----

8210000000

8213470000	RS F26 LPK 2H/28	D.7
8216480000	RS SD9B UNC LPK2	D.9

8230000000

8233350000	RS SD15S UNCLPK2	D.9
8234620000	RS VERT16 LPK2	D.18

8250000000

8252010000	RS VERT8 LPK2	D.18
8256980000	RS F14 LPK 2H/16	D.7
8259000000	RS F60 LPK 2H/62	D.7
8259010000	RS SD9S UNC LPK2	D.9

8260000000

8265540000	RS F16 LPK 2H/18	D.7
------------	------------------	-----

8530000000

8537110000	RS F20 Z	A.39
8537110000	RS F20 Z	D.6
8537130000	RS F34 Z	D.6
8537140000	RS F40 Z	A.39
8537140000	RS F40 Z	D.6
8537150000	RS F50 Z	D.6
8537180000	RS F26 Z	D.6
8537190000	RS F10 Z	D.6
8537200000	RS F14 Z	D.6
8537240000	RS SD37 SZ	A.53
8537240000	RS SD37 SZ	D.8
8537250000	RS SD37 BZ	D.8
8537260000	RS SD9 SZ	D.8
8537320000	RS SD9 BZ	D.8
8537350000	RS SD50 SZ	A.53
8537350000	RS SD50 SZ	D.8
8537360000	RS SD50 BZ	D.8
8537370000	RS SD25 SZ	A.53
8537370000	RS SD25 SZ	D.8
8537380000	RS SD25 BZ	D.8
8537390000	RS SD15 SZ	A.53
8537390000	RS SD15 SZ	D.8

Order No.	Type	Page
8537400000	RS SD15 BZ	D.8

8550000000

8555440000	RS RJ45 2WAY	D.11
------------	--------------	------

8610000000

8611320000	RS RJ45	D.11
------------	---------	------

9440000000

9441500000	RS 16IO 1W R S	A.39
9441500000	RS 16IO 1W R S	A.48
9441510000	RS 32IO 1W R S	A.39
9441510000	RS 32IO 1W R S	A.51
9441560000	RS 16IO 2W F R S	A.39
9441560000	RS 16IO 2W F R S	A.49
9441570000	RS 32IO 2W F R S	A.39
9441570000	RS 32IO 2W F R S	A.52
9441600000	RS 16IO 3W I R S	A.39
9441600000	RS 16IO 3W I R S	A.50
9441700000	RS 16IO 2W R S	A.39
9441700000	RS 16IO 2W R S	A.49
9441710000	RS 32IO 2W R S	A.39
9441710000	RS 32IO 2W R S	A.52
9441860000	RS 16IO 1W I R S	A.39
9441860000	RS 16IO 1W I R S	A.48
9441870000	RS 32IO 1W I R S	A.39
9441870000	RS 32IO 1W I R S	A.51
9445000000	RSM-8 C 1CO S	A.62
9445000000	RSM-8 C 1CO S	A.65
9445100000	RSM-16 C 1CO S	A.62
9445100000	RSM-16 C 1CO S	A.74
9445120000	RSM-16 FUS 1CO S	A.62
9445120000	RSM-16 FUS 1CO S	A.76
9445140000	RSM-16 FOR 1CO S	A.62
9445140000	RSM-16 FOR 1CO S	A.77
9445530000	RS 8IO 2W L H S	A.39
9445530000	RS 8IO 2W L H S	A.40
9445700000	RS 16IO 1W H S	A.39
9445700000	RS 16IO 1W H S	A.41
9445710000	RS 16IO 1W L H S	A.39
9445710000	RS 16IO 1W L H S	A.41
9445720000	RS 16IO 2W H S	A.39
9445720000	RS 16IO 2W H S	A.43
9445730000	RS 16IO 2W L H S	A.39
9445730000	RS 16IO 2W L H S	A.43
9445750000	RS 16IO 2W L H S	A.39
9445750000	RS 16IO 2W L H S	A.44
9445760000	RS 16IO 3W H S	A.39
9445760000	RS 16IO 3W H S	A.47
9445770000	RS 16IO 3W L H S	A.39
9445770000	RS 16IO 3W L H S	A.47
9445810000	RS 16IO 1W L H S	A.39
9445810000	RS 16IO 1W L H S	A.42
9445820000	RS 16IO 2W F H S	A.39
9445820000	RS 16IO 2W F H S	A.46
9447000000	RSM-8 C 1CO Z	A.62
9447000000	RSM-8 C 1CO Z	A.65
9447100000	RSM-16 C 1CO Z	A.62
9447100000	RSM-16 C 1CO Z	A.74
9447120000	RSM-16 FUS 1CO Z	A.62
9447120000	RSM-16 FUS 1CO Z	A.76
9448000000	RS 4AIO DP SD S	A.53
9448000000	RS 4AIO DP SD S	A.54
9448010000	RS 8AIO DP SD S	A.53
9448010000	RS 8AIO DP SD S	A.55
9448020000	RS 16AIO DP SD S	A.53
9448020000	RS 16AIO DP SD S	A.57
9448030000	RS 8AI PREM/APR SD S	A.53
9448030000	RS 8AI PREM/APR SD S	A.56
9448100000	RS 4AIO I-M-DP SD S	A.53
9448100000	RS 4AIO I-M-DP SD S	A.54
9448110000	RS 8AIO I-M-DP SD S	A.53
9448110000	RS 8AIO I-M-DP SD S	A.55
9448120000	RS 16AIO I-M-DP SD S	A.53
9448120000	RS 16AIO I-M-DP SD S	A.57
9449110000	RS 8AIO I-M-DP SD Z	A.53
9449110000	RS 8AIO I-M-DP SD Z	A.55

Addresses worldwide

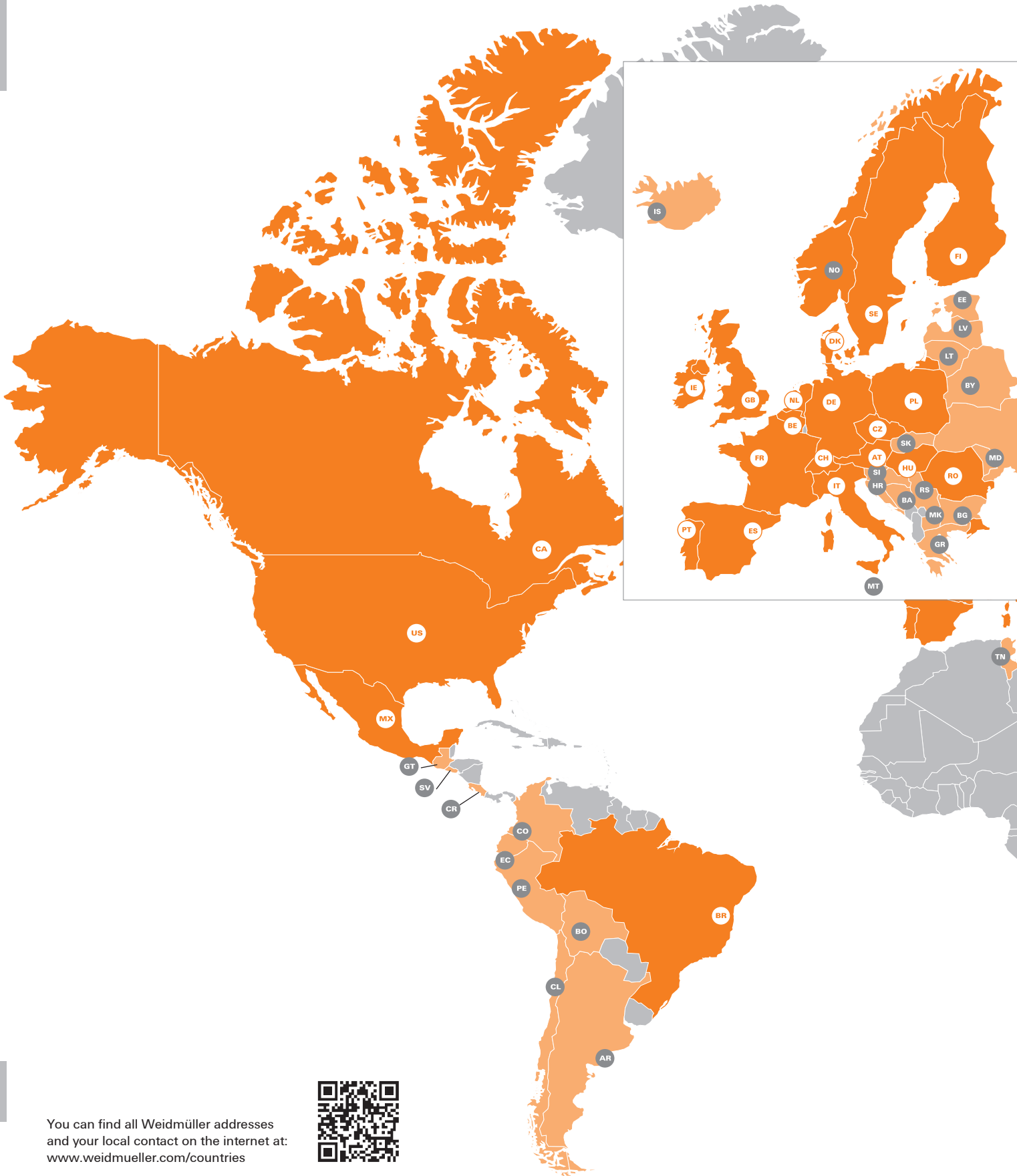

X

You can find all Weidmüller addresses and your local contact on the internet at: www.weidmueller.com/countries



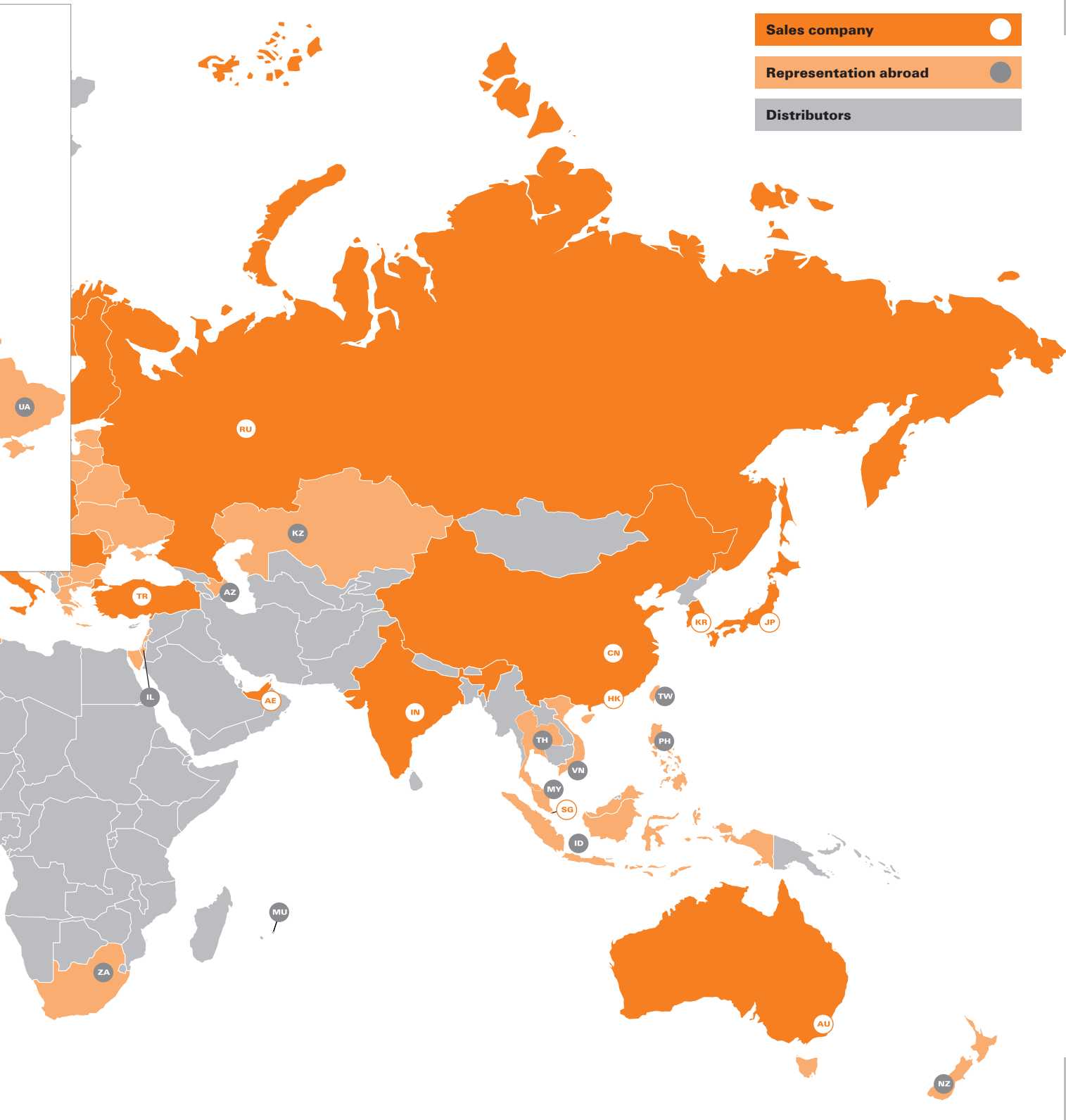

This catalogue contains trademarks of:

ABB is registered trademark of Asea Brown Boveri Ltd.

- S800 is registered trademark of ABB Schweiz AG
- Emerson, Delta V are registered trademark of Emerson Electric Co.
- Gefanuc is registered trademark of GE-Fanuc
- Honeywell, ControlEdge, Experion are registered trademarks of Honeywell International Inc.
- Mitsubishi is registered trademark of Mitsubishi Electric Corporation
- Moeller is registered trademark of Eaton Electrical IP GmbH & Co. KG
- Omron is registered trademark of Omron Corporation
- Rockwell Automation, PLC-5, CompactLogix, ControlLogix, MicroLogix are registered trademarks of Rockwell Automation, Inc.
- Schneider, Twido, Modicom, TSX are registered trademarks of Schneider Electric
- Siemens, ET 200M, ET 200 SP, S7-200, S7-300, S7-400, S7-1200, S7-1500 are registered trademarks of Siemens AG
- Yokogawa, ProSafe, Centum are registered trademarks of Yokogawa Electric Corporation
- Weidmüller, u-remote are registered trademarks of Weidmüller Interface GmbH & Co. KG

We cannot guarantee that there are no mistakes in the publications or software provided by us to the customer for the purpose of making orders. We try our best to quickly correct errors in our printed media.

X All orders are based on our general terms of delivery, which can be reviewed on the websites of our group companies where you place your order. On demand we can also send the general terms of delivery to you.

Weidmüller – Your partner in Industrial Connectivity

As experienced experts we support our customers and partners around the world with products, solutions and services in the industrial environment of power, signal and data. We are at home in their industries and markets and know the technological challenges of tomorrow. We are therefore continuously developing innovative, sustainable and useful solutions for their individual needs. Together we set standards in Industrial Connectivity.

Weidmüller Interface GmbH & Co. KG
Klingenbergstraße 26
32758 Detmold, Germany
T +49 5231 14-0
F +49 5231 14-292083
www.weidmueller.com

Personal support can
be found on our website:
www.weidmueller.com/contact

Made in Germany



Order number: 2829500000/05/2022/SMD