

PCB terminals and connectors OMNIMATE®

Design-in tools
and support at
[www.weidmuller.com/
omnimate](http://www.weidmuller.com/omnimate)

Version 2022

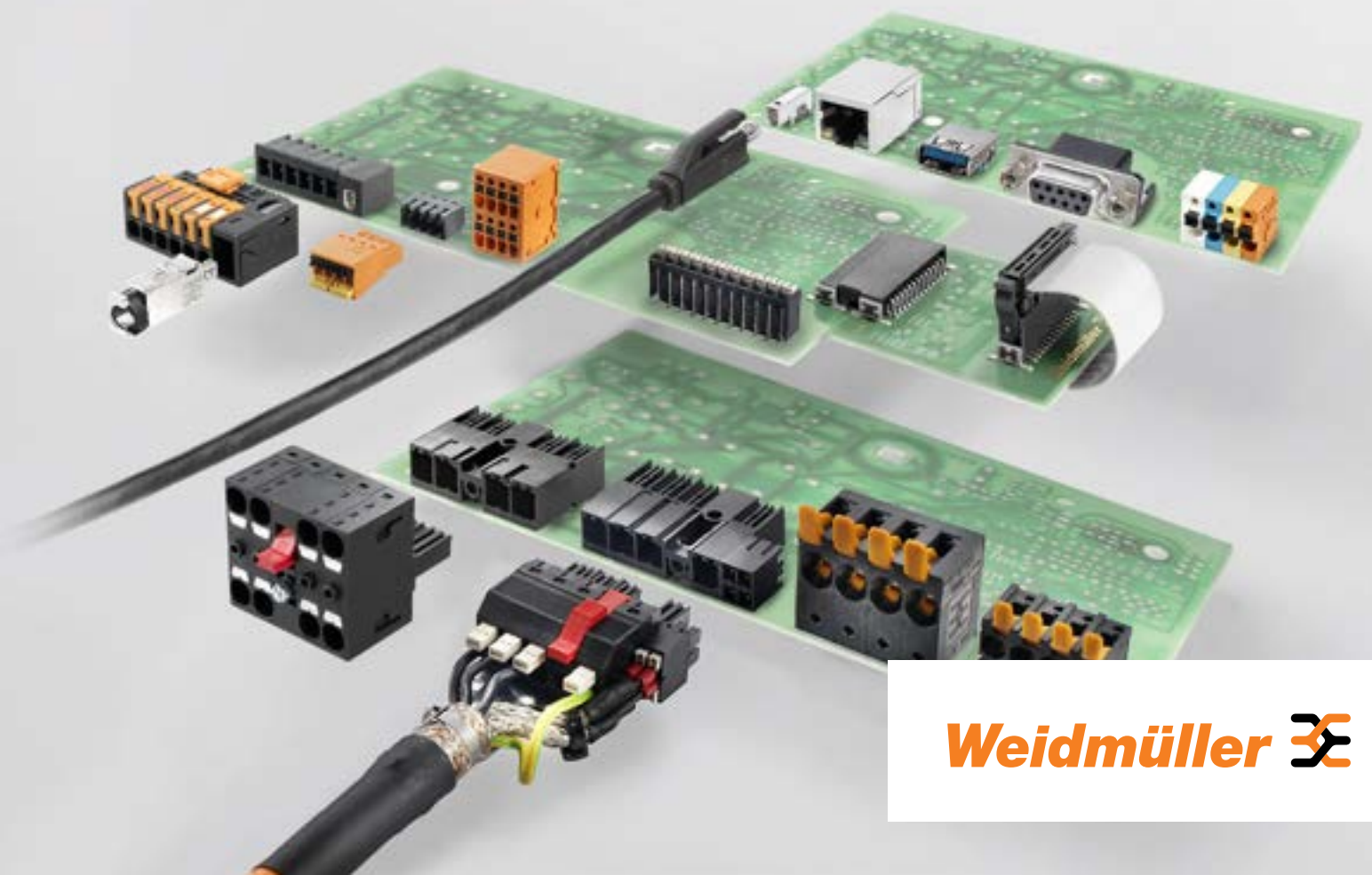

Weidmüller 

Orange Selection

Quick and easy planning

As a planning engineer, do you want to select products easily and receive them quickly? From a partner you can rely on? Then plan with the Orange Selection from Weidmüller in the future. The Orange Selection items are always available, carefully selected and the portfolio consists of more than 1,500 items to fully cover your standard needs.

If your order is placed before 3:00 pm, we guarantee that your order will be on its way the very next working day.

For even more efficient planning and production processes, we will of course provide all articles in digital form. CAD, ETIM and eClass data are available in our online product catalogue **catalog.weidmueller.com**

We have summarised all the advantages of the Orange Selection on our website.

Check it out: **www.weidmueller.com/orange-selection**



PCB terminals and connectors

OMNIMATE®

Catalogue 2

A	PCB terminals and connectors OMNIMATE®	Services & products in use
B		OMNIMATE® 4.0
C		OMNIMATE® Data
D		OMNIMATE® Data - RJ45
E		OMNIMATE® Data - USB
F		OMNIMATE® Data - D-SUB
G		OMNIMATE® Signal
H		PCB terminals
I		PCB plug-in connectors in 1.27 mm pitch Board-to-Board
J		PCB connectors in 2.50 mm pitch
K		PCB connectors in 3.50 mm pitch
L		PCB connectors in 3.81 mm pitch
M		PCB connectors in 5.00 mm and 5.08 mm pitch
N		PCB connectors Series RSV
		Accessories

PCB terminals and connectors

OMNIMATE®

Catalogue 2

PCB terminals and connectors
OMNIMATE®

OMINIMATE® Power

PCB terminals

PCB connectors

BUS connection system

Through-Panel Terminals

Accessories

OMINIMATE® Housings

Electronic housings

Annex

Service and Support

Technical appendix

Index

Search according to type or order number

Contents

O

P

Q

R

S

T

V

W

X

Rely on the quality and leading edge of the pioneer in connectivity

With each new generation, device designs are becoming smaller, more economical and offer greater performance. Accordingly, the connection system for more compact sizes must, for example, transfer high currents to the printed circuit board reliably and with minimum losses and also ensure a mechanically stable connection. At the same time, handling should be made safer and more convenient.

Do not leave the success of your device developments to chance. Trust the original OMNIMATE® PCB connection technology. As the inventor of the PCB terminal block and technological leader in device connectivity, Weidmüller offers high-quality components and unique design-in services that promise real added value for your device design.

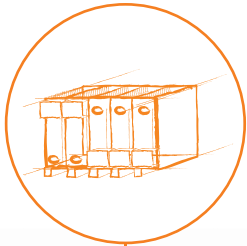

1960

Pioneering accomplishment

Weidmüller brings the worldwide first PCB terminal block onto the market

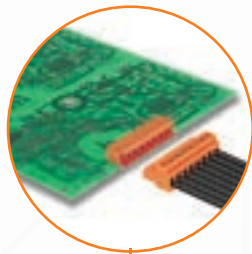

1980

Groundbreaking

The first plug-in connector for the PCB connection still today defines a connector face standard



2003

Creative

Power connectors up to 16 mm² with mounting flange simplify safe connection and release

PUSH IN

1978

Progressive

The PUSH IN connection technology is used for the very first time in a PCB terminal block



1999

Efficient

The first male header for the SMT reflow soldering processing is launched



**Your way to the right product
The AppGuide**

You can search for ways to successfully implement ideas for an application. Simply select your device application in our AppGuide, and we will recommend a range of products for all the different functions of your device.



**2021
OMNIMATE 4.0**

Digital. Flexible. Fast.
Solutions for industrial infrastructure of the future.



**2016
New**

Compact PUSH IN terminal blocks set new standards in efficiency and reliability



**2009
Innovative**

With the hybrid motor connector, Weidmüller provides the first single cable interface for drives



**2018
Smart**

The BL I/O CJC integrates electronics into a PCB plug-in connector for the first time



**2019
Digital**

The digital twin of all components as the key to Industry 4.0



**2013
Unique**

AppGuide, 72-hour sample service and configurators are just some of the diverse planning and support tools

Your ideas need the right connections Ours are simply brilliant



OMNIMATE® 4.0 SNAP IN connection solutions



- Unique SNAP IN connection for particularly fast, safe and tool-free wiring
- Maximum flexibility with digital configuration for transmitting power, signals and data in one connector
- Future-proof platform connector with integrated functions, such as Single Pair Ethernet
- All products are ready for shipment within 3 days - including individually configured products"



OMNIMATE® Data Single Pair Ethernet Connectors

- Devices can become significantly smaller - Most compact design for implementing IIoT devices (saving of > 50 %)
- Vibration-proof and insensitive to electromagnetic influences - Particularly robust, industry-compatible construction
- The colour-coded two-wire connection technology saves installation time and avoids connection errors - Userfriendly structure for safe and quick installation
- Suitable for IIoT, corresponds to the latest IEEE / IEC standards for data rates from 10Mbit/s to 1Gbit/s. - High future security through compliance with international standards
- Safe locking - Even in the smallest installation space, a robust locking mechanism up to 50N is ensured (acoustic feedback during the mating process)
- Reliable process - Troublefree assembly due to sharpened pin geometry, guide posts and Tape on Reel packaging



**OMNIMATE® Data
RJ45 modular and transformer jacks**

- Future-proof transmission characteristics up to Cat 6 standard for a data rate of up to 1Gbit/s
- Electromagnetic compatibility and protection through 360° shielding
- RJ45 transformer jacks with integrated "magnetics" actively counteract faults and save space on the board
- Reinforced gold layer improves corrosion protection, reduces contact problems and guarantees a long service life



**OMNIMATE® Data
USB PCB jacks**

- Robust plug & play operation - connect and disconnect without shutting down or restarting the system
- Reinforced gold surface - up to 1,500 plugging cycles meet the requirements for high resistance
- High rated current of up to 1.5 A provides sufficient safety reserves with a maximum charging current of 0.9 A
- Flexible deployment thanks to the compatibility of USB 3.0 hosts and devices with version 2.0



**OMNIMATE® Data
D-SUB PCB connectors**

- Simple installation - Due to the straight and angled designs, the sockets integrate into any installation situation.
- High performance – Established locking systems in combination with polarisation and protection of the contacts fulfil standards in electrical applications.
- Broad range of applications – In compliance with the dimensions according to IEC 60807-3 (IEC 807-3) and DIN 41652, a wide variety of applications, such as measuring devices, interfaces and electronic devices, are covered.

Your ideas need the right connections Ours are simply brilliant

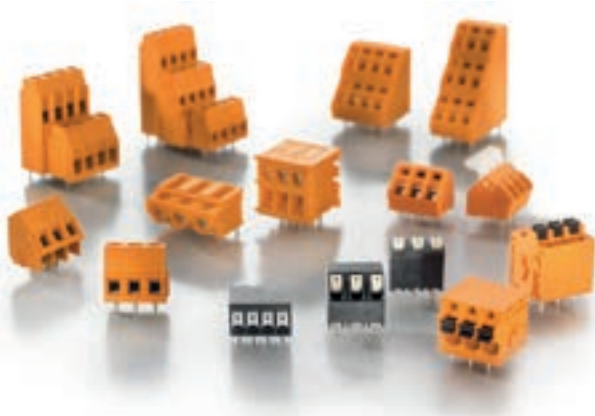

OMNIMATE® Signal PCB terminals



- Application-oriented connection systems ranging from clamping yoke screw connections to PUSH IN spring connections in all relevant cross-section ranges up to 6 mm²
- Can be used universally in all standard pitches from 3.50 mm to 7.62 mm
- A wide range of reflow-compatible products for automated SMT processes
- Compact, multi-layer designs up to 72-pole



OMNIMATE® Signal PCB plug-in connectors



- Compact at 2.50 mm pitch
36 connections at 3.50 mm pitch, highest level of power reserves at 3.81 mm pitch and largest application area at 5.08 mm pitch
- Application-oriented connection systems ranging from clamping yoke screw connections to PUSH IN spring connections.
- A wide range of reflow-compatible products for automated SMT processes
- Multi-row and multi-layer designs up to 48-pole



OMNIMATE® Signal Board-to-Board connectors

- Industrial suitable density combined with high flexible connection combinations (mezzanine, mother-to-daughter, extended-board and Board-to-wire)
- Pitch 1,27mm from 12 – 80 poles in different outlet-directions and heights
- Developed for automatic assembly with high precise pin coplanarity and SMT-fixation
- Reliable contact surface (PdNi-Au) equipped in high-performance material LCP and packed in Tape on reel for automatic assembly



**OMNIMATE® Power
PCB terminals**



- High-power to 150 A / 1000 V (IEC) or 127 A / 600 V (UL)
- Application-oriented scalability with connection cross-sections from 16 mm² to 50 mm²
- Simple UL device approval up to 600 V
- PUSH IN wire connection up to 16 mm²
- Maintenance-free steel clamping yoke for vibration-resistant screw connections



**OMNIMATE® Power
PCB plug-in connectors**



- Application-oriented scalability: from the compact 4 mm² connector for 29 A (IEC) or 20 A (UL) up to the sturdy 16 mm² connector for 76 A (IEC) or 60 A (UL)
- Unlimited usage up to 1000 V (IEC) or 600 V (UL)
- A variety of application-optimised mounting options



**OMNIMATE® Power
Panel feedthrough terminal blocks**



- Clamping yoke screw connection
- PUSH IN wire connection
- Wall and housing feedthrough
- Simple, flexible and cost-saving assembly and connection of conductors
- Cable lug
- Solder connection

Your ideas need the right connections Ours are simply brilliant



OMNIMATE® Housings



- Scalability to meet requirements: from extruded profile to compact housing to modular housing
- Customisable
- Installation housing IP20
- Female plug with mismatching protection
- PUSH IN wire connection
- Clamping yoke screw connection
- Suitable for an automated soldering process with THT & THR Solderable male connectors with high-temperature LCP material and optional tape-on-reel packing

OMNIMATE® 4.0– SNAP IN Connection solutions

Pitch 5.00 mm



Webcode # 11530

MHS 5

Male connector with 90°, 180° and 270° outlet direction for wave and reflow processes.

- Male header
- Pitch: 5.00 mm
- Number of poles: 2–12
- IEC: 400 V / 26.8 A
- UL: 300 V / 18.5 A



Webcode # 11531

MPS 5

Female plug with 180° outlet direction, SNAP IN connection technology and optional self-locking top flange.

- SNAP IN connection
- Pitch: 5.00 mm
- Number of poles: 2–12
- IEC: 400 V / 26.8 A / 0.5–4 mm²
- UL: 300 V / 18.5 A / AWG 20–12/7/9

Pitch 7.50 mm



Webcode # 11539

MHS 7S

Male connector with 90°, 180° and 270° outlet direction for wave and reflow processes.

- Male connector
- Grid: 7.50 mm
- Number of poles: 2–12
- IEC: 630 V / 26.8 A
- UL: 300 V / 18.5 A"



Webcode # 11540

MPS 7S

Female plug with 180° outlet direction, SNAP IN connection system and optional self-locking top flange.

- SNAP IN connection system
- Grid: 7.50 mm
- Number of poles: 2–12
- IEC: 1000 V / 26.8 A / 0.5–4 mm²
- UL: 600 V / 18.5 A / AWG 20–12/7/9

Pitch 7.50 mm + pitch 5.00 mm (Hybrid)



Webcode # 11541

MHS 7S/.. 5

Hybrid male connector consisting of power and signal interfaces for wave and reflow processes.

- Male connector
- Grid: 7.50 mm and 5.00 mm
- Number of poles: 2–12
- IEC: 630 V / 26.8 A
- UL: 300 V / 18.5 A



Webcode # 11542

MPS 7S/.. 5

Hybrid female plug with 180° outlet direction, SNAP IN connection system and optional self-locking top flange.

- SNAP IN connection system
- Grid: 7.50 mm and 5.00 mm
- Number of poles: 2–12
- IEC: 1000 V / 26.8 A / 0.5–4 mm²
- UL: 600 V / 18.5 A / AWG 20–12/7/9"

Pitch 5.00 mm + Single Pair Ethernet (Hybrid)



Webcode # 11532

MHS 5/.. D11

Hybrid male connector with integrated Single Pair Ethernet (SPE) data connection for wave and reflow processes..

- Male header
- Pitch: 5.00 mm
- Number of poles: 2–12
- IEC: 400 V / 26.8 A
- UL: 300 V / 18.5 A



Webcode # 11533

MPS 5/.. D11

Hybrid female plug with SNAP IN connection technology and field attachable Single Pair Ethernet data connector.

- SNAP IN connection
- Pitch: 5.00 mm
- Number of poles: 2–12
- IEC: 400 V / 26.8 A / 0.5–4 mm²
- UL: 300 V / 18.5 A / AWG 20–12/7/9

Pitch 7.50 mm + pitch 5.00 mm + Single Pair Ethernet (Hybrid)



Webcode # 11543

MHS 7S/.. 5/.. D11

Hybrid male connector consisting of power, signal and data interfaces for wave and reflow processes.

- Male connector
- Grid: 7.50 mm and 5.00 mm
- Number of poles: 2–12
- IEC: 630 V / 26.8 A
- UL: 300 V / 18.5 A



Webcode # 11544

MPS 7S/.. 5/.. D11

Hybrid female plug with SNAP IN connection system and field-terminable Single Pair Ethernet data connector.

- SNAP IN connection system
- Grid: 7.50 mm and 5.00 mm
- Number of poles: 2–12
- IEC: 1000 V / 26.8 A / 0.5–4 mm²
- UL: 600 V / 18.5 A / AWG 20–12/7/9

OMNIMATE® Data – Single Pair Ethernet connector

SPE Connector, IP20



Webcode # 11523

IE-PCB-SP0-P-90V-THR

Angled (90°) Single-Pair PCB male header for IP20

- Reflow-soldering (THR)
- Robust housing with metal snap-in mechanism
- Shielded and reinforced contacts (PdNi)
- Performance Category: up to 1Gbit/s
- Plugging cycles: 750
- Packaging in ToR



Webcode # 11550

IE-PCB-SP0-P-90V-THR-YG/YG

Angled (90°) Single-Pair PCB male header for IP20 incl. LED

- Reflow-soldering (THR)
- Robust housing with metal snap-in mechanism
- Shielded and reinforced contacts (PdNi)
- Performance Category: up to 1Gbit/s
- Plugging cycles: 750
- Packaging in ToR*



Webcode # 11551

IE-PCB-SP0-P-180V-THR

Straight (180°) Single-Pair PCB male header for IP20

- Reflow-soldering (THR)
- Robust housing with metal snap-in mechanism
- Shielded and reinforced contacts (PdNi)
- Performance Category: up to 1Gbit/s
- Plugging cycles: 750
- Packaging in ToR



Webcode # 11552

IE-S1DS2VE00..TO..

Overmoulded single-pair patch cable for IP20

- Pre-assembled patch cables
- Industrial design metal snap-in locking hook
- Shielded and reinforced contacts
- Performance Category: up to 1Gbit/s
- Plugging cycles: 750
- Packaging in bag

SPE Connector, IP20



Webcode # 11545

IE-PS-SP0-S-FH-180

Single-Pair IDC Plug for IP20

- field attachable IDC plug
- Industry standard plug with metal Snap-in hooks locking
- Shielded and reinforced contacts
- Performance Category: up to 1Gbit/s
- Plugging cycles: 750
- Packaging in ToR

SPE Connector, IP67



Webcode # 11546

IE-PCB-SPM..

Straight (180°) and angled (90°) Single-Pair PCB connector for IP67

- M8 Connector
- Reflow-soldering (THR) and SMT
- Front and rear wll mounting possible
- Performance Category: up to 1Gbit/s
- Packaging in ToR



Webcode # 11546

IE-S1DS2VE00..TM..

Overmoulded single-pair patch cable for IP67

- M8 Connector
- Inverse M8 System possible (PoDL coding)
- Performance Category: up to 1Gbit/s
- Packaging in bag

OMNIMATE® Data – PCB jacks and plug-in connectors

PCB modular jack



Webcode # 11413

RJ45 solder connection for (THT)
PCB jack for wave soldering process

- Outlet direction: 90° and 180°
- Catch mechanism: up and down
- Performance Category: up to Cat 6
- Plugging cycles: 750
- With / without LEDs



Webcode # 11414

RJ45 solder connection (THR)
PCB jack for reflow and wave soldering process

- Outlet direction: 90° and 180°
- Catch mechanism: up and down
- Performance Category: up to Cat 6
- Plugging cycles: 750
- With / without LEDs



Webcode # 11415

RJ45 solder connection for (SMT)
PCB jack for reflow soldering process

- Outlet direction: 90° and 180°
- Catch mechanism: up and down
- Performance Category: up to Cat 5
- Plugging cycles: 750
- With / without LEDs

RJ45 transformer jacks



Webcode # 11416

RJ45 solder connection for (THT)
PCB jack for wave soldering process

- Integrated magnetics
- Outlet direction: 90°
- Catch mechanism: up and down
- Performance Category: up to 1Gbit/s
- Plugging cycles: 750



Webcode # 11417

RJ45 solder connection (THR)
PCB jack for reflow and wave soldering process

- Integrated magnetics
- Outlet direction: 90° and 180°
- Catch mechanism: up and down
- Performance Category: up to 1Gbit/s
- Plugging cycles: 750
- With / without LEDs



Webcode # 11418

RJ45 solder connection (THT) multiport
PCB jack for wave soldering process

- Integrated magnetics
- Outlet direction: 90°
- Catch mechanism: up and down
- Performance Category: up to 1Gbit/s
- Plugging cycles: 750
- With / without LEDs



Webcode # 11419

RJ45 solder connection (THR) multiport
PCB jack for wave soldering process

- Integrated magnetics
- Outlet direction: 90°
- Catch mechanism: up and down
- Performance Category: up to 1Gbit/s
- Plugging cycles: 750
- With / without LEDs

Plug-in connectors



Webcode # 11312

RJ45 connector „steadytec“
Tool-free and field-attachable plug for Industrial Ethernet

- IDC connection, 4-8-core
- Outlet direction: 180°
- Category: Cat.5 and Cat.6A
- AWG 26...AWG 22 / 0.48...0.76 mm²

Patch cable



Webcode # 11313

RJ45 patch cable
Freely configurable RJ45 cable in a wide range of colours

- Protected latching hook, 8-core
- Outlet direction: 90°, 180° and 270°
- Category: Cat.6A

D-SUB connectors



Webcode # 11528

High-Density D-SUB solder connection for (THT)
PCB connectors for wave soldering process

- Outlet direction: 90°
- Gender: femal, male
- Side termination: threaded nut
- Packed in tray



Webcode # 11462

D-SUB solder connection for (THT)
PCB connectors for wave soldering process

- Outlet direction: 90° and 180°
- Gender: femal, male
- Side termination: hole, nut, bold
- Packed in tray

OMNIMATE® Data – PCB jacks and plug-in connectors

USB jacks



Webcode # 11420

USB 3.0/2.0 solder connection (THT)
PCB jack for wave soldering process

- Outlet direction: 90° and 180°
- Performance Category: up to 5 Gbit/s
- Plugging cycles: ≥1.500
- Packed in tray

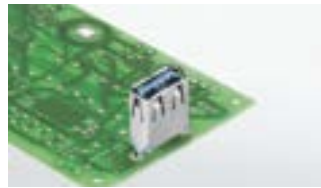

Webcode # 11421

USB 3.0 solder connection (THR)
PCB jack for reflow and wave soldering process

- Outlet direction: 180°
- Performance Category: up to 5 Gbit/s
- Plugging cycles: ≥1.500
- Packed in tray or ToR



Webcode # 11422

USB 2.0 solder connection for (SMT)
PCB jack for reflow soldering process (SMT)

- Outlet direction: 90°
- Performance Category: up to 5 Gbit/s
- Plugging cycles: ≥1.500
- Packed in ToR

Ethernet terminal



Webcode # 11527

LSF-SMT and LMF
PCB terminal for Ethernet-compliant data transmission e.g. for PROFINET (up to 100Mbps)

- PUSH IN spring connection
- Pitch: 3.50, 3.81 and 5.08 mm
- Number of poles: 4
- For all IIoT devices

OMNIMATE® Data – M8 and M12 PCB jacks

M8



Webcode # 11364

M8 Dome (individual part)
PCB circular connector for automatic assembly and M8 threads.

- Number of poles: 3, 4, 8
- Female and male contact
- SMT, THR
- Shielded and unshielded



Webcode # 11366

M8 Front mounting
PCB circular connector with M8 thread for front mounting.

- Number of poles: 3, 4, 8
- Female and male contact
- Outlet direction: 180°
- Shielded and unshielded

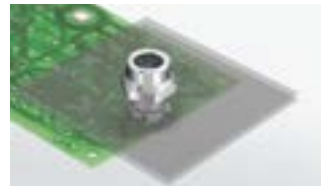

Webcode # 11368

M8 Rear panel mounting
PCB circular connector with M8 thread for rear panel mounting.

- Number of poles: 3, 4, 8
- Female and male contact
- Outlet direction: 90°, 180°
- Shielded and unshielded

M12



Webcode # 11352

M12 Dome (individual part)
PCB circular connector for automatic assembly and M12 threads.

- Number of poles: 4, 5, 8
- Female and male contact
- SMT
- Shielded and unshielded
- Coding: A, B, D



Webcode # 11354

M12 Front mounting
PCB circular connector with M12 thread for front mounting.

- Number of poles: 4, 5, 8
- Female and male contact
- Outlet direction: 90°, 180°
- Shielded and unshielded
- Coding: A, B, D, X



Webcode # 11356

M12 Front mounting
PCB circular connector with M12 thread for front mounting.

- Number of poles: 4, 5, 8
- Female and male contact
- Outlet direction: 90°, 180°
- Shielded and unshielded
- Coding: A, B, D, X

SAI plugs and cables



Webcode # 11529

SAI round plug-in connectors and cables
High IP rated connectivity range of M5, M8, M12, M16 and M23

- Different codings like A, B and D
- Up to protection degree IP 69K
- For mechanically and chemically stressed applications

OMNIMATE® Signal – PCB terminals

Clamping yoke screw connection



Webcode #01010

LM 3.50 / LM1N / LM2N

Small, compact PCB terminal with conductor outlet direction of 90° or 135°.

- Clamping yoke screw connection
- Pitch: 3.50 mm
- Number of poles: 2-12
- IEC: 320 V / 16 A / 0.2-1.5 mm²
- UL: 300 V / 10 A / AWG 28-14



Webcode #01012

LM 5.00/5.08

Single-row PCB terminal with conductor outlet direction of 90°, 135° and 180°.

- Clamping yoke screw connection
- Pitch: 5.00 mm / 5.08 mm
- Number of poles: 2-24
- IEC: 630 V / 17.5 A / 0.2-2.5 mm²
- UL: 300 V / 15 A / AWG 24-14



Webcode #01014

LS 5.08

Small, compact PCB terminal with conductor outlet direction of 90°.

- Clamping yoke screw connection
- Pitch: 5.08 mm
- Number of poles: 2-12
- IEC: 630 V / 17.5 A / 0.08-1.5 mm²
- UL: 300 V / 15 A / AWG 28-14



Webcode #01016

LL 5.00/5.08

Single-row PCB terminal with conductor outlet direction of 90° and 180°.

- Clamping yoke screw connection
- Pitch: 5.00 mm / 5.08 mm
- Number of poles: 2-24
- IEC: 500 V / 32.5 A / 0.5-6 mm²
- UL: 300 V / 20 A / AWG 28-12

Clamping yoke screw connection

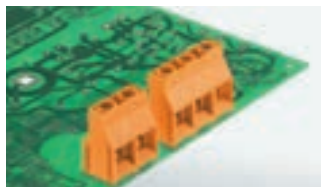

Webcode #01018

LL 9.52

Single-row PCB terminal with conductor outlet direction of 90°.

- Clamping yoke screw connection
- Pitch: 9.52 mm
- Number of poles: 2-3
- IEC: 1,000 V / 32 A / 0.18-6 mm²
- UL: 300 V / 30 A / AWG 26-10

Leaf - spring screw connection



Webcode #01020

PS 3.5

Very small and compact PCB terminal with conductor outlet direction of 90°.

- Leaf-spring screw connection
- Pitch: 3.50 mm
- Number of poles: 2-12
- IEC: 320 V / 17.5 A / 0.2-1.5 mm²
- UL: 300 V / 10 A / AWG 28-16

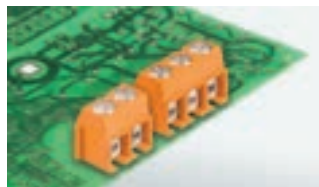

Webcode #01022

PM 5.00/5.08

PCB terminal with conductor inlet direction of 90°.

- Leaf-spring screw connection
- Pitch: 5.00 mm / 5.08 mm
- Number of poles: 2-12
- IEC: 600 V / 24 A / 0.13-2.5 mm²
- UL: 300 V / 15 A / AWG 26-14

PUSH IN - spring connection



Webcode #01028

LSF-SMT 3.5 / 3.81

PCB terminal for fully automatic assembly for THR reflow soldering (SMT) and wave soldering.

- PUSH IN spring connection
- Pitch: 3.50 mm / 3.81 mm
- Number of poles: 2-24
- IEC: 320 V / 17.5 A / 0.2-1.5 mm²
- UL: 300 V / 12 A / AWG 24-16



Webcode #01030

LSF-SMT 5.00 / 5.08

PCB terminal for fully automatic assembly for THR reflow soldering (SMT) and wave soldering.

- PUSH IN spring connection
- Pitch: 5.00 mm / 5.08 mm
- Number of poles: 2-8
- IEC: 500 V / 17.5 A / 0.2-1.5 mm²
- UL: 300 V / 12 A / AWG 24-16



Webcode #01032

LSF-SMT 7.50 / 7.62

PCB terminal for fully automatic assembly for THR reflow soldering (SMT) and wave soldering.

- PUSH IN spring connection
- Pitch: 7.50 mm / 7.62 mm
- Number of poles: 2-8
- IEC: 800 V / 17.5 A / 0.2-1.5 mm²
- UL: 300 V / 12 A / AWG 24-16



Webcode #01034

LSF-SMD 3.5

PCB terminal for fully automatic assembly for reflow soldering (SMT).

- PUSH IN spring connection
- Pitch: 3.50 mm
- Number of poles: 2-12
- IEC: 320 V / 17.5 A / 0.2-1.5 mm²
- UL: 300 V / 12 A / AWG 24-16

OMNIMATE® Signal – PCB terminals

PUSH IN - spring connection



Webcode #01036

LSF-SMD 5.00

PCB terminal for fully automatic assembly for reflow soldering (SMT).

- PUSH IN spring connection
- Pitch: 5.00 mm
- Number of poles: 2-8
- IEC: 500 V / 17.5 A / 0.2-1.5 mm²
- UL: 300 V / 12 A / AWG 24-16



Webcode #01038

LSF-SMD 7.50

PCB terminal for fully automatic assembly for reflow soldering (SMT).

- PUSH IN spring connection
- Pitch: 7.50 mm
- Number of poles: 2-6
- IEC: 800 V / 17.5 A / 0.2-1.5 mm²
- UL: 300 V / 12 A / AWG 24-16

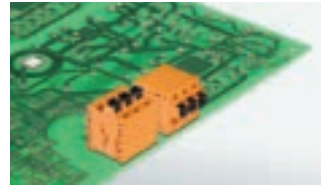

Webcode #01040

LMF 5.00/5.08

PCB terminal with pusher for opening the contact point and an integrated test point.

- PUSH IN spring connection
- Pitch: 5.00 mm / 5.08 mm
- Number of poles: 2-24
- IEC: 400 V / 24 A / 0.2-2.5 mm²
- UL: 300 V / 10 A / AWG 26-12

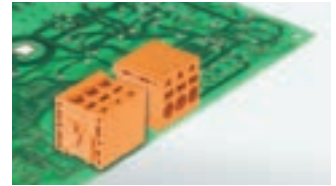

Webcode #01042

LMFS 5.00/5.08

PCB terminal without pusher; contact point can be opened using a screwdriver and integrated test point.

- PUSH IN spring connection
- Pitch: 5.00 mm / 5.08 mm
- Number of poles: 2-24
- IEC: 400 V / 24 A / 0.2-2.5 mm²
- UL: 300 V / 10 A / AWG 26-12

PUSH IN - spring connection

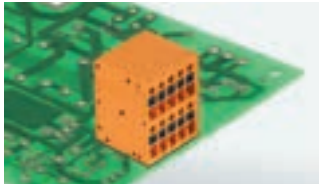

Webcode #01026

LS2HF 3.50

Double-storey PCB terminal for wave soldering processes, with conductor insertion and slider operation from the same direction (TOP).

- PUSH IN spring connection
- Pitch: 3.50 mm
- Number of poles: 4-24
- IEC: 400 V / 10 A / 0.14-1.5 mm²
- UL: 150 V / 12.5 A / AWG 26-16



Webcode #11514

LMF 7.50

PCB terminal with pusher for opening the contact point and an integrated test point.

- PUSH IN spring connection
- Pitch: 7.50 mm
- Number of poles: 2-24
- IEC: 1000 V / 24 A / 0.2-2.5 mm²
- UL: 300 V / 20 A / AWG 26-12



Webcode #11515

LMFS 7.50

PCB terminal without pusher; contact point can be opened using a screwdriver and integrated test point.

- PUSH IN spring connection
- Pitch: 7.50 mm
- Number of poles: 2-24
- IEC: 1000 V / 24 A / 0.2-2.5 mm²
- UL: 300 V / 20 A / AWG 26-12



Webcode #11547

LMFV 5.00/90

PCB terminal with pusher, identical to the tried-and-tested LM 5.00 with clamping yoke connection

- PUSH IN spring connection
- Grid 5.00
- Number of poles 2-24
- IEC: 630 V / 17.5 A / 0.2 - 2.5 mm²
- UL: 300 V / 15 A / AWG 24 - AWG 14

PUSH IN - spring connection



Webcode #11548

LMFV 7.50/90

PCB terminal with pusher

- PUSH IN spring connection
- Grid 7.50
- Number of poles 2-24
- IEC: 630 V / 17.5 A / 0.2 - 2.5 mm²
- UL: 300 V / 15 A / AWG 24 - AWG 14



Webcode #11448

LMZF

Single-row PCB terminal with maintenance-free tension clamp connection and with conductor outlet direction of 135°.

- Tension clamp connection
- Pitch: 5, 7 & 10 mm
- Number of poles: 2-24
- IEC: 630 V/24 A / 0.13 - 2.5 mm²
- UL: 300 V/15 A / AWG 26-AWG 14

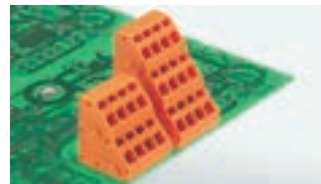

Webcode #11447

LM2NZF & LM3RZF

Multi-level PCB terminal with conductor outlet direction of 135°.

- Tension clamp connection
- Pitch: 5.08 mm
- Number of poles: 2-24
- IEC: 630 V/24 A / 0.13 - 2.5 mm²
- UL: 300 V/15 A / AWG 26-AWG 14

OMNIMATE® Board-to-Board connectors

Pitch 1.27 mm



Webcode # 11516

FMH1
Male header with stack height 1.75 mm

- Reflow-soldering (SMT)
- Pitch: 1.27 mm
- Number of poles: 12-80
- Clear. and creepage distance: min. 0.4 mm
- IEC: 2.8 A (20°C, 12 pole)
- UL: 150 V / 1.7 A (12 pole)



Webcode # 11517

FMH3
Male header with stack height 3.25 mm

- Reflow-soldering (SMT)
- Pitch: 1.27 mm
- Number of poles: 12-80
- Clear. and creepage distance: min. 0.4 mm
- IEC: 2.8 A (20°C, 12 pole)
- UL: 150 V / 1.7 A (12 pole)



Webcode # 11518

FMH
Male header, angled

- Reflow-soldering (SMT)
- Pitch: 1.27 mm
- Number of poles: 12-80
- Clear. and creepage distance: min. 0.4 mm
- IEC: 2.8 A (20°C, 12 pole)
- UL: 150 V / 1.7 A (12 pole)



Webcode # 11549

- FC**
- Assembled cable
 - Different cable types and lengths
 - Pitch: 1.27 mm / 0,635 mm Ribbon Cable
 - 12 - 80 poles
 - IEC: 0,5 A
 - Cross section: AWG 30/7
 - UL 758 flammability rating: VW1

Pitch 1.27 mm



Webcode # 11519

FFH6
Female header with stack height 6.25 mm

- Reflow-soldering (SMT)
- Pitch: 1.27 mm
- Number of poles: 12-80
- Clear. and creepage distance: min. 0.4 mm
- IEC: 2.8 A (20°C, 12 pole)
- UL: 150 V / 1.7 A (12 pole)



Webcode # 11520

FFH9
Female header with stack height 9.05 mm

- Reflow-soldering (SMT)
- Pitch: 1.27 mm
- Number of poles: 12-80
- Clear. and creepage distance: min. 0.4 mm
- IEC: 2.8 A (20°C, 12 pole)
- UL: 150 V / 1.7 A (12 pole)



Webcode # 11521

FFH
Female header, angled

- Reflow-soldering (SMT)
- Pitch: 1.27 mm
- Number of poles: 12-80
- Clear. and creepage distance: min. 0.4 mm
- IEC: 2.8 A (20°C, 12 pole)
- UL: 150 V / 1.7 A (12 pole)



Webcode # 11522

- FFH**
Female plug
- IDC-Connection
 - Pitch: 1.27 mm
 - Number of poles: 12-80
 - Clear. and creepage distance: min. 0.4 mm
 - IEC: 2.8 A (20°C, 12 pole)
 - UL: 150 V / 1.0 A (12 pole) / AWG 30

OMNIMATE® Signal – PCB connectors

Pitch 2.50 mm



Webcode # 11323

BLF 2.50
Female plug for conductor connection with PUSH IN spring connection.

- PUSH IN spring connection
- Pitch: 2.50 mm
- Number of poles: 2-12
- IEC: 320 V / 6 A / 0.08 - 0.5 mm²
- UL: 150 V / 5 A / AWG 28 - 20



Webcode # 11324

SL 2.50
Male header for wave soldering methods for 2.50 mm pitch.

- Male header
- Pitch: 2.50 mm
- Number of poles: 2-12
- IEC: 320 V / 6 A
- UL: 320 V / 6 A

Pitch 3.50 mm double - row design



Webcode # 01060

S2C 3.50
High-temperature-resistant, double-row male header for reflow and wave soldering methods.

- Male header
- Pitch: 3.50 mm
- Number of poles: 4-36
- IEC: 200 V / 13.4 A
- UL: 150 V / 10 A



Webcode # 01058

B2CF 3.50
Compact double-row female plug with maximum connection density within an extremely small space.

- PUSH IN spring connection
- Pitch: 3.50 mm
- Number of poles: 4-46
- IEC: 320 V / 13.4 A / 0.14-1.5 mm²
- UL: 300 V / 9.5 A / AWG 26-16

OMNIMATE® Signal – PCB connectors

Pitch 3.50 mm

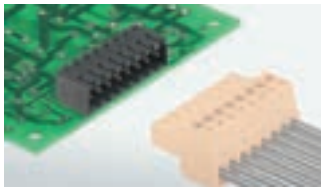

Webcode #01068

SL-SMT 3.50

High-temperature-resistant male header for reflow and wave soldering methods.

- Male header
- Pitch: 3.50 mm
- Number of poles: 2-24
- IEC: 320 V / 15 A
- UL: 300 V / 10 A

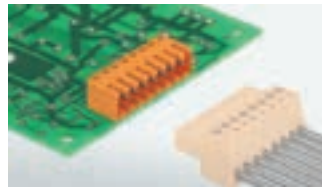

Webcode #01072

SL 3.50

Male header for wave soldering methods.

- Male header
- Pitch: 3.50 mm
- Number of poles: 2-24
- IEC: 320 V / 17 A
- UL: 300 V / 10 A

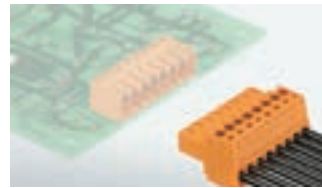

Webcode #01066

BL 3.50

Female plug for conductor connection with clamping yoke screw connection.

- Clamping yoke screw connection
- Pitch: 3.50 mm
- Number of poles: 2-24
- IEC: 320 V / 17 A / 0.2-1.5 mm²
- UL: 300 V / 10 A / AWG 28-14

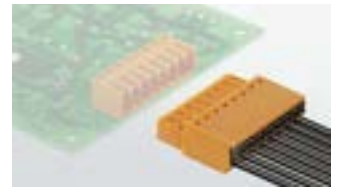

Webcode #11410

BLF 3.5

Female plug with PUSH IN spring connection

- PUSH IN spring connection
- Pitch: 3.50 mm
- Number of poles: 2-24
- IEC: 320 V / 14.5 A / 0.2 - 1.5 mm²
- UL: 300 V / 9.5 A / AWG 28-16

Pitch 3.50 mm

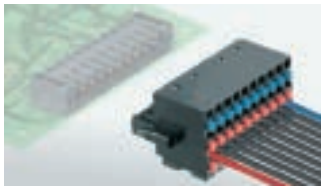

Webcode #01064

BL-I/O 3.5

Extremely compact female plug in one or three-row design and with an integrated LED display.

- PUSH IN spring connection
- Pitch: 3.50 mm
- Number of poles: 10 & 30
- IEC: 200 V / 2.2 A / 0.2-1 mm²
- UL: 50 V / 5 A / AWG 24-16



Webcode #11445

BLI/O CJC

Compact female plug with integrated cold junction compensation.

- PUSH IN spring connection
- Pitch: 3.50 mm
- Number of poles: 10
- IEC: 50 -V / 2.2 A / 0.2 - 1.5 mm²
- UL: 50 V / 5 A / AWG 24 - 16

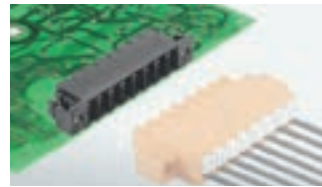

Webcode #01076

SC-SMT 3.81

High-temperature-resistant male header with a very low profile for reflow and wave soldering methods.

- Male header
- Pitch: 3.81 mm
- Number of poles: 2-16
- IEC: 320 V / 17.5 A
- UL: 300 V / 10 A

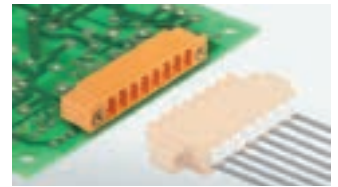

Webcode #01080

SC 3.81

Male header with a very low profile for wave soldering methods.

- Male header
- Pitch: 3.81 mm
- Number of poles: 2-20
- IEC: 320 V / 17.5 A
- UL: 300 V / 10 A

Pitch 3.81 mm



Webcode #11316

SCZ 3.81

Compact male plug for conductor connection with clamping yoke screw connection.

- Clamping yoke screw connection
- Pitch: 3.81 mm
- Number of poles: 2-12
- IEC: 320 V / 17.5 A / 0.14-1.5 mm²
- UL: 300 V / 10 A / AWG 28-16



Webcode #01074

BCZ 3.81

Compact female plug for conductor connection with clamping yoke screw connection.

- Clamping yoke screw connection
- Pitch: 3.81 mm
- Number of poles: 2-20
- IEC: 320 V / 17.5 A / 0.14-1.5 mm²
- UL: 300 V / 10 A / AWG 28-16



Webcode #01078

BCF 3.81

Female plug with very low profile for conductor connection with PUSH IN spring connection.

- PUSH IN spring connection
- Pitch: 3.81 mm
- Number of poles: 2-18
- IEC: 320 V / 17.5 A / 0.2-1.5 mm²
- UL: 300 V / 10 A / AWG 28-16



Webcode #01082

BCL-SMT 3.81

High-temperature-resistant female header with a very low profile for reflow soldering methods.

- Female header
- Pitch: 3.81 mm
- Number of poles: 2-12
- IEC: 320 V / 17.5 A
- UL: 300 V / 10 A

OMNIMATE® Signal – PCB connectors

Pitch 5.00 mm



Webcode # 11444

SL-SMT 5.00HC

High-temperature-resistant, bent pin header, optimized for automatic assembly and reflow and wave soldering.

- Male header
- Pitch: 5.00 mm
- Number of poles: 2-24
- IEC: 400 V / 27.5 A
- UL: 300 V / 18.5 A

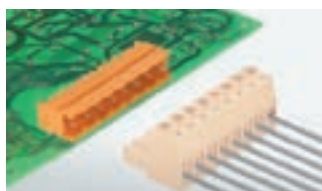

Webcode # 01095

SL 5.00

Pin headers with solder pin length optimized for wave flow soldering.

- Male header
- Pitch: 5.00 mm
- Number of poles: 2-24
- IEC: 400 V / 24 A
- UL: 300 V / 18.5 A



Webcode # 11461

SLD 5.00

2-tier male header with parallel pin arrangement with outlet direction of 90° & 180°, optimized for wave soldering methods.

- Male header
- Pitch: 5.00 mm
- Number of poles: 4-48
- IEC: 400 V / 15 A
- UL: 300 V / 10 A



Webcode # 01165

BLZP 5.00HC

High-current-female-plug for outlet direction of 90°, 180° or 270°.

- Clamping yoke screw connection
- Pitch: 5.00 mm
- Number of poles: 2-24
- IEC: 400 V / 23 A / 0.2-4 mm²
- UL: 300 V / 20 A / AWG 30-12

Pitch 5.00 mm



Webcode # 11442

BLF 5.00HC

Compact high-current-female-plug for outlet direction of 90°, 180° or 270°.

- PUSH IN spring connection
- Pitch: 5.00 mm
- Number of poles: 2-24
- IEC: 400 V / 24 A / 0.2-2.5 mm²
- UL: 300 V / 18.5 A / AWG 26-12

Pitch 5.08 mm

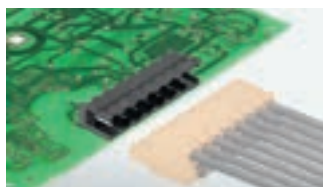

Webcode # 01090

SL-SMT 5.08HC

Highly temperature-resistant angled male header optimised for automatic assembly and for reflow and wave soldering methods.

- Male header
- Pitch: 5.08 mm
- Number of poles: 2-24
- IEC: 400 V / 27.5 A
- UL: 300 V / 18.5 A



Webcode # 11441

SLDV-THR 5.08

High-temperature resistant, double level, laterally offset, male connector with flange or solder flange.

- Male header
- Pitch: 5.08 mm
- Number of poles: 4-48
- IEC: 400 V / 15 A
- UL: 300 V / 10 A

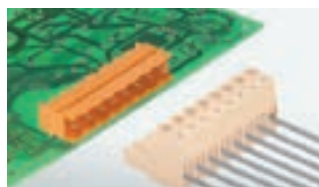

Webcode # 01094

SL 5.08HC

Male headers in glass-fibre-reinforced plastic, optimised for wave soldering methods.

- Male header
- Pitch: 5.08 mm
- Number of poles: 2-24
- IEC: 400 V / 24 A
- UL: 300 V / 18.5 A

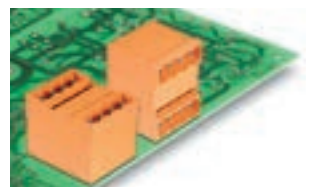

Webcode # 11440

SLD 5.08

2-tier male header with parallel or laterally offset pin arrangement with with outlet direction of 90° & 180°, optimized for wave soldering methods.

- Male header, parallel or laterally offset
- Pitch: 5.08 mm
- Number of poles: 4-48
- IEC: 400 V / 15 A
- UL: 300 V / 10 A

Product overview

OMNIMATE® Signal – PCB connectors

Pitch 5.08 mm

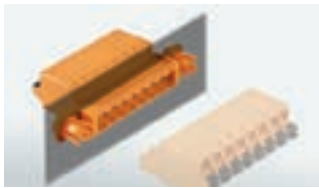

Webcode #01098

SLF 5.08

Male plugs with straight outlet direction provide space for labelling and can be coded.

- PUSH IN spring connection
- Pitch: 5.08 mm
- Number of poles: 2-12
- IEC: 400 V / 25.9 A / 0.2-2.5 mm²
- UL: 300 V / 14 A / AWG 26-12



Webcode #01087

SLS 5.08

Male plug with clamping-yoke screw wire-connect system. Clamping yoke screw connection

- Pitch: 5.08 mm
- Number of poles: 2-24
- IEC: 400 V / 21.5 A / 0.2-2.5 mm²
- UL: 300 V / 14 A / AWG 26-AWG 12

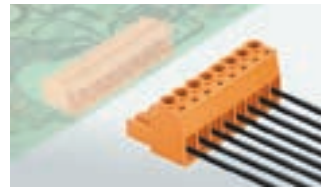

Webcode #01084

BLZP 5.08HC

High-current female plug for conductor connection with 90°, 180° to 225° and 270° outlet direction.

- Clamping yoke screw connection
- Pitch: 5.08 mm
- Number of poles: 2-24
- IEC: 400 V / 23 A / 0.2-4 mm²
- UL: 300 V / 20 A / AWG 30-12

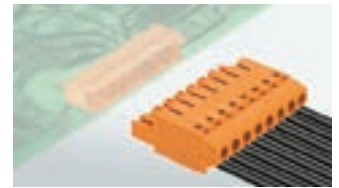

Webcode #01092

BLT 5.08HC

High-current female plug for conductor connection with a straight 180° outlet direction and space for labelling.

- TOP screw connection
- Pitch: 5.08 mm
- Number of poles: 2-24
- IEC: 400 V / 27 A / 0.2-2.5 mm²
- UL: 300 V / 17 A / AWG 26-14

Pitch 5.08 mm



Webcode #01088

BLF 5.08HC

Compact high-current female plug for conductor outlet directions of 90° to 180° and 270°.

- PUSH IN spring connection
- Pitch: 5.08 mm
- Number of poles: 2-24
- IEC: 400 V / 24 A / 0.2-2.5 mm²
- UL: 300 V / 18.5 A / AWG 26-12

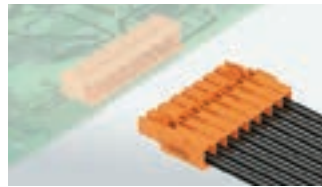

Webcode #01096

BLC 5.08

Female plug to allow for the pre-assembly of wiring harnesses in large quantities.

- Crimp connection system
- Pitch: 5.08 mm
- Number of poles: 2-16
- IEC: 400 V / 21 A
- UL: 300 V / 10 A / AWG 26-14

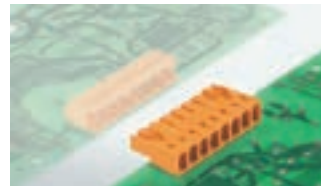

Webcode #01100

BLL 5.08

Female header for PCB assembly with 90° and 180° outlet direction and optimised solder pin length for wave soldering methods.

- Female header
- Pitch: 5.08 mm
- Number of poles: 2-24
- IEC: 400 V / 23 A
- UL: 300 V / 15 A

Rectangular connector



Webcode #11360

RSV 1.6 C

Rectangular connector for a high component density, for use as a free coupling or a PCB variant.

- Crimp connection system
- Pitch: 5.00 mm
- Number of poles: 4-36
- IEC: 630 V / 17 A
- UL: 600 V / 10 A / AWG 26-12

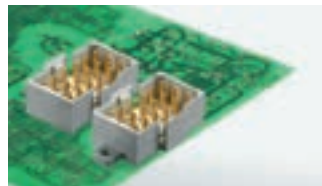

Webcode #01106

RSV 1.6 L

Rectangular connector with solder pin and solder jack contacts for PCB applications.

- Solder pin contacts
- Pitch: 5.00 mm
- Number of poles: 4-36
- IEC: 500 V / 14 A
- UL: 300 V / 10 A

Accessories

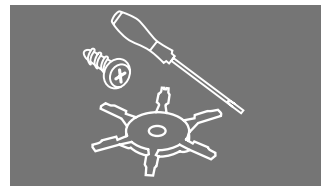

Webcode #11439

Accessories

For signal PCB terminals

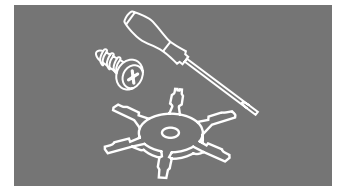

Webcode #11438

Accessories

For signal PCB connectors

OMNIMATE® Power – PCB terminals

Clamping yoke screw connection



Webcode #01044

LL 6.35

High-performance PCB terminal with offset solder pins and conductor outlet direction of 90°.

- Clamping yoke screw connection
- Pitch: 6.35 mm
- Number of poles: 2-12
- IEC: 1.000 V / 32 A / 0.18-6 mm²
- UL: 600 V / 30 A / AWG 26-10



Webcode #01048

LU 10.16

High-performance PCB terminal with offset solder pins and conductor outlet direction of 90°.

- Clamping yoke screw connection
- Pitch: 10.16 mm
- Number of poles: 2-10
- IEC: 1.000 V / 76 A / 0.5-16 mm²
- UL: 300 V / 65 A / AWG 26-6

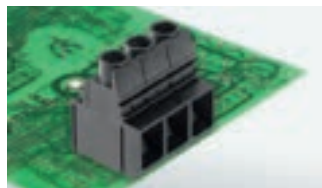

Webcode #01050

LUP 10.16 V with test point

High-performance PCB terminal with integrated test point and conductor outlet direction of 90°.

- Clamping yoke screw connection
- Pitch: 10.16 mm
- Number of poles: 2-9
- IEC: 1.000 V / 76 A / 0.5-16 mm²
- UL: 600 V / 51 A / AWG 26-6

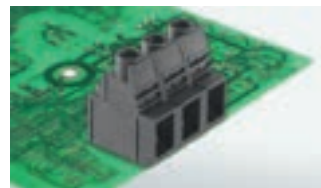

Webcode #01052

LUP 12.70 with test point

High-performance PCB terminal with integrated test point and conductor outlet direction of 90°.

- Clamping yoke screw connection
- Pitch: 12.70 mm
- Number of poles: 2-9
- IEC: 1.000 V / 76 A / 0.5-16 mm²
- UL: 600 V / 58 A / AWG 26-6

Clamping yoke screw connection

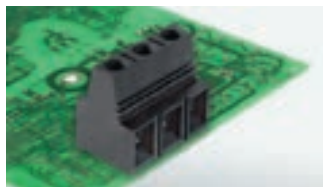

Webcode #01054

LX 15.00 with test point

High-performance PCB terminal with integrated test point and conductor outlet direction of 90°.

- Clamping yoke screw connection
- Pitch: 15.00 mm
- Number of poles: 1-9
- IEC: 1.000 V / 101 A / 1.5-25 mm²
- UL: 600 V / 85 A / AWG 16-4



Webcode #01056

LXXX 15.00 with test point

High-performance PCB terminal with integrated test point and conductor outlet direction of 90°.

- Clamping yoke screw connection
- Pitch: 15.00 mm
- Number of poles: 1-9
- IEC: 1.000 V / 150 A / 0.5-50 mm²
- UL: 600 V / 127 A / AWG 20-1

PUSH IN spring connection



Webcode #11408

LLF/LLFS 7.5

Highly reliable PCB terminals with integrated test point and conductor outlet direction of 90° and 180°.

- PUSH IN spring connection
- Fast wiring without tool (LLF 7.50)
- Pitch: 7.5 mm
- Number of poles: 1-12
- IEC: 1.000 V / 41 A / 0.5-6 mm²
- UL: 600 V / 35 A / AWG 24-8

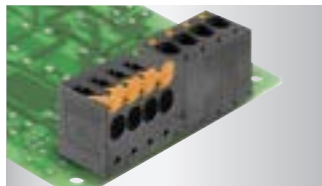

Webcode #01046

LUF/LUFS 10

Highly reliable PCB terminals with integrated test point and conductor outlet direction of 90° and 180°.

- PUSH IN spring connection
- Fast wiring without tool (LUF10)
- Pitch: 10.00 mm
- Number of poles: 1-12
- IEC: 1.000 V / 76 A / 0.5-16 mm²
- UL: 600 V / 61 A / AWG 18-6



Webcode #11409

LUF/LUFS 15

Highly reliable PCB terminals with integrated test point and conductor outlet direction of 90° and 180°.

- PUSH IN spring connection
- Fast wiring without tool (LUF 15)
- Pitch: 15.00 mm
- Number of poles: 2-8
- IEC: 1.000 V / 76 A / 0.5-16 mm²
- UL: 1.000 V / 57 A / AWG 18-6

OMNIMATE® Power – PCB connectors

OMNIMATE® Power Hybrid



Webcode # 11437

SV-SMT 7.62 hybrid

High-temperature-resistant hybrid male header with energy and signal contacts.

- Male header
- Pitch: 7.62 mm
- Pole count: 2/4-5/8
- IEC: 1.000 V / 41 A
- UL: 300 V / 35 A



Webcode #01112

SV 7.62 hybrid

Hybrid male header with energy and signal contacts.

- Male header
- Pitch: 7.62 mm
- Pole count: 2/4-5/8
- IEC: 1.000 V / 41 A
- UL: 300 V / 35 A



Webcode # 11465

BVF 7.62HP hybrid

Hybrid female plug - the perfect 2-in-1 solution for the simultaneous combination of energy and signals. Available with plug-in EMC shield support on request.

- PUSH IN spring connection
- Pitch: 7.62 mm
- Pole count: 2/4-5/8
- IEC: 1.000 V / 38 A / 0.5-10 mm²
- UL: 600 V / 35 A / AWG 24-8



Webcode # 11466

BVFL 7.62 hybrid

Hybrid female plug with Wire-Ready PUSH IN the perfect 2-in-1 solution for the simultaneous combination of energy and signals.

- Wire-Ready PUSH-IN spring connection
- Pitch: 7.62 mm
- Pole count: 2 / 4-5 / 8
- IEC: 1.000 V / 38 A / 0.5-6 mm
- UL: 600 V / 35 A / AWG 24-8

OMNIMATE® Power Hybrid



Webcode # 11467

BVF 7.62 hybrid with pluggable shield connection

Hybrid female plug with pluggable shield connection to printed circuit board.

- PUSH IN spring connection
- Pitch: 7.62 mm
- Pole count: 4-4
- IEC: 1.000 V / 38 A / 0.5-10 mm
- UL: 600 V / 35 A / AWG 24-8



Webcode # 11468

BVFL 7.62 hybrid with pluggable shield connection

Hybrid female plug with Wire-Ready PUSH IN and pluggable shield connection to printed circuit board.

- Wire-Ready PUSH IN spring connection
- Pitch: 7.62 mm
- Pole count: 4-4
- IEC: 1.000 V / 38 A / 0.5-6 mm
- UL: 600 V / 35 A / AWG 24-8



Webcode # 11481

BVF 7.62 hybrid with pluggable shield connection

Hybrid female plug with pluggable shield connection to the device metall housing.

- PUSH IN spring connection
- Pitch: 7.62 mm
- Pole count: 4-4
- IEC: 1.000 V / 38 A / 0.5-10 mm
- UL: 600 V / 35 A / AWG 24-8



Webcode # 11480

BVFL 7.62 hybrid with pluggable shield connection

Hybrid female plug with Wire-Ready PUSH-IN and pluggable shield connection to the device metall housing.

- Wire-Ready PUSH IN spring connection
- Pitch: 7.62 mm
- Pole count: 4-4
- IEC: 1.000 V / 38 A / 0.5-6 mm
- UL: 600 V / 35 A / AWG 24-8

OMNIMATE® Power IT



Webcode #01116

SL 7.62IT

Male header with optional solder flange attachment and with leading contact for IT networks.

- Male header
- Pitch: 7.62 mm
- Number of poles: 2-6
- IEC: 630 V / 29 A
- UL: 300 V / 20 A



Webcode #01114

BLZ 7.62IT

Female plug with 180° outlet direction and touch safety for IT networks with self-locking centre flange.

- Clamping yoke screw connection
- Pitch: 7.62 mm
- Number of poles: 2-6
- IEC: 1,000 V / 41 A / 0.2-6 mm²
- UL: 600 V / 40.5 A / AWG 24-8



Webcode # 11469

SV-SMT 7.62IT

High temperature-resistant male haeder with leading contact for IT-networks.

- Male header
- Pitch: 7.62 mm
- Number of poles: 2-5
- IEC: 1.000 V / 41 A
- UL: 300 V / 40.5 A

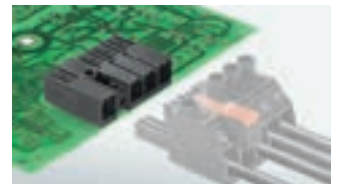

Webcode #01120

SV 7.62IT

Male header with optional solder flange attachment and with leading contact for IT networks.

- Male header
- Pitch: 7.62 mm
- Number of poles: 2-4
- IEC: 1.000 V / 41 A
- UL: 300 V / 40.5 A

OMNIMATE® Power – PCB connectors

OMNIMATE® Power IT



Webcode #01118

BVZ 7.62IT

Female plug with 180° outlet direction and touch safety for IT networks with self-locking centre flange.

- Clamping yoke screw connection
- Pitch: 7.62 mm
- Number of poles: 2-4
- IEC: 1,000 V / 41 A / 0.2-6 mm²
- UL: 600 V / 40.5 A / AWG 24-8



Webcode #01124

SU 10.16IT

Male header with optional solder flange attachment and with leading contact for computer networks.

- Male header
- Pitch: 10.16 mm
- Number of poles: 2-4
- IEC: 1,000 V / 76 A
- UL: 300 V / 60 A



Webcode #01122

BUZ 10.16IT

Female plug with 180° outlet direction and touch safety for IT networks with self-locking centre flange.

- Clamping yoke screw connection
- Pitch: 10.16 mm
- Number of poles: 2-4
- IEC: 1,000 V / 78 A / 0.2-16 mm²
- UL: 300 V / 60 A / AWG 22-4



Webcode #11479

BUZ 10.16IT SH

Female plug with 180° outlet direction and touch safety for IT networks with self-locking centre flange and pluggable shield connection to the device metall housing.

- Clamping yoke screw connection
- Pitch: 10.16 mm
- Number of poles: 3-4
- IEC: 1,000 V / 76 A / 2.5-16 mm²
- UL: 600 V / 55 A / AWG 22-4

OMNIMATE® Power IT



Webcode #11407

BUF 10.16IT

Female plug with 180° outlet direction for IT networks with self-locking centre flange.

- PUSH IN spring connection
- Pitch: 10.16 mm
- Number of poles: 2-5
- IEC: 1,000 V / 76 A / 2.5 - 16 mm²
- UL: 600 V / 55 A / AWG 12 - AWG 4



Webcode #11471

BUF 10.16IT SH

Female plug with 180° outlet direction and touch safety for IT networks with self-locking centre flange and pluggable shield connection to the device metall housing.

- PUSH IN spring connection
- Pitch: 10.16 mm
- Number of poles: 3-4
- IEC: 1,000 V / 76 A / 2.5-16 mm²
- UL: 600 V / 55 A / AWG 12-4

OMNIMATE® Power HP pitch 4 mm²



Webcode #01130

SL 7.62HP

Male header with single compartment mating profile and touch protection.

- Male header
- Pitch: 7.62 mm
- Number of poles: 2-12
- IEC: 630 V / 29 A
- UL: 300 V / 20 A



Webcode #01134

SLF 7.62HP

Male plug with single compartment mating profile with 180° outlet direction as touch-safe solution for the reverse voltage in HP networks.

- PUSH IN spring connection
- Pitch: 7.62 mm
- Number of poles: 2-5
- IEC: 1,000 V / 24 A / 0.5-2.5 mm²
- UL: 600 V / 20 A / AWG 20-12



Webcode #11472

SLF 7.62HP SH

Male plug with single compartment mating profile with 180° outlet direction as touch-safe solution for the reverse voltage in HP networks, with pluggable shield connection to the device metall housing.

- PUSH IN spring connection
- Pitch: 7.62 mm
- Number of poles: 4
- IEC: 1,000 V / 24 A / 0.5-2.5 mm²
- UL: 600 V / 20 A / AWG 20-12



Webcode #01126

BLZ 7.62HP

Female plug with single compartment mating profile with 180° outlet direction and touch protection for HP networks.

- Clamping yoke screw connection
- Pitch: 7.62 mm
- Number of poles: 2-12
- IEC: 630 V / 29 A / 0.2-4 mm²
- UL: 600 V / 20 A / AWG 20-12

OMNIMATE® Power – PCB connectors

OMNIMATE® Power HP pitch 4 mm²



Webcode #01128

BLF 7.62HP

Female plug with single compartment mating profile with 180° outlet direction and touch protection for HP networks.

- PUSH IN spring connection
- Pitch: 7.62 mm
- Number of poles: 2-12
- IEC: 1,000 V / 24 A / 0.5-2.5 mm²
- UL: 600 V / 20 A / AWG 20-12



Webcode #01136

BLL 7.62HP

Touch-safe female header with single compartment mating profile for the PCB with one-hand safety interlock.

- Female header
- Pitch: 7.62 mm
- Number of poles: 2-5
- IEC: 630 V / 24 A
- UL: 300 V / 20 A

OMNIMATE® Power HP pitch 10 mm²



Webcode # 11473

SV-SMT 7.62HP

High temperature-resistant single-row male header for pole-loss-safe attachment or for use with patented multi-function flanges for TNC(S) networks.

- Male header
- Pitch: 7.62 mm
- Number of poles: 2-5
- IEC: 1,000 V / 41 A
- UL: 300 V / 40.5 A



Webcode #01142

SV 7.62HP

High-performance single-row male header for pole-loss-safe attachment or for use with patented multi-function flanges for TNC(S) networks.

- Male header
- Pitch: 7.62 mm
- Number of poles: 2-12
- IEC: 1,000 V / 41 A
- UL: 300 V / 40.5 A



Webcode#11474

SVD 7.62HP

Double-row high-current, high-performance pin headers for pole-loss-safe attachment or for use with patented multi-function flanges for TNC(S) networks.

- Male header
- Pitch: 7.62 mm
- Number of poles: 4-12
- IEC: 1,000 V / 47 A
- UL: 300 V / 30 A



Webcode # 11475

SVF 7.62HP

High-performance male plug with 180° outlet direction as a three-flange version for the housing feedthrough for TNC(S) networks.

- PUSH IN spring connection
- Pitch: 7.62 mm
- Number of poles: 2-6
- IEC: 1,000 V / 41 A / 0.5-10 mm²
- UL: 600 V / 35 A / AWG 24-10

OMNIMATE® Power HP pitch 10 mm²



Webcode # 11476

SVFL 7.62HP

High-performance male plug with 180° outlet direction as a three-flange version for the housing feedthrough for TNC(S) networks.

- Wire-Ready PUSH IN spring connection
- Pitch: 7.62 mm
- Number of poles: 2-6
- IEC: 1,000 V / 41 A / 0.5-6 mm²
- UL: 600 V / 35 A / AWG 24-10



Webcode #01138

BVZ 7.62HP

High-performance female plug for pole-loss-safe attachment or for use with patented multi-function flanges for TNC(S) networks.

- Clamping yoke screw connection
- Pitch: 7.62 mm
- Number of poles: 2-12
- IEC: 1,000 V / 41 A / 0.2-6 mm²
- UL: 600 V / 40.5 A / AWG 24-8

OMNIMATE® Power – PCB connectors

OMNIMATE® Power HP pitch 10 mm²



Webcode #11477

BVF 7.62HP

High-performance female plug with 180° outlet direction as a touch-safe solution for the power output for TNC(S) networks.

- PUSH IN spring connection
- Pitch: 7.62 mm
- Number of poles: 2-7
- IEC: 1.000 V / 41 A / 0.5-10 mm²
- UL: 600 V / 35 A / AWG 24-8



Webcode #11478

BVFL 7.62HP

High-performance female plug with 180° outlet direction as a touch-safe solution for the power output for TNC(S) networks.

- Wire-Ready PUSH-IN spring connection
- Pitch: 7.62 mm
- Number of poles: 2-5
- IEC: 1.000 V / 41 A / 0.5-6 mm²
- UL: 600 V / 35 A / AWG 24-8



Webcode #11512

BVDF 7.62HP

Bus connector with two connections per pole with the time-saving 6mm² PUSH IN connection system

- Female header
- Pitch: 7.62 mm
- Number of Poles: 2-8
- IEC: 600 V / 46 A / 0.5 - 10 mm²
- UL: 600 V / 35 A / AWG 24 - AWG 8



Webcode #01148

BVL 7.62HP

High-performance female header for pole-loss-safe attachment or for use with patented multi-function flanges for TNC(S) networks.

- Female header
- Pitch: 7.62 mm
- Number of poles: 2-7
- IEC: 1.000 V / 41 A
- UL: 300 V / 35 A

OMNIMATE® Power HP pitch 10.16 mm²

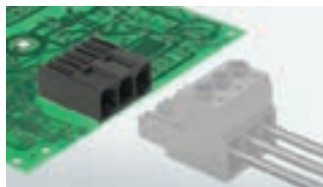

Webcode #01152

SU 10.16HP

High-performance single-row male header for pole-loss-safe attachment or for use with patented multi-function flanges for TNC(S) networks.

- Male header
- Pitch: 10.16 mm
- Number of poles: 2-9
- IEC: 1.000 V / 76 A
- UL: 300 V / 60 A



Webcode #01154

SUZ 10.16HP

High-performance male plug with 180° outlet direction and high-strength contact system for TNC(S) networks.

- Clamping yoke screw connection
- Pitch: 10.16 mm
- Number of poles: 2-9
- IEC: 1.000 V / 78 A / 0.2-16 mm²
- UL: 600 V / 54 A / AWG 24-6



Webcode #01150

BUZ 10.16HP

High-performance female plug with 180° outlet direction for pole-loss-safe attachment or for use with patented multi-function flanges for TNC(S) networks.

- Clamping yoke screw connection
- Pitch: 10.16 mm
- Number of poles: 2-9
- IEC: 1.000 V / 78 A / 0.2-16 mm²
- UL: 600 V / 60 A / AWG 22-4



Webcode #01156

BUL 10.16HP

High-performance female header with 180° outlet direction and high-strength contact system for TNC(S) networks.

- Female header
- Pitch: 10.16 mm
- Number of poles: 2-4
- IEC: 1.000 V / 76 A
- UL: 300 V / 57 A

PUSH IN spring connection



Webcode #01158

PGK

Device feedthrough terminal blocks with disc design and intuitive locking for a quick and compact solution.

- PUSH IN spring connection
- Connection cross-section: up to 4 mm²
- IEC: 500 V / 32 A / 0.5-4 mm²
- UL: 300 V / 30 A / AWG 24-10

Clamping yoke screw connection



Webcode #01160

WGK

High-current feed-through terminals as a universal solution to guide currents of various scales through the device wall.

- Clamping yoke screw connection
- Connection cross-section: 6 to 95 mm²
- IEC: 1.000 V / 232 A / 0.5-95 mm²
- UL: 600 V / 230 A / AWG 24-4/0

Accessories

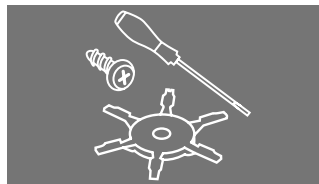

Webcode #11463

Accessories

For Power feed-through terminals

OMNIMATE® Power – PCB- connector cross connection

OMNIMATE® Power bus and T-connector



Webcode #11513

PB 160

Modular current bar solution, for multi-axis servo amplifiers intermediate circuit and 24 V control voltage supply.

- Modular SNAP-IN bus system
- Tool less connection
- Number of poles: 2
- IEC: 1000 V / 160 A
- UL: 750 V DC / 160 A

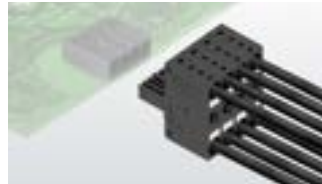

Webcode #11512

BVDF 7.62HP

T-connector with two connections per pole with the time-saving 6 mm² PUSH IN connection system.

- Female header
- Pitch: 7.62 mm
- Number of Poles: 2-8
- IEC: 600 V / 46 A / 0.5 -10 mm²
- UL: 600 V / 35 A / AWG 24 - AWG 8

OMNIMATE® Housings

CH20M



Webcode # 11334

CH20M6

The tailor-made solution for a wide application spectrum. Fits in any terminal strip.

- Housing width: 6.1 mm
- Connection levels on each side: 4
- Connectable conductors: 8
- Connection technology reflow-compatible: yes
- Circuit board capacity: 1
- Variable circuit board positions: no



Webcode # 11335

CH20M12

The "small" option amongst the "large" housing solutions for compact electronics applications.

- Housing width: 12.5 mm
- Connection levels on each side: 3
- Connectable conductors: 12
- Connection technology reflow-compatible: yes
- Circuit board capacity: 1
- Variable circuit board positions: yes



Webcode # 11336

CH20M17

Ideal housing solution for compact standard electronics applications.

- Housing width: 17.5 mm
- Connection levels on each side: 3
- Connectable conductors: 18
- Connection technology reflow-compatible: yes
- Circuit board capacity: 1
- Variable circuit board positions: yes



Webcode # 11337

CH20M22

Standard format with optimal width for most typical electronics applications.

- Housing width: 22.5 mm
- Connection levels on each side: 3
- Connectable conductors: 24
- Connection technology reflow-compatible: yes
- Circuit board capacity: 1
- Variable circuit board positions: yes

CH20M



Webcode # 11338

CH20M45

Extra-large size for electronics applications that require more space, such as compact controllers and power supplies.

- Housing width: 45 mm
- Connection levels on each side: 3
- Connectable conductors: 48
- Connection technology reflow-compatible: yes
- Circuit board capacity: 2
- Variable circuit board positions: yes



Webcode # 11339

CH20M67

XXL size for those electronics applications that require lots of space, such as compact controllers and power supplies.

- Housing width: 67.5 mm
- Connection levels on each side: 3
- Connectable conductors: 72
- Connection technology reflow-compatible: yes
- Circuit board capacity: 3
- Variable circuit board positions: yes



Webcode # 11436

Connection system CH20M

PCB terminal or male header and plug-in connectors for the CH20M housing.

- PUSH IN spring connection
- Clamping yoke screw connection
- Protection against mismatching of connections
- Grid: 5.00 mm
- Number of poles 1-4
- IEC: 400 V / 10 A / 0.25-2.5 mm²
- UL: 300 V / 10 A / AWG 26-12

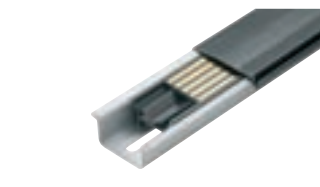

Webcode # 11435

Tragschienenbus-System CH20M

Der durchgängige Tragschienenbus für das modulare Elektronikgehäuse-System

- für alle Gehäusebreiten durchgängig verwendbar
- einfache Integration in die TS35 Tragschiene
- Reflow-lötfähige BUS-Kontakte

MICROBOX



Webcode # 11434

Small enclosure with 6 screw and tension clamp connections

- Clamping yoke screw connection for conductors up to 2.5 mm²
- Tension clamp connection for conductors up to 1.5 mm²
- Vibration-resistant contacts
- Vibration-free terminal rail mounting
- Enclosure wall clipped on securely

TERMINALBOX



Webcode # 11433

Small housing with 4 to 6 connection, in screw-connection and tension-clamp versions

- Versatile arrangements of circuit boards and transparent top plate for clear, permanent labelling
- Cover plates for sealing the enclosure
- Compatible with terminal rails TS32 and TS35

Modular housings of profile form series RS



Webcode # 11432

Modular housings of profile form

- PCB width 45 mm - 122 mm
- Variable heights
- Different installation variations
- Solid hoods
- Can be individually cut to length

Services & products in use

Services & products in use	Service	A.2
	AppGuide - Products in use	A.10

Device developments designed with unique efficiency OMNIMATE® during a typical device development phase

Efficient planning and design-in processes save you valuable time in product development. In addition to our PCB components, we offer a wide range of support tools and services.



Information

We support you with specialist expertise and detailed information. Do you have any questions about device development in accordance with UL 600 V or would you like to find out about the benefits of PUSH IN technology? Our white papers and webinars provide you with comprehensive, compact and useful information.

Webcode #11358



Use

Your information edge: Our handling videos provide you step by step with useful information and important details on handling the various products. This makes the design-in process and installation even easier, safer and more pleasant for you.

Webcode #11536

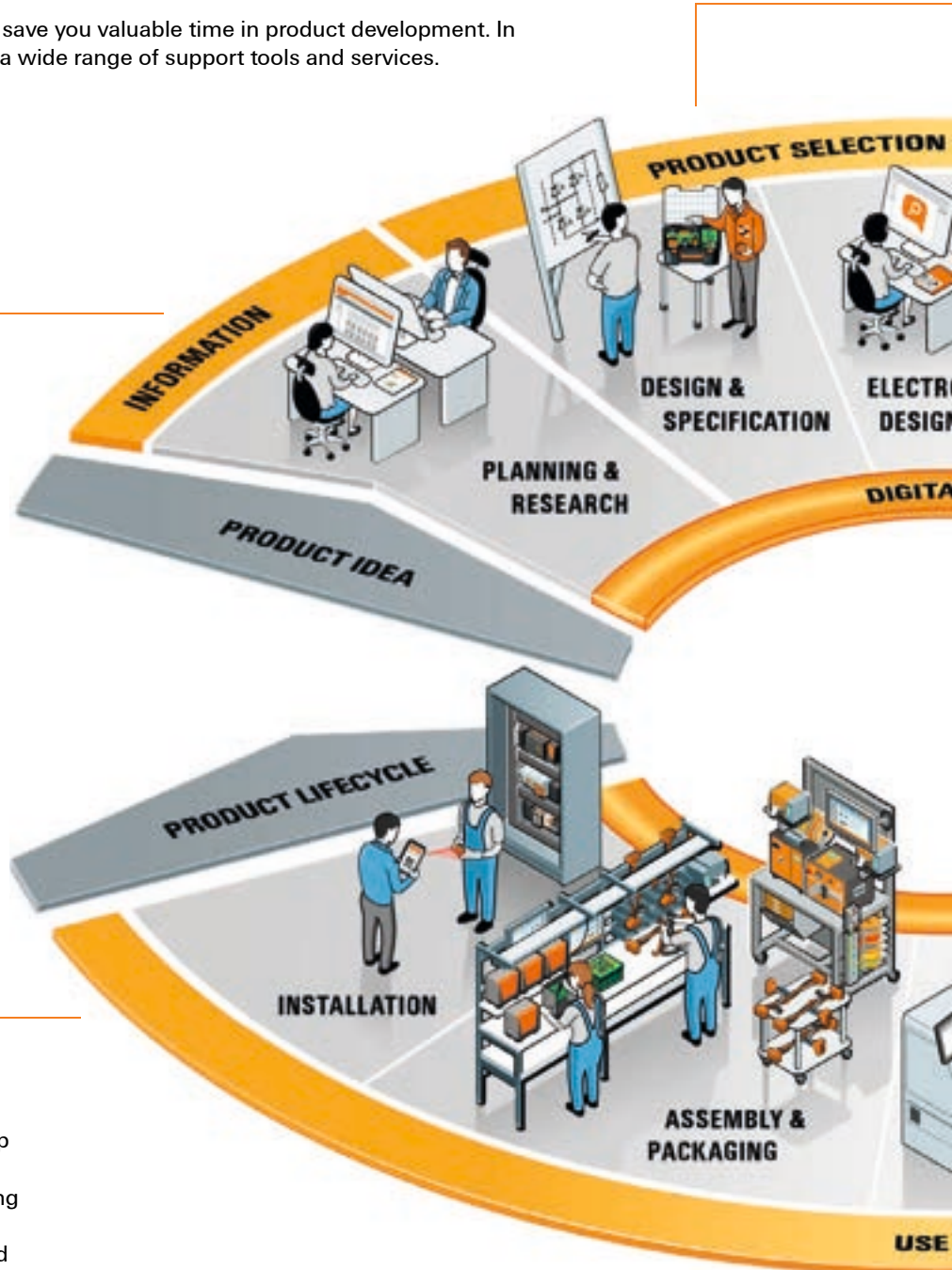

24/7 Online-Services

The right know-how at any time, helpful support and reliable services for your device development.
www.weidmueller.com/omnimate-services

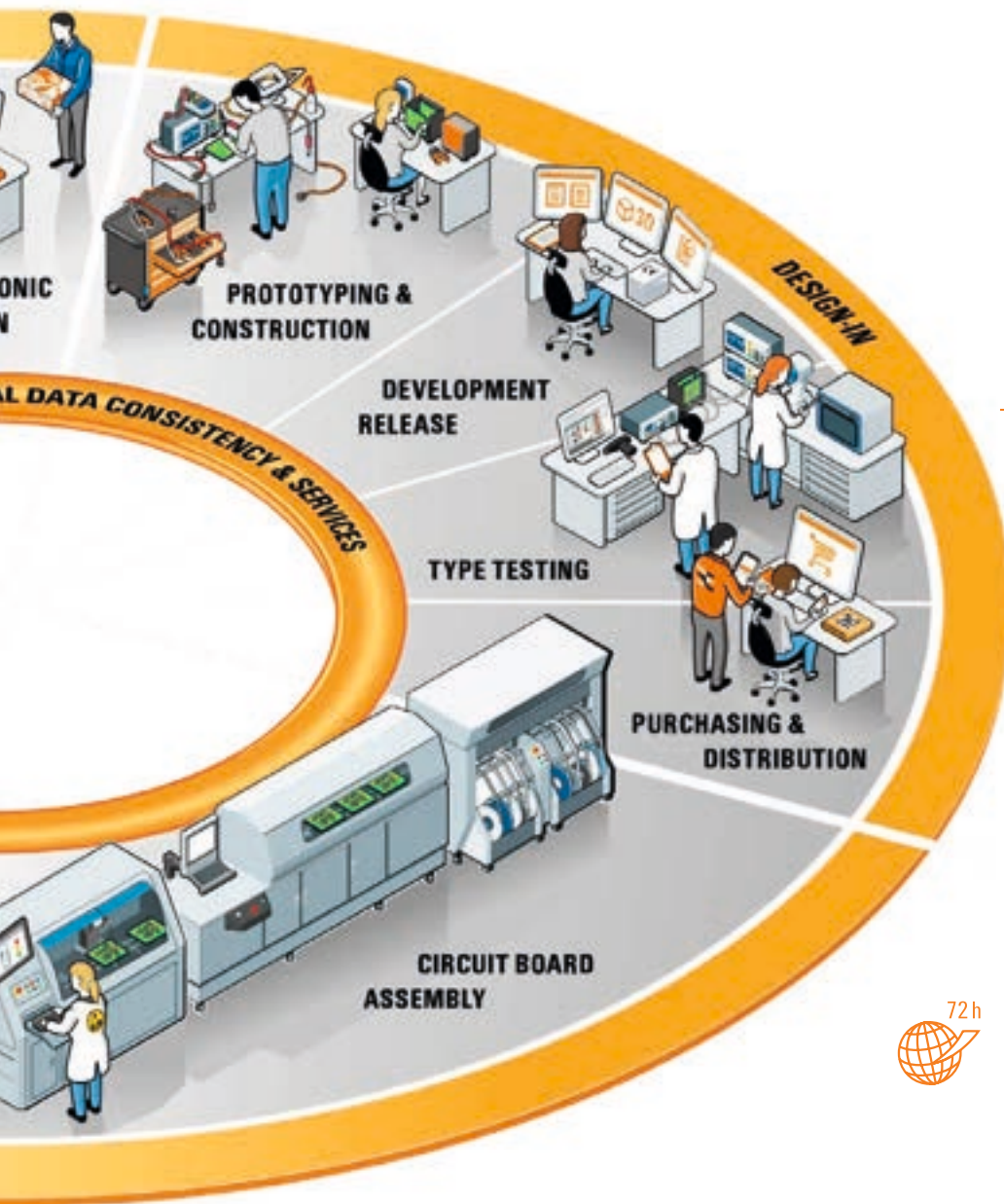

Product selection

Precise product recommendations just one click away: Our AppGuide supports you in a simple and targeted way. Simply select the required device application and the AppGuide recommends to you the suitable connection solutions for the different functions of your device.

Webcode #01170



Design-in support

You can adapt PCB terminals, connectors and electronics housings to your application, as required, using our online configurators. With the sample service, your personal design-in sample is in your hands within just 72 hours. Free of charge and worldwide.

Webcode #01162

Your requirements for individual components

Our product configurators for more design freedom

Product configurator for device connection technology

Whenever you are looking for the right connection technology, the product configurator for device connection technology enables the quick selection and adaptation of terminals and plug connectors according to component specifications and application requirements.



Stored data packages

- Ordering data
- Dimensions and weights
- System specifications
- Material data
- Connection system data
- Rating and nominal data
- Classifications
- Approvals



Customised colours



Process-compatible packaging



Clear labelling



Application-oriented surfacing systems



Optimised pin lengths



Distinctive coding

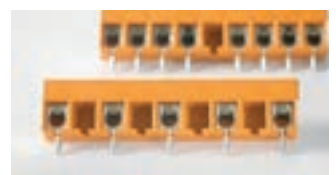

Custom assembly

Product configurator for electronic housings

Weidmüller's innovative CH20M housing system allows us to provide the best platform to fit your custom requirements – for whatever electronics application you are planning. Configure custom-fit housings according to your requirements from our line of connectivity, housing, and accessory components.



Webcode
#11343



Customised colours



Clear labelling



Custom assembly



Dimensions of the circuit board



User-friendly mounting rail connection



Pin lengths optimized for the process



Process-compatible packaging

Many ways lead to the right product

Our online services as process-optimisation tools

There is more than one route to the final layout. Our support concept will assist you in all of your search and selection options.

Weidmüller has fundamentally re-designed the selection and ordering process for device connectivity in a way that better suits your application. In the future, there'll no longer be just the one path to the right product; there'll just be the right path: yours.

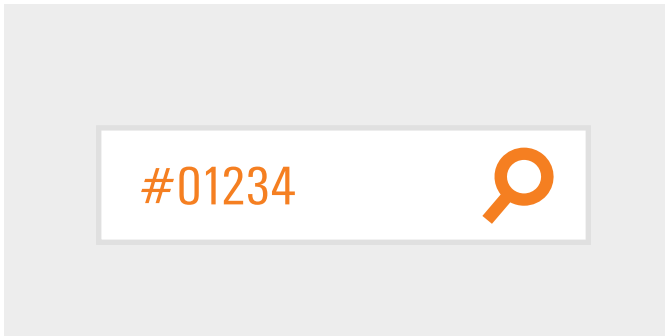

Webcode selection

For an application, you need certain specifications for certain products. Our new webcode allows you to go directly to the relevant products: simply choose the required product from the following pages and enter the hashtag with five-digit code on our website, and you'll be directed to the relevant details.

www.weidmueller.com



The AppGuide

When working with applications, you'll need to find ways of successfully implementing your ideas. Simply select your device application in our AppGuide, and we will recommend a range of products for all the different functions of your device.

Webcode #01171



Specification filters

In our online catalog in the area of device connectivity, you filter the right product in seconds using your product and application requirements.

Webcode #11534

#11530

#01028

#01052

#01072

#01116

#01160

#11581

#01056

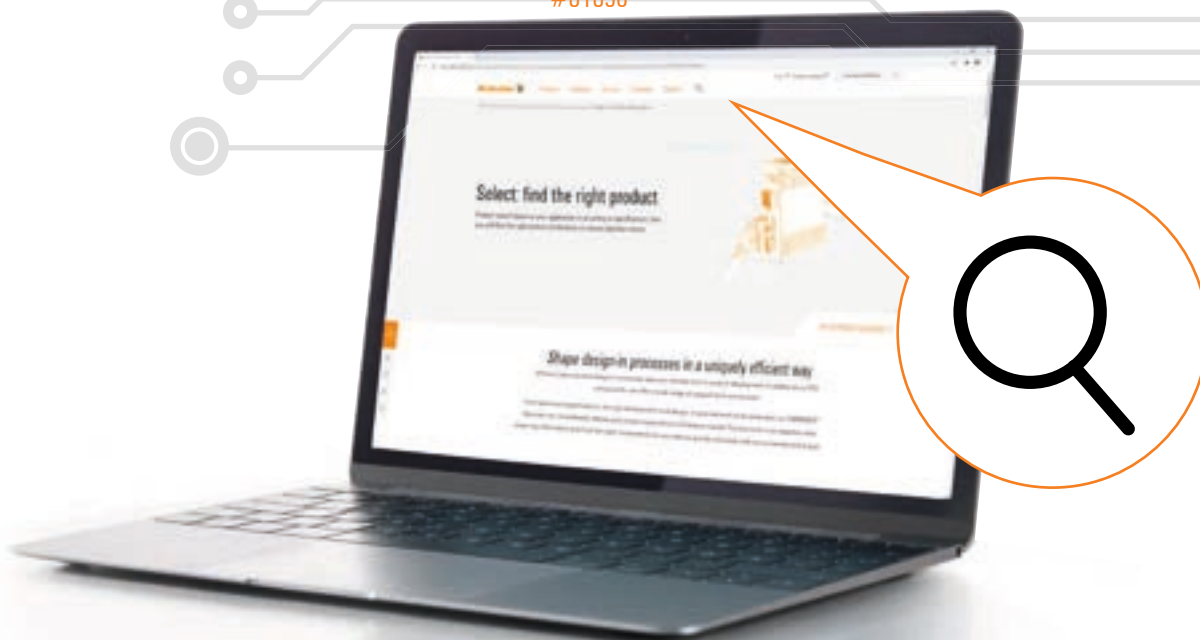

Webcode: the hashtag for easy product searching

A hashtag followed by five digits – that's all you need to find out detailed information about the products in our wide-ranging portfolio. Entering the sequence of characters activates certain product groups or an individual product.

Where can I find the webcode?

Next to the product, either in this brochure or online.

Where do I enter the webcode?

Just enter the code into the search screen on our website. *

Where will I be directed to once I've entered the webcode?

You'll be taken to the product specifications and technical details, as well as additional info and downloads.

* Note: Make sure that the pop-up blocker settings are disabled

A

From concept to prototype in just 72 hours

You prefer to implement your ideas for PCB and device designs directly. We share your passion. Try our unique, on-demand, 72-hour sample service and see how great it is.

When designing PCBs and devices, development engineers eventually reach the point when they have to find the ideal connectivity components for their applications.

With Weidmüller’s sample service, you won’t lose any time; within 72 hours, Weidmüller delivers samples of your device connection components and electronics housing to you, wherever you are located.

The path from our sample stock to your designers workplace is simple and begins with Weidmüller’s online catalogue. Here, searchers will find 2,500 products in the area of device connectivity and can select up to 25 samples.

Just a click of the mouse on the new “Order sample” button initiates the delivery process – from Weidmüller’s warehouse to you, anywhere in the world.

Available for order online
Select your sample directly from the OMNIMATE® online catalogue.
www.sample-service.com



Best-in-class service

Our service team is ready to respond to any enquiry. You benefit from our best-in-class customer service.



This is how to get your design-in sample:

Simply go to the Weidmüller online catalogue or www.sample-service.com. Find the ideal OMNIMATE® component there, enter your contact information and send in your order. Done! We’ll deliver your design-in sample to any location.



Large selection of products

Choose your samples from more than 2,500 items in the OMNIMATE® product portfolio.



At your workplace in 72 hours

You will receive your samples no later than 72 hours after placing the order. Track your samples using your individual tracking number.

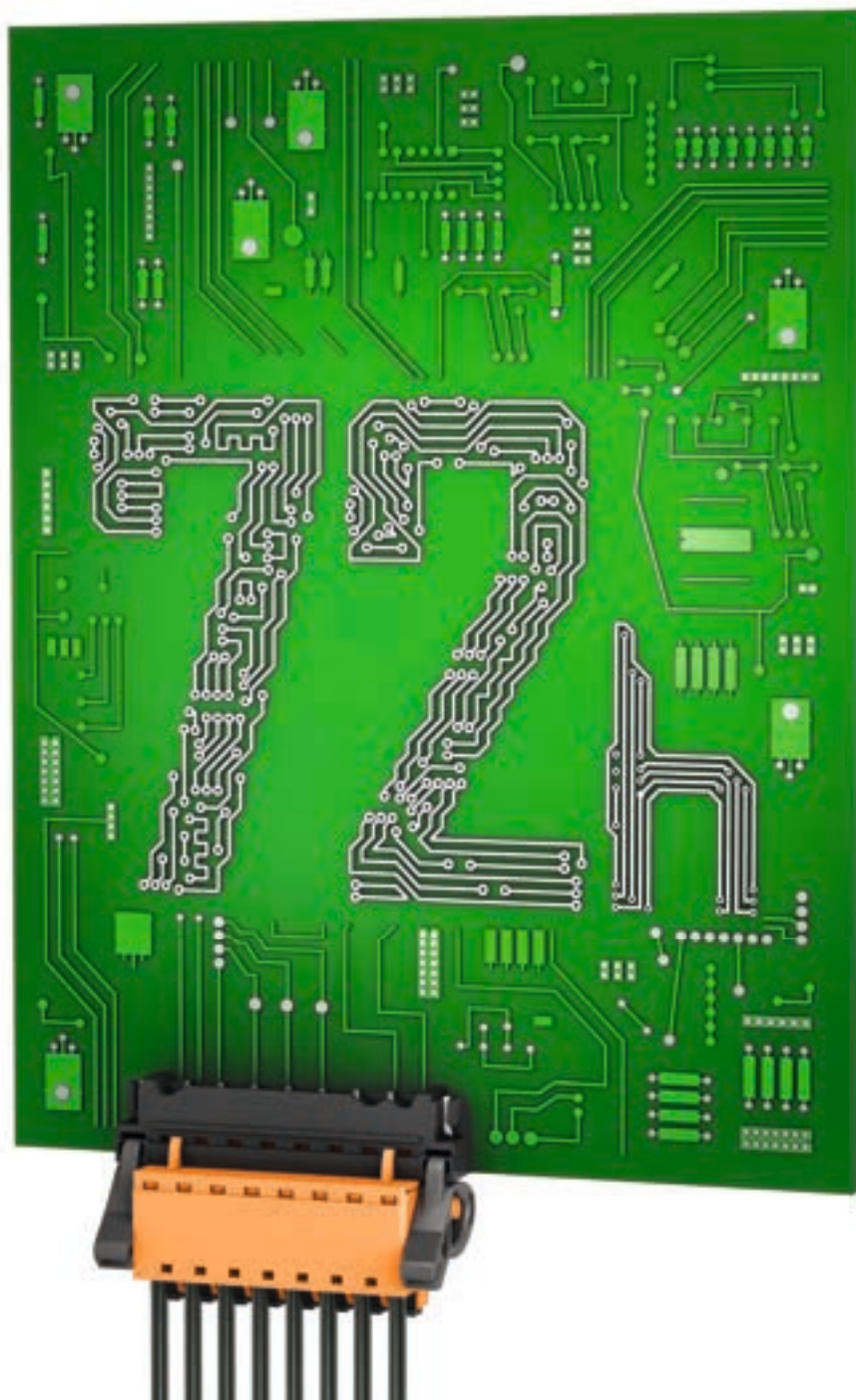

Your device application

Our AppGuide for device developers

A

Based on your application, the AppGuide will show you a representative range of products for the different functions of your device.

The overview will show you the application as you know it. Move the cursor over the markings to find out information on the connection technology for sub-assemblies and components. And it's just a few more clicks from here to your desired product.



AppGuide

Simply select your device application in our AppGuide, and we will recommend a range of products for all the different functions of your device.

www.weidmueller.com/appguide



1. Open the AppGuide

Go to: www.weidmueller.com/appguide or use the **Webcode #01171**

2. Select the application

Hotspots will show you the way to our recommended products

Go directly to your application with the webcode



Industrial controls



Drive controllers and regulators



Devices of machine safety



Analogue signal converter



Photovoltaic inverter



Power supply



Radio base stations



Heating electronics



Building security equipment



LED lighting systems



Elevator electronics devices



Smart Meter



Industrial IoT Network



Charging infrastructure for e-mobility

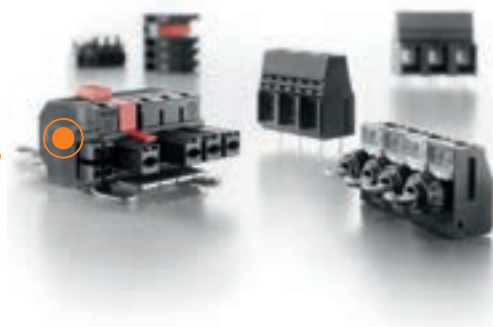

3. Select product group

Use the hotspots to find the perfect products for your applications



4. Receive the product

Configure your selection and use the available functions of our online catalogue

An example of the OMNIMATE® Signal device connection method used in an industrial control application.

A

The trend in industrial automation technology is towards space-saving, cost-effective design. This results in higher density in the controls and individual components. At the same time, cost pressure and the demands of plant safety also increase. Furthermore, standards across all industries have to be complied with and automation know-how must be kept in tip-top shape.

We have been closely monitoring developments in electrical engineering and processing through all their stages and our range of products meets the trends and in many cases anticipates them. One example is our pin headers, which were optimised for the automated assembly and reflow soldering processes in advance. We are specialists in industrial connectivity. With an eye on practical application, we can support you in all your needs for automation and systems technology (measurement, industrial process and control technology), particularly in the areas of sensor actuator interfaces and power supplies.

We think you will be very pleased with our broad spectrum of products, particularly those in the OMNIMATE® family. You have a choice of device connectivity products which you can trust to be perfectly suited to your application needs. Our customer service staff is on hand to advise you in the selection process. In addition, our online configurator, located on our website, can help you put together your own entire product from the comfort of your computer. You can also find a 3D CAD tool for your product development free of charge under our Downloads section online. To round off our service, we offer our unique, on-demand 72-hour sample service, which ensures that you get the sample you request directly on site within three days.



Power supply & peripherals
PCB terminals and connectors, in 5.08 pitch, with PUSH IN or screw wire connections



Input card
PCB BL-I/O plug-in connectors with PUSH IN connections for the most compact solution



Housings

CH20M electronic component housing in module widths of 6 mm to 67.5 mm

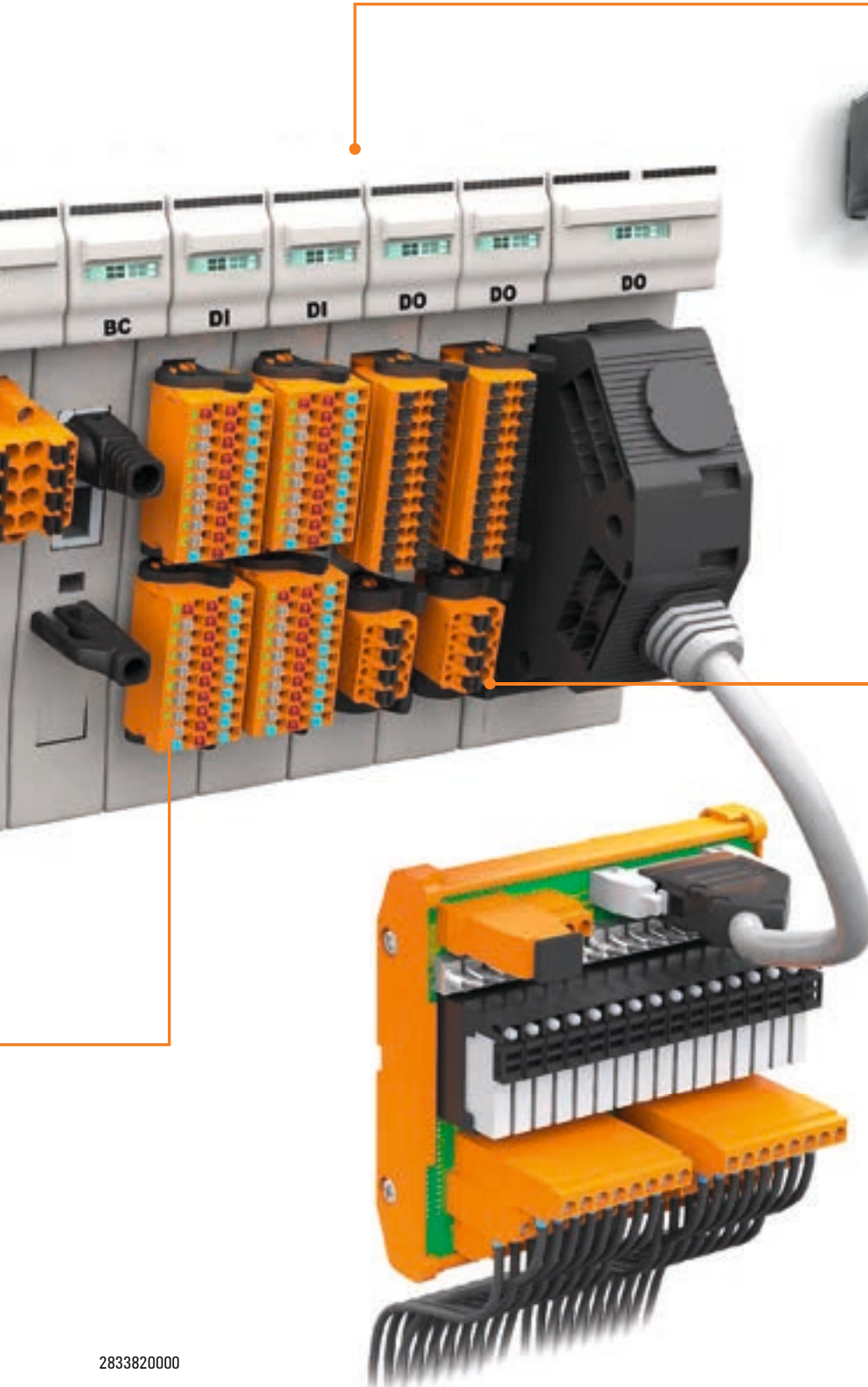

Output card

Compact B2CF 3.5 mm PCB plug-in connectors in two rows of PUSH IN connection



An example of the OMNIMATE® Power device connection method in a frequency converter application.

Semiconductor technology for power electronics has progressed at a steady pace in the last few years enabling more complex drive controllers to be manufactured, e.g. for rotational speed controllers or for precise positioning systems. So it's more important than ever to take advantage of connection technology that you can trust now and in the future.

We specialise in industrial connectivity; our connectivity solutions for the power electronics sector are backed by our comprehensive, real-world expertise. We understand the extremely demanding requirements for the servo-controllers and frequency inverters that are common in this business. Voltages of 400 to 690 V (according to IEC) and 600 V (according to UL), and up to 1,000 V in DC circuits, are not uncommon for such equipment. That is why you require high current-carrying capacity implemented in the most compact space possible. We can provide superior connectivity solutions to meet these challenging requirements.

You will be impressed with the vast range of our OMNIMATE® product line. Our OMNIMATE® Signal, OMNIMATE® Power, OMNIMATE® Housings and FieldPower® series offer you a choice range of products and the ideal connectivity solution for your application. We also support you with free 3D CAD files, which can be downloaded from the Weidmüller Online Configurator. In addition our unique, convenient and quick 72-hour OMNIMATE® sample service guarantees your design project stays on schedule. This service is convenient and quick to use – you receive the requested samples within 72 hours.

Network connection

Industry compliant plugs and sockets with the innovative Single Pair Ethernet technology.



Motor connection compact

Modular and hybrid system for the construction of connectors for data, signals and power. Fast, secure and tool-free wiring thanks to the unique SNAP IN connection.



Safety circuit / External I/Os

PCB terminals and connectors with PUSH IN or screw connection



Intermediate circuits (DC-Link)

Device feedthrough terminals for direct connections, PCB terminals, connectors carrying high voltages safely



Power supply

High-performance connectors and terminals for circuit boards; terminals for feeding through housing walls



Motor connections

Convenient and standardised motor connections: hybrid motor plugs, soldered feedthrough terminals and PCB terminals blocks



Industrial IoT network as a reference for OMNIMATE® Data device connection technology

Ethernet devices such as switches, safety routers or IoT gateways are perfect communication components within an industrial network. For simple to complex real-time networks in plant and machine construction, different categories of devices are used. They form a perfect platform in the industrial environment and its connection to superordinate office networks and cloud services. In order for the communication between Ethernet-capable devices to function smoothly, high-performance connectors are required that can withstand the high requirements in terms of EMC and temperature resistance.

Service Interface

Standardized connectors such as the USB or D-SUB (RS-232) for serial interfaces.



Ethernet-Ports

High-performance connectors for data transmission including a wide range of Single Pair Ethernet products for miniaturization and future security.



Input and output signals

PCB terminal blocks and connectors with a pitch of 3.50 to 5.08 mm with PUSH IN connection and high packing density



Power Supply

Intuitive connectors with visual connection indicators or supply of neighbouring components by means of cross-connections.



Internal board connection

Industry-compatible board-to-board connectors, which are specially designed for the fully automatic assembly process, ensure flexible and at the same time stable connections between circuit boards in the device.



OMNIMATE® 4.0

OMNIMATE® 4.0	Explanation	B.2
	Quick selection	B.8
	Connectors in 5.00 mm pitch Series MHS / MPS 5.00 - Connection up to 2.50 mm ²	B.10
	Connectors in 7.50 mm pitch Series MHS / MPS 7S - Connection up to 4 mm ²	B.15
	Hybrid connectors with 7.50 mm and 5.00 mm pitch Series MHS / MPS 7S/..5/.. - Connection up to 4 mm ²	B.20
	Hybrid connector with 5.00 mm pitch incl. Single Pair Ethernet Series MHS / MPS 5/.. D11 - Connection up to 2.50 mm ²	B.22
	Hybrid connectors with 7.50 mm and 5.00 mm pitch incl. Single Pair Ethernet Series MHS/MPS 7S/..5/..D11 - connection up to 4 mm ²	B.25

The business booster for next generation devices

OMNIMATE® 4.0 – Fast. Flexible. Digital.

B

The demands on the development of electrical devices are constantly increasing. This leads to higher complexity and challenges device developers. OMNIMATE® 4.0 is the efficient solution for a continuous, digitalised device development process for the connected world of tomorrow.

The modular product concept of OMNIMATE® 4.0 enables flexible configuration and ordering via the Weidmüller Configurator (WMC). This enables even highly individual products to be shipped within 3 days – from samples to product series. The innovative SNAP IN connection technology allows even flexible conductors without ferrules to be connected easily without tools. An indicator signals the secure connection both acoustically and visually.

3 Days Availability

All products are ready for dispatch within 3 days – even individually configured products



Maximum wiring speed

Unique SNAP IN connection for particularly fast, safe and tool-free wiring



Highest flexibility for your application

The Weidmüller Configurator (WMC) enables unlimited combination possibilities of the modular connector for power, signal and data transmission

**Future-proof**

Platform-Connector with integrated functions like Single-Pair Ethernet or smart connectors with related digital twin



SNAP IN connection solution for the next generation devices

OMNIMATE® 4.0 – Fast. Flexible. Digital.

B

OMNIMATE® 4.0 provides a flexible, future-proof product portfolio with unlimited variations. The modular design allows fast configuration of interfaces for transmitting data, signals and power, even in a single hybrid connector. For the first time, the innovative SNAP IN connection technology is used in device connectors, revolutionizing the wiring of devices. Even flexible conductors without ferrules can be connected intuitively and without tools - even in fully automated wiring processes.

Hearable and visible feedback

The visual safety indicator increase the security of the proper wiring by a hearable „click“ and visible green indication



Wire-ready & Ready-to-Robot

Thanks to the innovative SNAP IN connection technology flexible conductors can be connected directly & tool-free in record time – even in fully automated wiring processes



Easy and intuitive handling

Complete tool-less handling thanks to the lever for re-wiring and the one-hand usable top-fixation for preventing undesired disconnection



Process- & Automation-Ready

High performance material for different soldering methods like THT or THR with precise pin tolerances and automation-ready packaging

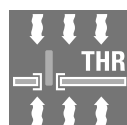
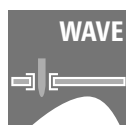
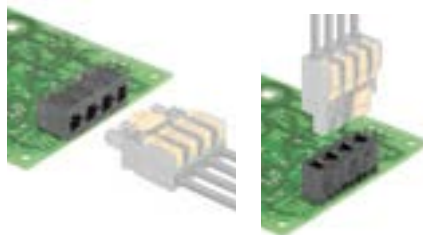

The efficient solution for a digitalised device development process

OMNIMATE® 4.0 – Fast. Flexible. Digital.

B

You are looking for a specific solution perfectly fitting to your individual devices and their requirements.

The modular product concept of OMNIMATE® 4.0 enables flexible configuration and request via the Weidmüller Configurator (WMC). The software tool significantly reduces your efforts and speeds up your engineering processes from product specification to the individual offer within minutes. Digital engineering can be as simple as that.



Full design-in support

From product recommendations in the AppGuide to fast available samples within 3 days to the support of installation with handlings videos – our OMNIMATE® services reduce your Design-In efforts

Fastest availability

Don't lose your time: Your individual offer for a configuration is ready within minutes and all products are ready to dispatch within 3 days



Create your own configuration

The Weidmüller Configurator (WMC) reduce your engineering efforts: Combine power, signal and data modules to your individual product and design the marking with a few clicks

**Time-saving engineering data**

Comprehensive data sheets, individual drawings and 3D models plus prepared EDA data for PCB layout - OMNIMATE® 4.0 brings the full design-in support for mechanical and electrical engineering



<http://www.OMNIMATE.net>

- = Wire-to-Board
- = Board-to-Board
- = Wire-to-Wire
- = Board-to-Wire

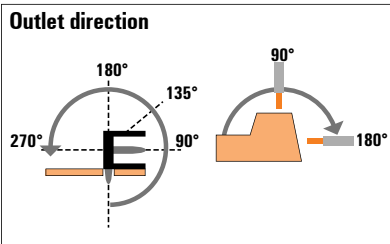
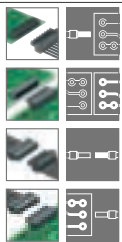

MPS/MHS series



Type	Pitch	Outlet direction	
		Fixation options	
			IEC / UL

Female plug	Spring SNAP IN		MPS 5/.. S..	5.00 mm	180°	Optional top fixation (F)	IEC: 400 V / 26.8 A / 0.5 - 4 mm ² UL: 300 V / 18.5 A / AWG 20 - AWG 12	
			MPS 7S - S	7.50 mm	180°	Optional top fixation (F)	IEC: 1000 V / 26.8 A / 0.5 - 4 mm ² UL: 600 V / 18.5 A / AWG 20 - AWG 12	
			MPS 7S/.. -5/.. S	Hybrid 7.50 mm + 5.00 mm	180°	Optional top fixation (F)	IEC: 1000 V / 26.8 A / 0.5 - 4 mm ² UL: 600 V / 18.5 A / AWG 20 - AWG 12	
			MPS 5/.. D11 S	Hybrid 5.00 mm + SPE	180°	Optional top fixation (F)	IEC: 400 V / 26.8 A / 0.5 - 4 mm ² UL: 300 V / 18.5 A / AWG 20 - AWG 12	
			MPS 7S/.. -5/.. D11 S	Hybrid 7.50 mm + 5.00 mm + SPE	180°	Optional top fixation (F)	IEC: 1000 V / 26.8 A / 0.5 - 4 mm ² UL: 600 V / 18.5 A / AWG 20 - AWG 12	

Plug



Reflow solder connection



OMNIMATE® 4.0

B

	MHS 5/.. H	MHS 5/.. V	MHS 5/.. W	MHS 7S/.. H	MHS 7S/.. V	MHS 7S/.. W	MHS 7S/..-5/.. H	MHS 5/.. D11 H	MHS 7S/..-5/.. D11 H
	5.00 mm	5.00 mm	5.00 mm	7.50 mm	7.50 mm	7.50 mm	Hybrid 7.50 mm + 5.00 mm	Hybrid 5.00 mm + SPE	Hybrid 7.50 mm + 5.00 mm + SPE
	90°	180°	270°	90°	180°	270°	90°	90°	90°
	Compatible with top fixation	Compatible with top fixation	Compatible with top fixation	Compatible with top fixation	Compatible with top fixation	Compatible with top fixation	Compatible with top fixation	Compatible with top fixation	Compatible with top fixation
	IEC: 400 V / 26.8 A UL: 300 V / 18.5 A	IEC: 400 V / 25.3 A UL: 300 V / 18.5 A	IEC: 400 V / 26.8 A UL: 300 V / 18.5 A	IEC: 630 V / 26.8 A UL: 300 V / 18.5 A	IEC: 630 V / 25.3 A UL: 300 V / 18.5 A	IEC: 630 V / 26.8 A UL: 300 V / 18.5 A	IEC: 630 V / 26.8 A UL: 300 V / 18.5 A	IEC: 400 V / 26.8 A UL: 300 V / 18.5 A	IEC: 630 V / 26.8 A UL: 300 V / 18.5 A
	○	○	○						
				○	○	○			
							○		
								○	
									○

Connectors in 5.00 mm pitch
Series MHS / MPS 5.00 - Connection up to 2.50 mm²

OMNIMATE® 4.0

B

MHS 5 - horizontal

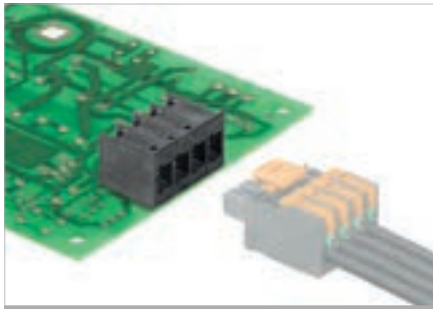

Modular male headers in 5.00 mm pitch with 90° outgoing elbow made of high performance material PA9T, which can be used for both reflow and wave soldering process.

- 90° outgoing elbow for horizontal PCB connection
- Suitable for reflow and wave soldering processes
- Compliance with Moisture Level 1
- Available prepared engineering data (EDA)

Technical data

In compliance with IEC 60664-1 / IEC 61984

Clamping range, max.			
Solid core H05(07) V-U			
Stranded H07 V-R			
Flexible H05(07) V-K			
Flexible with ferrule			
Ferrule with ferrule collar			
Stripping length			
Screwdriver blade	mm		
According to norm			
Tightening torque range			
Rated current, max.	A	26.8	23.1
At ambient temperature		20°C	40°C
For conductor cross-section			
Overvoltage category		III	III II
Pollution severity		3	2 2
Rated voltage	V	250	320 400
Rated impulse voltage	kV	4	4 4
UL / CUL (Use Group)		B	C D
Rated voltage	V	300	300
Rated current	A	14	10
AWG conductor	AWG		-
CSA (Use Group)		B	C D
Rated voltage	V		
Rated current	A		
AWG conductor	AWG		-
General data			
Type of insulation material		PA 9T	
UL 94 flammability rating		V-0	
Contact base material		CuMg	
Material of contact surface		tinned	
Pin dimensions = d	mm	1.0 x 1.0	
Solder eyelet Ø = D	mm	1.4	
Solder eyelet Ø tolerance	mm	+ 0,1	

Product data

IEC: 400 V / 26.8 A
 UL: 300 V / 14 A



For additional articles and information, refer to catalog.weidmueller.com

Note:

- Rated current related to rated cross-section & min. No. of poles.
- P on drawing = pitch
- Rated data refer only to the component itself. Clearance and creepage distances to other components are to be designed in accordance with the relevant application standards.
- Diameter of solder eyelet D = 1.4+0.1mm
- Long term storage of the product with average temperature of 50 °C and average humidity 70%, 36 months

MHS 5/.. H T3 B T

Tube packaging



Dimensioned drawing

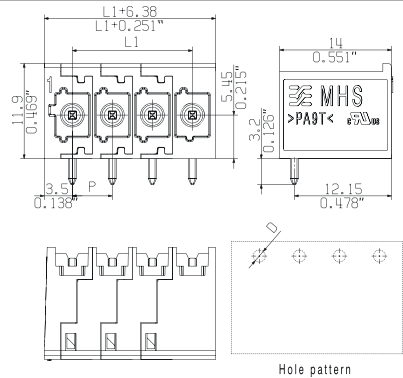

Ordering data

Solder pin length		3.2 mm		
Colour		black		
Pitch		5.00 mm		
Pol.	L1	(inch)	Qty.	Order No.
2	5.00	0.197	48	2741400000
3	10.00	0.394	33	2741420000
4	15.00	0.591	25	2741430000
5	20.00	0.787	20	2741440000
6	25.00	0.984	17	2741450000
7	30.00	1.181	15	2741460000
8	35.00	1.378	13	2741470000
9	40.00	1.575	11	2741480000
10	45.00	1.772	10	2741490000
11	50.00	1.969	9	2741500000
12	55.00	2.165	8	2741510000

5.00

90°

MHS 5 - vertical

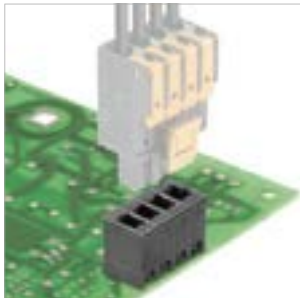

Modular male headers in 5.00 mm pitch with 180° outgoing elbow made of high performance material PA9T, which can be used for both reflow and wave soldering process.

- 180° outgoing elbow for vertical PCB connection
- Suitable for reflow and wave soldering processes
- Compliance with Moisture Level 1
- Available prepared engineering data (EDA)

Product data

IEC: 400 V / 25.3 A
UL: 300 V / 14 A



For additional articles and information, refer to catalog.weidmuller.com

Note:

- Rated current related to rated cross-section & min. No. of poles.
- P on drawing = pitch
- Rated data refer only to the component itself. Clearance and creepage distances to other components are to be designed in accordance with the relevant application standards.
- Diameter of solder eyelet D = 1.4±0.1mm
- Long term storage of the product with average temperature of 50 °C and average humidity 70%, 36 months

MHS 5/.. V T3 B T

Tube packaging



Dimensioned drawing

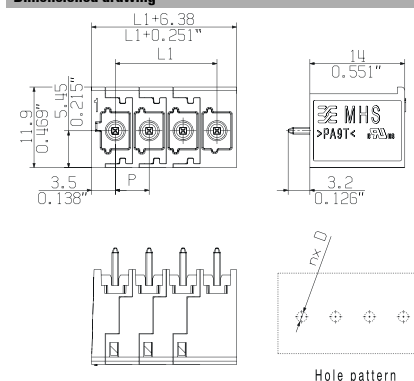

Technical data

In compliance with IEC 60664-1 / IEC 61984

Clamping range, max.			
Solid core H05(07) V-U			
Stranded H07 V-R			
Flexible H05(07) V-K			
Flexible with ferrule			
Ferrule with ferrule collar			
Stripping length			
Screwdriver blade	mm		
According to norm			
Tightening torque range			
Rated current, max.	A	25.3	21.8
At ambient temperature		20°C	40°C
For conductor cross-section			
Overvoltage category		III	III II
Pollution severity		3	2 2
Rated voltage	V	250	320 400
Rated impulse voltage	kV	4	4 4
UL / CUL (Use Group)		B	C D
Rated voltage	V	300	300
Rated current	A	14	10
AWG conductor	AWG		-
CSA (Use Group)		B	C D
Rated voltage	V		
Rated current	A		
AWG conductor	AWG		-
General data			
Type of insulation material		PA 9T	
UL 94 flammability rating		V-0	
Contact base material		CuMg	
Material of contact surface		tinned	
Pin dimensions = d	mm	1.0 x 1.0	
Solder eyelet Ø = D	mm	1.4	
Solder eyelet Ø tolerance	mm	+ 0,1	

Ordering data

Solder pin length		3.2 mm		
Colour		black		
Pitch		5.00 mm		
Pol.	L1	(inch)	Qty.	Order No.
2	5.00	0.197	48	8000072425
3	10.00	0.394	33	8000072430
4	15.00	0.591	25	8000072431
5	20.00	0.787	20	8000072435
6	25.00	0.984	17	8000072438
7	30.00	1.181	15	8000072450
8	35.00	1.378	13	8000072453
9	40.00	1.575	11	8000072454
10	45.00	1.772	10	8000072456
11	50.00	1.969	9	8000072461
12	55.00	2.165	8	8000072470

Connectors in 5.00 mm pitch
Series MHS / MPS 5.00 - Connection up to 2.50 mm²

OMNIMATE® 4.0

B

MHS 5 - horizontal inverted



Modular male headers in 5.00 mm pitch with 270° outgoing elbow made of high performance material PA9T, which can be used for both reflow and wave soldering process.

- 270° outgoing elbow for horizontal inverted PCB connection
- Suitable for reflow and wave soldering processes
- Compliance with Moisture Level 1
- Available prepared engineering data (EDA)

Technical data

In compliance with IEC 60664-1 / IEC 61984

Clamping range, max.			
Solid core H05(07) V-U			
Stranded H07 V-R			
Flexible H05(07) V-K			
Flexible with ferrule			
Ferrule with plastic collar			
Stripping length			
Screwdriver blade	mm		
According to norm			
Tightening torque range			
Rated current, max.	A	26.8	23.1
At ambient temperature		20°C	40°C
For conductor cross-section			
Overvoltage category		III	III II
Pollution severity		3	2 2
Rated voltage	V	250	320 400
Rated impulse voltage	kV	4	4 4
UL / CUL (Use Group)		B	C D
Rated voltage	V	300	300
Rated current	A	14	10
AWG conductor	AWG		-
CSA (Use Group)		B	C D
Rated voltage	V		
Rated current	A		
AWG conductor	AWG		-
General data			
Type of insulation material		PA 9T	
UL 94 flammability rating		V-0	
Contact base material		CuMg	
Material of contact surface		tinned	
Pin dimensions = d	mm	1.0 x 1.0	
Solder eyelet Ø = D	mm	1.4	
Solder eyelet Ø tolerance	mm	+ 0,1	

Product data

IEC: 400 V / 26.8 A
 UL: 300 V / 14 A



For additional articles and information, refer to catalog.weidmueller.com

Note:

- Rated current related to rated cross-section & min. No. of poles.
- P on drawing = pitch
- Rated data refer only to the component itself. Clearance and creepage distances to other components are to be designed in accordance with the relevant application standards.
- Diameter of solder eyelet D = 1.4+0.1mm
- Long term storage of the product with average temperature of 50 °C and average humidity 70%, 36 months

MHS 5/.. W T3 B T

Tube packaging



Dimensioned drawing

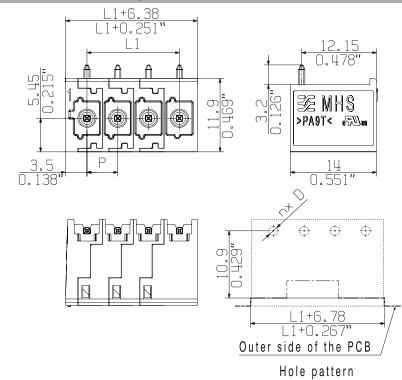

Ordering data

Solder pin length		3.2 mm		
Colour		black		
Pitch		5.00 mm		
Pol.	L1	(inch)	Qty.	Order No.
2	5.00	0.197	48	8000072497
3	10.00	0.394	33	8000072503
4	15.00	0.591	25	8000072506
5	20.00	0.787	20	8000072508
6	25.00	0.984	17	8000072509
7	30.00	1.181	15	8000072510
8	35.00	1.378	13	8000072511
9	40.00	1.575	11	8000072512
10	45.00	1.772	10	8000072513
11	50.00	1.969	9	8000072514
12	55.00	2.165	8	8000072515

5.00

270°

MPS 5 - straight

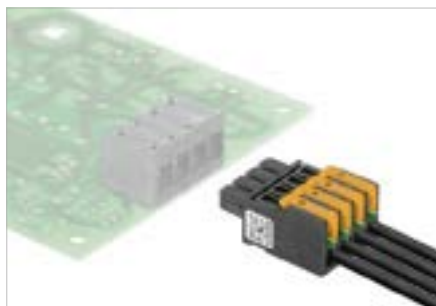

OMNIMATE® 4.0 signal connectors combine three innovations in one product: the fastest connection technology SNAP IN, a modular product design with flexible configuration options, and the fastest possible delivery.

- Particularly fast, safe and tool-free wiring thanks to SNAP IN connection
- Optical and acoustic feedback indicates proper wiring
- Tool-free rewiring via lever operation
- Individual color and font marking in the configurator

Product data

IEC: 400 V / 26.8 A / 0.5 - 4 mm²
UL: 300 V / 14 A / AWG 18 - 14



For additional articles and information, refer to catalog.weidmueller.com

Note:

- Rated current related to rated cross-section & min. No. of poles.
- P on drawing = pitch
- Rated data refer only to the component itself. Clearance and creepage distances to other components are to be designed in accordance with the relevant application standards.
- Wire end ferrule without plastic collar to DIN 46228/1
- Long term storage of the product with average temperature of 50 °C and average humidity 70%, 36 months

MPS 5/.. S TN B

Box packaging



Dimensioned drawing

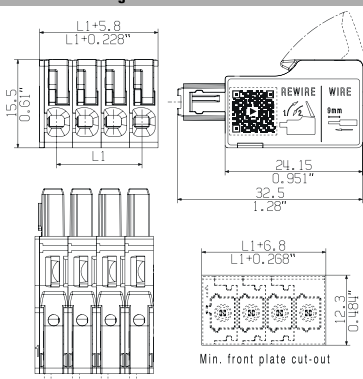

Ordering data

Solder pin length				
Colour				black
Pitch 5.00 mm				
Pol.	L1	(inch)	Qty.	Order No.
2	5.00	0.197	168	2741560000
3	10.00	0.394	114	2741570000
4	15.00	0.591	84	2741580000
5	20.00	0.787	72	2741590000
6	25.00	0.984	60	2741600000
7	30.00	1.181	48	2741610000
8	35.00	1.378	42	2741620000
9	40.00	1.575	36	2741630000
10	45.00	1.772	36	2741640000
11	50.00	1.969	30	2741650000
12	55.00	2.165	30	2741660000

Technical data

In compliance with IEC 60664-1 / IEC 61984			
Clamping range, max.	mm ²	0.5...2.5	
Solid core H05(07) V-U	mm ²	0.5...2.5	
Stranded H07 V-R			
Flexible H05(07) V-K	mm ²	0.5...4	
Flexible with ferrule	mm ²	0.5...2.5	
Ferrule with plastic collar	mm ²	0.5...2.5	
Stripping length	mm	9	
Screwdriver blade	mm		
According to norm			
Tightening torque range			
Rated current, max.	A	26.8	23.1
At ambient temperature		20°C	40°C
For conductor cross-section			
Overtoltage category		III	III II
Pollution severity		3	2 2
Rated voltage	V	250	320 400
Rated impulse voltage	kV	4	4 4
UL / CUL (Use Group)		B	C D
Rated voltage	V	300	300
Rated current	A	14	10
AWG conductor	AWG	18-14	
CSA (Use Group)		B	C D
Rated voltage	V		
Rated current	A		
AWG conductor	AWG	-	
General data			
Type of insulation material		PBT GF	
UL 94 flammability rating		V-0	
Contact base material		CuSn	
Material of contact surface		tinned	
Pin dimensions = d	mm		
Solder eyelet Ø = D	mm		
Solder eyelet Ø tolerance	mm		

Representative deratings curve

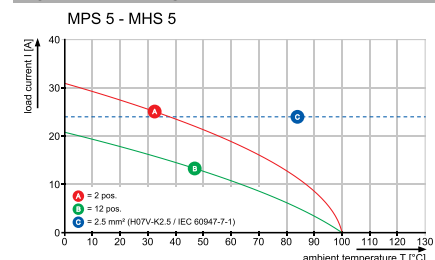

Connectors in 5.00 mm pitch
Series MHS / MPS 5.00 - Connection up to 2.50 mm²

OMNIMATE® 4.0

B

MPS 5 - straight, top flange

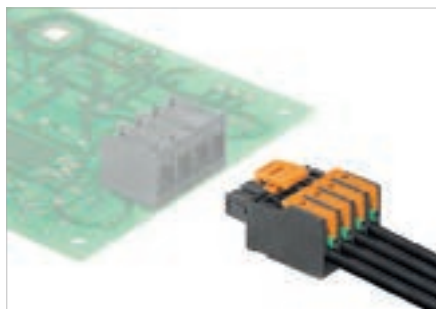

OMNIMATE® 4.0 signal connectors combine three innovations in one product: the fastest connection technology SNAP IN, a modular product design with flexible configuration options, and the fastest possible delivery.

- Particularly fast, safe and tool-free wiring thanks to SNAP IN connection
- Optical and acoustic feedback indicates proper wiring
- Tool-free operation thanks to lever and top fixation
- Individual color and font marking in the configurator

Technical data

In compliance with IEC 60664-1 / IEC 61984			
Clamping range, max.	mm ²	0.5...2.5	
Solid core H05(07) V-U	mm²	0.5...2.5	
Stranded H07 V-R			
Flexible H05(07) V-K	mm ²	0.5...4	
Flexible with ferrule	mm ²	0.5...2.5	
Ferrule with plastic collar	mm ²	0.5...2.5	
Stripping length	mm	9	
Screwdriver blade	mm		
According to norm			
Tightening torque range			
Rated current, max.	A	26.8	23.1
At ambient temperature		20°C	40°C
For conductor cross-section			
Overtoltage category		III	III II
Pollution severity		3	2 2
Rated voltage	V	250	320 400
Rated impulse voltage	kV	4	4 4
UL / CUL (Use Group)		B	C D
Rated voltage	V	300	300
Rated current	A	14	10
AWG conductor	AWG	18-14	
CSA (Use Group)		B	C D
Rated voltage	V		
Rated current	A		
AWG conductor	AWG	-	
General data			
Type of insulation material		PBT GF	
UL 94 flammability rating		V-0	
Contact base material		CuSn	
Material of contact surface		tinned	
Pin dimensions = d	mm		
Solder eyelet Ø = D	mm		
Solder eyelet Ø tolerance	mm		

5.00

180°

2.5 mm²

Product data

IEC: 400 V / 26.8 A / 0.5 - 4 mm²
 UL: 300 V / 14 A / AWG 18 - 14



For additional articles and information, refer to catalog.weidmuller.com

Note:

- Rated current related to rated cross-section & min. No. of poles.
- P on drawing = pitch
- Rated data refer only to the component itself. Clearance and creepage distances to other components are to be designed in accordance with the relevant application standards.
- Wire end ferrule without plastic collar to DIN 46228/1
- Long term storage of the product with average temperature of 50 °C and average humidity 70%, 36 months

MPS 5/.. S F.. TN B

Box packaging



Dimensioned drawing

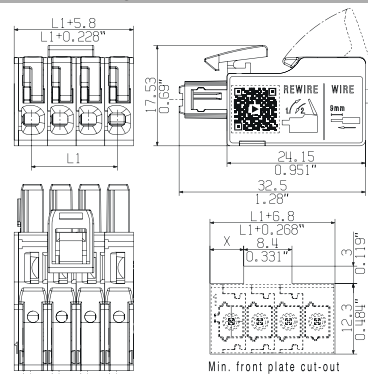

Ordering data

Solder pin length				
Colour				black
Pitch		5.00 mm		
Pol.	L1	(inch)	Qty.	Order No.
2	5.00	0.197	168	2741670000
3	10.00	0.394	114	2741680000
4	15.00	0.591	84	2741690000
5	20.00	0.787	72	2741700000
6	25.00	0.984	60	2741710000
7	30.00	1.181	48	2741720000
8	35.00	1.378	42	2741730000
9	40.00	1.575	36	2741740000
10	45.00	1.772	36	2741750000
11	50.00	1.969	30	2741760000
12	55.00	2.165	30	2741770000

Representative deratings curve

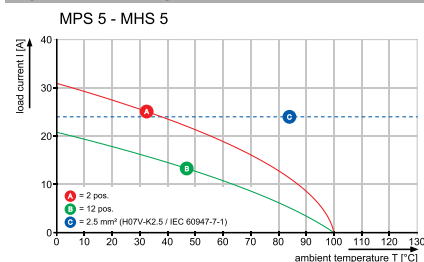

MHS 7S - horizontal

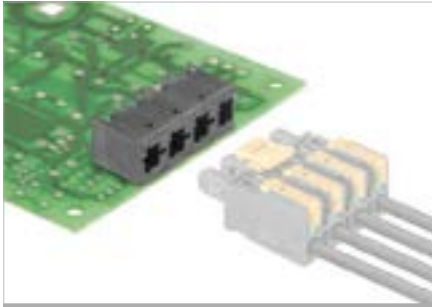

Modular male headers in 7.50 mm pitch with 90° outgoing elbow made of high performance material PA9T, which can be used for both reflow and wave soldering process.

- 90° outgoing elbow for horizontal PCB connection
- Suitable for reflow and wave soldering processes
- Compliance with Moisture Level 1
- Available prepared engineering data (EDA)

Product data

IEC: 630 V / 26.8 A
UL: 300 V / 18.5 A



For additional articles and information, refer to catalog.weidmueller.com

Note:

- Rated current related to rated cross-section & min. No. of poles.
- P on drawing = pitch
- Rated data refer only to the component itself. Clearance and creepage distances to other components are to be designed in accordance with the relevant application standards.
- Diameter of solder eyelet D = 1.4±0.1mm
- Long term storage of the product with average temperature of 50 °C and average humidity 70%, 36 months

MHS 7S/.. H T3 B T

Tube packaging



Dimensioned drawing

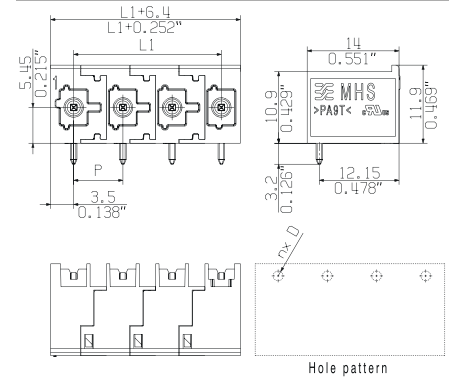

Technical data

In compliance with IEC 60664-1 / IEC 61984

Clamping range, max.			
Solid core H05(07) V-U			
Stranded H07 V-R			
Flexible H05(07) V-K			
Flexible with ferrule			
Ferrule with plastic collar			
Stripping length			
Screwdriver blade	mm		
According to norm			
Tightening torque range			
Rated current, max.	A	26.8	23.1
At ambient temperature		20°C	40°C
For conductor cross-section			
Overvoltage category		III	III II
Pollution severity		3	2 2
Rated voltage	V	400	500 630
Rated impulse voltage	kV	4	4 4
UL / CUL (Use Group)		B	C D
Rated voltage	V	300	300 300
Rated current	A	18.5	18.5 10
AWG conductor	AWG		-
CSA (Use Group)		B	C D
Rated voltage	V		
Rated current	A		
AWG conductor	AWG		-
General data			
Type of insulation material		PA 9T	
UL 94 flammability rating		V-0	
Contact base material		CuMg	
Material of contact surface		tinned	
Pin dimensions = d	mm	1.0 x 1.0	
Solder eyelet Ø = D	mm	1.4	
Solder eyelet Ø tolerance	mm	+ 0,1	

Ordering data

Solder pin length		3.2 mm		
Colour		black		
Pitch		7.50 mm		
Pol.	L1	(inch)	Qty.	Order No.
2	7.50	0.295	39	8000078306
3	15.00	0.591	25	8000078308
4	22.50	0.886	19	8000078309
5	30.00	1.181	15	8000078310
6	37.50	1.476	12	8000078311
7	45.00	1.772	10	8000078312
8	52.50	2.067	9	8000078313

Connectors in 7.50 mm pitch
Series MHS / MPS 7S - Connection up to 4 mm²

MHS 7S - vertical

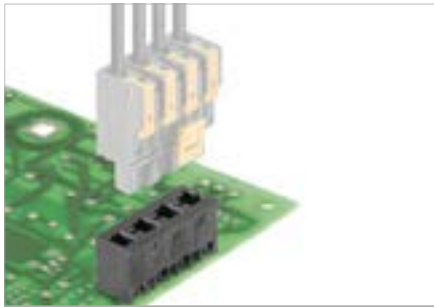

Modular male headers in 7.50 mm pitch with 180° outgoing elbow made of high performance material PA9T, which can be used for both reflow and wave soldering process.

- 180° outgoing elbow for vertical PCB connection
- Suitable for reflow and wave soldering processes
- Compliance with Moisture Level 1
- Available prepared engineering data (EDA)

Product data

IEC: 630 V / 26.8 A
 UL: 300 V / 18.5 A



For additional articles and information, refer to catalog.weidmueller.com

Note:

- Rated current related to rated cross-section & min. No. of poles.
- P on drawing = pitch
- Rated data refer only to the component itself. Clearance and creepage distances to other components are to be designed in accordance with the relevant application standards.
- Diameter of solder eyelet D = 1.4+0.1mm
- Long term storage of the product with average temperature of 50 °C and average humidity 70%, 36 months

MHS 7S/.. V T3 B T

Tube packaging



Dimensioned drawing

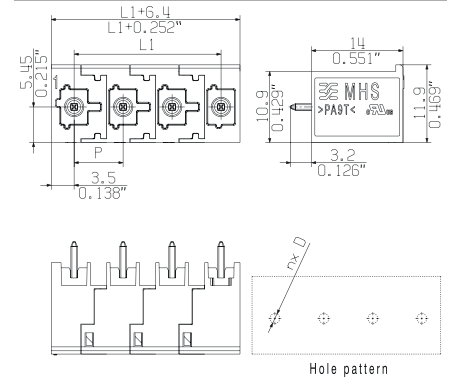

Technical data

In compliance with IEC 60664-1 / IEC 61984			
Clamping range, max.			
Solid core H05(07) V-U			
Stranded H07 V-R			
Flexible H05(07) V-K			
Flexible with ferrule			
Ferrule with plastic collar			
Stripping length			
Screwdriver blade	mm		
According to norm			
Tightening torque range			
Rated current, max.	A	26.8	21.8
At ambient temperature		20°C	40°C
For conductor cross-section			
Overvoltage category		III	III II
Pollution severity		3	2 2
Rated voltage	V	400	500 630
Rated impulse voltage	kV	4	4 4
UL / CUL (Use Group)		B	C D
Rated voltage	V	300	300 300
Rated current	A	18.5	18.5 10
AWG conductor	AWG		-
CSA (Use Group)		B	C D
Rated voltage	V		
Rated current	A		
AWG conductor	AWG		-
General data			
Type of insulation material		PA 9T	
UL 94 flammability rating		V-0	
Contact base material		CuMg	
Material of contact surface		tinned	
Pin dimensions = d	mm	1.0 x 1.0	
Solder eyelet Ø = D	mm	1.4	
Solder eyelet Ø tolerance	mm	+ 0,1	

Ordering data

Solder pin length			3.2 mm	
Colour			black	
Pitch			7.50 mm	
Pol.	L1	(inch)	Qty.	Order No.
2	7.50	0.295	39	8000078314
3	15.00	0.591	25	8000078315
4	22.50	0.886	19	8000078316
5	30.00	1.181	15	8000078317
6	37.50	1.476	12	8000078318
7	45.00	1.772	10	8000078319
8	52.50	2.067	9	8000078320

MHS 7S - horizontal inverted

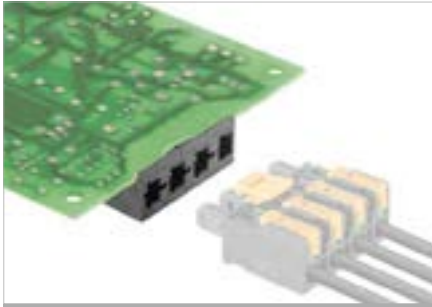

Modular male headers in 7.50 mm pitch with 270° outgoing elbow made of high performance material PA9T, which can be used for both reflow and wave soldering process.

- 270° outgoing elbow for horizontal inverted PCB connection
- Suitable for reflow and wave soldering processes
- Compliance with Moisture Level 1
- Available prepared engineering data (EDA)

Product data

IEC: 630 V / 26.8 A
UL: 300 V / 18.5 A



For additional articles and information, refer to catalog.weidmueller.com

Note:

- Rated current related to rated cross-section & min. No. of poles.
- P on drawing = pitch
- Rated data refer only to the component itself. Clearance and creepage distances to other components are to be designed in accordance with the relevant application standards.
- Diameter of solder eyelet D = 1.4+0.1mm
- Long term storage of the product with average temperature of 50 °C and average humidity 70%, 36 months

MHS 7S/.. W T3 B T

Tube packaging



Dimensioned drawing

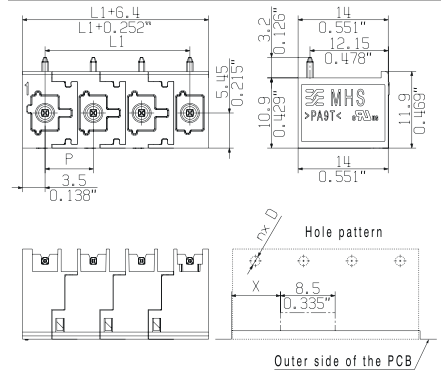

Technical data

In compliance with IEC 60664-1 / IEC 61984

Clamping range, max.			
Solid core H05(07) V-U			
Stranded H07 V-R			
Flexible H05(07) V-K			
Flexible with ferrule			
Ferrule with plastic collar			
Stripping length			
Screwdriver blade	mm		
According to norm			
Tightening torque range			
Rated current, max.	A	26.8	23.1
At ambient temperature		20°C	40°C
For conductor cross-section			
Overvoltage category		III	III II
Pollution severity		3	2 2
Rated voltage	V	400	500 630
Rated impulse voltage	kV	4	4 4
UL / CUL (Use Group)		B	C D
Rated voltage	V	300	300 300
Rated current	A	18.5	18.5 10
AWG conductor	AWG		-
CSA (Use Group)		B	C D
Rated voltage	V		
Rated current	A		
AWG conductor	AWG		
General data			
Type of insulation material		PA 9T	
UL 94 flammability rating		V-0	
Contact base material		CuMg	
Material of contact surface		tinned	
Pin dimensions = d	mm	1.0 x 1.0	
Solder eyelet Ø = D	mm	1.4	
Solder eyelet Ø tolerance	mm	+ 0,1	

Ordering data

Solder pin length	3.2 mm			
Colour	black			
Pitch	7.50 mm			
Pol.	L1	(inch)	Qty.	Order No.
2	7.50	0.295	39	8000078321
3	15.00	0.591	25	8000078322
4	22.50	0.886	19	8000078323
5	30.00	1.181	15	8000078324
6	37.50	1.476	12	8000078325
7	45.00	1.772	10	8000078326
8	52.50	2.067	9	8000078327

Connectors in 7.50 mm pitch
Series MHS / MPS 7S - Connection up to 4 mm²

OMNIMATE® 4.0

B

MPS 7S - straight

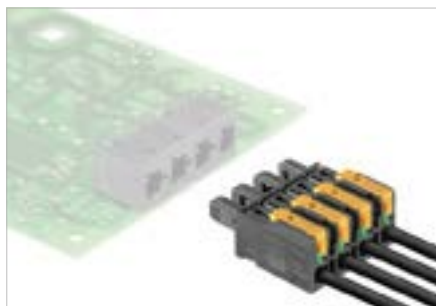

The compact power connectors of OMNIMATE® 4.0 combine three innovations in one product: the fastest connection technology SNAP IN, a modular product design with flexible configuration options, and the fastest possible delivery.

- Particularly fast, safe and tool-free wiring thanks to SNAP IN connection
- Optical and acoustic feedback indicates proper wiring
- Tool-free rewiring via lever operation
- Individual color and font marking in the configurator

Technical data

In compliance with IEC 60664-1 / IEC 61984			
Clamping range, max.	mm ²	0.5...4	
Solid core H05(07) V-U	mm²	0.5...2.5	
Stranded H07 V-R			
Flexible H05(07) V-K	mm ²	0.5...4	
Flexible with ferrule	mm ²	0.5...2.5	
Ferrule with plastic collar	mm ²	0.5...2.5	
Stripping length	mm	9	
Screwdriver blade	mm		
According to norm			
Tightening torque range			
Rated current, max.	A	26.8	23.1
At ambient temperature		20°C	40°C
For conductor cross-section			
Overtoltage category		III	III II
Pollution severity		3	2 2
Rated voltage	V	630	1000 1000
Rated impulse voltage	kV	4	4
UL / CUL (Use Group)		B	C D
Rated voltage	V	600	600 600
Rated current	A	18.5	18.5 10
AWG conductor	AWG	20-12	
CSA (Use Group)		B	C D
Rated voltage	V		
Rated current	A		
AWG conductor	AWG	-	
General data			
Type of insulation material		PBT GF	
UL 94 flammability rating		V-0	
Contact base material		CuSn	
Material of contact surface		tinned	
Pin dimensions = d	mm		
Solder eyelet Ø = D			
Solder eyelet Ø tolerance	mm		

7.50

180°

2.5 mm²

Product data

IEC: 1000 V / 26.8 A / 0.5 - 4 mm²
 UL: 600 V / 18.5 A / AWG 20 - 12



For additional articles and information, refer to catalog.weidmuller.com

Note:

- Rated current related to rated cross-section & min. No. of poles.
- P on drawing = pitch
- Rated data refer only to the component itself. Clearance and creepage distances to other components are to be designed in accordance with the relevant application standards.
- Wire end ferrule without plastic collar to DIN 46228/1
- Long term storage of the product with average temperature of 50 °C and average humidity 70%, 36 months

MPS 7S/.. S TN B B

Box packaging



Dimensioned drawing

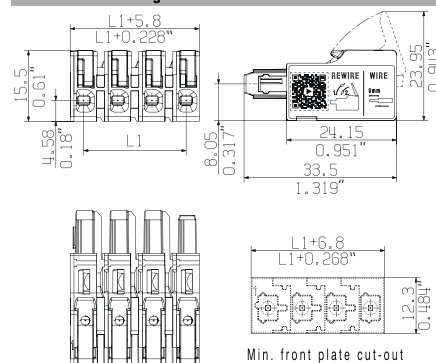

Ordering data

Solder pin length					
Colour					black
Pitch 7.50 mm					
Pol.	L1	(inch)	Qty.	Order No.	
2	7.50	0.295	138	8000078328	
3	15.00	0.591	84	8000078329	
4	22.50	0.886	66	8000078330	
5	30.00	1.181	48	8000078331	
6	37.50	1.476	42	8000078332	
7	45.00	1.772	36	8000078333	
8	52.50	2.067	30	8000078334	

MPS 7S - straight, top flange

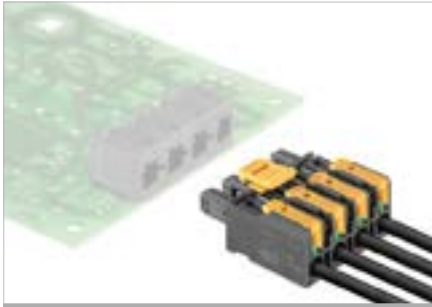

The compact power connectors of OMNIMATE® 4.0 combine three innovations in one product: the fastest connection technology SNAP IN, a modular product design with flexible configuration options, and the fastest possible delivery.

- Particularly fast, safe and tool-free wiring thanks to SNAP IN connection
- Optical and acoustic feedback indicates proper wiring
- Tool-free operation thanks to lever and top fixation
- Individual color and font marking in the configurator

Technical data

In compliance with IEC 60664-1 / IEC 61984			
Clamping range, max.	mm ²	0.5...4	
Solid core H05(07) V-U	mm ²	0.5...2.5	
Stranded H07 V-R			
Flexible H05(07) V-K	mm ²	0.5...4	
Flexible with ferrule	mm ²	0.5...2.5	
Ferrule with plastic collar	mm ²	0.5...2.5	
Stripping length	mm	9	
Screwdriver blade	mm		
According to norm			
Tightening torque range			
Rated current, max.	A	26.8	23.1
At ambient temperature	20°C	40°C	
For conductor cross-section			
Overtoltage category		III	III II
Pollution severity		3	2 2
Rated voltage	V	630	1000 1000
Rated impulse voltage	kV	4 4	
UL / CUL (Use Group)		B	C D
Rated voltage	V	600	600 600
Rated current	A	18.5	18.5 10
AWG conductor	AWG	20-12	
CSA (Use Group)		B	C D
Rated voltage	V		
Rated current	A		
AWG conductor	AWG	-	
General data			
Type of insulation material		PBT GF	
UL 94 flammability rating		V-0	
Contact base material		CuSn	
Material of contact surface		tinned	
Pin dimensions = d	mm		
Solder eyelet Ø = D			
Solder eyelet Ø tolerance	mm		

Product data

IEC: 1000 V / 26.8 A / 0.5 - 4 mm²
UL: 600 V / 18.5 A / AWG 20 - 12



For additional articles and information, refer to catalog.weidmueller.com

Note:

- Rated current related to rated cross-section & min. No. of poles.
- P on drawing = pitch
- Rated data refer only to the component itself. Clearance and creepage distances to other components are to be designed in accordance with the relevant application standards.
- Wire end ferrule without plastic collar to DIN 46228/1
- Long term storage of the product with average temperature of 50 °C and average humidity 70%, 36 months

MPS 7S/.. S F.. TN B B

Box packaging



Dimensioned drawing

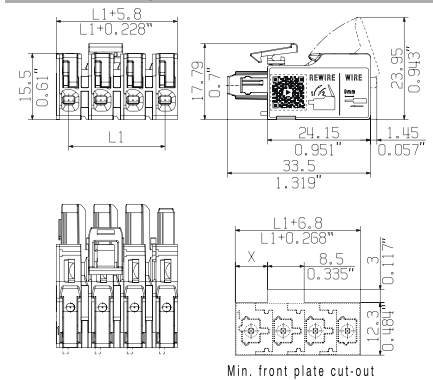

Ordering data

Solder pin length				
Colour				black
Pitch 7.50 mm				
Pol.	L1	(inch)	Qty.	Order No.
2	7.50	0.295	138	8000078353
3	15.00	0.591	84	8000078354
4	22.50	0.886	66	8000078355
5	30.00	1.181	48	8000078356
6	37.50	1.476	42	8000078357
7	45.00	1.772	36	8000078358
8	52.50	2.067	30	8000078359

Hybrid connectors with 7.50 mm and 5.00 mm pitch
Series MHS / MPS 7S/..-5/.. - Connection up to 4 mm²

OMNIMATE® 4.0

B

MHS 7S/..-5/.. - horizontal

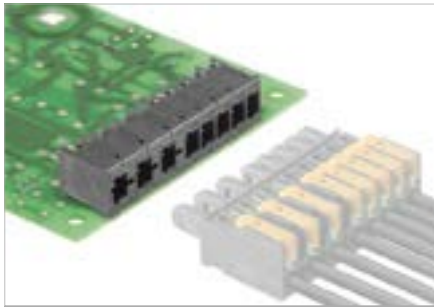

The modular product design of OMNIMATE® 4.0 enables the simple combination of different modules for the transmission of power and signals in a single connector.

- Combination of modules for power and signal transmission
- 90° outgoing elbow for horizontal PCB outgoing
- Suitable for reflow and wave soldering processes
- Individual configurations with further outgoing directions in the configurator

Technical data

In compliance with IEC 60664-1 / IEC 61984			
Clamping range, max.			
Solid core H05(07) V-U			
Stranded H07 V-R			
Flexible H05(07) V-K			
Flexible with ferrule			
Ferrule with plastic collar			
Stripping length			
Screwdriver blade	mm		
According to norm			
Tightening torque range			
Rated current, max.	A	26.8	23.1
At ambient temperature		20°C	40°C
For conductor cross-section			
Overvoltage category		III	III II
Pollution severity		3	2 2
Rated voltage	V	400	500 630
Rated impulse voltage	kV	4	4 4
UL / CUL (Use Group)		B	C D
Rated voltage	V	300	300 300
Rated current	A	18.5	18.5 10
AWG conductor	AWG		-
CSA (Use Group)		B	C D
Rated voltage	V		
Rated current	A		
AWG conductor	AWG		-
General data			
Type of insulation material		PA 9T	
UL 94 flammability rating		V-0	
Contact base material		CuSn	
Material of contact surface		tinned	
Pin dimensions = d	mm	1.0 x 1.0	
Solder eyelet Ø = D	mm	1.4	
Solder eyelet Ø tolerance	mm	+ 0,1	

Product data

IEC: 630 V / 26.8 A
UL: 300 V / 18.5 A



For additional articles and information, refer to catalog.weidmuller.com

Note:

- Rated current related to rated cross-section & min. No. of poles.
- P on drawing = pitch
- Rated data refer only to the component itself. Clearance and creepage distances to other components are to be designed in accordance with the relevant application standards.
- Diameter of solder eyelet D = 1.4+0.1mm
- Long term storage of the product with average temperature of 50 °C and average humidity 70%, 36 months

MHS 7S/..-5/.. H T3 B T

Tube packaging



Dimensioned drawing

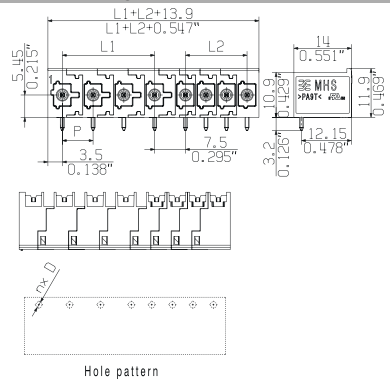

Ordering data

Solder pin length		3.2 mm				
Colour		black				
Pitch		7.50 mm				
Poles	L1 (inch)	L2 (inch)	Qty.	Order No.		
4	7.50	0.295	5.00	0.197	20	8000078335
5	7.50	0.295	10.00	0.394	17	8000078338
5	15.00	0.591	5.00	0.197	16	8000078336
6	7.50	0.295	15.00	0.591	15	8000078341
6	15.00	0.591	10.00	0.394	14	8000078339
6	22.50	0.886	5.00	0.197	13	8000078337
7	15.00	0.591	15.00	0.591	12	8000078342
7	22.50	0.886	10.00	0.394	11	8000078340
8	22.50	0.886	15.00	0.591	10	8000078343

7.50

MPS 7S/..-5/.. - straight



The modular product design of OMNIMATE® 4.0 enables the simple combination of different modules for the transmission of power and signals in a single connector.

- Combination of modules for power and signal transmission
- Particularly fast, safe and tool-free wiring thanks to SNAP IN connection
- Optical and acoustic feedback indicates proper wiring
- Individual configurations with optional top fixing incl. markings in the configurator

Technical data

In compliance with IEC 60664-1 / IEC 61984			
Clamping range, max.	mm ²	0.5...4	
Solid core H05(07) V-U	mm²	0.5...2.5	
Stranded H07 V-R			
Flexible H05(07) V-K	mm ²	0.5...4	
Flexible with ferrule	mm ²	0.5...2.5	
Ferrule with plastic collar	mm ²	0.5...2.5	
Stripping length	mm	9	
Screwdriver blade	mm		
According to norm			
Tightening torque range			
Rated current, max.	A	26.8	23.1
At ambient temperature		20°C	40°C
For conductor cross-section	mm ²	2.5	
Overvoltage category		III	III II
Pollution severity		3	2 2
Rated voltage	V	1000 1000	
Rated impulse voltage	kV	4 4	
UL / CUL (Use Group)		B	C D
Rated voltage			
Rated current	A	18.5	18.5 10
AWG conductor	AWG	20-12	
CSA (Use Group)		B	C D
Rated voltage			
Rated current	A		
AWG conductor	AWG	-	
General data			
Type of insulation material		PBT GF	
UL 94 flammability rating		V-0	
Contact base material		CuSn	
Material of contact surface		tinned	
Pin dimensions = d	mm		
Solder eyelet Ø = D			
Solder eyelet Ø tolerance	mm		

Product data

IEC: 1000 V / 26.8 A / 0.5 - 4 mm²
UL: / 18.5 A / AWG 20 - 12



For additional articles and information, refer to catalog.weidmuller.com

Note:

- Rated current related to rated cross-section & min. No. of poles.
- P on drawing = pitch
- Rated data refer only to the component itself. Clearance and creepage distances to other components are to be designed in accordance with the relevant application standards.
- Wire end ferrule without plastic collar to DIN 46228/1
- Long term storage of the product with average temperature of 50 °C and average humidity 70%, 36 months

MPS 7S/..-5/.. S TN B

Box packaging



Dimensioned drawing

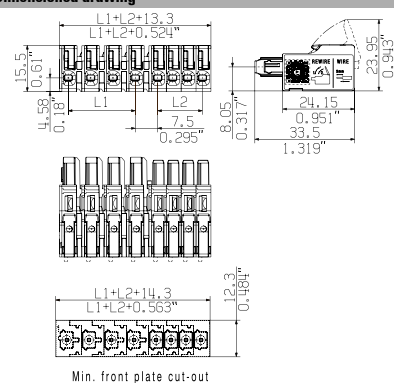

Ordering data

Solder pin length						
Colour						black
Pitch 7.50 mm						
Poles	L1 (inch)	L2 (inch)	Qty.	Order No.		
4	7.50	0.295	5.00	0.197	72	8000078344
5	7.50	0.295	10.00	0.394	60	8000078347
5	15.00	0.591	5.00	0.197	54	8000078345
6	7.50	0.295	15.00	0.591	48	8000078350
6	15.00	0.591	10.00	0.394	48	8000078348
6	22.50	0.886	5.00	0.197	42	8000078346
7	15.00	0.591	15.00	0.591	42	8000078351
7	22.50	0.886	10.00	0.394	36	8000078349
8	22.50	0.886	15.00	0.591	36	8000078352

Hybrid connector with 5.00 mm pitch incl. Single Pair Ethernet
Series MHS / MPS 5/.. D11 - Connection up to 2.50 mm²

OMNIMATE® 4.0

B

MHS 5/.. SPE - horizontal

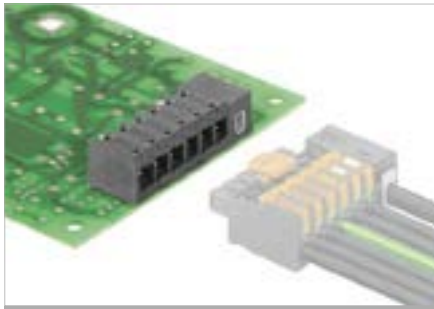

The modular product design of OMNIMATE® 4.0 enables the simple combination of power, signal and data transmissions in a single connector. Together with the Single Pair Ethernet technology, the cabling effort can be reduced and automation processes accelerated in a wide range of applications.

- Combination of modules with 5.00 mm pitch and Single Pair Ethernet (SPE)
- Integrated data transmission thanks to future-proof Single Pair Ethernet (SPE) technology
- Suitable for reflow and wave soldering processes
- Individual configurations with additional pole variants in the configurator

Technical data

In compliance with IEC 60664-1 / IEC 61984			
Clamping range, max.			
Solid core H05(07) V-U			
Stranded H07 V-R			
Flexible H05(07) V-K			
Flexible with ferrule			
Ferrule with plastic collar			
Stripping length			
Screwdriver blade	mm		
According to norm			
Tightening torque range			
Rated current, max.	A	26.8	23.1
At ambient temperature		20°C	40°C
For conductor cross-section			
Overvoltage category		III	III II
Pollution severity		3	2 2
Rated voltage	V	250	320 400
Rated impulse voltage	kV	4	4 4
UL / CUL (Use Group)		B	C D
Rated voltage	V	300	300
Rated current	A	14	10
AWG conductor	AWG		-
CSA (Use Group)		B	C D
Rated voltage	V		
Rated current	A		
AWG conductor	AWG		-
General data			
Type of insulation material		PA 9T	
UL 94 flammability rating		V-0	
Contact base material		CuMg	
Material of contact surface		tinned	
Pin dimensions = d	mm	1.0 x 1.0	
Solder eyelet Ø = D	mm	1.4	
Solder eyelet Ø tolerance	mm	+ 0,1	

Product data

IEC: 400 V / 26.8 A
 UL: 300 V / 14 A



For additional articles and information, refer to catalog.weidmueller.com

Note:

- Rated current related to rated cross-section & min. No. of poles.
- P on drawing = pitch
- Rated data refer only to the component itself. Clearance and creepage distances to other components are to be designed in accordance with the relevant application standards.
- Diameter of solder eyelet D = 1.4±0.1mm
- Long term storage of the product with average temperature of 50 °C and average humidity 70%, 36 months

MHS 5/.. D11 H T3 B T

Tube packaging



Dimensioned drawing

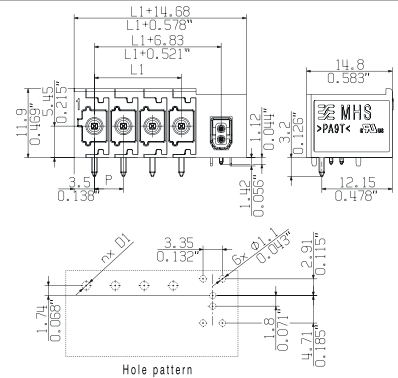

Ordering data

Solder pin length		3.2 mm	
Colour		black	
Pitch		5.00 mm	
Pol.	L1	(inch)	Qty. Order No.
3	10.00	0.394	22 2741520000
4	15.00	0.591	18 2741530000
5	20.00	0.787	15 2741540000
6	25.00	0.984	13 2741550000

5.00

MPS 5/.. SPE - straight

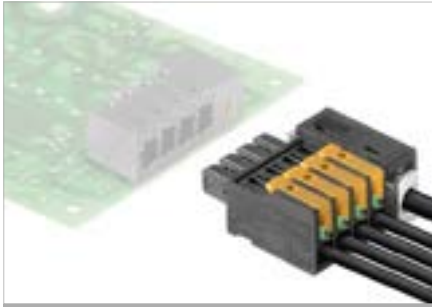

The modular product design of OMNIMATE® 4.0 enables the simple combination of power, signal and data transmissions in a single connector. Together with the integration of SNAP IN connection technology and Single Pair Ethernet technology, cabling effort can be reduced and automation processes accelerated in a wide range of applications.

- Combination of modules with 5.00 mm pitch and Single Pair Ethernet (SPE)
- Particularly fast, safe and tool-free wiring thanks to SNAP IN connection
- Integrated data transmission thanks to future-proof Single Pair Ethernet (SPE) technology
- Individual configurations with additional pole variants and printing in the configurator

Technical data

In compliance with IEC 60664-1 / IEC 61984

Clamping range, max.	mm ²	0.5...2.5	
Solid core H05(07) V-U	mm²	0.5...2.5	
Stranded H07 V-R			
Flexible H05(07) V-K	mm ²	0.5...4	
Flexible with ferrule	mm ²	0.5...2.5	
Ferrule with plastic collar	mm ²	0.5...2.5	
Stripping length	mm	9	
Screwdriver blade	mm		
According to norm			
Tightening torque range			
Rated current, max.	A	26.8	23.1
At ambient temperature	20°C		40°C
For conductor cross-section			
Overvoltage category		III	III II
Pollution severity		3	2 2
Rated voltage	V	250	320 400
Rated impulse voltage	kV	4	4 4
UL / CUL (Use Group)		B	C D
Rated voltage	V	300	300
Rated current	A	18.5	10
AWG conductor	AWG	18-14	
CSA (Use Group)		B	C D
Rated voltage	V		
Rated current	A		
AWG conductor	AWG	-	
General data			
Type of insulation material		PBT GF	
UL 94 flammability rating		V-0	
Contact base material		CuSn	
Material of contact surface		tinned	
Pin dimensions = d	mm		
Solder eyelet Ø = D	mm		
Solder eyelet Ø tolerance	mm		

Product data

IEC: 400 V / 26.8 A / 0.5 - 4 mm²
UL: 300 V / 18.5 A / AWG 18 - 14



For additional articles and information, refer to catalog.weidmuller.com

Note:

- Rated current related to rated cross-section & min. No. of poles.
- P on drawing = pitch
- Rated data refer only to the component itself. Clearance and creepage distances to other components are to be designed in accordance with the relevant application standards.
- Wire end ferrule without plastic collar to DIN 46228/1
- Long term storage of the product with average temperature of 50 °C and average humidity 70%, 36 months

MPS 5/.. D11 S TN B

Box packaging



Dimensioned drawing

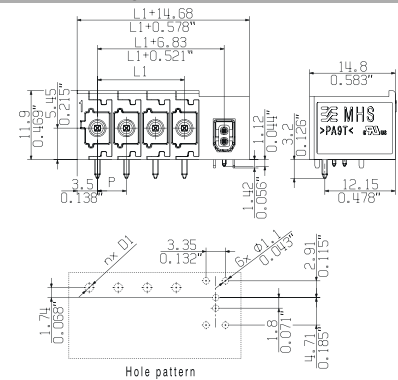

Ordering data

Solder pin length

Colour		black	
Pitch	5.00 mm		
Pol.	L1	(inch)	Qty. Order No.
3	10.00	0.394	72 2741780000
4	15.00	0.591	60 2741790000
5	20.00	0.787	48 2741800000
6	25.00	0.984	42 2741810000

Hybrid connector with 5.00 mm pitch incl. Single Pair Ethernet
Series MHS / MPS 5/.. D11 - Connection up to 2.50 mm²

OMNIMATE® 4.0

B

MPS 5/.. SPE - straight, top flange



The modular product design of OMNIMATE® 4.0 enables the simple combination of power, signal and data transmissions in a single connector. Together with the integration of SNAP IN connection technology and Single Pair Ethernet technology, cabling effort can be reduced and automation processes accelerated in a wide range of applications.

- Combination of modules with 5.00 mm pitch and Single Pair Ethernet (SPE) incl. top-fixation
- Particularly fast, safe and tool-free wiring thanks to SNAP IN connection
- Integrated data transmission thanks to future-proof Single Pair Ethernet (SPE) technology
- Individual configurations with additional pole variants and printing in the configurator

Technical data

In compliance with IEC 60664-1 / IEC 61984			
Clamping range, max.	mm ²	0.5...2.5	
Solid core H05(07) V-U	mm²	0.5...2.5	
Stranded H07 V-R			
Flexible H05(07) V-K	mm ²	0.5...4	
Flexible with ferrule	mm ²	0.5...2.5	
Ferrule with plastic collar	mm ²	0.5...2.5	
Stripping length	mm	9	
Screwdriver blade	mm		
According to norm			
Tightening torque range			
Rated current, max.	A	26.8	23.1
At ambient temperature		20°C	40°C
For conductor cross-section			
Overvoltage category		III	III II
Pollution severity		3	2 2
Rated voltage	V	250	320 400
Rated impulse voltage	kV	4	4 4
UL / CUL (Use Group)		B	C D
Rated voltage	V	300	300
Rated current	A	18.5	10
AWG conductor	AWG	18-14	
CSA (Use Group)		B	C D
Rated voltage	V		
Rated current	A		
AWG conductor	AWG	-	
General data			
Type of insulation material		PBT GF	
UL 94 flammability rating		V-0	
Contact base material		CuSn	
Material of contact surface		tinned	
Pin dimensions = d	mm		
Solder eyelet Ø = D			
Solder eyelet Ø tolerance	mm		

Product data

IEC: 400 V / 26.8 A / 0.5 - 4 mm²
 UL: 300 V / 18.5 A / AWG 18 - 14



For additional articles and information, refer to catalog.weidmueller.com

Note:

- Rated current related to rated cross-section & min. No. of poles.
- P on drawing = pitch
- Rated data refer only to the component itself. Clearance and creepage distances to other components are to be designed in accordance with the relevant application standards.
- Wire end ferrule without plastic collar to DIN 46228/1
- Long term storage of the product with average temperature of 50 °C and average humidity 70%, 36 months

MPS 5/.. D11 S F.. TN B B

Box packaging



Dimensioned drawing

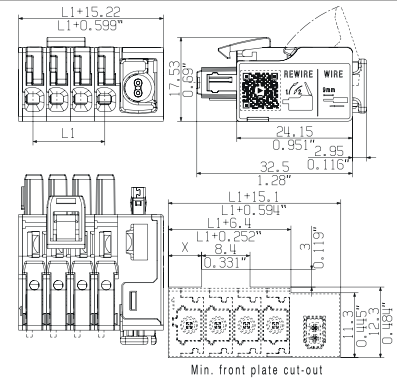

Ordering data

Solder pin length					
Colour					black
Pitch	5.00 mm		Qty.	Order No.	
3	10.00	0.394	72	2741890000	
4	15.00	0.591	60	2741900000	
5	20.00	0.787	48	2741910000	
6	25.00	0.984	42	2741920000	

5.00

180°

2.5 mm²

MHS 7S/..5/.. SPE - horizontal

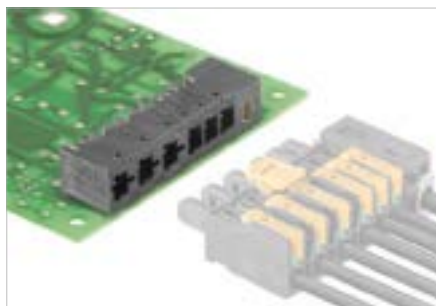

The modular product design of OMNIMATE® 4.0 enables the simple combination of power, signal and data transmissions in a single connector. Together with the single-pair Ethernet technology, the cabling effort can be reduced and automation processes accelerated in a wide range of applications.

- Combination of modules with 7.50 mm and 5.00 mm pitch and Single Pair Ethernet (SPE)
- Integrated data transmission thanks to future-proof Single Pair Ethernet (SPE) technology
- Suitable for reflow and wave soldering processes
- Individual configurations with additional pole variants in the configurator

Technical data

In compliance with IEC 60664-1 / IEC 61984

Clamping range, max.			
Solid core H05(07) V-U			
Stranded H07 V-R			
Flexible H05(07) V-K			
Flexible with ferrule			
Ferrule with plastic collar			
Stripping length			
Screwdriver blade	mm		
According to norm			
Tightening torque range			
Rated current, max.	A	26.8	23.1
At ambient temperature		20°C	40°C
For conductor cross-section			
Overvoltage category		III	III II
Pollution severity		3	2 2
Rated voltage	V	400	500 630
Rated impulse voltage	kV	4	4 4
UL / CUL (Use Group)		B	C D
Rated voltage	V	300	300 300
Rated current	A	18.5	18.5 10
AWG conductor	AWG		-
CSA (Use Group)		B	C D
Rated voltage	V		
Rated current	A		
AWG conductor	AWG		-
General data			
Type of insulation material		PA 9T	
UL 94 flammability rating		V-0	
Contact base material		CuSn	
Material of contact surface		tinned	
Pin dimensions = d	mm	1.0 x 1.0	
Solder eyelet Ø = D	mm	1.4	
Solder eyelet Ø tolerance	mm	+ 0,1	

Product data

IEC: 630 V / 26.8 A
UL: 300 V / 18.5 A



For additional articles and information, refer to catalog.weidmueller.com

Note:

- Rated current related to rated cross-section & min. No. of poles.
- P on drawing = pitch
- Rated data refer only to the component itself. Clearance and creepage distances to other components are to be designed in accordance with the relevant application standards.
- Diameter of solder eyelet D = 1.4+0.1mm
- Long term storage of the product with average temperature of 50 °C and average humidity 70%, 36 months

MHS 7S/..5/.. D11 H T3 B T

Tube packaging



Dimensioned drawing

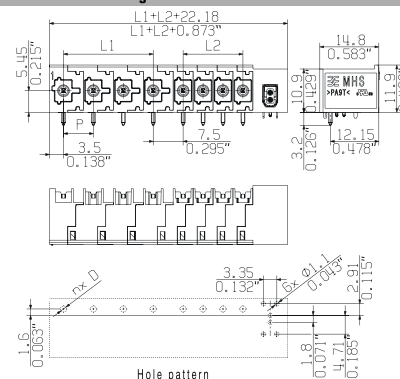

Ordering data

Solder pin length	3.2 mm					
Colour	black					
Pitch	7.50 mm					
Poles	L1	(inch)	L2	(inch)	Qty.	Order No.
5	15.00	0.591	5.00	0.197	13	8000085192
6	22.50	0.886	5.00	0.197	11	8000085260
7	15.00	0.591	15.00	0.591	10	8000085261
8	22.50	0.886	15.00	0.591	9	8000085263

Hybrid connectors with 7.50 mm and 5.00 mm pitch incl. Single Pair Ethernet Series MHS/MPS 7S/..5/..D11 - connection up to 4 mm²

OMNIMATE® 4.0

B

MPS 7S/..5/.. SPE - straight



The modular product design of OMNIMATE® 4.0 enables the simple combination of power, signal and data transmissions in a single connector. Together with the integration of SNAP IN connection technology and single-pair Ethernet technology, cabling effort can be reduced and automation processes accelerated in a wide range of applications.

- Combination of modules with 7.50 mm and 5 mm pitch and Single Pair Ethernet (SPE)
- Particularly fast, safe and tool-free wiring thanks to SNAP IN connection
- Integrated data transmission thanks to future-proof Single Pair Ethernet (SPE) technology
- Individual configurations with additional pole variants, optional top fixing and printing in the configurator

Technical data

In compliance with IEC 60664-1 / IEC 61984			
Clamping range, max.	mm ²	0.5...4	
Solid core H05(07) V-U	mm ²	0.5...2.5	
Stranded H07 V-R			
Flexible H05(07) V-K	mm ²	0.5...4	
Flexible with ferrule	mm ²	0.5...2.5	
Ferrule with plastic collar	mm ²	0.5...2.5	
Stripping length	mm	9	
Screwdriver blade	mm		
According to norm			
Tightening torque range			
Rated current, max.	A	26.8	23.1
At ambient temperature		20°C	40°C
For conductor cross-section	mm ²	2.5	
Overvoltage category		III	III II
Pollution severity		3	2 2
Rated voltage	V	1000	1000
Rated impulse voltage	kV	4	4
UL / CUL (Use Group)		B	C D
Rated voltage			
Rated current	A	18.5	18.5 10
AWG conductor	AWG	20-12	
CSA (Use Group)		B	C D
Rated voltage			
Rated current	A		
AWG conductor	AWG		-
General data			
Type of insulation material		PBT GF	
UL 94 flammability rating		V-0	
Contact base material		CuSn	
Material of contact surface		tinned	
Pin dimensions = d	mm		
Solder eyelet Ø = D	mm		
Solder eyelet Ø tolerance	mm		

Product data

IEC: 1000 V / 26.8 A / 0.5 - 4 mm²
 UL: / 18.5 A / AWG 20 - 12



For additional articles and information, refer to catalog.weidmuller.com

Note:

- Rated current related to rated cross-section & min. No. of poles.
- P on drawing = pitch
- Rated data refer only to the component itself. Clearance and creepage distances to other components are to be designed in accordance with the relevant application standards.
- Wire end ferrule without plastic collar to DIN 46228/1
- Long term storage of the product with average temperature of 50 °C and average humidity 70%, 36 months

MPS 7S/..5/.. D11 S TN B

Box packaging



Dimensioned drawing

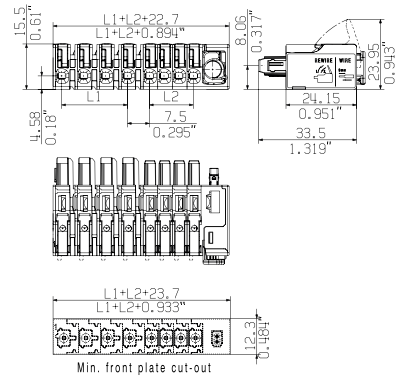

Ordering data

Solder pin length						
Colour						black
Pitch 7.50 mm						
Poles	L1 (inch)	L2 (inch)	Qty.	Order No.		
5	15.00	0.591	5.00	0.197	42	8000085268
6	22.50	0.886	5.00	0.197	36	8000085269
7	15.00	0.591	15.00	0.591	30	8000085270
8	22.50	0.886	15.00	0.591	30	8000085271

7.50

180°

2.5 mm²

OMNIMATE® Data – SPE

OMNIMATE® Data – SPE	Explanation	C.2
	Quick selection	C.8
	Assembled cable IP20 / IP67	C.10
	PCB and field attachable components	C.13

Single Pair Ethernet

The network infrastructure for Industrial IIoT

C

In the factory of the future, machines and systems will be connected to each other consistently via a data infrastructure. These cyber-physical systems can act independently in the Industrial Internet of Things (IIoT), communicate in real time, and control production processes. In order to enable this, a continuous network with high-performance data connections from the sensor to the cloud is required. This pushes conventional Ethernet systems to their limits.

Single Pair Ethernet (SPE) facilitates the extension of the Ethernet to the sensor. It is compact, flexible, and enables high ranges. This means that data connections are achievable in situations where conventional Ethernet systems have reached their limits. SPE provides for the extension of existing installations and supports consistent communication based on the Ethernet protocol. Indeed, SPE is considered by Weidmüller as the missing component needed to close the current gap in the supply of standard Ethernet at field level.

SPE runs at the same transmission speeds as conventional Ethernet but with simplified 2-wire cabling technology and data lines up to 1,000 m in length. Together with other new technologies such as TSN, OPC-UA, or 5G, SPE enables both continuous IP communication between the server and the cloud, as well as supplying up to 60 Watts of power in complex IIoT solutions through PoDL (Power over Data Line).



The new standard for high demands

SPE connectors for the industry

SPE connections can transfer data and power using only one twin wire. This enables both end-to-end IP communication between server and cloud, as well as power supply in complex IIoT solutions. SPE connectors therefore are particularly efficient and future-oriented.

The market requirements for data connectors in the field level are:

- Smallest, most compact design possible for implementing IIoT devices
- High robustness for use in industrial environments
- Easy to connect for safe, fast installation
- Future-proof design through international standards

Advantages of SPE connectors at a glance:

Miniaturisation

Industrial suitability



Simplicity

Future-proof

Particularly compact

Miniaturisation of SPE connectors according to IEC 63171-2

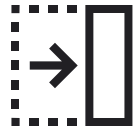

C Weidmuller has been developing user-friendly connectors for industrial use, according to IEC63171-2. With a pitch of 7.62mm the compact connector system saves up to 50% space in comparison to RJ45 interfaces. The vertical arrangement of the two contacts allows a very high packing density. This enables device manufacturers to save valuable space on the PCB and to build smaller devices. This reduces port costs in device construction and effectively saves space in the control cabinet.

Small mating face

- Currently the smallest mating face according to IEC 63171 on the market

High packing density

- Double the packing density compared to RJ45 connectors
- Doubling of the interfaces with the same housing contour
- Only 20% of the volume of an RJ45 jack
- Minimum space requirement in the device

Easy IP67-integration

- Can be integrated into standard M8 housings and connectors as with I/O-Link or PROFINET
- M8 connectors with male and female contacts available
- Front and rear panel mounting with male and female contacts supported
- Simple integration in M8 sensors
- Inverse M8 system possible



Made for highest demands

The industrial suitability of SPE connectors

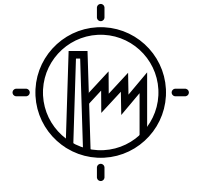

Originally developed for automotive applications, the aim of single pair ethernet technology was to realise the most efficient infrastructure capable of delivering high performance with as little cabling as possible. There are similar expectations within industry applications and building automation where the number of intelligent end devices in the plant is increasing but the amount of available space is not. Weidmuller SPE connector solutions deliver long cable lengths, a compact design that is simple, robust and vibration-proof, as well as being insensitive to electromagnetic influences.

Mechanical robustness

- Robust metal housing with metal snap-in hooks
- Safe industrial double contacting compared to single-sided contacting RJ45
- Shock resistant and vibration resistant according to IEC 60068
- Stable latching with lateral forces

EMC Compatibility

- Coupling attenuation at 600 MHz according to IEEE 802.3
- Additional burst test according to IEC 61000-6-2
- Optimum shield connection on the PCB due to four symmetrical legs

Industrial suitability

- PCB connectors for environments up to pollution degree 2
- Impulse voltage strength of 2.25 kV according to IEEE 802.3
- Optimum contact distance for 100 Ohm systems



Easy to use

The simplicity of SPE connectors



Ethernet technology is too complex for many industrial applications. SPE components are clearly superior due to their simplicity. Compared to four-pair Ethernet, installation is less difficult and allows a significant reduction in space and weight. SPE connectors also enable robust cabling in a short time. At the same time, they offer extended cable lengths in an extremely compact design.

Proven locking mechanism

- Industry standard plugs and sockets with metal Snap-in hooks locking
- Known locking and unlocking mechanism as for RJ45 connectors
- High holding force (> 50 N)

Tool-free installation

- Well proven IDC connection technology
- Simple assembly due to a two-part connector
- Clear colour coding to prevent miswiring
- Suitable for all commercially available SPE cables

Easy integration

- Trouble-free integration into M8 housings and connectors
- Compatibility of IP20 and IP67 variants
- Optional use of the IP20 connector as service connector for devices with M8IP67 interfaces



Ready for the challenges of tomorrow

Future-proof SPE connectors



SPE is the next milestone in network technology, as it enables continuous intelligent networking across all levels. SPE is scalable, deterministic, and fully compatible, allowing all components to communicate with each other. As a comprehensive key technology for applications in the field of Industry 4.0 and IIoT, it will form the core of a wide range of industrial applications in the future.

Extensive support

The SPE product family is already supported by several well-known connector manufacturers, which have joined together to form the Single Pair Ethernet System Alliance. This collaboration, with leading technology companies from a wide range of markets and application areas, means that the level of combined technological competence will result in unprecedented and lasting benefits for all users.

Suitable for low to high transmission rates

With SPE components, only a compact IEC standard interface is required to connect a sensor to the cloud via the data centre. The interface is suitable for various Ethernet applications with transfer rates from 10 Mbit/s to 1 Gbit/s. Simulations confirm a bandwidth of up to 2.5 GHz – this corresponds to the new Ethernet transmission standard IEEE 802.3ch, which is currently under development for up to 10 Gbit/s.

Increase of the port density

In the near future, a new and innovative four-chamber system will be available that will enable the port density for IP20 and IP67 systems to be quadrupled. This means that SPE technology can also be used in standard M12 connectors. It will also allow extremely compact IIoT devices with 32 ports to be implemented, and can be integrated into existing housing structures.

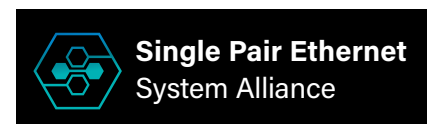



Single Pair Ethernet Solutions

Ordering data

IP-20 SPE cabling

Type	Versions	Qty.	Order No.
 IE-S1DS2VE0010T01T01-E	Patch cable overmoulded, IP 20, Female-Female, 1m	1	2725850010
IE-S1DS2VE0020T01T01-E	Patch cable overmoulded, IP 20, Female-Female, 2m	1	2725850020
IE-S1DS2VE0030T01T01-E	Patch cable overmoulded, IP 20, Female-Female, 3m	1	2725850030
IE-S1DS2VE0050T01T01-E	Patch cable overmoulded, IP 20, Female-Female, 5m	1	2725850050
IE-S1DS2VE0100T01T01-E	Patch cable overmoulded, IP 20, Female-Female, 10m	1	2725850100
IE-S1DS2VE0150T01T01-E	Patch cable overmoulded, IP 20, Female-Female, 15m	1	2725850150
IE-S1DS2VE0400T01T01-E	Patch cable overmoulded, IP 20, Female-Female, 40m	1	2725850400

IP-67 SPE cabling

 IE-S1DS2VE0020TM1TM1-E	Patch cable overmoulded, M8 IP 67, Female-Female, 2m	1	2726050020
IE-S1DS2VE0050TM1TM1-E	Patch cable overmoulded, M8 IP 67, Female-Female, 5m	1	2726050050
IE-S1DS2VE0100TM1TM1-E	Patch cable overmoulded, M8 IP 67, Female-Female, 10m	1	2726050100
IE-S1DS2VE0150TM1TM1-E	Patch cable overmoulded, M8 IP 67, Female-Female, 15m	1	2726050150
IE-S1DS2VE0200TM1TM1-E	Patch cable overmoulded, M8 IP 67, Female-Female, 20m	1	2726050200
IE-S1DS2VE0400TM1TM1-E	Patch cable overmoulded, M8 IP 67, Female-Female, 40m	1	2726050400
 IE-S1DS2VE0020TM1TM2-E	Patch cable overmoulded, M8 IP67, Female-Male, 2m	1	2726060020
 IE-S1DS2VE0020TM2TM2-E	Patch cable overmoulded, M8 IP67, Male-Male, 2m	1	2726070020



PCB components & field attachable components

	Type	Versions	Qty.	Order No.
	IE-PCB-SP0-P-90V-THR	PCB connector, IP20, 90°, THR Male	100	2726010000
	IE-PCB-SP0-P-90V-THR-YG/YG	PCB connector, IP20, 90°, LED, THR, Male	100	2795120000
	IE-PCB-SP0-P-180V-THR	PCB connector, IP 20, 180°, THR, Male	100	2795170000
	IE-PS-SP0-S-FH-180	Field attachable plug IP20, Female	1	2726040000
	IE-BHD-SPE-M8-OT-FP	M8 Device housing, front panel mounting	10	2726020000
	IE-BHD-SPE-M8-OT-BP	M8 Device housing, back panel mounting	20	2726030000
	IE-BHD-SPE-BP-CN-M10X0.75	Befestigungsmutter für M8 Gehäuse	10	2739640000
	IE-PCB-SPM-P-180-THR	M8 SPE insert, 180°, THR, Male	100	2735920000
	IE-PCB-SPM-P-180-SMD	M8 SPE insert, 180°, SMD, Male	100	2795110000
	IE-PCB-SPM-P-90-THR	M8 SPE insert, 90°, THR, Male	100	2795100000
	IE-AD-SP0-P-SPM-P-90	SPE IP20 to SPE M8 adapter / panel feed-through, Male	1	2814400000

**Assembled cable
IP20**

Plug - Plug

Socket contact / Socket contact

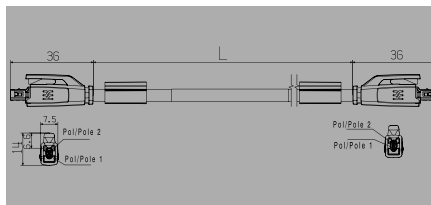

Technical data

Product type
Category
Shielding
Ambient temperature (operational)
Rated voltage (DC)
Rated current
PoE / PoE+
Transmission rate
Dielectric strength, contact / contact
Dielectric strength, contact / shield
Characteristic impedance
Capacity at 800 Hz
Coupling attenuation 1 to 600 MHz
Coupling attenuation up to 1000 MHz
Test voltage: wire-wire-shield
Resistance differential
Transmission rate
Version connector left
Version connector right
Number of wires
Colour coding
Complete shielding / Overlap of shielding braid
Insulation
Insulation diameter
Sheath diameter, min. / max.
Cross-section / Strands
Shielding
Material sheath
Colour
Halogen
UV-resistant
Connector standard
Note

Patch cable
STP
-40...80 °C
60 V
3.5 A
PoDL acc. to IEEE 802.3bu / cg
10/100 MBit/s, 1000 MBit/s
1000 V DC
2250 V DC
100 ± 15 Ω at 20 MHz
1.6 nF/km
Type I
1 kV DC, 1 min
2 %
10/100 MBit/s, 1000 MBit/s
SPE plug (IEC 63171-2) - IP20 socket contact straight
SPE plug (IEC 63171-2) - IP20 socket contact straight
2
white / blue
Shielding braid made from copper wiring / 80 %
PE
1.65 mm
4.9 / 5.3 mm
2*AWG 22 / 7
STP
PVC
black
Yes
Complies with UL 1581 Sec. 1200
IEC 63171-2
Note

Ordering data

	1.0 m
	2.0 m
	3.0 m
	5.0 m
	10.0 m
	15.0 m
	40.0 m
Note	

Type	Qty.	Order No.
IE-S1DS2VE0010T01T01-E	1	2725850010
IE-S1DS2VE0020T01T01-E	1	2725850020
IE-S1DS2VE0030T01T01-E	1	2725850030
IE-S1DS2VE0050T01T01-E	1	2725850050
IE-S1DS2VE0100T01T01-E	1	2725850100
IE-S1DS2VE0150T01T01-E	1	2725850150
IE-S1DS2VE0400T01T01-E	1	2725850400
Note		

M8 plug Male / Male

Socket contact / Socket contact

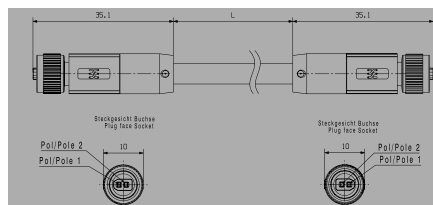

M8 plug Male / Female

Socket contact / Pin contact

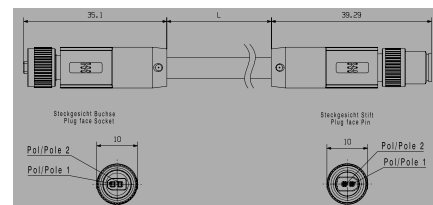

Technical data

Product type	Patch cable
Category	STP
Shielding	-40...85 °C
Ambient temperature (operational)	60 V
Rated voltage (DC)	3.5 A
Rated current	PoDL acc. to IEEE 802.3bu / cg
PoE / PoE+	10/100 MBit/s, 1000 MBit/s
Transmission rate	1000 V DC
Dielectric strength, contact / contact	2250 V DC
Dielectric strength, contact / shield	3.5A @ 0°C
Current-carrying capacity	100 ± 15 Ω at 20 MHz
Characteristic impedance	1.6 nF/km
Capacity at 800 Hz	Type I
Coupling attenuation 1 to 600 MHz	1 kV DC, 1 min
Coupling attenuation up to 1000 MHz	2 %
Test voltage: wire-wire-shield	10/100 MBit/s, 1000 MBit/s
Resistance differential	M8 SPE (IEC63171-5) - IP67 socket contact - straight
Transmission rate	M8 SPE (IEC63171-5) - IP67 socket contact - straight
Version connector left	2
Version connector right	white / blue
Number of wires	Shielding braid made from copper wiring / 80 %
Colour coding	PE
Complete shielding / Overlap of shielding braid	1.65 mm
Insulation	4.9 / 5.3 mm
Insulation diameter	2*AWG 22 / 7
Sheath diameter, min. / max.	STP
Cross-section / Strands	PVC
Shielding	black
Material sheath	Yes
Colour	Complies with UL 1581 Sec. 1200
Halogen	IEC 63171-5
UV-resistant	
Connector standard	
Note	

Ordering data

	2.0 m	Type	Qty.	Order No.
	5.0 m	IE-S1DS2VE0020TM1TM1-E	1	2726050020
	10.0 m	IE-S1DS2VE0050TM1TM1-E	1	2726050050
	15.0 m	IE-S1DS2VE0100TM1TM1-E	1	2726050100
	20.0 m	IE-S1DS2VE0150TM1TM1-E	1	2726050150
	40.0 m	IE-S1DS2VE0200TM1TM1-E	1	2726050200
		IE-S1DS2VE0400TM1TM1-E	1	2726050400
Note				

Product type	Patch cable
Category	STP
Shielding	-40...85 °C
Ambient temperature (operational)	60 V
Rated voltage (DC)	3.5 A
Rated current	PoDL acc. to IEEE 802.3bu / cg
PoE / PoE+	10/100 MBit/s, 1000 MBit/s
Transmission rate	1000 V DC
Dielectric strength, contact / contact	2250 V DC
Dielectric strength, contact / shield	3.5A @ 0°C
Current-carrying capacity	100 ± 15 Ω at 20 MHz
Characteristic impedance	1.6 nF/km
Capacity at 800 Hz	Type I
Coupling attenuation 1 to 600 MHz	1 kV DC, 1 min
Coupling attenuation up to 1000 MHz	2 %
Test voltage: wire-wire-shield	10/100 MBit/s, 1000 MBit/s
Resistance differential	M8 SPE (IEC63171-5) - IP67 socket contact - straight
Transmission rate	M8 SPE (IEC63171-5) - IP67 pin contact - straight
Version connector left	2
Version connector right	white / blue
Number of wires	Shielding braid made from copper wiring / 80 %
Colour coding	PE
Complete shielding / Overlap of shielding braid	1.65 mm
Insulation	4.9 / 5.3 mm
Insulation diameter	2*AWG 22 / 7
Sheath diameter, min. / max.	STP
Cross-section / Strands	PVC
Shielding	black
Material sheath	Yes
Colour	Complies with UL 1581 Sec. 1200
Halogen	IEC 63171-5
UV-resistant	
Connector standard	
Note	

Product type	Patch cable
Category	STP
Shielding	-40...85 °C
Ambient temperature (operational)	60 V
Rated voltage (DC)	3.5 A
Rated current	PoDL acc. to IEEE 802.3bu / cg
PoE / PoE+	10/100 MBit/s, 1000 MBit/s
Transmission rate	1000 V DC
Dielectric strength, contact / contact	2250 V DC
Dielectric strength, contact / shield	3.5A @ 0°C
Current-carrying capacity	100 ± 15 Ω at 20 MHz
Characteristic impedance	1.6 nF/km
Capacity at 800 Hz	Type I
Coupling attenuation 1 to 600 MHz	1 kV DC, 1 min
Coupling attenuation up to 1000 MHz	2 %
Test voltage: wire-wire-shield	10/100 MBit/s, 1000 MBit/s
Resistance differential	M8 SPE (IEC63171-5) - IP67 socket contact - straight
Transmission rate	M8 SPE (IEC63171-5) - IP67 pin contact - straight
Version connector left	2
Version connector right	white / blue
Number of wires	Shielding braid made from copper wiring / 80 %
Colour coding	PE
Complete shielding / Overlap of shielding braid	1.65 mm
Insulation	4.9 / 5.3 mm
Insulation diameter	2*AWG 22 / 7
Sheath diameter, min. / max.	STP
Cross-section / Strands	PVC
Shielding	black
Material sheath	Yes
Colour	Complies with UL 1581 Sec. 1200
Halogen	IEC 63171-5
UV-resistant	
Connector standard	
Note	

	2.0 m	Type	Qty.	Order No.
	5.0 m	IE-S1DS2VE0020TM1TM2-E	1	2726060020
	10.0 m			
	15.0 m			
	20.0 m			
	40.0 m			
Note				

**Assembled cable
IP67**

M8 plug Female / Female

Pin contact / Pin contact

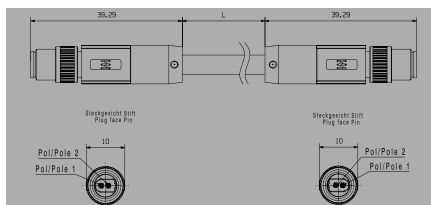

Technical data

Product type	Patch cable
Category	STP
Shielding	-40...85 °C
Ambient temperature (operational)	60 V
Rated voltage (DC)	3.5 A
Rated current	PoDL acc. to IEEE 802.3bu / cg
PoE / PoE+	10/100 MBit/s, 1000 MBit/s
Transmission rate	1000 V DC
Dielectric strength, contact / contact	2250 V DC
Dielectric strength, contact / shield	3.5A @ 0°C
Current-carrying capacity	100 ± 15 Ω at 20 MHz
Characteristic impedance	1.6 nF/km
Capacity at 800 Hz	Type I
Coupling attenuation 1 to 600 MHz	1 kV DC, 1 min
Coupling attenuation up to 1000 MHz	2 %
Test voltage: wire-wire-shield	10/100 MBit/s, 1000 MBit/s
Resistance differential	M8 SPE (IEC63171-5) - IP67 pin contact - straight
Transmission rate	M8 SPE (IEC63171-5) - IP67 pin contact - straight
Version connector left	2
Version connector right	white / blue
Number of wires	Shielding braid made from copper wiring / 80 %
Colour coding	PE
Complete shielding / Overlap of shielding braid	1.65 mm
Insulation	4.9 / 5.3 mm
Insulation diameter	2*AWG 22 / 7
Sheath diameter, min. / max.	STP
Cross-section / Strands	PVC
Shielding	black
Material sheath	Yes
Colour	Complies with UL 1581 Sec. 1200
Halogen	IEC 63171-5
UV-resistant	
Connector standard	

Note

Ordering data

	2.0 m
	5.0 m
	10.0 m
	15.0 m
	20.0 m
	40.0 m
Note	

Type	Qty.	Order No.
IE-S1DS2VE0020TM2TM2-E	1	2726070020

Plug

- Only one pair of cables for data and power
- Multi-port support
- IP20

Field-terminated plug IP20

Socket contact

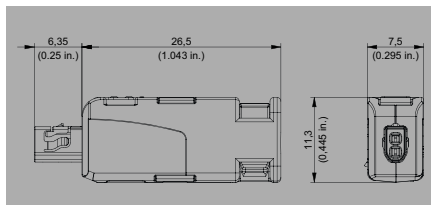

Technical data

Category
 Protection degree
 Ambient temperature (operational)
 Plugging cycles
 Housing main material
 Contact material
 Contact surface
 Rated voltage
 Rated current
 Insulation cross-section, min.
 Insulation cross-section, max.
 Insulation strength
 PoE / PoE+
 Dielectric strength, contact / contact
 Dielectric strength, contact / shield
 Connector standard
 UL 94 flammability rating

IP20
 -40...85 °C
 750
 zinc diecast nickel-plated
 Bronze tin-plated
 4 A
 0.85 mm
 1.6 mm
 ≥ 500 MΩ
 PoDL acc. to IEEE 802.3bu / cg
 ≥ 1000 V DC
 ≥ 1500 V DC
 IEC 63171-2
 V-0

Note

Ordering data

Plug	field-terminated plug
Note	

Type	Qty.	Order No.
IE-PS-SP0-S-FH-180	1	2726040000

PCB and field attachable components

PCB connector IP20

- Only one pair of cables for data and power
- Multi-port support
- Robust locking mechanism
- Shock and vibration proof
- Most compact design

PCB connector, 90°

Pin contact



PCB connector, 90°, incl. LED

Pin contact

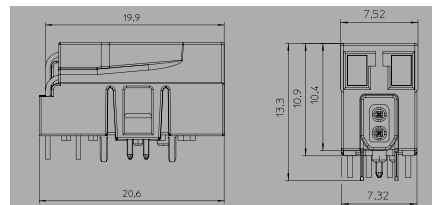
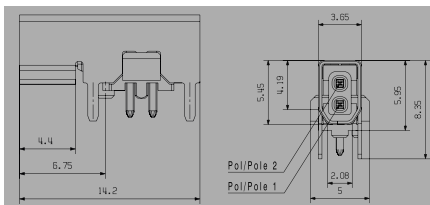

Technical data

Category	
Protection degree	IP20
Ambient temperature (operational)	-40...85 °C
Transmission rate	10/100 MBit/s, 1000 MBit/s
Type of connection	Solder connection, Male contact
Outgoing elbow	90°
Number of poles	2
Mounting onto the PCB	THT/THR solder connection
Plugging cycles	750
Contact material	Cu
Contact surface	Ni/Au
Rated voltage	72 V
Rated current	4 A
Insulation strength	≥ 500 MΩ
PoE / PoE+	PoDL acc. to IEEE 802.3bu / cg
Dielectric strength, contact / contact	1000 V DC
Dielectric strength, contact / shield	2250 V DC
Connector standard	IEC 63171-2
UL 94 flammability rating	V-0
Note	

Category	
Protection degree	IP20
Ambient temperature (operational)	-40...85 °C
Transmission rate	10/100 MBit/s, 1000 MBit/s
Type of connection	Solder connection, Male contact
Outgoing elbow	90°
Number of poles	2
Mounting onto the PCB	THT/THR solder connection
Plugging cycles	750
Contact material	Cu
Contact surface	Ni/Au
Rated voltage	72 V
Rated current	4 A
Insulation strength	≥ 500 MΩ
PoE / PoE+	PoDL acc. to IEEE 802.3bu / cg
Dielectric strength, contact / contact	1000 V DC
Dielectric strength, contact / shield	2250 V DC
Connector standard	IEC 63171-2
UL 94 flammability rating	V-0
Note	

Category	
Protection degree	IP20
Ambient temperature (operational)	-40...85 °C
Transmission rate	10/100 MBit/s, 1000 MBit/s
Type of connection	Solder connection, Male contact
Outgoing elbow	90°
Number of poles	2
Mounting onto the PCB	THT/THR solder connection
Plugging cycles	750
Contact material	Cu
Contact surface	Ni/Au
Rated voltage	72 V
Rated current	4 A
Insulation strength	≥ 500 MΩ
PoE / PoE+	PoDL acc. to IEEE 802.3bu / cg
Dielectric strength, contact / contact	1000 V DC
Dielectric strength, contact / shield	2250 V DC
Connector standard	IEC 63171-2
UL 94 flammability rating	V-0
Note	

Ordering data

	PCB connector, IP20, pin contact
	PCB connector, IP20, pin contact incl. LEDs
Note	

Type	Qty.	Order No.
IE-PCB-SP0-P-90V-THR	100	2726010000
Note		

Type	Qty.	Order No.
IE-PCB-SP0-P-90V-THR-YG/YG	100	2795120000
Bi-colour LED: yellow/green yellow/green		
Note		

PCB connector IP20

- Only one pair of cables for data and power
- Multi-port support
- Robust locking mechanism
- Shock and vibration proof
- Most compact design

PCB connector, 180°

Pin contact

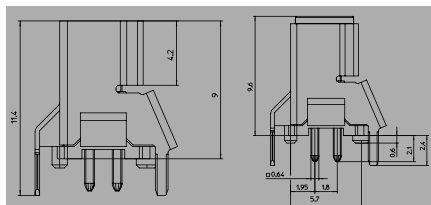

Technical data

Category
 Protection degree
 Ambient temperature (operational)
 Transmission rate
 Type of connection
 Outgoing elbow
 Number of poles
 Mounting onto the PCB
 Plugging cycles
 Contact material
 Contact surface
 Rated voltage
 Rated current
 Insulation strength
 PoE / PoE+
 Dielectric strength, contact / contact
 Dielectric strength, contact / shield
 Connector standard
 UL 94 flammability rating

IP20
 -40...85 °C
 10/100 MBit/s, 1000 MBit/s
 Solder connection, Male contact
 180°
 2
 THT/THR solder connection
 750
 Cu
 Ni/Au
 72 V
 4 A
 ≥ 500 MΩ
 PoDL acc. to IEEE 802.3bu / cg
 1000 V DC
 2250 V DC
 IEC 63171-2
 V-0

Note

Ordering data

PCB connector, IP20, pin contact
 PCB connector, IP20, pin contact incl. LEDs

Type	Qty.	Order No.
IE-PCB-SP0-P-180V-THR	100	2795170000

Note

Empty housing

M8 front wall mounting

M8 rear wall mounting

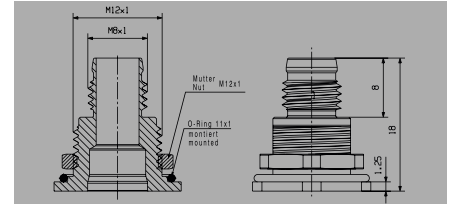
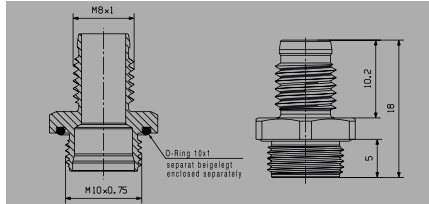

Technical data

Category
Ambient temperature (operational)
Protection degree
Housing main material
Seal material
Configuration
Type of mounting
Connection thread
Connector standard
Tightening torque fixing nut
Note

-40...85 °C
IP67
Brass, nickel-plated
FKM
Frontpanel mounting
Screw mounting
M10 x 0.75
IEC 61076-2-104, IEC 63171-5
2.5 Nm
Note

40...85 °C
IP67
Brass, nickel-plated
FKM
Backpanel mounting
Screw mounting
M10 x 0.75
IEC 61076-2-104, IEC 63171-5
2.5 Nm
Note

Ordering data

Note

Type	Qty.	Order No.
IE-BHD-SPE-M8-OT-FP	10	2726020000
Inserts and fixing nut must be ordered separately.		

Type	Qty.	Order No.
IE-BHD-SPE-M8-OT-BP	20	2726030000
Inserts to be ordered separately, fixing nut included.		

Accessories

Fastening nut
Note

Type	Qty.	Order No.
IE-BHD-SPE-FP-CN-M10X0.75	10	2739640000

Type	Qty.	Order No.
IE-BHD-SPE-FP-CN-M10X0.75	10	2739640000

PCB insert

M8 insert 180° pin contacts

M8 insert 90° pin contacts

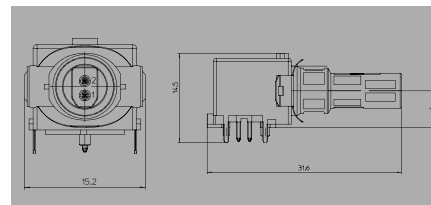
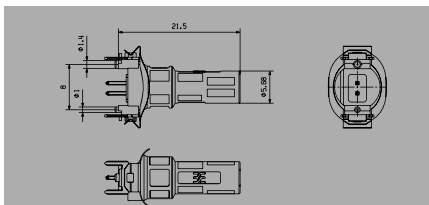

Technical data

Category	
Ambient temperature (operational)	
Protection degree	
Pollution severity	
Connection thread	
Number of poles	
Type of connection	
Outgoing elbow	
Contact material	
Contact surface	
Contact carrier material	
Operational voltage range	
Rated current	
Insulation strength	
Dielectric strength, contact / contact	
Dielectric strength, contact / shield	
Connector standard	
UL 94 flammability rating	
Note	

Ambient temperature (operational)	-40...85 °C
Protection degree	IP67 with housing
Pollution severity	2
Connection thread	M8
Number of poles	2
Type of connection	Solder connection, Male contact
Outgoing elbow	180°
Contact material	Copper alloy
Contact surface	Ni/Au
Contact carrier material	LCP
Operational voltage range	≤ 50 V AC, ≤ 60 V DC
Rated current	4 A
Insulation strength	≥ 500 MΩ
Dielectric strength, contact / contact	1000 V DC
Dielectric strength, contact / shield	2250 V DC
Connector standard	IEC 63171-5
UL 94 flammability rating	V-0
Note	

Ambient temperature (operational)	-40...85 °C
Protection degree	IP67 with housing
Pollution severity	2
Connection thread	M8
Number of poles	2
Type of connection	Solder connection, Male contact
Outgoing elbow	90°
Contact material	Copper alloy
Contact surface	Ni/Au
Contact carrier material	LCP
Operational voltage range	≤ 50 V AC, ≤ 60 V DC
Rated current	4 A
Insulation strength	≥ 500 MΩ
Dielectric strength, contact / contact	1000 V DC
Dielectric strength, contact / shield	2250 V DC
Connector standard	IEC 63171-5
UL 94 flammability rating	V-0
Note	

Ordering data

	THR
	SMD
Note	

Type	Qty.	Order No.
IE-PCB-SPM-P-180-THR	100	2735920000
IE-PCB-SPM-P-180-SMD	100	2795110000
Note		

Type	Qty.	Order No.
IE-PCB-SPM-P-90-THR	100	2795100000
Note		

Adapter IP20 / IP65 (M8)

Adapter

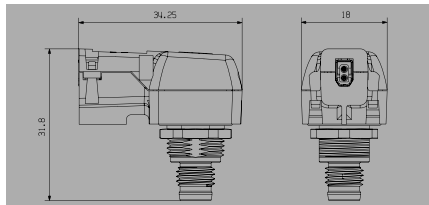

Technical data

Category	
Ambient temperature (operational)	-40...85 °C
Protection degree	IP65 (in plugged condition)
Connection 1 / 2 / Connection	SPE socket acc. to IEC 63171-2 / M8 socket male contact
Number of poles	2
Outlet direction	Angled
Contact material	Cu
Contact surface	Ni/Au
Contact carrier material	
Operational voltage range	≤ 50 V AC, ≤ 60 V DC
Rated current	4 A
Insulation strength	≥ 500 MΩ
Dielectric strength, contact / contact	≥ 1000 V DC
Dielectric strength, contact / shield	2250 V DC
Connector standard	IEC 63171-2, IEC 63171-5
UL 94 flammability rating	V-0
Note	

Ordering data

Type	Qty.	Order No.
IE-AD-SP0-P-SPM-P-90	10	2814400000
Note		

OMNIMATE® Data – RJ45

OMNIMATE® Data – RJ45	Explanation	D.2
	RJ45 modular jacks - Quick selection	D.4
	RJ45 modular jacks for SMT soldering process	D.6
	RJ45 modular jacks for THR soldering process	D.12
	RJ45 modular jacks for wave soldering process	D.18
	RJ45 transformer jacks - Quick selection	D.24
	RJ45 transformer jacks for SMT soldering process	D.26
	RJ45 transformer jacks for THR soldering process	D.28
	RJ45 transformer jacks for wave soldering process	D.38

OMNIMATE® Data RJ45 PCB jacks

The future-proof transmission solution in the industrial environment

A wide variety of PCB jacks are needed for the data transmission in Industrial Ethernet environment. Trends in technology, like the shift from fieldbus to Industrial Ethernet, demand an increasing number of designs of RJ45 PCB jacks to enable adaptation to individual housing design.

D

RJ45 components from Weidmüller ensure a reliable transmission with high data rates of up to 1 Gbps and provide sufficient safety reserves. With diverse variants, such as for THT, THR or SMT soldering methods, the PCB sockets are suitable for all common methods of circuit board assembly. The shielded technology also allows its use in products for harsh and electromagnetically noisy environments.

Improves corrosion protection, reduces contact problems

Reinforced gold layer (30µ") for high durability (≥750cycles)

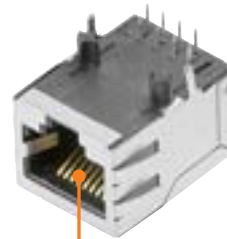

Trouble-free PCB assembly

Due to shorter solder pins with chamfered tips; SMT, THR or THT soldering technology; Tape on Reel or assembly by hand (Tray)



Equipped for the future
For data transmission rates
up to 10 Gbit/s

**Optimum adaptation to
various housing formats**
90° and 180° outlet directions
With and without LEDs and shield tabs



**Best possible wetting properties and
soldering result**
by min. 0.3mm stand-off and tinned ground pins



<http://www.OMNIMATE.net>

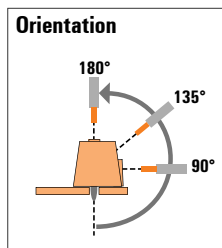

RJ45 modular jacks

- Shielded
- Contact surface: 30µ" Au
- Temperature range: -40 °C to +85 °C

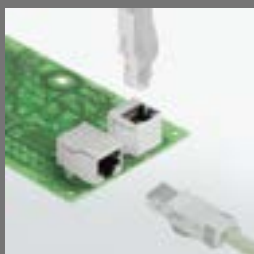

Mounting onto the PCB



SMT-soldering process



THR-soldering process



Wave soldering process

Reference picture	Outgoing elbow/ Latch option	Shield tabs	LED (left/right)	Performance category
	180° vertical	No	No	Cat.5
		Yes	No	Cat.5
	90° horizontal/latch down	No	No	Cat.5
		No	No	Cat.5
	90° horizontal/latch up	No	No	Cat.5
		Yes	G/Y	Cat.5
		Yes	No	Cat.5
	180° vertical	No	G/Y	Cat.5
		No	No	Cat.5
	90° horizontal/latch down	Yes	G/Y	Cat.5
		Yes	No	Cat.5
	90° horizontal/latch up	Yes	No	Cat.5
		No	G/Y	Cat.5
	180°/vertical	No	No	Cat.6
		No	G/Y	Cat.5
		No	No	Cat.5
		No	No	Cat.5
	90°/latch down	No	No	Cat.5
		Yes	G/Y	Cat.5
		Yes	No	Cat.5
	90°/latch up	No	No	Cat.6
		No	No	Cat.5
		Yes	G/Y	Cat.5
		Yes	No	Cat.5

Note:
 *1 Solder pin - shield THR
 *2 Solder pin - shield SMT
 *3 Solder pin - shield front

Packaging	Order No.	Type
Tape	1433900000	RJ45C3 S1V 2.7N4N RL
Tape	2514600000	RJ45C3 S1V 2.7E4N RL
Tape	2000890000	RJ45C3 S1D 2.7N4N RL*1
Tape	1433890000	RJ45C3 S1D 2.7N4N RL*2
Tape	1455220000	RJ45C3 S1U 0.9N4N RL
Tape	2562890000	RJ45C3 S1U DE4G/Y RL
Tape	2562940000	RJ45C3 S1U DE4N RL
Tray	2516380000	RJ45C5 R1V 3.2N4G/Y TY
Tape	2562970000	RJ45C5 R1V 3.2N4N RL
Tape	2562870000	RJ45C5 R1D 3.2E4G/Y RL
Tape	2562910000	RJ45C5 R1D 3.3E4N RL
Tape	2562930000	RJ45C5 R1U 2.8E4N RL
Tape	2562950000	RJ45C5 R1U 2.8N4G/Y RL
Tray	2626050000	RJ45C6 T1V 3.0N4N TY
Tray	2562960000	RJ45C5 T1V 3.2N4G/Y TY
Tray	2436450000	RJ45C5 T1V 4.0N4N TY
Tray	1433810000	RJ45C5 T1V 3.2N4N TY*3
Tray	1433800000	RJ45C5 T1D 3.2N4N TY
Tray	2562820000	RJ45C5 T1D 3.2E4G/Y TY
Tray	2562900000	RJ45C5 T1D 3.3E4N TY
Tray	1433910000	RJ45C6 T1U 2.7N4N TY
Tray	1455240000	RJ45C5 T1U 2.8N4N TY
Tray	2562880000	RJ45C5 T1U 2.8E4G/Y TY
Tray	2562920000	RJ45C5 T1U 2.8E4N TY

RJ45	G1	R	1	U	3.2	E	4	GY/GY	TY
Performance Category									
C5 Category 5 C6 Category 6 C6A Category 6A C5e Category 5e M 10/100 Mbit G1 10/100/1000 Mbit G10 10 Gbit U Unshielded MP 10/100 Mbit with POE MP+ 10/100 Mbit with POE+									
Assembly on PCB									
R Through Hole Reflow – THR Soldering process: Wave or Reflow soldering S Surface Mount Technology – SMT Soldering process: Reflow soldering T Through Hole Technology – THT Soldering process: Wave									
Number of Ports									
1 1 Port 12; 14; ... multi ports side by side, Multiport 21; 41; ... multi ports about each other, Multilevel									
Direction, latch style									
U Horizontal (90°, side entry), latch up D Horizontal (90°, side entry), latch down V Vertical (180°, top entry) Y Diagonal (45°), latch up									
Solder Pin length									
3.2 3.2 mm 1.6 1.6 mm D SMD									
EMI tabs (ground fingers)									
E E = with EMI tabs N N = without EMI tabs									
Contact surface thickness									
4 1 = 3µ", 2 = 6µ", 3 = 15µ", 4 = 30µ", 5 = 50µ"									
LED									
Y/G Yellow/Green G/Y Green/Yellow (standard) GY/GY Green-Yellow/Green-Yellow O/G Orange/Green R/O Red/Orange ... (further combinations possible) N without LED									
Packaging									
TY Tray in box (manual assembly) RL Tape on Reel (automated assembly)									

**RJ45 modular jacks
for SMT soldering process**

1x1 port, 180° (vertical)



- 360° shielding
- Contact surface 30µ" (0.76µm) Au
- ≥750 plugging cycles
- Extended temperature range: -40 °C to +85 °C
- For fully automatic assembly (tape-on-reel)
- Optimised package sizes
- Other variations on request

For additional articles and information, refer to catalog.weidmueller.com



Technical data

Outgoing elbow	180°
Pitch	1.27 mm
Type of insulation material	PA 9T
Colour	black
UL 94 flammability rating	V-0
Moisture Level (MSL)	1
Shielding material	Copper alloy
Shield surface	nickel-plated
Contact base material	Phosphorus bronze
Note	

Layer structure of plug contact	30...80 µ" Ni / ≥ 30 µ" Au
Operating temperature	-40...85 °C
Rated voltage	125 V
Rated current	1.5 A
Dielectric strength, contact / contact	1000 V DC
Insulation strength	≥ 500 MΩ
Plugging cycles	750
Approvals	CURUS

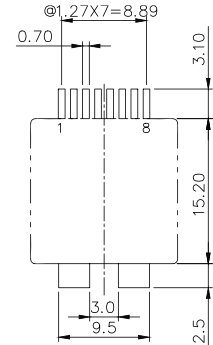
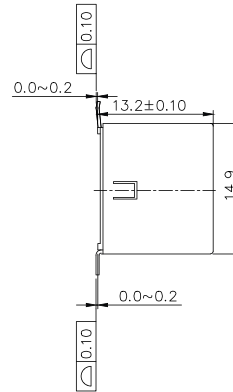
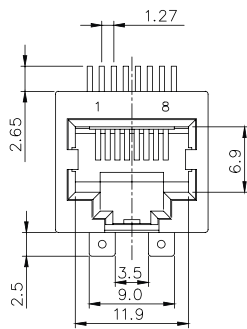

Ordering data

Type	Mounting onto the PCB	Latch option	Shield tabs	LED	Performance-Category	Packaging	Qty.	Order No.
RJ45C5 S1V 2.7N4N RL	SMD solder connection		none	No	Cat. 5	Tape	300	1433900000
Other versions on request								



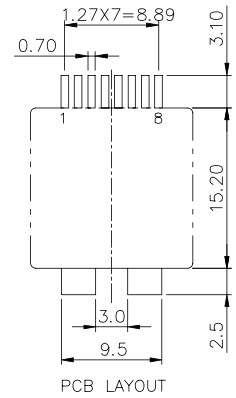
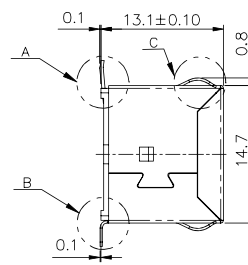
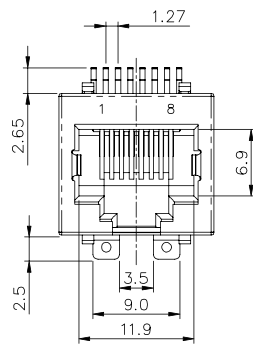

PCB LAYOUT

Ordering data

Type	Mounting onto the PCB	Latch option	Shield tabs	LED	Performance-Category	Packaging	Qty.	Order No.
RJ45C5 S1V 2.7E4N RL	SMD solder connection		4 tabs	No	Cat. 5	Tape	300	251460000

**RJ45 modular jacks
for SMT soldering process**

1x1 port, 90° (horizontal) latch down

For additional articles and information, refer to catalog.weidmuller.com



- 360° shielding
- Contact surface 30µ" (0.76µm) Au
- ≥750 plugging cycles
- Extended temperature range: -40 °C to +85 °C
- For fully automatic assembly (tape-on-reel)
- Optimised package sizes
- Other variations on request

Technical data

Outgoing elbow	90°
Pitch	1.27 mm
Type of insulation material	PA 9T
Colour	black
UL 94 flammability rating	V-0
Moisture Level (MSL)	1
Shielding material	Copper alloy
Shield surface	nickel-plated
Contact base material	Phosphorus bronze
Note	

Layer structure of plug contact	30...80 µ" Ni / ≥ 30 µ" Au
Operating temperature	-40...85 °C
Rated voltage	125 V
Rated current	1.5 A
Dielectric strength, contact / contact	1000 V DC
Insulation strength	≥ 500 MΩ
Plugging cycles	750
Approvals	CURUS

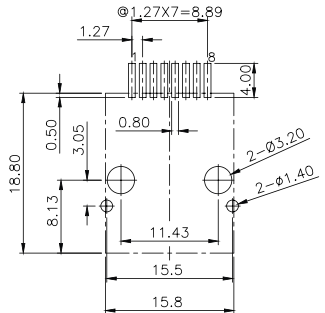
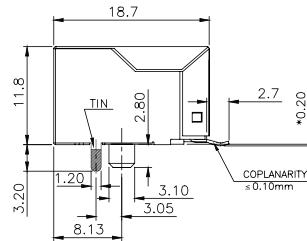
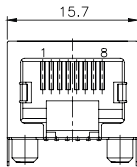

Ordering data

Type	Mounting onto the PCB	Latch option	Shield tabs	LED	Performance-Category	Packaging	Qty.	Order No.
RJ45C5 S1D 2.7N4N RL	SMD solder connection	bottom	none	No	Cat. 5	Tape	240	2000890000

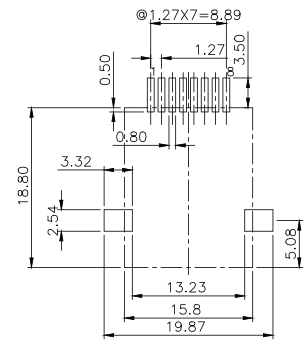
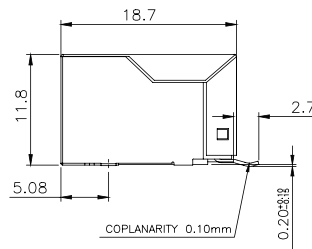
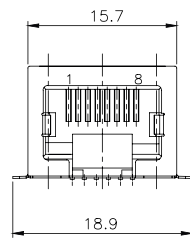

Recommended PCB
Layout (Top side)

Ordering data

Type	Mounting onto the PCB	Latch option	Shield tabs	LED	Performance-Category	Packaging	Qty.	Order No.
RJ45C5 S1D 2.7N4N RL	SMD solder connection	bottom	none	No	Cat. 5	Tape	260	1433890000
Other versions on request								

RJ45 modular jacks for SMT soldering process

1x1 port, 90° (horizontal) latch up



- 360° shielding
- Contact surface 30µ" (0.76µm) Au
- ≥750 plugging cycles
- Extended temperature range: -40 °C to +85 °C
- For fully automatic assembly (tape-on-reel)
- Optimised package sizes
- Other variations on request

For additional articles and information, refer to catalog.weidmuller.com



Technical data

Outgoing elbow	90°
Pitch	1.27 mm
Type of insulation material	PA 9T
Colour	black
UL 94 flammability rating	V-0
Moisture Level (MSL)	1
Shielding material	Copper alloy
Shield surface	nickel-plated
Contact base material	Phosphorus bronze
Note	

Layer structure of plug contact	30...80 µ" Ni / ≥ 30 µ" Au
Operating temperature	-40...85 °C
Rated voltage	125 V
Rated current	1.5 A
Dielectric strength, contact / contact	1000 V DC
Insulation strength	≥ 500 MΩ
Plugging cycles	750
Approvals	CURUS

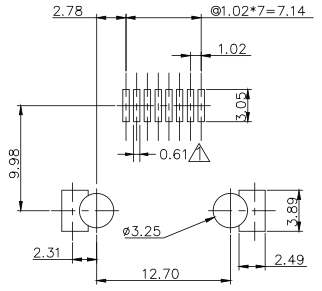
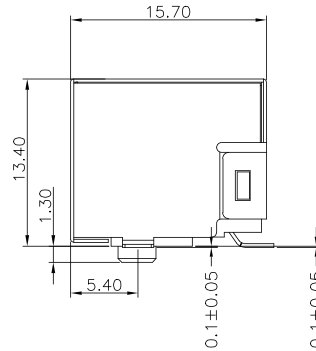
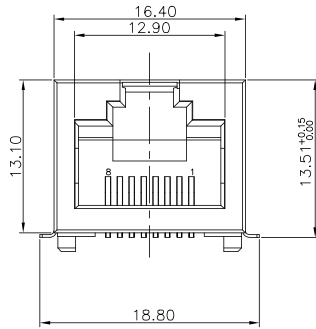

Ordering data

Type	Mounting onto the PCB	Latch option	Shield tabs	LED	Performance-Category	Packaging	Qty.	Order No.
RJ45C5E S1U 0.9N4N RL	SMD solder connection	top	none	No	Cat. 5e	Tape	200	1455220000

Other versions on request



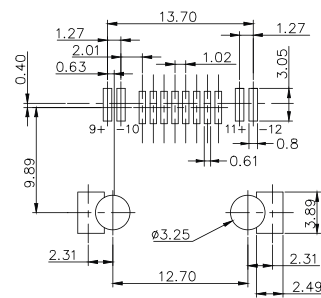
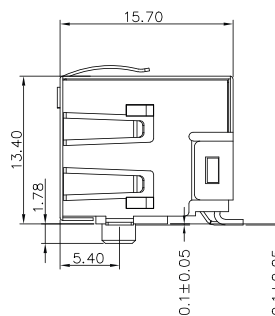
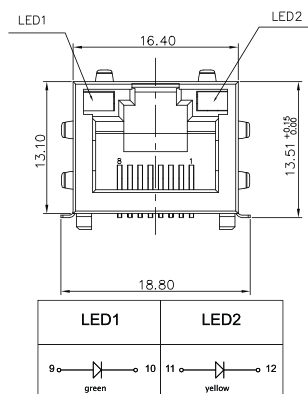

Ordering data

Type	Mounting onto the PCB	Latch option	Shield tabs	LED	Performance-Category	Packaging	Qty.	Order No.
RJ45C5E S1U DE4G/Y RL	SMD solder connection	top	6 tabs	Yes	Cat. 5e	Tape	200	2562890000

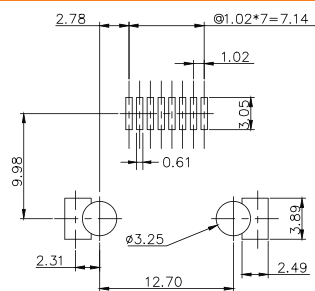
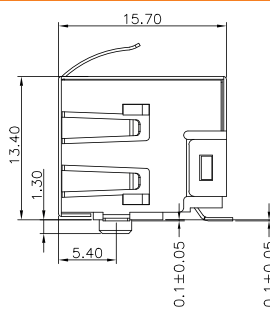
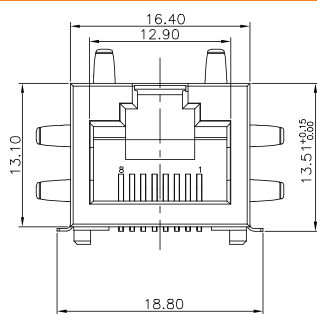

Ordering data

Type	Mounting onto the PCB	Latch option	Shield tabs	LED	Performance-Category	Packaging	Qty.	Order No.
RJ45C5E S1U DE4N RL	SMD solder connection	top	6 tabs	No	Cat. 5e	Tape	200	2562940000



**RJ45 modular jacks
for THR soldering process**

1x1 port, 180° (vertical)



- 360° shielding
- Contact surface 30µ" (0.76µm) Au
- ≥750 plugging cycles
- Extended temperature range: -40 °C to +85 °C
- For fully automated assembly (tape-on-reel) or manual assembly (tray)
- Optimised package sizes
- Other variations on request

For additional articles and information, refer to catalog.weidmueller.com



Technical data

Outgoing elbow	180°
Pitch	1.27 mm
Type of insulation material	PA 9T
Colour	black
UL 94 flammability rating	V-0
Moisture Level (MSL)	1
Shielding material	Brass
Shield surface	nickel-plated
Contact base material	Phosphorus bronze
Note	

Layer structure of plug contact	30...80 µ" Ni / ≥ 30 µ" Au
Operating temperature	-40...85 °C
Rated voltage	125 V
Rated current	1.5 A
Dielectric strength, contact / contact	1000 V DC
Insulation strength	≥ 500 MΩ
Plugging cycles	750
Approvals	CURUS

D

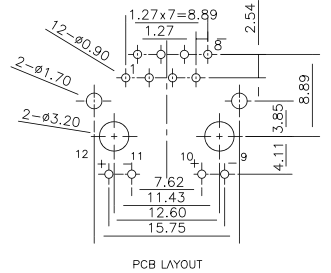
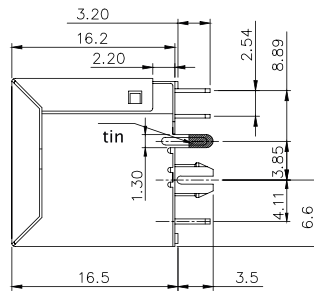
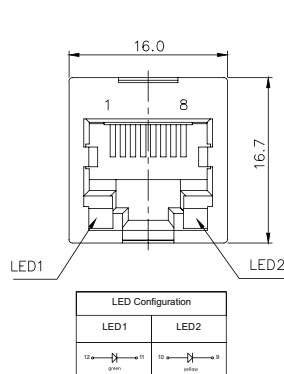

Ordering data

Type	Mounting onto the PCB	Latch option	Shield tabs	LED	Performance-Category	Packaging	Qty.	Order No.
RJ45C5 R1V 3.2N4G/Y TY	THT/THR solder connection		none	Yes	Cat. 5	Tray	120	2516380000



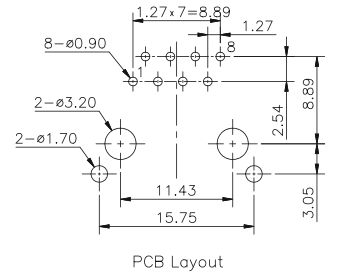
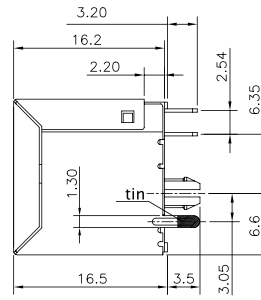
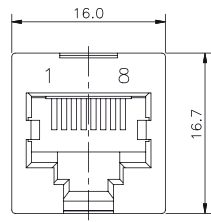

Ordering data

Type	Mounting onto the PCB	Latch option	Shield tabs	LED	Performance-Category	Packaging	Qty.	Order No.
RJ45C5 R1V 3.2N4N RL	THT/THR solder connection		none	No	Cat. 5	Tape	200	2562970000

**RJ45 modular jacks
for THR soldering process**

1x1 port, 90° (horizontal) latch down

For additional articles and information, refer to catalog.weidmuller.com



- 360° shielding
- Contact surface 30µ" (0.76µm) Au
- ≥750 plugging cycles
- Extended temperature range: -40 °C to +85 °C
- For fully automated assembly (tape-on-reel) or manual assembly (tray)
- Optimised package sizes
- Other variations on request

Technical data

Outgoing elbow	90°
Pitch	1.27 mm
Type of insulation material	PA 9T
Colour	black
UL 94 flammability rating	V-0
Moisture Level (MSL)	1
Shielding material	Brass
Shield surface	nickel-plated
Contact base material	Phosphorus bronze
Note	

Layer structure of plug contact	30..80 µ" Ni / ≥ 30 µ" Au
Operating temperature	-40..85 °C
Rated voltage	125 V
Rated current	1.5 A
Dielectric strength, contact / contact	1000 V DC
Insulation strength	≥ 500 MΩ
Plugging cycles	750
Approvals	CURUS

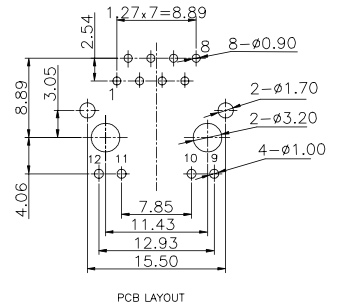
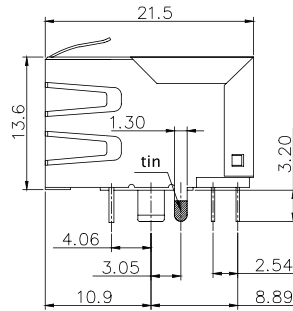
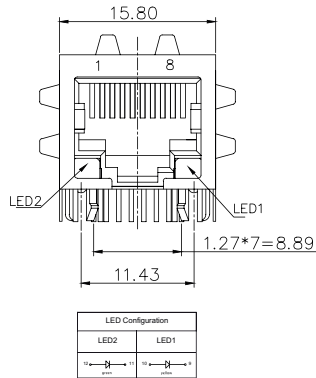

Ordering data

Type	Mounting onto the PCB	Latch option	Shield tabs	LED	Performance-Category	Packaging	Qty.	Order No.
RJ45C5 R1D 3.2E4G/Y RL	THT/THR solder connection	bottom	6 tabs	Yes	Cat. 5	Tape	200	2562870000



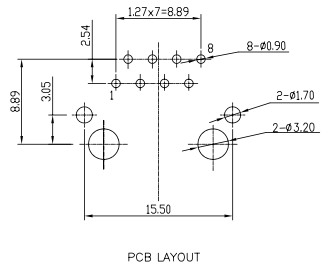
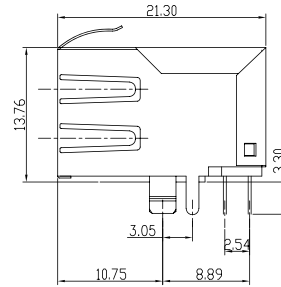
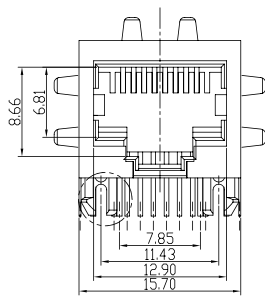

Ordering data

Type	Mounting onto the PCB	Latch option	Shield tabs	LED	Performance-Category	Packaging	Qty.	Order No.
RJ45C5 R1D 3.3E4N RL	THT/THR solder connection	bottom	6 tabs	No	Cat. 5	Tape	200	2562910000



**RJ45 modular jacks
for THR soldering process**

1x1 port, 90° (horizontal) latch up

For additional articles and information, refer to catalog.weidmuller.com



- 360° shielding
- Contact surface 30µ" (0.76µm) Au
- ≥750 plugging cycles
- Extended temperature range: -40 °C to +85 °C
- For fully automated assembly (tape-on-reel) or manual assembly (tray)
- Optimised package sizes
- Other variations on request

Technical data

Outgoing elbow	90°
Pitch	1.27 mm
Type of insulation material	PA 9T
Colour	black
UL 94 flammability rating	V-0
Moisture Level (MSL)	1
Shielding material	Brass
Shield surface	nickel-plated
Contact base material	Phosphorus bronze
Note	

Layer structure of plug contact	30...80 µ" Ni / ≥ 30 µ" Au
Operating temperature	-40...85 °C
Rated voltage	125 V
Rated current	1.5 A
Dielectric strength, contact / contact	1000 V DC
Insulation strength	≥ 500 MΩ
Plugging cycles	750
Approvals	CURUS

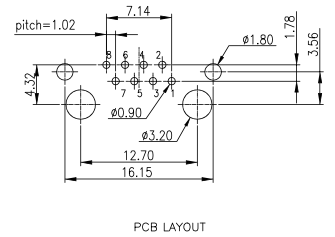
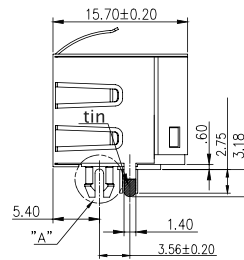
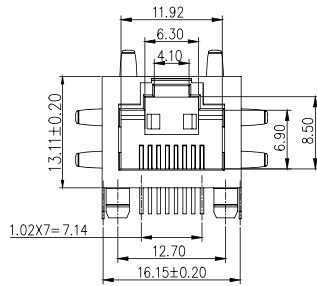

Ordering data

Type	Mounting onto the PCB	Latch option	Shield tabs	LED	Performance-Category	Packaging	Qty.	Order No.
RJ45C5 R1U 2.8E4N RL	THT/THR solder connection	bottom	6 tabs	No	Cat. 5	Tape	200	2562930000



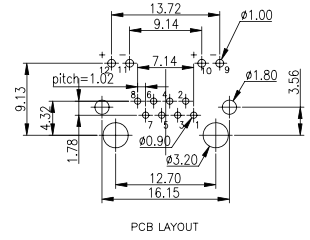
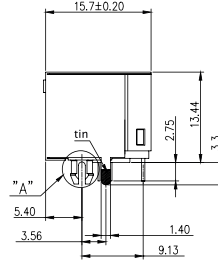
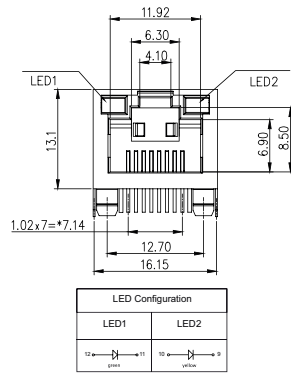

Ordering data

Type	Mounting onto the PCB	Latch option	Shield tabs	LED	Performance-Category	Packaging	Qty.	Order No.
RJ45C5 R1U 2.8N4G/Y RL	THT/THR solder connection	top	none	Yes	Cat. 5	Tape	200	2562950000



**RJ45 modular jacks
for wave soldering process**

1x1 port, 180° (vertical)



- 360° shielding
- Contact surface 30µ" (0.76µm) Au
- ≥750 plugging cycles
- Extended temperature range: -40 °C to +85 °C
- For manual assembly
- Optimised package sizes
- Other variations on request

For additional articles and information, refer to catalog.weidmueller.com



Technical data

Outgoing elbow	180°
Pitch	1.27 mm
Type of insulation material	PA 66
Colour	black
UL 94 flammability rating	V-0
Shielding material	Brass, nickel-plated
Shield surface	nickel-plated
Contact base material	

Layer structure of plug contact	30...80 µ" Ni / ≥ 30 µ" Au
Operating temperature	-40...85 °C
Rated voltage	125 V
Rated current	1.5 A
Dielectric strength, contact / contact	1000 V DC
Insulation strength	≥ 500 MΩ
Plugging cycles	750
Approvals	CURUS

Note

D

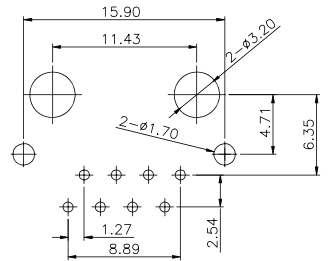
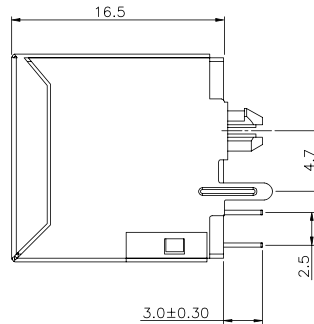
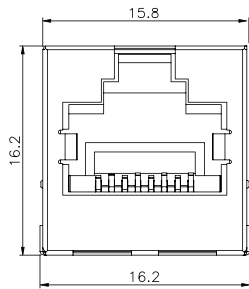
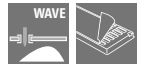

Ordering data

Type	Mounting onto the PCB	Latch option	Shield tabs	LED	Performance-Category	Packaging	Qty.	Order No.
RJ45C6 T1V 3.0N4N TY	THT solder connection		none	No	Cat. 6	Tray (manual assembly)	160	2626050000

Other versions on request



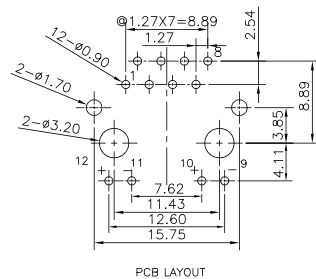
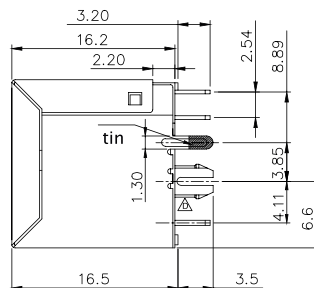
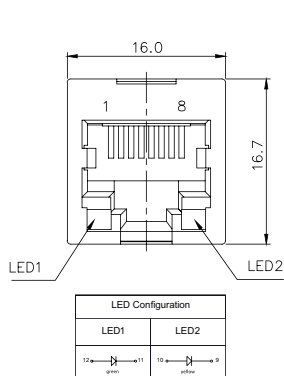
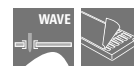

Ordering data

Type	Mounting onto the PCB	Latch option	Shield tabs	LED	Performance-Category	Packaging	Qty.	Order No.
RJ45C5 T1V 3.2N4G/Y TY	THT solder connection		none	Yes	Cat. 5	Tray (manual assembly)	120	2562960000

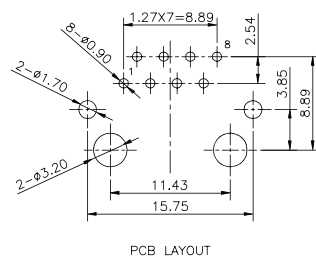
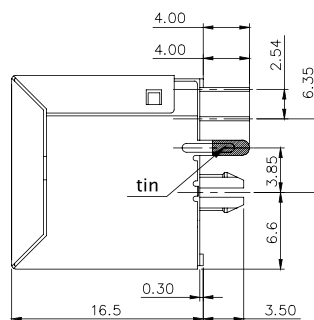
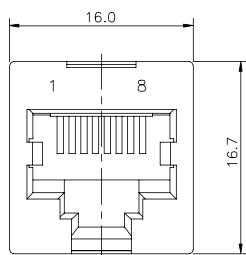

Ordering data

Type	Mounting onto the PCB	Latch option	Shield tabs	LED	Performance-Category	Packaging	Qty.	Order No.
RJ45C5 T1V 4.0N4N TY	THT solder connection		none	No	Cat. 5	Tray (manual assembly)	120	2436450000

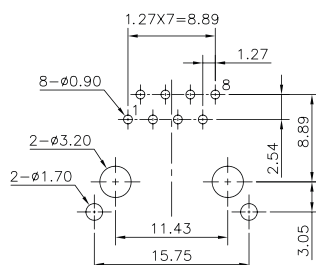
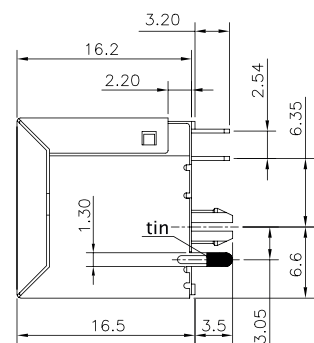
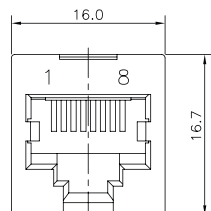
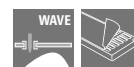

Ordering data

Type	Mounting onto the PCB	Latch option	Shield tabs	LED	Performance-Category	Packaging	Qty.	Order No.
RJ45C5 T1V 3.2N4N TY	THT solder connection		none	No	Cat. 5	Tray	120	1433810000

Other versions on request



RJ45 modular jacks for wave soldering process

1x1 port, 90° (horizontal) latch down



- 360° shielding
- Contact surface 30µ" (0.76µm) Au
- ≥750 plugging cycles
- Extended temperature range: -40 °C to +85 °C
- For manual assembly
- Optimised package sizes
- Other variations on request

For additional articles and information, refer to catalog.weidmueller.com



Technical data

Outgoing elbow	90°
Pitch	1.27 mm
Type of insulation material	PA 66
Colour	black
UL 94 flammability rating	V-0
Shielding material	Copper alloy
Shield surface	nickel-plated
Contact base material	Phosphorus bronze

Layer structure of plug contact	30...80 µ" Ni / ≥ 30 µ" Au
Operating temperature	-40...85 °C
Rated voltage	125 V
Rated current	1.5 A
Dielectric strength, contact / contact	1000 V DC
Insulation strength	≥ 500 MΩ
Plugging cycles	750
Approvals	CURUS

Note

D

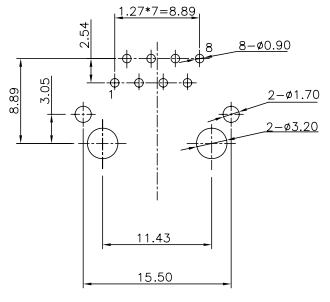
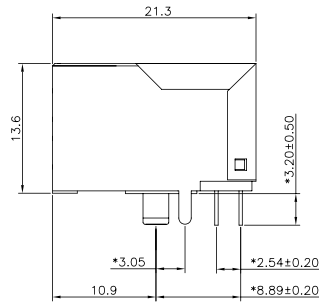
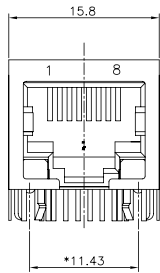
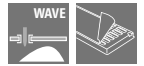

Ordering data

Type	Mounting onto the PCB	Latch option	Shield tabs	LED	Performance-Category	Packaging	Qty.	Order No.
RJ45C5 T1D 3.3N4N TY	THT solder connection	bottom	none	No	Cat. 5	Tray	120	1433800000
Other versions on request								



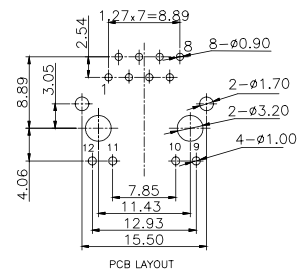
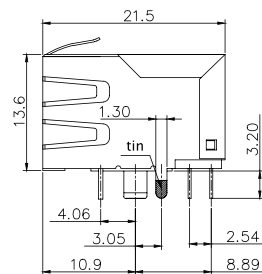
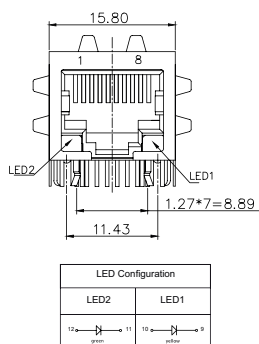
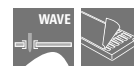

Ordering data

Type	Mounting onto the PCB	Latch option	Shield tabs	LED	Performance-Category	Packaging	Qty.	Order No.
RJ45C5 T1D 3.2E4G/Y TY	THT solder connection	bottom	6 tabs	Yes	Cat. 5	Tray (manual assembly)	140	2562820000

D

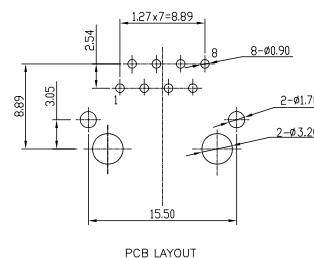
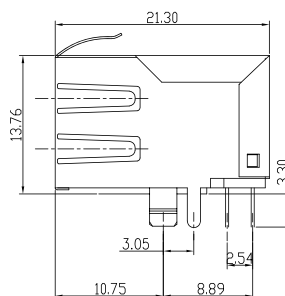
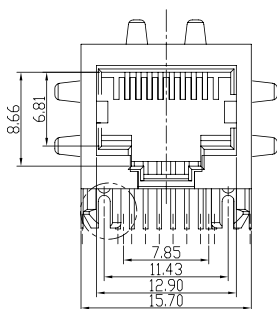

Ordering data

Type	Mounting onto the PCB	Latch option	Shield tabs	LED	Performance-Category	Packaging	Qty.	Order No.
RJ45C5 T1D 3.3E4N TY	THT solder connection	bottom	6 tabs	No	Cat. 5	Tray (manual assembly)	120	2562900000



**RJ45 modular jacks
for wave soldering process**

1x1 port, 90° (horizontal) latch up



- 360° shielding
- Contact surface 30µ" (0.76µm) Au
- ≥750 plugging cycles
- Extended temperature range: -40 °C to +85 °C
- For manual assembly
- Optimised package sizes
- Other variations on request

For additional articles and information, refer to catalog.weidmuller.com



Technical data

Outgoing elbow	90°
Pitch	1.27 mm
Type of insulation material	PA 66
Colour	black
UL 94 flammability rating	V-0
Shielding material	Copper alloy
Shield surface	nickel-plated
Contact base material	Phosphorus bronze

Layer structure of plug contact	30...80 µ" Ni / ≥ 30 µ" Au
Operating temperature	-40...85 °C
Rated voltage	125 V
Rated current	1.5 A
Dielectric strength, contact / contact	≥ 1000 V DC
Insulation strength	≥ 500 MΩ
Plugging cycles	750
Approvals	CURUS

Note

D

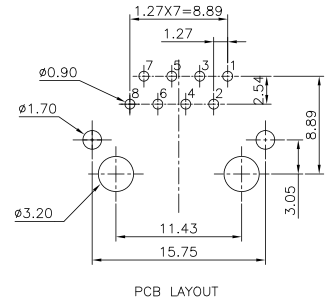
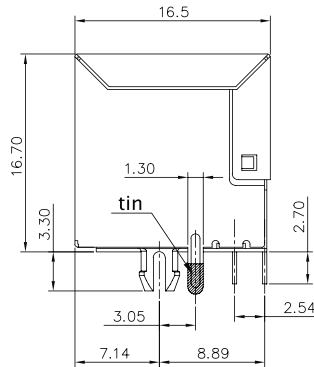
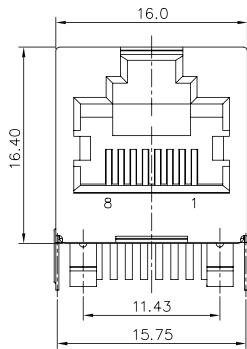
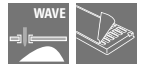

Ordering data

Type	Mounting onto the PCB	Latch option	Shield tabs	LED	Performance-Category	Packaging	Qty.	Order No.
RJ45C6 T1U 2.7N4N TY	THT solder connection	top	none	No	Cat. 6	Tray	160	1433910000
Other versions on request								



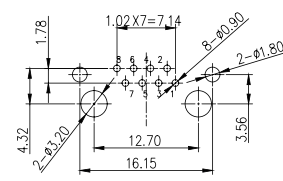
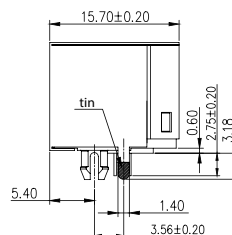
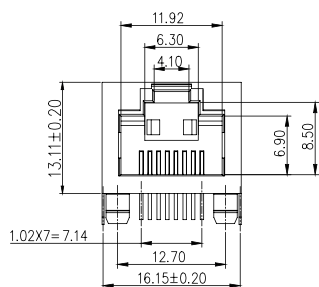

Recommended PCB-Layout

Ordering data

Type	Mounting onto the PCB	Latch option	Shield tabs	LED	Performance-Category	Packaging	Qty.	Order No.
RJ45C5 T1U 2.8N4N TY	THT solder connection	top	none	No	Cat. 5	Tray	140	1455240000

Other versions on request

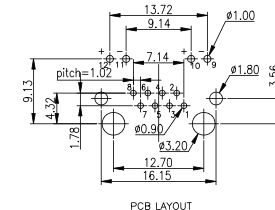
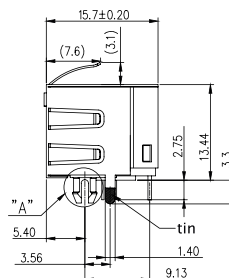
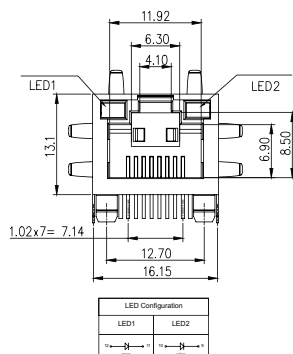
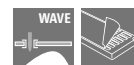

PCB LAYOUT

Ordering data

Type	Mounting onto the PCB	Latch option	Shield tabs	LED	Performance-Category	Packaging	Qty.	Order No.
RJ45C5 T1U 2.8E4G/Y TY	THT solder connection	top	6 tabs	Yes	Cat. 5	Tray (manual assembly)	140	2562880000

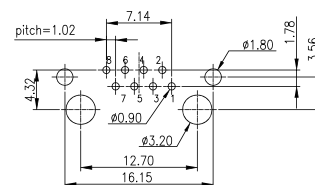
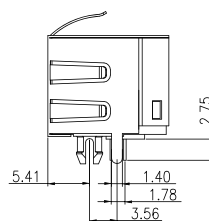
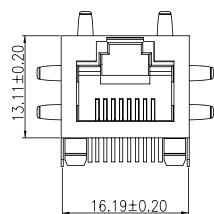
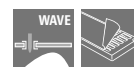

PCB LAYOUT

Ordering data

Type	Mounting onto the PCB	Latch option	Shield tabs	LED	Performance-Category	Packaging	Qty.	Order No.
RJ45C5 T1U 2.8E4N TY	THT solder connection	top	6 tabs	No	Cat. 5	Tray (manual assembly)	140	2562920000

<http://www.OMNIMATE.net>

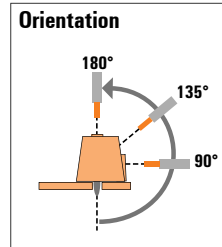

RJ45 transformer jacks

- With magnetics
- Shielded
- Contact surface 30µ" Au
- temperature range:
-40 °C to +85 °C



Mounting onto the PCB



SMT-soldering process



THR-soldering process



Wave soldering process

Reference picture	Outgoing elbow/ Latch option	Shield tabs	LED (left/ right)	Performance category
	90° horizontal/latch down	No	No	10/100 Mbit/s
	180° vertical	No	YG/YG	1000 MBit/s
		No	YG/YG	10/100 Mbit/s
		No	Y/G	10/100 Mbit/s
	90° liegend/latch down	Yes	No	1000 MBit/s
		Yes	G/Y	1000 MBit/s
		Yes	No	10/100 Mbit/s
		Yes	G/Y	10/100 Mbit/s
		No	Y/G	10/100 Mbit/s
	90° horizontal/latch down Multiport	Yes	YG/YG	1000 MBit/s
		Yes	G/Y	1000 MBit/s
		No	YG/YG	1000 MBit/s
		No	G/Y	10/100 Mbit/s
	90° horizontal/latch down Multiport	Yes	No	10/100 Mbit/s
		Yes	G/Y	10/100 Mbit/s
	90° horizontal/latch down Multiport	Yes	G/Y	10/100 Mbit/s

Packaging	Order No.	Type
Tape	2564450000	RJ45M S1D DE4N RL
Tape	2562160000	RJ45G R1V 1.9N4YG/YG RL
Tape	2562150000	RJ45M R1V 1.9N4YG/YG RL
Tray	2461070000	RJ45M R1V 3.3N4Y/G TY
Tape	2564440000	RJ45G1 R1D 3.2E4N RL
Tray	2544510000	RJ45G1 R1D 3.3E4G/Y TY
Tape	2564430000	RJ45M R1D 3.2E4N RL
Tape	2564410000	RJ45M R1D 3.3E4G/Y RL
Tray	2461060000	RJ45M R1D 3.3N4Y/G TY
Tape	2036510000	RJ45G1 R12D 3.3E4YG/YG RL
Tray	2544500000	RJ45G1 R12D 3.3E4G/Y TY
Tape	2485370000	RJ45G1 R12D 3.3N4YG/YG RL
Tape	2551900000	RJ45M R12D 3.2N4G/Y RL
Tray	2474160000	RJ45M T1D 3.2E4N TY
Tray	2563850000	RJ45M T1D 3.3E4G/Y TY
Tape	2036460000	RJ45M T12D 3.3E4G/Y RL

RJ45	G1	R	1	U	3.2	E	4	GY/GY	TY
Performance Category									
C5 Category 5									
C6 Category 6									
C6A Category 6A									
C5e Category 5e									
M 10/100 Mbit									
G1 10/100/1000 Mbit									
G10 10 Gbit									
U Unshielded									
MP 10/100 Mbit with POE									
MP+ 10/100 Mbit with POE+									
Assembly on PCB									
R Through Hole Reflow - THR Soldering process: Wave or Reflow soldering									
S Surface Mount Technology - SMT Soldering process: Reflow soldering									
T Through Hole Technology - THT Soldering process: Wave									
Number of Ports									
1 1 Port									
12; 14; ... multi ports side by side, Multiport									
21; 41; ... multi ports about each other, Multilevel									
Direction, latch style									
U Horizontal (90°, side entry), latch up									
D Horizontal (90°, side entry), latch down									
V Vertical (180°, top entry)									
Y Diagonal (45°), latch up									
Solder Pin length									
3.2 3.2 mm									
1.6 1.6 mm									
D SMD									
EMI tabs (ground fingers)									
E E = with EMI tabs									
N N = without EMI tabs									
Contact surface thickness									
4 1 = 3µ", 2 = 6µ", 3 = 15µ", 4 = 30µ", 5 = 50µ"									
LED									
Y/G Yellow/Green									
G/Y Green/Yellow (standard)									
GY/GY Green-Yellow/Green-Yellow									
O/G Orange/Green									
R/O Red/Orange									
... (further combinations possible)									
N without LED									
Packaging									
TY Tray in box (manual assembly)									
RL Tape on Reel (automated assembly)									

RJ45 transformer jacks for SMT soldering process

1x1 port, 90° (horizontal) latch down



- With integrated magnetics
- 360° shielding
- Contact surface 30µm (0.76µm) Au
- ≥750 plugging cycles
- Extended temperature range: -40 °C to +85 °C
- For fully automatic assembly (tape-on-reel)
- Optimised package sizes
- Other variations on request

For additional articles and information, refer to catalog.weidmuller.com



Characteristics

Inductance	350 µH min. at 100 kHz, 100 mV, 8 mA DC Bias
Leakage Inductance	0.3 µH max. at 100 kHz, 100 mV
Insertion Loss	1.1 dB max. at (1 - 100) MHz
Return Loss	18 dB min. at (1 - 30) MHz 16 dB min. at (30 - 60) MHz 12 dB min. at (60 - 80) MHz
Cross Talk	30 dB min. at (1 - 100) MHz
Common Mode Rejection	30 dB min. at (1 - 100) MHz

Technical data

Outgoing elbow	90°
Pitch	1.27 mm
Type of insulation material	PA 9T
Colour	black
UL 94 flammability rating	V-0
Moisture Level (MSL)	1
Shielding material	Brass
Shield surface	nickel-plated
Contact base material	Phosphorus bronze
Note	

Layer structure of plug contact	30...80 µm Ni / ≥ 30 µm Au
Operating temperature	-40...85 °C
Rated voltage	125 V
Rated current	1.5 A
Dielectric strength, contact / contact	1000 V DC
Insulation strength	
Plugging cycles	750
Approvals	CURUS

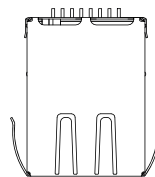
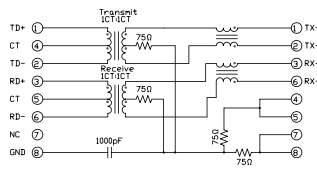
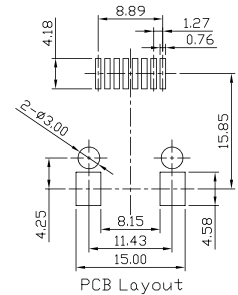
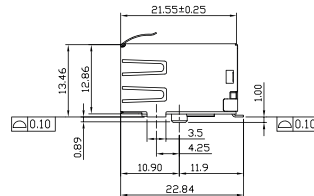
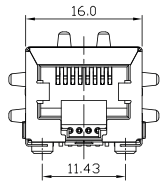

Ordering data

Type	Mounting onto the PCB	Latch option	Shield tabs	LED	Performance-Category	Packaging	Qty.	Order No.
RJ45M S1D DE4N RL	SMD solder connection	bottom	6 tabs	No	10/100 MBit/s	Tape	220	2564450000



**RJ45 transformer jacks
for THR soldering process**

1x1 port, 180° (vertical)



- With integrated magnetics
- 360° shielding
- Contact surface 30µm (0.76µm) Au
- ≥750 plugging cycles
- Extended temperature range: -40 °C to +85 °C
- For fully automated assembly (tape-on-reel) or manual assembly (tray)
- Optimised package sizes
- Other variations on request

For additional articles and information, refer to catalog.weidmueller.com



Characteristics

Inductance	350 µH min. at 100 kHz, 100 mV, 8 mA DC Bias
Leakage Inductance	0.3 µH max. at 100 kHz, 100 mV
Insertion Loss	1.1 dB max. at (1 - 100) MHz
Return Loss	18 dB min. at (1 - 30) MHz 16 dB min. at (30 - 60) MHz 12 dB min. at (60 - 80) MHz
Cross Talk	30 dB min. at (1 - 100) MHz
Common Mode Rejection	30 dB min. at (1 - 100) MHz

Technical data

Outgoing elbow	180°
Pitch	1.27 mm
Type of insulation material	PA 9T
Colour	black
UL 94 flammability rating	V-0
Moisture Level (MSL)	1
Shielding material	Brass
Shield surface	nickel-plated
Contact base material	Phosphorus bronze
Note	

Layer structure of plug contact	30...80 µm Ni / ≥ 30 µm Au
Operating temperature	-40...85 °C
Rated voltage	125 V
Rated current	1.5 A
Dielectric strength, contact / contact	1000 V DC
Insulation strength	
Plugging cycles	750
Approvals	CURUS

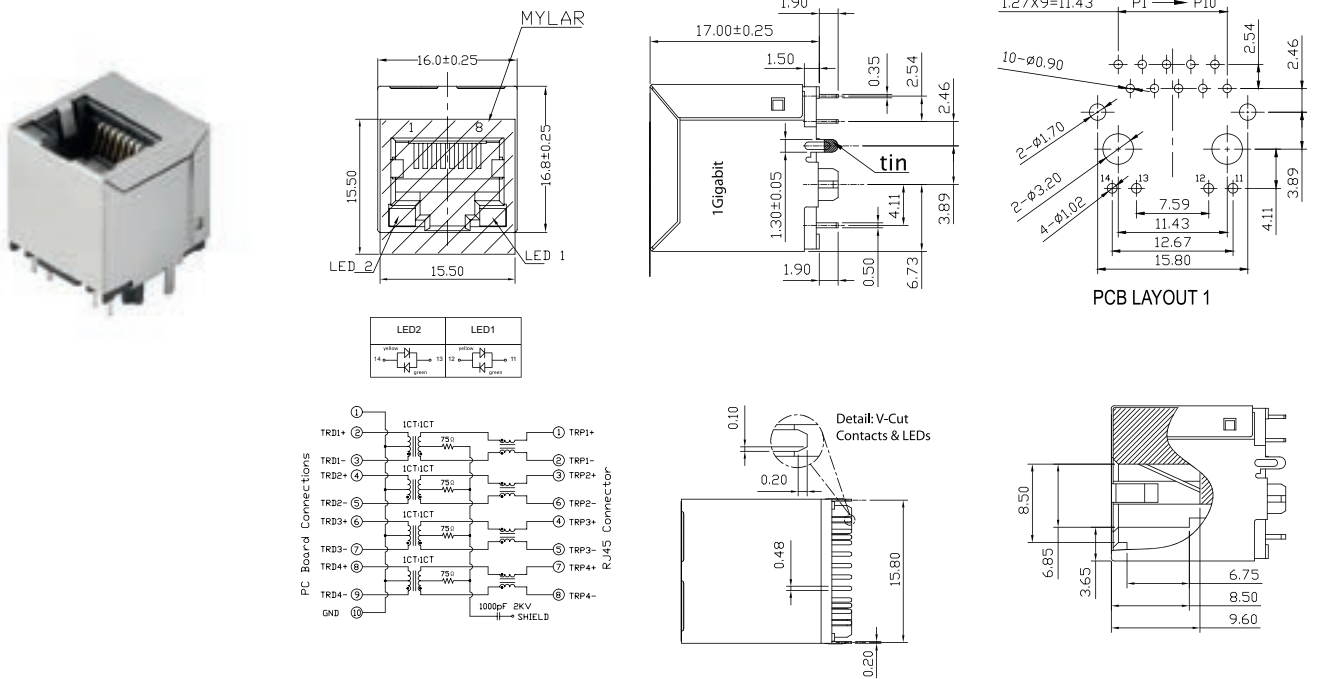

Ordering data

Type	Mounting onto the PCB	Latch option	Shield tabs	LED	Performance-Category	Packaging	Qty.	Order No.
RJ45G R1V 1.9N4YG/YG RL	THT/THR solder connection		none	Yes	1000 Mbps	Tape	200	2562160000



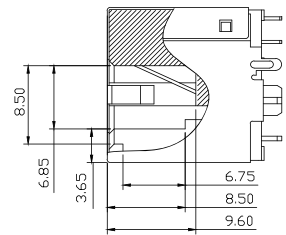
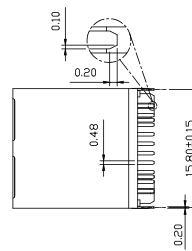
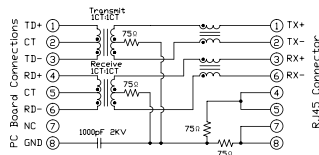
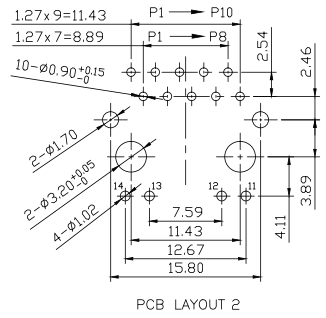
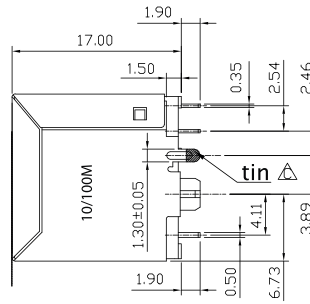
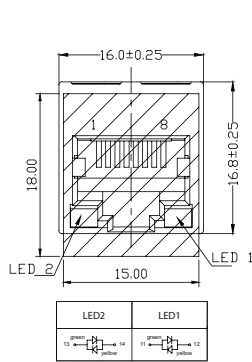

Ordering data

Type	Mounting onto the PCB	Latch option	Shield tabs	LED	Performance-Category	Packaging	Qty.	Order No.
RJ45M R1V 1.9N4YG/YG RL	THT/THR solder connection		none	Yes	10/100 MBit/s	Tape	200	2562150000

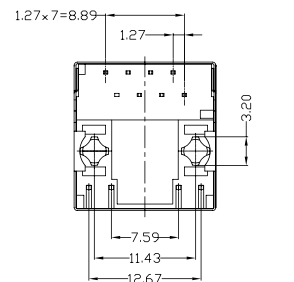
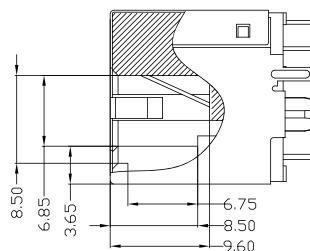
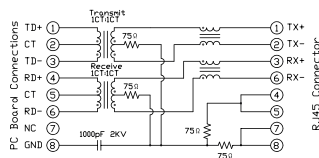
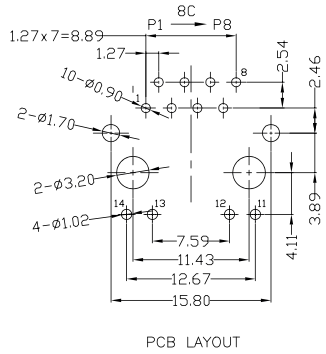
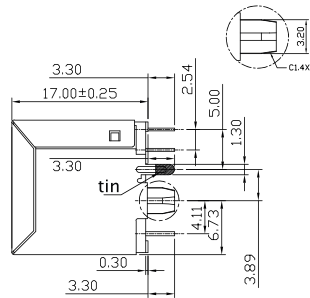
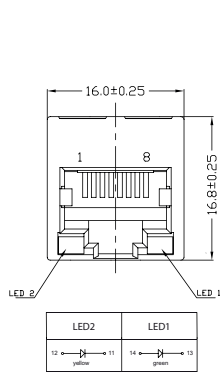

Ordering data

Type	Mounting onto the PCB	Latch option	Shield tabs	LED	Performance-Category	Packaging	Qty.	Order No.
RJ45M R1V 3.3N4Y/G TY	THT/THR solder connection		none	Yes	10/100 MBit/s	Tray (manual assembly)	120	2461070000

**RJ45 transformer jacks
for THR soldering process**

1x1 port, 90° (horizontal) latch down



- With integrated magnetics
- 360° shielding
- Contact surface 30µm (0.76µm) Au
- ≥750 plugging cycles
- Extended temperature range: -40 °C to +85 °C
- For fully automated assembly (tape-on-reel) or manual assembly (tray)
- Optimised package sizes
- Other variations on request

For additional articles and information, refer to catalog.weidmueller.com



Characteristics

Inductance	350 µH min. at 100 kHz, 100 mV, 8 mA DC Bias
Leakage Inductance	0.3 µH max. at 100 kHz, 100 mV
Insertion Loss	1.1 dB max. at (1 - 100) MHz
Return Loss	18 dB min. at (1 - 30) MHz 16 dB min. at (30 - 60) MHz 12 dB min. at (60 - 80) MHz
Cross Talk	30 dB min. at (1 - 100) MHz
Common Mode Rejection	30 dB min. at (1 - 100) MHz

Technical data

Outgoing elbow	90°
Pitch	1.27 mm
Type of insulation material	PA 9T
Colour	black
UL 94 flammability rating	V-0
Shielding material	Brass
Shield surface	nickel-plated
Contact base material	Phosphorus bronze

Layer structure of plug contact	30...80 µm Ni / ≥ 30 µm Au
Operating temperature	-40...85 °C
Rated voltage	125 V
Rated current	1.5 A
Dielectric strength, contact / contact	1000 V DC
Insulation strength	
Plugging cycles	750
Approvals	CURUS

Note

D

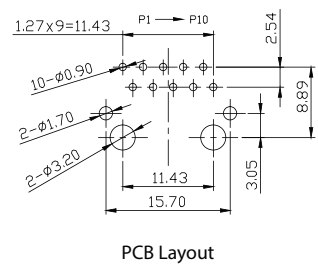
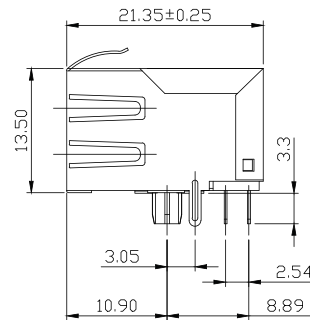
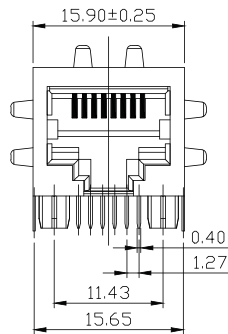

PCB Layout

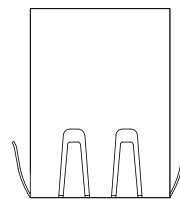
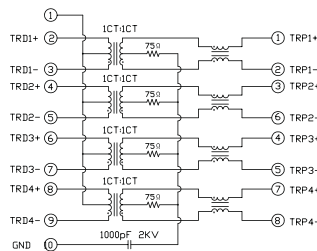

Ordering data

Type	Mounting onto the PCB	Latch option	Shield tabs	LED	Performance-Category	Packaging	Qty.	Order No.
RJ45G1 R1D 3.2E4N RL	THT/THR solder connection	bottom	6 tabs	No	1000 Mbps	Tape	200	2564440000

90°

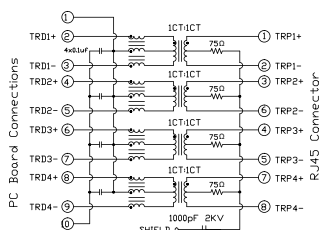
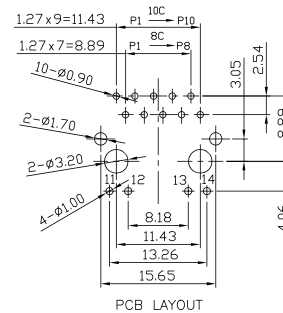
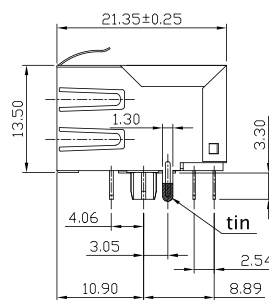
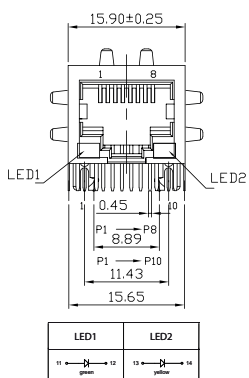

Ordering data

Type	Mounting onto the PCB	Latch option	Shield tabs	LED	Performance-Category	Packaging	Qty.	Order No.
RJ45G1 R1D 3.3E4G/Y TY	THT/THR solder connection	bottom	6 tabs	Yes	1000 Mbps	Tray (manual assembly)	120	2544510000

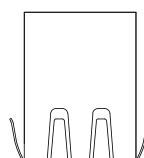
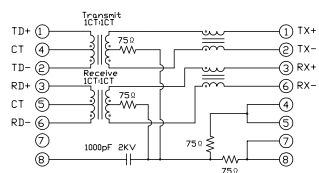
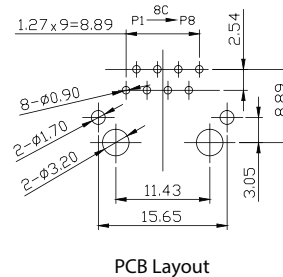
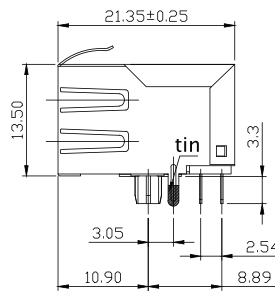
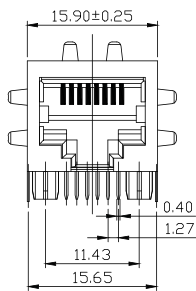

Ordering data

Type	Mounting onto the PCB	Latch option	Shield tabs	LED	Performance-Category	Packaging	Qty.	Order No.
RJ45M R1D 3.2E4N RL	THT/THR solder connection	bottom	6 tabs	No	10/100 MBit/s	Tape	200	2564430000



RJ45 transformer jacks
for THR soldering process

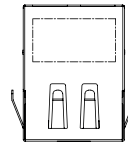
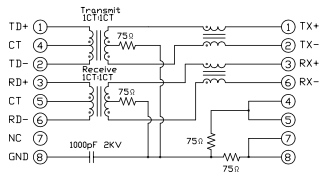
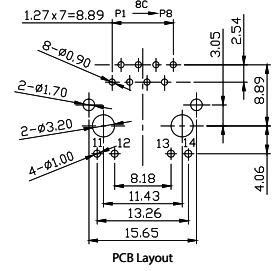
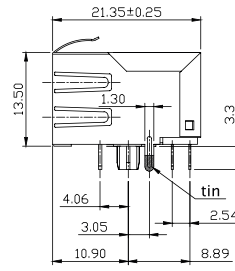
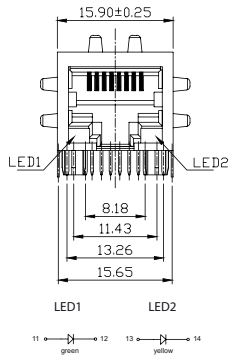

Ordering data

Type	Mounting onto the PCB	Latch option	Shield tabs	LED	Performance-Category	Packaging	Qty.	Order No.
RJ45M R1D 3.3E4G/Y RL	THT/THR solder connection	bottom	6 tabs	Yes	10/100 MBit/s	Tape	200	2564410000

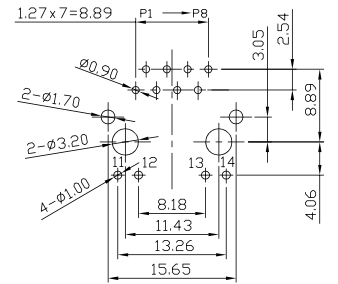
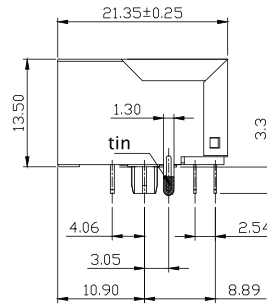
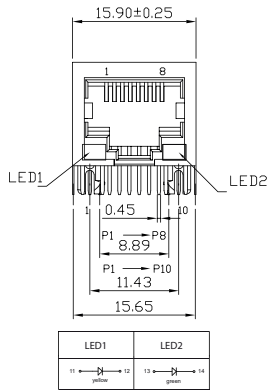
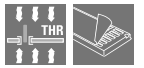

PCB Layout

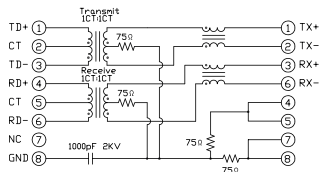

Ordering data

Type	Mounting onto the PCB	Latch option	Shield tabs	LED	Performance-Category	Packaging	Qty.	Order No.
RJ45M R1D 3.3N4Y/G TY	THT/THR solder connection	bottom	none	Yes	10/100 MBit/s	Tray (manual assembly)	120	2461060000

**RJ45 transformer jacks
for THR soldering process**

1x2 multiport, 90° (horizontal) latch down



- With integrated magnetics
- 360° shielding
- Contact surface 30µm (0.76µm) Au
- ≥750 plugging cycles
- Extended temperature range: -40 °C to +85 °C
- For fully automated assembly (tape-on-reel) or manual assembly (tray)
- Optimised package sizes
- Other variations on request

For additional articles and information, refer to catalog.weidmuller.com



Characteristics

Inductance	350 µH min. at 100 kHz, 100 mV, 8 mA DC Bias
Leakage Inductance	0.3 µH max. at 100 kHz, 100 mV
Insertion Loss	1.1 dB max. at (1 - 100) MHz
Return Loss	18 dB min. at (1 - 30) MHz 16 dB min. at (30 - 60) MHz 12 dB min. at (60 - 80) MHz
Cross Talk	30 dB min. at (1 - 100) MHz
Common Mode Rejection	30 dB min. at (1 - 100) MHz

Technical data

Outgoing elbow	90°
Pitch	1.27 mm
Type of insulation material	PA 9T
Colour	black
UL 94 flammability rating	V-0
Moisture Level (MSL)	1
Shielding material	Brass
Shield surface	nickel-plated
Contact base material	Phosphorus bronze
Note	

Layer structure of plug contact	30...80 µm Ni / ≥ 30 µm Au
Operating temperature	-40...85 °C
Rated voltage	125 V
Rated current	1.5 A
Dielectric strength, contact / contact	1000 V DC
Insulation strength	
Plugging cycles	750
Approvals	CURUS

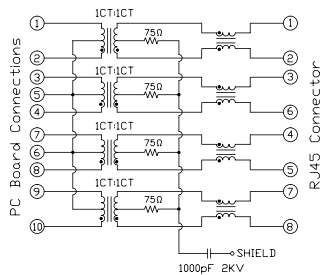
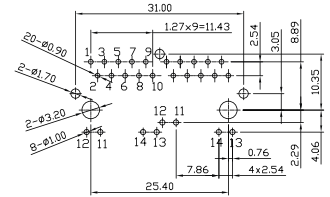
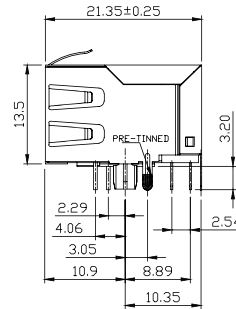
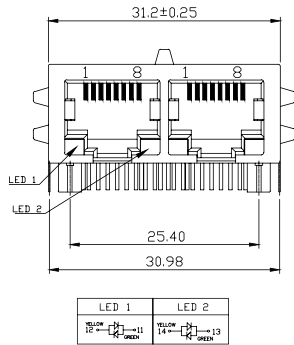

Ordering data

Type	Mounting onto the PCB	Latch option	Shield tabs	LED	Performance-Category	Packaging	Qty.	Order No.
RJ45G1 R12D 3.2E4YG/YG RL	THT/THR solder connection	bottom	6 tabs	Yes	1000 Mbps	Tape	180	2036510000



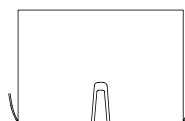
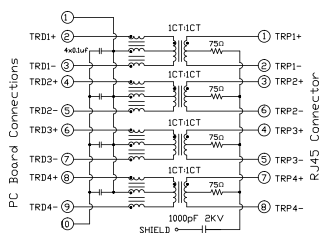
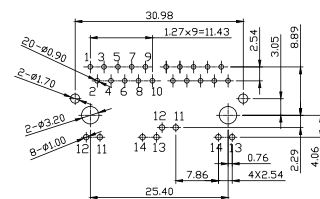
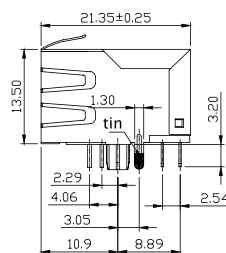
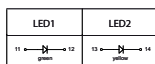
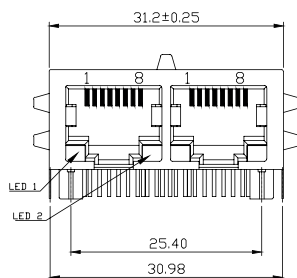

Ordering data

Type	Mounting onto the PCB	Latch option	Shield tabs	LED	Performance-Category	Packaging	Qty.	Order No.
RJ45G1 R12D 3.3E4G/Y TY	THT/THR solder connection	bottom	6 tabs	Yes	1000 Mbps	Tray (manual assembly)	80	2544500000

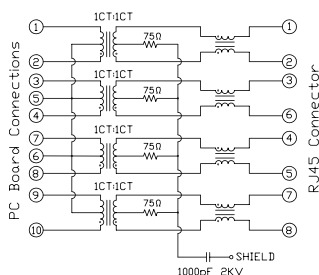
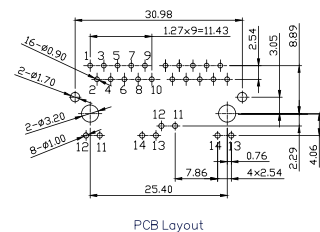
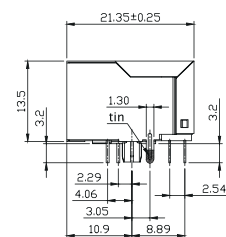
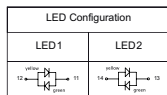
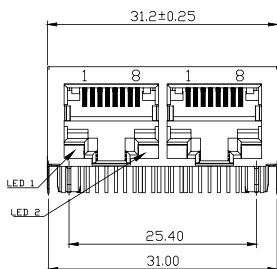

Ordering data

Type	Mounting onto the PCB	Latch option	Shield tabs	LED	Performance-Category	Packaging	Qty.	Order No.
RJ45G1 R12D 3.2N4YG/YG RL	THT/THR solder connection	bottom	none	Yes	1000 Mbps	Tape	200	2485370000



**RJ45 transformer jacks
for THR soldering process**

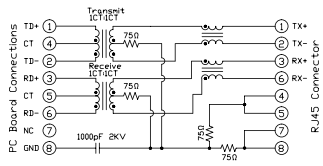
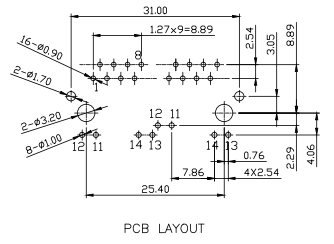
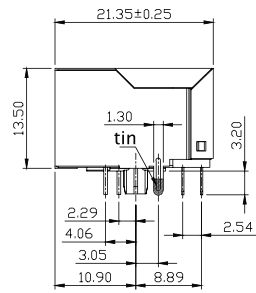
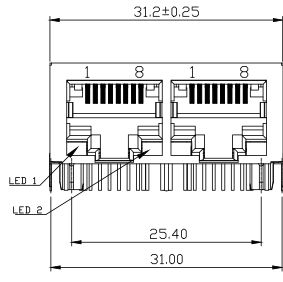

Ordering data

Type	Mounting onto the PCB	Latch option	Shield tabs	LED	Performance-Category	Packaging	Qty.	Order No.
RJ45M R12D 3.2N4G/Y RL	THT/THR solder connection	bottom	none	Yes	10/100 MBit/s	Tape	200	2551900000



**RJ45 transformer jacks
for wave soldering process**

1x1 port, 90° (horizontal) latch down



- With integrated magnetics
- 360° shielding
- Contact surface 30µm (0.76µm) Au
- ≥750 plugging cycles
- Extended temperature range: -40 °C to +85 °C
- For or manual assembly (tray)
- Optimised package sizes
- Other variations on request

For additional articles and information, refer to catalog.weidmueller.com



Characteristics

Inductance	350 µH min. at 100 kHz, 100 mV, 8 mA DC Bias
Leakage Inductance	0.3 µH max. at 100 kHz, 100 mV
Insertion Loss	1.1 dB max. at (1 - 100) MHz
Return Loss	18 dB min. at (1 - 30) MHz 16 dB min. at (30 - 60) MHz 12 dB min. at (60 - 80) MHz
Cross Talk	30 dB min. at (1 - 100) MHz
Common Mode Rejection	30 dB min. at (1 - 100) MHz

Technical data

Outgoing elbow	90°
Pitch	1.27 mm
Type of insulation material	PA 66
Colour	black
UL 94 flammability rating	V-0
Shielding material	Brass
Shield surface	nickel-plated
Contact base material	Phosphorus bronze

Layer structure of plug contact	30...80 µm Ni / ≥ 30 µm Au
Operating temperature	-40...85 °C
Rated voltage	125 V
Rated current	1.5 A
Dielectric strength, contact / contact	1000 V DC
Insulation strength	
Plugging cycles	750
Approvals	CURUS

Note

D

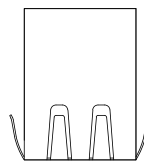
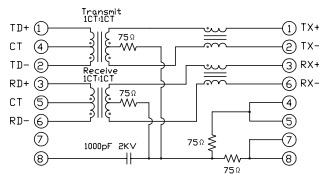
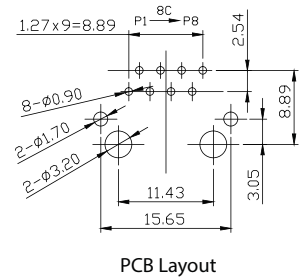
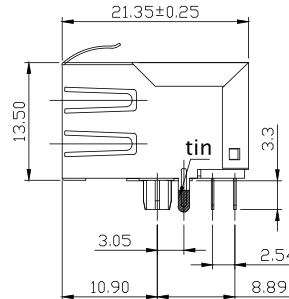
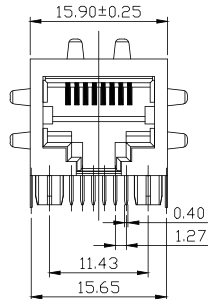
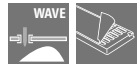

Ordering data

Type	Mounting onto the PCB	Latch option	Shield tabs	LED	Performance-Category	Packaging	Qty.	Order No.
RJ45M T1D 3.2E4N TY	THT solder connection	bottom	6 tabs	No	10/100 MBit/s	Tray (manual assembly)	120	2474160000

90°

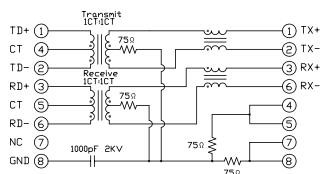
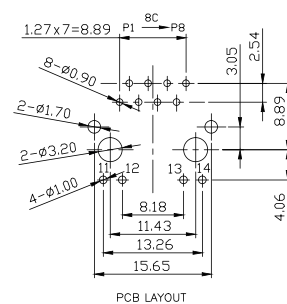
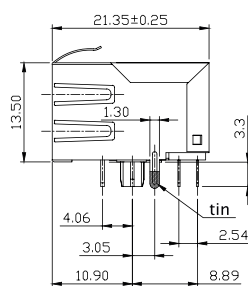
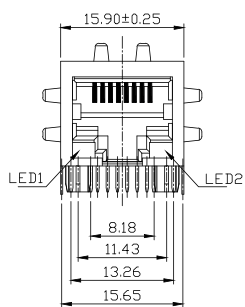
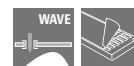

Ordering data

Type	Mounting onto the PCB	Latch option	Shield tabs	LED	Performance-Category	Packaging	Qty.	Order No.
RJ45M T1D 3.3E4G/Y TY	THT solder connection	bottom	6 tabs	Yes	10/100 MBit/s	Tray (manual assembly)	120	2563850000



**RJ45 transformer jacks
for wave soldering process**

1x2 multiport, 90° (horizontal) latch down



- With integrated magnetics
- 360° shielding
- Contact surface 30µm (0.76µm) Au
- ≥750 plugging cycles
- Extended temperature range: -40 °C to +85 °C
- For fully automatic assembly (tape-on-reel)
- Optimised package sizes
- Other variations on request

For additional articles and information, refer to catalog.weidmueller.com



Characteristics

Inductance	350 µH min. at 100 kHz, 100 mV, 8 mA DC Bias
Leakage Inductance	0.3 µH max. at 100 kHz, 100 mV
Insertion Loss	1.1 dB max. at (1 - 100) MHz
Return Loss	18 dB min. at (1 - 30) MHz 16 dB min. at (30 - 60) MHz 12 dB min. at (60 - 80) MHz
Cross Talk	30 dB min. at (1 - 100) MHz
Common Mode Rejection	30 dB min. at (1 - 100) MHz

Technical data

Outgoing elbow	90°
Pitch	1.27 mm
Type of insulation material	PA 66
Colour	black
UL 94 flammability rating	V0
Shielding material	Brass
Shield surface	nickel-plated
Contact base material	Phosphorus bronze

Layer structure of plug contact	30...80 µm Ni / ≥ 30 µm Au
Operating temperature	-40...85 °C
Rated voltage	125 V
Rated current	1.5 A
Dielectric strength, contact / contact	1000 V DC
Insulation strength	
Plugging cycles	750
Approvals	CURUS

Note

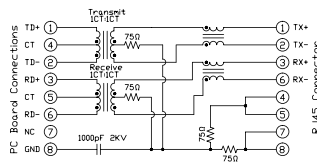
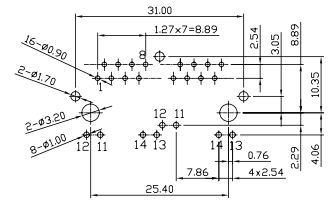
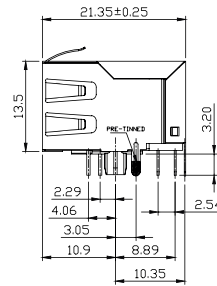
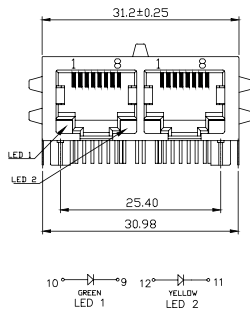

Ordering data

Type	Mounting onto the PCB	Latch option	Shield tabs	LED	Performance-Category	Packaging	Qty.	Order No.
RJ45M T12D 3.3E4G/Y RL	THT solder connection	bottom	6 tabs	Yes	10/100 MBit/s	Tape	180	2036460000



OMNIMATE® Data – USB

OMNIMATE® Data – USB	Explanation	E.2
	Quick selection	E.4
	USB jacks for SMT soldering process	E.6
	USB jacks for THR soldering process	E.8
	USB jacks for wave soldering process	E.10

OMNIMATE® Data USB jacks

Reliable data interfaces for your device

Plug-in connectors and jacks for data transmission are already an integral part of the future-proof device design. In the industrial environment, they have to stand up to exacting requirements and the ever-increasing data transmission rates demand high-quality on individual components.

For this, our USB data jacks ensure a high data transmission rate, a robust plug and play operation with reliable PCB assembly possibilities.

E

Reinforced gold surface
up to 1.500 mating cycles meet the requirements for high durability



Reliable PCB assembly with any technology
SMT, THR or THT soldering method; Tape on Reel or assembly by hand (Tray)



Variable outlet directions

The 90°/180° variants allow optimum adaptation to the various housing formats



USB 3.0 jacks support a data rate up to 5 Gbit/s

For fast data transmission. USB 3.0 Hosts and devices are generally backwards compatible with version 2.0 - makes flexible use possible



Robust plug & play operation

connect and disconnect without powering down or restarting the system

<http://www.OMNIMATE.net>

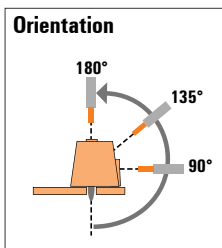

USB 3.0/2.0 jacks

Rated current up to 1,5 A

- Up to 1500 mating cycles
- Backwards compatible



Mounting onto the PCB



SMT-soldering process



THR-soldering process



Wave soldering process

Reference picture	Outgoing elbow	Performance category	Packaging	Order No.	Type
	180° vertical	480 Mbit/s	Reel	2762070000	USB-MIC2.0B S1V 1N1 RL BK
	180° vertical	480 Mbit/s	Tray	2878140000	USB2.0A S1V 0.8N4 RL BK
	90° horizontal	480 Mbit/s	Tray	2563720000	USB2.0A S1H 1.4N4 TY BK
	180° vertical	480 Mbit/s	Tray	2563730000	USB2.0A R1V 2.5N4 TY BK
	180° vertical	5 Gbit/s	Tray	1549730000	USB3.0A R1V 3.0N2 TY BL
	90° horizontal	480 Mbit/s	Tray	2878150000	USB2.0A R1H 2.5N4 RL BK
	180° vertical	480 Mbit/s	Tray	1985910000	USB2.0A T1V 2.5N4 TY BK
	90° horizontal	480 Mbit/s	Tray	2563710000	USB2.0A T1H 2.5N4 TY BK
	90° horizontal	5 Gbit/s	Tray	2563550000	USB3.0A T1H 2.3N4 TY BL

USB	3.0A	R	1	V	3.0	N	4	TY	BK
Type / Performance									
2.0A USB 2.0 Type A									
3.0A USB 3.0 Type A									
Assembly on PCB									
R Through Hole Reflow - THR Soldering process: Wave or Reflow soldering									
S Surface Mount Technology - SMT Soldering process: Reflow soldering									
T Through Hole Technology - THT Soldering process: Wave									
Number of Ports									
1 1 Port									
21; 41; ... multi ports about each other, Multilevel									
Direction									
H Horizontal (90°, side entry)									
U Horizontal, Upright 90°									
V Vertical (180°, top entry)									
Solder Pin length									
3.2 3.2 mm									
1.6 1.6 mm									
D SMD									
N no use									
Contact surface thickness									
4 1 = 3µ", 2 = 6µ", 3 = 15µ", 4 = 30µ", 5 = 50µ"									
Packaging									
TY Tray in box (manual assembly)									
RL Tape on Reel (automated assembly)									
TU Tube									
Special Option / Colour									
BL blue (plastic)									
BK black (plastic)									
WH white (plastic)									
SD customized product									

**USB jacks
for SMT soldering process**

Type 2.0 A, 90° (horizontal)



- Rated current up to 1.5 A
- ≥ 1500 plugging cycles
- Downward compatible

For additional articles and information, refer to catalog.weidmueller.com



Technical data

Outgoing elbow	90°
Pitch	2.00 mm
Type of insulation material	LCP
Colour	black
UL 94 flammability rating	V-0
Moisture Level (MSL)	1
Shielding material	Brass
Shield surface	nickel-plated

Contact base material	Phosphorus bronze
Layer structure of plug contact	30...80 µm Ni / ≥ 30 µm Au
Operating temperature	-40...85 °C
Rated voltage	30 V
Rated current	1.5 A
Dielectric strength, contact / contact	750 V AC
Insulation strength	≥ 500 MΩ

Note

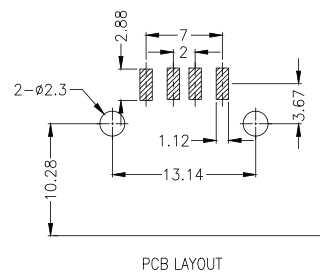
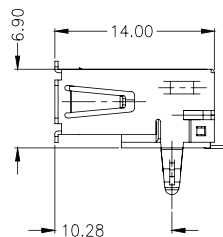
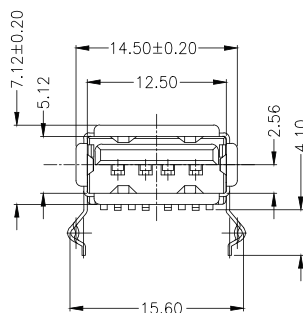

Ordering data

Type	Mounting onto the PCB	Plugging cycles	Performance-Category	Packaging	Qty.	Order No.
USB2.0A S1H 1.4N4 TY BK	THT/THR solder connection	≥ 1500	480 Mbps	Tray (manual assembly)	100	2563720000

**USB jacks
for THR soldering process**

Type 3.0/2.0 A, 180° (vertical)



- Rated current up to 1.5 A
- ≥ 1500 plugging cycles
- Downward compatible

For additional articles and information, refer to catalog.weidmueller.com



Technical data

Outgoing elbow	180°
Pitch	2.00 mm
Type of insulation material	LCP
Colour	black
UL 94 flammability rating	V-0
Moisture Level (MSL)	1
Shielding material	Brass
Shield surface	nickel-plated

Contact base material	Phosphorus bronze
Layer structure of plug contact	30...80 µm Ni / ≥ 30 µm Au
Operating temperature	-40...85 °C
Rated voltage	30 V
Rated current	1.5 A at 250 V AC
Dielectric strength, contact / contact	500 V AC
Insulation strength	≥ 500 MΩ

Note

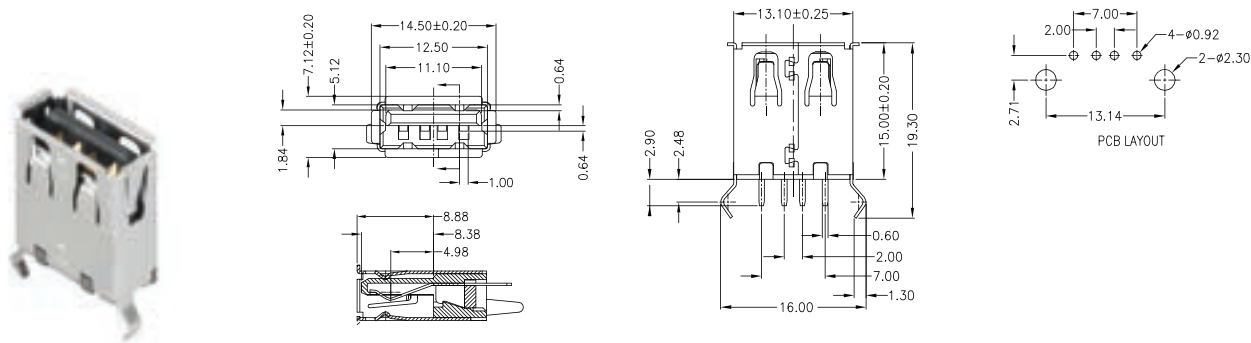

Ordering data

Type	Mounting onto the PCB	Plugging cycles	Performance-Category	Packaging	Qty.	Order No.
USB2.0A R1V 2.5N4 TY BK	THT/THR solder connection	≥ 1500	480 Mbps	Tray (manual assembly)	100	2563730000



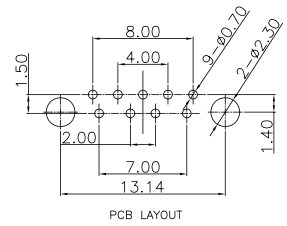
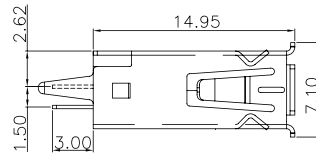
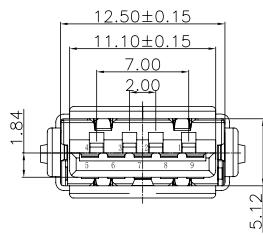
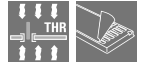

Ordering data

Type	Mounting onto the PCB	Plugging cycles	Performance-Category	Packaging	Qty.	Order No.
USB3.0A R1V 3.0N2 TY BL	THT/THR solder connection	≥ 1500	5 Gbps	Tray (manual assembly)	100	1549730000

USB jacks
for wave soldering process

Type 3.0/2.0 A, 180° (vertical)



- Rated current up to 1.5 A
- ≥ 1500 plugging cycles
- Downward compatible

For additional articles and information, refer to catalog.weidmueller.com



Technical data

Outgoing elbow	180°
Pitch	2.00 mm
Type of insulation material	PBT
Colour	black
UL 94 flammability rating	V-0
Shielding material	Brass
Shield surface	nickel-plated

Contact base material	Phosphorus bronze
Layer structure of plug contact	30...80 µm Ni / ≥ 30 µm Au
Operating temperature	-40...60 °C
Rated voltage	30 V
Rated current	1.5 A
Dielectric strength, contact / contact	500 V AC
Insulation strength	≥ 500 MΩ

Note

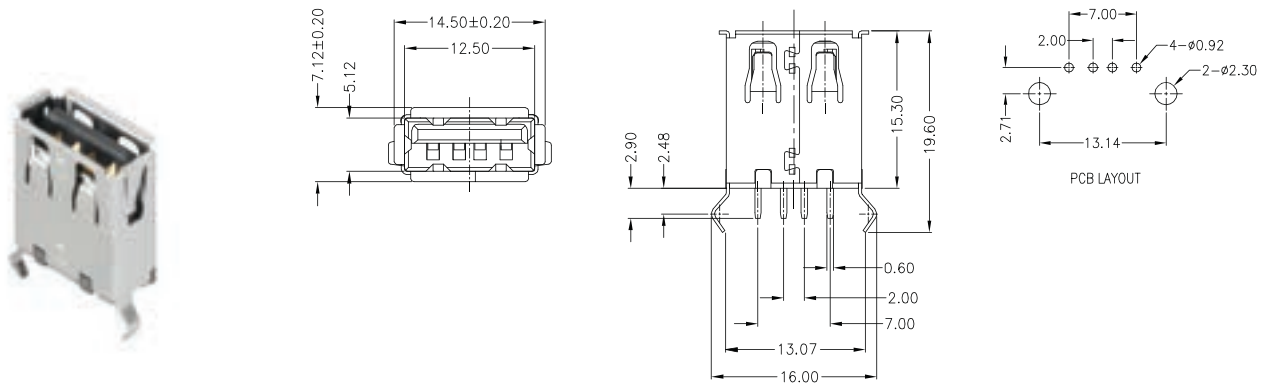
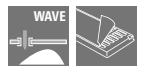

Ordering data

Type	Mounting onto the PCB	Plugging cycles	Performance-Category	Packaging	Qty.	Order No.
USB2.0A T1V 2.5N4 TY BK	THT solder connection	≥ 1500	480 Mbps	Tray (manual assembly)	100	1985910000



**USB jacks
for wave soldering process**

Type 3.0/2.0 A, 180° (horizontal)

For additional articles and information, refer to catalog.weidmueller.com



- Rated current up to 1.5 A
- ≥ 1500 plugging cycles
- Downward compatible

Technical data

Outgoing elbow	90°
Pitch	2.00 mm
Type of insulation material	PBT
Colour	black
UL 94 flammability rating	V-0
Shielding material	Brass
Shield surface	nickel-plated

Contact base material	Phosphorus bronze
Layer structure of plug contact	30...80 μm Ni / ≥ 30 μm Au
Operating temperature	-40...85 °C
Rated voltage	30 V
Rated current	1.5 A at 250 V AC
Dielectric strength, contact / contact	500 V AC
Insulation strength	≥ 500 MΩ

Note

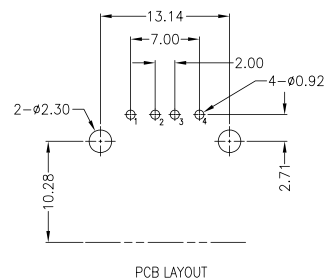
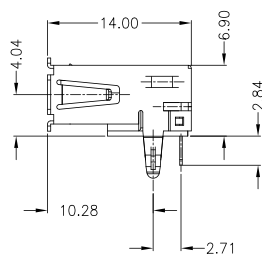
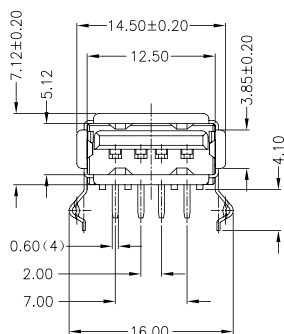
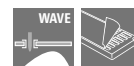

Ordering data

Type	Mounting onto the PCB	Plugging cycles	Performance-Category	Packaging	Qty.	Order No.
USB2.0A T1H 2.5N4 TY BK	THT solder connection	≥ 1500	480 Mbps	Tray (manual assembly)	100	2563710000

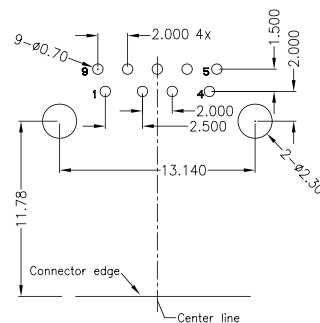
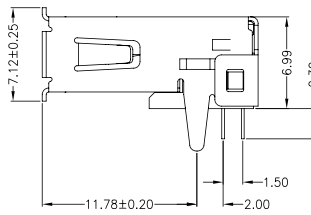
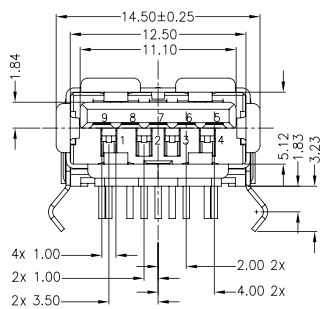
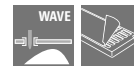

Ordering data

Type	Mounting onto the PCB	Plugging cycles	Performance-Category	Packaging	Qty.	Order No.
USB3.0A T1H 2.3N4 TY BL	THT solder connection	≥ 1500	5 Gbps	Tray (manual assembly)	104	2563550000



OMNIMATE® Data – D-SUB

OMNIMATE® Data – D-SUB	Explanation	F.2
	Quick selection	F.4
	D-SUB connector	F.6
	D-SUB connector High Density	F.14

OMNIMATE® Data D-SUB PCB connectors

Reliable data interfaces for your device

Already today connectors for data transmission play an important role of future-oriented device design. The D-SUB connectors ensure a secure and efficient interface on your device for the reliable transmission of data and signals in the industrial environments.

Take advantage of the easy integration into any installation situation and the reliable connections to industrial devices. Due to the high number of different types and the proven locking systems in combination with anti-rotation and contact protection, our D-SUB connectors meet the requirements for high durability.

F

Your special advantages:

- Established locking systems in combination with polarization and protection of the contacts
- Design in accordance with IEC 60807-3 (IEC 807-3) and DIN 41652
- Extended temperature range of -55 °C to +85 °C for maximum performance

Electromagnetic compatibility
(EMC) and protection thanks to 360° shielding

Simple installation
Due to the straight and angled designs, the sockets integrate into any installation situation.



Reliable ground connection and locking system
with optional snap-in clip



Economic flash-gold surface
for ≥ 500 mating cycles



Established locking
with threaded bolt or nut UNC 4-40



Broad range of applications

In compliance with the dimensions according to IEC 60807-3 (IEC 807-3) und DIN 41652, a wide variety of applications, such as measuring devices, interfaces and electronic devices, are covered.

<http://www.OMNIMATE.net>

- Design in accordance with IEC 60807-3 (IEC 807-3) and DIN 41652
- Wide range of different design types, also with snap-on clip
- Stamped contacts (Rated current: 3 A)
- Extended temperature range of -55 °C to +85 °C for maximum performance
- Solder pin length: 3,2 mm
- Packaging: Tray



Wave soldering process (THT)

Mounting onto the PCB

Reference picture	Type / Gender	Polanzahl	Outgoing elbow	Flange
	Female	9	Vertical 180°, standing	UNC 4-40 thread bolt
	Female	15	Vertical 180°, standing	UNC 4-40 thread bolt
	Female	25	Vertical 180°, standing	UNC 4-40 thread bolt
	Male	9	Vertical 180°, standing	UNC 4-40 thread bolt
	Male	15	Vertical 180°, standing	UNC 4-40 thread bolt
	Male	25	Vertical 180°, standing	UNC 4-40 thread bolt
	Female	9	Vertical 180°, standing	UNC 4-40 thread nut
	Female	15	Vertical 180°, standing	UNC 4-40 thread nut
	Female	25	Vertical 180°, standing	UNC 4-40 thread nut
	Male	9	Vertical 180°, standing	UNC 4-40 thread nut
	Male	15	Vertical 180°, standing	UNC 4-40 thread nut
	Male	25	Vertical 180°, standing	UNC 4-40 thread nut
	Female	9	Vertical 180°, standing	Hole
	Male	9	Vertical 180°, standing	Hole
	Female	9	Horizontal 90°, lying	UNC 4-40 thread bolt
	Female	15	Horizontal 90°, lying	UNC 4-40 thread bolt
	Female	25	Horizontal 90°, lying	UNC 4-40 thread bolt
	Male	9	Horizontal 90°, lying	UNC 4-40 thread bolt
	Male	15	Horizontal 90°, lying	UNC 4-40 thread bolt
	Male	25	Horizontal 90°, lying	UNC 4-40 thread bolt
	Female	9	Horizontal 90°, lying	UNC 4-40 thread nut
	Female	15	Horizontal 90°, lying	UNC 4-40 thread nut
	Female	25	Horizontal 90°, lying	UNC 4-40 thread nut
	Male	9	Horizontal 90°, lying	UNC 4-40 thread nut
	Male	15	Horizontal 90°, lying	UNC 4-40 thread nut
	Male	25	Horizontal 90°, lying	UNC 4-40 thread nut
	Female, high density	15	Horizontal 90°, lying	UNC 4-40 thread nut
	Male, high density	15	Horizontal 90°, lying	UNC 4-40 thread nut

Contact surface thickness	Order No.	Type
30 µ"	2707200000	D-SUB F6.3 T09VB 3.2B4 TY BK
30 µ"	2707210000	D-SUB F6.3 T15VB 3.2B4 TY BK
30 µ"	2707220000	D-SUB F6.3 T25VB 3.2B4 TY BK
30 µ"	2707230000	D-SUB M6.3 T09VB 3.2B4 TY BK
30 µ"	2707240000	D-SUB M6.3 T15VB 3.2B4 TY BK
30 µ"	2707250000	D-SUB M6.3 T25VB 3.2B4 TY BK
30 µ"	2707150000	D-SUB F6.3 T09VU 3.2B4 TY BK
30 µ"	2707160000	D-SUB F6.3 T15VU 3.2B4 TY BK
30 µ"	2707170000	D-SUB F6.3 T25VU 3.2B4 TY BK
30 µ"	2707170000	D-SUB M6.3 T09VU 3.2B4 TY BK
30 µ"	2707180000	D-SUB M6.3 T15VU 3.2B4 TY BK
30 µ"	2707190000	D-SUB M6.3 T25VU 3.2B4 TY BK
6 µ"	2626650000	D-SUB F6.1 T09VN 3.2N2 TY GY
6 µ"	2626620000	D-SUB M6.1 T09VN 3.2N2 TY GY
30 µ"	2706970000	D-SUB F6.3 T09HB 3.2B4 TY BK
30 µ"	2706980000	D-SUB F6.3 T15HB 3.2B4 TY BK
30 µ"	2701700000	D-SUB F6.3 T25HB 3.2B4 TY BK
30 µ"	2701720000	D-SUB M6.3 T09HB 3.2B4 TY BK
30 µ"	2701750000	D-SUB M6.3 T15HB 3.2B4 TY BK
30 µ"	2701760000	D-SUB M6.3 T25HB 3.2B4 TY BK
30 µ"	2701710000	D-SUB F6.3 T09HU 3.2B4 TY BK
30 µ"	2701730000	D-SUB F6.3 T15HU 3.2B4 TY BK
30 µ"	2724020000	D-SUB F6.3 T25HU 3.2B4 TY BK
30 µ"	2724030000	D-SUB M6.3 T09HU 3.2B4 TY BK
30 µ"	2724060000	D-SUB M6.3 T15HU 3.2B4 TY BK
30 µ"	2724070000	D-SUB M6.3 T25HU 3.2B4 TY BK
30 µ"	2706950000	D-SUB HDF6.3 T15HU 3.2B4 TY BK
30 µ"	2701690000	D-SUB HDM6.3 T15HU 3.2B4 TY BK

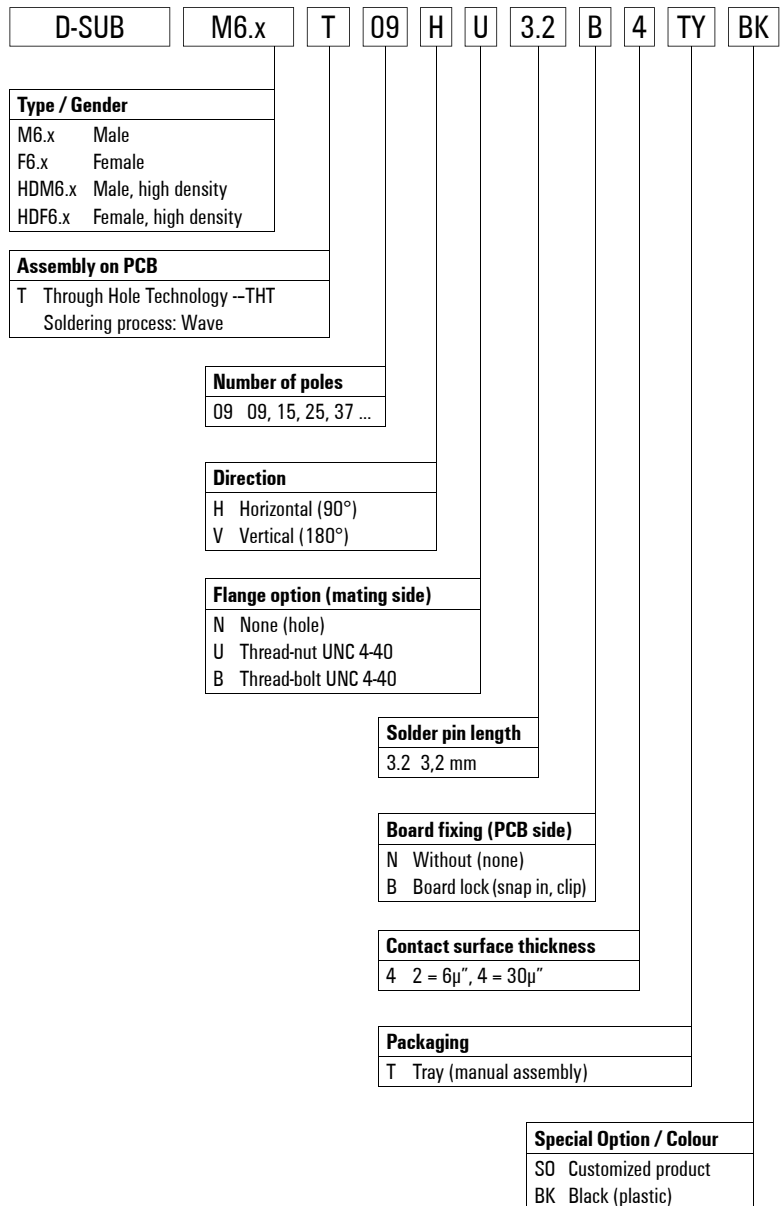

D-SUB connector

D-SUB acc. to IEC 60807-3 (IEC 807-3) and DIN 41652

For additional articles and information, refer to catalog.weidmueller.com



Technical data

Outgoing elbow	90°
Pitch	2.77 mm
Type of fixing	Board-lock
Mounting onto the PCB	THT solder connection
Side termination, characteristic	Thread-nut UNC 4-40
Type of insulation material	PBT GF
UL 94 flammability rating	V-0
Shielding material	Steel
Shield surface	tinned
Note	Further variants on request. Contacts are punched.

Contact base material	Copper alloy
Layer structure of plug contact	≥ 50 μ" Ni / 30 μ" Au
Operating temperature	-55...105 °C
Rated voltage	250 V
Rated current	3 A
Dielectric strength, contact / contact	1000 V AC
Insulation strength	≥ 1000 MΩ
Plugging cycles	500
Approvals	UR

F

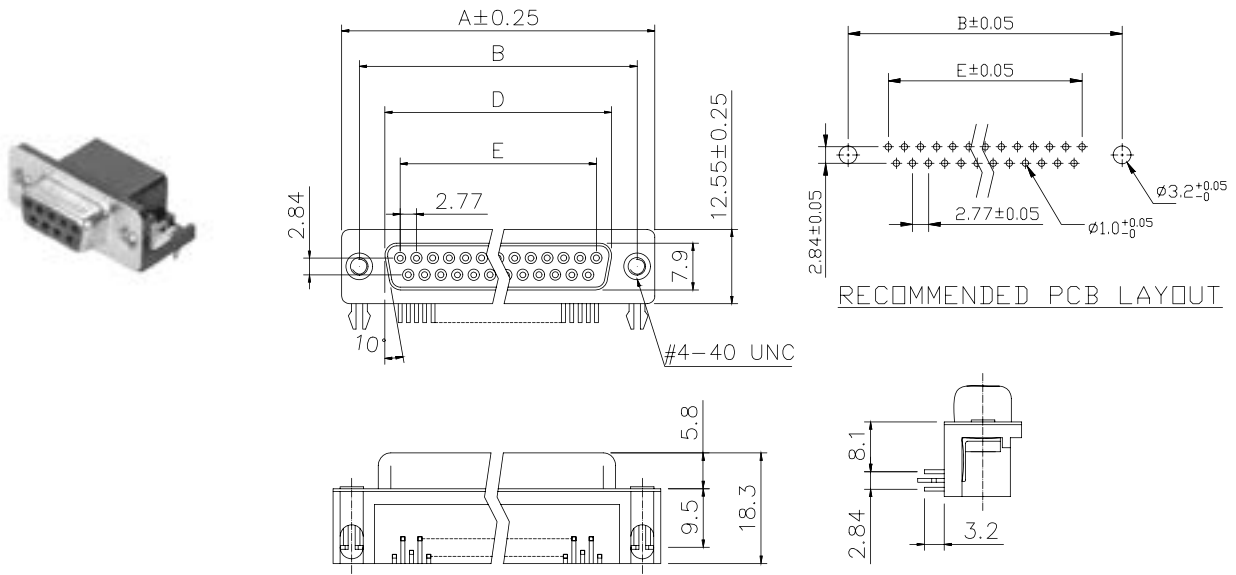
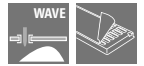

No. of poles	A	B	C	E
9	30.81	24.99	16.92	11.08
15	39.20	33.30	25.25	19.39
25	53.05	47.04	38.96	33.24

Ordering data

Type	Construction type	Pol.	Packaging	Qty.	Order No.
D-SUB F6.3 T09HU 3.2B4 TY BK	female header	9	Tray	90	2701710000
D-SUB F6.3 T15HU 3.2B4 TY BK	female header	15	Tray	70	2701730000
D-SUB F6.3 T25HU 3.2B4 TY BK	female header	25	Tray	70	2724020000



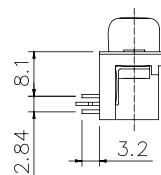
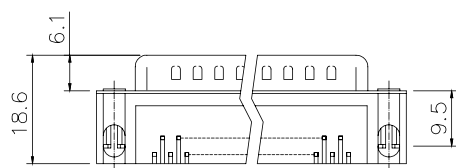
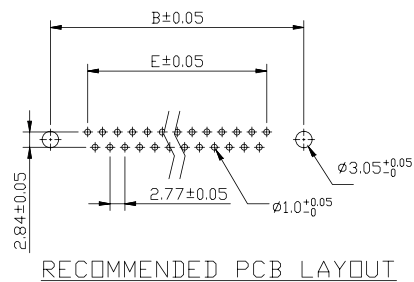
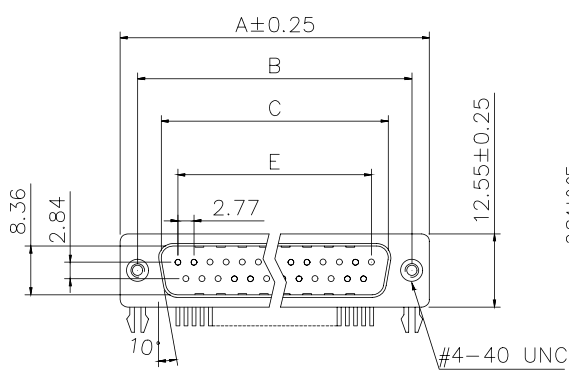
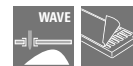

No. of poles	A	B	C	E
9	30.81	24.99	16.92	11.08
15	39.20	33.30	25.25	19.39
25	53.05	47.04	38.96	33.24

Ordering data

Type	Construction type	Pol.	Packaging	Qty.	Order No.
D-SUB M6.3 T09HU 3.2B4 TY BK	male header	9	Tray	90	2724030000
D-SUB M6.3 T15HU 3.2B4 TY BK	male header	15	Tray	90	2724060000
D-SUB M6.3 T25HU 3.2B4 TY BK	male header	25	Tray	90	2724070000



D-SUB connector

D-SUB acc. to IEC 60807-3 (IEC 807-3) and DIN 41652

For additional articles and information, refer to catalog.weidmuller.com



Technical data

Outgoing elbow	90°
Pitch	2.77 mm
Type of fixing	Board-lock
Mounting onto the PCB	THT solder connection
Side termination, characteristic	Thread-bolt UNC 4-40
Type of insulation material	PBT GF
UL 94 flammability rating	V-0
Shielding material	Steel
Shield surface	tinned
Note	Further variants on request. Contacts are punched.

Contact base material	Copper alloy
Layer structure of plug contact	≥ 50 μm Ni / 30 μm Au
Operating temperature	-55...105 °C
Rated voltage	250 V
Rated current	3 A
Dielectric strength, contact / contact	1000 V AC
Insulation strength	≥ 1000 MΩ
Plugging cycles	500
Approvals	UR

F

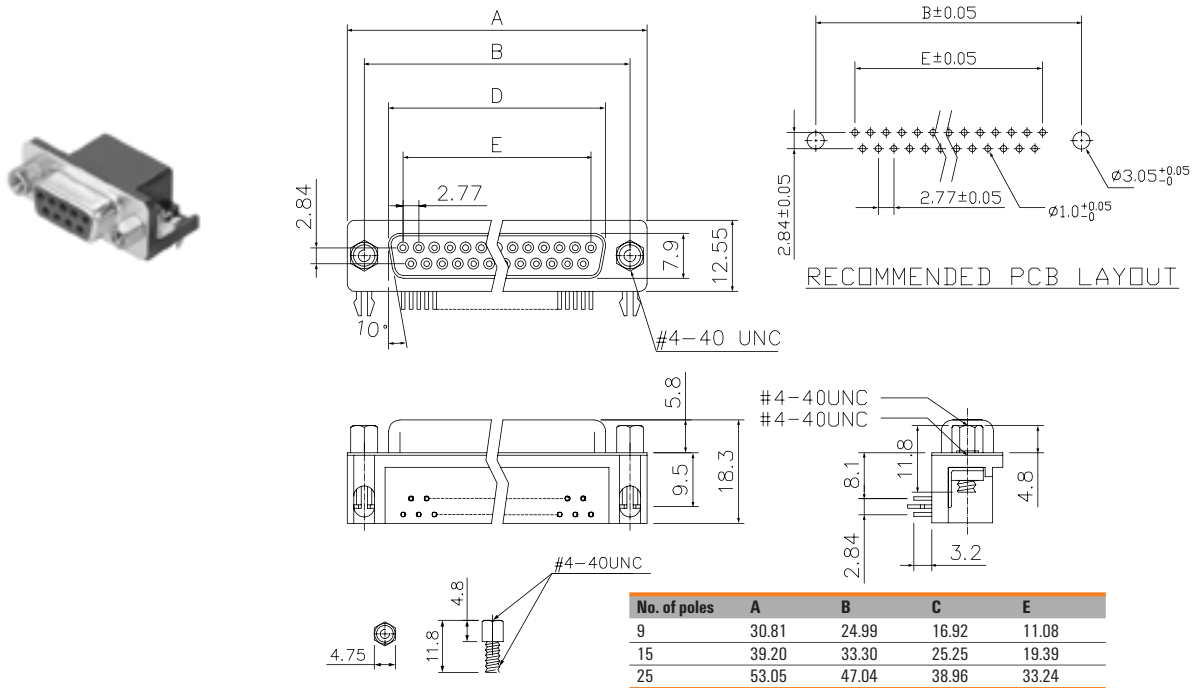
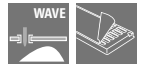

No. of poles	A	B	C	E
9	30.81	24.99	16.92	11.08
15	39.20	33.30	25.25	19.39
25	53.05	47.04	38.96	33.24

Ordering data

Type	Construction type	Pol.	Packaging	Qty.	Order No.
D-SUB F6.3 T09HB 3.2B4 TY BK	female header	9	Tray	90	2706970000
D-SUB F6.3 T15HB 3.2B4 TY BK	female header	15	Tray	70	2706980000
D-SUB F6.3 T25HB 3.2B4 TY BK	female header	25	Tray	90	2701700000



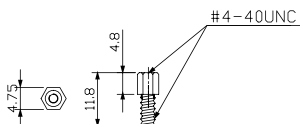
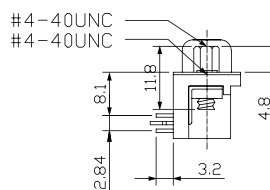
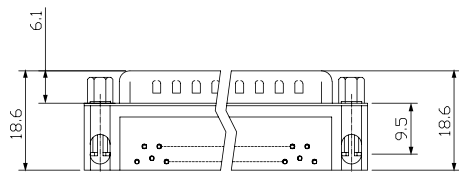
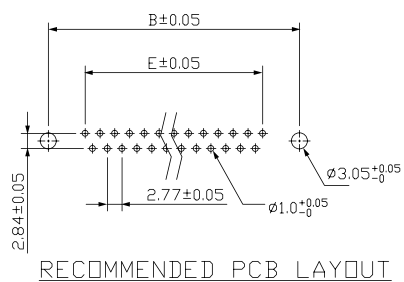
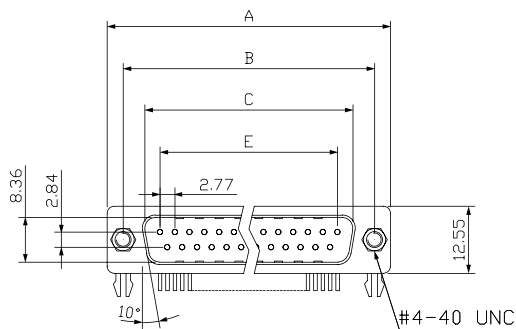
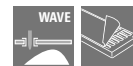

No. of poles	A	B	C	E
9	30.81	24.99	16.92	11.08
15	39.20	33.30	25.25	19.39
25	53.05	47.04	38.96	33.24

Ordering data

Type	Construction type	Pol.	Packaging	Qty.	Order No.
D-SUB M6.3 T09HB 3.2B4 TY BK	male header	9	Tray	90	2701720000
D-SUB M6.3 T15HB 3.2B4 TY BK	male header	15	Tray	70	2701750000
D-SUB M6.3 T25HB 3.2B4 TY BK	male header	25	Tray	50	2701760000



D-SUB connector

D-SUB acc. to IEC 60807-3 (IEC 807-3) and DIN 41652

For additional articles and information, refer to catalog.weidmueller.com



Technical data

Outgoing elbow	180°
Pitch	2.77 mm
Type of fixing	Board-lock
Mounting onto the PCB	THT solder connection
Side termination, characteristic	Thread-nut UNC 4-40
Type of insulation material	PBT GF
UL 94 flammability rating	V-0
Shielding material	Steel
Shield surface	tinned
Note	Further variants on request. Contacts are punched.

Contact base material	Copper alloy
Layer structure of plug contact	≥ 50 μ" Ni / 30 μ" Au
Operating temperature	-55...105 °C
Rated voltage	250 V
Rated current	3 A
Dielectric strength, contact / contact	1000 V AC
Insulation strength	≥ 1000 MΩ
Plugging cycles	500
Approvals	UR

F

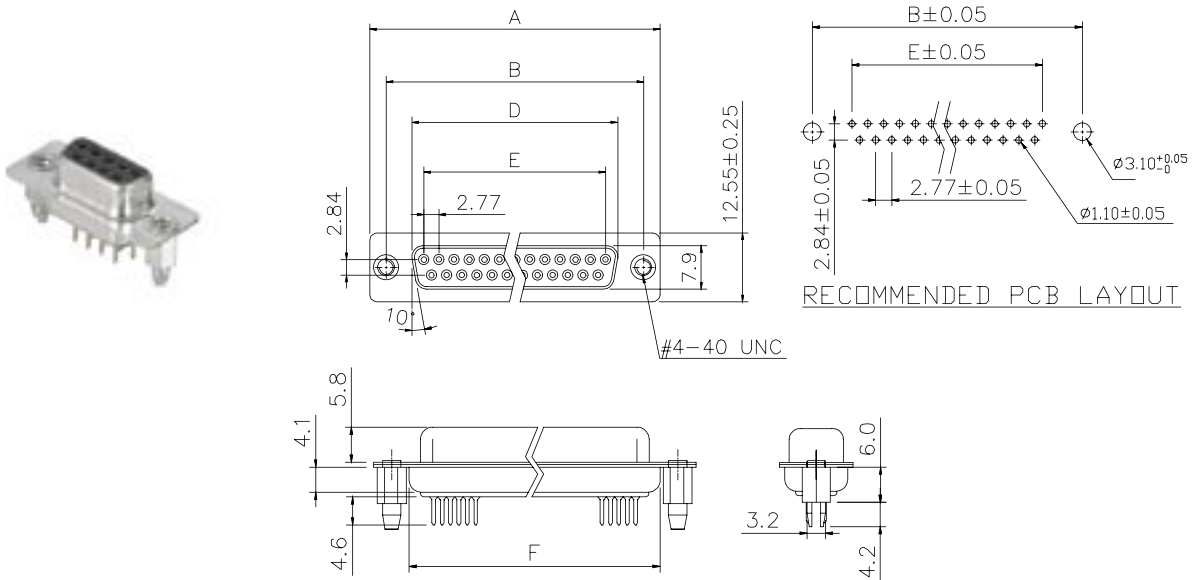
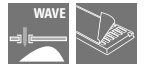

No. of poles	A	B	C	E	E
9	30.81	24.99	16.92	11.08	11.08
15	39.20	33.30	25.25	19.39	19.39
25	53.05	47.04	38.96	33.24	33.24

Ordering data

Type	Construction type	Pol.	Packaging	Qty.	Order No.
D-SUB F6.3 T09VU 3.2B4 TY BK	female header	9	Tray	90	2707150000
D-SUB F6.3 T15VU 3.2B4 TY BK	female header	15	Tray	70	2707160000
D-SUB F6.3 T25VU 3.2B4 TY BK	female header	25	Tray	50	2701740000



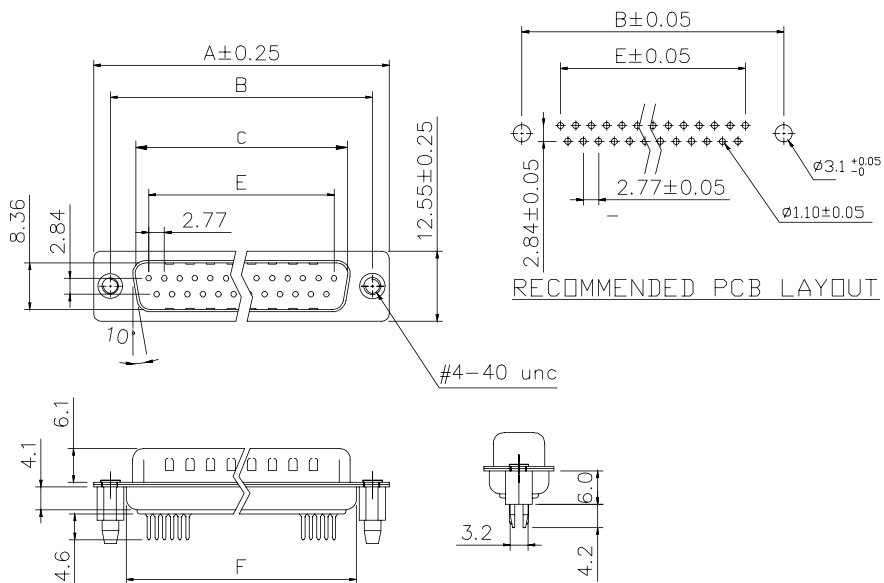
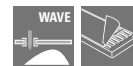

No. of poles	A	B	C	E	F
9	30.81	24.99	16.92	11.08	19.20
15	39.20	33.30	25.25	19.39	27.70
25	53.05	47.04	38.96	33.24	41.10

Ordering data

Type	Construction type	Pol.	Packaging	Qty.	Order No.
D-SUB M6.3 T09VU 3.2B4 TY BK	male header	9	Tray	90	2707170000
D-SUB M6.3 T15VU 3.2B4 TY BK	male header	15	Tray	70	2707180000
D-SUB M6.3 T25VU 3.2B4 TY BK	male header	25	Tray	50	2707190000



D-SUB connector

D-SUB acc. to IEC 60807-3 (IEC 807-3) and DIN 41652

For additional articles and information, refer to catalog.weidmueller.com



Technical data

Outgoing elbow	180°
Pitch	2.77 mm
Type of fixing	Board-lock
Mounting onto the PCB	THT solder connection
Side termination, characteristic	Thread-bolt UNC 4-40
Type of insulation material	PBT GF
UL 94 flammability rating	V-0
Shielding material	Steel
Shield surface	tinned
Note	Further variants on request. Contacts are punched.

Contact base material	Copper alloy
Layer structure of plug contact	≥ 50 μm Ni / 30 μm Au
Operating temperature	-55...105 °C
Rated voltage	250 V
Rated current	3 A
Dielectric strength, contact / contact	1000 V AC
Insulation strength	≥ 1000 MΩ
Plugging cycles	500
Approvals	UR

F

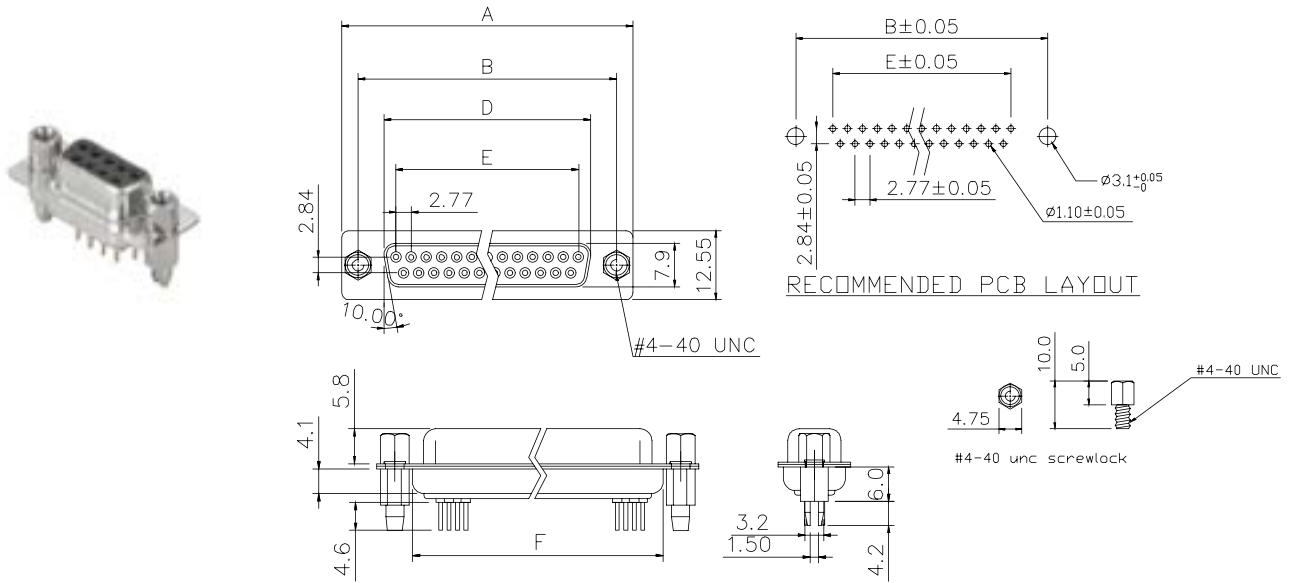
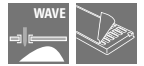

No. of poles	A	B	C	E	F
9	30.81	24.99	16.92	11.08	19.20
15	39.20	33.30	25.25	19.39	27.70
25	53.05	47.04	38.96	33.24	41.10

Ordering data

Type	Construction type	Pol.	Packaging	Qty.	Order No.
D-SUB F6.3 T09VB 3.2B4 TY BK	female header	9	Tray	90	2707200000
D-SUB F6.3 T15VB 3.2B4 TY BK	female header	15	Tray	70	2707210000
D-SUB F6.3 T25VB 3.2B4 TY BK	female header	25	Tray	50	2707220000



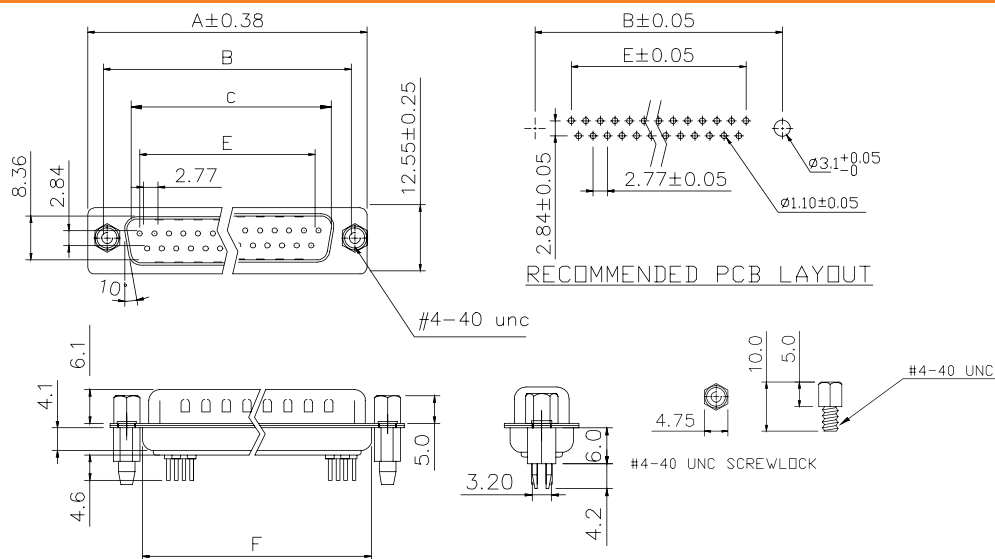
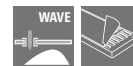

No. of poles	A	B	C	E	E
9	30.81	24.99	16.92	11.08	19.20
15	39.20	33.30	25.25	19.39	27.70
25	53.05	47.04	38.96	33.24	41.10

Ordering data

Type	Construction type	Pol.	Packaging	Qty.	Order No.
D-SUB M6.3 T09VB 3.2B4 TY BK	male header	9	Tray	90	2707230000
D-SUB M6.3 T15VB 3.2B4 TY BK	male header	15	Tray	70	2707240000
D-SUB M6.3 T25VB 3.2B4 TY BK	male header	25	Tray	50	2707250000



D-SUB connector
High Density

D-SUB acc. to IEC 60807-3 (IEC 807-3) and DIN 41652

For additional articles and information, refer to catalog.weidmueller.com



Technical data

Outgoing elbow	90°
Pitch	2.29 mm
Type of fixing	Board-lock
Mounting onto the PCB	THT solder connection
Side termination, characteristic	Thread-nut UNC 4-40
Type of insulation material	PBT GF
UL 94 flammability rating	V-0
Shielding material	Steel
Shield surface	tinned
Note	Further variants on request. Contacts are punched.

Contact base material	Copper alloy
Layer structure of plug contact	≥ 50 μm Ni / ≥ 30 μm Au
Operating temperature	-55...105 °C
Rated voltage	250 V
Rated current	3 A
Dielectric strength, contact / contact	1000 V AC
Insulation strength	≥ 1000 MΩ
Plugging cycles	500
Approvals	UR

F

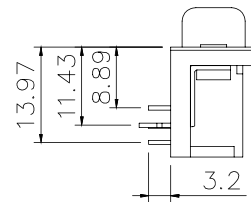
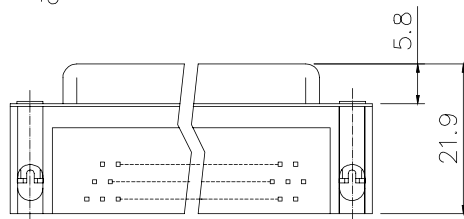
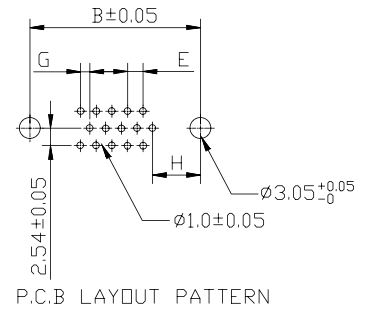
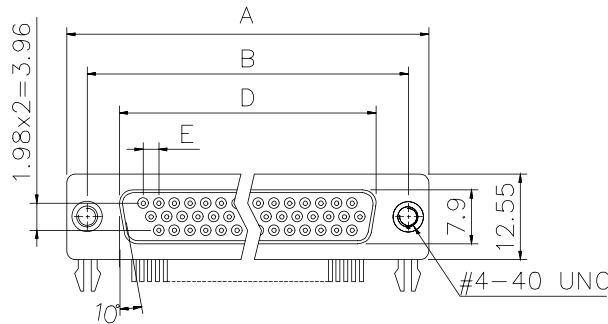

No. of poles	A	B	D	E	G	H
15	30.81	24.99	16.35	2.29	1.145	7.04

Ordering data

Type	Construction type	Pol.	Packaging	Qty.	Order No.
D-SUB HDF6.3 T15HU 3.2B4 TY BK	female header	15	Tray	90	2706950000

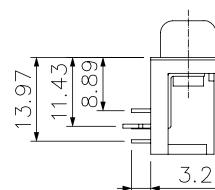
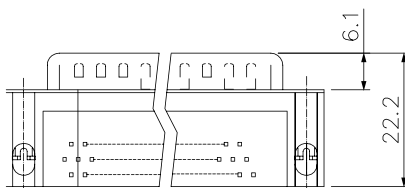
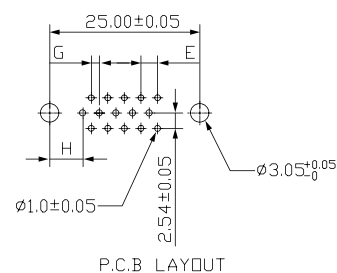
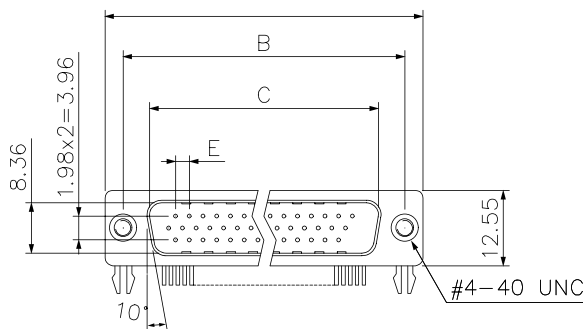
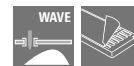

No. of poles	A	B	D	E	G	H
15	30.81	24.99	16.92	2.29	1.145	7.04

Ordering data

Type	Construction type	Pol.	Packaging	Qty.	Order No.
D-SUB HDM6.3 T15HU 3.2B4 TY BK	male header	15	Tray	90	2701690000

OMNIMATE® Signal PCB terminals

OMNIMATE® Signal PCB terminals	Explanation	G.2
	Quick selection	G.14
	Clamping yoke screw connection	G.18
	Leaf spring screw connection	G.42
	PUSH IN spring connection	G.46
	Tension clamp connection	G.98

OMNIMATE® Signal PCB terminals

Flexible and versatile in pitches of between 3.5 mm and 10.00 mm for the wave soldering process

A wide variety of application requirements from the industrial automation and control fields are solved using the components from the comprehensive OMNIMATE® Signal PCB terminal range. You can find a suitable solution for almost any application, whether in terms of the conductor outlet direction, the pitch, the wire cross-section to be clamped, the required contact density through multi-level varieties or the sort of connection you want.

Standard-compliant integration

Following relevant international guidelines/standards and Weidmüller's laboratory accreditation ensure highest quality standards for use globally.



Screw connection system

The automatically counter-operating Weidmüller steel clamping yoke uses force generated by tightening the screw to open the upper thread. Settling of the connected wires and vibrations are compensated for and this guarantees a maintenance free operation. Subsequent tightening and maintenance of the screw is not needed.

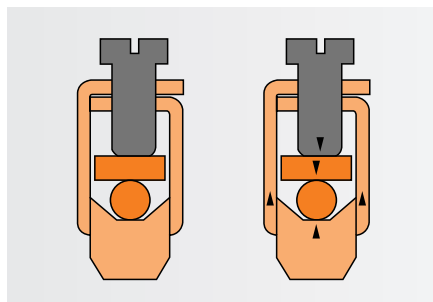

Fire resistance

The high-quality plastics used in many of the product families in the OMNIMATE® Signal product line meet the higher fire safety requirements according to the domestic appliance standard IEC 60335-1.



Tension clamp connection system

Simple and fast - the universal screw-less connector with a steel spring. Ideal for PCB installation terminals where it is important that the connections are secure. Single row, with or without an operating lever to open the terminal point with a wire cross-section of up to 2.5 mm². Higher connector density with double, or triple level variations with a pitch of 5.08 mm and clamping range of up to 2.5 mm².

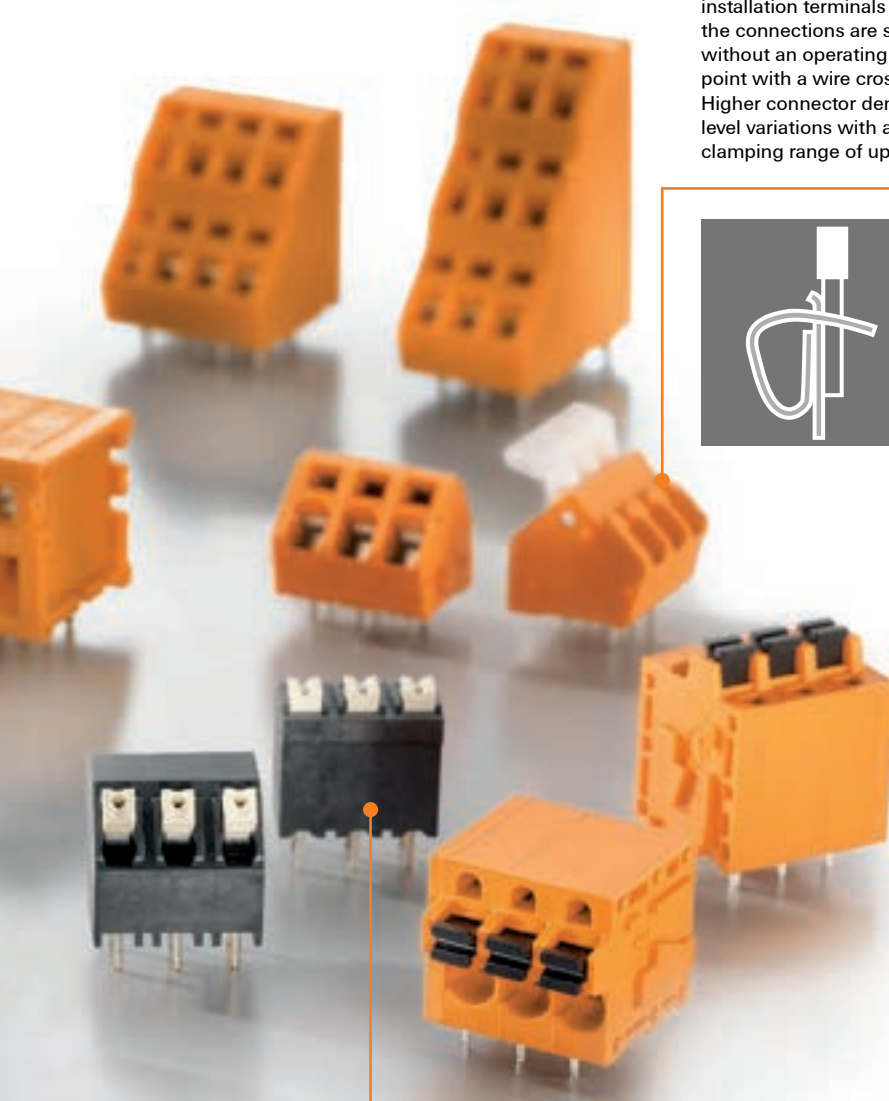
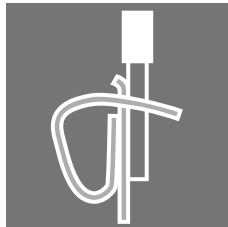

PUSH IN connection system

The innovative quick connector – simple, safe and economical. Direct insertion of solid-core wires and stranded wires with ferrules when used with the LSF-SMT series.

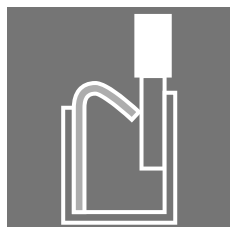

Power reserve for safety

The high performance insulating material WEMID with a continuous operating temperature of 120 °C for higher load currents and ambient temperatures. OMNIMATE® Signal PCB terminals already exceed the standard PA working temperature (100 °C) of many product families by 20 °K. This allows more power reserves and increased safety during temperature fluctuations or overloads.

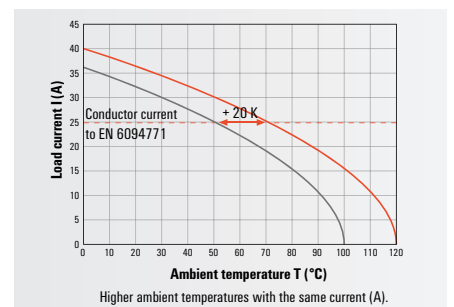



OMNIMATE® Signal PCB terminals

LSF-SMT spring connection in pitches of between 3.5 mm and 7.62 mm for the reflow soldering process (THR)

The innovative quick connector - simple, safe and economical. Its compact dimensions and surprising performance of 17.5 A / 800 V (IEC) means that the LSF-SMT meets the market push for miniaturisation. The OMNIMATE® Signal PCB terminals LSF-SMT offer a wide pitch range from 3.5 to 7.62 mm, in various conductor outlet directions (90°/135°/180°) to the PCB for connections of wire cross-sections of up to 1.5 mm². The use of high-quality materials guarantees maximum cost effectiveness in the manufacturing of electronic assemblies.

SMT/THR process compatible

The compact design and packaging (tape-on-reel) for automatic pick and place systems of SMT production lines reduces production costs of electronic components even further.



Form stability for the reflow soldering process

The high-temperature-resistant insulating material LCP used in the LSF-SMT range, is characterised by its form and dimensional stability. Due to low moisture absorption, the LSF-SMT can be immediately used in the Reflow THR soldering process without an extra drying phase. The uninterrupted production process from automated assembly to soldering is achieved saving you time and money.



Flexible processing

With a pin length of 3.5 mm for hand and wave soldering, or 1.5 mm for reflow soldering (THR), there are standard models available even for double sided assembled PCBs.



Fire resistance

The high-quality plastics used meet the higher fire safety requirements according to the domestic appliance standard IEC 60335-1.



Design flexibility

With the conductor outlet directions of 90°/135° and 180° over all pitches from 3.5 to 7.62 mm, all design options are possible.

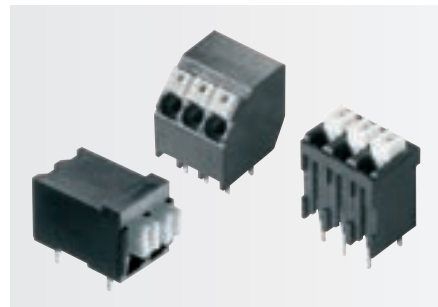

Marking and mapping

Terminal points can be distinctively marked with coloured push buttons or individual printing.



Safe and efficient

Solid conductors or wires with ferrules up to 1.5 mm² can be connected with the rapid spring-connection technology PUSH IN. The integrated push buttons are used for releasing. Amazingly simple and simply amazing in practice.

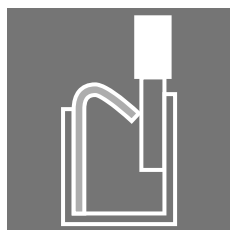

OMNIMATE® Signal PCB terminals

LSF-SMD 3.5/180 spring connection for the reflow soldering process (SMD)



The new LSF-SMD meets the demands for fully automatic PCB assembling as a surface-mounting device (SMD). Two SMD soldering pads per pole provide a high level of mechanical stability in accordance with IPC-A-610 class 2.

It is now possible for applications on glass based, ceramic based and aluminium compound based PCB's to also take advantage of PUSH IN technology. The existing portfolio of Weidmüller's reflow compatible LSF-SMT terminals with THR soldering has been expanded to include a real SMD variant.

The 3.5 mm pitch and the wire outlet direction of 180° allow a high packing density with a maximum wire cross section of 1.5 mm².

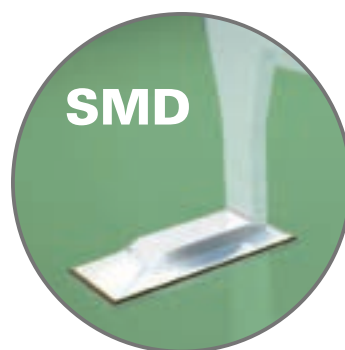

G

Order a sample

Let yourself be convinced by the LSF-SMD features. Request a free sample using.



Reliable processing

The LCP causes no formation of blisters and no predrying is required (MSL 1). Direct assembly with the SMT process is possible.

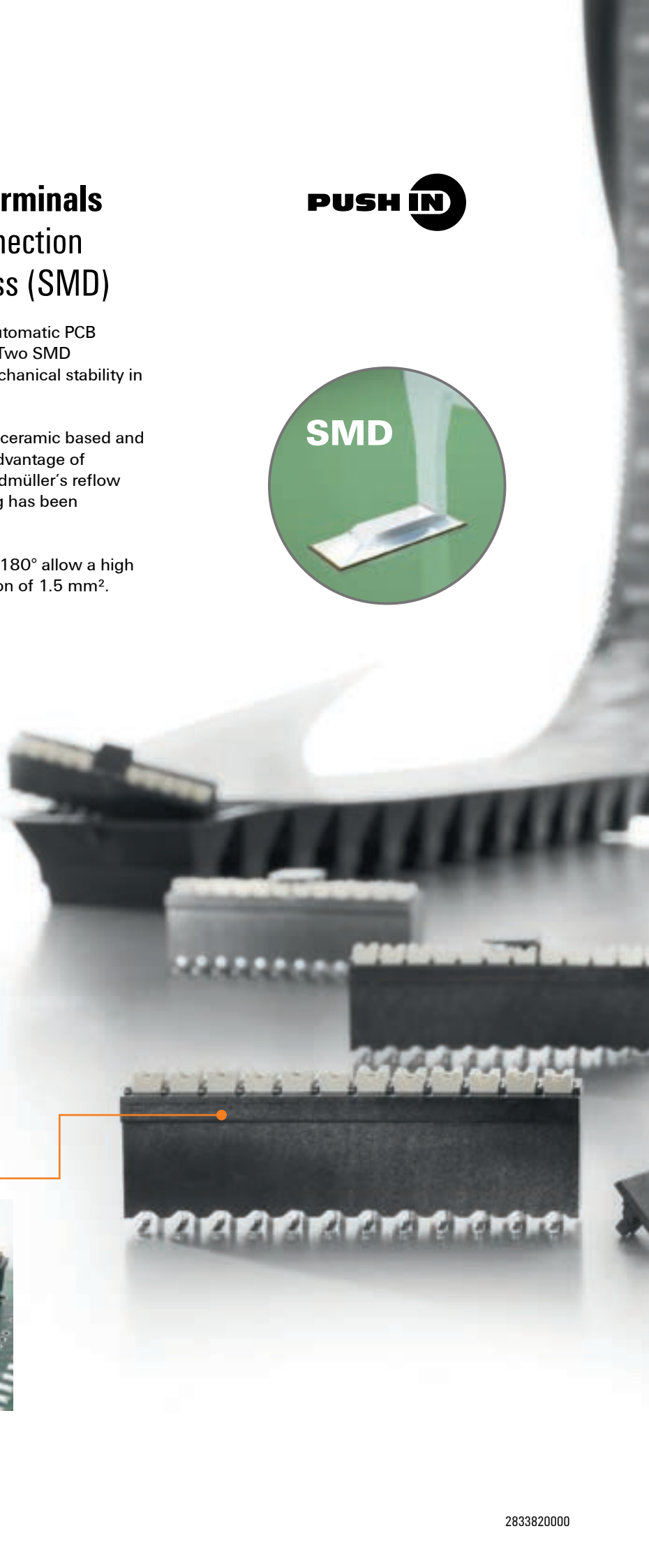
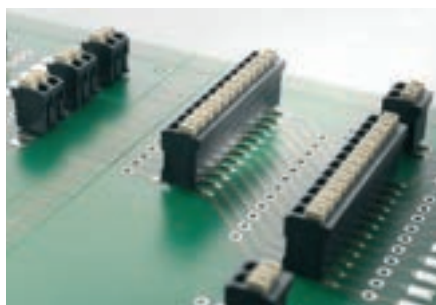

Stable soldering connections

With two solder pins per pole, the LSF-SMD PCB terminal is adequately attached to the circuit board and does not need an additional mounting flange.



Efficient assembly

An efficient automatic assembly process is supported by the tape on reel packaging in standard tape widths. The optimised Pick and Place pads ensure that the pick and place process is safe and reliable.



Fast wire connection method

Safe contact connections up to 1.5 mm² with no tools needed: made possible by the proven PUSH IN connection system. The integrated release button is used to disconnect the cable in a simple and quick manner.

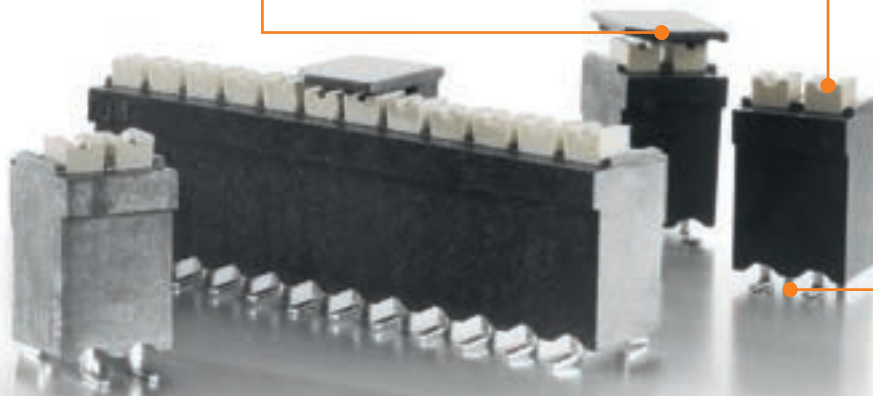
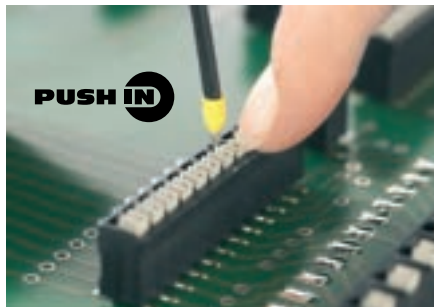

OMNIMATE® Signal – PUSH IN PCB-terminal LMF

Modern connectivity technology fulfilling the high demands of design up to a conductor cross section of 2.5 mm²

Innovative developments in industrial devices means precision-fit connectivity for power supplies is needed. Your best choice is our new, compact LMF PCB terminals, which are compelling with their modern connectivity technology.

The demands on PCB terminals in industrial device applications with a supply voltage of 250 V requires an extremely reliable wire connection contact and very safe electrical insulation materials.

Our response to this is the LMF with time saving PUSH IN spring connection technology, an integrated test point and a 90° or 180° wire outlet direction for different applications. The Wemid insulation material allows the assembling of PCB terminals and continuous use in temperatures of up to 120 °C.

With these functions, the LMF meets the tough design requirements of industrial device connections.

G

Integrated test point

The required maintenance and measurement can be carried out in a safe, reliable and convenient manner.



PUSH IN connector up to 2.5 mm²

You can plug solid conductors or wires with ferrules in directly and have a time-saving, reliable connection.

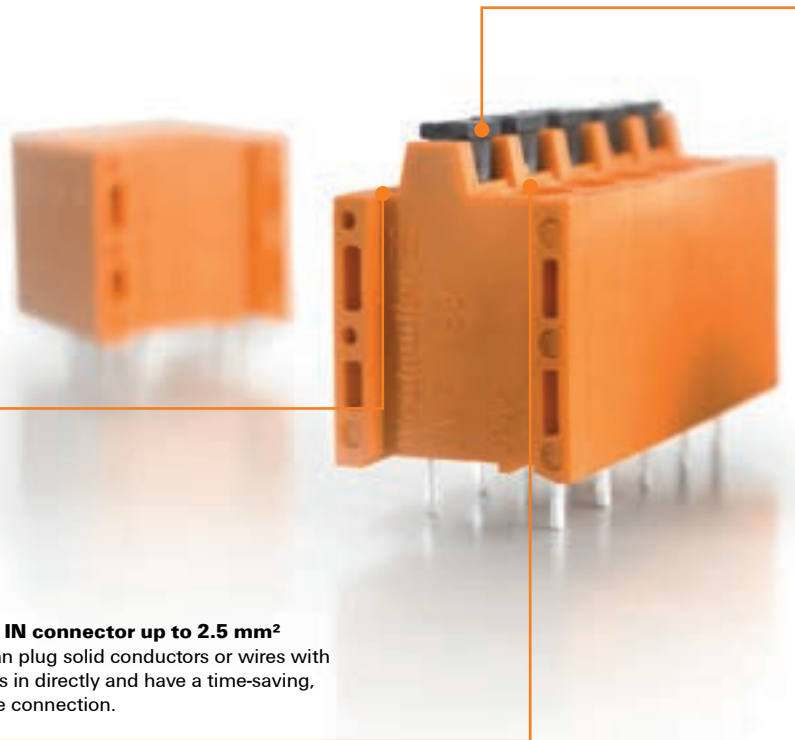

Wire outlet direction of 90° or 180°

High flexibility in your design is given by options of wire outlet directions from above (180°) or the side (90°).

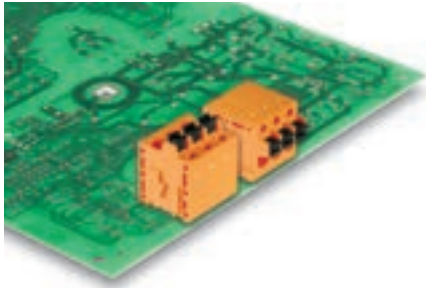

Two solder pins per pole

Benefit from the highly secure, current-carrying capacity and mechanical stability on the PCB board, without additional mounting elements.



Optional “pusher”

Select your preferred way of activating the PUSH IN spring connection: Depending on your choice, you open the contacts with the integrated “pusher” or by using a screwdriver.

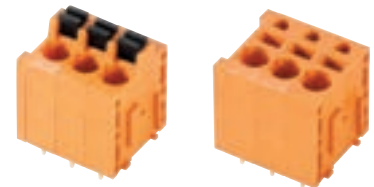

120° C continuous use temperature

In addition to fulfilling strict environmental standards, the Wemid insulation material also meets the requirement of maximum system reliability.

With a continuous use temperature of 120 °C, it exceeds the PA standard (100 °C) by 20 K.

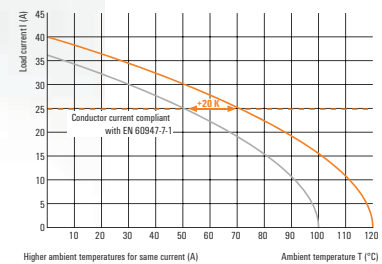

Reliable functionality due to the “pusher”

The optional push button provides a fast and exact wiring. By pressing the push button, the contact will open very quickly and easily.



Add-on programs of PUSH IN PCB terminals are the LSF product lines

This terminal series for conductor cross-sections up to 1.5 mm² meets all the requirements of the automated assembly and reflow processes.

PUSH IN – PCB terminal

LMFV – PUSH IN terminal in pitch 5.00 and 7.50

Due to the PUSH IN connection technology, the new OMNIMATE® Signal LMFV PCB terminal blocks enable a particularly fast and safe device connection. Their layout is identical to the proven LM product family with clamping yoke connection. This gives device engineers the choice between the classic clamping yoke connection and the innovative PUSH IN connection. The LMFV PCB terminals have been optimised for wave soldering processes.

G

Twin-Design

Layout and design compatibility with OMNIMATE® LM PCB terminal blocks with clamping yoke connection technology – for variable use of both connection technologies.

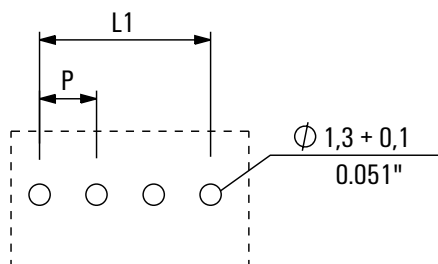

High flexibility

Flexible selection of the connection technology makes it possible to achieve particularly precise solutions.

**Two grid widths**

For standard connections with 5.00 mm pitch and also suitable for higher voltages up to 500 volts with 7.50 mm pitch.



The simple way to connect wires with cross-sections up to 1.5 mm² LS2HF with PUSH IN connection system on two connection levels

Ensuring compact dimensions through miniaturisation, while maintaining excellent functionality: these are the specific challenges faced when designing monitoring and I/O systems and devices in the field of building automation.

The new double-row OMNIMATE® Signal PCB terminal LS2HF meets both of these requirements at once thanks to the space-saving design and especially through the use of the time saving PUSH IN connection system. Optimised for wire cross-sections up to 1.5 mm² in a pitch dimension of 3.5 mm.

The LS2HF includes an integrated pusher for opening the contact in easiest way. An additional test point has also been integrated, making it easy to do necessary service measurements. The wire entry direction of 90° and the compact, double-row design of the LS2HF allows the simple integration into the front panel of a device.

G

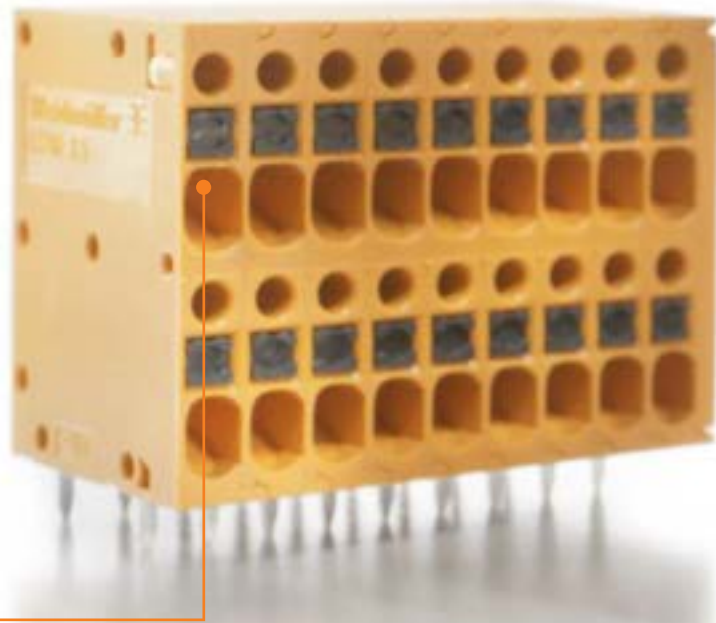

PUSH IN connection

Solid wires or wires with ferrules can be plugged directly thanks to the PUSH IN connection technology, which saves time and ensures a reliable connection.



Integrated test point

Necessary maintenance and measurements can be carried out in a safe, reliable and convenient manner.



Reliable functionality

The PUSH IN contact can be opened easily by pressing the push button in a particularly fast and unmistakable way.

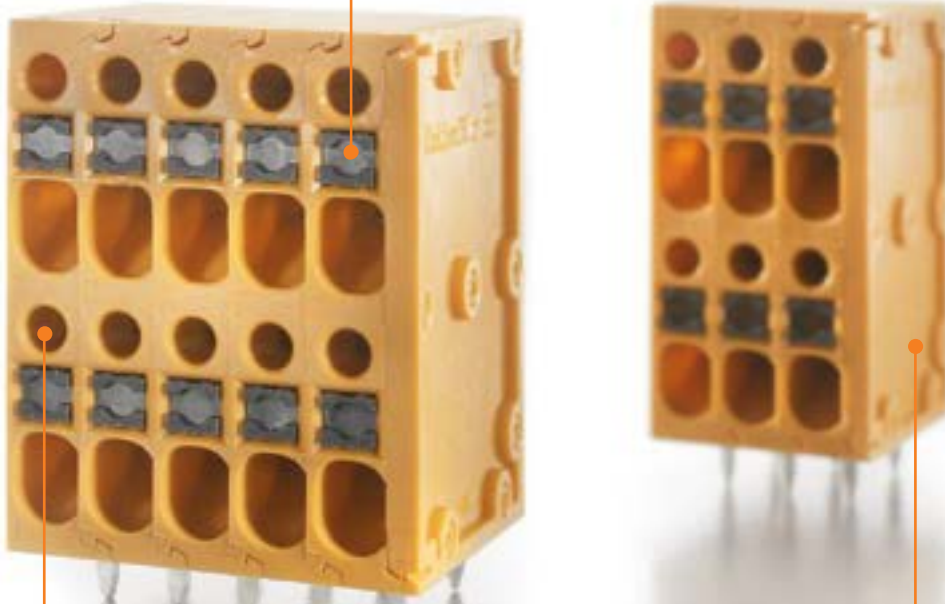
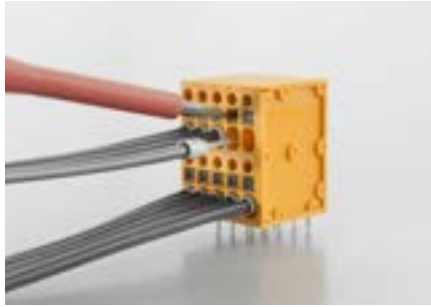

High component density

The compact design with PUSH IN connection system over two levels is perfectly suited for wire cross-sections up to 1.5 mm² in a pitch dimension of 3.5 mm.



Your special advantages:

PCB connection within the smallest space

For those looking for a compact and simple connection solution for optional installation in a front panel, the double-level LS2HF will not disappoint.



Quick and safe wiring with excellent performance: the space-saving LS2HF PCB terminal allows a perfect integration into the front panel of a device, e.g. with industrial control units and frequency converters

<http://www.OMNIMATE.net>

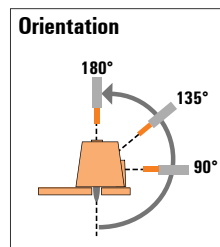

PCB terminals

Type of connection		Clamping range	Type	IEC / UL	90°	135°	180°
Screw	Clamping yoke	≤ 1.5 mm ²	LM	IEC: 320 V/16 A/0.5 - 1.5 mm ² UL: 300 V/10 A/AWG 28 - 14	●	●	
			LS	IEC: 630 V/17.5 A/0.08 - 1.5 mm ² UL: 300 V/15 A/AWG 28 - 14	●		
		≤ 2.5 mm ²	LM	IEC: 630 V/17.5 A/0.2 - 2.5 mm ² UL: 300 V/15 A/AWG 24 - 14	●	●	
	≤ 6.0 mm ²	LL	IEC: 500 V/32.5 A/0.5 - 6 mm ² UL: 300 V/20 A/AWG 28 - 12	●		●	
	Leaf spring	≤ 1.5 mm ²	PS	IEC: 320 V/17.5 A/0.2 - 1.5 mm ² UL: 300 V/10 A/AWG 28 - 16	●		
		≤ 2.5 mm ²	PM	IEC: 600 V/24 A/0.13 - 2.5 mm ² UL: 300 V/15 A/AWG 26 - 14	●		

G

Pitch, in mm	3.50		3.81	5.00			5.08			6.35	7.50	7.62	9.52		10.00	10.16
	1	2	1	1	2	3	1	2	3	1	1	1	1	2	1	1
Reflow																
	THT	SMD														
		●	●													
		●														
									●							
									●	●	●					
									●	●						
									●	●	●					
									●	●	●					
									●	●	●			●	●	●
									●							
		●							●							
									●							

<http://www.OMNIMATE.net>

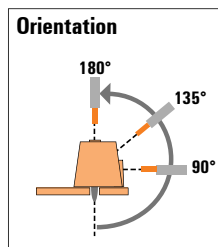

PCB terminals

Type of connection	Clamping range	Type	IEC / UL	90°	135°	180°
Spring PUSH IN	≤ 1.5 mm ²	 LSF-SMT	IEC: 320 V/17.5 A/0.2 - 1.5 mm ² UL: 300 V/12 A/AWG 24 - 16	●	●	●
		 LSF-SMD	IEC: 320 V/17.5 A/0.2 - 1.5 mm ² UL: 300 V/12 A/AWG 24 - 16		●	
		 LMF(S)	IEC: 400 V/24 A/0.2 - 2.5 mm ² UL: 300 V/10 A /AWG 26 - 12	●		●
		 LMFV	IEC: 630 V/17.5 A/0.2 - 2.5 mm ² UL: 300 V/15 A/AWG 24 - AWG 14	●		
		 LS2HF	IEC: 400 V/17 A/0.2 - 1.5 mm ² UL: 150 V/12.5 A /AWG 26 - 16	●		
 Tension clamp	≤ 2.5 mm ²	 LMZF	IEC: 630 V/24 A/0.13 - 2.5 mm ² UL: 300 V/15 A/AWG 26 - 14		●	

G

Pitch, in mm	3.50		3.81	5.00			5.08			6.35	7.50	7.62	9.52		10.00	10.16	
	Number of Levels	1	2	1	1	2	3	1	2	3	1	1	1	1	2	1	1
Reflow																	
	THT	SMD															
	●		●		●			●				●	●				
	●		●		●			●				●	●				
	●		●		●			●				●	●				
		●	●		●							●					
		●	●		●							●					
		●	●		●							●					
					●			●									
					●							●					
	●																
					●			●	●	●		●	●			●	●

LM 3.5

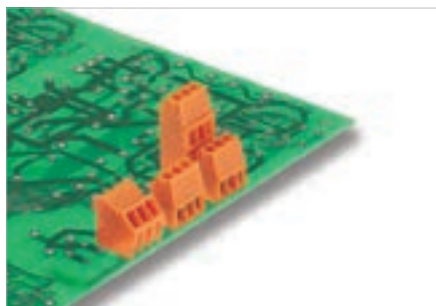

Small, compact PCB terminal with our proven clamping yoke screw connection in 3.5 mm pitch, suitable for wire cross-sections up to 1.5 mm².

- Wire outlet direction: 90° or 135° version.
- 2- and 3-pole block construction – can be aligned together for higher pole counts.

Product data

IEC: 320 V / 16 A / 0.5 - 1.5 mm²
 UL: 300 V / 10 A / AWG 28 - 14



For additional articles and information, refer to catalog.weidmuller.com

Note:

- Additional variants on request
- Rated current related to rated cross-section & min. No. of poles.
- Max. outer diameter of the conductor: 2.9 mm
- Wire end ferrule with plastic collar to DIN 46228/4
- P on drawing = pitch
- Rated data refer only to the component itself. Clearance and creepage distances to other components are to be designed in accordance with the relevant application standards.
- It is necessary to hold the insulating body of the one or two pole terminal when tightening the screw
- Long term storage of the product with average temperature of 50 °C and average humidity 70%, 36 months

LM 3.5/..90



Dimensioned drawing

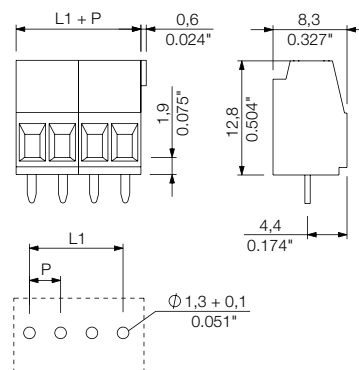

Ordering data

Solder pin length		3.2 mm		
Colour		orange		
Pitch		3.50 mm		
Pol.	L1	(inch)	Qty.	Order No.
2	3.50	0.138	100	1667750000
3	7.00	0.276	100	1667770000
4	10.50	0.413	100	1845040000
5	14.00	0.551	100	1720250000
6	17.50	0.689	50	1845050000
7	21.00	0.827	50	1845060000
8	24.50	0.965	50	1845070000
9	28.00	1.102	50	1845080000
10	31.50	1.240	50	1845090000
11	35.00	1.378	50	1845100000
12	38.50	1.516	50	1845110000

Representative deratings curve

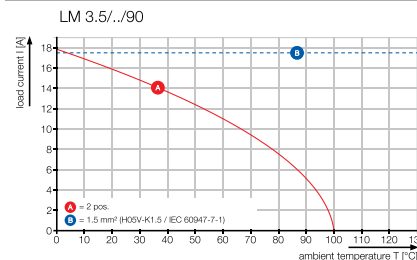

Technical data

In compliance with IEC 60664-1 / IEC 61984			
Clamping range, max.	mm ²	0.08...2.08	
Solid core H05(07) V-U	mm ²	0.5...1.5	
Stranded H07 V-R			
Flexible H05(07) V-K	mm ²	0.5...1.5	
Flexible with ferrule			
Ferrule with plastic collar	mm ²	0.5...0.75	
Stripping length	mm	5	
Screwdriver blade	mm	0.4 x 2.5	
According to norm		DIN 5264	
Tightening torque range	Nm	0.2...0.25	
Rated current, max.	A	16	14
At ambient temperature		20°C	40°C
For conductor cross-section			
Overtoltage category		III	III II
Pollution severity		3	2 2
Rated voltage	V	160	160 320
Rated impulse voltage	kV	2.5	2.5 2.5
UL / CUL (Use Group)		B	C D
Rated voltage	V	300	300
Rated current	A	10	10
AWG conductor	AWG	28-14	
CSA (Use Group)		B	C D
Rated voltage	V	300	300
Rated current	A	10	10
AWG conductor	AWG	28-14	
General data			
Type of insulation material		PA	
UL 94 flammability rating		V-2	
Contact base material		Copper alloy	
Material of contact surface		tinned	
Pin dimensions = d	mm	1.0 x 0.6	
Solder eyelet Ø = D	mm	1.3	
Solder eyelet Ø tolerance	mm	+ 0,1	

Accessories

Note: Refer to the Accessories chapter for additional accessories.

Screwdriver		Order No.
	SDS 0.4X2.5X75	2749320000
	SDIS 0.4X2.5X75	2749790000

G

3.50

90°

1.5 mm²

LM 3.5

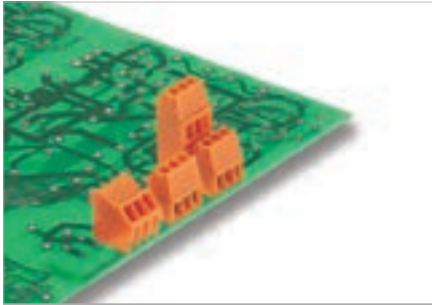

Small, compact PCB terminal with our proven clamping yoke screw connection in 3.5 mm pitch, suitable for wire cross-sections up to 1.5 mm².

- Wire outlet direction: 90° or 135° version.
- 2- and 3-pole block construction – can be aligned together for higher pole counts.

Product data

IEC: 320 V / 16 A / 0.5 - 1.5 mm²
UL: 300 V / 10 A / AWG 28 - 14



For additional articles and information, refer to catalog.weidmueller.com

Note:

- Additional variants on request
- Rated current related to rated cross-section & min. No. of poles.
- Max. outer diameter of the conductor: 2.9 mm
- Wire end ferrule with plastic collar to DIN 46228/4
- P on drawing = pitch
- Rated data refer only to the component itself. Clearance and creepage distances to other components are to be designed in accordance with the relevant application standards.
- It is necessary to hold the insulating body of the one or two pole terminal when tightening the screw
- Long term storage of the product with average temperature of 50 °C and average humidity 70%, 36 months

LM 3.5/.. /135



Dimensioned drawing

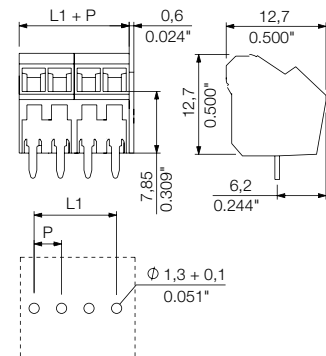

Technical data

In compliance with IEC 60664-1 / IEC 61984

Clamping range, max.	mm ²	0.08...2.08	
Solid core H05(07) V-U	mm ²	0.5...1.5	
Stranded H07 V-R			
Flexible H05(07) V-K	mm ²	0.5...1.5	
Flexible with ferrule			
Ferrule with plastic collar	mm ²	0.5...0.75	
Stripping length	mm	5	
Screwdriver blade	mm	0.4 x 2.5	
According to norm		DIN 5264	
Tightening torque range	Nm	0.2...0.25	
Rated current, max.	A	16	14
At ambient temperature		20°C	40°C
For conductor cross-section			
Overtoltage category		III	III II
Pollution severity		3	2 2
Rated voltage	V	160	160 320
Rated impulse voltage	kV	2.5	2.5 2.5
UL / CUL (Use Group)		B	C D
Rated voltage	V	300	300
Rated current	A	10	10
AWG conductor	AWG	28-14	
CSA (Use Group)		B	C D
Rated voltage	V	300	300
Rated current	A	10	10
AWG conductor	AWG	28-14	
General data			
Type of insulation material		PA	
UL 94 flammability rating		V-2	
Contact base material		Copper alloy	
Material of contact surface		tinned	
Pin dimensions = d	mm	1.0 x 0.6	
Solder eyelet Ø = D	mm	1.3	
Solder eyelet Ø tolerance	mm	+ 0,1	

Accessories

Note: Refer to the Accessories chapter for additional accessories.

Screwdriver		Order No.
	SDS 0.4X2.5X75	2749320000
	SDIS 0.4X2.5X75	2749790000

Ordering data

Solder pin length		3.2 mm		
Colour		orange		
Pitch		3.50 mm		
Pol.	L1	(inch)	Qty.	Order No.
2	3.50	0.138	100	1714980000
3	7.00	0.276	100	1715020000
4	10.50	0.413	100	1845220000
5	14.00	0.551	50	1845230000
6	17.50	0.689	50	1845240000
7	21.00	0.827	50	1845250000
8	24.50	0.965	50	1845260000
9	28.00	1.102	50	1845270000
10	31.50	1.240	50	1845280000
11	35.00	1.378	50	1845290000
12	38.50	1.516	50	1845300000

Representative deratings curve

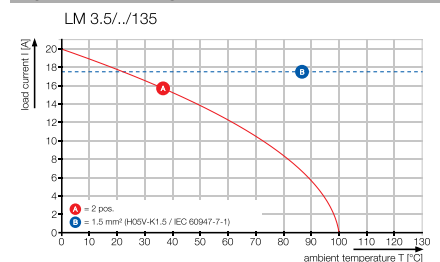

LM 3.5

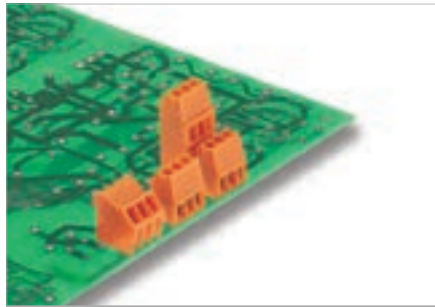

Small, compact PCB terminal with our proven clamping yoke screw connection in 3.5 mm pitch, suitable for wire cross-sections up to 1.5 mm².

- Wire outlet direction: 90° or 135° version.
- 2- and 3-pole block construction – can be aligned together for higher pole counts.

Product data

IEC: 320 V / 13 A / 0.5 - 1.5 mm²
 UL: 300 V / 10 A / AWG 28 - 14



For additional articles and information, refer to catalog.weidmueller.com

Note:

- Additional variants on request
- Rated current related to rated cross-section & min. No. of poles.
- Max. outer diameter of the conductor: 2.9 mm
- Wire end ferrule with plastic collar to DIN 46228/4
- P on drawing = pitch
- Rated data refer only to the component itself. Clearance and creepage distances to other components are to be designed in accordance with the relevant application standards.
- It is necessary to hold the insulating body of the one or two pole terminal when tightening the screw
- Long term storage of the product with average temperature of 50 °C and average humidity 70%, 36 months

LM1N 3.5/./90



Dimensioned drawing

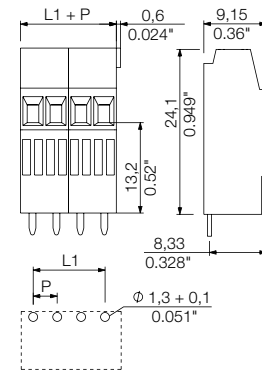

Ordering data

Solder pin length		3.2 mm		
Colour		orange		
Pitch		3.50 mm		
Pol.	L1	(inch)	Qty.	Order No.
2	3.50	0.138	100	1716710000
3	7.00	0.276	100	1716720000

Representative deratings curve

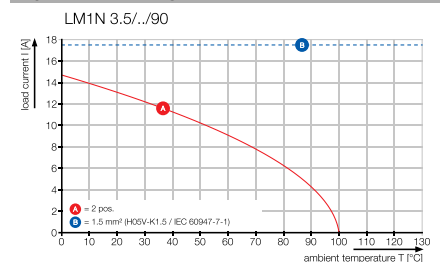

Technical data

In compliance with IEC 60664-1 / IEC 61984			
Clamping range, max.	mm ²	0.08...2.08	
Solid core H05(07) V-U	mm ²	0.5...1.5	
Stranded H07 V-R			
Flexible H05(07) V-K	mm ²	0.5...1.5	
Flexible with ferrule			
Ferrule with plastic collar	mm ²	0.5...0.75	
Stripping length	mm	5	
Screwdriver blade	mm	0.4 x 2.5	
According to norm		DIN 5264	
Tightening torque range	Nm	0.2...0.25	
Rated current, max.	A	13	11
At ambient temperature		20°C	40°C
For conductor cross-section			
Overtoltage category		III	III II
Pollution severity		3	2 2
Rated voltage	V	160	160 320
Rated impulse voltage	kV	2.5	2.5 2.5
UL / CUL (Use Group)		B	C D
Rated voltage	V	300	300
Rated current	A	10	10
AWG conductor	AWG	28-14	
CSA (Use Group)		B	C D
Rated voltage	V	300	300
Rated current	A	10	10
AWG conductor	AWG	28-14	
General data			
Type of insulation material		PA	
UL 94 flammability rating		V-2	
Contact base material		Copper alloy	
Material of contact surface		tinned	
Pin dimensions = d	mm	1.0 x 0.6	
Solder eyelet $\phi = D$	mm	1.3	
Solder eyelet ϕ tolerance	mm	+ 0,1	

Accessories

Note: Refer to the Accessories chapter for additional accessories.

Screwdriver		Order No.
	SDS 0.4X2.5X75	2749320000
	SDIS 0.4X2.5X75	2749790000



LM 3.5

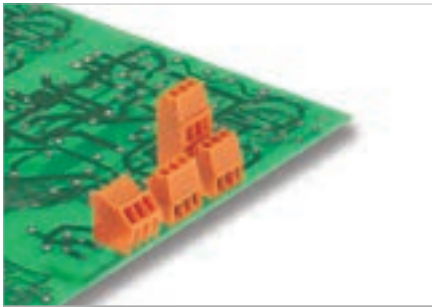

Small, compact PCB terminal with our proven clamping yoke screw connection in 3.5 mm pitch, suitable for wire cross-sections up to 1.5 mm².

- Wire outlet direction: 90° or 135° version.
- 2- and 3-pole block construction – can be aligned together for higher pole counts.

Technical data

In compliance with IEC 60664-1 / IEC 61984			
Clamping range, max.	mm ²	0.08...2.08	
Solid core H05(07) V-U	mm ²	0.5...1.5	
Stranded H07 V-R			
Flexible H05(07) V-K	mm ²	0.5...1.5	
Flexible with ferrule			
Ferrule with plastic collar	mm ²	0.5...0.75	
Stripping length	mm	5	
Screwdriver blade	mm	0.4 x 2.5	
According to norm		DIN 5264	
Tightening torque range	Nm	0.2...0.2	
Rated current, max.	A	13	11
At ambient temperature		20°C	40°C
For conductor cross-section			
Overtoltage category		III	III II
Pollution severity		3	2 2
Rated voltage	V	160	160 320
Rated impulse voltage	kV	2.5	2.5 2.5
UL / CUL (Use Group)		B	C D
Rated voltage	V	300	300
Rated current	A	10	10
AWG conductor	AWG	28-14	
CSA (Use Group)		B	C D
Rated voltage	V	300	300
Rated current	A	10	10
AWG conductor	AWG	28-14	
General data			
Type of insulation material		PA	
UL 94 flammability rating		V-2	
Contact base material		Copper alloy	
Material of contact surface		tinned	
Pin dimensions = d	mm	1.0 x 0.6	
Solder eyelet Ø = D	mm	1.3	
Solder eyelet Ø tolerance	mm	+ 0,1	

Product data

IEC: 320 V / 13 A / 0.5 - 1.5 mm²
 UL: 300 V / 10 A / AWG 28 - 14



For additional articles and information, refer to catalog.weidmueller.com

Note:

- Additional variants on request
- Rated current related to rated cross-section & min. No. of poles.
- Max. outer diameter of the conductor: 2.9 mm
- Wire end ferrule with plastic collar to DIN 46228/4
- P on drawing = pitch
- Rated data refer only to the component itself. Clearance and creepage distances to other components are to be designed in accordance with the relevant application standards.
- Long term storage of the product with average temperature of 50 °C and average humidity 70%, 36 months

LM2N 3.5/..90

multi-row



Dimensioned drawing

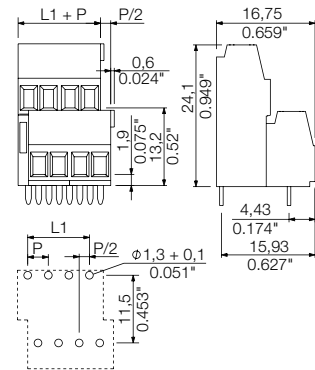

Ordering data

Solder pin length		3.2 mm		
Colour		orange		
Pitch		3.50 mm		
Pol.	L1	(inch)	Qty.	Order No.
4	3.50	0.138	100	1703700000
6	7.00	0.276	100	1703710000
8	10.50	0.413	100	1703720000
10	14.00	0.551	50	1703730000
12	17.50	0.689	50	1703740000
14	21.00	0.827	50	1703750000
16	24.50	0.965	50	1703760000
18	28.00	1.102	50	1703770000
20	31.50	1.240	50	1703780000
22	35.00	1.378	25	1703790000
24	38.50	1.516	25	1703800000

Accessories

Note: Refer to the Accessories chapter for additional accessories.

Screwdriver		Order No.
	SDS 0.4X2.5X75	2749320000
	SDIS 0.4X2.5X75	2749790000

Representative deratings curve

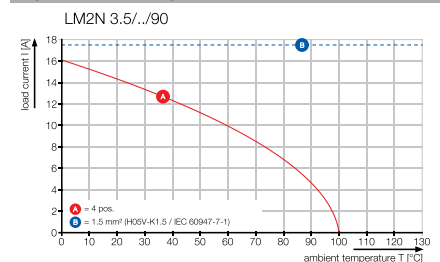

LS 5.08

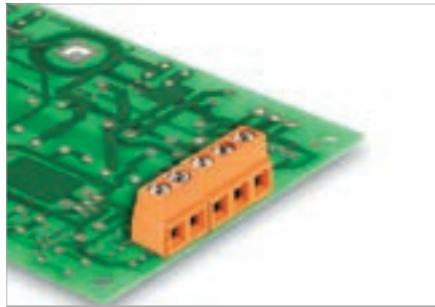

Small, compact PCB terminal with our proven clamping yoke screw connection in 5.08 mm pitch, suitable for wire cross-sections up to 1.5 mm².

- Increased derating reserves through the use of WEMID insulating material
- Wire outlet direction: 90° version
- 2- and 3-pole block construction – can be aligned together for higher pole counts.

Product data

IEC: 630 V / 17.5 A / 0.08 - 1.5 mm²
 UL: 300 V / 15 A / AWG 28 - 14



For additional articles and information, refer to catalog.weidmueller.com

Note:

- Rated current related to rated cross-section & min. No. of poles.
- Wire end ferrule without plastic collar to DIN 46228/1
- Wire end ferrule with plastic collar to DIN 46228/4
- P on drawing = pitch
- Rated data refer only to the component itself. Clearance and creepage distances to other components are to be designed in accordance with the relevant application standards.
- It is necessary to hold the insulating body of the one or two pole terminal when tightening the screw
- Long term storage of the product with average temperature of 50 °C and average humidity 70%, 36 months

LS 5.08/./90



Dimensioned drawing

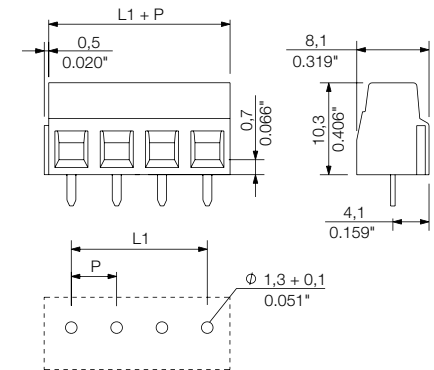

Ordering data

Solder pin length		3.5 mm		
Colour		orange		
Pitch		5.08 mm		
Pol.	L1	(inch)	Qty.	Order No.
2	5.08	0.200	100	1912520000
3	10.16	0.400	100	1912530000
4	15.24	0.600	100	1912540000
5	20.32	0.800	100	1912560000
6	25.40	1.000	100	1912570000
7	30.48	1.200	100	1912850000
8	35.56	1.400	100	1912890000
9	40.64	1.600	100	1912900000
10	45.72	1.800	50	1912910000
11	50.80	2.000	100	1912930000
12	55.88	2.200	100	1912940000

Representative deratings curve

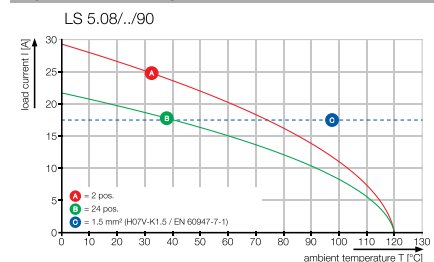

Technical data

In compliance with IEC 60664-1 / IEC 61984			
Clamping range, max.	mm ²	0.08...1.5	
Solid core H05(07) V-U	mm ²	0.08...1.5	
Stranded H07 V-R			
Flexible H05(07) V-K	mm ²	0.08...1.5	
Flexible with ferrule	mm ²	0.25...1.5	
Ferrule with plastic collar	mm ²	0.25...1.5	
Stripping length	mm	6	
Screwdriver blade	mm	0.6 x 3.5	
According to norm		DIN 5264	
Tightening torque range	Nm	0.4...0.5	
Rated current, max.	A	17.5	17.5
At ambient temperature		20°C	40°C
For conductor cross-section			
Overtoltage category		III	III II
Pollution severity		3	2 2
Rated voltage	V	250	320 630
Rated impulse voltage	kV	4	4 4
UL / CUL (Use Group)		B	C D
Rated voltage	V	300	300
Rated current	A	15	10
AWG conductor	AWG	28-14	
CSA (Use Group)		B	C D
Rated voltage	V	300	300
Rated current	A	20	10
AWG conductor	AWG	28-14	
General data			
Type of insulation material		Wemid (PA)	
UL 94 flammability rating		V-0	
Contact base material		Copper alloy	
Material of contact surface		tinned	
Pin dimensions = d	mm	0.5 x 1.0	
Solder eyelet Ø = D	mm	1.3	
Solder eyelet Ø tolerance	mm	+ 0,1	

Accessories

Note: Refer to the Accessories chapter for additional accessories.

Screwdriver		Order No.
	SDS 0.6X3.5X100	2749340000
	SDIS 0.6X3.5X100	2749810000



LM 5.00

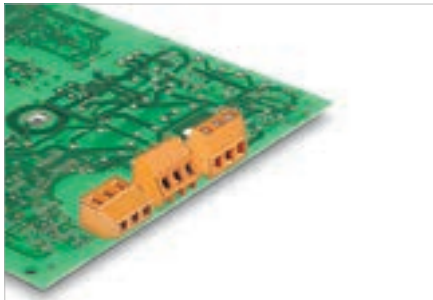

Single-row PCB terminal with our proven clamping-yoke screw connection in 5.00 mm pitch, suitable for wire cross-sections up to 2.5 mm².

- Increased derating reserves through the use of WEMID insulating material
- Wire outlet direction: 90°, 135° or 180° version.
- 2- and 3-pole block construction – can be aligned together for higher pole counts.

Product data

IEC: 630 V / 17.5 A / 0.2 - 2.5 mm²
 UL: 300 V / 15 A / AWG 24 - 14



For additional articles and information, refer to catalog.weidmueller.com

Note:

- Rated current related to rated cross-section & min. No. of poles.
- Wire end ferrule without plastic collar to DIN 46228/1
- Wire end ferrule with plastic collar to DIN 46228/4
- P on drawing = pitch
- Rated data refer only to the component itself. Clearance and creepage distances to other components are to be designed in accordance with the relevant application standards.
- It is necessary to hold the insulating body of the one or two pole terminal when tightening the screw
- Long term storage of the product with average temperature of 50 °C and average humidity 70%, 36 months

LM 5.00/..90



Dimensioned drawing

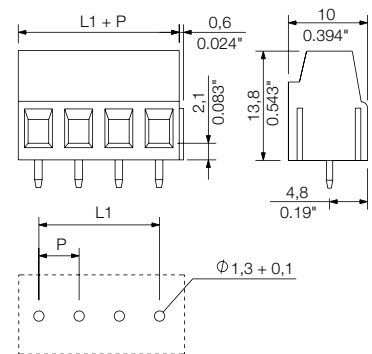

Technical data

In compliance with IEC 60664-1 / IEC 61984			
Clamping range, max.	mm ²	0.2...2.5	
Solid core H05(07) V-U	mm ²	0.2...2.5	
Stranded H07 V-R			
Flexible H05(07) V-K	mm ²	0.2...2.5	
Flexible with ferrule	mm ²	0.25...1.5	
Ferrule with plastic collar	mm ²	0.25...1.5	
Stripping length	mm	6	
Screwdriver blade	mm	0.6 x 3.5	
According to norm		DIN 5264	
Tightening torque range	Nm	0.4...0.5	
Rated current, max.	A	17.5	17.5
At ambient temperature		20°C	40°C
For conductor cross-section			
Overtoltage category		III	III II
Pollution severity		3	2 2
Rated voltage	V	250	320 630
Rated impulse voltage	kV	4	4 4
UL / CUL (Use Group)		B	C D
Rated voltage	V	300	300
Rated current	A	15	10
AWG conductor	AWG	24-14	
CSA (Use Group)		B	C D
Rated voltage	V	300	300
Rated current	A	18	10
AWG conductor	AWG	24-14	
General data			
Type of insulation material		Wemid (PA)	
UL 94 flammability rating		V-0	
Contact base material		Copper alloy	
Material of contact surface		tinned	
Pin dimensions = d	mm	0.95 x 0.8	
Solder eyelet Ø = D	mm	1.3	
Solder eyelet Ø tolerance	mm	+ 0,1	

Accessories

Note: Refer to the Accessories chapter for additional accessories.

Screwdriver		Order No.
	SDS 0.6X3.5X100	2749340000
	SDIS 0.6X3.5X100	2749810000

Ordering data

Solder pin length		3.5 mm		
Colour		orange		
Pitch	5.00 mm			
Pol.	L1	(inch)	Qty.	Order No.
2	5.00	0.197	500	1715310000
3	10.00	0.394	500	1715320000
4	15.00	0.591	50	1821490000
5	20.00	0.787	50	1845310000
6	25.00	0.984	50	1845320000
7	30.00	1.181	50	1845330000
8	35.00	1.378	50	1845340000
9	40.00	1.575	50	1845350000
10	45.00	1.772	50	1845360000
11	50.00	1.969	50	1845370000
12	55.00	2.165	50	1845380000

Representative deratings curve

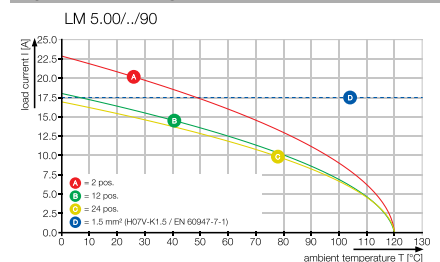

LM 5.00../135



Dimensioned drawing

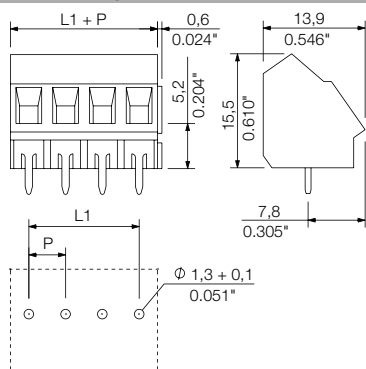

Ordering data

Solder pin length		3.5 mm			
Colour		orange			
Pitch		5.00 mm			
Pol.	L1	(inch)	Qty.	Order No.	
2	5.00	0.197	500	1715350000	
3	10.00	0.394	500	1715360000	
4	15.00	0.591	50	1845390000	
5	20.00	0.787	50	1845400000	
6	25.00	0.984	50	1845410000	
7	30.00	1.181	50	1845420000	
8	35.00	1.378	50	1845430000	
9	40.00	1.575	50	1845440000	
10	45.00	1.772	50	1845450000	
11	50.00	1.969	50	1845460000	
12	55.00	2.165	50	1845470000	

LM 5.00../180



Dimensioned drawing

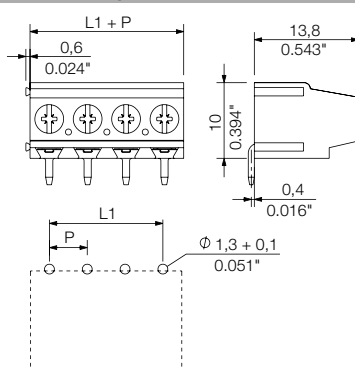

Ordering data

Solder pin length		3.5 mm			
Colour		orange			
Pitch		5.00 mm			
Pol.	L1	(inch)	Qty.	Order No.	
2	5.00	0.197	500	1715330000	
3	10.00	0.394	500	1715340000	
4	15.00	0.591	50	1234230000	
5	20.00	0.787	50	1234240000	
6	25.00	0.984	50	1234250000	
7	30.00	1.181	50	1234270000	
8	35.00	1.378	50	1234280000	
9	40.00	1.575	50	1234290000	
10	45.00	1.772	50	1234310000	
11	50.00	1.969	50	1234320000	
12	55.00	2.165	50	1234330000	

Additional deratings curves

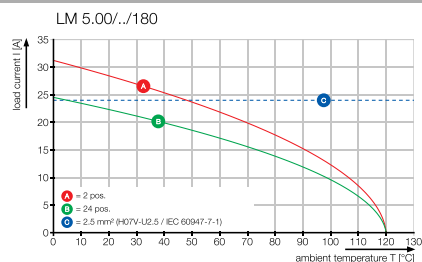
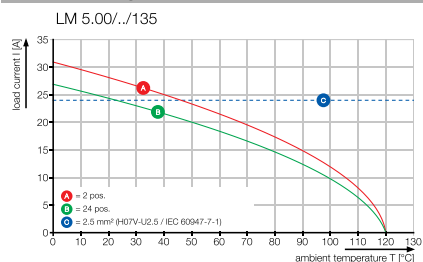

LM 5.08

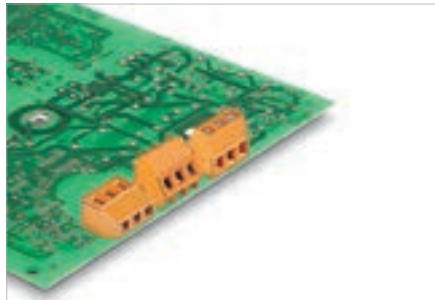

Single-row PCB terminal with our proven clamping-yoke screw connection in 5.08 mm pitch, suitable for wire cross-sections up to 2.5 mm².

- Increased derating reserves through the use of WEMID insulating material
- Wire outlet direction: 90°, 135° or 180° version.
- 2- and 3-pole block construction – can be aligned together for higher pole counts.

Product data

IEC: 630 V / 17.5 A / 0.2 - 2.5 mm²
 UL: 300 V / 15 A / AWG 24 - 14



For additional articles and information, refer to catalog.weidmueller.com

Note:

- Rated current related to rated cross-section & min. No. of poles.
- Wire end ferrule without plastic collar to DIN 46228/1
- Wire end ferrule with plastic collar to DIN 46228/4
- P on drawing = pitch
- Rated data refer only to the component itself. Clearance and creepage distances to other components are to be designed in accordance with the relevant application standards.
- It is necessary to hold the insulating body of the one or two pole terminal when tightening the screw
- Long term storage of the product with average temperature of 50 °C and average humidity 70%, 36 months

LM 5.08/..90



Dimensioned drawing

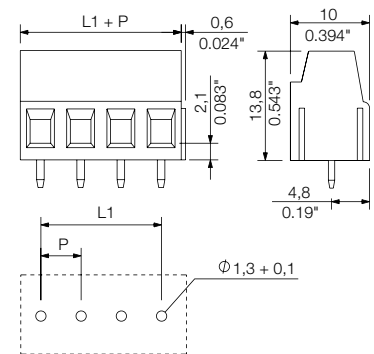

Technical data

In compliance with IEC 60664-1 / IEC 61984			
Clamping range, max.	mm ²	0.2...2.5	
Solid core H05(07) V-U	mm ²	0.2...2.5	
Stranded H07 V-R			
Flexible H05(07) V-K	mm ²	0.2...2.5	
Flexible with ferrule	mm ²	0.25...1.5	
Ferrule with plastic collar	mm ²	0.25...1.5	
Stripping length	mm	6	
Screwdriver blade	mm	0.6 x 3.5	
According to norm		DIN 5264	
Tightening torque range	Nm	0.4...0.5	
Rated current, max.	A	17.5	17.5
At ambient temperature		20°C	40°C
For conductor cross-section			
Overtoltage category		III	III II
Pollution severity		3	2 2
Rated voltage	V	250	320 630
Rated impulse voltage	kV	4	4 4
UL / CUL (Use Group)		B	C D
Rated voltage	V	300	300
Rated current	A	15	10
AWG conductor	AWG	24-14	
CSA (Use Group)		B	C D
Rated voltage	V	300	300
Rated current	A	18	10
AWG conductor	AWG	24-14	
General data			
Type of insulation material		Wemid (PA)	
UL 94 flammability rating		V-0	
Contact base material		Copper alloy	
Material of contact surface		tinned	
Pin dimensions = d	mm	0.95 x 0.8	
Solder eyelet Ø = D	mm	1.3	
Solder eyelet Ø tolerance	mm	+ 0,1	

Accessories

Note: Refer to the Accessories chapter for additional accessories.

Screwdriver		Order No.
	SDS 0.6X3.5X100	2749340000
	SDIS 0.6X3.5X100	2749810000

Ordering data

Solder pin length		3.5 mm		
Colour		orange		
Pitch		5.08 mm		
Pol.	L1	(inch)	Qty.	Order No.
2	5.08	0.200	500	1716080000
3	10.16	0.400	500	1716090000
4	15.24	0.600	50	9994130000
5	20.32	0.800	50	9994140000
6	25.40	1.000	50	9994150000
7	30.48	1.200	50	9994160000
8	35.56	1.400	50	9994170000
9	40.64	1.600	50	9994180000
10	45.72	1.800	50	9994190000
11	50.80	2.000	50	9994200000
12	55.88	2.200	50	9994210000

Representative deratings curve

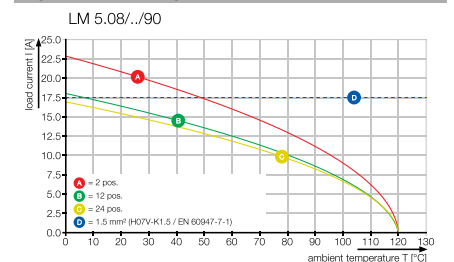

LM 5.08../135



Dimensioned drawing

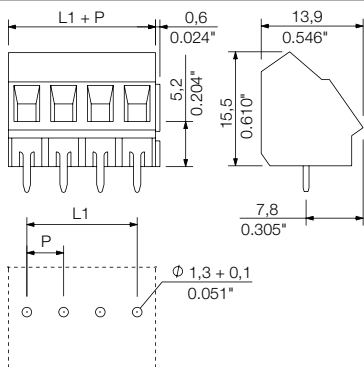

Ordering data

Solder pin length		3.5 mm			
Colour		orange			
Pitch		5.08 mm			
Pol.	L1	(inch)	Qty.	Order No.	
2	5.08	0.200	500	1716120000	
3	10.16	0.400	500	1716130000	
4	15.24	0.600	50	9994550000	
5	20.32	0.800	50	9994560000	
6	25.40	1.000	50	9994570000	
7	30.48	1.200	50	9994580000	
8	35.56	1.400	50	9994590000	
9	40.64	1.600	50	9994600000	
10	45.72	1.800	50	9994610000	
11	50.80	2.000	50	9994620000	
12	55.88	2.200	50	9994630000	

LM 5.08../180



Dimensioned drawing

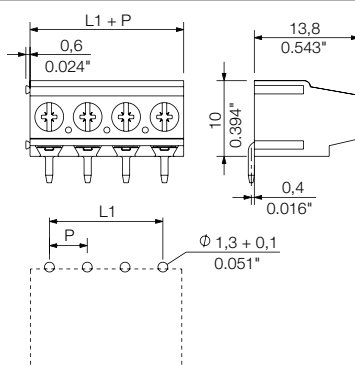

Ordering data

Solder pin length		3.5 mm			
Colour		orange			
Pitch		5.08 mm			
Pol.	L1	(inch)	Qty.	Order No.	
2	5.08	0.200	500	1716100000	
3	10.16	0.400	500	1716110000	
4	15.24	0.600	50	9994970000	
5	20.32	0.800	50	9994980000	
6	25.40	1.000	50	9994990000	
7	30.48	1.200	50	9995000000	
8	35.56	1.400	50	9995010000	
9	40.64	1.600	50	9995020000	
10	45.72	1.800	50	9995030000	
11	50.80	2.000	50	9995040000	
12	55.88	2.200	50	9995050000	

Additional deratings curves

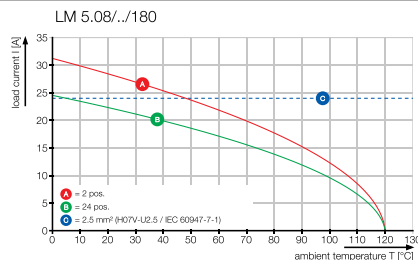
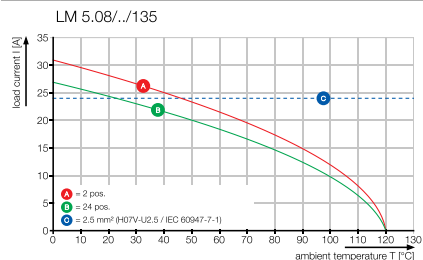

LM 5.08, multi-level

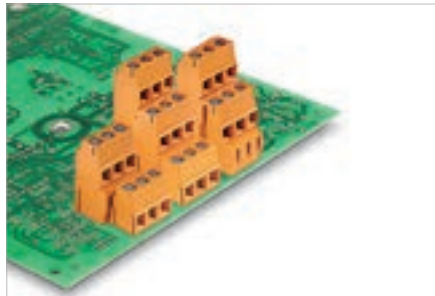

Multi-level PCB terminal with our proven clamping yoke screw connection in 5.08 mm pitch, suitable for wire cross-sections up to 2.5 mm².

- Increased derating reserves through the use of WEMID insulating material
- Wire outlet direction: 90° version
- Block construction – can be aligned together for higher pole counts.

Technical data

In compliance with IEC 60664-1 / IEC 61984			
Clamping range, max.	mm ²	0.2...2.5	
Solid core H05(07) V-U	mm ²	0.2...2.5	
Stranded H07 V-R			
Flexible H05(07) V-K	mm ²	0.2...2.5	
Flexible with ferrule	mm ²	0.25...1.5	
Ferrule with plastic collar	mm ²	0.25...1.5	
Stripping length	mm	6	
Screwdriver blade	mm	0.6 x 3.5	
According to norm		DIN 5264	
Tightening torque range	Nm	0.4...0.5	
Rated current, max.	A	17.5	17.5
At ambient temperature		20°C	40°C
For conductor cross-section			
Overtoltage category		III	III II
Pollution severity		3	2 2
Rated voltage	V	250	320 630
Rated impulse voltage	kV	4	4 4
UL / CUL (Use Group)		B	C D
Rated voltage	V	300	300
Rated current	A	15	10
AWG conductor	AWG	24-14	
CSA (Use Group)		B	C D
Rated voltage	V	300	300
Rated current	A	18	10
AWG conductor	AWG	24-14	
General data			
Type of insulation material		Wemid (PA)	
UL 94 flammability rating		V-0	
Contact base material		Copper alloy	
Material of contact surface		tinned	
Pin dimensions = d	mm	0.95 x 0.8	
Solder eyelet Ø = D	mm	1.3	
Solder eyelet Ø tolerance	mm	+ 0,1	

Product data

IEC: 630 V / 17.5 A / 0.2 - 2.5 mm²
 UL: 300 V / 15 A / AWG 24 - 14



For additional articles and information, refer to catalog.weidmueller.com

Note:

- Rated current related to rated cross-section & min. No. of poles.
- Wire end ferrule without plastic collar to DIN 46228/1
- Wire end ferrule with plastic collar to DIN 46228/4
- P on drawing = pitch
- Rated data refer only to the component itself. Clearance and creepage distances to other components are to be designed in accordance with the relevant application standards.
- It is necessary to hold the insulating body of the one or two pole terminal when tightening the screw
- Long term storage of the product with average temperature of 50 °C and average humidity 70%, 36 months

LM1N 5.08/..90

single row medium



Dimensioned drawing

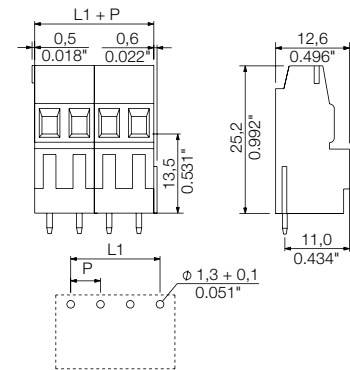

Ordering data

Solder pin length		3.5 mm	
Colour		orange	
Pitch		5.08 mm	
Pol.	L1	(inch)	Qty. Order No.
2	5.08	0.200	100 1766300000
3	10.16	0.400	100 1766310000

Accessories

Note: Refer to the Accessories chapter for additional accessories.

Screwdriver		Order No.
	SDS 0.6X3.5X100	2749340000
	SDIS 0.6X3.5X100	2749810000

Representative deratings curve

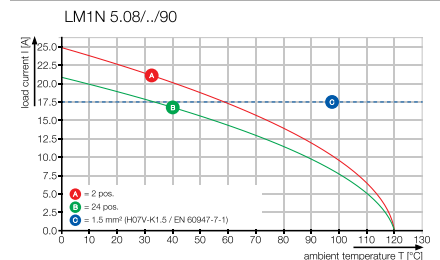

LM1H 5.08/./90

single row high



Dimensioned drawing

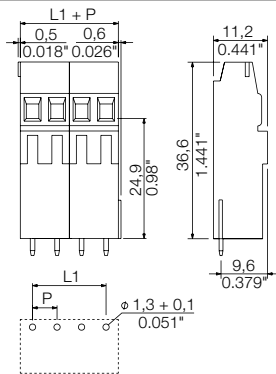

Ordering data

Solder pin length		3.5 mm	
Colour		orange	
Pitch		5.08 mm	
Pol.	L1	(inch)	Qty. Order No.
2	5.08	0.200	100 1766360000
3	10.16	0.400	100 1766370000

Additional deratings curves

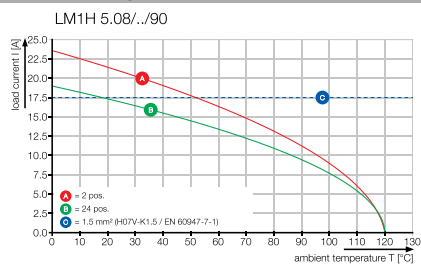

LM 5.08, multi-level

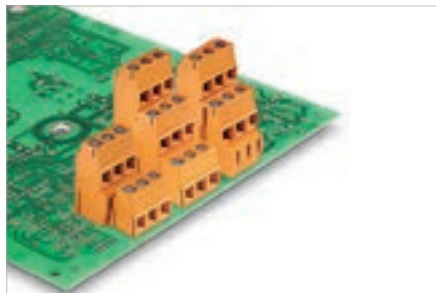

Multi-level PCB terminal with our proven clamping yoke screw connection in 5.08 mm pitch, suitable for wire cross-sections up to 2.5 mm².

- Increased derating reserves through the use of WEMID insulating material
- Wire outlet direction: 90° version
- Block construction – can be aligned together for higher pole counts.

Technical data

In compliance with IEC 60664-1 / IEC 61984			
Clamping range, max.	mm ²	0.2...2.5	
Solid core H05(07) V-U	mm ²	0.2...2.5	
Stranded H07 V-R			
Flexible H05(07) V-K	mm ²	0.2...2.5	
Flexible with ferrule	mm ²	0.25...1.5	
Ferrule with plastic collar	mm ²	0.25...1.5	
Stripping length	mm	6	
Screwdriver blade	mm	0.6 x 3.5	
According to norm		DIN 5264	
Tightening torque range	Nm	0.4...0.5	
Rated current, max.	A	17.5	17.5
At ambient temperature		20°C	40°C
For conductor cross-section			
Overtoltage category		III	III II
Pollution severity		3	2 2
Rated voltage	V	250	320 630
Rated impulse voltage	kV	4	4 4
UL / CUL (Use Group)		B	C D
Rated voltage	V	300	300
Rated current	A	15	10
AWG conductor	AWG	24-14	
CSA (Use Group)		B	C D
Rated voltage	V	300	300
Rated current	A	18	10
AWG conductor	AWG	24-14	
General data			
Type of insulation material		Wemid (PA)	
UL 94 flammability rating		V-0	
Contact base material		Copper alloy	
Material of contact surface		tinned	
Pin dimensions = d	mm	0.95 x 0.8	
Solder eyelet Ø = D	mm	1.3	
Solder eyelet Ø tolerance	mm	+ 0,1	

Product data

IEC: 630 V / 17.5 A / 0.2 - 2.5 mm²
 UL: 300 V / 15 A / AWG 24 - 14



For additional articles and information, refer to catalog.weidmueller.com

Note:

- Rated current related to rated cross-section & min. No. of poles.
- Wire end ferrule without plastic collar to DIN 46228/1
- Wire end ferrule with plastic collar to DIN 46228/4
- P on drawing = pitch
- Rated data refer only to the component itself. Clearance and creepage distances to other components are to be designed in accordance with the relevant application standards.
- Long term storage of the product with average temperature of 50 °C and average humidity 70%, 36 months

LM2N 5.08/..90

double row low



Dimensioned drawing

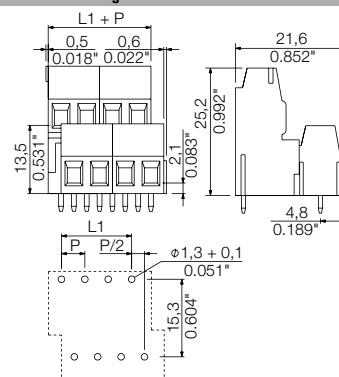

Ordering data

Solder pin length		3.5 mm		
Colour		orange		
Pitch		5.08 mm		
Pol.	L1	(inch)	Qty.	Order No.
4	5.08	0.200	92	1768850000
6	10.16	0.400	64	1768860000
8	15.24	0.600	56	1768870000
10	20.32	0.800	44	1768880000
12	25.40	1.000	36	1768890000
14	30.48	1.200	32	1768900000
16	35.56	1.400	28	1768910000
18	40.64	1.600	24	1768920000
20	45.72	1.800	20	1768930000
22	50.80	2.000	20	1768940000
24	55.88	2.200	16	1768950000

Representative deratings curve

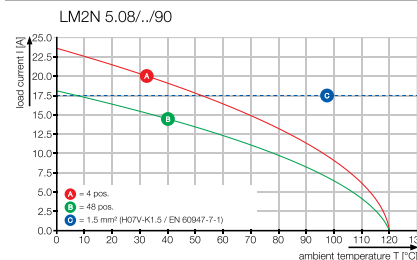

LM2H 5.08/./90

double row high



Dimensioned drawing

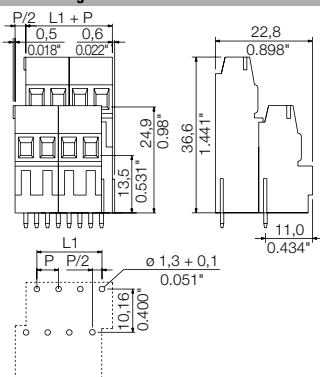

Ordering data

Solder pin length		3.5 mm			
Colour		orange			
Pitch		5.08 mm			
Pol.	L1	(inch)	Qty.	Order No.	
4	5.08	0.200	50	1769240000	
6	10.16	0.400	50	1769250000	
8	15.24	0.600	50	1769260000	
10	20.32	0.800	50	1769270000	
12	25.40	1.000	20	1769280000	
14	30.48	1.200	20	1769290000	
16	35.56	1.400	20	1769300000	
18	40.64	1.600	20	1769310000	
20	45.72	1.800	20	1769320000	
22	50.80	2.000	20	1769330000	
24	55.88	2.200	10	1769340000	

LM3R 5.08/./90

triple row



Dimensioned drawing

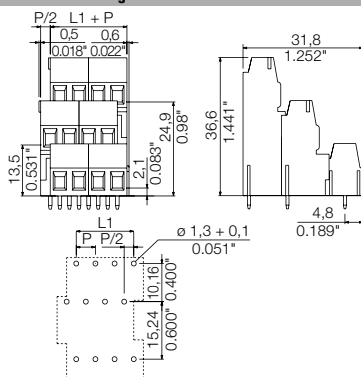

Ordering data

Solder pin length		3.5 mm			
Colour		orange			
Pitch		5.08 mm			
Pol.	L1	(inch)	Qty.	Order No.	
6	5.08	0.200	50	1769620000	
9	10.16	0.400	50	1769630000	
12	15.24	0.600	50	1769640000	
15	20.32	0.800	25	1769650000	
18	25.40	1.000	25	1769660000	
21	30.48	1.200	20	1769670000	
24	35.56	1.400	20	1769680000	
27	40.64	1.600	20	1769690000	
30	45.72	1.800	10	1769700000	
33	50.80	2.000	10	1769710000	
36	55.88	2.200	10	1769720000	

Additional deratings curves

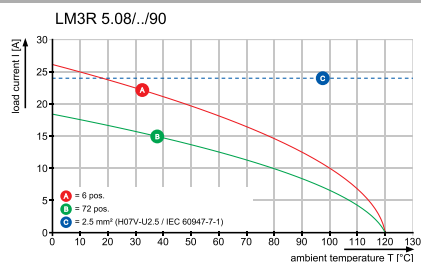
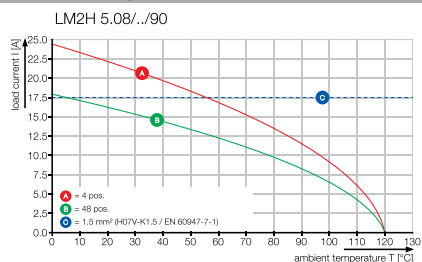

LL 5.00 & LL 5.08

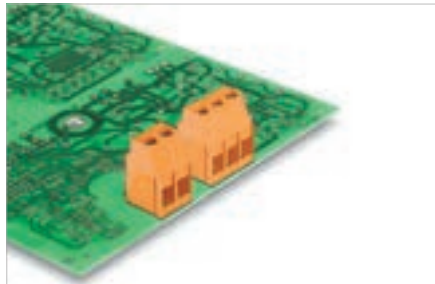

Single-row PCB terminal with our proven clamping yoke screw connection in 5.00 and 5.08 mm pitches, suitable for wire cross-sections up to 6.0 mm².

- Increased derating reserves through the use of WEMID insulating material
- Wire outlet direction: 90° version
- 2- and 3-pole block construction – can be aligned together for higher pole counts.

Product data

IEC: 500 V / 32.5 A / 0.5 - 6 mm²
 UL: 300 V / 20 A / AWG 26 - 12



For additional articles and information, refer to catalog.weidmuller.com

Note:

- Rated current related to rated cross-section & min. No. of poles.
- Wire end ferrule without plastic collar to DIN 46228/1
- Wire end ferrule with plastic collar to DIN 46228/4
- P on drawing = pitch
- Rated data refer only to the component itself. Clearance and creepage distances to other components are to be designed in accordance with the relevant application standards.
- It is necessary to hold the insulating body of the one or two pole terminal when tightening the screw
- Long term storage of the product with average temperature of 50 °C and average humidity 70%, 36 months

LL 5.00/./90



Dimensioned drawing

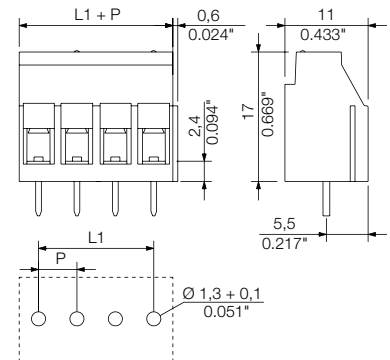

Ordering data

Solder pin length		3.2 mm	
Colour		orange	
Pitch	5.00 mm		
Pol.	L1	(inch)	Qty. Order No.
2	5.00	0.197	100 1934270000
3	10.00	0.394	100 1934280000
4	15.00	0.591	100 1001720000
5	20.00	0.788	50 1001730000
6	25.00	0.985	50 1001740000
7	30.00	1.182	50 1001750000
8	35.00	1.379	50 1001760000
9	40.00	1.576	50 1001770000
10	45.00	1.773	50 1001780000
11	50.00	1.970	50 1001790000
12	55.00	2.167	50 1001800000

Representative deratings curve

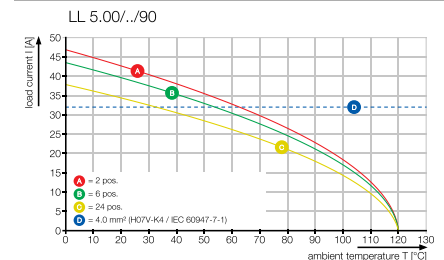

Technical data

In compliance with IEC 60664-1 / IEC 61984			
Clamping range, max.	mm ²	0.13...6	
Solid core H05(07) V-U	mm ²	0.5...6	
Stranded H07 V-R			
Flexible H05(07) V-K	mm ²	0.5...4	
Flexible with ferrule	mm ²	0.5...2.5	
Ferrule with plastic collar	mm ²	0.5...2.5	
Stripping length	mm	6	
Screwdriver blade	mm	0.6 x 3.5	
According to norm		DIN 5264	
Tightening torque range	Nm	0.5...0.6	
Rated current, max.	A	32.5	27.5
At ambient temperature		20°C	40°C
For conductor cross-section			
Overtoltage category		III	III II
Pollution severity		3	2 2
Rated voltage	V	250	320 500
Rated impulse voltage	kV	4	4 4
UL / CUL (Use Group)		B	C D
Rated voltage	V	300	300
Rated current	A	20	10
AWG conductor	AWG	26-12	
CSA (Use Group)		B	C D
Rated voltage	V	300	300
Rated current	A	20	10
AWG conductor	AWG	26-12	
General data			
Type of insulation material		Wemid (PA)	
UL 94 flammability rating		V-0	
Contact base material		Copper alloy	
Material of contact surface		tinned	
Pin dimensions = d	mm	0.75 x 0.9	
Solder eyelet Ø = D	mm	1.3	
Solder eyelet Ø tolerance	mm	+ 0,1	

Accessories

Note: Refer to the Accessories chapter for additional accessories.

Screwdriver		Order No.
	SDS 0.6X3.5X100	2749340000
	SDIS 0.6X3.5X100	2749810000

LL 5.08/./90



Dimensioned drawing

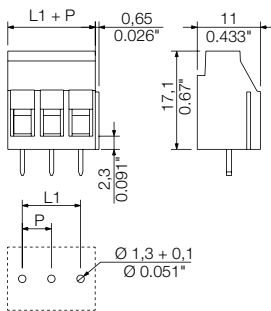

Ordering data

Solder pin length		3.2 mm	
Colour		orange	
Pitch		5.08 mm	
Pol.	L1	(inch)	Qty. Order No.
2	5.08	0.200	100 1934250000
3	10.16	0.400	100 1934260000
4	15.24	0.600	100 1001850000
5	20.32	0.800	50 1001860000
6	25.40	1.000	50 1001870000
7	30.48	1.200	50 1001880000
8	35.56	1.400	50 1001890000
9	40.64	1.600	50 1001900000
10	45.72	1.800	50 1001910000
11	50.80	2.000	50 1001920000
12	55.88	2.200	50 1001930000

LL 5.00/./180



Dimensioned drawing

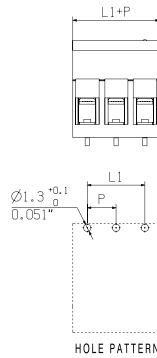

Ordering data

Solder pin length		3.2 mm	
Colour		orange	
Pitch		5.00 mm	
Pol.	L1	(inch)	Qty. Order No.
2	5.00	0.197	174 1994230000
3	10.00	0.394	114 1994240000
4	15.00	0.591	90 2429470000
5	20.00	0.788	72 2429530000
6	25.00	0.985	60 2429540000
7	30.00	1.182	48 2429550000
8	35.00	1.379	42 2429560000
9	40.00	1.576	36 2429570000
10	45.00	1.773	36 2429580000
11	50.00	1.970	30 2429590000
12	55.00	2.167	30 2429600000

LL 5.08/./180



Dimensioned drawing

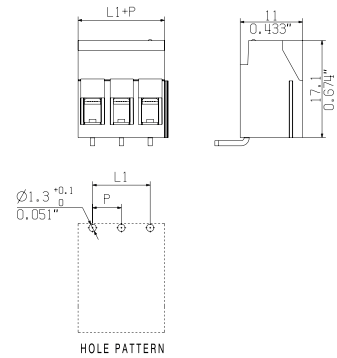

Ordering data

Solder pin length		3.2 mm	
Colour		orange	
Pitch		5.08 mm	
Pol.	L1	(inch)	Qty. Order No.
2	5.08	0.200	168 1994250000
3	10.16	0.400	114 1994260000
4	15.24	0.600	84 2429810000
5	20.32	0.800	66 2431930000
6	25.40	1.000	60 2431950000
7	30.48	1.200	48 2431960000
8	35.56	1.400	42 2431970000
9	40.64	1.600	36 2431980000
10	45.72	1.800	36 2431990000
11	50.80	2.000	30 2432000000
12	55.88	2.200	30 2432010000

Additional deratings curves

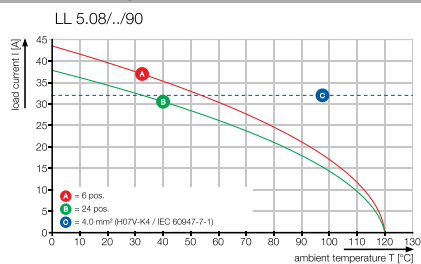

LL 5.00, multi-level

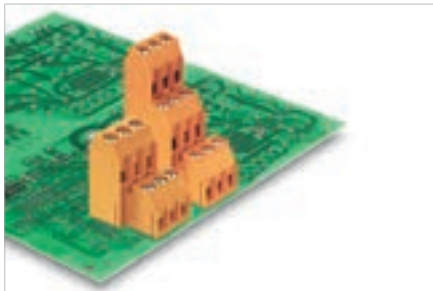

Multi-level PCB terminal with our proven clamping yoke screw connection in 5.00 mm pitch, suitable for wire cross-sections up to 6 mm².

- Increased derating reserves through the use of WEMID insulating material
- Wire outlet direction: 90° version
- Block construction – can be aligned together for higher pole counts.

Product data

IEC: 500 V / 32.5 A / 0.5 - 6 mm²
 UL: 300 V / 20 A / AWG 26 - 12



For additional articles and information, refer to catalog.weidmueller.com

Note:

- Rated current related to rated cross-section & min. No. of poles.
- Wire end ferrule without plastic collar to DIN 46228/1
- Wire end ferrule with plastic collar to DIN 46228/4
- P on drawing = pitch
- Rated data refer only to the component itself. Clearance and creepage distances to other components are to be designed in accordance with the relevant application standards.
- It is necessary to hold the insulating body of the one or two pole terminal when tightening the screw
- Long term storage of the product with average temperature of 50 °C and average humidity 70%, 36 months

LL1N 5.00/.. /90



Dimensioned drawing

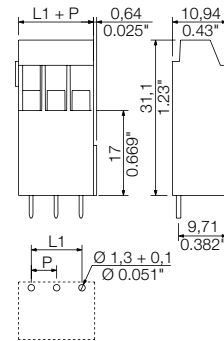

Technical data

In compliance with IEC 60664-1 / IEC 61984			
Clamping range, max.	mm ²	0.08...6	
Solid core H05(07) V-U	mm ²	0.5...6	
Stranded H07 V-R			
Flexible H05(07) V-K	mm ²	0.5...4	
Flexible with ferrule	mm ²	0.5...2.5	
Ferrule with plastic collar	mm ²	0.5...2.5	
Stripping length	mm	6	
Screwdriver blade	mm	0.6 x 3.5	
According to norm		DIN 5264	
Tightening torque range	Nm	0.5...0.6	
Rated current, max.	A	32.5	27.5
At ambient temperature		20°C	40°C
For conductor cross-section			
Overtoltage category		III	III II
Pollution severity		3	2 2
Rated voltage	V	250	320 500
Rated impulse voltage	kV	4	4 4
UL / CUL (Use Group)		B	C D
Rated voltage	V	300	300
Rated current	A	20	10
AWG conductor	AWG	26-12	
CSA (Use Group)		B	C D
Rated voltage	V	300	300
Rated current	A	20	10
AWG conductor	AWG	26-12	
General data			
Type of insulation material		Wemid (PA)	
UL 94 flammability rating		V-0	
Contact base material		Copper alloy	
Material of contact surface		tinned	
Pin dimensions = d	mm	0.75 x 0.9	
Solder eyelet Ø = D	mm	1.3	
Solder eyelet Ø tolerance	mm	+ 0,1	

Accessories

Note: Refer to the Accessories chapter for additional accessories.

Screwdriver		Order No.
	SDS 0.6X3.5X100	2749340000
	SDIS 0.6X3.5X100	2749810000

Ordering data

Solder pin length		3.2 mm		
Colour		orange		
Pitch		5.00 mm		
Pol.	L1	(inch)	Qty.	Order No.
2	5.00	0.197	100	1975250000
3	10.00	0.394	100	1975260000
4	15.00	0.591	100	1975270000
5	20.00	0.788	50	1975280000
6	25.00	0.985	50	1975290000
7	30.00	1.182	50	1975300000
8	35.00	1.379	50	1975310000
9	40.00	1.576	50	1975320000
10	45.00	1.773	50	1975330000
11	50.00	1.970	50	1975340000
12	55.00	2.167	50	1975350000

Representative deratings curve

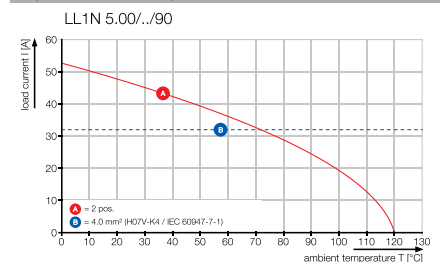

LL2N 5.00/./90



Dimensioned drawing

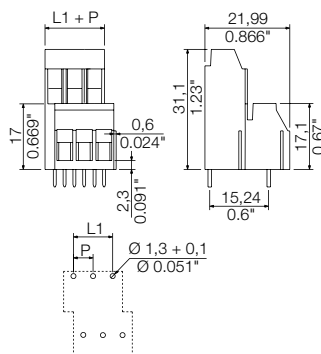

Ordering data

Solder pin length		3.2 mm			
Colour		orange			
Pitch		5.00 mm			
Pol.	L1	(inch)	Qty.	Order No.	
4	12.50	0.492	50	1934310000	
8	22.50	0.886	50	1977260000	
12	32.50	1.280	50	1977280000	
16	42.50	1.673	20	1977310000	
20	52.50	2.067	20	1977330000	
24	62.50	2.461	10	1977350000	

LL3R 5.00/./90



Dimensioned drawing

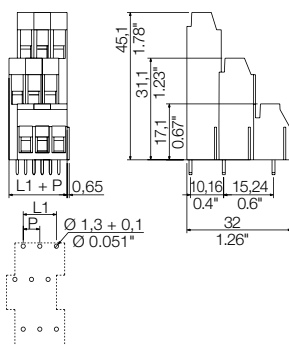

Ordering data

Solder pin length		3.2 mm			
Colour		orange			
Pitch		5.00 mm			
Pol.	L1	(inch)	Qty.	Order No.	
6	5.00	0.492	50	1934360000	
12	15.00	0.886	50	1978850000	
18	25.00	1.280	25	1978870000	
24	35.00	1.673	20	1978890000	
30	45.00	2.067	10	1978910000	
36	55.00	2.461	10	1978930000	

Additional deratings curves

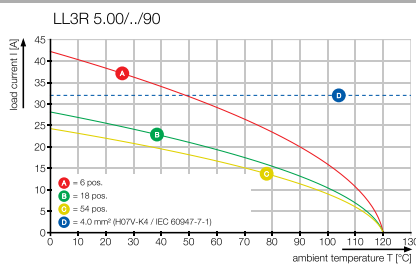
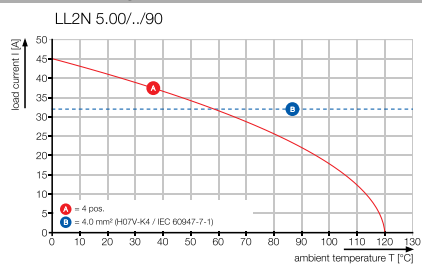

LL 5.08, multi-level

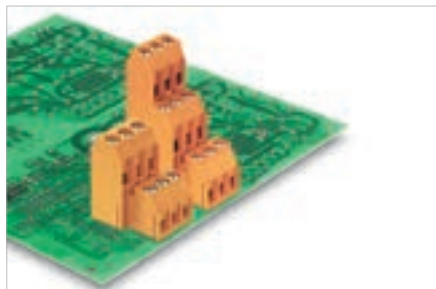

Multi-level PCB terminal with our proven clamping yoke screw connection in 5.08 mm pitch, suitable for wire cross-sections up to 6 mm².

- Increased derating reserves through the use of WEMID insulating material
- Wire outlet direction: 90° version
- Block construction can be aligned together for higher pole counts.

Product data

IEC: 500 V / 32.5 A / 0.5 - 6 mm²
 UL: 300 V / 20 A / AWG 26 - 12



For additional articles and information, refer to catalog.weidmueller.com

Note:

- Rated current related to rated cross-section & min. No. of poles.
- Wire end ferrule without plastic collar to DIN 46228/1
- Wire end ferrule with plastic collar to DIN 46228/4
- P on drawing = pitch
- Rated data refer only to the component itself. Clearance and creepage distances to other components are to be designed in accordance with the relevant application standards.
- It is necessary to hold the insulating body of the one or two pole terminal when tightening the screw
- Long term storage of the product with average temperature of 50 °C and average humidity 70%, 36 months

LL1N 5.08../90



Dimensioned drawing

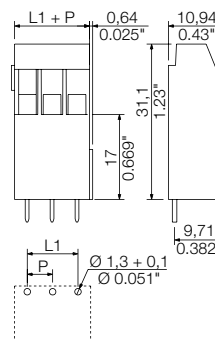

Technical data

In compliance with IEC 60664-1 / IEC 61984			
Clamping range, max.	mm ²	0.08...6	
Solid core H05(07) V-U	mm ²	0.5...6	
Stranded H07 V-R			
Flexible H05(07) V-K	mm ²	0.5...4	
Flexible with ferrule	mm ²	0.5...2.5	
Ferrule with plastic collar	mm ²	0.5...2.5	
Stripping length	mm	6	
Screwdriver blade	mm	0.6 x 3.5	
According to norm		DIN 5264	
Tightening torque range	Nm	0.5...0.6	
Rated current, max.	A	32.5	27.5
At ambient temperature		20°C	40°C
For conductor cross-section			
Overtoltage category		III	III II
Pollution severity		3	2 2
Rated voltage	V	250	320 500
Rated impulse voltage	kV	4	4 4
UL / CUL (Use Group)		B	C D
Rated voltage	V	300	300
Rated current	A	20	10
AWG conductor	AWG	26-12	
CSA (Use Group)		B	C D
Rated voltage	V	300	300
Rated current	A	20	10
AWG conductor	AWG	26-12	
General data			
Type of insulation material		Wemid (PA)	
UL 94 flammability rating		V-0	
Contact base material		Copper alloy	
Material of contact surface		tinned	
Pin dimensions = d	mm	0.75 x 0.9	
Solder eyelet Ø = D	mm	1.3	
Solder eyelet Ø tolerance	mm	+ 0,1	

Accessories

Note: Refer to the Accessories chapter for additional accessories.

Screwdriver		Order No.
	SDS 0.6X3.5X100	2749340000
	SDIS 0.6X3.5X100	2749810000

Ordering data

Solder pin length		3.2 mm		
Colour		orange		
Pitch		5.08 mm		
Pol.	L1	(inch)	Qty.	Order No.
2	5.08	0.200	100	1975360000
3	10.16	0.400	100	1975370000
4	15.24	0.600	100	1975380000
5	20.32	0.800	50	1975390000
6	25.40	1.000	50	1975400000
7	30.48	1.200	50	1975410000
8	35.56	1.400	50	1975420000
9	40.64	1.600	50	1975430000
10	45.72	1.800	50	1975440000
11	50.80	2.000	50	1975460000
12	55.88	2.200	50	1975470000

Representative deratings curve

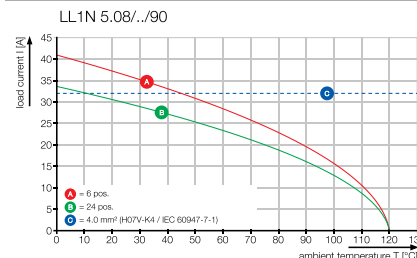

LL2N 5.08/..90



Dimensioned drawing

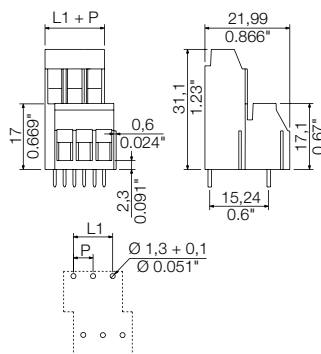

Ordering data

Solder pin length		3.2 mm	
Colour		orange	
Pitch		5.08 mm	
Pol.	L1	(inch)	Order No.
8	22.86	0.900	1977480000
12	33.02	1.300	1977500000
16	43.18	1.700	1977520000
20	53.34	2.100	1977540000
24	63.50	2.500	1977560000

LL3R 5.08/..90



Dimensioned drawing

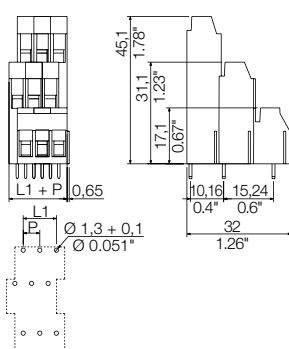

Ordering data

Solder pin length		3.2 mm	
Colour		orange	
Pitch		5.08 mm	
Pol.	L1	(inch)	Order No.
6	5.08	0.500	1934340000
12	15.24	0.900	1979060000
18	25.40	1.300	1979080000
24	35.56	1.700	1979100000
30	45.72	2.100	1979120000
36	55.88	2.500	1979140000

Additional deratings curves

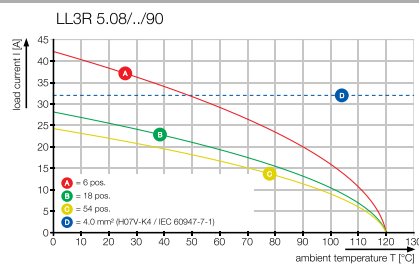
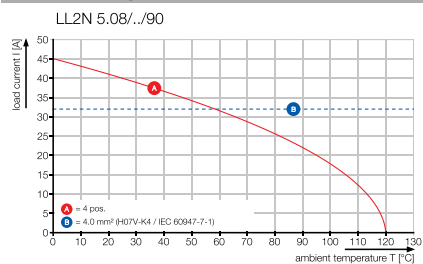

LL 9.52

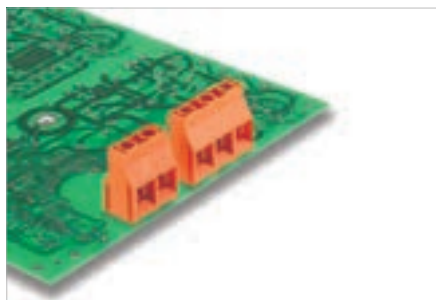

Single-row PCB terminal with our proven clamping-yoke screw connection in 9.52 mm pitch, suitable for wire cross-sections up to 6 mm².

- Increased derating reserves through the use of WEMID insulating material
- Wire outlet direction: 90° version
- 2- and 3-pole block construction – can be aligned together for higher pole counts.

Product data

IEC: 1000 V / 32 A / 0.18 - 6 mm²
 UL: 300 V / 30 A / AWG 26 - 10



For additional articles and information, refer to catalog.weidmueller.com

Note:

- Rated current related to rated cross-section & min. No. of poles.
- Wire end ferrule without plastic collar to DIN 46228/1
- Wire end ferrule with plastic collar to DIN 46228/4
- P on drawing = pitch
- Rated data refer only to the component itself. Clearance and creepage distances to other components are to be designed in accordance with the relevant application standards.
- It is necessary to hold the insulating body of the one or two pole terminal when tightening the screw
- Long term storage of the product with average temperature of 50 °C and average humidity 70%, 36 months

LL 9.52../90



Dimensioned drawing

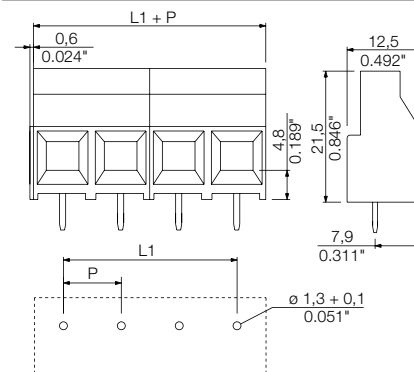

Ordering data

Solder pin length		5 mm		
Colour		orange		
Pitch		9.52 mm		
Pol.	L1	(inch)	Qty.	Order No.
2	9.52	0.375	100	1724680000
3	19.04	0.750	100	1724690000

Representative deratings curve

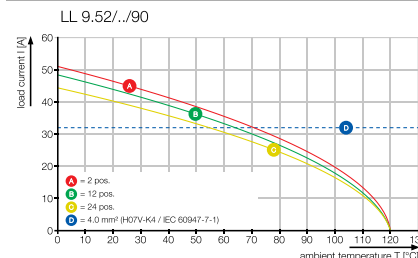

Technical data

In compliance with IEC 60664-1 / IEC 61984			
Clamping range, max.	mm ²	0.18...6	
Solid core H05(07) V-U	mm ²	0.18...6	
Stranded H07 V-R			
Flexible H05(07) V-K	mm ²	0.22...4	
Flexible with ferrule	mm ²	0.5...4	
Ferrule with plastic collar	mm ²	0.5...2.5	
Stripping length	mm	7	
Screwdriver blade	mm	0.8 x 4.0	
According to norm		DIN 5264	
Tightening torque range	Nm	0.5...0.6	
Rated current, max.	A	32	32
At ambient temperature		20°C	40°C
For conductor cross-section			
Overtoltage category		III	III II
Pollution severity		3	2 2
Rated voltage	V	690	1000 1000
Rated impulse voltage	kV	8	8 6
UL / CUL (Use Group)		B	C D
Rated voltage	V	300	300
Rated current	A	30	30
AWG conductor	AWG	26-10	
CSA (Use Group)		B	C D
Rated voltage	V	300	300
Rated current	A	30	35
AWG conductor	AWG	26-10	
General data			
Type of insulation material		Wemid (PA)	
UL 94 flammability rating		V-0	
Contact base material		Copper alloy	
Material of contact surface		tinned	
Pin dimensions = d	mm	0.5 x 1.0	
Solder eyelet Ø = D	mm	1.3	
Solder eyelet Ø tolerance	mm	+ 0,1	

Accessories

Note: Refer to the Accessories chapter for additional accessories.

Screwdriver		Order No.
	SDS 0.8X4.0X100	2749360000
	SDIS 0.8X4.0X100	2749820000
	SDK PZ1 X 80	2749440000

LL 9.52, multi-level



Double-level PCB terminal with our proven clamping yoke screw connection in 9.52 mm pitch, suitable for wire cross-sections up to 6 mm².

- Increased derating reserves through the use of WEMID insulating material
- Wire outlet direction: 90° version
- Block construction – can be aligned together for higher pole counts.

Technical data

In compliance with IEC 60664-1 / IEC 61984			
Clamping range, max.	mm ²	0.18...6	
Solid core H05(07) V-U	mm²	0.18...6	
Stranded H07 V-R			
Flexible H05(07) V-K	mm ²	0.22...4	
Flexible with ferrule	mm ²	0.5...2.5	
Ferrule with plastic collar	mm ²	0.5...2.5	
Stripping length	mm	7	
Screwdriver blade	mm	0.8 x 4.0	
According to norm		DIN 5264	
Tightening torque range	Nm	0.5...0.6	
Rated current, max.	A	32	32
At ambient temperature		20°C	40°C
For conductor cross-section			
Overtoltage category		III	III II
Pollution severity		3	2 2
Rated voltage	V	690	690 1000
Rated impulse voltage	kV	6	6 6
UL / CUL (Use Group)		B	C D
Rated voltage	V	300	300
Rated current	A	30	30
AWG conductor	AWG	26-10	
CSA (Use Group)		B	C D
Rated voltage	V	300	300
Rated current	A	30	30
AWG conductor	AWG	26-10	
General data			
Type of insulation material		Wemid (PA)	
UL 94 flammability rating		V-0	
Contact base material		Copper alloy	
Material of contact surface		tinned	
Pin dimensions = d	mm	0.5 x 1.0	
Solder eyelet Ø = D	mm	1.3	
Solder eyelet Ø tolerance	mm	+ 0,1	

Product data

IEC: 1000 V / 32 A / 0.18 - 6 mm²
 UL: 300 V / 30 A / AWG 26 - 10



For additional articles and information, refer to catalog.weidmueller.com

Note:

- Rated current related to rated cross-section & min. No. of poles.
- Wire end ferrule without plastic collar to DIN 46228/1
- Wire end ferrule with plastic collar to DIN 46228/4
- P on drawing = pitch
- Rated data refer only to the component itself. Clearance and creepage distances to other components are to be designed in accordance with the relevant application standards.
- Long term storage of the product with average temperature of 50 °C and average humidity 70%, 36 months

LL2N 9.52/.. /90



Dimensioned drawing

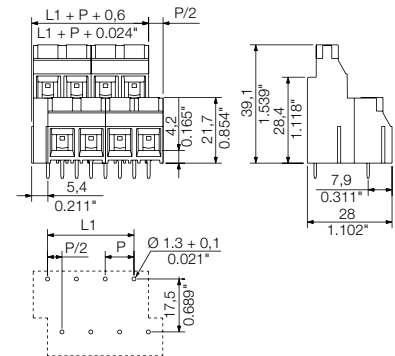

Accessories

Note: Refer to the Accessories chapter for additional accessories.

Screwdriver		Order No.
	SDS 0.8X4.0X100	2749360000
	SDIS 0.8X4.0X100	2749820000
	SDK PZ1 X 80	2749440000

Ordering data

Solder pin length		5 mm		
Colour		orange		
Pitch		9.52 mm		
Pol.	L1	(inch)	Qty.	Order No.
4	9.52	3.750	10	1926350000
8	28.56	11.250	10	1926360000
12	47.60	18.750	10	1926370000
16	66.64	26.250	5	1926380000
20	85.68	33.750	5	1926390000
24	104.72	41.250	5	1926400000

Representative deratings curve

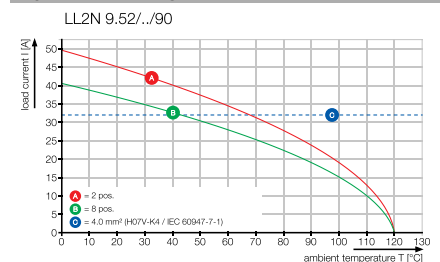

LL 10.00

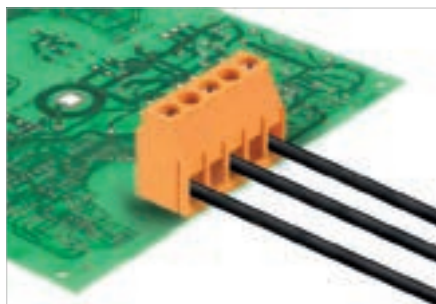

Product data

IEC: 1000 V / 32 A / 0.5 - 6 mm²
 UL: 300 V / 30 A / AWG 26 - 10



For additional articles and information, refer to catalog.weidmueller.com

Note:

- Long term storage of the product with average temperature of 50 °C and average humidity 70%, 36 months

LL 10.00/./90



Dimensioned drawing

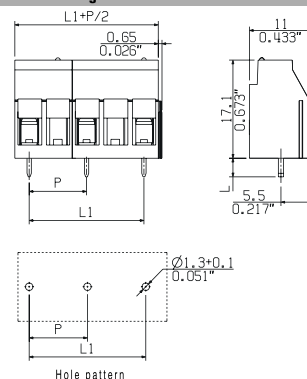

Ordering data

Solder pin length		3.2 mm		
Colour		orange		
Pitch		10.00 mm		
Pol.	L1	(inch)	Qty.	Order No.
2	10.00	0.394	100	2613390000
3	20.00	0.787	50	2613340000

Technical data

In compliance with IEC 60664-1 / IEC 61984		
Clamping range, max.	mm ²	0.13...6
Solid core H05(07) V-U	mm ²	0.5...6
Stranded H07 V-R		
Flexible H05(07) V-K	mm ²	0.5...4
Flexible with ferrule	mm ²	0.5...2.5
Ferrule with plastic collar	mm ²	0.5...2.5
Stripping length	mm	6
Screwdriver blade	mm	0.6 x 3.5
According to norm		DIN 5264
Tightening torque range	Nm	0.5...0.6
Rated current, max.	A	32 32
At ambient temperature	20°C	40°C
For conductor cross-section		
Overvoltage category		III III II
Pollution severity		3 2 2
Rated voltage	V	630 630 1000
Rated impulse voltage	V	8 8 1000
UL / CUL (Use Group)	B C D	
Rated voltage	V	300 150 300
Rated current	A	30 10 10
AWG conductor	AWG	26-10
CSA (Use Group)	B C D	
Rated voltage	V	300 300
Rated current	A	30 10
AWG conductor	AWG	26-10
General data		
Type of insulation material		Wemid (PA)
UL 94 flammability rating		V-0
Contact base material		Copper alloy
Material of contact surface		tinned
Pin dimensions = d	mm	0.75 x 0.9
Solder eyelet Ø = D	mm	1.3
Solder eyelet Ø tolerance	mm	+ 0,1

Accessories

Note: Refer to the Accessories chapter for additional accessories.

PS 3.5/..90

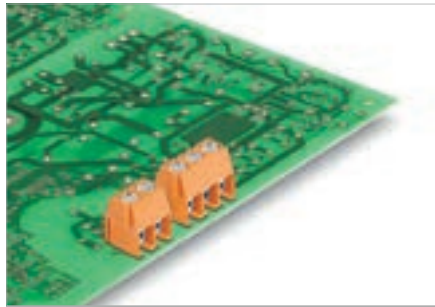

Highly compact PCB terminal with leaf spring screw connection in 3.5 mm pitch for wire cross-sections up to 1.5 mm².

- Increased derating reserves through the use of WEMID insulating material
- Wire outlet direction: 90° version
- 2- and 3-pole block construction – can be aligned together for higher pole counts.

Product data

IEC: 320 V / 17.5 A / 0.2 - 1.5 mm²
 UL: 300 V / 10 A / AWG 28 - 16



For additional articles and information, refer to catalog.weidmueller.com

Note:

- Rated current related to rated cross-section & min. No. of poles.
- Wire end ferrule without plastic collar to DIN 46228/1
- Wire end ferrule with plastic collar to DIN 46228/4
- The data given under CSA relates to a cUL approval - E60693
- P on drawing = pitch
- Rated data refer only to the component itself. Clearance and creepage distances to other components are to be designed in accordance with the relevant application standards.
- It is necessary to hold the insulating body of the one or two pole terminal when tightening the screw
- Long term storage of the product with average temperature of 50 °C and average humidity 70%, 36 months

PS 3.5/..90



Dimensioned drawing

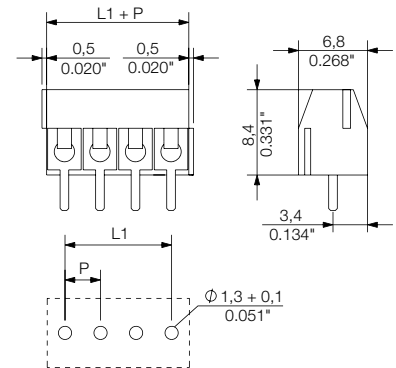

Ordering data

Solder pin length		3.5 mm		
Colour		orange		
Pitch		3.50 mm		
Pol.	L1	(inch)	Qty.	Order No.
2	3.50	0.138	100	1912320000
3	7.00	0.276	100	1912330000
4	10.50	0.413	100	1912340000
5	14.00	0.551	100	1912350000
6	17.50	0.689	100	1912360000
7	21.00	0.827	100	1912370000
8	24.50	0.965	100	1912380000
9	28.00	1.102	100	1912390000
10	31.50	1.240	100	1912400000
11	35.00	1.378	100	1912410000
12	38.50	1.516	100	1912420000

Representative deratings curve

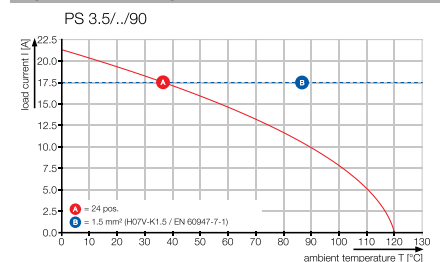

Technical data

In compliance with IEC 60664-1 / IEC 61984			
Clamping range, max.	mm ²	0.08...1.5	
Solid core H05(07) V-U	mm ²	0.2...1.5	
Stranded H07 V-R			
Flexible H05(07) V-K	mm ²	0.2...1.5	
Flexible with ferrule	mm ²	0.25...0.75	
Ferrule with plastic collar	mm ²	0.25...0.75	
Stripping length	mm	4	
Screwdriver blade	mm	0.4 x 2.5	
According to norm		DIN 5264	
Tightening torque range	Nm	0.2...0.25	
Rated current, max.	A	17.5	17.5
At ambient temperature		20°C	40°C
For conductor cross-section			
Overtoltage category		III	III II
Pollution severity		3	2 2
Rated voltage	V	160	160 320
Rated impulse voltage	kV	2.5	2.5 2.5
UL / CUL (Use Group)		B	C D
Rated voltage	V	300	300
Rated current	A	10	10
AWG conductor	AWG	28-16	
CSA (Use Group)		B	C D
Rated voltage	V	300	
Rated current	A	10	
AWG conductor	AWG	28-16	
General data			
Type of insulation material		Wemid (PA)	
UL 94 flammability rating		V-0	
Contact base material		Copper alloy	
Material of contact surface		tinned	
Pin dimensions = d	mm	0.8	
Solder eyelet Ø = D	mm	1.3	
Solder eyelet Ø tolerance	mm	+ 0,1	

Accessories

Note: Refer to the Accessories chapter for additional accessories.

Screwdriver		Order No.
	SDIS 0.6X3.5X100	2749810000

PM 5.00/./90

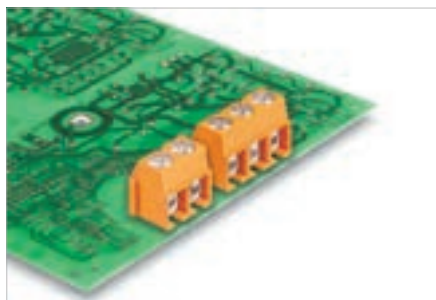

PCB terminal with leaf spring screw connection in 5.00 and 5.08 mm pitches for wire cross-sections up to 2.5 mm².

- Increased derating reserves through the use of WEMID insulating material
- Wire outlet direction: 90° version
- 2- and 3-pole block construction – can be aligned together for higher pole counts.

Product data

IEC: 600 V / 24 A / 0.13 - 2.5 mm²
 UL: 300 V / 15 A / AWG 26 - 14



For additional articles and information, refer to catalog.weidmueller.com

Note:

- Rated current related to rated cross-section & min. No. of poles.
- Wire end ferrule without plastic collar to DIN 46228/1
- Wire end ferrule with plastic collar to DIN 46228/4
- The data given under CSA relates to a cUL approval - E60693
- P on drawing = pitch
- Rated data refer only to the component itself. Clearance and creepage distances to other components are to be designed in accordance with the relevant application standards.
- Long term storage of the product with average temperature of 50 °C and average humidity 70%, 36 months

PM 5.00/./90



Dimensioned drawing

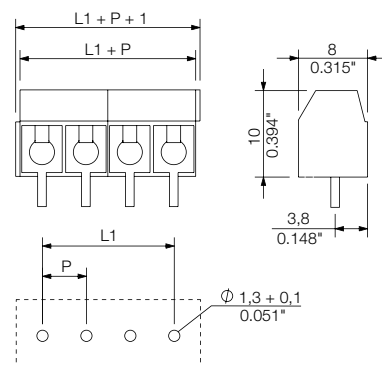

Ordering data

Solder pin length		3.5 mm		
Colour		orange		
Pitch		5.00 mm		
Pol.	L1	(inch)	Qty.	Order No.
2	5.00	0.197	500	1791610000
3	10.00	0.394	500	1791620000
4	15.00	0.591	100	1234650000
5	20.00	0.787	100	1234670000
6	25.00	0.984	500	1234680000
7	30.00	1.181	100	1234690000
8	35.00	1.378	100	1234700000
9	40.00	1.575	100	1234710000
10	45.00	1.772	100	1234720000
11	50.00	1.969	100	1234730000
12	55.00	2.165	100	1234740000

Representative deratings curve

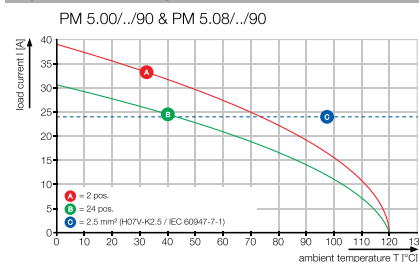

Technical data

In compliance with IEC 60664-1 / IEC 61984			
Clamping range, max.	mm ²	0.13...2.5	
Solid core H05(07) V-U	mm ²	0.13...2.5	
Stranded H07 V-R			
Flexible H05(07) V-K	mm ²	0.13...2.5	
Flexible with ferrule	mm ²	0.25...1.5	
Ferrule with plastic collar	mm ²	0.25...1.5	
Stripping length	mm	6	
Screwdriver blade	mm	0.6 x 3.5	
According to norm		DIN 5264	
Tightening torque range	Nm	0.4...0.5	
Rated current, max.	A	24	24
At ambient temperature		20°C	40°C
For conductor cross-section			
Overtoltage category		III	III II
Pollution severity		3	2 2
Rated voltage	V	250	250 600
Rated impulse voltage	kV	4	4 4
UL / CUL (Use Group)		B	C D
Rated voltage	V	300	300
Rated current	A	15	10
AWG conductor	AWG	26-14	
CSA (Use Group)		B	C D
Rated voltage	V	300	300
Rated current	A	15	10
AWG conductor	AWG	26-14	
General data			
Type of insulation material		Wemid (PA)	
UL 94 flammability rating		V-0	
Contact base material		Copper alloy	
Material of contact surface		tinned	
Pin dimensions = d	mm	1.0	
Solder eyelet Ø = D	mm	1.3	
Solder eyelet Ø tolerance	mm	+ 0,1	

Accessories

Note: Refer to the Accessories chapter for additional accessories.

Screwdriver		Order No.
	SDIS 0.6X3.5X100	2749810000

PM 5.08/./90

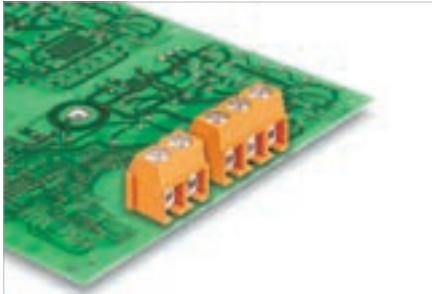

PCB terminal with leaf spring screw connection in 5.00 and 5.08 mm pitches for wire cross-sections up to 2.5 mm².

- Increased derating reserves through the use of WEMID insulating material
- Wire outlet direction: 90° version
- 2- and 3-pole block construction – can be aligned together for higher pole counts.

Technical data

In compliance with IEC 60664-1 / IEC 61984			
Clamping range, max.	mm ²	0.13...2.5	
Solid core H05(07) V-U	mm ²	0.13...2.5	
Stranded H07 V-R			
Flexible H05(07) V-K	mm ²	0.13...2.5	
Flexible with ferrule	mm ²	0.25...1.5	
Ferrule with plastic collar	mm ²	0.25...1.5	
Stripping length	mm	6	
Screwdriver blade	mm	0.6 x 3.5	
According to norm		DIN 5264	
Tightening torque range	Nm	0.4...0.5	
Rated current, max.	A	24	24
At ambient temperature		20°C	40°C
For conductor cross-section			
Overtoltage category		III	III II
Pollution severity		3	2 2
Rated voltage	V	250	250 600
Rated impulse voltage	kV	4	4 4
UL / CUL (Use Group)		B	C D
Rated voltage	V	300	300
Rated current	A	15	10
AWG conductor	AWG	26-14	
CSA (Use Group)		B	C D
Rated voltage	V	300	300
Rated current	A	15	10
AWG conductor	AWG	26-14	
General data			
Type of insulation material		Wemid (PA)	
UL 94 flammability rating		V-0	
Contact base material		Copper alloy	
Material of contact surface		tinned	
Pin dimensions = d	mm	1.0	
Solder eyelet Ø = D	mm	1.3	
Solder eyelet Ø tolerance	mm	+ 0,1	

Product data

IEC: 600 V / 24 A / 0.13 - 2.5 mm²
 UL: 300 V / 15 A / AWG 26 - 14



For additional articles and information, refer to catalog.weidmueller.com

Note:

- Rated current related to rated cross-section & min. No. of poles.
- Wire end ferrule without plastic collar to DIN 46228/1
- Wire end ferrule with plastic collar to DIN 46228/4
- The data given under CSA relates to a cUL approval - E60693
- P on drawing = pitch
- Rated data refer only to the component itself. Clearance and creepage distances to other components are to be designed in accordance with the relevant application standards.
- Long term storage of the product with average temperature of 50 °C and average humidity 70%, 36 months

PM 5.08/./90



Dimensioned drawing

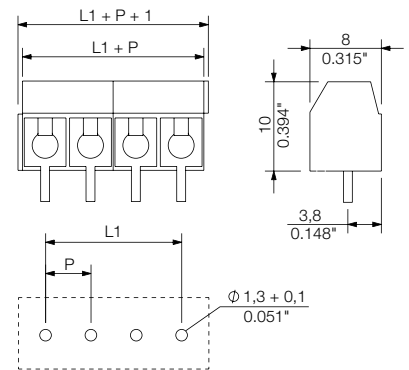

Accessories

Note: Refer to the Accessories chapter for additional accessories.

Screwdriver		Order No.
	SDIS 0.6X3.5X100	2749810000

Ordering data

Solder pin length		3.5 mm		
Colour		orange		
Pitch		5.08 mm		
Pol.	L1	(inch)	Qty.	Order No.
2	5.08	0.200	500	1760490000
3	10.16	0.400	500	1760500000
4	15.24	0.600	100	1234550000
5	20.32	0.800	100	1234570000
6	25.40	1.000	100	1234580000
7	30.48	1.200	100	1234590000
8	35.56	1.400	100	1234600000
9	40.64	1.600	100	1234610000
10	45.72	1.800	50	1234620000
11	50.80	2.000	100	1234630000
12	55.88	2.200	100	1234640000

Representative deratings curve

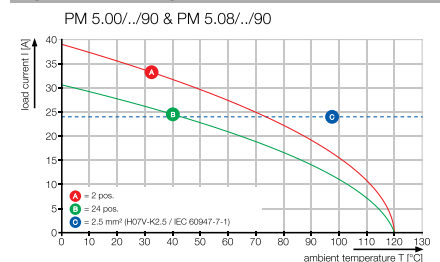

LSF-SMT 3.5/./90

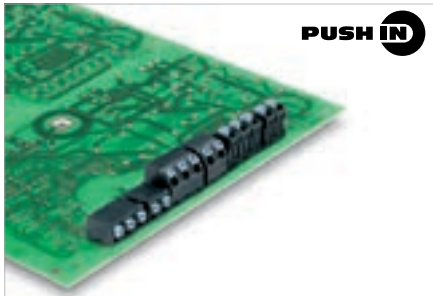

PCB terminal for fully automatic assembly, in 3.5 mm pitch, for THR reflow soldering (SMT) and wave soldering.

- PUSH IN spring connection system for wire cross-sections up to 1.5 mm².
- Form and dimensional stability through the use of LCP insulating material.
- Wire connection and slider operation from the same direction (TOP).
- Packaged in tube or tape-on-reel.
- Pin lengths optimised to 1.5 mm or 3.5 mm.
- Wire outlet direction: 90° version

Technical data

In compliance with IEC 60664-1 / IEC 61984			
Clamping range, max.	mm ²	0.13...1.5	
Solid core H05(07) V-U	mm²	0.2...1.5	
Stranded H07 V-R			
Flexible H05(07) V-K	mm ²	0.2...1.5	
Flexible with ferrule	mm ²	0.25...1.5	
Ferrule with plastic collar	mm ²	0.25...0.75	
Stripping length	mm	8	
Screwdriver blade	mm		
According to norm			
Tightening torque range			
Rated current, max.	A	17.5	17.5
At ambient temperature		20°C	40°C
For conductor cross-section			
Overtoltage category		III	III II
Pollution severity		3	2 2
Rated voltage	V	160	160 320
Rated impulse voltage	kV	2.5	2.5 2.5
UL / CUL (Use Group)		B	C D
Rated voltage	V	300	300
Rated current	A	12	10
AWG conductor	AWG	28-14	
CSA (Use Group)		B	C D
Rated voltage	V	300	300
Rated current	A	10	10
AWG conductor	AWG	28-14	
General data			
Type of insulation material		LCP GF	
UL 94 flammability rating		V-0	
Contact base material		Copper alloy	
Material of contact surface			
Pin dimensions = d	mm	0.35 x 0.8	
Solder eyelet Ø = D	mm	1.1	
Solder eyelet Ø tolerance	mm	+ 0,1	

3.50
90°

1.5 mm²

Product data

IEC: 320 V / 17.5 A / 0.2 - 1.5 mm²
UL: 300 V / 12 A / AWG 28 - 14



For additional articles and information, refer to catalog.weidmueller.com

Note:

- Additional push button colours on request
- Operating force of slider max. 40 N
- Rated current related to rated cross-section & min. No. of poles.
- Wire end ferrule with plastic collar to DIN 46228/4
- Wire end ferrule without plastic collar to DIN 46228/1
- P on drawing = pitch
- Rated data refer only to the component itself. Clearance and creepage distances to other components are to be designed in accordance with the relevant application standards.
- Crimping shape "A" for wire end ferrules with PZ 6/5 crimping tool recommended.
- Long term storage of the product with average temperature of 50 °C and average humidity 70%, 36 months

Accessories

Note: Refer to the Accessories chapter for additional accessories.

Screwdriver		Order No.
	SDS 0.4X2.5X75	2749320000
	SDIS 0.4X2.5X75	2749790000

LSF-SMT 3.5/./90

Reflow-compatible PCB terminal



Dimensioned drawing

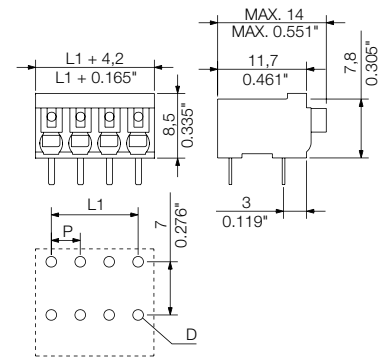

Ordering data

Solder pin length		1.5 mm	3.5 mm		
Colour		black	black		
Pitch 3.50 mm					
Pol.	L1 (inch)	Qty.	Order No.	Order No.	
2	3.50	0.138	71	1870500000	1824420000
3	7.00	0.276	49	1870530000	1824430000
4	10.50	0.413	37	1870550000	1824440000
5	14.00	0.551	30	1870580000	1824450000
6	17.50	0.689	25	1870590000	1824460000
7	21.00	0.827	21	1871020000	1824470000
8	24.50	0.965	19	1871030000	1824480000
9	28.00	1.102	17	1871040000	1824490000
10	31.50	1.240	15	1871050000	1824500000
11	35.00	1.378	14	1871060000	1824510000
12	38.50	1.516	12	1871070000	1824520000

Representative deratings curve

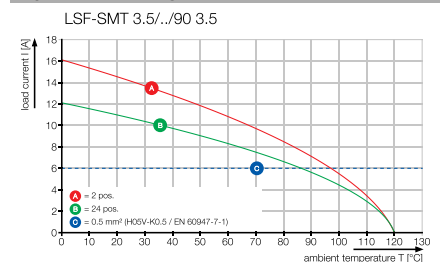

LSF-SMT 3.5/./90 Tape

Reflow-compatible PCB terminal



Dimensioned drawing

Ordering data

Solder pin length		1.5 mm	3.5 mm		
Colour		black	black		
Pitch		3.50 mm			
Pol.	L1 (inch)	Qty.	Order No.		
2	3.50	0.138	265	1874690000	1874990000
3	7.00	0.276	265	1874710000	1875030000
4	10.50	0.413	265	1874730000	1875050000
5	14.00	0.551	265	1874740000	1875070000
6	17.50	0.689	265	1874810000	1875080000
7	21.00	0.827	265	1874840000	1875100000
8	24.50	0.965	265	1874890000	1875110000
9	28.00	1.102	265	1874900000	1875120000
10	31.50	1.240	265	1874930000	1875130000
11	35.00	1.378	265	1874940000	1875140000
12	38.50	1.516	265	1874970000	1875160000

Belt widths: 32, 44, 56, 72, 88

Additional deratings curves

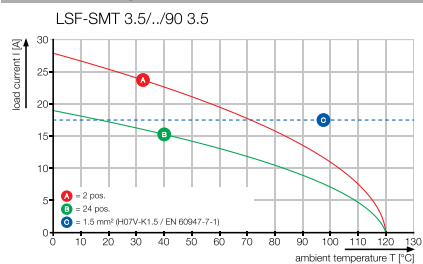

LSF-SMT 3.5/./135

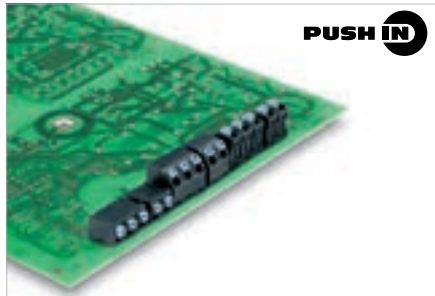

PCB terminal for fully automatic assembly, in 3.5 mm pitch, for THR reflow soldering (SMT) and wave soldering.

- PUSH IN spring connection system for wire cross-sections up to 1.5 mm².
- Form and dimensional stability through the use of LCP insulating material.
- Wire connection and slider operation from the same direction (TOP).
- Packaged in tube or tape-on-reel.
- Pin lengths optimised to 1.5 mm or 3.5 mm.
- Wire outlet direction: 135° version

Technical data

In compliance with IEC 60664-1 / IEC 61984			
Clamping range, max.	mm ²	0.13...1.5	
Solid core H05(07) V-U	mm²	0.2...1.5	
Stranded H07 V-R			
Flexible H05(07) V-K	mm ²	0.2...1.5	
Flexible with ferrule	mm ²	0.25...1.5	
Ferrule with plastic collar	mm ²	0.25...0.75	
Stripping length	mm	8	
Screwdriver blade	mm		
According to norm			
Tightening torque range			
Rated current, max.	A	17.5	17.5
At ambient temperature		20°C	40°C
For conductor cross-section			
Overtoltage category		III	III II
Pollution severity		3	2 2
Rated voltage	V	160	160 320
Rated impulse voltage	kV	2.5	2.5 2.5
UL / CUL (Use Group)		B	C D
Rated voltage	V	300	300
Rated current	A	12	10
AWG conductor	AWG	28-14	
CSA (Use Group)		B	C D
Rated voltage	V	300	300
Rated current	A	10	10
AWG conductor	AWG	28-14	
General data			
Type of insulation material		LCP GF	
UL 94 flammability rating		V-0	
Contact base material		Copper alloy	
Material of contact surface			
Pin dimensions = d	mm	0.35 x 0.8	
Solder eyelet Ø = D	mm	1.1	
Solder eyelet Ø tolerance	mm	+ 0,1	

Product data

IEC: 320 V / 17.5 A / 0.2 - 1.5 mm²
 UL: 300 V / 12 A / AWG 28 - 14



For additional articles and information, refer to catalog.weidmueller.com

Note:

- Additional push button colours on request
- Operating force of slider max. 40 N
- Rated current related to rated cross-section & min. No. of poles.
- Wire end ferrule with plastic collar to DIN 46228/4
- Wire end ferrule without plastic collar to DIN 46228/1
- P on drawing = pitch
- Rated data refer only to the component itself. Clearance and creepage distances to other components are to be designed in accordance with the relevant application standards.
- Crimping shape "A" for wire end ferrules with PZ 6/5 crimping tool recommended.
- Long term storage of the product with average temperature of 50 °C and average humidity 70%, 36 months

LSF-SMT 3.5/./135

Reflow-compatible PCB terminal



Dimensioned drawing

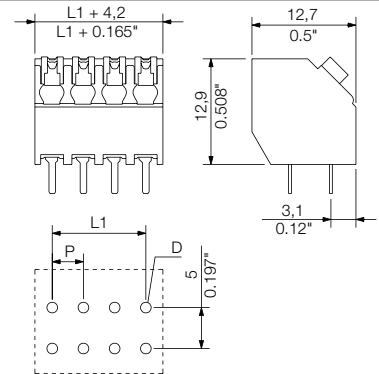

Ordering data

Solder pin length	1.5 mm		3.5 mm	
	black		black	
Colour	black		black	
Pitch	3.50 mm			
Pol.	L1 (inch)	Qty.	Order No.	Order No.
2	3.50	0.138	71	1885180000 1885650000
3	7.00	0.276	49	1885190000 1885660000
4	10.50	0.413	37	1885200000 1885670000
5	14.00	0.551	30	1885210000 1885680000
6	17.50	0.689	25	1885220000 1885690000
7	21.00	0.827	21	1885230000 1885700000
8	24.50	0.965	19	1885240000 1885710000
9	28.00	1.102	17	1885250000 1885720000
10	31.50	1.240	15	1885260000 1885730000
11	35.00	1.378	14	1885270000 1885740000
12	38.50	1.516	12	1885280000 1885750000

Representative deratings curve

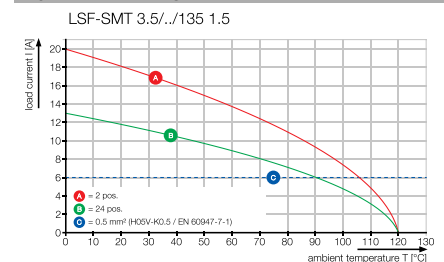

LSF-SMT 3.5/././135 Tape

Reflow-compatible PCB terminal



Dimensioned drawing

Ordering data

Solder pin length		1.5 mm	3.5 mm
Colour		black	black
Pitch		3.50 mm	
Pol.	L1 (inch)	Qty.	Order No.
2	3.50	0.138	190 1887550000 1887340000
3	7.00	0.276	190 1887560000 1887350000
4	10.50	0.413	190 1887580000 1887360000
5	14.00	0.551	190 1887630000 1887460000
6	17.50	0.689	190/175 1887640000 1887470000
7	21.00	0.827	190 1887650000 1887480000
8	24.50	0.965	190 1887660000 1887490000
9	28.00	1.102	190 1887670000 1887500000
10	31.50	1.240	190 1887680000 1887510000
11	35.00	1.378	190 1887690000 1887520000
12	38.50	1.516	190 1887700000 1887530000

Belt widths: 32, 44, 56, 72, 88

Additional deratings curves

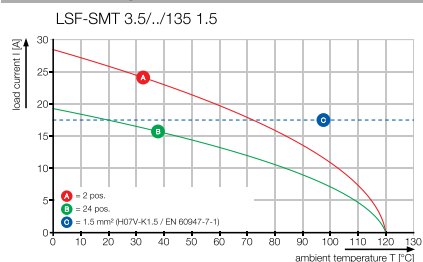

LSF-SMT 3.5/./180

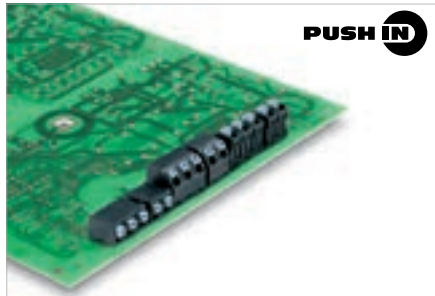

PCB terminal for fully automatic assembly, in 3.5 mm pitch, for THR reflow soldering (SMT) and wave soldering.

- PUSH IN spring connection system for wire cross-sections up to 1.5 mm².
- Form and dimensional stability through the use of LCP insulating material.
- Wire connection and slider operation from the same direction (TOP).
- Packaged in tube or tape-on-reel.
- Pin lengths optimised to 1.5 mm or 3.5 mm.
- Wire outlet direction: 180° version

Technical data

In compliance with IEC 60664-1 / IEC 61984			
Clamping range, max.	mm ²	0.13...1.5	
Solid core H05(07) V-U	mm²	0.2...1.5	
Stranded H07 V-R			
Flexible H05(07) V-K	mm ²	0.2...1.5	
Flexible with ferrule	mm ²	0.25...1.5	
Ferrule with plastic collar	mm ²	0.25...0.75	
Stripping length	mm	8	
Screwdriver blade	mm		
According to norm			
Tightening torque range			
Rated current, max.	A	17.5	17.5
At ambient temperature		20°C	40°C
For conductor cross-section			
Overvoltage category		III	III II
Pollution severity		3	2 2
Rated voltage	V	160	160 320
Rated impulse voltage	kV	2.5	2.5 2.5
UL / CUL (Use Group)		B	C D
Rated voltage	V	300	300
Rated current	A	12	10
AWG conductor	AWG	28-14	
CSA (Use Group)		B	C D
Rated voltage	V	300	300
Rated current	A	10	10
AWG conductor	AWG	28-14	
General data			
Type of insulation material		LCP GF	
UL 94 flammability rating		V-0	
Contact base material		Copper alloy	
Material of contact surface			
Pin dimensions = d	mm	0.35 x 0.8	
Solder eyelet Ø = D	mm	1.1	
Solder eyelet Ø tolerance	mm	+ 0,1	

Product data

IEC: 320 V / 17.5 A / 0.2 - 1.5 mm²
 UL: 300 V / 12 A / AWG 28 - 14



For additional articles and information, refer to catalog.weidmueller.com

Note:

- Additional push button colours on request
- Operating force of slider max. 40 N
- Rated current related to rated cross-section & min. No. of poles.
- Wire end ferrule with plastic collar to DIN 46228/4
- Wire end ferrule without plastic collar to DIN 46228/1
- P on drawing = pitch
- Rated data refer only to the component itself. Clearance and creepage distances to other components are to be designed in accordance with the relevant application standards.
- Crimping shape "A" for wire end ferrules with PZ 6/5 crimping tool recommended.
- Long term storage of the product with average temperature of 50 °C and average humidity 70%, 36 months

LSF-SMT 3.5/./180

Reflow-compatible PCB terminal



Dimensioned drawing

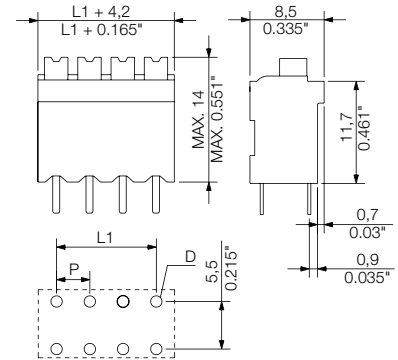

Ordering data

Solder pin length	1.5 mm		3.5 mm	
	black		black	
Pitch	3.50 mm			
Pol.	L1 (inch)	Qty.	Order No.	Order No.
2	3.50	0.138	71	1870640000 1825640000
3	7.00	0.276	49	1870650000 1825650000
4	10.50	0.413	37	1870660000 1825660000
5	14.00	0.551	30	1870670000 1825670000
6	17.50	0.689	25	1870680000 1825680000
7	21.00	0.827	21	1870690000 1825690000
8	24.50	0.965	19	1870700000 1825700000
9	28.00	1.102	17	1870710000 1825710000
10	31.50	1.240	15	1870720000 1825720000
11	35.00	1.378	14	1870730000 1825730000
12	38.50	1.516	12	1870740000 1825740000

Representative deratings curve

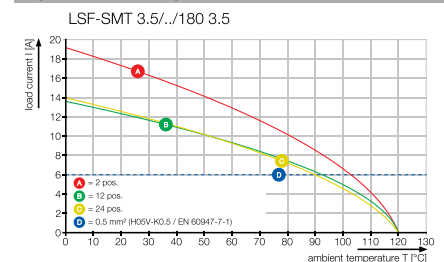

LSF-SMT 3.5/./180 Tape

Reflow-compatible PCB terminal



Dimensioned drawing

Ordering data

Solder pin length		1.5 mm	3.5 mm
Colour		black	black
Pitch		3.50 mm	
Pol.	L1 (inch)	Qty.	Order No.
2	3.50	0.138	175 1874490000 1874510000
3	7.00	0.276	175 1874300000 1874520000
4	10.50	0.413	175 1874280000 1874540000
5	14.00	0.551	175 1874310000 1874560000
6	17.50	0.689	175 1874320000 1874590000
7	21.00	0.827	175 1874340000 1874600000
8	24.50	0.965	175 1874350000 1874610000
9	28.00	1.102	175 1874370000 1874620000
10	31.50	1.240	175 1874380000 1874640000
11	35.00	1.378	175 1874400000 1874660000
12	38.50	1.516	175 1874420000 1874680000

Belt widths: 32, 44, 56, 72, 88

Additional deratings curves

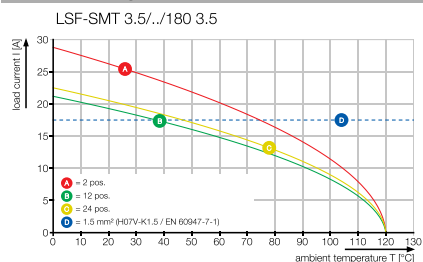

LSF-SMT 3.81/./90

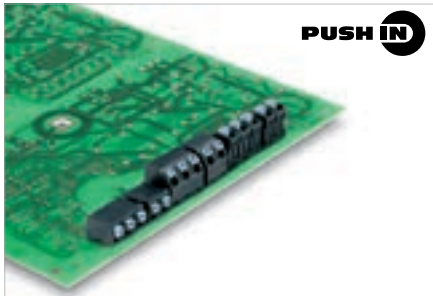

PCB terminal for fully automatic assembly in 3.81 mm pitch, for THR reflow soldering (SMT) and wave soldering.

- PUSH IN spring connection system for wire cross-sections up to 1.5 mm².
- Form and dimensional stability through the use of LCP insulating material.
- Wire connection and slider operation from the same direction (TOP).
- Packaged in tube or tape-on-reel.
- Pin lengths optimised to 1.5 mm or 3.5 mm.
- Wire outlet direction: 90° version

Technical data

In compliance with IEC 60664-1 / IEC 61984			
Clamping range, max.	mm ²	0.13...1.5	
Solid core H05(07) V-U	mm²	0.2...1.5	
Stranded H07 V-R			
Flexible H05(07) V-K	mm ²	0.2...1.5	
Flexible with ferrule	mm ²	0.25...1.5	
Ferrule with plastic collar	mm ²	0.25...0.75	
Stripping length	mm	8	
Screwdriver blade	mm		
According to norm			
Tightening torque range			
Rated current, max.	A	17.5	17.5
At ambient temperature		20°C	40°C
For conductor cross-section			
Overtoltage category		III	III II
Pollution severity		3	2 2
Rated voltage	V	160	160 320
Rated impulse voltage	kV	2.5	2.5 2.5
UL / CUL (Use Group)		B	C D
Rated voltage	V	300	300
Rated current	A	12	10
AWG conductor	AWG	28-14	
CSA (Use Group)		B	C D
Rated voltage	V	300	300
Rated current	A	10	10
AWG conductor	AWG	28-14	
General data			
Type of insulation material		LCP GF	
UL 94 flammability rating		V-0	
Contact base material		Copper alloy	
Material of contact surface			
Pin dimensions = d	mm	0.35 x 0.8	
Solder eyelet Ø = D	mm	1.1	
Solder eyelet Ø tolerance	mm	+ 0,1	

3.81

90°

1.5 mm²

Product data

IEC: 320 V / 17.5 A / 0.2 - 1.5 mm²
 UL: 300 V / 12 A / AWG 28 - 14



For additional articles and information, refer to catalog.weidmueller.com

Note:

- Additional push button colours on request
- Operating force of slider max. 40 N
- Rated current related to rated cross-section & min. No. of poles.
- Wire end ferrule with plastic collar to DIN 46228/4
- Wire end ferrule without plastic collar to DIN 46228/1
- P on drawing = pitch
- Rated data refer only to the component itself. Clearance and creepage distances to other components are to be designed in accordance with the relevant application standards.
- Crimping shape "A" for wire end ferrules with PZ 6/5 crimping tool recommended.
- Long term storage of the product with average temperature of 50 °C and average humidity 70%, 36 months

Accessories

Note: Refer to the Accessories chapter for additional accessories.

Screwdriver		Order No.
	SDS 0.4X2.5X75	2749320000
	SDIS 0.4X2.5X75	2749790000

LSF-SMT 3.81/./90

Reflow-compatible PCB terminal



Dimensioned drawing

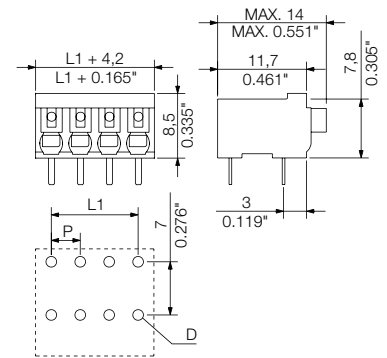

Ordering data

Solder pin length		1.5 mm	3.5 mm		
Colour		black	black		
Pitch 3.81 mm					
Pol.	L1 (inch)	Qty.	Order No.	Order No.	
2	3.81	0.150	69	1869360000	1824620000
3	7.62	0.300	46	1869370000	1824630000
4	11.43	0.450	35	1869380000	1824640000
5	15.24	0.600	28	1869390000	1824650000
6	19.05	0.750	23	1869400000	1824660000
7	22.86	0.900	20	1869410000	1824690000
8	26.67	1.050	17	1869420000	1824700000
9	30.48	1.200	15	1869430000	1824710000
10	34.29	1.350	14	1869440000	1824720000
11	38.10	1.500	13	1869450000	1824730000
12	41.91	1.650	12	1869460000	1825300000

Representative deratings curve

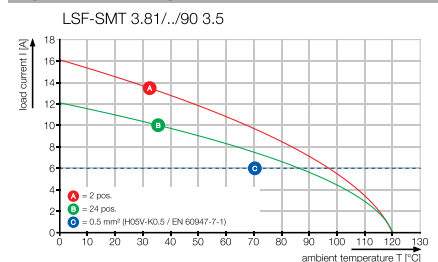

LSF-SMT 3.81../90 Tape

Reflow-compatible PCB terminal



Dimensioned drawing

Ordering data

Solder pin length		1.5 mm	3.5 mm
Colour		black	black
Pitch		3.81 mm	
Pol.	L1 (inch)	Qty.	Order No.
2	3.81	0.150	265 1875170000 1875920000
3	7.62	0.300	265 1875230000 1875930000
4	11.43	0.450	265 1875240000 1875940000
5	15.24	0.600	265 1875250000 1875950000
6	19.05	0.750	265 1875260000 1875960000
7	22.86	0.900	265 1875270000 1875970000
8	26.67	1.050	265 1875280000 1875980000
9	30.48	1.200	265 1875290000 1875990000
10	34.29	1.350	265 1875300000 1876000000
11	38.10	1.500	265 1875310000 1876010000

Belt widths: 32, 44, 56, 72, 88

Additional deratings curves

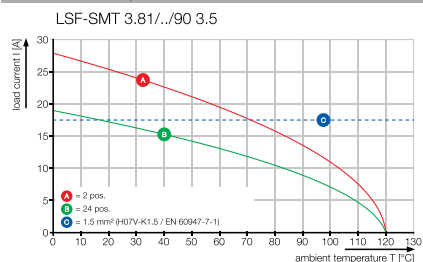

LSF-SMT 3.81../135

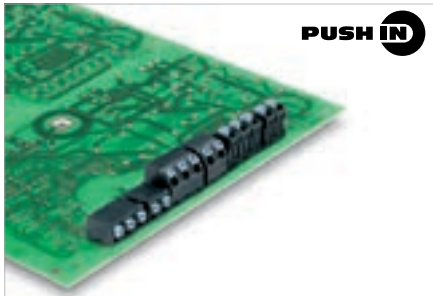

PCB terminal for fully automatic assembly in 3.81 mm pitch, for THR reflow soldering (SMT) and wave soldering.

- PUSH IN spring connection system for wire cross-sections up to 1.5 mm².
- Form and dimensional stability through the use of LCP insulating material.
- Wire connection and slider operation from the same direction (TOP).
- Packaged in tube or tape-on-reel.
- Pin lengths optimised to 1.5 mm or 3.5 mm.
- Wire outlet direction of 135°

Technical data

In compliance with IEC 60664-1 / IEC 61984

Clamping range, max.	mm ²	0.13...1.5
Solid core H05(07) V-U	mm²	0.2...1.5
Stranded H07 V-R		
Flexible H05(07) V-K	mm ²	0.2...1.5
Flexible with ferrule	mm ²	0.25...1.5
Ferrule with plastic collar	mm ²	0.25...0.75
Stripping length	mm	8
Screwdriver blade	mm	
According to norm		
Tightening torque range		
Rated current, max.	A	17.5 17.5
At ambient temperature	20°C	40°C
For conductor cross-section		
Overtoltage category		III III II
Pollution severity		3 2 2
Rated voltage	V	160 160 320
Rated impulse voltage	kV	2.5 2.5 2.5
UL / CUL (Use Group)	B C D	
Rated voltage	V	300 300
Rated current	A	12 10
AWG conductor	AWG	28-14
CSA (Use Group)	B C D	
Rated voltage	V	300 300
Rated current	A	10 10
AWG conductor	AWG	28-14
General data		
Type of insulation material		LCP GF
UL 94 flammability rating		V-0
Contact base material		Copper alloy
Material of contact surface		
Pin dimensions = d	mm	0.35 x 0.8
Solder eyelet Ø = D	mm	1.1
Solder eyelet Ø tolerance	mm	+ 0,1

Product data

IEC: 320 V / 17.5 A / 0.2 - 1.5 mm²
 UL: 300 V / 12 A / AWG 28 - 14



For additional articles and information, refer to catalog.weidmueller.com

Note:

- Additional push button colours on request
- Operating force of slider max. 40 N
- Rated current related to rated cross-section & min. No. of poles.
- Wire end ferrule with plastic collar to DIN 46228/4
- Wire end ferrule without plastic collar to DIN 46228/1
- P on drawing = pitch
- Rated data refer only to the component itself. Clearance and creepage distances to other components are to be designed in accordance with the relevant application standards.
- Crimping shape "A" for wire end ferrules with PZ 6/5 crimping tool recommended.
- Long term storage of the product with average temperature of 50 °C and average humidity 70%, 36 months

LSF-SMT 3.81../135

Reflow-compatible PCB terminal



Dimensioned drawing

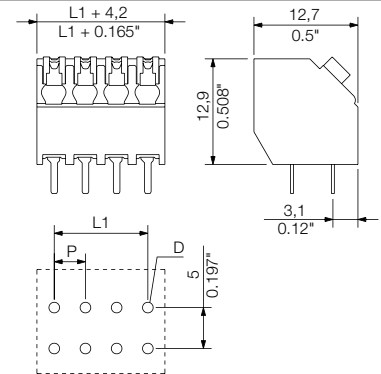

Ordering data

		1.5 mm	3.5 mm	
Solder pin length				
Colour		black	black	
Pitch	3.81 mm			
Pol.	L1 (inch)	Qty.	Order No.	Order No.
2	3.81 0.150	69	1885410000	1885880000
3	7.62 0.300	46	1885420000	1885890000
4	11.43 0.450	35	1885430000	1885900000
5	15.24 0.600	28	1885440000	1885910000
6	19.05 0.750	23	1885450000	1885920000
7	22.86 0.900	20	1885460000	1885930000
8	26.67 1.050	17	1885470000	1885940000
9	30.48 1.200	15	1885480000	1885950000
10	34.29 1.350	14	1885490000	1885960000
11	38.10 1.500	13	1885510000	1885970000
12	41.91 1.650	12	1885520000	1885980000

Representative deratings curve

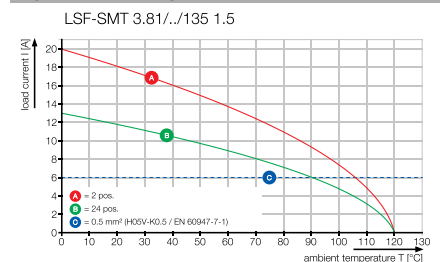

LSF-SMT 3.81../135 Tape

Reflow-compatible PCB terminal



Dimensioned drawing

Ordering data

Solder pin length		1.5 mm	3.5 mm		
Colour		black	black		
Pitch		3.81 mm			
Pol.	L1 (inch)	Qty.	Order No.		
2	3.81	0.150	175	1888450000	1888320000
3	7.62	0.300	190	1888460000	1888330000
4	11.43	0.450	190	1888470000	1888340000
5	15.24	0.600	190	1888480000	1888380000
6	19.05	0.750	190	1888490000	1888390000
7	22.86	0.900	190	1888500000	1888400000
8	26.67	1.050	190	1888510000	1888410000
9	30.48	1.200	190	1888520000	1888420000
10	34.29	1.350	190	1888530000	1888430000
11	38.10	1.500	190	1888540000	1888440000

Belt widths: 32, 44, 56, 72, 88

Additional deratings curves

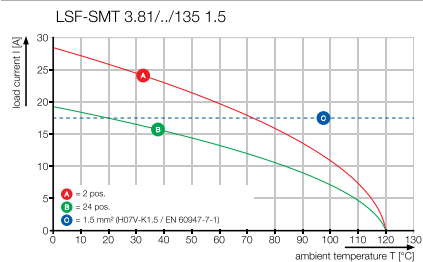

LSF-SMT 3.81/././180

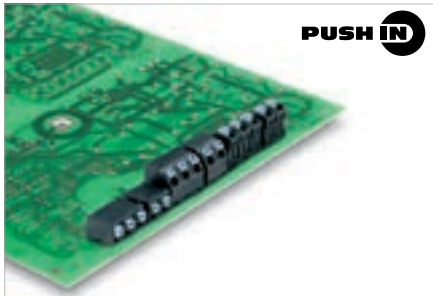

PCB terminal for fully automatic assembly in 3.81 mm pitch, for THR reflow soldering (SMT) and wave soldering.

- PUSH IN spring connection system for wire cross-sections up to 1.5 mm².
- Form and dimensional stability through the use of LCP insulating material.
- Wire connection and slider operation from the same direction (TOP).
- Packaged in tube or tape-on-reel.
- Pin lengths optimised to 1.5 mm or 3.5 mm.
- Wire outlet direction: 180° version

Technical data

In compliance with IEC 60664-1 / IEC 61984			
Clamping range, max.	mm ²	0.13...1.5	
Solid core H05(07) V-U	mm²	0.2...1.5	
Stranded H07 V-R			
Flexible H05(07) V-K	mm ²	0.2...1.5	
Flexible with ferrule	mm ²	0.25...1.5	
Ferrule with plastic collar	mm ²	0.25...0.75	
Stripping length	mm	8	
Screwdriver blade	mm		
According to norm			
Tightening torque range			
Rated current, max.	A	17.5	17.5
At ambient temperature		20°C	40°C
For conductor cross-section			
Overtoltage category		III	III II
Pollution severity		3	2 2
Rated voltage	V	160	160 320
Rated impulse voltage	kV	2.5	2.5 2.5
UL / CUL (Use Group)		B	C D
Rated voltage	V	300	300
Rated current	A	12	10
AWG conductor	AWG	28-14	
CSA (Use Group)		B	C D
Rated voltage	V	300	300
Rated current	A	10	10
AWG conductor	AWG	28-14	
General data			
Type of insulation material		LCP GF	
UL 94 flammability rating		V-0	
Contact base material		Copper alloy	
Material of contact surface			
Pin dimensions = d	mm	0.35 x 0.8	
Solder eyelet Ø = D	mm	1.1	
Solder eyelet Ø tolerance	mm	+ 0,1	

Product data

IEC: 320 V / 17.5 A / 0.2 - 1.5 mm²
 UL: 300 V / 12 A / AWG 28 - 14



For additional articles and information, refer to catalog.weidmuller.com

Note:

- Additional push button colours on request
- Operating force of slider max. 40 N
- Rated current related to rated cross-section & min. No. of poles.
- Wire end ferrule with plastic collar to DIN 46228/4
- Wire end ferrule without plastic collar to DIN 46228/1
- P on drawing = pitch
- Rated data refer only to the component itself. Clearance and creepage distances to other components are to be designed in accordance with the relevant application standards.
- Crimping shape "A" for wire end ferrules with PZ 6/5 crimping tool recommended.
- Long term storage of the product with average temperature of 50 °C and average humidity 70%, 36 months

LSF-SMT 3.81/././180

Reflow-compatible PCB terminal



Dimensioned drawing

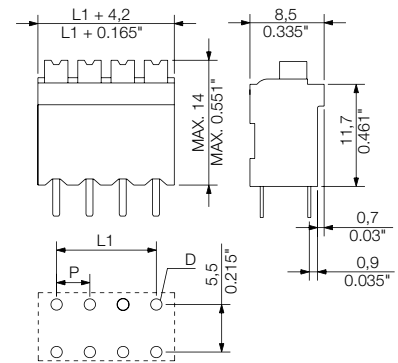

Ordering data

Solder pin length	1.5 mm		3.5 mm	
	black		black	
Pitch	3.81 mm			
Pol.	L1 (inch)	Qty.	Order No.	Order No.
2	3.81 0.150	69	1869890000	1825790000
3	7.62 0.300	46	1869900000	1825800000
4	11.43 0.450	35	1869910000	1825810000
5	15.24 0.600	28	1869920000	1825820000
6	19.05 0.750	23	1869930000	1825830000
7	22.86 0.900	20	1869940000	1825840000
8	26.67 1.050	17	1869950000	1825850000
9	30.48 1.200	15	1869960000	1825870000
10	34.29 1.350	14	1869970000	1825880000
11	38.10 1.500	13	1870000000	1825890000
12	41.91 1.650	12	1870010000	1825920000

Representative deratings curve

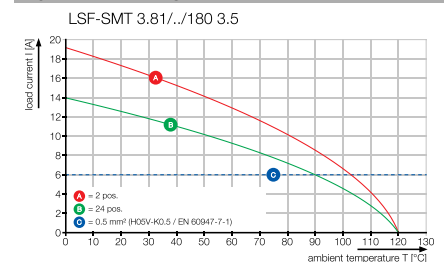

LSF-SMT 3.81../180 Tape

Reflow-compatible PCB terminal



Dimensioned drawing

Ordering data

Solder pin length		1.5 mm	3.5 mm
Colour		black	black
Pitch		3.81 mm	
Pol.	L1 (inch)	Qty.	Order No.
2	3.81	0.150	175 1875320000 1875550000
3	7.62	0.300	175 1875330000 1875570000
4	11.43	0.450	175 1875340000 1875590000
5	15.24	0.600	175 1875350000 1875650000
6	19.05	0.750	175 1875360000 1875670000
7	22.86	0.900	175 1875370000 1875680000
8	26.67	1.050	175 1875380000 1875710000
9	30.48	1.200	175 1875390000 1875730000
10	34.29	1.350	175 1875400000 1875760000
11	38.10	1.500	175 1875410000 1875810000

Belt widths: 32, 44, 56, 72, 88

Additional deratings curves

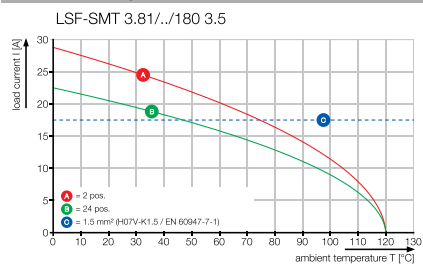

LSF-SMT 5.00/./90

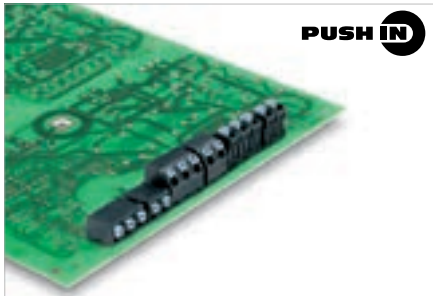

PCB terminal for fully automatic assembly in 5.00 mm pitch, for THR reflow soldering (SMT) and wave soldering.

- PUSH IN spring connection system for wire cross-sections up to 1.5 mm². Form and dimensional stability through the use of LCP insulating material.
- Wire connection and slider operation from the same direction (TOP).
- Packaged in tube or tape-on-reel.
- Pin lengths optimised to 1.5 mm or 3.5 mm.
- Wire outlet direction: 90° version

Technical data

In compliance with IEC 60664-1 / IEC 61984			
Clamping range, max.	mm ²	0.13...1.5	
Solid core H05(07) V-U	mm²	0.2...1.5	
Stranded H07 V-R			
Flexible H05(07) V-K	mm ²	0.2...1.5	
Flexible with ferrule	mm ²	0.25...1.5	
Ferrule with plastic collar	mm ²	0.25...0.75	
Stripping length	mm	8	
Screwdriver blade	mm		
According to norm			
Tightening torque range			
Rated current, max.	A	17.5	17.5
At ambient temperature		20°C	40°C
For conductor cross-section			
Overvoltage category		III	III II
Pollution severity		3	2 2
Rated voltage	V	250	320 500
Rated impulse voltage	kV	4	4 4
UL / CUL (Use Group)		B	C D
Rated voltage	V	300	300
Rated current	A	12	10
AWG conductor	AWG	28-14	
CSA (Use Group)		B	C D
Rated voltage	V	300	300
Rated current	A	10	10
AWG conductor	AWG	28-14	
General data			
Type of insulation material		LCP GF	
UL 94 flammability rating		V-0	
Contact base material		Copper alloy	
Material of contact surface			
Pin dimensions = d	mm	0.35 x 0.8	
Solder eyelet Ø = D	mm	1.1	
Solder eyelet Ø tolerance	mm	+ 0,1	

Product data

IEC: 500 V / 17.5 A / 0.2 - 1.5 mm²
 UL: 300 V / 12 A / AWG 28 - 14



For additional articles and information, refer to catalog.weidmuller.com

Note:

- Additional push button colours on request
- Operating force of slider max. 40 N
- Rated current related to rated cross-section & min. No. of poles.
- Wire end ferrule with plastic collar to DIN 46228/4
- Wire end ferrule without plastic collar to DIN 46228/1
- P on drawing = pitch
- Rated data refer only to the component itself. Clearance and creepage distances to other components are to be designed in accordance with the relevant application standards.
- Crimping shape "A" for wire end ferrules with PZ 6/5 crimping tool recommended.
- Long term storage of the product with average temperature of 50 °C and average humidity 70%, 36 months

LSF-SMT 5.00/./90

Reflow-compatible PCB terminal



Dimensioned drawing

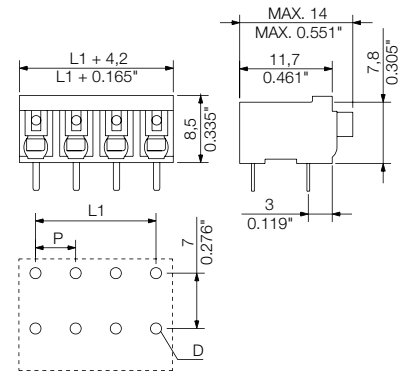

Ordering data

Solder pin length	1.5 mm		3.5 mm		
	black		black		
Pitch	5.00 mm				
Pol.	L1	(inch)	Qty.	Order No.	Order No.
2	5.00	0.197	60	1869600000	1824740000
3	10.00	0.394	39	1869610000	1824750000
4	15.00	0.591	28	1869620000	1824760000
5	20.00	0.788	22	1869630000	1824770000
6	25.00	0.985	18	1869640000	1824780000
7	30.00	1.182	16	1869650000	1824790000
8	35.00	1.379	14	1869660000	1824800000

Accessories

Note: Refer to the Accessories chapter for additional accessories.

Screwdriver		Order No.
	SDS 0.4X2.5X75	2749320000
	SDIS 0.4X2.5X75	2749790000

Representative deratings curve

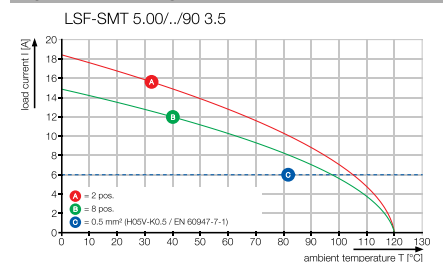

LSF-SMT 5.00/./90 Tape

Reflow-compatible PCB terminal



Dimensioned drawing

Ordering data

Solder pin length		1.5 mm	3.5 mm		
Colour		black	black		
Pitch		5.00 mm			
Pol.	L1 (inch)	Qty.	Order No.		
2	5.00	0.197	265	1876240000	1876430000
3	10.00	0.394	265	1876260000	1876510000
4	15.00	0.591	265	1876270000	1876530000
5	20.00	0.788	265	1876280000	1876550000
6	25.00	0.985	265	1876300000	1876560000
7	30.00	1.182	265	1876330000	1876540000
8	35.00	1.379	265	1876350000	1876520000

Belt widths: 32, 44, 56, 72, 88

Additional deratings curves

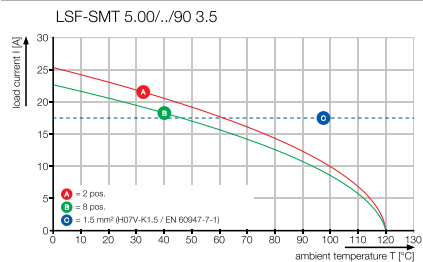

LSF-SMT 5.00/././135

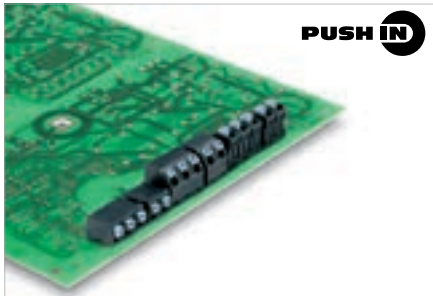

PCB terminal for fully automatic assembly in 5.00 mm pitch, for THR reflow soldering (SMT) and wave soldering.

- PUSH IN spring connection system for wire cross-sections up to 1.5 mm².
- Form and dimensional stability through the use of LCP insulating material.
- Wire connection and slider operation from the same direction (TOP).
- Packaged in tube or tape-on-reel.
- Pin lengths optimised to 1.5 mm or 3.5 mm.
- Wire outlet direction: 135° version

Technical data

In compliance with IEC 60664-1 / IEC 61984			
Clamping range, max.	mm ²	0.13...1.5	
Solid core H05(07) V-U	mm²	0.2...1.5	
Stranded H07 V-R			
Flexible H05(07) V-K	mm ²	0.2...1.5	
Flexible with ferrule	mm ²	0.25...1.5	
Ferrule with plastic collar	mm ²	0.25...0.75	
Stripping length	mm	8	
Screwdriver blade	mm		
According to norm			
Tightening torque range			
Rated current, max.	A	17.5	17.5
At ambient temperature		20°C	40°C
For conductor cross-section			
Overvoltage category		III	III II
Pollution severity		3	2 2
Rated voltage	V	250	320 500
Rated impulse voltage	kV	4	4 4
UL / CUL (Use Group)		B	C D
Rated voltage	V	300	300
Rated current	A	12	10
AWG conductor	AWG	28-14	
CSA (Use Group)		B	C D
Rated voltage	V	300	300
Rated current	A	10	10
AWG conductor	AWG	28-14	
General data			
Type of insulation material		LCP GF	
UL 94 flammability rating		V-0	
Contact base material		Copper alloy	
Material of contact surface			
Pin dimensions = d	mm	0.35 x 0.8	
Solder eyelet Ø = D	mm	1.1	
Solder eyelet Ø tolerance	mm	+ 0,1	

Product data

IEC: 500 V / 17.5 A / 0.2 - 1.5 mm²
 UL: 300 V / 12 A / AWG 28 - 14



For additional articles and information, refer to catalog.weidmueller.com

Note:

- Additional push button colours on request
- Operating force of slider max. 40 N
- Rated current related to rated cross-section & min. No. of poles.
- Wire end ferrule with plastic collar to DIN 46228/4
- Wire end ferrule without plastic collar to DIN 46228/1
- P on drawing = pitch
- Rated data refer only to the component itself. Clearance and creepage distances to other components are to be designed in accordance with the relevant application standards.
- Crimping shape "A" for wire end ferrules with PZ 6/5 crimping tool recommended.
- Long term storage of the product with average temperature of 50 °C and average humidity 70%, 36 months

LSF-SMT 5.00/././135

Reflow-compatible PCB terminal



Dimensioned drawing

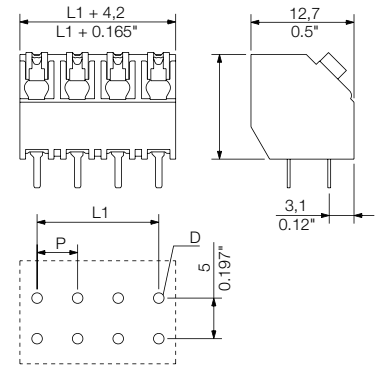

Ordering data

Solder pin length		1.5 mm	3.5 mm		
Colour		black	black		
Pitch 5.00 mm					
Pol.	L1 (inch)	Qty.	Order No.	Order No.	
2	5.00	0.197	60	1884530000	1884340000
3	10.00	0.394	39	1884540000	1884370000
4	15.00	0.591	28	1884550000	1884380000
5	20.00	0.787	22	1884560000	1884390000
6	25.00	0.984	18	1884570000	1884400000
7	30.00	1.181	16	1884580000	1884410000
8	35.00	1.378	14	1884590000	1884420000
9	40.00	1.575	12	1884600000	1884430000
10	45.00	1.772	11	1884660000	1884440000
11	50.00	1.969	10	1884670000	1884450000
12	55.00	2.165	9	1884680000	1884460000

Representative deratings curve

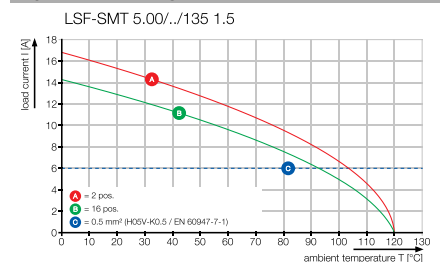

LSF-SMT 5.00/./135 Tape

Reflow-compatible PCB terminal



Dimensioned drawing

Ordering data

Solder pin length		1.5 mm	3.5 mm
Colour		black	black
Pitch		5.00 mm	
Pol.	L1 (inch)	Qty.	Order No.
2	5.00 0.197	190	1888570000 1888640000
3	10.00 0.394	190	1888580000 1888650000
4	15.00 0.591	190	1888590000 1888660000
5	20.00 0.787	190	1888600000 1888670000
6	25.00 0.984	190	1888610000 1888680000
7	30.00 1.181	190	1888620000 1888690000
8	35.00 1.378	190	1888630000 1888700000

Belt widths: 32, 44, 56, 72, 88

Additional deratings curves

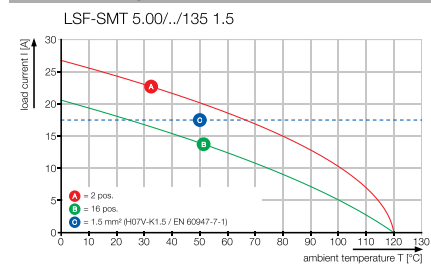

LSF-SMT 5.00/././180

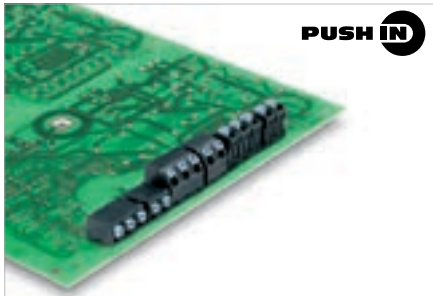

PCB terminal for fully automatic assembly in 5.00 mm pitch, for THR reflow soldering (SMT) and wave soldering.

- PUSH IN spring connection system for wire cross-sections up to 1.5 mm².
- Form and dimensional stability through the use of LCP insulating material.
- Wire connection and slider operation from the same direction (TOP).
- Packaged in tube or tape-on-reel.
- Pin lengths optimised to 1.5 mm or 3.5 mm.
- Wire outlet direction: 180° version

Technical data

In compliance with IEC 60664-1 / IEC 61984			
Clamping range, max.	mm ²	0.13...1.5	
Solid core H05(07) V-U	mm²	0.2...1.5	
Stranded H07 V-R			
Flexible H05(07) V-K	mm ²	0.2...1.5	
Flexible with ferrule	mm ²	0.25...1.5	
Ferrule with plastic collar	mm ²	0.25...0.75	
Stripping length	mm	8	
Screwdriver blade	mm		
According to norm			
Tightening torque range			
Rated current, max.	A	17.5	17.5
At ambient temperature		20°C	40°C
For conductor cross-section			
Overtoltage category		III	III II
Pollution severity		3	2 2
Rated voltage	V	250	320 500
Rated impulse voltage	kV	4	4 4
UL / CUL (Use Group)		B	C D
Rated voltage	V	300	300
Rated current	A	12	10
AWG conductor	AWG	28-14	
CSA (Use Group)		B	C D
Rated voltage	V	300	300
Rated current	A	10	10
AWG conductor	AWG	28-14	
General data			
Type of insulation material		LCP GF	
UL 94 flammability rating		V-0	
Contact base material		Copper alloy	
Material of contact surface			
Pin dimensions = d	mm	0.35 x 0.8	
Solder eyelet Ø = D	mm	1.1	
Solder eyelet Ø tolerance	mm	+ 0,1	

Product data

IEC: 500 V / 17.5 A / 0.2 - 1.5 mm²
 UL: 300 V / 12 A / AWG 28 - 14



For additional articles and information, refer to catalog.weidmuller.com

Note:

- Additional push button colours on request
- Operating force of slider max. 40 N
- Rated current related to rated cross-section & min. No. of poles.
- Wire end ferrule with plastic collar to DIN 46228/4
- Wire end ferrule without plastic collar to DIN 46228/1
- P on drawing = pitch
- Rated data refer only to the component itself. Clearance and creepage distances to other components are to be designed in accordance with the relevant application standards.
- Crimping shape "A" for wire end ferrules with PZ 6/5 crimping tool recommended.
- Long term storage of the product with average temperature of 50 °C and average humidity 70%, 36 months

LSF-SMT 5.00/././180

Reflow-compatible PCB terminal



Dimensioned drawing

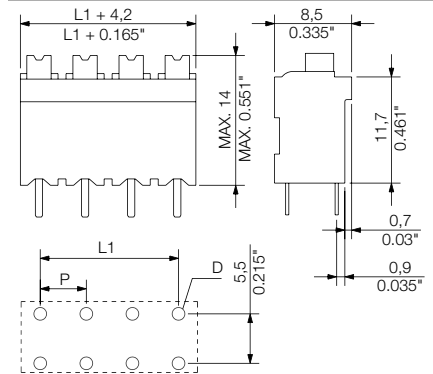

Ordering data

Solder pin length	1.5 mm		3.5 mm		
	black		black		
Pitch	5.00 mm				
Pol.	L1	(inch)	Qty.	Order No.	Order No.
2	5.00	0.197	60	1870140000	1825960000
3	10.00	0.394	39	1870150000	1825970000
4	15.00	0.591	28	1870160000	1825980000
5	20.00	0.787	22	1870170000	1825990000
6	25.00	0.984	18	1870180000	1826000000
7	30.00	1.181	16	1870190000	1826010000
8	35.00	1.378	14	1870200000	1826020000

Accessories

Note: Refer to the Accessories chapter for additional accessories.

Screwdriver		Order No.
	SDS 0.4X2.5X75	2749320000
	SDIS 0.4X2.5X75	2749790000

Representative deratings curve

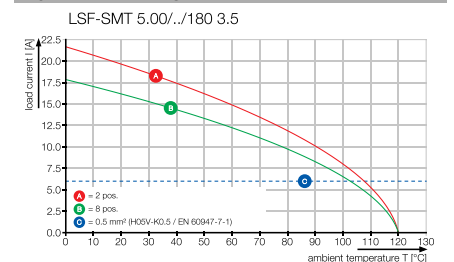

LSF-SMT 5.00/./180 Tape

Reflow-compatible PCB terminal



Dimensioned drawing

Ordering data

Solder pin length		1.5 mm	3.5 mm		
Colour		black	black		
Pitch		5.00 mm			
Pol.	L1 (inch)	Qty.	Order No.		
2	5.00	0.197	175	1876020000	1876110000
3	10.00	0.394	175	1876030000	1876130000
4	15.00	0.591	175	1876050000	1876140000
5	20.00	0.787	175	1876060000	1876160000
6	25.00	0.984	175	1876070000	1876200000
7	30.00	1.181	175	1876080000	1876220000
8	35.00	1.378	175	1876090000	1876230000

Belt widths: 32, 44, 56, 72, 88

Additional deratings curves

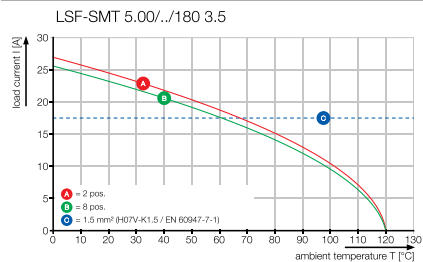

LSF-SMT 5.08/./90

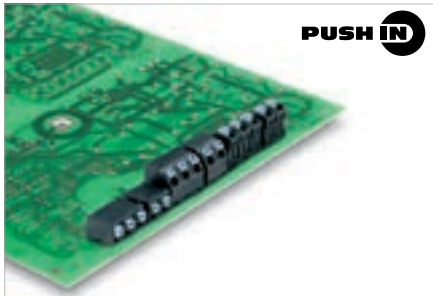

PCB terminal for fully automatic assembly in 5.08 mm pitch, for THR reflow soldering (SMT) and wave soldering.

- PUSH IN spring connection system for wire cross-sections up to 1.5 mm².
- Form and dimensional stability through the use of LCP insulating material.
- Wire connection and slider operation from the same direction (TOP).
- Packaged in tube or tape-on-reel.
- Pin lengths optimised to 1.5 mm or 3.5 mm.
- Wire outlet direction: 90° version

Technical data

In compliance with IEC 60664-1 / IEC 61984			
Clamping range, max.	mm ²	0.13...1.5	
Solid core H05(07) V-U	mm ²	0.2...1.5	
Stranded H07 V-R			
Flexible H05(07) V-K	mm ²	0.2...1.5	
Flexible with ferrule	mm ²	0.25...1.5	
Ferrule with plastic collar	mm ²	0.25...0.75	
Stripping length	mm	8	
Screwdriver blade	mm		
According to norm			
Tightening torque range			
Rated current, max.	A	17.5	17.5
At ambient temperature		20°C	40°C
For conductor cross-section			
Overtoltage category		III	III II
Pollution severity		3	2 2
Rated voltage	V	250	320 500
Rated impulse voltage	kV	4	4 4
UL / CUL (Use Group)		B	C D
Rated voltage	V	300	300
Rated current	A	12	10
AWG conductor	AWG	28-14	
CSA (Use Group)		B	C D
Rated voltage	V	300	300
Rated current	A	10	10
AWG conductor	AWG	28-14	
General data			
Type of insulation material		LCP GF	
UL 94 flammability rating		V-0	
Contact base material		Copper alloy	
Material of contact surface			
Pin dimensions = d	mm	0.35 x 0.8	
Solder eyelet Ø = D	mm	1.1	
Solder eyelet Ø tolerance	mm	+ 0,1	

Product data

IEC: 500 V / 17.5 A / 0.2 - 1.5 mm²
 UL: 300 V / 12 A / AWG 28 - 14



For additional articles and information, refer to catalog.weidmueller.com

Note:

- Additional push button colours on request
- Operating force of slider max. 40 N
- Rated current related to rated cross-section & min. No. of poles.
- Wire end ferrule with plastic collar to DIN 46228/4
- Wire end ferrule without plastic collar to DIN 46228/1
- P on drawing = pitch
- Rated data refer only to the component itself. Clearance and creepage distances to other components are to be designed in accordance with the relevant application standards.
- Crimping shape "A" for wire end ferrules with PZ 6/5 crimping tool recommended.
- Long term storage of the product with average temperature of 50 °C and average humidity 70%, 36 months

LSF-SMT 5.08/./90

Reflow-compatible PCB terminal



Dimensioned drawing

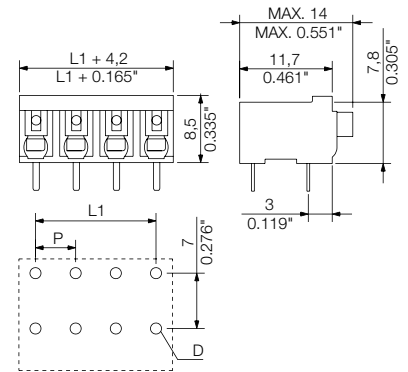

Ordering data

Solder pin length		1.5 mm	3.5 mm	
Colour		black	black	
Pitch 5.08 mm				
Pol.	L1 (inch)	Qty.	Order No.	Order No.
2	5.08 0.200	59	1869670000	1824810000
3	10.16 0.400	38	1869680000	1824820000
4	15.24 0.600	28	1869690000	1824830000
5	20.32 0.800	22	1869700000	1824840000
6	25.40 1.000	18	1869710000	1824850000
7	30.48 1.200	15	1869720000	1824860000
8	35.56 1.400	13	1869730000	1824870000

Accessories

Note: Refer to the Accessories chapter for additional accessories.

Screwdriver		Order No.
	SDS 0.4X2.5X75	2749320000
	SDIS 0.4X2.5X75	2749790000

Representative deratings curve

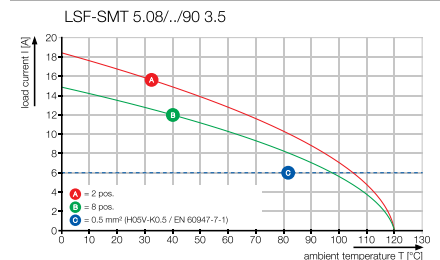

LSF-SMT 5.08/./90 Tape

Reflow-compatible PCB terminal



Dimensioned drawing

Ordering data

Solder pin length		1.5 mm	3.5 mm		
Colour		black	black		
Pitch		5.08 mm			
Pol.	L1 (inch)	Qty.	Order No.		
2	5.08	0.200	265	1876480000	1876470000
3	10.16	0.400	265	1876440000	1876420000
4	15.24	0.600	265	1878520000	1876310000
5	20.32	0.800	265	1876210000	1876190000
6	25.40	1.000	265	1876150000	1876120000
7	30.48	1.200	265	1875720000	1875690000
8	35.56	1.400	265	1875520000	1875510000

Belt widths: 32, 44, 56, 72, 88

Additional deratings curves

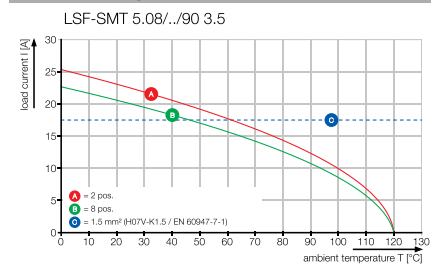

LSF-SMT 5.08/./135

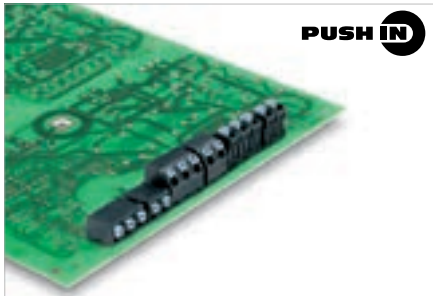

PCB terminal for fully automatic assembly in 5.08 mm pitch, for THR reflow soldering (SMT) and wave soldering.

- PUSH IN spring connection system for wire cross-sections up to 1.5 mm².
- Form and dimensional stability through the use of LCP insulating material.
- Wire connection and slider operation from the same direction (TOP).
- Packaged in tube or tape-on-reel.
- Pin lengths optimised to 1.5 mm or 3.5 mm.
- Wire outlet direction: 135° version

Technical data

In compliance with IEC 60664-1 / IEC 61984			
Clamping range, max.	mm ²	0.13...1.5	
Solid core H05(07) V-U	mm²	0.2...1.5	
Stranded H07 V-R			
Flexible H05(07) V-K	mm ²	0.2...1.5	
Flexible with ferrule	mm ²	0.25...1.5	
Ferrule with plastic collar	mm ²	0.25...0.75	
Stripping length	mm	8	
Screwdriver blade	mm		
According to norm			
Tightening torque range			
Rated current, max.	A	17.5	17.5
At ambient temperature		20°C	40°C
For conductor cross-section			
Overtoltage category		III	III II
Pollution severity		3	2 2
Rated voltage	V	250	320 500
Rated impulse voltage	kV	4	4 4
UL / CUL (Use Group)		B	C D
Rated voltage	V	300	300
Rated current	A	12	10
AWG conductor	AWG	28-14	
CSA (Use Group)		B	C D
Rated voltage	V	300	300
Rated current	A	10	10
AWG conductor	AWG	28-14	
General data			
Type of insulation material		LCP GF	
UL 94 flammability rating		V-0	
Contact base material		Copper alloy	
Material of contact surface			
Pin dimensions = d	mm	0.35 x 0.8	
Solder eyelet Ø = D	mm	1.1	
Solder eyelet Ø tolerance	mm	+ 0,1	

Product data

IEC: 500 V / 17.5 A / 0.2 - 1.5 mm²
 UL: 300 V / 12 A / AWG 28 - 14



For additional articles and information, refer to catalog.weidmueller.com

Note:

- Additional push button colours on request
- Operating force of slider max. 40 N
- Rated current related to rated cross-section & min. No. of poles.
- Wire end ferrule with plastic collar to DIN 46228/4
- Wire end ferrule without plastic collar to DIN 46228/1
- P on drawing = pitch
- Rated data refer only to the component itself. Clearance and creepage distances to other components are to be designed in accordance with the relevant application standards.
- Crimping shape "A" for wire end ferrules with PZ 6/5 crimping tool recommended.
- Long term storage of the product with average temperature of 50 °C and average humidity 70%, 36 months

LSF-SMT 5.08/./135

Reflow-compatible PCB terminal



Dimensioned drawing

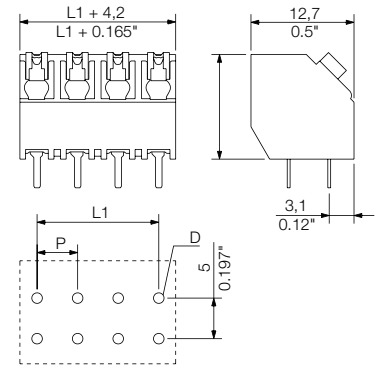

Ordering data

Solder pin length	1.5 mm		3.5 mm		
	black		black		
Pitch	5.08 mm				
Pol.	L1	(inch)	Qty.	Order No.	Order No.
2	5.08	0.200	59	1884730000	1885020000
3	10.16	0.400	38	1884740000	1885030000
4	15.24	0.600	28	1884750000	1885040000
5	20.32	0.800	22	1884760000	1885050000
6	25.40	1.000	18	1884770000	1885060000
7	30.48	1.200	15	1884780000	1885070000
8	35.56	1.400	13	1884790000	1885080000
9	40.64	1.600	12	1884800000	1885090000
10	45.72	1.800	11	1884810000	1885100000
11	50.80	2.000	10	1884820000	1885110000
12	55.88	2.200	9	1884830000	1885120000

Representative deratings curve

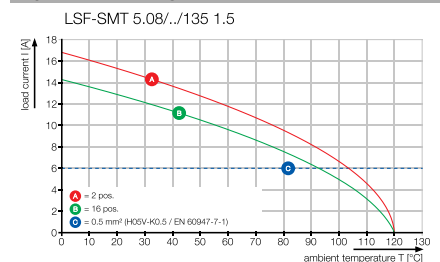

LSF-SMT 5.08/./135 Tape

Reflow-compatible PCB terminal



Dimensioned drawing

Ordering data

Solder pin length		1.5 mm	3.5 mm		
Colour		black	black		
Pitch		5.08 mm			
Pol.	L1 (inch)	Qty.	Order No.		
2	5.08	0.200	190	1888710000	1888780000
3	10.16	0.400	190	1888720000	1888790000
4	15.24	0.600	190	1888730000	1888810000
5	20.32	0.800	190	1888740000	1888830000
6	25.40	1.000	190	1888750000	1888840000
7	30.48	1.200	190	1888760000	1888870000
8	35.56	1.400	190	1888770000	1888880000

Belt widths: 32, 44, 56, 72, 88

Additional deratings curves

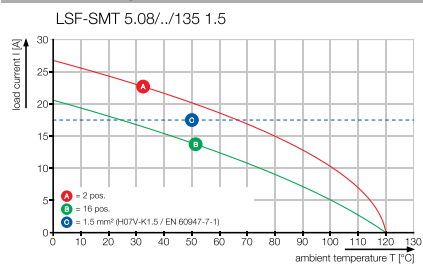

LSF-SMT 5.08/./180

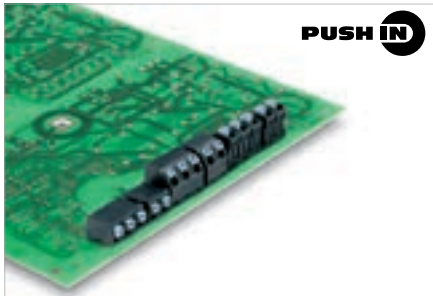

PCB terminal for fully automatic assembly in 5.08 mm pitch, for THR reflow soldering (SMT) and wave soldering.

- PUSH IN spring connection system for wire cross-sections up to 1.5 mm².
- Form and dimensional stability through the use of LCP insulating material.
- Wire connection and slider operation from the same direction (TOP).
- Packaged in tube or tape-on-reel.
- Pin lengths optimised to 1.5 mm or 3.5 mm.
- Wire outlet direction: 180° version

Technical data

In compliance with IEC 60664-1 / IEC 61984			
Clamping range, max.	mm ²	0.13...1.5	
Solid core H05(07) V-U	mm²	0.2...1.5	
Stranded H07 V-R			
Flexible H05(07) V-K	mm ²	0.2...1.5	
Flexible with ferrule	mm ²	0.25...1.5	
Ferrule with plastic collar	mm ²	0.25...0.75	
Stripping length	mm	8	
Screwdriver blade	mm		
According to norm			
Tightening torque range			
Rated current, max.	A	17.5	17.5
At ambient temperature		20°C	40°C
For conductor cross-section			
Overtoltage category		III	III II
Pollution severity		3	2 2
Rated voltage	V	250	320 500
Rated impulse voltage	kV	4	4 4
UL / CUL (Use Group)		B	C D
Rated voltage	V	300	300
Rated current	A	12	10
AWG conductor	AWG	28-14	
CSA (Use Group)		B	C D
Rated voltage	V	300	300
Rated current	A	10	10
AWG conductor	AWG	28-14	
General data			
Type of insulation material		LCP GF	
UL 94 flammability rating		V-0	
Contact base material		Copper alloy	
Material of contact surface			
Pin dimensions = d	mm	0.35 x 0.8	
Solder eyelet Ø = D	mm	1.1	
Solder eyelet Ø tolerance	mm	+ 0,1	

Product data

IEC: 500 V / 17.5 A / 0.2 - 1.5 mm²
 UL: 300 V / 12 A / AWG 28 - 14



For additional articles and information, refer to catalog.weidmuller.com

Note:

- Additional push button colours on request
- Operating force of slider max. 40 N
- Rated current related to rated cross-section & min. No. of poles.
- Wire end ferrule with plastic collar to DIN 46228/4
- Wire end ferrule without plastic collar to DIN 46228/1
- P on drawing = pitch
- Rated data refer only to the component itself. Clearance and creepage distances to other components are to be designed in accordance with the relevant application standards.
- Crimping shape "A" for wire end ferrules with PZ 6/5 crimping tool recommended.
- Long term storage of the product with average temperature of 50 °C and average humidity 70%, 36 months

LSF-SMT 5.08/./180

Reflow-compatible PCB terminal



Dimensioned drawing

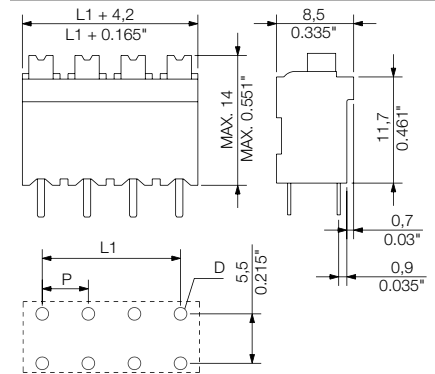

Ordering data

Solder pin length		1.5 mm	3.5 mm	
Colour		black	black	
Pitch 5.08 mm				
Pol.	L1 (inch)	Qty.	Order No.	Order No.
2	5.08 0.200	59	1870210000	1826040000
3	10.16 0.400	38	1870220000	1826060000
4	15.24 0.600	28	1870230000	1826070000
5	20.32 0.800	22	1870240000	1826080000
6	25.40 1.000	18	1870250000	1826100000
7	30.48 1.200	15	1870260000	1826110000
8	35.56 1.400	13	1870270000	1826120000

Accessories

Note: Refer to the Accessories chapter for additional accessories.

Screwdriver		Order No.
	SDS 0.4X2.5X75	2749320000
	SDIS 0.4X2.5X75	2749790000

Representative deratings curve

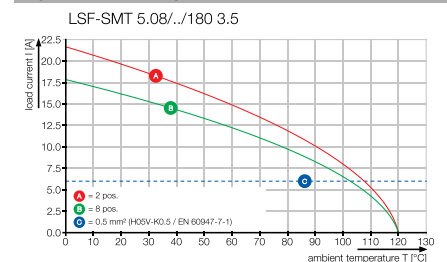

LSF-SMT 5.08/./180 Tape

Reflow-compatible PCB terminal



Dimensioned drawing

Ordering data

Solder pin length		1.5 mm	3.5 mm
Colour		black	black
Pitch		5.08 mm	
Pol.	L1 (inch)	Qty.	Order No.
2	5.08	0.200	175 1876500000 1876490000
3	10.16	0.400	175 1876460000 1876450000
4	15.24	0.600	175 1876410000 1876360000
5	20.32	0.800	175 1876290000 1876250000
6	25.40	1.000	175 1876180000 1876170000
7	30.48	1.200	175 1876100000 1875750000
8	35.56	1.400	175 1875610000 1875580000

Belt widths: 32, 44, 56, 72, 88

Additional deratings curves

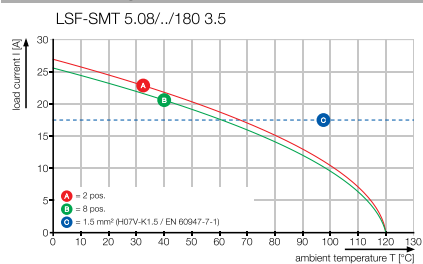

LSF-SMT 7.50/./90

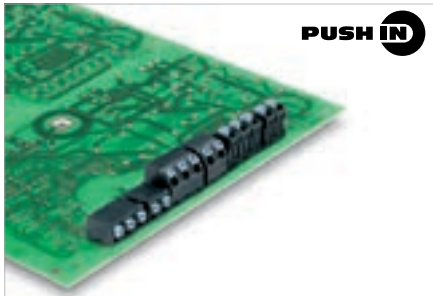

PCB terminal for fully automatic assembly in 7.50 mm pitch, for THR reflow soldering (SMT) and wave soldering.

- PUSH IN spring connection system for wire cross-sections up to 1.5 mm².
- Form and dimensional stability through the use of LCP insulating material.
- Wire connection and slider operation from the same direction (TOP).
- Packaged in tube or tape-on-reel.
- Pin lengths optimised to 1.5 mm or 3.5 mm.
- Wire outlet direction: 90° version

Technical data

In compliance with IEC 60664-1 / IEC 61984			
Clamping range, max.	mm ²	0.13...1.5	
Solid core H05(07) V-U	mm ²	0.2...1.5	
Stranded H07 V-R			
Flexible H05(07) V-K	mm ²	0.2...1.5	
Flexible with ferrule	mm ²	0.25...1.5	
Ferrule with plastic collar	mm ²	0.25...0.75	
Stripping length	mm	8	
Screwdriver blade	mm		
According to norm			
Tightening torque range			
Rated current, max.	A	17.5	17.5
At ambient temperature		20°C	40°C
For conductor cross-section			
Overtoltage category		III	III II
Pollution severity		3	2 2
Rated voltage	V	500	630 800
Rated impulse voltage	kV	6	6 6
UL / CUL (Use Group)		B	C D
Rated voltage	V	300	150 300
Rated current	A	12	10 10
AWG conductor	AWG	28-14	
CSA (Use Group)		B	C D
Rated voltage	V	300	150 300
Rated current	A	10	10 10
AWG conductor	AWG	28-14	
General data			
Type of insulation material		LCP GF	
UL 94 flammability rating		V-0	
Contact base material		Copper alloy	
Material of contact surface			
Pin dimensions = d	mm	0.35 x 0.8	
Solder eyelet Ø = D	mm	1.1	
Solder eyelet Ø tolerance	mm	+ 0,1	

Product data

IEC: 800 V / 17.5 A / 0.2 - 1.5 mm²
 UL: 300 V / 12 A / AWG 28 - 14



For additional articles and information, refer to catalog.weidmueller.com

Note:

- Additional push button colours on request
- Operating force of slider max. 40 N
- Rated current related to rated cross-section & min. No. of poles.
- Wire end ferrule with plastic collar to DIN 46228/4
- Wire end ferrule without plastic collar to DIN 46228/1
- P on drawing = pitch
- Rated data refer only to the component itself. Clearance and creepage distances to other components are to be designed in accordance with the relevant application standards.
- Crimping shape "A" for wire end ferrules with PZ 6/5 crimping tool recommended.
- Long term storage of the product with average temperature of 50 °C and average humidity 70%, 36 months

LSF-SMT 7.50/./90

Reflow-compatible PCB terminal



Dimensioned drawing

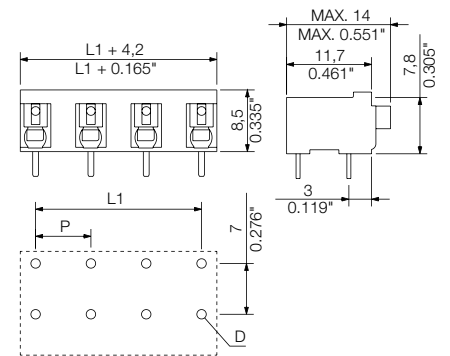

Ordering data

Solder pin length		1.5 mm	3.5 mm		
Colour		black	black		
Pitch 7.50 mm					
Pol.	L1	(inch)	Qty.	Order No.	Order No.
2	7.50	0.295	47	1869740000	1824880000
3	15.00	0.591	28	1869750000	1824890000
4	22.50	0.886	20	1869760000	1824900000
5	30.00	1.181	16	1869770000	1824910000
6	37.50	1.476	13	1869780000	1824920000
7	45.00	1.772	11	1869790000	1824930000
8	52.50	2.067	9	1869800000	1824940000

Accessories

Note: Refer to the Accessories chapter for additional accessories.

Screwdriver		Order No.
	SDS 0.4X2.5X75	2749320000
	SDIS 0.4X2.5X75	2749790000

Representative deratings curve

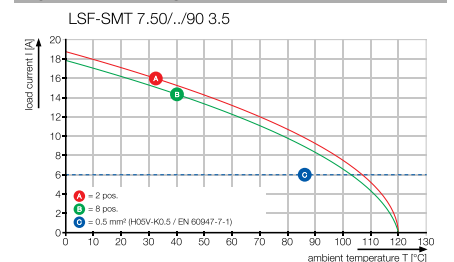

LSF-SMT 7.50/./90 Tape

Reflow-compatible PCB terminal



Dimensioned drawing

Ordering data

Solder pin length		1.5 mm	3.5 mm		
Colour		black	black		
Pitch		7.50 mm			
Pol.	L1 (inch)	Qty.	Order No.		
2	7.50	0.295	265	1875480000	1875470000
3	15.00	0.591	265	1875440000	1875430000
4	22.50	0.886	265	1875040000	1875020000
5	30.00	1.181	265	1874980000	1874960000
6	37.50	1.476	265	1874910000	1874880000

Belt widths: 32, 44, 56, 72, 88

Additional deratings curves

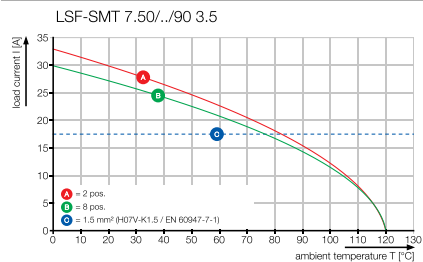

LSF-SMT 7.50/././135

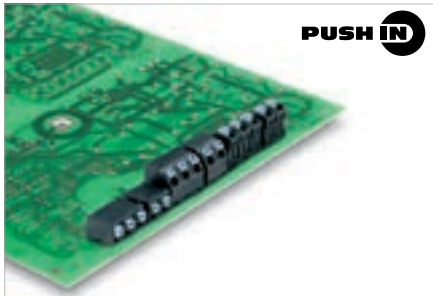

PCB terminal for fully automatic assembly in 7.50 mm pitch, for THR reflow soldering (SMT) and wave soldering.

- PUSH IN spring connection system for wire cross-sections up to 1.5 mm².
- Form and dimensional stability through the use of LCP insulating material.
- Wire connection and slider operation from the same direction (TOP).
- Packaged in tube or tape-on-reel.
- Pin lengths optimised to 1.5 mm or 3.5 mm.
- Wire outlet direction: 135° version

Technical data

In compliance with IEC 60664-1 / IEC 61984			
Clamping range, max.	mm ²	0.13...1.5	
Solid core H05(07) V-U	mm²	0.2...1.5	
Stranded H07 V-R			
Flexible H05(07) V-K	mm ²	0.2...1.5	
Flexible with ferrule	mm ²	0.25...1.5	
Ferrule with plastic collar	mm ²	0.25...0.75	
Stripping length	mm	8	
Screwdriver blade	mm		
According to norm			
Tightening torque range			
Rated current, max.	A	17.5	17.5
At ambient temperature		20°C	40°C
For conductor cross-section			
Overtoltage category		III	III II
Pollution severity		3	2 2
Rated voltage	V	500	630 800
Rated impulse voltage	kV	6	6 6
UL / CUL (Use Group)		B	C D
Rated voltage	V	300	300
Rated current	A	12	10
AWG conductor	AWG	28-14	
CSA (Use Group)		B	C D
Rated voltage	V	300	300
Rated current	A	10	10
AWG conductor	AWG	28-14	
General data			
Type of insulation material		LCP GF	
UL 94 flammability rating		V-0	
Contact base material		Copper alloy	
Material of contact surface			
Pin dimensions = d	mm	0.35 x 0.8	
Solder eyelet Ø = D	mm	1.1	
Solder eyelet Ø tolerance	mm	+ 0,1	

Product data

IEC: 800 V / 17.5 A / 0.2 - 1.5 mm²
 UL: 300 V / 12 A / AWG 28 - 14



For additional articles and information, refer to catalog.weidmueller.com

Note:

- Additional push button colours on request
- Operating force of slider max. 40 N
- Rated current related to rated cross-section & min. No. of poles.
- Wire end ferrule with plastic collar to DIN 46228/4
- Wire end ferrule without plastic collar to DIN 46228/1
- P on drawing = pitch
- Rated data refer only to the component itself. Clearance and creepage distances to other components are to be designed in accordance with the relevant application standards.
- Crimping shape "A" for wire end ferrules with PZ 6/5 crimping tool recommended.
- Long term storage of the product with average temperature of 50 °C and average humidity 70%, 36 months

LSF-SMT 7.50/././135

Reflow-compatible PCB terminal



Dimensioned drawing

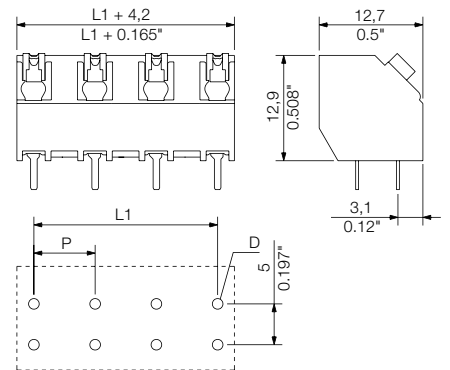

Ordering data

Solder pin length		1.5 mm	3.5 mm		
Colour		black	black		
Pitch 7.50 mm					
Pol.	L1 (inch)	Qty.	Order No.	Order No.	
2	7.50	0.295	47	1884880000	1886110000
3	15.00	0.591	28	1884890000	1886120000
4	22.50	0.886	20	1884900000	1886130000
5	30.00	1.181	16	1884910000	1886140000
6	37.50	1.476	13	1884920000	1886150000
7	45.00	1.772	11	1884930000	1886160000
8	52.50	2.067	9	1884940000	1886170000

Accessories

Note: Refer to the Accessories chapter for additional accessories.

Screwdriver		Order No.
	SDS 0.4X2.5X75	2749320000
	SDIS 0.4X2.5X75	2749790000

Representative deratings curve

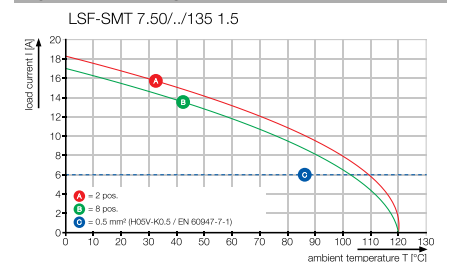

LSF-SMT 7.50/./135 Tape

Reflow-compatible PCB terminal



Dimensioned drawing

Ordering data

Solder pin length		1.5 mm	3.5 mm
Colour		black	black
Pitch		7.50 mm	
Pol.	L1 (inch)	Qty.	Order No.
2	7.50 0.295	190	1888890000 1888970000
3	15.00 0.591	190	1888910000 1888990000
4	22.50 0.886	190	1888930000 1889000000
5	30.00 1.181	190	1888940000 1889020000
6	37.50 1.476	190	1888950000 1889030000

Belt widths: 32, 44, 56, 72, 88

Additional deratings curves

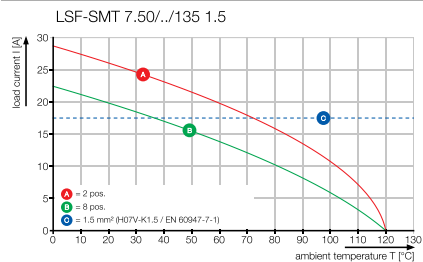

LSF-SMT 7.50/./180

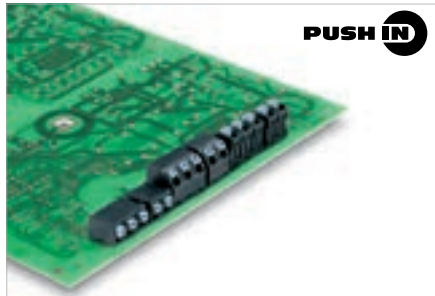

PCB terminal for fully automatic assembly in 7.50 mm pitch, for THR reflow soldering (SMT) and wave soldering.

- PUSH IN spring connection system for wire cross-sections up to 1.5 mm².
- Form and dimensional stability through the use of LCP insulating material.
- Wire connection and slider operation from the same direction (TOP).
- Packaged in tube or tape-on-reel.
- Pin lengths optimised to 1.5 mm or 3.5 mm.
- Wire outlet direction: 180° version

Product data

IEC: 800 V / 17.5 A / 0.2 - 1.5 mm²
UL: 300 V / 12 A / AWG 28 - 14



For additional articles and information, refer to catalog.weidmueller.com

Note:

- Additional push button colours on request
- Operating force of slider max. 40 N
- Rated current related to rated cross-section & min. No. of poles.
- Wire end ferrule with plastic collar to DIN 46228/4
- Wire end ferrule without plastic collar to DIN 46228/1
- P on drawing = pitch
- Rated data refer only to the component itself. Clearance and creepage distances to other components are to be designed in accordance with the relevant application standards.
- Crimping shape "A" for wire end ferrules with PZ 6/5 crimping tool recommended.
- Long term storage of the product with average temperature of 50 °C and average humidity 70%, 36 months

LSF-SMT 7.50/./180

Reflow-compatible PCB terminal



Dimensioned drawing

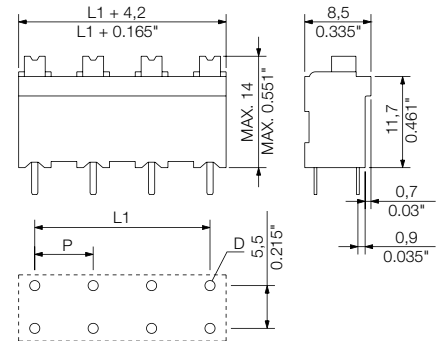

Ordering data

Solder pin length		1.5 mm	3.5 mm	
Colour		black	black	
Pitch 7.50 mm				
Pol.	L1 (inch)	Qty.	Order No.	Order No.
2	7.50 0.295	47	1870280000	1826130000
3	15.00 0.591	28	1870290000	1826140000
4	22.50 0.886	20	1870300000	1826150000
5	30.00 1.181	16	1870310000	1826160000
6	37.50 1.476	13	1870320000	1826170000
7	45.00 1.772	11	1870330000	1826180000
8	52.50 2.067	9	1870340000	1826190000

Representative deratings curve

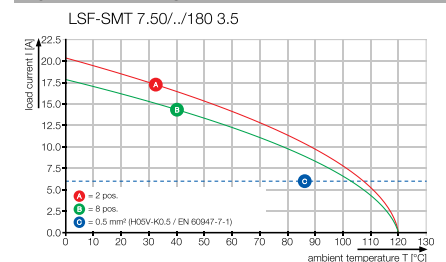

Technical data

In compliance with IEC 60664-1 / IEC 61984			
Clamping range, max.	mm ²	0.13...1.5	
Solid core H05(07) V-U	mm²	0.2...1.5	
Stranded H07 V-R			
Flexible H05(07) V-K	mm ²	0.2...1.5	
Flexible with ferrule	mm ²	0.25...1.5	
Ferrule with plastic collar	mm ²	0.25...0.75	
Stripping length	mm	8	
Screwdriver blade	mm		
According to norm			
Tightening torque range			
Rated current, max.	A	17.5	17.5
At ambient temperature		20°C	40°C
For conductor cross-section			
Overtoltage category		III	III II
Pollution severity		3	2 2
Rated voltage	V	500	630 800
Rated impulse voltage	kV	6	6 6
UL / CUL (Use Group)		B	C D
Rated voltage	V	300	150 300
Rated current	A	12	10 10
AWG conductor	AWG	28-14	
CSA (Use Group)		B	C D
Rated voltage	V	300	150 300
Rated current	A	10	10 10
AWG conductor	AWG	28-14	
General data			
Type of insulation material		LCP GF	
UL 94 flammability rating		V-0	
Contact base material		Copper alloy	
Material of contact surface			
Pin dimensions = d	mm	0.35 x 0.8	
Solder eyelet Ø = D	mm	1.1	
Solder eyelet Ø tolerance	mm	+ 0,1	

Accessories

Note: Refer to the Accessories chapter for additional accessories.

Screwdriver		Order No.
	SDS 0.4X2.5X75	2749320000
	SDIS 0.4X2.5X75	2749790000

7.50

180°

1.5 mm²

LSF-SMT 7.50/./180 Tape

Reflow-compatible PCB terminal



Dimensioned drawing

Ordering data

Solder pin length		1.5 mm	3.5 mm
Colour		black	black
Pitch		7.50 mm	
Pol.	L1 (inch)	Qty.	Order No.
2	7.50 0.295	175	1875500000 1875490000
3	15.00 0.591	175	1875460000 1875450000
4	22.50 0.886	175	1875090000 1875060000
5	30.00 1.181	175	1875010000 1875000000
6	37.50 1.476	175	1874950000 1874920000

Belt widths: 32, 44, 56, 72, 88

Additional deratings curves

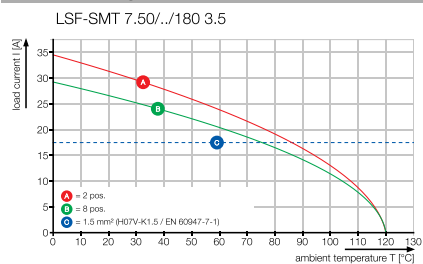

LSF-SMT 7.62/./90

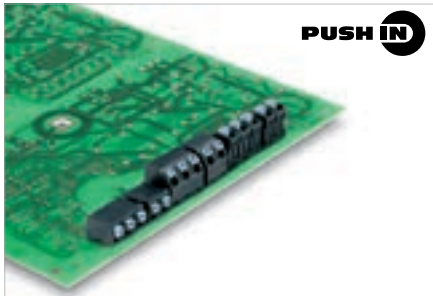

PCB terminal for fully automatic assembly in 7.62 mm pitch, for THR reflow soldering (SMT) and wave soldering.

- PUSH IN spring connection system for wire cross-sections up to 1.5 mm².
- Form and dimensional stability through the use of LCP insulating material.
- Wire connection and slider operation from the same direction (TOP).
- Packaged in tube or tape-on-reel.
- Pin lengths optimised to 1.5 mm or 3.5 mm.
- Wire outlet direction: 90° version

Technical data

In compliance with IEC 60664-1 / IEC 61984			
Clamping range, max.	mm ²	0.13...1.5	
Solid core H05(07) V-U	mm²	0.2...1.5	
Stranded H07 V-R			
Flexible H05(07) V-K	mm ²	0.2...1.5	
Flexible with ferrule	mm ²	0.25...1.5	
Ferrule with plastic collar	mm ²	0.25...0.75	
Stripping length	mm	8	
Screwdriver blade	mm		
According to norm			
Tightening torque range			
Rated current, max.	A	17.5	17.5
At ambient temperature		20°C	40°C
For conductor cross-section			
Overtoltage category		III	III II
Pollution severity		3	2 2
Rated voltage	V	500	630 800
Rated impulse voltage	kV	6	6 6
UL / CUL (Use Group)		B	C D
Rated voltage	V	300	150 300
Rated current	A	12	10 10
AWG conductor	AWG	28-14	
CSA (Use Group)		B	C D
Rated voltage	V	300	150 300
Rated current	A	10	10 10
AWG conductor	AWG	28-14	
General data			
Type of insulation material		LCP GF	
UL 94 flammability rating		V-0	
Contact base material		Copper alloy	
Material of contact surface			
Pin dimensions = d	mm	0.35 x 0.8	
Solder eyelet Ø = D	mm	1.1	
Solder eyelet Ø tolerance	mm	+ 0,1	

Product data

IEC: 800 V / 17.5 A / 0.2 - 1.5 mm²
 UL: 300 V / 12 A / AWG 28 - 14



For additional articles and information, refer to catalog.weidmueller.com

Note:

- Additional push button colours on request
- Operating force of slider max. 40 N
- Rated current related to rated cross-section & min. No. of poles.
- Wire end ferrule with plastic collar to DIN 46228/4
- Wire end ferrule without plastic collar to DIN 46228/1
- P on drawing = pitch
- Rated data refer only to the component itself. Clearance and creepage distances to other components are to be designed in accordance with the relevant application standards.
- Crimping shape "A" for wire end ferrules with PZ 6/5 crimping tool recommended.
- Long term storage of the product with average temperature of 50 °C and average humidity 70%, 36 months

LSF-SMT 7.62/./90

Reflow-compatible PCB terminal



Dimensioned drawing

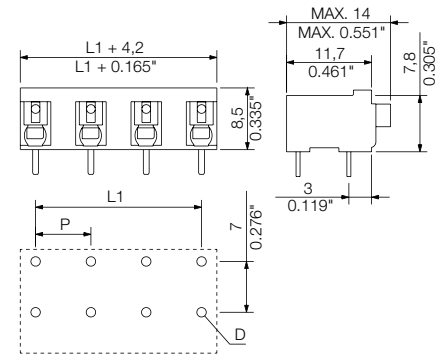

Ordering data

Solder pin length		1.5 mm	3.5 mm		
Colour		black	black		
Pitch 7.62 mm					
Pol.	L1	(inch)	Qty.	Order No.	Order No.
2	7.62	0.300	46	1869260000	1824950000
3	15.24	0.600	28	1869270000	1824960000
4	22.86	0.900	20	1869280000	1824970000
5	30.48	1.200	15	1869290000	1824980000
6	38.10	1.500	13	1869300000	1824990000
7	45.72	1.800	11	1869310000	1825000000
8	53.34	2.100	9	1869320000	1825010000

Accessories

Note: Refer to the Accessories chapter for additional accessories.

Screwdriver		Order No.
	SDS 0.4X2.5X75	2749320000
	SDIS 0.4X2.5X75	2749790000

Representative deratings curve

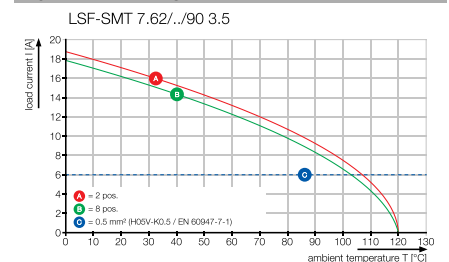

LSF-SMT 7.62/./90 Tape

Reflow-compatible PCB terminal



Dimensioned drawing

Ordering data

Solder pin length		1.5 mm	3.5 mm		
Colour		black	black		
Pitch		7.62 mm			
Pol.	L1 (inch)	Qty.	Order No.		
2	7.62	0.300	265	1874700000	1874670000
3	15.24	0.600	265	1874570000	1874550000
4	22.86	0.900	265	1874480000	1874470000
5	30.48	1.200	265	1874430000	1874410000
6	38.10	1.500	265	1874330000	1874290000

Belt widths: 32, 44, 56, 72, 88

Additional deratings curves

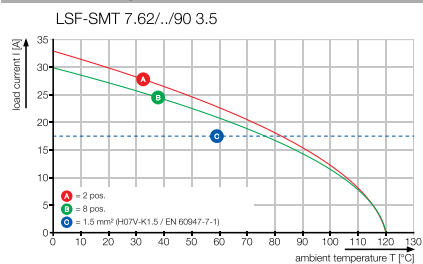

LSF-SMT 7.62/././135

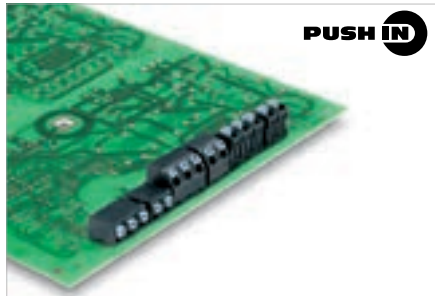

PCB terminal for fully automatic assembly in 7.62 mm pitch, for THR reflow soldering (SMT) and wave soldering.

- PUSH IN spring connection system for wire cross-sections up to 1.5 mm².
- Form and dimensional stability through the use of LCP insulating material.
- Wire connection and slider operation from the same direction (TOP).
- Packaged in tube or tape-on-reel.
- Pin lengths optimised to 1.5 mm or 3.5 mm.
- Wire outlet direction: 135° version

Technical data

In compliance with IEC 60664-1 / IEC 61984			
Clamping range, max.	mm ²	0.13...1.5	
Solid core H05(07) V-U	mm²	0.2...1.5	
Stranded H07 V-R			
Flexible H05(07) V-K	mm ²	0.2...1.5	
Flexible with ferrule	mm ²	0.25...1.5	
Ferrule with plastic collar	mm ²	0.25...0.75	
Stripping length	mm	8	
Screwdriver blade	mm		
According to norm			
Tightening torque range			
Rated current, max.	A	17.5	17.5
At ambient temperature		20°C	40°C
For conductor cross-section			
Overtoltage category		III	III II
Pollution severity		3	2 2
Rated voltage	V	500	630 800
Rated impulse voltage	kV	6	6 6
UL / CUL (Use Group)		B	C D
Rated voltage	V	300	300
Rated current	A	12	10
AWG conductor	AWG	28-14	
CSA (Use Group)		B	C D
Rated voltage	V	300	300
Rated current	A	10	10
AWG conductor	AWG	28-14	
General data			
Type of insulation material		LCP GF	
UL 94 flammability rating		V-0	
Contact base material		Copper alloy	
Material of contact surface			
Pin dimensions = d	mm	0.35 x 0.8	
Solder eyelet Ø = D	mm	1.1	
Solder eyelet Ø tolerance	mm	+ 0,1	

Product data

IEC: 800 V / 17.5 A / 0.2 - 1.5 mm²
UL: 300 V / 12 A / AWG 28 - 14



For additional articles and information, refer to catalog.weidmuller.com

Note:

- Additional push button colours on request
- Operating force of slider max. 40 N
- Rated current related to rated cross-section & min. No. of poles.
- Wire end ferrule with plastic collar to DIN 46228/4
- Wire end ferrule without plastic collar to DIN 46228/1
- P on drawing = pitch
- Rated data refer only to the component itself. Clearance and creepage distances to other components are to be designed in accordance with the relevant application standards.
- Crimping shape "A" for wire end ferrules with PZ 6/5 crimping tool recommended.
- Long term storage of the product with average temperature of 50 °C and average humidity 70%, 36 months

LSF-SMT 7.62/././135

Reflow-compatible PCB terminal



Dimensioned drawing

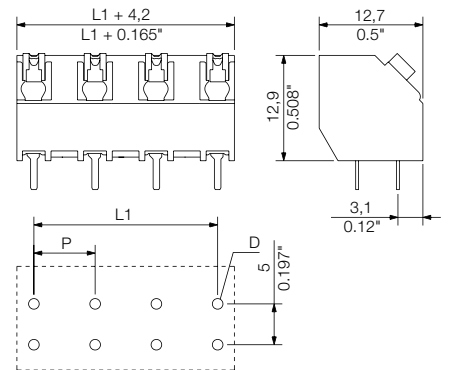

Ordering data

Solder pin length	1.5 mm		3.5 mm	
	black		black	
Pitch	7.62 mm			
Pol.	L1 (inch)	Qty.	Order No.	Order No.
2	7.62 0.300	46	1884950000	1886180000
3	15.24 0.600	28	1884960000	1886190000
4	22.86 0.900	20	1884970000	1886200000
5	30.48 1.200	15	1884980000	1886210000
6	38.10 1.500	13	1884990000	1886220000
7	45.72 1.800	11	1885000000	1886230000
8	53.34 2.100	9	1885010000	1886240000

Accessories

Note: Refer to the Accessories chapter for additional accessories.

Screwdriver		Order No.
	SDS 0.4X2.5X75	2749320000
	SDIS 0.4X2.5X75	2749790000

Representative deratings curve

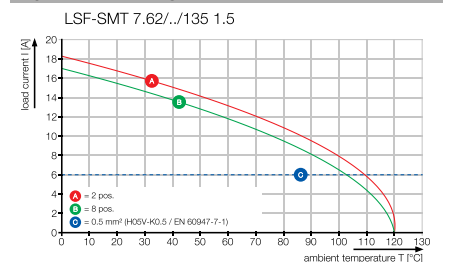

LSF-SMT 7.62/./135 Tape

Reflow-compatible PCB terminal



Dimensioned drawing

Ordering data

Solder pin length		1.5 mm	3.5 mm		
Colour		black	black		
Pitch		7.62 mm			
Pol.	L1 (inch)	Qty.	Order No.		
2	7.62	0.300	190	1887110000	1887160000
3	15.24	0.600	190	1887120000	1887170000
4	22.86	0.900	190	1887130000	1887180000
5	30.48	1.200	190	1887140000	1887190000
6	38.10	1.500	190	1887150000	1887200000

Belt widths: 32, 44, 56, 72, 88

Additional deratings curves

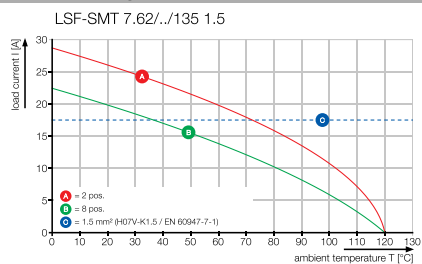

LSF-SMT 7.62/././180

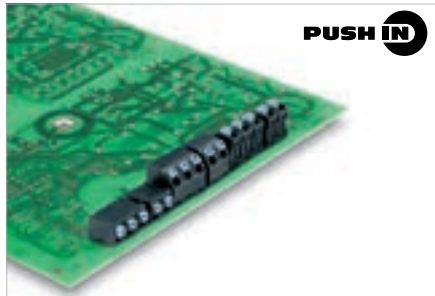

PCB terminal for fully automatic assembly in 7.62 mm pitch, for THR reflow soldering (SMT) and wave soldering.

- PUSH IN spring connection system for wire cross-sections up to 1.5 mm².
- Form and dimensional stability through the use of LCP insulating material.
- Wire connection and slider operation from the same direction (TOP).
- Packaged in tube or tape-on-reel.
- Pin lengths optimised to 1.5 mm or 3.5 mm.
- Wire outlet direction: 180° version

Technical data

In compliance with IEC 60664-1 / IEC 61984			
Clamping range, max.	mm ²	0.13...1.5	
Solid core H05(07) V-U	mm²	0.2...1.5	
Stranded H07 V-R			
Flexible H05(07) V-K	mm ²	0.2...1.5	
Flexible with ferrule	mm ²	0.25...1.5	
Ferrule with plastic collar	mm ²	0.25...0.75	
Stripping length	mm	8	
Screwdriver blade	mm		
According to norm			
Tightening torque range			
Rated current, max.	A	17.5	17.5
At ambient temperature		20°C	40°C
For conductor cross-section			
Overvoltage category		III	III II
Pollution severity		3	2 2
Rated voltage	V	500	630 800
Rated impulse voltage	kV	6	6 6
UL / CUL (Use Group)		B	C D
Rated voltage	V	300	150 300
Rated current	A	12	10 10
AWG conductor	AWG	28-14	
CSA (Use Group)		B	C D
Rated voltage	V	300	150 300
Rated current	A	10	10 10
AWG conductor	AWG	28-14	
General data			
Type of insulation material		LCP GF	
UL 94 flammability rating		V-0	
Contact base material		Copper alloy	
Material of contact surface			
Pin dimensions = d	mm	0.35 x 0.8	
Solder eyelet Ø = D	mm	1.1	
Solder eyelet Ø tolerance	mm	+ 0,1	

7.62

180°

1.5 mm²

Product data

IEC: 800 V / 17.5 A / 0.2 - 1.5 mm²
 UL: 300 V / 12 A / AWG 28 - 14



For additional articles and information, refer to catalog.weidmueller.com

Note:

- Additional push button colours on request
- Operating force of slider max. 40 N
- Rated current related to rated cross-section & min. No. of poles.
- Wire end ferrule with plastic collar to DIN 46228/4
- Wire end ferrule without plastic collar to DIN 46228/1
- P on drawing = pitch
- Rated data refer only to the component itself. Clearance and creepage distances to other components are to be designed in accordance with the relevant application standards.
- Crimping shape "A" for wire end ferrules with PZ 6/5 crimping tool recommended.
- Long term storage of the product with average temperature of 50 °C and average humidity 70%, 36 months

Accessories

Note: Refer to the Accessories chapter for additional accessories.

Screwdriver		Order No.
	SDS 0.4X2.5X75	2749320000
	SDIS 0.4X2.5X75	2749790000

LSF-SMT 7.62/././180

Reflow-compatible PCB terminal



Dimensioned drawing

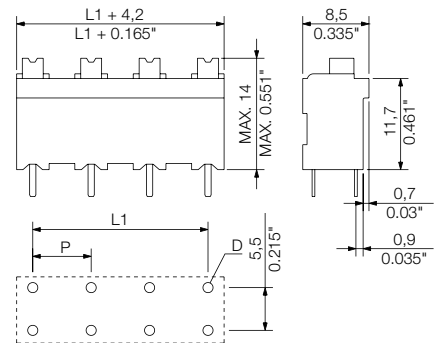

Ordering data

Solder pin length	1.5 mm		3.5 mm		
	black		black		
Pitch	7.62 mm				
Pol.	L1	(inch)	Qty.	Order No.	Order No.
2	7.62	0.300	46	1869810000	1826210000
3	15.24	0.600	28	1869830000	1826220000
4	22.86	0.900	20	1869840000	1826230000
5	30.48	1.200	15	1869850000	1826240000
6	38.10	1.500	13	1869860000	1826250000
7	45.72	1.800	11	1869870000	1826260000
8	53.34	2.100	9	1869880000	1826270000

Representative deratings curve

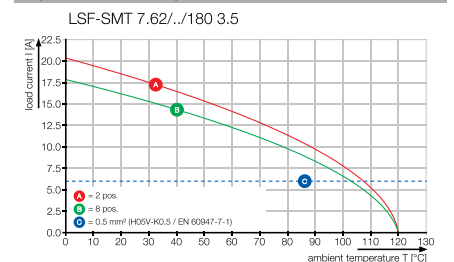

LSF-SMT 7.62/././180 Tape

Reflow-compatible PCB terminal



Dimensioned drawing

Ordering data

Solder pin length		1.5 mm	3.5 mm		
Colour		black	black		
Pitch		7.62 mm			
Pol.	L1 (inch)	Qty.	Order No.		
2	7.62	0.300	175	1874870000	1874750000
3	15.24	0.600	175	1874650000	1874630000
4	22.86	0.900	175	1874530000	1874500000
5	30.48	1.200	175	1874450000	1874460000
6	38.10	1.500	175	1874390000	1874360000

Belt widths: 32, 44, 56, 72, 88

Additional deratings curves

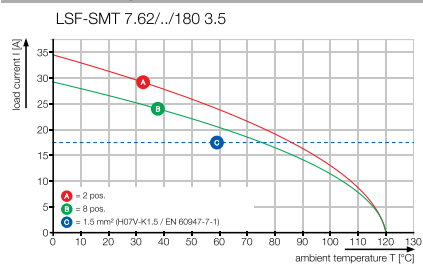

LSF-SMD 3.50

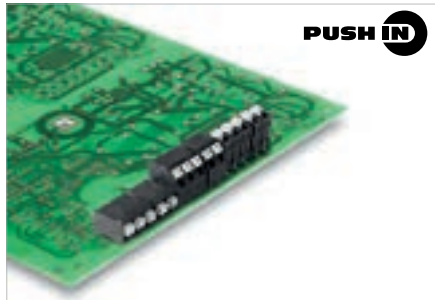

PCB terminal for fully automatic assembly using reflow soldering (SMD), with PUSH IN wire connections. Conductor insertion and slider operation from the same direction (TOP).

- Solid & flexible conductors with wire-end ferrules need only to be inserted and they are ready.
- When connecting stranded wires without wire-end ferrules the actuating element is used to open the terminal point
- Intuitive handling – since the wire-entry area and handling area are clearly separated.
- Packaged in tape-on-reel
- Conductor outlet direction 180°

Technical data

In compliance with IEC 60664-1 / IEC 61984			
Clamping range, max.	mm ²	0.13...1.5	
Solid core H05(07) V-U	mm²	0.2...1.5	
Stranded H07 V-R			
Flexible H05(07) V-K	mm ²	0.2...1.5	
Flexible with ferrule	mm ²	0.25...1.5	
Ferrule with plastic collar	mm ²	0.25...0.75	
Stripping length	mm	8	
Screwdriver blade	mm		
According to norm			
Tightening torque range			
Rated current, max.	A	17.5	17.5
At ambient temperature	20°C	40°C	
For conductor cross-section			
Overtoltage category		III	III II
Pollution severity		3	2 2
Rated voltage	V	160	160 320
Rated impulse voltage	kV	2.5	2.5 2.5
UL / CUL (Use Group)		B	C D
Rated voltage	V	300	300
Rated current	A	12	10
AWG conductor	AWG	28-14	
CSA (Use Group)		B	C D
Rated voltage	V	300	300
Rated current	A	10	10
AWG conductor	AWG	28-14	
General data			
Type of insulation material		LCP GF	
UL 94 flammability rating		V-0	
Contact base material		Copper alloy	
Material of contact surface			
Pin dimensions = d	mm		
Solder eyelet Ø = D	mm		
Solder eyelet Ø tolerance	mm		

Product data

IEC: 320 V / 17.5 A / 0.2 - 1.5 mm²
 UL: 300 V / 12 A / AWG 28 - 14



For additional articles and information, refer to catalog.weidmueller.com

Note:

- Additional push button colours on request
- Operating force of slider max. 40 N
- Rated current related to rated cross-section & min. No. of poles.
- Wire end ferrule with plastic collar to DIN 46228/4
- Wire end ferrule without plastic collar to DIN 46228/1
- P on drawing = pitch
- Rated data refer only to the component itself. Clearance and creepage distances to other components are to be designed in accordance with the relevant application standards.
- Crimping shape "A" for wire end ferrules with PZ 6/5 crimping tool recommended.
- Long term storage of the product with average temperature of 50 °C and average humidity 70%, 36 months

LSF-SMD 3.50/. /90 Tape

Reflow-compatible circuit board terminal



Dimensioned drawing

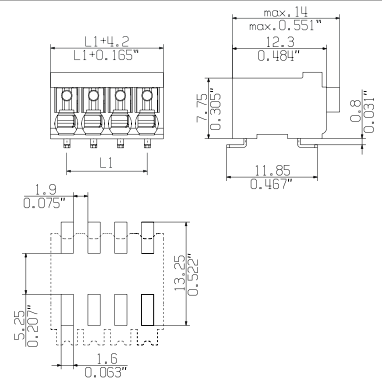

Ordering data

Solder pin length				
Colour	black			
Pitch	3.50 mm			
Pol.	L1	(inch)	Qty.	Order No.
2	3.50	0.138	320	1412410000
3	7.00	0.276	320	1412420000
4	10.50	0.414	320	1473510000
5	14.00	0.552	320	1473520000
6	17.50	0.690	320	1473530000
7	21.00	0.828	320	1473540000
8	24.50	0.966	320	1473550000
9	28.00	1.104	320	1473570000
10	31.50	1.242	320	1473590000
11	35.00	1.380	320	1473620000
12	38.50	1.518	320	1473650000

Accessories

Note: Refer to the Accessories chapter for additional accessories.

Screwdriver		Order No.
	SDS 0.4X2.5X75	2749320000
	SDIS 0.4X2.5X75	2749790000

Representative deratings curve

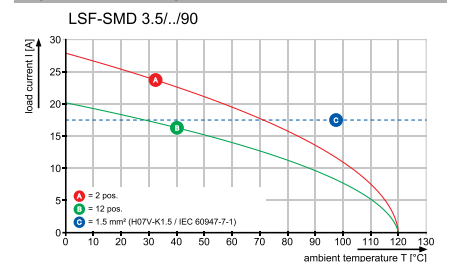

LSF-SMD 3.50../135 Tape

Reflow-compatible circuit board terminal



Dimensioned drawing

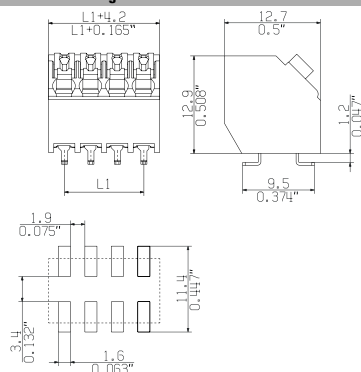

Ordering data

Solder pin length					
Colour					black
Pitch 3.50 mm					
Pol.	L1	(inch)	Qty.	Order No.	
2	3.50	0.138	210	1473310000	
3	7.00	0.276	210	1473320000	
4	10.50	0.414	210	1473330000	
5	14.00	0.552	210	1473340000	
6	17.50	0.690	210	1473350000	
7	21.00	0.828	210	1473370000	
8	24.50	0.966	210	1473380000	
9	28.00	1.104	210	1473390000	
10	31.50	1.242	210	1473410000	
11	35.00	1.380	210	1473420000	
12	38.50	1.518	210	1473430000	

LSF-SMD 3.50/180 Tape

Reflow-compatible PCB terminal



Dimensioned drawing

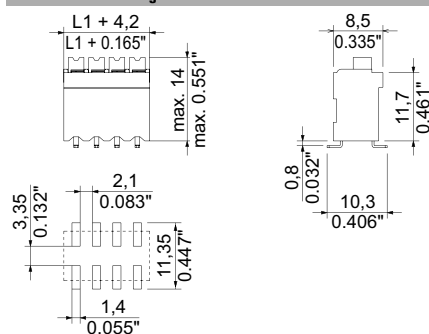

Ordering data

Solder pin length					
Colour					black
Pitch 3.50 mm					
Pol.	L1	(inch)	Qty.	Order No.	
2	3.50	0.138	235	1250360000	
3	7.00	0.276	180	1250370000	
4	10.50	0.414	180	1250380000	
5	14.00	0.552	180	1250390000	
6	17.50	0.690	180	1250410000	
7	21.00	0.828	180	1250420000	
8	24.50	0.966	180	1250430000	
9	28.00	1.104	180	1250440000	
10	31.50	1.242	180	1250450000	
11	35.00	1.380	180	1250460000	
12	38.50	1.518	180	1250470000	

G

Additional deratings curves

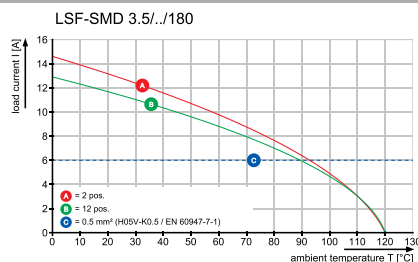
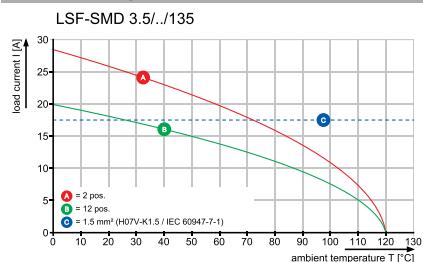

LSF-SMD 5.00

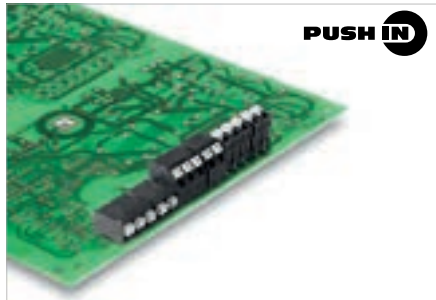

PCB terminal for fully automatic assembly using reflow soldering (SMD), with PUSH IN wire connections. Conductor insertion and slider operation from the same direction (TOP).

- Solid & flexible conductors with wire-end ferrules need only to be inserted and they are ready.
- When connecting stranded wires without wire-end ferrules the actuating element is used to open the terminal point
- Intuitive handling – since the wire-entry area and handling area are clearly separated.
- Packaged in tape-on-reel
- Conductor outlet direction 180°

Technical data

In compliance with IEC 60664-1 / IEC 61984			
Clamping range, max.	mm ²	0.13...1.5	
Solid core H05(07) V-U	mm²	0.2...1.5	
Stranded H07 V-R			
Flexible H05(07) V-K	mm ²	0.2...1.5	
Flexible with ferrule	mm ²	0.25...1.5	
Ferrule with plastic collar	mm ²	0.25...0.75	
Stripping length	mm	8	
Screwdriver blade	mm		
According to norm			
Tightening torque range			
Rated current, max.	A	17.5	17.5
At ambient temperature	20°C	40°C	
For conductor cross-section			
Overvoltage category		III	III II
Pollution severity		3	2 2
Rated voltage	V	250	320 500
Rated impulse voltage	kV	4	4 4
UL / CUL (Use Group)		B	C D
Rated voltage	V	300	300
Rated current	A	12	10
AWG conductor	AWG	28-14	
CSA (Use Group)		B	C D
Rated voltage	V	300	300
Rated current	A	10	10
AWG conductor	AWG	28-14	
General data			
Type of insulation material		LCP GF	
UL 94 flammability rating		V-0	
Contact base material		Copper alloy	
Material of contact surface			
Pin dimensions = d	mm		
Solder eyelet Ø = D	mm		
Solder eyelet Ø tolerance	mm		

Product data

IEC: 500 V / 17.5 A / 0.2 - 1.5 mm²
 UL: 300 V / 12 A / AWG 28 - 14



For additional articles and information, refer to catalog.weidmueller.com

Note:

- Additional push button colours on request
- Operating force of slider max. 40 N
- Rated current related to rated cross-section & min. No. of poles.
- Wire end ferrule with plastic collar to DIN 46228/4
- Wire end ferrule without plastic collar to DIN 46228/1
- P on drawing = pitch
- Rated data refer only to the component itself. Clearance and creepage distances to other components are to be designed in accordance with the relevant application standards.
- Crimping shape "A" for wire end ferrules with PZ 6/5 crimping tool recommended.
- Long term storage of the product with average temperature of 50 °C and average humidity 70%, 36 months

LSF-SMD 5.00/.90 Tape

Reflow-compatible circuit board terminal



Dimensioned drawing

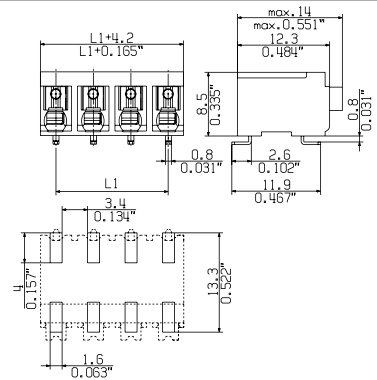

Ordering data

Solder pin length				
Colour	black			
Pitch	5.00 mm			
Pol.	L1	(inch)	Qty.	Order No.
2	5.00	0.197	320	1473770000
3	10.00	0.394	320	1473780000
4	15.00	0.591	320	1473790000
5	20.00	0.787	320	1473800000
6	25.00	0.984	320	1473810000
7	30.00	1.181	320	1473820000
8	35.00	1.378	320	1473830000

Accessories

Note: Refer to the Accessories chapter for additional accessories.

Screwdriver		Order No.
	SDS 0.4X2.5X75	2749320000
	SDIS 0.4X2.5X75	2749790000

Representative deratings curve

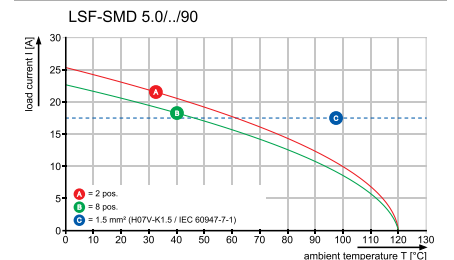

LSF-SMD 5.00../135 Tape

Reflow-compatible circuit board terminal



Dimensioned drawing

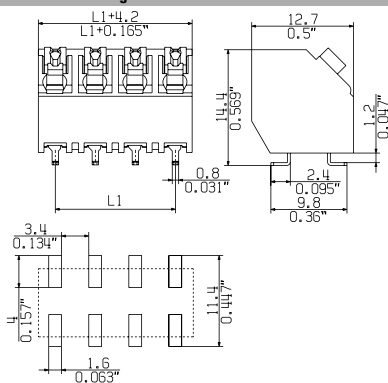

Ordering data

Solder pin length					
Colour					black
Pitch 5.00 mm					
Pol.	L1	(inch)	Qty.	Order No.	
2	5.00	0.197	210	1473690000	
3	10.00	0.394	210	1473700000	
4	15.00	0.591	210	1473710000	
5	20.00	0.787	210	1473720000	
6	25.00	0.984	210	1473740000	
7	30.00	1.181	210	1473750000	
8	35.00	1.378	210	1473760000	

LSF-SMD 5.00../180 Tape

Reflow-compatible circuit board terminal



Dimensioned drawing

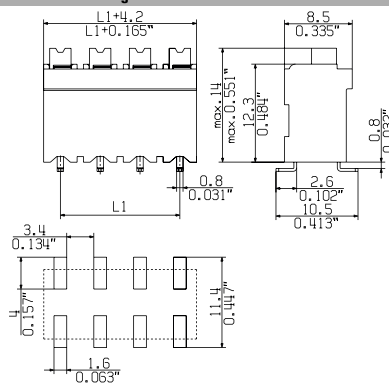

Ordering data

Solder pin length					
Colour					black
Pitch 5.00 mm					
Pol.	L1	(inch)	Qty.	Order No.	
2	5.00	0.197	235	1473560000	
3	10.00	0.394	180	1473580000	
4	15.00	0.591	180	1473610000	
5	20.00	0.787	180	1473640000	
6	25.00	0.984	180	1473660000	
7	30.00	1.181	180	1473670000	
8	35.00	1.378	180	1473680000	

Additional deratings curves

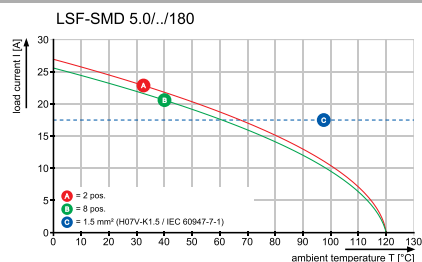
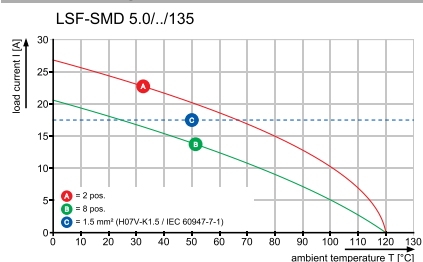

LSF-SMD 7.50

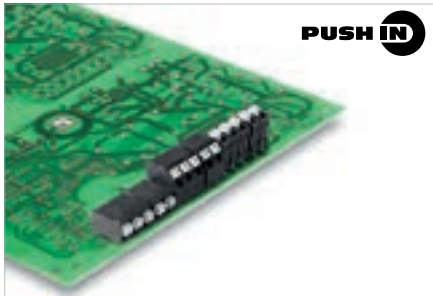

PCB terminal for fully automatic assembly using reflow soldering (SMD), with PUSH IN wire connections. Conductor insertion and slider operation from the same direction (TOP).

- Solid & flexible conductors with wire-end ferrules need only to be inserted and they are ready.
- When connecting stranded wires without wire-end ferrules the actuating element is used to open the terminal point
- Intuitive handling – since the wire-entry area and handling area are clearly separated.
- Packaged in tape-on-reel
- Conductor outlet direction 180°

Product data

IEC: 800 V / 17.5 A / 0.2 - 1.5 mm²
UL: 300 V / 12 A / AWG 28 - 14



For additional articles and information, refer to catalog.weidmueller.com

Note:

- Additional push button colours on request
- Operating force of slider max. 40 N
- Rated current related to rated cross-section & min. No. of poles.
- Wire end ferrule with plastic collar to DIN 46228/4
- Wire end ferrule without plastic collar to DIN 46228/1
- P on drawing = pitch
- Rated data refer only to the component itself. Clearance and creepage distances to other components are to be designed in accordance with the relevant application standards.
- Crimping shape "A" for wire end ferrules with PZ 6/5 crimping tool recommended.
- Long term storage of the product with average temperature of 50 °C and average humidity 70%, 36 months

LSF-SMD 7.50/./90 Tape

Reflow-compatible circuit board terminal



Dimensioned drawing

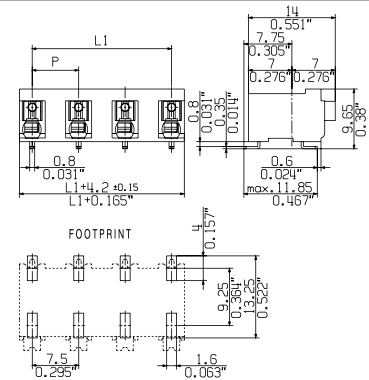

Ordering data

Solder pin length				
Colour	black			
Pitch	7.50 mm			
Pol.	L1	(inch)	Qty.	Order No.
2	7.50	0.295	320	1473940000
3	15.00	0.590	320	1473950000
4	22.50	0.885	320	1473960000
5	30.00	1.180	320	1473970000
6	37.50	1.475	320	1473980000

Technical data

In compliance with IEC 60664-1 / IEC 61984			
Clamping range, max.	mm ²	0.13...1.5	
Solid core H05(07) V-U	mm²	0.2...1.5	
Stranded H07 V-R			
Flexible H05(07) V-K	mm ²	0.2...1.5	
Flexible with ferrule	mm ²	0.25...1.5	
Ferrule with plastic collar	mm ²	0.25...0.75	
Stripping length	mm	8	
Screwdriver blade	mm		
According to norm			
Tightening torque range			
Rated current, max.	A	17.5	17.5
At ambient temperature		20°C	40°C
For conductor cross-section			
Overtoltage category		III	III II
Pollution severity		3	2 2
Rated voltage	V	500	630 800
Rated impulse voltage	kV	6	6 6
UL / CUL (Use Group)	B C D		
Rated voltage	V	300	150 300
Rated current	A	12	10 10
AWG conductor	AWG	28-14	
CSA (Use Group)	B C D		
Rated voltage	V	300	150 300
Rated current	A	10	10 10
AWG conductor	AWG	28-14	
General data			
Type of insulation material		LCP GF	
UL 94 flammability rating		V-0	
Contact base material		Copper alloy	
Material of contact surface			
Pin dimensions = d	mm		
Solder eyelet Ø = D	mm		
Solder eyelet Ø tolerance	mm		

Accessories

Note: Refer to the Accessories chapter for additional accessories.

Screwdriver		Order No.
	SDS 0.4X2.5X75	2749320000
	SDIS 0.4X2.5X75	2749790000

Representative deratings curve

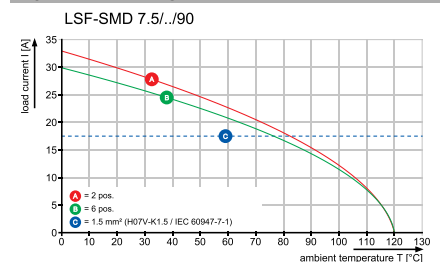

LSF-SMD 7.50../135 Tape

Reflow-compatible circuit board terminal



Dimensioned drawing

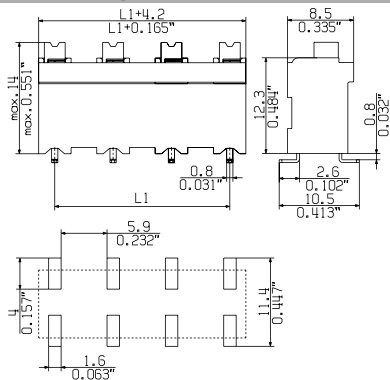

Ordering data

Solder pin length					
Colour					black
Pitch 7.50 mm					
Pol.	L1	(inch)	Qty.	Order No.	
2	7.50	0.295	210	1473890000	
3	15.00	0.590	210	1473900000	
4	22.50	0.885	210	1473910000	
5	30.00	1.180	210	1473920000	
6	37.50	1.475	210	1473930000	

LSF-SMD 7.50../180 Tape

Reflow-compatible circuit board terminal



Dimensioned drawing

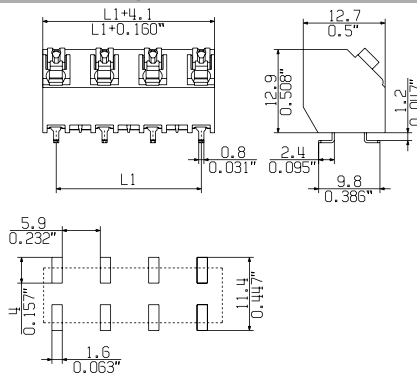

Ordering data

Solder pin length					
Colour					black
Pitch 7.50 mm					
Pol.	L1	(inch)	Qty.	Order No.	
2	7.50	0.295	180	1473840000	
3	15.00	0.590	180	1473850000	
4	22.50	0.885	180	1473860000	
5	30.00	1.180	180	1473870000	
6	37.50	1.475	180	1473880000	

Additional deratings curves

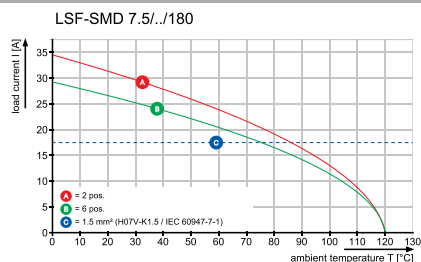
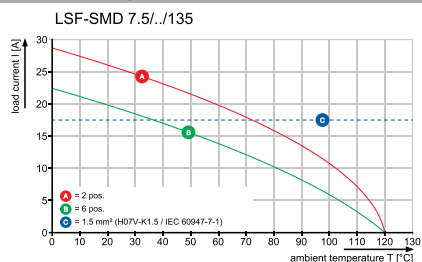

LMF & LMFS 5.00

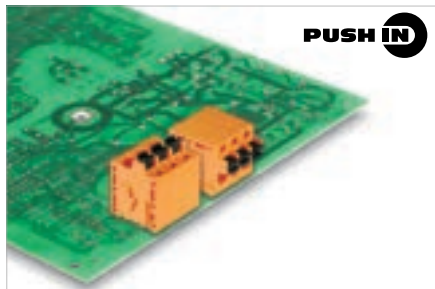

With the new LMF, we are meeting current market requirements for a PCB terminal with a PUSH IN connection system for wire cross-sections up to 2.5 mm².

- PUSH IN connection system
- Pusher for opening the contact point
- Integrated test point
- 90° or 180° wire outlet direction

Product data

IEC: 400 V / 24 A / 0.5 - 2.5 mm²
 UL: 300 V / 20 A / AWG 24 - 12



For additional articles and information, refer to catalog.weidmueller.com

Note:

- Additional variants on request
- Rated current related to rated cross-section & min. No. of poles.
- Wire end ferrule without plastic collar to DIN 46228/1
- Wire end ferrule with plastic collar to DIN 46228/4
- P on drawing = pitch
- Rated data refer only to the component itself. Clearance and creepage distances to other components are to be designed in accordance with the relevant application standards.
- The test point can only be used as potential-pickup point.
- Long term storage of the product with average temperature of 50 °C and average humidity 70%, 36 months

LMF 5.00/./90



Dimensioned drawing

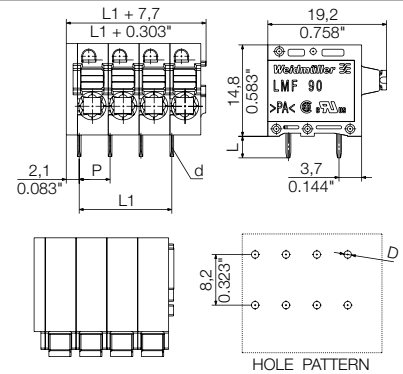

Technical data

In compliance with IEC 60664-1 / IEC 61984			
Clamping range, max.	mm ²	0.12...2.5	
Solid core H05(07) V-U	mm ²	0.5...2.5	
Stranded H07 V-R			
Flexible H05(07) V-K	mm ²	0.25...2.5	
Flexible with ferrule	mm ²	0.25...2.5	
Ferrule with plastic collar	mm ²	0.25...2.5	
Stripping length	mm	10	
Screwdriver blade	mm	0.6 x 3.5	
According to norm			
Tightening torque range			
Rated current, max.	A	24	24
At ambient temperature		20°C	40°C
For conductor cross-section			
Overtoltage category		III	III II
Pollution severity		3	2 2
Rated voltage	V	250	320 400
Rated impulse voltage	kV	4	4 4
UL / CUL (Use Group)		B	C D
Rated voltage	V	300	300
Rated current	A	20	10
AWG conductor	AWG	24-12	
CSA (Use Group)		B	C D
Rated voltage	V	300	300
Rated current	A	20	10
AWG conductor	AWG	24-12	
General data			
Type of insulation material		Wemid (PA)	
UL 94 flammability rating		V-0	
Contact base material		CuSn	
Material of contact surface		tinned	
Pin dimensions = d	mm	0.8, 0.6 x 0.8	
Solder eyelet Ø = D	mm	1.1	
Solder eyelet Ø tolerance	mm	+ 0,1	

Accessories

Note: Refer to the Accessories chapter for additional accessories.

Test plug		Order No.
	PS 2.0 MC	0310000000
Screwdriver		
	SDS 0.6X3.5X100	2749340000

Ordering data

Solder pin length		3.5 mm		
Colour		orange		
Pitch		5.00 mm		
Pol.	L1	(inch)	Qty.	Order No.
2	5.00	0.197	130	1331700000
3	10.00	0.394	90	1331710000
4	15.00	0.591	70	1331720000
5	20.00	0.787	55	1331730000
6	25.00	0.984	45	1331740000
7	30.00	1.181	40	1331750000
8	35.00	1.378	35	1331770000
9	40.00	1.575	30	1331780000
10	45.00	1.772	25	1331790000
11	50.00	1.969	25	1331800000
12	55.00	2.166	25	1331810000

Representative deratings curve

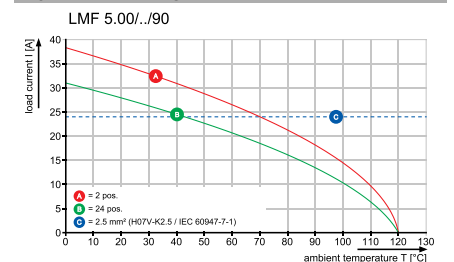

LMF 5.00../180



Dimensioned drawing

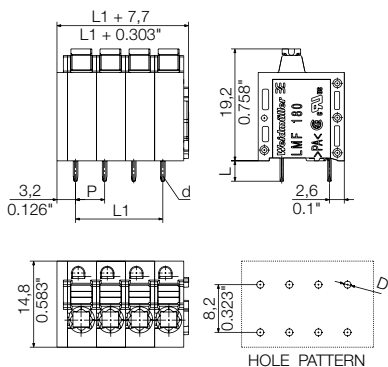

Ordering data

Solder pin length		3.5 mm			
Colour		orange			
Pitch		5.00 mm			
Pol.	L1	(inch)	Qty.	Order No.	
2	5.00	0.197	130	1330180000	
3	10.00	0.394	90	1330190000	
4	15.00	0.591	70	1330200000	
5	20.00	0.787	55	1330210000	
6	25.00	0.984	45	1330220000	
7	30.00	1.181	40	1330230000	
8	35.00	1.378	35	1330240000	
9	40.00	1.575	30	1330250000	
10	45.00	1.772	30	1330270000	
11	50.00	1.969	25	1330280000	
12	55.00	2.166	25	1330290000	

LMFS 5.00../90



Dimensioned drawing

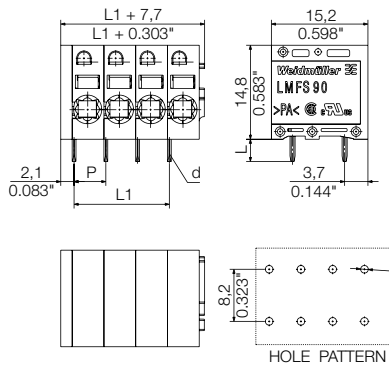

Ordering data

Solder pin length		3.5 mm			
Colour		orange			
Pitch		5.00 mm			
Pol.	L1	(inch)	Qty.	Order No.	
2	5.00	0.197	130	1331960000	
3	10.00	0.394	90	1331970000	
4	15.00	0.591	70	1331980000	
5	20.00	0.787	55	1331990000	
6	25.00	0.984	45	1332010000	
7	30.00	1.181	40	1332020000	
8	35.00	1.378	35	1332030000	
9	40.00	1.575	30	1332040000	
10	45.00	1.772	25	1332050000	
11	50.00	1.969	25	1332060000	
12	55.00	2.166	25	1332070000	

LMFS 5.00../180



Dimensioned drawing

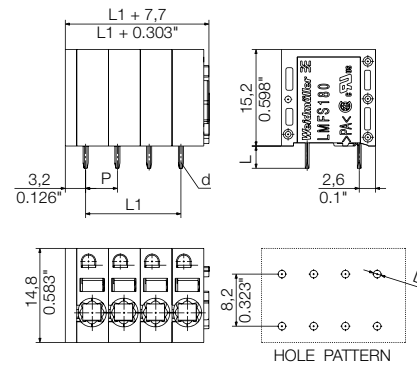

Ordering data

Solder pin length		3.5 mm			
Colour		orange			
Pitch		5.00 mm			
Pol.	L1	(inch)	Qty.	Order No.	
2	5.00	0.197	130	1330430000	
3	10.00	0.394	90	1330440000	
4	15.00	0.591	70	1330450000	
5	20.00	0.787	55	1330470000	
6	25.00	0.984	45	1330490000	
7	30.00	1.181	40	1330500000	
8	35.00	1.378	35	1330510000	
9	40.00	1.575	30	1330520000	
10	45.00	1.772	30	1330530000	
11	50.00	1.969	25	1330540000	
12	55.00	2.166	25	1330550000	

Additional deratings curves

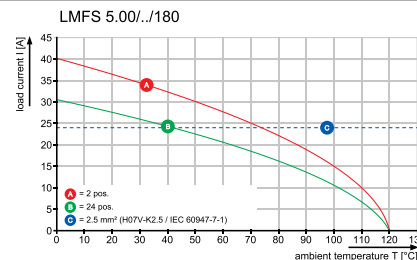
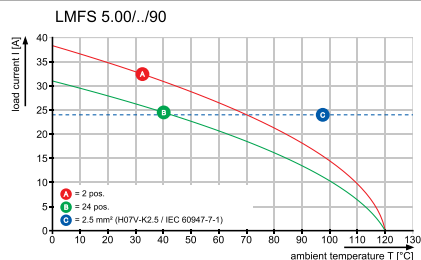
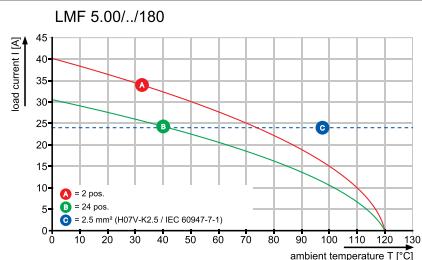

LMF & LMFS 5.08

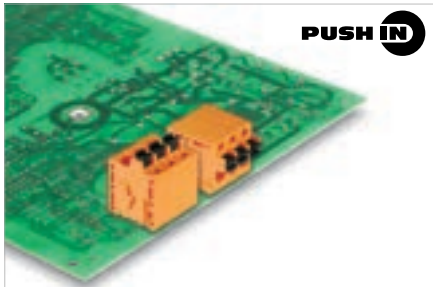

With the new LMF, we are meeting current market requirements for a PCB terminal with a PUSH IN connection system for wire cross-sections up to 2.5 mm².

- PUSH IN connection system
- Pusher for opening the contact point
- Integrated test point
- 90° or 180° wire outlet direction

Product data

IEC: 400 V / 24 A / 0.5 - 2.5 mm²
UL: 300 V / 20 A / AWG 24 - 12



For additional articles and information, refer to catalog.weidmueller.com

Note:

- Additional variants on request
- Rated current related to rated cross-section & min. No. of poles.
- Wire end ferrule without plastic collar to DIN 46228/1
- Wire end ferrule with plastic collar to DIN 46228/4
- P on drawing = pitch
- Rated data refer only to the component itself. Clearance and creepage distances to other components are to be designed in accordance with the relevant application standards.
- The test point can only be used as potential-pickup point.
- Long term storage of the product with average temperature of 50 °C and average humidity 70%, 36 months

LMF 5.08/./90



Dimensioned drawing

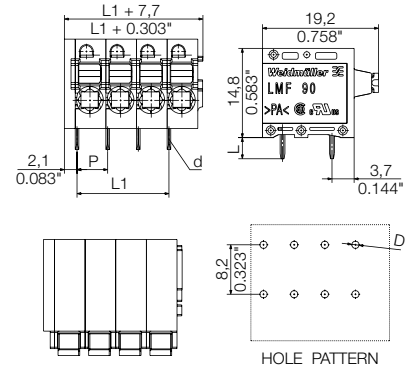

Ordering data

Solder pin length		3.5 mm		
Colour		orange		
Pitch		5.08 mm		
Pol.	L1	(inch)	Qty.	Order No.
2	5.08	0.200	125	1330710000
3	10.16	0.400	90	1330720000
4	15.24	0.600	70	1330730000
5	20.32	0.800	55	1330740000
6	25.40	1.000	45	1330750000
7	30.48	1.200	40	1330770000
8	35.56	1.400	35	1330780000
9	40.64	1.600	30	1330790000
10	45.72	1.800	25	1330800000
11	50.80	2.000	25	1330810000
12	55.88	2.200	20	1330820000

Representative deratings curve

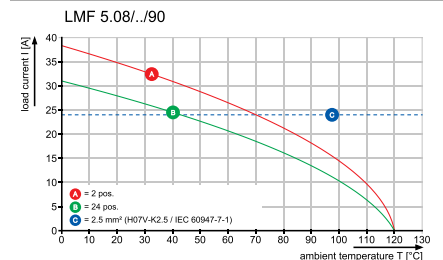

Technical data

In compliance with IEC 60664-1 / IEC 61984			
Clamping range, max.	mm ²	0.12...2.5	
Solid core H05(07) V-U	mm ²	0.5...2.5	
Stranded H07 V-R			
Flexible H05(07) V-K	mm ²	0.25...2.5	
Flexible with ferrule	mm ²	0.25...2.5	
Ferrule with plastic collar	mm ²	0.25...2.5	
Stripping length	mm	10	
Screwdriver blade	mm	0.6 x 3.5	
According to norm		DIN 5264	
Tightening torque range			
Rated current, max.	A	24	24
At ambient temperature		20°C	40°C
For conductor cross-section			
Overtoltage category		III	III II
Pollution severity		3	2 2
Rated voltage	V	250	320 400
Rated impulse voltage	kV	4	4 4
UL / CUL (Use Group)		B	C D
Rated voltage	V	300	300
Rated current	A	20	10
AWG conductor	AWG	24-12	
CSA (Use Group)		B	C D
Rated voltage	V	300	300
Rated current	A	20	10
AWG conductor	AWG	24-12	
General data			
Type of insulation material		Wemid (PA)	
UL 94 flammability rating		V-0	
Contact base material		CuSn	
Material of contact surface		tinned	
Pin dimensions = d	mm	0.8, 0.6 x 0.8	
Solder eyelet Ø = D	mm	1.1	
Solder eyelet Ø tolerance	mm	+ 0,1	

Accessories

Note: Refer to the Accessories chapter for additional accessories.

Test plug		Order No.
	PS 2.0 MC	0310000000
Screwdriver		
	SDS 0.6X3.5X100	2749340000

LMF 5.08../180



Dimensioned drawing

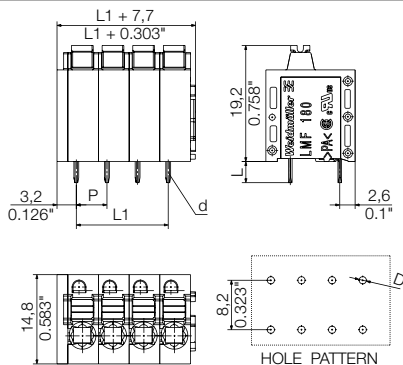

Ordering data

Solder pin length		3.5 mm	
Colour		orange	
Pitch		5.08 mm	
Pol.	L1	(inch)	Qty. Order No.
2	5.08	0.200	130 1331080000
3	10.16	0.400	90 1331100000
4	15.24	0.600	70 1331120000
5	20.32	0.800	55 1331140000
6	25.40	1.000	45 1331160000
7	30.48	1.200	40 1331180000
8	35.56	1.400	35 1331200000
9	40.64	1.600	30 1331220000
10	45.72	1.800	25 1331240000
11	50.80	2.000	25 1331260000
12	55.88	2.200	20 1331280000

LMFS 5.08../90



Dimensioned drawing

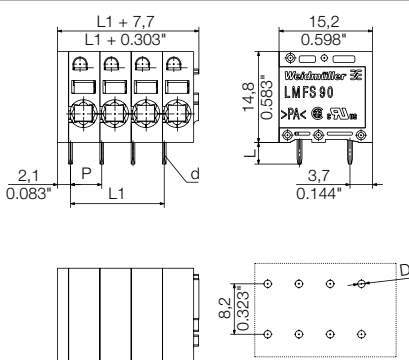

Ordering data

Solder pin length		3.5 mm	
Colour		orange	
Pitch		5.08 mm	
Pol.	L1	(inch)	Qty. Order No.
2	5.08	0.200	130 1330960000
3	10.16	0.400	90 1330970000
4	15.24	0.600	70 1330980000
5	20.32	0.800	55 1330990000
6	25.40	1.000	45 1331000000
7	30.48	1.200	40 1331010000
8	35.56	1.400	35 1331020000
9	40.64	1.600	30 1331030000
10	45.72	1.800	25 1331040000
11	50.80	2.000	25 1331050000
12	55.88	2.200	20 1331060000

LMFS 5.08../180



Dimensioned drawing

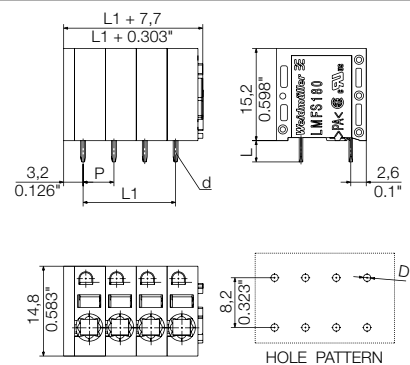

Ordering data

Solder pin length		3.5 mm	
Colour		orange	
Pitch		5.08 mm	
Pol.	L1	(inch)	Qty. Order No.
2	5.08	0.200	130 1331430000
3	10.16	0.400	90 1331440000
4	15.24	0.600	70 1331450000
5	20.32	0.800	55 1331470000
6	25.40	1.000	45 1331480000
7	30.48	1.200	40 1331490000
8	35.56	1.400	35 1331500000
9	40.64	1.600	30 1331510000
10	45.72	1.800	25 1331520000
11	50.80	2.000	25 1331530000
12	55.88	2.200	20 1331540000

Additional deratings curves

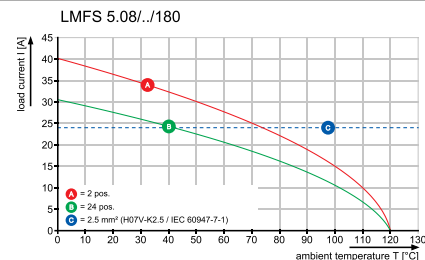
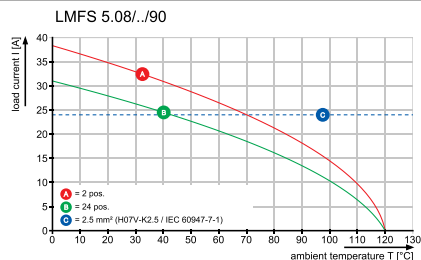
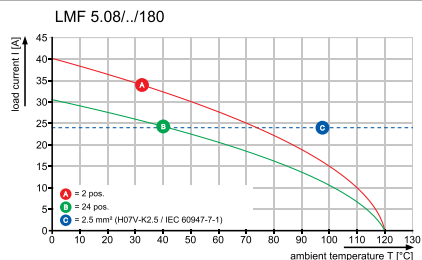

LMF & LMFS 7.50

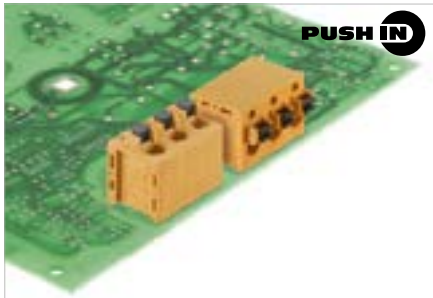

PUSH IN

With the new LMF, we are meeting current market requirements for a PCB terminal with a PUSH IN connection system for wire cross-sections up to 2.5 mm².

- PUSH IN connection system
- Pusher for opening the contact point
- Integrated test point
- 90° or 180° wire outlet direction

Product data

IEC: 1000 V / 24 A / 0.5 - 2.5 mm²
 UL: 300 V / 20 A / AWG 24 - 12



For additional articles and information, refer to catalog.weidmueller.com

Note:

- Additional variants on request
- Rated current related to rated cross-section & min. No. of poles.
- Wire end ferrule without plastic collar to DIN 46228/1
- Wire end ferrule with plastic collar to DIN 46228/4
- P on drawing = pitch
- Rated data refer only to the component itself. Clearance and creepage distances to other components are to be designed in accordance with the relevant application standards.
- The test point can only be used as potential-pickup point.
- Long term storage of the product with average temperature of 50 °C and average humidity 70%, 36 months

LMF 7.50/./90



Dimensioned drawing

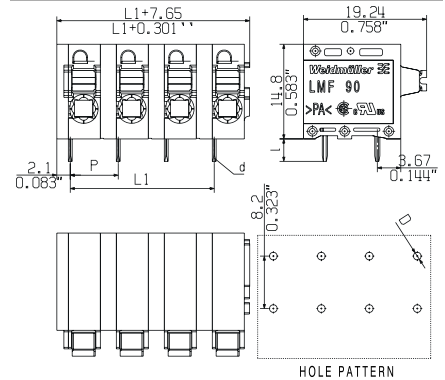

Technical data

In compliance with IEC 60664-1 / IEC 61984			
Clamping range, max.	mm ²	0.12...2.5	
Solid core H05(07) V-U	mm ²	0.5...2.5	
Stranded H07 V-R			
Flexible H05(07) V-K	mm ²	0.25...2.5	
Flexible with ferrule	mm ²	0.25...2.5	
Ferrule with plastic collar	mm ²	0.25...2.5	
Stripping length	mm	10	
Screwdriver blade	mm	0.6 x 3.5	
According to norm		DIN 5264	
Tightening torque range			
Rated current, max.	A	24	24
At ambient temperature		20°C	40°C
For conductor cross-section			
Overtoltage category		III	III II
Pollution severity		3	2 2
Rated voltage	V	500	600 1000
Rated impulse voltage	kV	6	6 6
UL / CUL (Use Group)	B C D	B	C D
Rated voltage	V	300	300
Rated current	A	20	10
AWG conductor	AWG	24-12	
CSA (Use Group)	B C D	B	C D
Rated voltage	V	300	300
Rated current	A	20	10
AWG conductor	AWG	24-12	
General data			
Type of insulation material		Wemid (PA)	
UL 94 flammability rating		V-0	
Contact base material		CuSn	
Material of contact surface		tinned	
Pin dimensions = d	mm	0.8	
Solder eyelet Ø = D	mm	1.1	
Solder eyelet Ø tolerance	mm	+ 0,1	

Accessories

Note: Refer to the Accessories chapter for additional accessories.

Ordering data

Solder pin length		3.5 mm	
Colour		orange	
Pitch		7.50 mm	
Pol.	L1	(inch)	Qty. Order No.
2	7.50		100 2667910000
3	15.00		65 2667920000
4	22.50		50 2667830000
5	30.00		40 2667840000
6	37.50		30 2667850000
7	45.00		25 2667860000
8	52.50		25 2667870000
9	60.00		20 2667880000
10	67.50		20 2667930000
11	75.00		15 2668140000
12	82.50		15 2668150000

Representative deratings curve

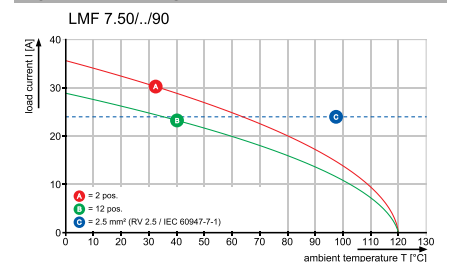

LMF 7.50../180



Dimensioned drawing

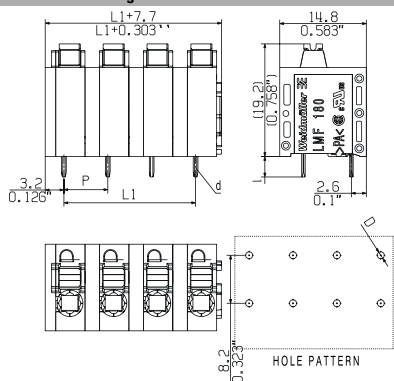

Ordering data

Solder pin length		3.5 mm	
Colour		orange	
Pitch		7.50 mm	
Pol.	L1	(inch)	Qty. Order No.
2	100		2774540000
3	65		2774550000
4	50		2774560000
5	40		2774570000
6	30		2774580000
7	25		2774590000
8	25		2774600000
9	20		2774610000
10	20		2774620000
11	15		2774630000
12	15		2774640000

LMFS 7.50../90



Dimensioned drawing

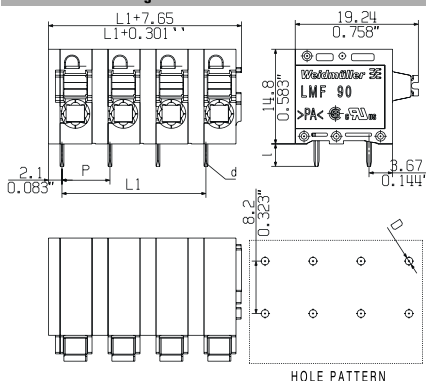

Ordering data

Solder pin length		3.5 mm	
Colour		orange	
Pitch		7.50 mm	
Pol.	L1	(inch)	Qty. Order No.
2	100		2667420000
3	65		2667430000
4	50		2667440000
5	40		2667450000
6	30		2667460000
7	25		2667470000
8	25		2667480000
9	20		2667490000
10	20		2667500000
11	15		2667510000
12	15		2667520000

LMFS 7.50../180



Dimensioned drawing

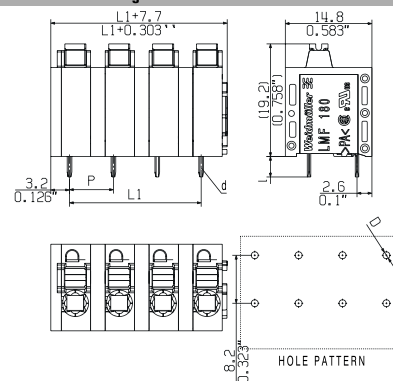

Ordering data

Solder pin length		3.5 mm	
Colour		orange	
Pitch		7.50 mm	
Pol.	L1	(inch)	Qty. Order No.
2	100		2774760000
3	65		2774770000
4	50		2774780000
5	40		2774790000
6	30		2774800000
7	25		2774810000
8	25		2774820000
9	20		2774830000
10	20		2774840000
11	15		2774850000
12	15		2774860000

Additional deratings curves

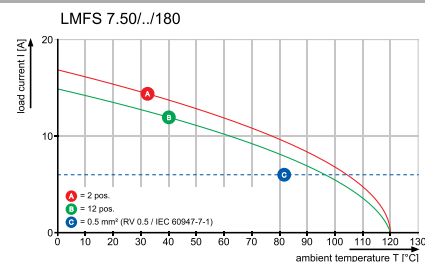
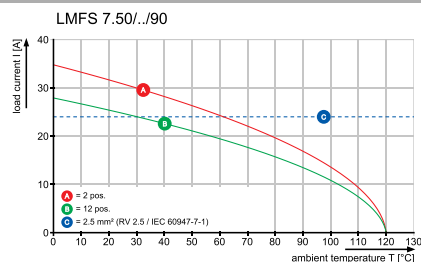
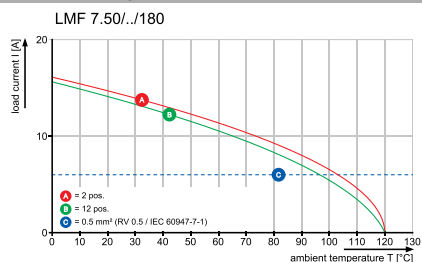

LMFV 5.00

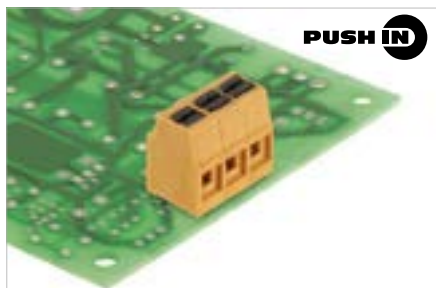

With the new LMF, we are meeting current market requirements for a PCB terminal with a PUSH IN connection system for wire cross-sections up to 2.5 mm².

- PUSH IN connection system
- Pusher for opening the contact point
- Integrated test point
- 90° or 180° wire outlet direction

Product data

IEC: 630 V / 24 A / 0.2 - 2.5 mm²
 UL: 300 V / 15 A / AWG 24 - 14



For additional articles and information, refer to catalog.weidmueller.com

Note:

- Additional variants on request
- Rated current related to rated cross-section & min. No. of poles.
- Wire end ferrule without plastic collar to DIN 46228/1
- Wire end ferrule with plastic collar to DIN 46228/4
- P on drawing = pitch
- Rated data refer only to the component itself. Clearance and creepage distances to other components are to be designed in accordance with the relevant application standards.
- The test point can only be used as potential-pickup point.
- Long term storage of the product with average temperature of 50 °C and average humidity 70%, 36 months

LMFV 5.00/./90



Dimensioned drawing

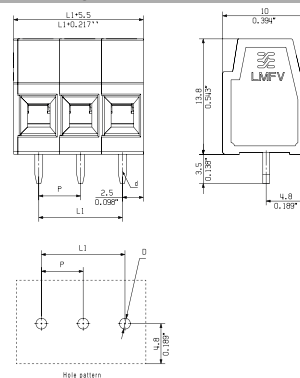

Technical data

In compliance with IEC 60664-1 / IEC 61984			
Clamping range, max.	mm ²	0.2...2.5	
Solid core H05(07) V-U	mm²	0.2...2.5	
Stranded H07 V-R			
Flexible H05(07) V-K	mm ²	0.2...2.5	
Flexible with ferrule	mm ²	0.2...1.5	
Ferrule with plastic collar	mm ²	0.25...1.5	
Stripping length	mm	8	
Screwdriver blade	mm	0.6 x 3.5	
According to norm			
Tightening torque range			
Rated current, max.	A	24	24
At ambient temperature		20°C	40°C
For conductor cross-section			
Overtoltage category		III	III II
Pollution severity		3	2 2
Rated voltage	V	250	350 630
Rated impulse voltage	kV	4	4 4
UL / CUL (Use Group)		B	C D
Rated voltage	V	300	300
Rated current	A	15	10
AWG conductor	AWG	24-14	
CSA (Use Group)		B	C D
Rated voltage	V		
Rated current	A		
AWG conductor	AWG	-	
General data			
Type of insulation material		PA	
UL 94 flammability rating		V-0	
Contact base material		Copper alloy	
Material of contact surface		tinned	
Pin dimensions = d	mm	0.95 x 0.8	
Solder eyelet Ø = D			
Solder eyelet Ø tolerance	mm		

Accessories

Note: Refer to the Accessories chapter for additional accessories.

Ordering data

Solder pin length		3.5 mm		
Colour		orange		
Pitch		5.00 mm		
Pol.	L1	(inch)	Qty.	Order No.
2	5.00	0.200	360	2786530000
3	10.00	0.390	240	2786540000
4	15.00	0.590	192	2786550000
5	20.00	0.790	152	2786560000
6	25.00	0.980	128	2786570000
7	30.00	1.180	108	2786580000
8	35.00	1.380	96	2786590000
9	40.00	1.570	82	2786600000
10	45.00	1.770	76	2786620000
11	50.00	1.970	68	2786630000
12	55.00	2.170	64	2786640000
16	75.00	2.950	48	2786690000

LMFV 7.50

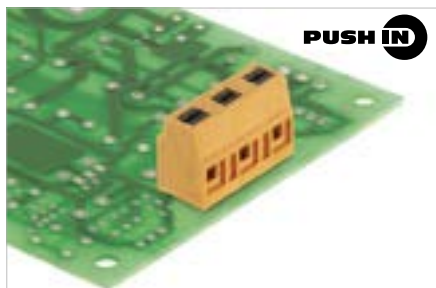

With the new LMF, we are meeting current market requirements for a PCB terminal with a PUSH IN connection system for wire cross-sections up to 2.5 mm².

- PUSH IN connection system
- Pusher for opening the contact point
- Integrated test point
- 90° or 180° wire outlet direction

Technical data

In compliance with IEC 60664-1 / IEC 61984			
Clamping range, max.	mm ²	0.2...2.5	
Solid core H05(07) V-U	mm ²	0.2...2.5	
Stranded H07 V-R			
Flexible H05(07) V-K	mm ²	0.2...2.5	
Flexible with ferrule	mm ²	0.2...1.5	
Ferrule with plastic collar	mm ²	0.25...1.5	
Stripping length	mm	8	
Screwdriver blade	mm	0.6 x 3.5	
According to norm			
Tightening torque range			
Rated current, max.	A	24	24
At ambient temperature		20°C	40°C
For conductor cross-section			
Overtoltage category		III	III II
Pollution severity		3	2 2
Rated voltage	V	250	350 630
Rated impulse voltage	kV	4	4 4
UL / CUL (Use Group)		B	C D
Rated voltage	V	300	300
Rated current	A	15	10
AWG conductor	AWG	24-14	
CSA (Use Group)		B	C D
Rated voltage	V		
Rated current	A		
AWG conductor	AWG	-	
General data			
Type of insulation material		PA	
UL 94 flammability rating		V-0	
Contact base material		Copper alloy	
Material of contact surface		tinned	
Pin dimensions = d	mm	0.95 x 0.8	
Solder eyelet Ø = D			
Solder eyelet Ø tolerance	mm		

Product data

IEC: 630 V / 24 A / 0.2 - 2.5 mm²
 UL: 300 V / 15 A / AWG 24 - 14



For additional articles and information, refer to catalog.weidmueller.com

Note:

- Additional variants on request
- Rated current related to rated cross-section & min. No. of poles.
- Wire end ferrule without plastic collar to DIN 46228/1
- Wire end ferrule with plastic collar to DIN 46228/4
- P on drawing = pitch
- Rated data refer only to the component itself. Clearance and creepage distances to other components are to be designed in accordance with the relevant application standards.
- The test point can only be used as potential-pickup point.
- Long term storage of the product with average temperature of 50 °C and average humidity 70%, 36 months

LMFV 7.50/./90



Dimensioned drawing

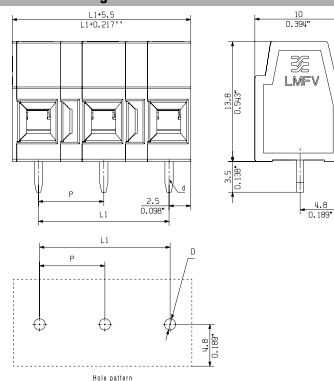

Accessories

Note: Refer to the Accessories chapter for additional accessories.

Ordering data

Solder pin length		3.5 mm		
Colour		orange		
Pitch		7.50 mm		
Pol.	L1	(inch)	Qty.	Order No.
2	7.50	0.300	288	2787570000
3	15.00	0.590	192	2787580000
4	22.50	0.890	136	2787590000
5	30.00	1.180	108	2787600000
6	37.50	1.480	84	2787610000
7	45.00	1.770	76	2787620000
8	52.50	2.070	64	2787630000
9	60.00	2.360	54	2787640000
10	67.50	2.660	50	2787650000
11	75.00	2.950	48	2787660000
12	82.50	3.250	38	2787670000



LS2HF/90

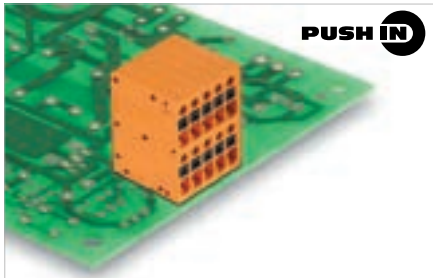

Double-level PCB terminal for wave soldering, with PUSH IN wire connection system. Wire connection and slider operation from the same direction (TOP).

- Solid and stranded wires with wire-end ferrules need only to be inserted and they are ready
- When connecting stranded wires without wire-end ferrules, the actuating element is used to open the contact point
- Intuitive handling thanks to the clear distinction between conductor entry and actuating element
- Packaged in box
- Wire outlet direction: 90° version

Product data

IEC: 400 V / 17.5 A / 0.2 - 1.5 mm²
 UL: 150 V / 12.5 A / AWG 26 - 16



For additional articles and information, refer to catalog.weidmueller.com

Note:

- Additional variants on request
- Rated current related to rated cross-section & min. No. of poles.
- Wire end ferrule without plastic collar to DIN 46228/1
- Wire end ferrule with plastic collar to DIN 46228/4
- P on drawing = pitch
- Rated data refer only to the component itself. Clearance and creepage distances to other components are to be designed in accordance with the relevant application standards.
- Crimping shape "A" for wire end ferrules with PZ 6/5 crimping tool recommended.
- Long term storage of the product with average temperature of 50 °C and average humidity 70%, 36 months

LS2HF 3.50/./90



Dimensioned drawing

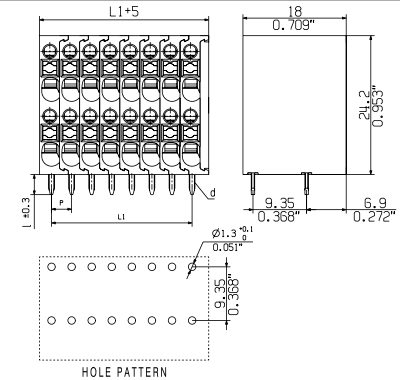

Ordering data

Solder pin length		3.5 mm		
Colour		orange		
Pitch		3.50 mm		
Pol.	L1	(inch)	Qty.	Order No.
4	3.50	0.138	100	2000940000
6	7.00	0.276	100	2000950000
8	10.50	0.413	100	2000960000
10	14.00	0.551	100	2000970000
12	17.50	0.689	50	2000980000
14	21.00	0.827	50	2000990000
16	24.50	0.965	50	2001000000
18	28.00	1.102	50	2001010000
20	31.50	1.240	50	2001020000
22	35.00	1.378	20	2001030000
24	38.50	1.516	20	2001040000

Representative deratings curve

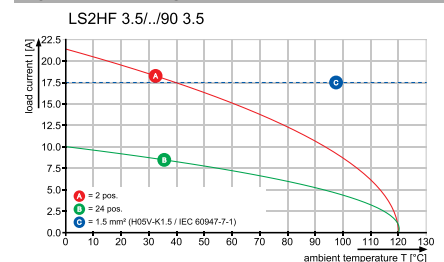

Technical data

In compliance with IEC 60664-1 / IEC 61984			
Clamping range, max.	mm ²	0.2...1.5	
Solid core H05(07) V-U	mm²	0.2...1.5	
Stranded H07 V-R			
Flexible H05(07) V-K	mm ²	0.2...1.5	
Flexible with ferrule	mm ²	0.2...1.5	
Ferrule with plastic collar	mm ²	0.2...0.75	
Stripping length	mm	8	
Screwdriver blade	mm	0.4 x 2.5	
According to norm			
Tightening torque range			
Rated current, max.	A	17.5	17.5
At ambient temperature	20°C	40°C	
For conductor cross-section			
Overtoltage category		III	III II
Pollution severity		3	2 2
Rated voltage	V	160	200 400
Rated impulse voltage	kV	2.5	2.5 2.5
UL / CUL (Use Group)	B C D		
Rated voltage	V	150	150
Rated current	A	12.5	12.5
AWG conductor	AWG	26-16	
CSA (Use Group)	B C D		
Rated voltage	V	150	150
Rated current	A	12.5	12.5
AWG conductor	AWG	26-16	
General data			
Type of insulation material		PA 66/6	
UL 94 flammability rating		V-0	
Contact base material		Copper alloy	
Material of contact surface			
Pin dimensions = d	mm	1.0 x 0.6	
Solder eyelet Ø = D	mm	1.3	
Solder eyelet Ø tolerance	mm	+ 0,1	

Accessories

Note: Refer to the Accessories chapter for additional accessories.

Screwdriver		Order No.
	SDIS 0.4X2.5X75	2749790000
	SDS 0.4X2.5X75	2749320000

LMZF & LMZF 5/..../135

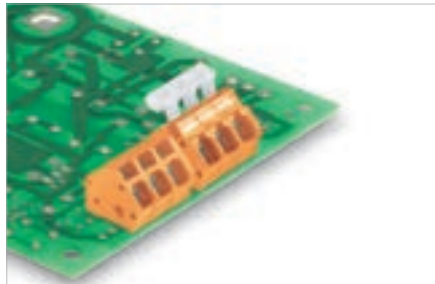

The compact installation terminal with tension clamp spring connection in 5.0x-mm pitch for wire cross-sections up to 2.5 mm².

- Variable pitch: 5.00 - 5.08 mm
- 1 component = 2 pitches
- Wire outlet direction: 135° version
- Convenient: optional lever for opening the contact point.

Product data

IEC: 630 V / 24 A / 0.13 - 2.5 mm²
 UL: 300 V / 15 A / AWG 26 - 14



For additional articles and information, refer to catalog.weidmueller.com

Note:

- Rated current related to rated cross-section & min. No. of poles.
- Wire end ferrule without plastic collar to DIN 46228/1
- Wire end ferrule with plastic collar to DIN 46228/4
- P on drawing = pitch
- Rated data refer only to the component itself. Clearance and creepage distances to other components are to be designed in accordance with the relevant application standards.
- Long term storage of the product with average temperature of 50 °C and average humidity 70%, 36 months

LMZF 5/..../135



Dimensioned drawing

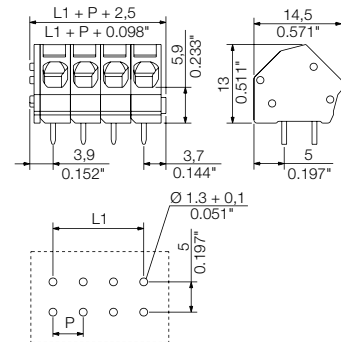

Technical data

In compliance with IEC 60664-1 / IEC 61984			
Clamping range, max.	mm ²	0.13...2.5	
Solid core H05(07) V-U	mm ²	0.13...2.5	
Stranded H07 V-R			
Flexible H05(07) V-K	mm ²	0.13...2.5	
Flexible with ferrule	mm ²	0.25...1.5	
Ferrule with plastic collar	mm ²	0.25...1.5	
Stripping length	mm	6	
Screwdriver blade	mm	0.4 x 2.5	
According to norm		DIN 5264-A	
Tightening torque range			
Rated current, max.	A	24	24
At ambient temperature		20°C	40°C
For conductor cross-section			
Overtoltage category		III	III II
Pollution severity		3	2 2
Rated voltage	V	250	320 630
Rated impulse voltage	kV	4	4 4
UL / CUL (Use Group)		B	C D
Rated voltage	V	300	300
Rated current	A	15	10
AWG conductor	AWG	26-14	
CSA (Use Group)		B	C D
Rated voltage	V	300	300
Rated current	A	10	10
AWG conductor	AWG	26-14	
General data			
Type of insulation material		Wemid (PA)	
UL 94 flammability rating		V-0	
Contact base material		Copper alloy	
Material of contact surface		tinned	
Pin dimensions = d	mm	0.8 x 0.8	
Solder eyelet Ø = D	mm	1.3	
Solder eyelet Ø tolerance	mm	+ 0,1	

Accessories

Note: Refer to the Accessories chapter for additional accessories.

Screwdriver		Order No.
	SDS 0.6X3.5X100	2749340000
	SDIS 0.6X3.5X100	2749810000

Ordering data

Solder pin length		3.5 mm		
Colour		orange		
Pitch	5.00 mm			
Pol.	L1	(inch)	Qty.	Order No.
2	5.00	0.197	100	1913780000
3	10.00	0.394	100	1913820000
4	15.00	0.591	100	1913960000
5	20.00	0.787	100	1914000000
6	25.00	0.984	100	1914020000
7	30.00	1.181	100	1914030000
8	35.00	1.378	100	1914040000
9	40.00	1.575	100	1914050000
10	45.00	1.772	100	1914070000
11	50.00	1.969	100	1914080000
12	55.00	2.165	100	1914090000

Representative deratings curve

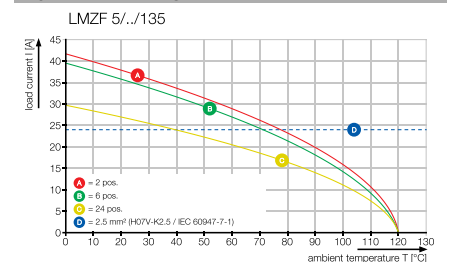

LMZFL 5/./135



Dimensioned drawing

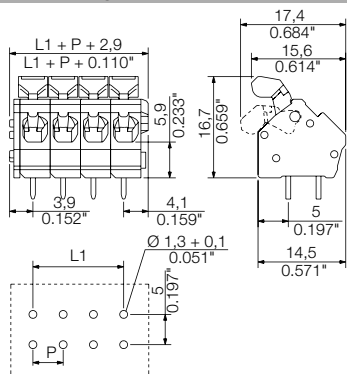

Ordering data

Solder pin length		3.5 mm	
Colour		orange	
Pitch		5.00 mm	
Pol.	L1	(inch)	Qty. Order No.
2	5.00	0.197	100 1914560000
3	10.00	0.394	100 1914580000
4	15.00	0.591	100 1914590000
5	20.00	0.787	100 1914600000
6	25.00	0.984	100 1914640000
7	30.00	1.181	100 1914720000
8	35.00	1.378	100 1914790000
9	40.00	1.575	100 1914830000
10	45.00	1.772	100 1914860000
11	50.00	1.969	100 1914990000
12	55.00	2.165	100 1915030000

G

Additional deratings curves

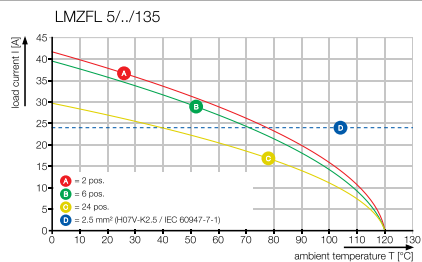

LMZF & LMZF 7../135

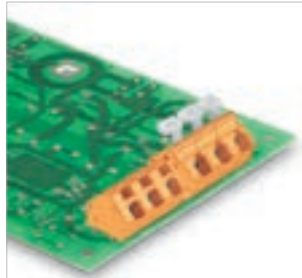

The compact installation terminal with tension clamp spring connection in 7.xx mm pitch for wire cross-sections up to 2.5 mm².

- Variable pitch: 7.50 - 7.62 mm
- 1 component = 2 pitches
- Wire outlet direction: 135° version
- Convenient: optional lever for opening the contact point.

Product data

IEC: 1000 V / 24 A / 0.13 - 2.5 mm²
 UL: 300 V / 15 A / AWG 26 - 14



For additional articles and information, refer to catalog.weidmueller.com

Note:

- Rated current related to rated cross-section & min. No. of poles.
- Wire end ferrule without plastic collar to DIN 46228/1
- Wire end ferrule with plastic collar to DIN 46228/4
- P on drawing = pitch
- Rated data refer only to the component itself. Clearance and creepage distances to other components are to be designed in accordance with the relevant application standards.
- Long term storage of the product with average temperature of 50 °C and average humidity 70%, 36 months

LMZF 7../135



Dimensioned drawing

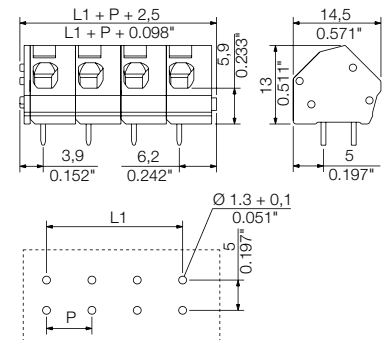

Technical data

In compliance with IEC 60664-1 / IEC 61984			
Clamping range, max.	mm ²	0.13...2.5	
Solid core H05(07) V-U	mm ²	0.13...2.5	
Stranded H07 V-R			
Flexible H05(07) V-K	mm ²	0.13...2.5	
Flexible with ferrule	mm ²	0.25...1.5	
Ferrule with plastic collar	mm ²	0.25...1.5	
Stripping length	mm	6	
Screwdriver blade	mm	0.6 x 3.5	
According to norm		DIN 5264-A	
Tightening torque range			
Rated current, max.	A	24	24
At ambient temperature		20°C	40°C
For conductor cross-section			
Overtoltage category		III	III II
Pollution severity		3	2 2
Rated voltage	V	400	800 1000
Rated impulse voltage	kV	6	6 6
UL / CUL (Use Group)	B C D		
Rated voltage	V	300	150 300
Rated current	A	15	15 10
AWG conductor	AWG	26-14	
CSA (Use Group)	B C D		
Rated voltage	V	300	150 300
Rated current	A	15	15 10
AWG conductor	AWG	26-14	
General data			
Type of insulation material		Wemid (PA)	
UL 94 flammability rating		V-0	
Contact base material		Copper alloy	
Material of contact surface		tinned	
Pin dimensions = d	mm	0.8 x 0.8	
Solder eyelet Ø = D	mm	1.3	
Solder eyelet Ø tolerance	mm	+ 0,1	

Accessories

Note: Refer to the Accessories chapter for additional accessories.

Screwdriver		Order No.
	SDS 0.6X3.5X100	2749340000
	SDIS 0.6X3.5X100	2749810000

Ordering data

Solder pin length		3.5 mm		
Colour		orange		
Pitch		7.50 mm		
Pol.	L1	(inch)	Qty.	Order No.
2	7.50	0.295	100	1952570000
3	15.00	0.591	100	1952580000
4	22.50	0.886	100	1952590000
5	30.00	1.181	100	1952600000
6	37.50	1.476	100	1952610000
7	45.00	1.772	100	1952620000
8	52.50	2.067	100	1952630000
9	60.00	2.362	100	1952640000
10	67.50	2.657	100	1952650000
11	75.00	2.953	100	1952660000
12	82.50	3.248	100	1952670000

Representative deratings curve

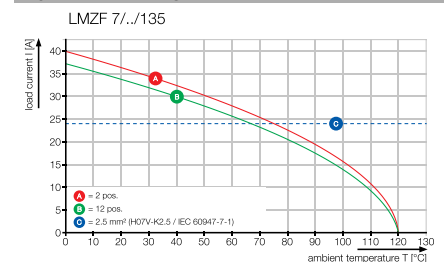

LMZFL 7../135



Dimensioned drawing

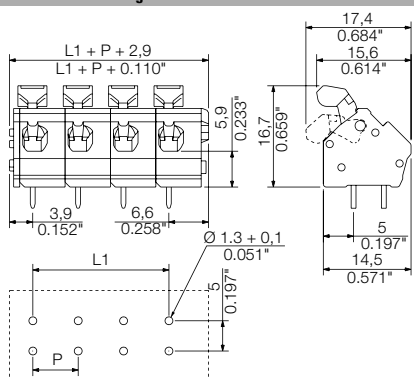

Ordering data

Solder pin length		3.5 mm	
Colour		orange	
Pitch		7.50 mm	
Pol.	L1	(inch)	Qty. Order No.
2	7.50	0.295	100 1953010000
3	15.00	0.591	100 1953020000
4	22.50	0.886	100 1953030000
5	30.00	1.181	100 1953040000
6	37.50	1.476	100 1953050000
7	45.00	1.772	100 1953060000
8	52.50	2.067	100 1953070000
9	60.00	2.362	100 1953080000
10	67.50	2.657	100 1953090000
11	75.00	2.953	100 1953100000
12	82.50	3.248	100 1953110000

OMNIMATE® Signal PCB terminals

G

Additional deratings curves

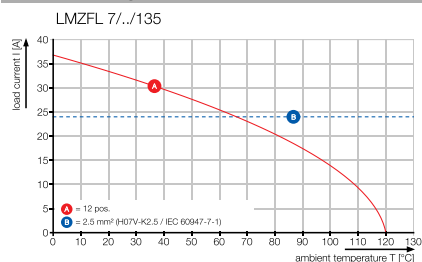

LMZF & LMZFL 10../135

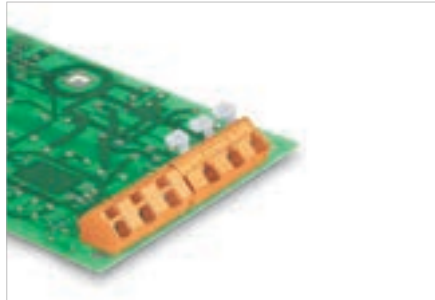

The compact installation terminal with tension clamp spring connection in 10.xx-mm pitch for wire cross-sections up to 2.5 mm².

- Variable pitch 10.00 - 10.16 mm
- 1 component = 2 pitches
- Wire outlet direction: 135° version
- Convenient: optional lever for opening the contact point.

Product data

IEC: 1000 V / 24 A / 0.13 - 2.5 mm²
 UL: 300 V / 15 A / AWG 26 - 14



For additional articles and information, refer to catalog.weidmueller.com

Note:

- Rated current related to rated cross-section & min. No. of poles.
- Wire end ferrule without plastic collar to DIN 46228/1
- Wire end ferrule with plastic collar to DIN 46228/4
- P on drawing = pitch
- Rated data refer only to the component itself. Clearance and creepage distances to other components are to be designed in accordance with the relevant application standards.
- Long term storage of the product with average temperature of 50 °C and average humidity 70%, 36 months

LMZF 10../135



Dimensioned drawing

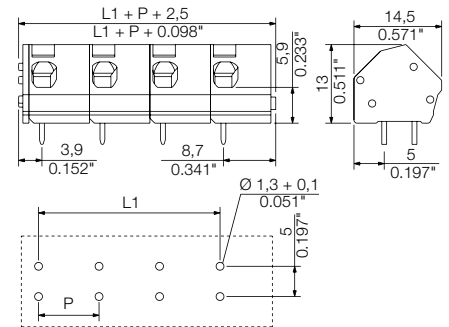

Technical data

In compliance with IEC 60664-1 / IEC 61984			
Clamping range, max.	mm ²	0.13...2.5	
Solid core H05(07) V-U	mm ²	0.13...2.5	
Stranded H07 V-R			
Flexible H05(07) V-K	mm ²	0.13...2.5	
Flexible with ferrule	mm ²	0.25...1.5	
Ferrule with plastic collar	mm ²	0.25...1.5	
Stripping length	mm	6	
Screwdriver blade	mm	0.6 x 3.5	
According to norm		DIN 5264	
Tightening torque range			
Rated current, max.	A	24	24
At ambient temperature		20°C	40°C
For conductor cross-section			
Overtoltage category		III	III II
Pollution severity		3	2 2
Rated voltage	V	500	1000 1000
Rated impulse voltage	kV	8	8 8
UL / CUL (Use Group)	B C D	B	C D
Rated voltage	V	300	150 300
Rated current	A	15	15 10
AWG conductor	AWG	26-14	
CSA (Use Group)	B C D	B	C D
Rated voltage	V	300	150 300
Rated current	A	15	15 10
AWG conductor	AWG	26-14	
General data			
Type of insulation material		Wemid (PA)	
UL 94 flammability rating		V-0	
Contact base material		Copper alloy	
Material of contact surface		tinned	
Pin dimensions = d	mm	0.8 x 0.8	
Solder eyelet Ø = D	mm	1.3	
Solder eyelet Ø tolerance	mm	+ 0,1	

Accessories

Note: Refer to the Accessories chapter for additional accessories.

Screwdriver		Order No.
	SDS 0.6X3.5X100	2749340000
	SDIS 0.6X3.5X100	2749810000

Ordering data

Solder pin length		3.5 mm		
Colour		orange		
Pitch		10.00 mm		
Pol.	L1	(inch)	Qty.	Order No.
2	10.00	0.394	100	1953470000
3	20.00	0.787	100	1953480000
4	30.00	1.181	100	1953490000
5	40.00	1.575	100	1953500000
6	50.00	1.969	100	1953510000
7	60.00	2.362	100	1953520000
8	70.00	2.756	100	1953530000
9	80.00	3.150	100	1953540000
10	90.00	3.543	100	1953550000
11	100.00	3.937	100	1953560000
12	110.00	4.331	100	1953570000

Representative deratings curve

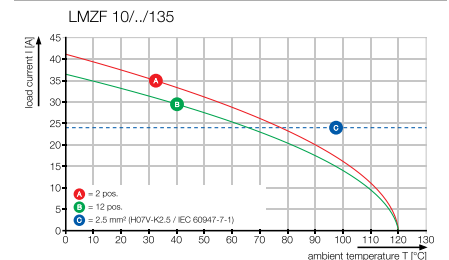

LMZFL 10../135



Dimensioned drawing

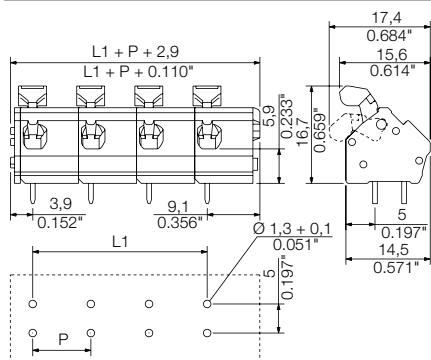

Ordering data

Solder pin length		3.5 mm	
Colour		orange	
Pitch		10.00 mm	
Pol.	L1	(inch)	Qty. Order No.
2	10.00	0.394	100 1953930000
3	20.00	0.787	100 1953940000
4	30.00	1.181	100 1953950000
5	40.00	1.575	100 1953960000
6	50.00	1.969	100 1953970000
7	60.00	2.362	100 1953980000
8	70.00	2.756	100 1953990000
9	80.00	3.150	100 1954000000
10	90.00	3.543	100 1954010000
11	100.00	3.937	100 1954020000
12	110.00	4.331	100 1954030000

Additional deratings curves

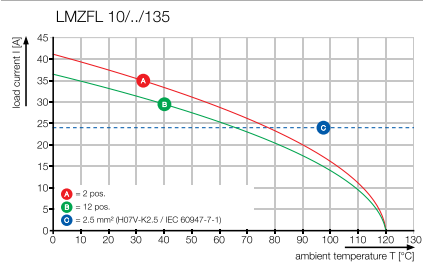

LMZF 5.08, multi-level



The high-performance device interface with a high connection density. Multi-level PCB terminal with tension clamp spring connection in 5.08 mm pitch for wire cross-sections up to 2.5 mm².

- Wire outlet direction: 135° version
- Simple switching of connection system - layout compatible with multi-level screw terminals.

Product data

IEC: 630 V / 15 A / 0.2 - 2.5 mm²
 UL: 300 V / 10 A / AWG 24 - 14



For additional articles and information, refer to catalog.weidmueller.com

Note:

- Rated current related to rated cross-section & min. No. of poles.
- Wire end ferrule without plastic collar to DIN 46228/1
- Wire end ferrule with plastic collar to DIN 46228/4
- P on drawing = pitch
- Rated data refer only to the component itself. Clearance and creepage distances to other components are to be designed in accordance with the relevant application standards.
- Long term storage of the product with average temperature of 50 °C and average humidity 70%, 36 months

LM2NZF 5.08../135



Dimensioned drawing

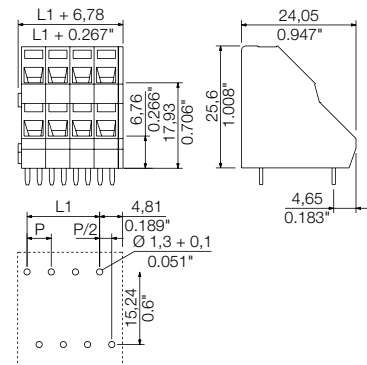

Ordering data

Solder pin length		3.5 mm		
Colour		orange		
Pitch		5.08 mm		
Pol.	L1	(inch)	Qty.	Order No.
4	5.08	0.200	50	1764810000
6	10.16	0.400	50	1764820000
8	15.24	0.600	50	1764830000
10	20.32	0.800	50	1764840000
12	25.40	1.000	50	1764850000
14	30.48	1.200	20	1764860000
16	35.56	1.400	20	1764870000
18	40.64	1.600	20	1764880000
20	45.72	1.800	20	1758020000
22	50.80	2.000	20	1764890000
24	55.88	2.200	10	1764900000

Representative deratings curve

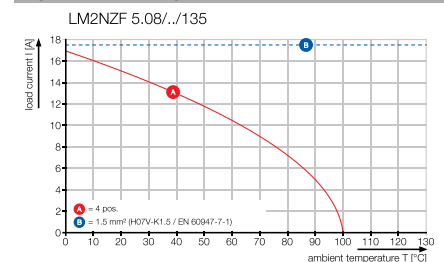

Technical data

In compliance with IEC 60664-1 / IEC 61984			
Clamping range, max.	mm ²	0.13...2.5	
Solid core H05(07) V-U	mm ²	0.2...2.5	
Stranded H07 V-R			
Flexible H05(07) V-K	mm ²	0.2...1.5	
Flexible with ferrule	mm ²	0.25...1.5	
Ferrule with plastic collar	mm ²	0.25...1.5	
Stripping length	mm	7.5	
Screwdriver blade	mm	0.6 x 3.5	
According to norm		DIN 5264-A	
Tightening torque range			
Rated current, max.	A	15	13
At ambient temperature		20°C	40°C
For conductor cross-section			
Overtoltage category		III	III II
Pollution severity		3	2 2
Rated voltage	V	250	320 630
Rated impulse voltage	kV	4	4 4
UL / CUL (Use Group)	B C D	B C D	B C D
Rated voltage	V	300	300
Rated current	A	10	10
AWG conductor	AWG	24-14	
CSA (Use Group)	B C D	B C D	B C D
Rated voltage	V	300	300
Rated current	A	10	10
AWG conductor	AWG	24-14	
General data			
Type of insulation material		PA	
UL 94 flammability rating		V-0	
Contact base material			
Material of contact surface			
Pin dimensions = d	mm	0.7 x 1.0	
Solder eyelet Ø = D	mm	1.3	
Solder eyelet Ø tolerance	mm	+ 0,1	

Accessories

Note: Refer to the Accessories chapter for additional accessories.

Screwdriver		Order No.
	SDS 0.6X3.5X100	2749340000
	SDIS 0.6X3.5X100	2749810000



LM3RZF 5.08/./135



Dimensioned drawing

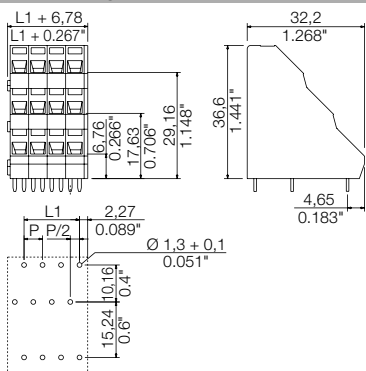

Ordering data

Solder pin length		3.5 mm	
Colour		orange	
Pitch		5.08 mm	
Pol.	L1	(inch)	Qty. Order No.
6	5.08	0.200	50 1764910000
9	10.16	0.400	50 1764920000
12	15.24	0.600	50 1764930000
15	20.32	0.800	20 1764940000
18	25.40	1.000	20 1764950000
21	30.48	1.200	20 1758040000
24	35.56	1.400	10 1764960000
27	40.64	1.600	10 1764970000
30	45.72	1.800	10 1758030000
33	50.80	2.000	10 1764980000
36	55.88	2.200	10 1764990000

Additional deratings curves

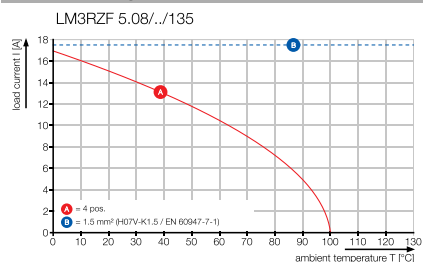

OMNIMATE® Signal PCB connectors in 1.27 mm pitch Board-to-Board

OMNIMATE® Signal	Explanation	H.2
PCB connectors in 1.27 mm pitch Board-to-Board	Quick selection	H.4
	Connectors in 1.27 mm pitch Series FM/FF - Board-to-Board	H.6
	Connectors in 1.27 mm pitch Series FC assembled cables - Board-to-Board	H.20



OMNIMATE® Signal Board-to-Board solutions

Flexible engineering of compact devices

The use of future-proof contact systems, as well as the optimization of manufacturing processes, are increasingly important in the development of efficient industrial devices, especially in the field of Industry 4.0. OMNIMATE® board-to-board connectors feature a 1.27 mm pitch and offer maximum flexibility due to different designs.

Reliable connection

Robust design thanks to coordinated contact geometries and latching clip

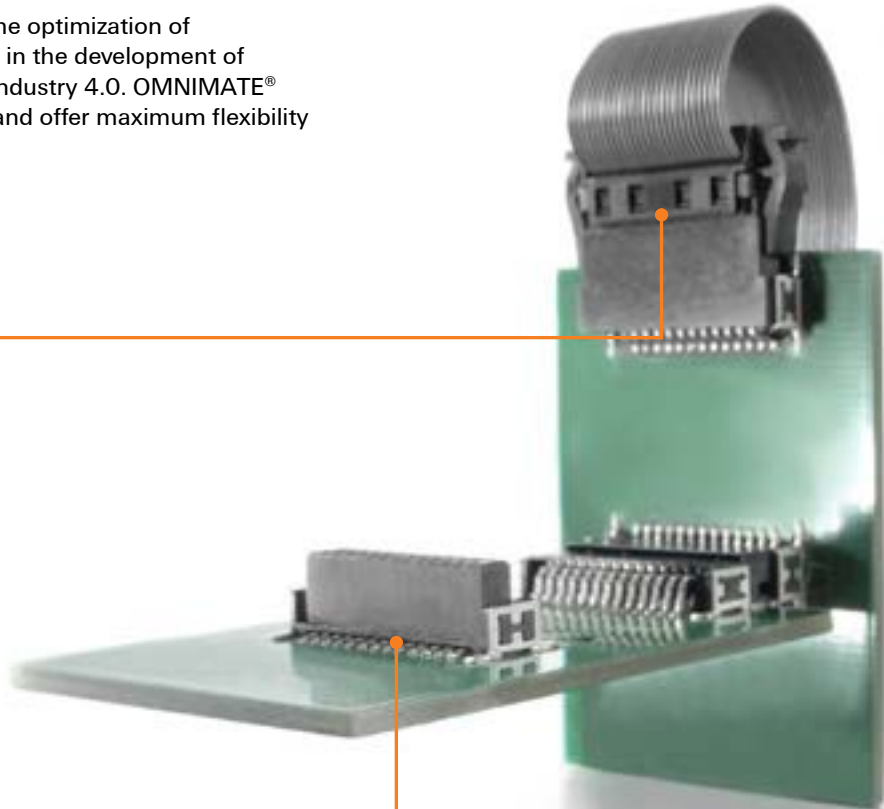

Flexible device design

Different designs with 1.27 mm pitch enable all conceivable interface combinations – from mother-to-daughter and extender card to cable-to-board and mezzanine.

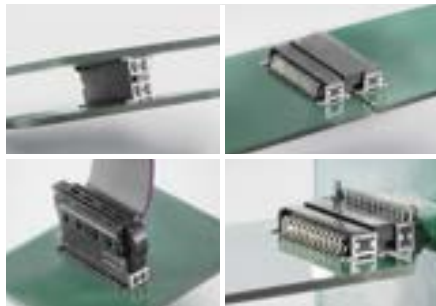

Flexible device design

Different designs with 1.27 mm pitch enable all conceivable interface combinations – from mother-to-daughter and extender card to cable-to-board and mezzanine.



H

Automation-Ready

Precise pin coplanarity and packaging makes automatic assembly reliable



Process-Ready

High performance LCP material for reflow soldering

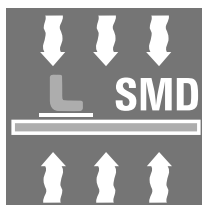

H

Scalability

Different heights with high contact overlapping ensure various solutions from 12 – 80 poles.



Reliable contact

Up to 500 mating cycles due to industry suitable gold-surface (PdNi-Au).



<http://www.OMNIMATE.net>



Series FF / FM

- Up to 500 mating cycles
- LCP material for reflow soldering
- 12 - 80 poles
- Further variants on request



Female header



FFH6 S1/..V

6.25 mm

vertical

Reel



FFH9 S1/..V

9.05 mm

vertical

Reel



1

FFH S1/..H

horizontal

Reel



FFP D1/..H

horizontal / vertical

Tray



FC..

horizontal / vertical

Bag

Female plug

- IDC connector suitable for ribbon cable
- Assembled cables in different lengths (0,10 m, 0,20 m, 0,50 m)
- Cable in PVC or TPE material
- Optional strain relief

Type

Height

Conductor outlet direction

Packaging

Male header



2

FMH1 S1../.V 1.75 mm vertical Reel Mezzanine S = 8 mm - 9. mm	FMH3 S1../.V 3.25 mm vertical Reel Mezzanine S = 9,5 mm - 11 mm	FMH S1../.H horizontal Reel Mother-to-Daughter P = min. 7.70 mm O = min. 11.53 mm
Mezzanine S = 10.8 mm - 12.3 mm	Mezzanine S = 12.3 mm - 13.8 mm	Mother-to-Daughter P = min. 10.50 mm O = min. 14.33 mm
Mother-to-Daughter P = min. 8.75 mm O = min. 12.58 mm	Mother-to-Daughter P = min. 10.25 mm O = min. 14.08 mm	Extender-Board P = min. 8.6 mm O = min. 16.25 mm
Board-to-Wire	Board-to-Wire	Board-to-Wire
Board-to-Wire	Board-to-Wire	Board-to-Wire

Mezzanine

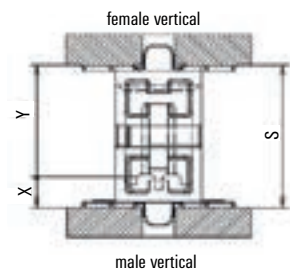

Mother-to-Daughter A

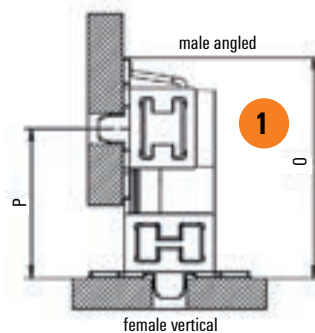

Mother-to-Daughter B

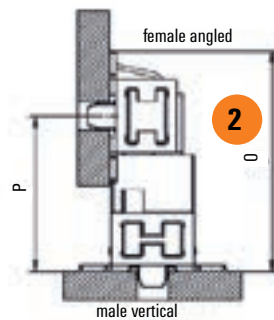

Extender-Board

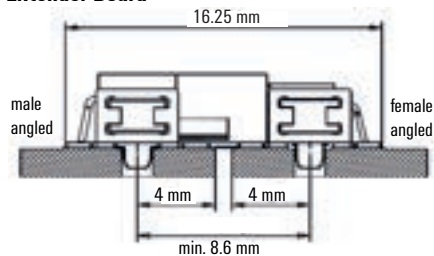

H

Connectors in 1.27 mm pitch Series FM/FF - Board-to-Board

FMH S1/..H (horizontal)

For additional articles and information, refer to catalog.weidmueller.com



Technical data

Outgoing elbow	90°
Pitch	1.27 mm
Construction type	male header
Mounting onto the PCB	SMD solder connection
Side termination, characteristic	Solder flange
Type of insulation material	LCP
Colour	black
Contact base material	Copper alloy
Layer structure of plug contact	≥ 2 μm Ni / ≥ 0.4 μm PdNi / ≥ 0.05 μm Au
Note	Other variants on request.

Operating temperature	-55...125 °C
Clearance, min.	0.4 mm
Rated current, min. number of poles (Tu=20°C)	2.8 A
Volume resistance	<25 mΩ
Insulation strength	≥ 10 ¹⁰ Ω
Plugging cycles	500
Pulling force / pole	0.40...0.6 N
Approvals	CURUS
Packaging	Tape



H

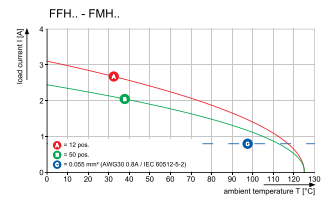

Ordering data

Type	Pol.	Qty.	Order No.
FMH S1/12H F1 B RL	12	560	2747160000
FMH S1/16H F1 B RL	16	560	2747170000
FMH S1/20H F1 B RL	20	560	2747180000
FMH S1/26H F1 B RL	26	560	2747190000
FMH S1/32H F1 B RL	32	560	2747200000
FMH S1/40H F1 B RL	40	560	2747210000
FMH S1/50H F1 B RL	50	560	2747220000
FMH S1/68H F1 B RL	68	560	2747230000
FMH S1/80H F1 B RL	80	560	2747240000



Drawing dimensions

Type	No. of poles	A	B	C	D	E	Order no.
FMH S1/12H F1 B RL	12	6.35	10.77	12.7	9.57	8.57	2747160000
FMH S1/16H F1 B RL	16	8.89	13.31	15.24	12.11	11.11	2747170000
FMH S1/20H F1 B RL	20	11.43	15.85	17.78	14.65	13.65	2747180000
FMH S1/26H F1 B RL	26	15.24	19.66	21.59	18.46	17.46	2747190000
FMH S1/32H F1 B RL	32	19.05	23.47	25.4	22.27	21.27	2747200000
FMH S1/40H F1 B RL	40	24.13	28.55	30.48	27.35	26.35	2747210000
FMH S1/50H F1 B RL	50	30.48	34.9	36.83	33.7	32.7	2747220000
FMH S1/68H F1 B RL	68	41.91	46.33	48.26	45.13	44.13	2747230000
FMH S1/80H F1 B RL	80	49.53	53.95	55.88	52.75	51.75	2747240000

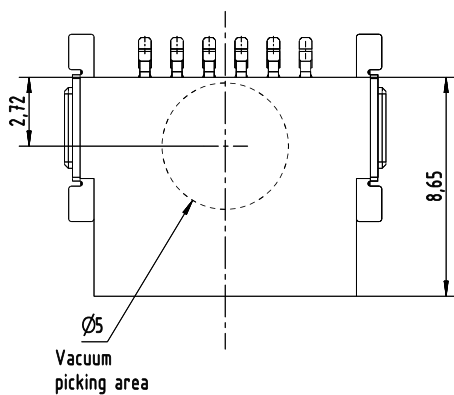
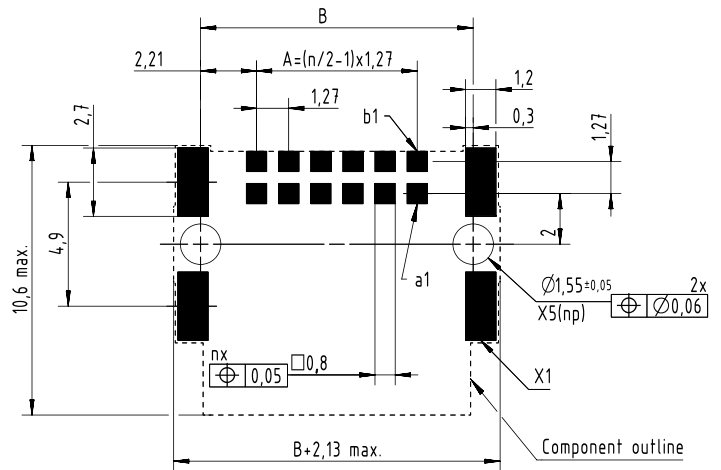
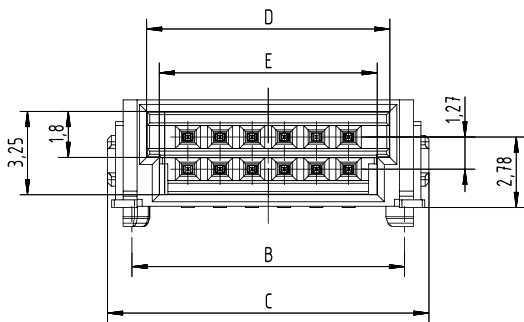
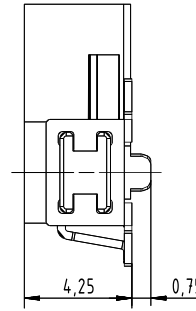
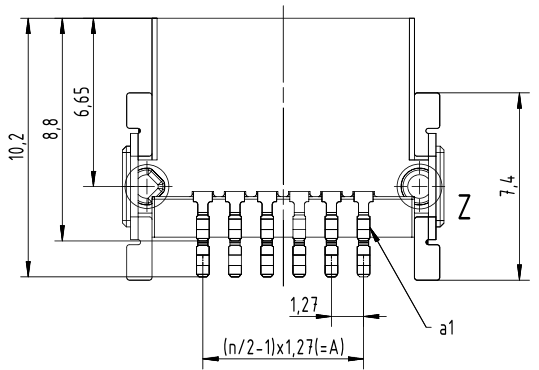

Y (10:1)

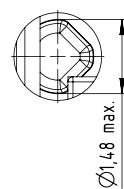

Z (10:1)

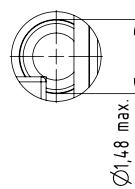

x= only mechanical
np= not plated thru hole
n= number of poles

Connectors in 1.27 mm pitch Series FM/FF - Board-to-Board

FMH1 S1/..V (vertical, height 1.75 mm)



For additional articles and information, refer to catalog.weidmueller.com



Technical data

Outgoing elbow	180°
Pitch	1.27 mm
Construction type	male header
Mounting onto the PCB	SMD solder connection
Side termination, characteristic	Solder flange
Type of insulation material	LCP
Colour	black
Contact base material	Copper alloy
Layer structure of plug contact	≥ 2 µm Ni / ≥ 0.4 µm PdNi / ≥ 0.05 µm Au
Note	Other variants on request.

Operating temperature	-55...125 °C
Clearance, min.	0.4 mm
Rated current, min. number of poles (Tu=20°C)	2.8 A
Volume resistance	<25 mΩ
Insulation strength	≥ 10 ¹⁰ Ω
Plugging cycles	500
Pulling force / pole	0.40...0.6 N
Approvals	CURUS
Packaging	Tape



H

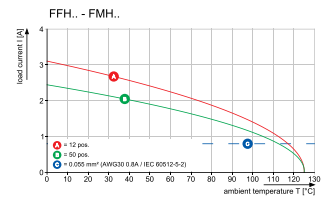

Ordering data

Type	Pol.	Qty.	Order No.
FMH1 S1/12V F1 B RL	12	280	2746980000
FMH1 S1/16V F1 B RL	16	280	2746990000
FMH1 S1/20V F1 B RL	20	280	2747000000
FMH1 S1/26V F1 B RL	26	280	2747010000
FMH1 S1/32V F1 B RL	32	280	2747020000
FMH1 S1/40V F1 B RL	40	280	2747030000
FMH1 S1/50V F1 B RL	50	280	2747040000
FMH1 S1/68V F1 B RL	68	280	2747050000
FMH1 S1/80V F1 B RL	80	280	2747060000



Drawing dimensions

Type	No. of poles	A	B	C	D	E	F	G	Order no.
FMH1 S1/12V F1 B RL	12	6.35	10.77	12.7	9.57	8.57	10.37	2.96	2747980000
FMH1 S1/16V F1 B RL	16	8.89	13.31	15.24	12.11	11.11	12.91	4.23	2747990000
FMH1 S1/20V F1 B RL	20	11.43	15.85	17.78	14.65	13.65	15.45	5.5	2747000000
FMH1 S1/26V F1 B RL	26	15.24	19.66	21.59	18.46	17.46	19.26	7.4	2747010000
FMH1 S1/32V F1 B RL	32	19.05	23.47	25.4	22.27	21.27	23.07	9.31	2747020000
FMH1 S1/40V F1 B RL	40	24.13	28.55	30.48	27.35	26.35	28.15	11.85	2747030000
FMH1 S1/50V F1 B RL	50	30.48	34.9	36.83	33.7	32.7	34.5	15.02	2747040000
FMH1 S1/68V F1 B RL	68	41.91	46.33	48.26	45.13	44.13	45.93	20.74	2747050000
FMH1 S1/80V F1 B RL	80	49.53	53.95	55.88	52.75	51.75	53.55	24.55	2747060000

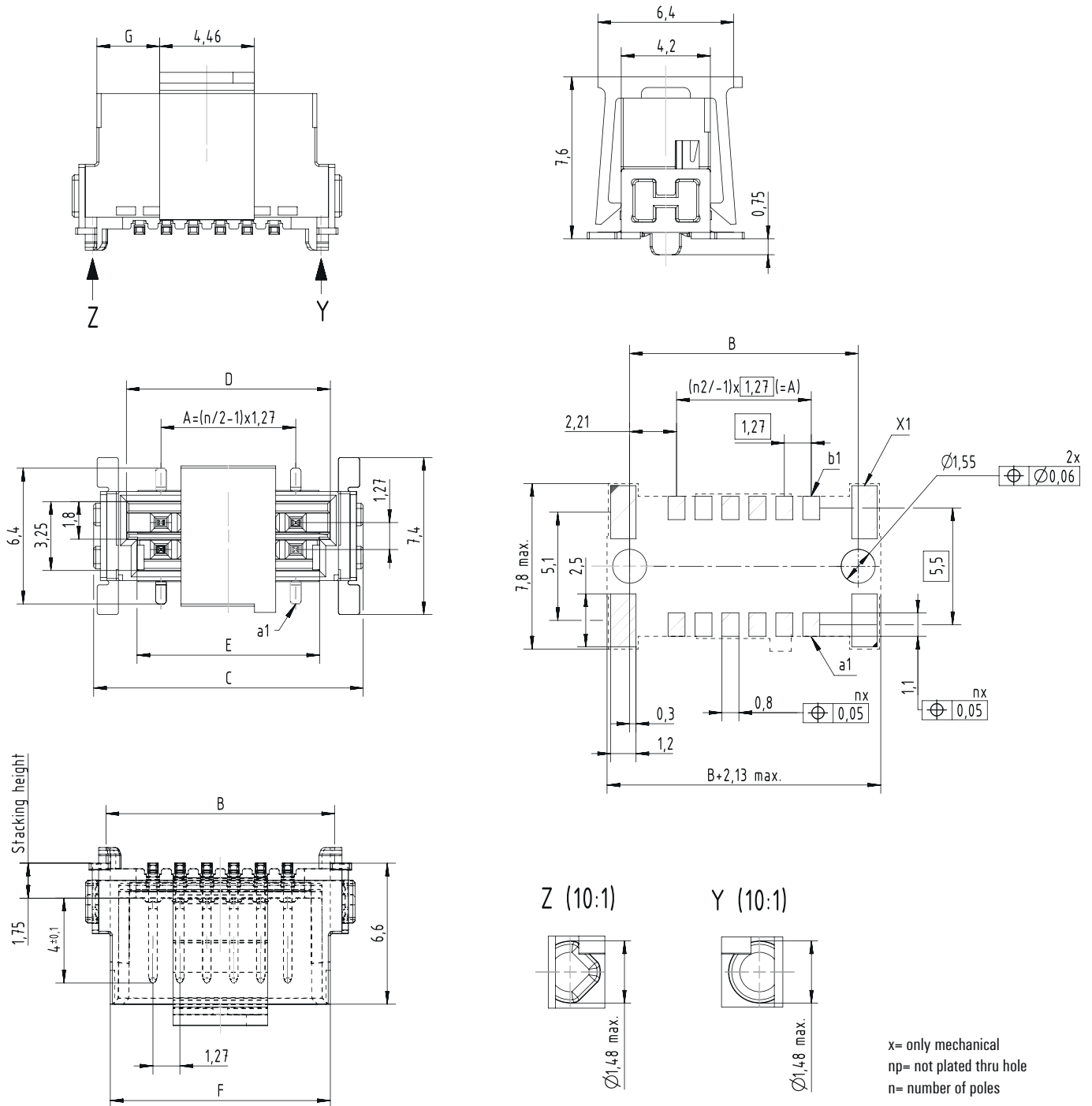

**Connectors in 1.27 mm pitch
Series FM/FF – Board-to-Board**

FMH3 S1/..V (vertical, height 3.25 mm)

For additional articles and information, refer to catalog.weidmueller.com



Technical data

Outgoing elbow	180°
Pitch	1.27 mm
Construction type	male header
Mounting onto the PCB	SMD solder connection
Side termination, characteristic	Solder flange
Type of insulation material	LCP
Colour	black
Contact base material	Copper alloy
Layer structure of plug contact	≥ 2 µm Ni / ≥ 0.4 µm PdNi / ≥ 0.05 µm Au
Note	Other variants on request.

Operating temperature	-55...125 °C
Clearance, min.	0.4 mm
Rated current, min. number of poles (Tu=20°C)	2.8 A
Volume resistance	<25 mΩ
Insulation strength	≥ 10 ¹⁰ Ω
Plugging cycles	500
Pulling force / pole	0.40...0.6 N
Approvals	CURUS
Packaging	Tape



H

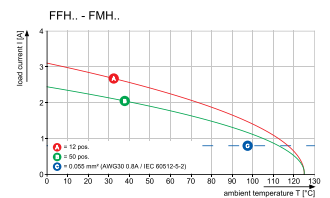

Ordering data

Type	Pol.	Qty.	Order No.
FMH3 S1/12V F1 B RL	12	280	2747070000
FMH3 S1/16V F1 B RL	16	280	2747080000
FMH3 S1/20V F1 B RL	20	280	2747090000
FMH3 S1/26V F1 B RL	26	280	2747100000
FMH3 S1/32V F1 B RL	32	280	2747110000
FMH3 S1/40V F1 B RL	40	280	2747120000
FMH3 S1/50V F1 B RL	50	280	2747130000
FMH3 S1/68V F1 B RL	68	280	2747140000
FMH3 S1/80V F1 B RL	80	280	2747150000



Drawing dimensions

Type	No. of poles	A	B	C	D	E	F	G	Order no.
FMH3 S1/12V F1 B RL	12	6.35	10.77	12.7	9.57	8.57	10.37	2.96	2747070000
FMH3 S1/16V F1 B RL	16	8.89	13.31	15.24	12.11	11.11	12.91	4.23	2747080000
FMH3 S1/20V F1 B RL	20	11.43	15.85	17.78	14.65	13.65	15.45	5.5	2747090000
FMH3 S1/26V F1 B RL	26	15.24	19.66	21.59	18.46	17.46	19.26	7.4	2747100000
FMH3 S1/32V F1 B RL	32	19.05	23.47	25.4	22.27	21.27	23.07	9.31	2747110000
FMH3 S1/40V F1 B RL	40	24.13	28.55	30.48	27.35	26.35	28.15	11.85	2747120000
FMH3 S1/50V F1 B RL	50	30.48	34.9	36.83	33.7	32.7	34.5	15.02	2747130000
FMH3 S1/68V F1 B RL	68	41.91	46.33	48.26	45.13	44.13	45.93	20.74	2747140000
FMH3 S1/80V F1 B RL	80	49.53	53.95	55.88	52.75	51.75	53.55	24.55	2747150000

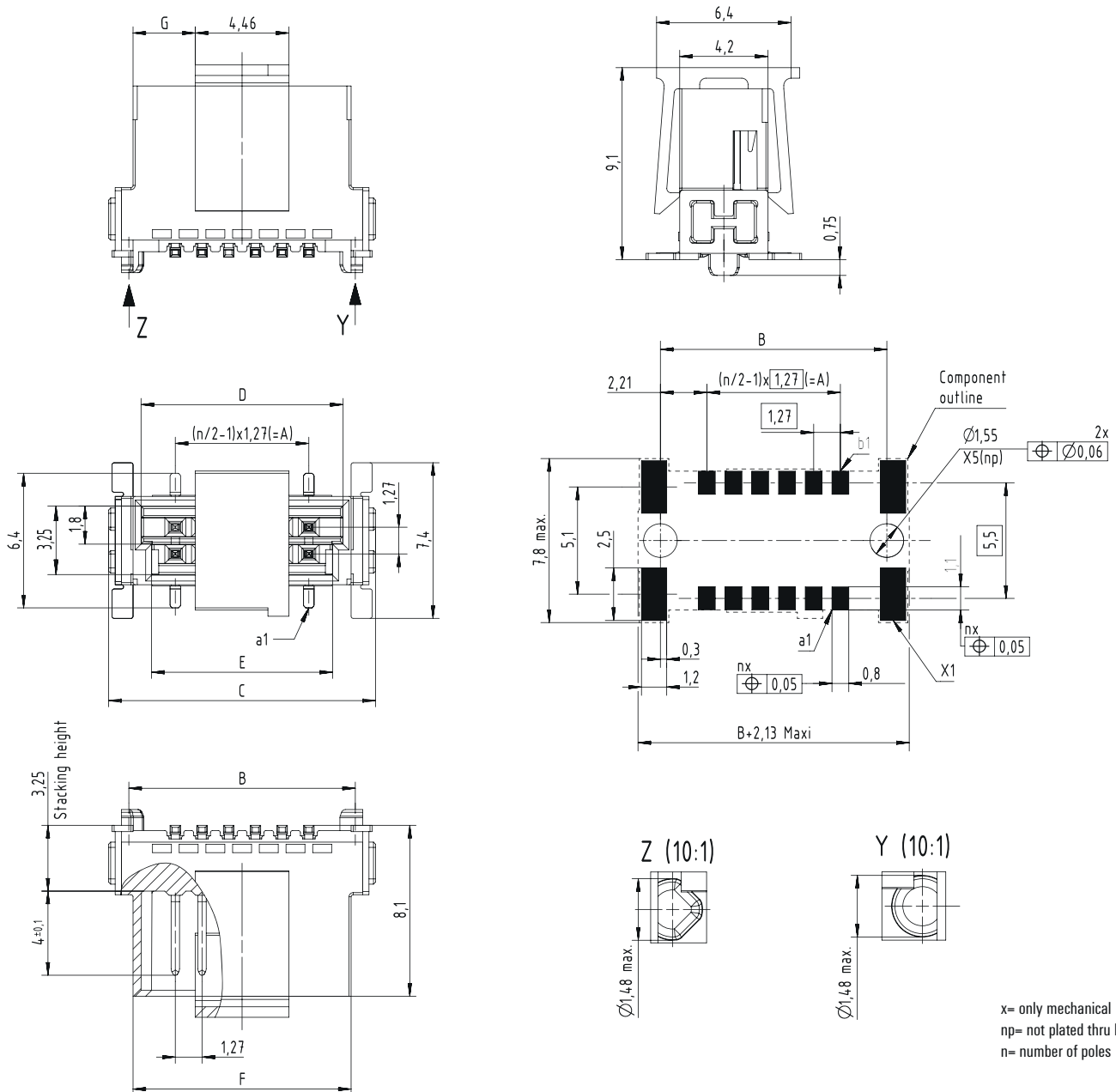

Connectors in 1.27 mm pitch
Series FM/FF - Board-to-Board

FFH S1/..H (horizontal)

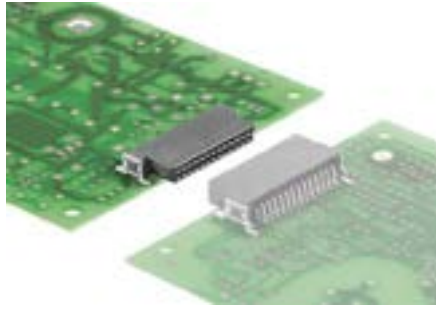

For additional articles and information, refer to catalog.weidmueller.com



Technical data

Outgoing elbow	90°
Pitch	1.27 mm
Construction type	female header
Mounting onto the PCB	SMD solder connection
Side termination, characteristic	Solder flange
Type of insulation material	LCP
Colour	black
Contact base material	Copper alloy
Layer structure of plug contact	≥ 2 μm Ni / ≥ 0.4 μm PdNi / ≥ 0.05 μm Au
Note	Other variants on request.

Operating temperature	-55...125 °C
Clearance, min.	0.4 mm
Rated current, min. number of poles (Tu=20°C)	2.8 A
Volume resistance	<25 mΩ
Insulation strength	≥ 10 ¹⁰ Ω
Plugging cycles	500
Pulling force / pole	0.40...0.6 N
Approvals	CURUS
Packaging	Tape



H

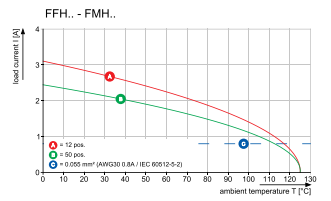

Ordering data

Type	Pol.	Qty.	Order No.
FFH S1/16H F1 B RL	16	560	2747440000
FFH S1/20H F1 B RL	20	560	2747450000
FFH S1/26H F1 B RL	26	560	2747460000
FFH S1/32H F1 B RL	32	560	2747470000
FFH S1/40H F1 B RL	40	560	2747480000
FFH S1/50H F1 B RL	50	560	2747490000
FFH S1/68H F1 B RL	68	560	2747500000
FFH S1/80H F1 B RL	80	560	2747510000



Drawing dimensions

Type	No. of poles	A	B	C	D	E	Order no.
FFH S1/12H F1 B RL	12	6.35	10.77	12.7	9.37	8.37	2747430000
FFH S1/16H F1 B RL	16	8.89	13.31	15.24	11.91	10.91	2747440000
FFH S1/20H F1 B RL	20	11.43	15.85	17.78	14.45	13.45	2747450000
FFH S1/26H F1 B RL	26	15.24	19.66	21.59	18.26	17.26	2747460000
FFH S1/32H F1 B RL	32	19.05	23.47	25.4	22.07	21.07	2747470000
FFH S1/40H F1 B RL	40	24.13	28.55	30.48	27.15	26.15	2747480000
FFH S1/50H F1 B RL	50	30.48	34.9	36.83	33.5	32.5	2747490000
FFH S1/68H F1 B RL	68	41.91	46.33	48.26	44.93	43.93	2747500000
FFH S1/80H F1 B RL	80	49.53	53.95	55.88	52.55	51.55	2747510000

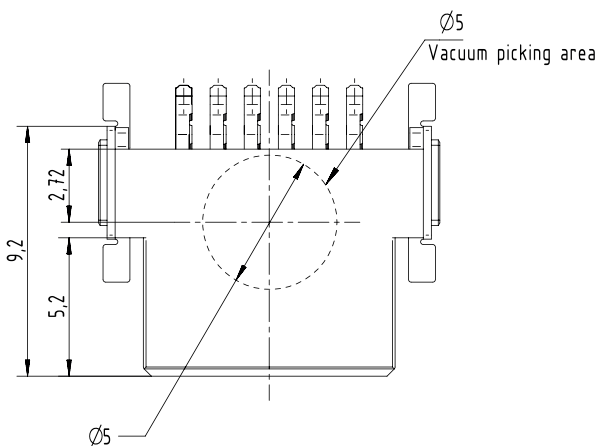
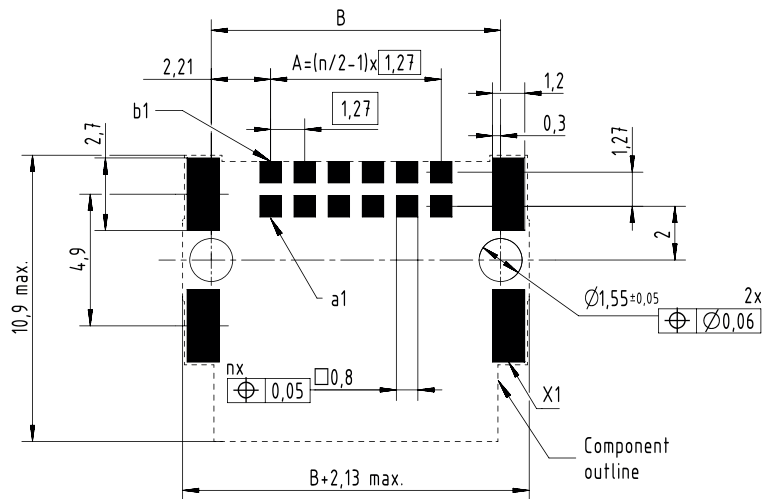
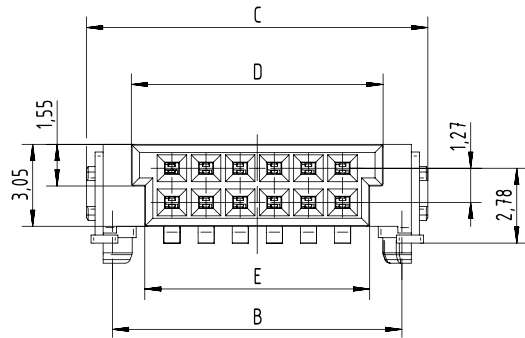
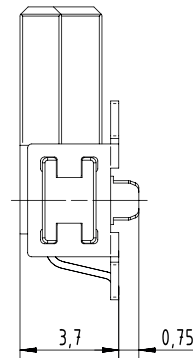
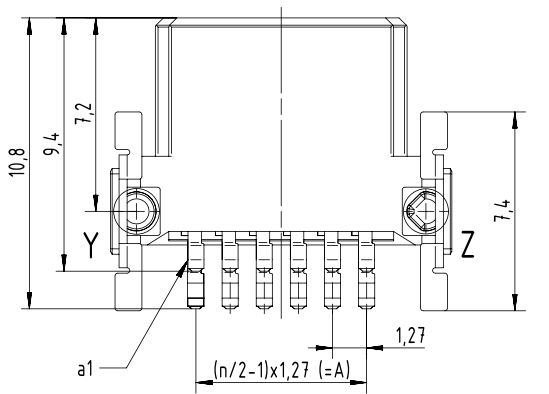

Y (10:1)

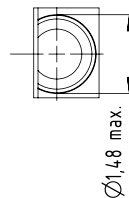

Z (10:1)

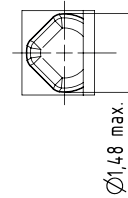

x= only mechanical
np= not plated thru hole
n= number of poles

**Connectors in 1.27 mm pitch
Series FM/FF - Board-to-Board**

FFH6 S1/..V (vertical, height 6.25 mm)



For additional articles and information, refer to catalog.weidmueller.com



Technical data

Outgoing elbow	180°
Pitch	1.27 mm
Construction type	female header
Mounting onto the PCB	SMD solder connection
Side termination, characteristic	Solder flange
Type of insulation material	LCP
Colour	black
Contact base material	Copper alloy
Layer structure of plug contact	≥ 2 µm Ni / ≥ 0.4 µm PdNi / ≥ 0.05 µm Au
Note	Other variants on request.

Operating temperature	-55...125 °C
Clearance, min.	0.4 mm
Rated current, min. number of poles (Tu=20°C)	2.8 A
Volume resistance	<25 mΩ
Insulation strength	≥ 10 ¹⁰ Ω
Plugging cycles	500
Pulling force / pole	0.40...0.6 N
Approvals	CURUS
Packaging	Tape



H

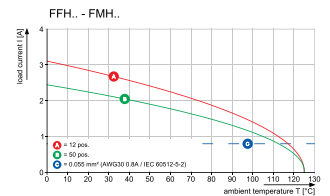

Ordering data

Type	Pol.	Qty.	Order No.
FFH6 S1/12V F1 B RL	12	280	2747250000
FFH6 S1/16V F1 B RL	16	280	2747260000
FFH6 S1/20V F1 B RL	20	280	2747270000
FFH6 S1/26V F1 B RL	26	280	2747280000
FFH6 S1/32V F1 B RL	32	280	2747290000
FFH6 S1/40V F1 B RL	40	280	2747300000
FFH6 S1/50V F1 B RL	50	280	2747310000
FFH6 S1/68V F1 B RL	68	280	2747320000
FFH6 S1/80V F1 B RL	80	280	2747330000



Drawing dimensions

Type	No. of poles	A	B	C	D	E	G	Order no.
FFH6 S1/12V F1 B RL	12	6.35	10.77	12.7	9.37	8.37	2.46	2747250000
FFH6 S1/16V F1 B RL	16	8.89	13.31	15.24	11.91	10.91	3.73	2747260000
FFH6 S1/20V F1 B RL	20	11.43	15.85	17.78	14.45	13.45	5	2747270000
FFH6 S1/26V F1 B RL	26	15.24	19.66	21.59	18.26	17.26	7.54	2747280000
FFH6 S1/32V F1 B RL	32	19.5	23.47	25.4	22.07	21.07	8.81	2747290000
FFH6 S1/40V F1 B RL	40	24.13	28.55	30.48	27.15	26.15	11.35	2747300000
FFH6 S1/50V F1 B RL	50	30.48	34.29	36.83	33.5	32.5	15.16	2747310000
FFH6 S1/68V F1 B RL	68	41.91	46.33	48.26	44.93	43.93	20.24	2747320000
FFH6 S1/80V F1 B RL	80	49.53	53.95	55.88	52.55	51.55	24.05	2747330000

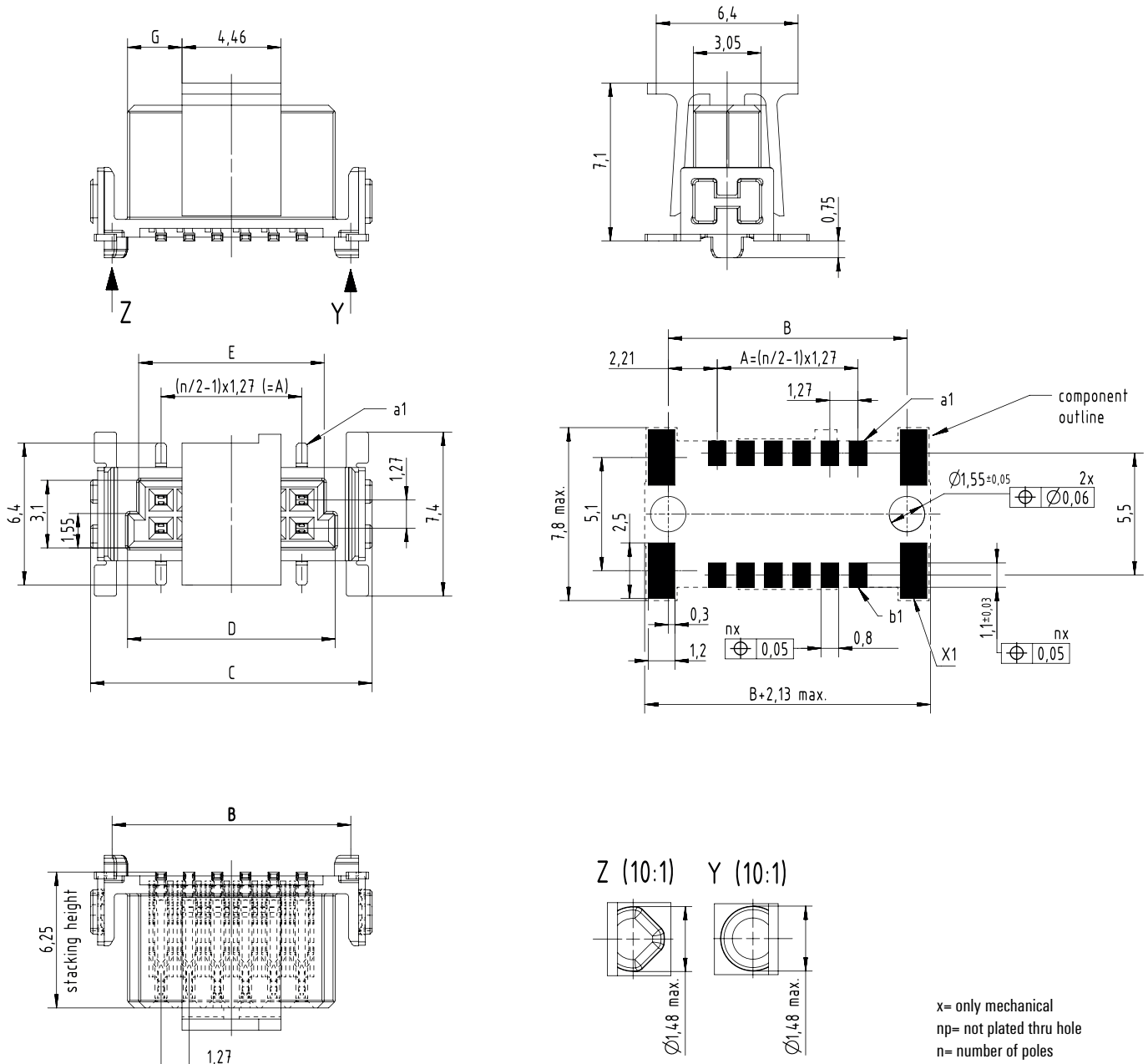

x= only mechanical
np= not plated thru hole
n= number of poles

**Connectors in 1.27 mm pitch
Series FM/FF - Board-to-Board**

FFH9 S1/..V (vertical, height 9.05 mm)

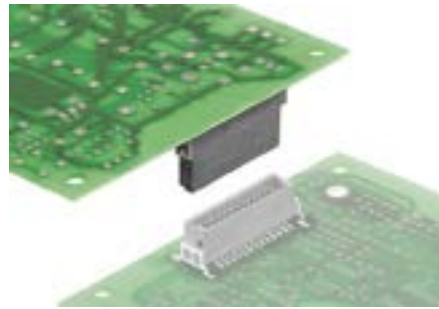

For additional articles and information, refer to catalog.weidmueller.com



Technical data

Outgoing elbow	180°
Pitch	1.27 mm
Construction type	female header
Mounting onto the PCB	SMD solder connection
Side termination, characteristic	Solder flange
Type of insulation material	LCP
Colour	black
Contact base material	Copper alloy
Layer structure of plug contact	≥ 2 µm Ni / ≥ 0.4 µm PdNi / ≥ 0.05 µm Au
Note	Other variants on request.

Operating temperature	-55...125 °C
Clearance, min.	0.4 mm
Rated current, min. number of poles (Tu=20°C)	2.8 A
Volume resistance	<25 mΩ
Insulation strength	≥ 10 ¹⁰ Ω
Plugging cycles	500
Pulling force / pole	0.40...0.6 N
Approvals	CURUS
Packaging	Tape



H

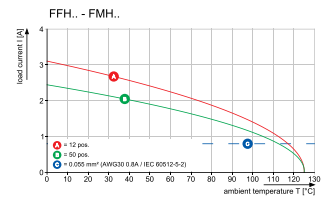

Ordering data

Type	Pol.	Qty.	Order No.
FFH9 S1/12V F1 B RL	12	280	2747340000
FFH9 S1/16V F1 B RL	16	280	2747350000
FFH9 S1/20V F1 B RL	20	280	2747360000
FFH9 S1/26V F1 B RL	26	280	2747370000
FFH9 S1/32V F1 B RL	32	280	2747380000
FFH9 S1/40V F1 B RL	40	280	2747390000
FFH9 S1/50V F1 B RL	50	280	2747400000
FFH9 S1/68V F1 B RL	68	280	2747410000
FFH9 S1/80V F1 B RL	80	280	2747420000



Drawing dimensions

Type	No. of poles	A	B	C	D	E	G	Order no.
FFH9 S1/12V F1 B RL	12	6.35	10.77	12.7	9.37	8.37	2.46	2747340000
FFH9 S1/16V F1 B RL	16	8.89	13.31	15.24	11.91	10.91	3.73	2747350000
FFH9 S1/20V F1 B RL	20	11.43	15.85	17.78	14.45	13.45	5	2747360000
FFH9 S1/26V F1 B RL	26	15.24	19.66	21.59	18.26	17.26	7.54	2747370000
FFH9 S1/32V F1 B RL	32	19.5	23.47	25.4	22.07	21.07	8.81	2747380000
FFH9 S1/40V F1 B RL	40	24.13	28.55	30.48	27.15	26.15	11.35	2747390000
FFH9 S1/50V F1 B RL	50	30.48	34.29	36.83	33.5	32.5	15.16	2747400000
FFH9 S1/68V F1 B RL	68	41.91	46.33	48.26	44.93	43.93	20.24	2747410000
FFH9 S1/80V F1 B RL	80	49.53	53.95	55.88	52.55	51.55	24.05	2747420000

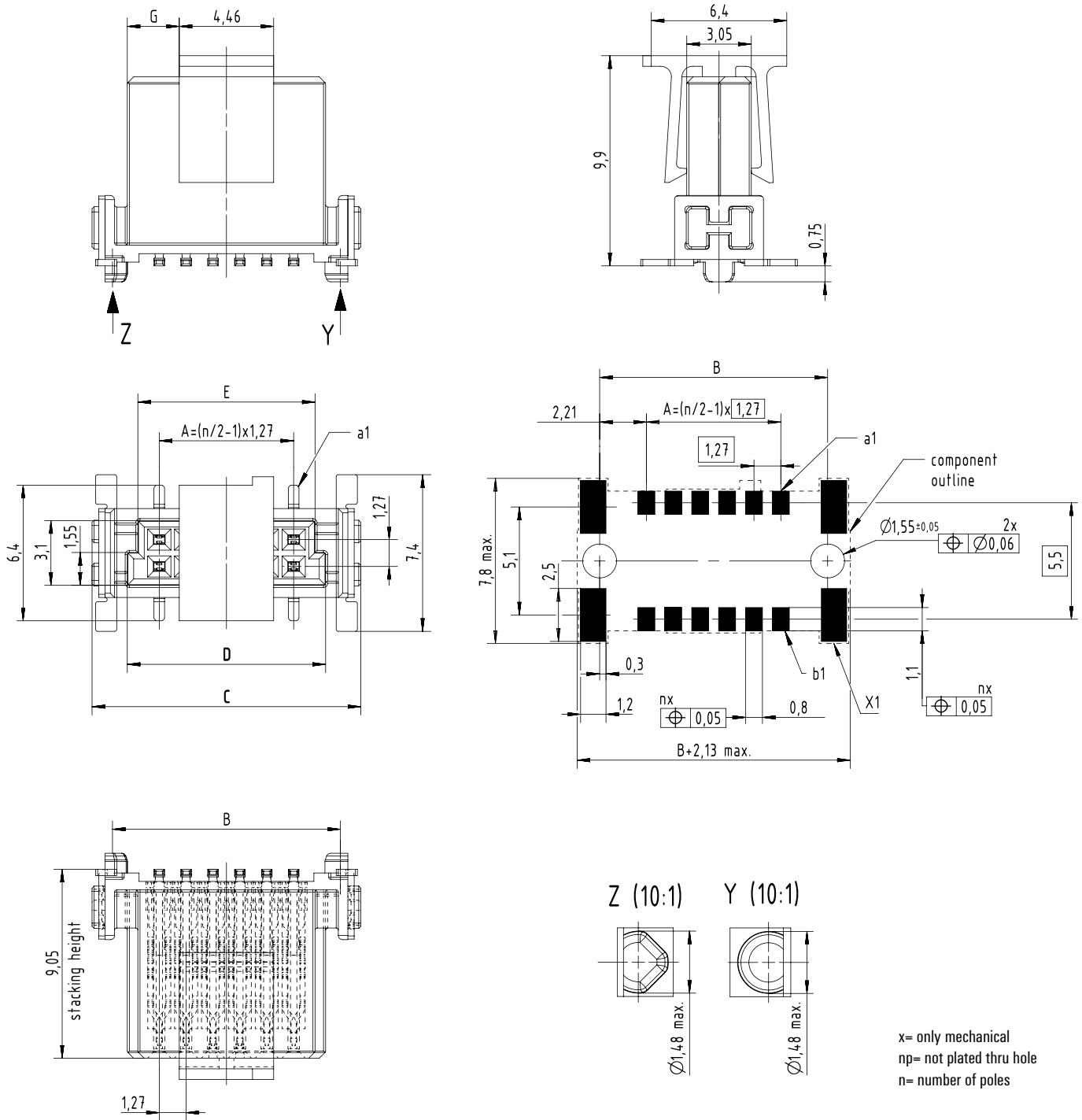

x= only mechanical
np= not plated thru hole
n= number of poles

**Connectors in 1.27 mm pitch
Series FM/FF – Board-to-Board**

FFP D1/..H (female connector without ribbon cable)

For additional articles and information, refer to catalog.weidmueller.com



Technical data

Conductor outlet direction	90°/270°
Pitch	1.27 mm
Type of connection	Insulation displacement connection (IDC)
Wire connection cross section AWG	AWG 30/1, 30/7
Outer diameter of insulation	0.55...0.75 mm
Side termination, characteristic	Clip-on flange
Type of insulation material	LCP
Colour	black
Contact base material	Copper alloy
Note	Other variants on request.

Layer structure of plug contact	≥ 2 µm Ni / ≥ 0.4 µm PdNi / ≥ 0.05 µm Au
Operating temperature	-55...125 °C
Clearance, min.	0.4 mm
Rated current, min. number of poles (T _u =20°C)	1.9 A
Volume resistance	<25 mΩ
Insulation strength	≥ 10 ¹⁰ Ω
Plugging cycles	500
Plugging force/pole	0.40...0.6 N
Approvals	CURUS



H



Ordering data

Type	Pol.	Qty.	Order No.
FFP D1/12H S1 B TY	12	100	2747520000
FFP D1/16H S1 B TY	16	120	2747530000
FFP D1/20H S1 B TY	20	105	2747540000
FFP D1/26H S1 B TY	26	120	2747550000
FFP D1/32H S1 B RL	32	100	2747560000
FFP D1/40H S1 B TY	40	100	2747570000
FFP D1/50H S1 B TY	50	75	2747580000
FFP D1/68H S1 B TY	68	75	2747590000
FFP D1/80H S1 B TY	80	50	2747600000

1.27

90°

Drawing dimensions

Type	No. of poles	A	B	C	D	E	Order no.
FFP D1/12H S1 B TY	12	6.35	15.4	9.37	8.37	15	2747520000
FFP D1/16H S1 B TY	16	8.89	17.94	11.91	10.91	15	2747530000
FFP D1/20H S1 B TY	20	11.43	20.48	14.45	13.45	15	2747540000
FFP D1/26H S1 B TY	26	15.24	24.29	18.26	17.26	15	2747550000
FFP D1/32H S1 B TY	32	19.05	28.1	22.07	21.07	15	2747560000
FFP D1/40H S1 B TY	40	24.13	33.18	27.15	26.15	15	2747570000
FFP D1/50H S1 B TY	50	30.48	39.53	33.5	32.5	15	2747580000
FFP D1/68H S1 B TY	68	41.91	50.96	44.93	43.93	16.2	2747590000
FFP D1/80H S1 B TY	80	49.53	58.58	55.88	51.55	16.2	2747600000

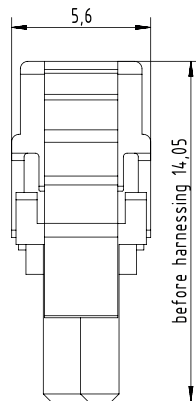
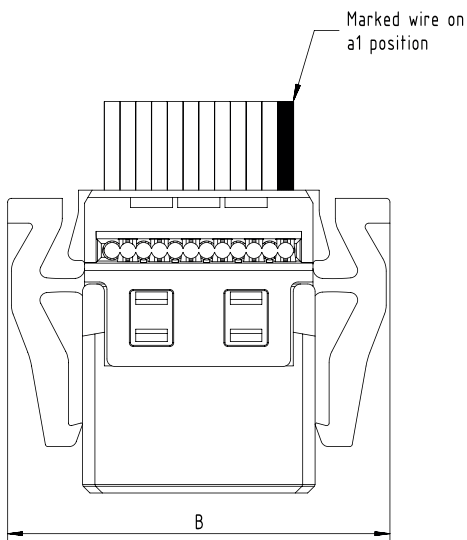
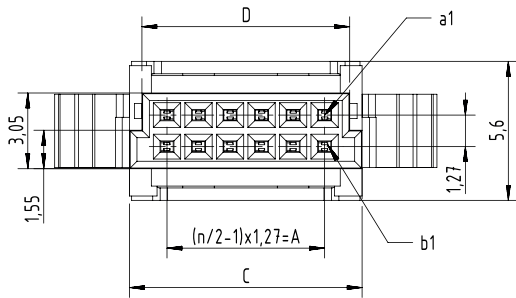

PVC FLAT CABLE : AWG 30/1 (solid)
AWG 30/7 (stranded)
PTFE FLAT CABLE : AWG 30/1 (solid)
 $\varnothing 0,55$ min. - $\varnothing 0,75$ max.

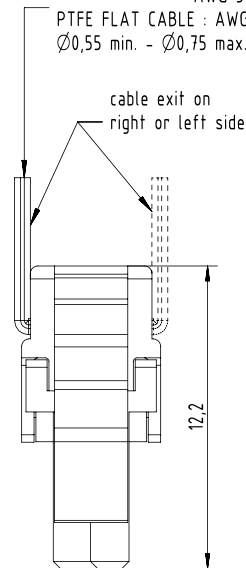

n= number of poles

Connectors in 1.27 mm pitch
Series FC assembled cables – Board-to-Board

FC.. PN/..A.. (PVC, 1:1 wiring)

For additional articles and information, refer to catalog.weidmueller.com



Technical data

Conductor outlet direction	90°/270°
Pitch	1.27 mm
Type of connection	Insulation displacement connection (IDC)
Wire connection cross section AWG	AWG 30/7
Type of insulation material	LCP
Colour	grey
Contact base material	Copper alloy
Layer structure of plug contact	≥ 2 µm Ni / ≥ 0.4 µm PdNi / ≥ 0.05 µm Au

Operating temperature	-20...105 °C
Clearance, min.	0.4 mm
Rated current, min. number of poles (Tu=20°C)	1.9 A
Volume resistance	<25 mΩ
Insulation strength	≥ 20 MΩ
Plugging cycles	500
Plugging force/pole	0.40...0.6 N

Note Further versions on request.
 Ribbon cable pitch 0.635 mm.

FC..../26A S1 B BX

1:1 wiring, 26 pole, different lengths and cable types

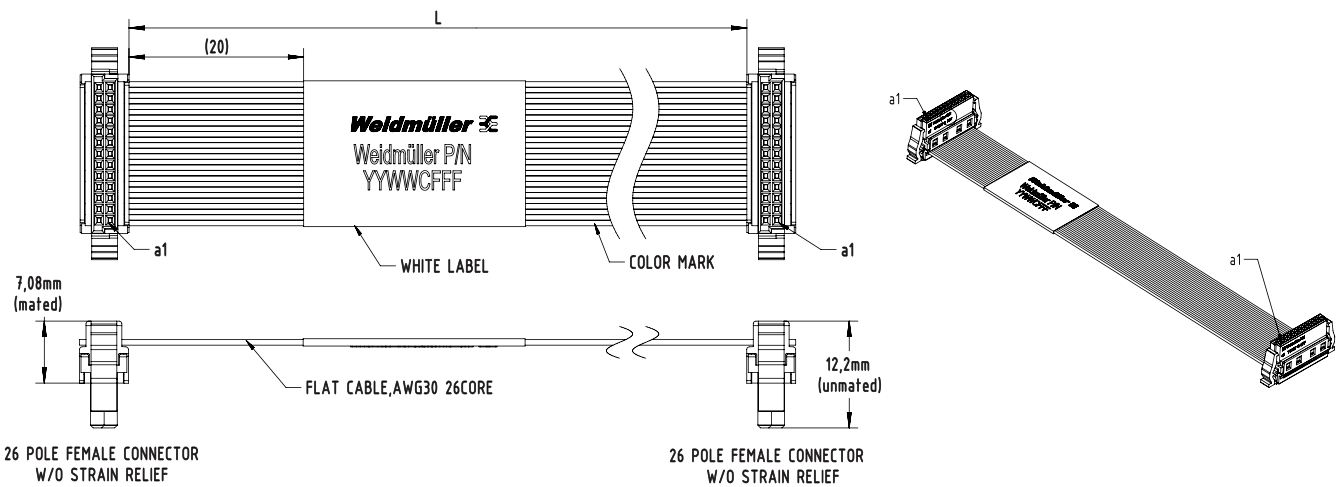

H



Ordering data

Type	Pol.	Cable length	Insulation	Qty.	Order No.
FC10 PN/12A S1 B BX	12	100 mm	PVC	10	2826880000
FC10 PN/16A S1 B BX	16	100 mm	PVC	10	2826940000
FC10 PN/20A S1 B BX	20	100 mm	PVC	10	2827000000
FC10 PN/26A S1 B BX	26	100 mm	PVC	10	2827060000
FC10 PN/32A S1 B BX	32	100 mm	PVC	10	2827120000
FC10 PN/40A S1 B BX	40	100 mm	PVC	10	2827180000
FC10 PN/50A S1 B BX	50	100 mm	PVC	10	2827240000
FC10 PN/68A S1 B BX	68	100 mm	PVC	10	2827300000
FC10 PN/80A S1 B BX	80	100 mm	PVC	10	2827360000
FC20 PN/12A S1 B BX	12	200 mm	PVC	10	2826890000
FC20 PN/16A S1 B BX	16	200 mm	PVC	10	2826950000
FC20 PN/20A S1 B BX	20	200 mm	PVC	10	2827010000
FC20 PN/26A S1 B BX	26	200 mm	PVC	10	2827070000
FC20 PN/32A S1 B BX	32	200 mm	PVC	10	2827130000
FC20 PN/40A S1 B BX	40	200 mm	PVC	10	2827190000
FC20 PN/50A S1 B BX	50	200 mm	PVC	10	2827250000
FC20 PN/68A S1 B BX	68	200 mm	PVC	10	2827310000
FC20 PN/80A S1 B BX	80	200 mm	PVC	10	2827370000
FC50 PN/12A S1 B BX	12	500 mm	PVC	10	2826900000
FC50 PN/16A S1 B BX	16	500 mm	PVC	10	2826960000
FC50 PN/20A S1 B BX	20	500 mm	PVC	10	2827020000
FC50 PN/26A S1 B BX	26	500 mm	PVC	10	2827080000
FC50 PN/32A S1 B BX	32	500 mm	PVC	10	2827140000
FC50 PN/40A S1 B BX	40	500 mm	PVC	10	2827200000
FC50 PN/50A S1 B BX	50	500 mm	PVC	10	2827260000
FC50 PN/68A S1 B BX	68	500 mm	PVC	10	2827320000
FC50 PN/80A S1 B BX	80	500 mm	PVC	10	2827380000

Connectors in 1.27 mm pitch
Series FC assembled cables – Board-to-Board

FC.. TN/..A.. (TPE, 1:1 wiring)

For additional articles and information, refer to catalog.weidmuller.com



Technical data

Conductor outlet direction	90°/270°
Pitch	1.27 mm
Type of connection	Insulation displacement connection (IDC)
Wire connection cross section AWG	AWG 30/7
Type of insulation material	LCP
Colour	grey
Contact base material	Copper alloy
Layer structure of plug contact	≥ 2 µm Ni / ≥ 0.4 µm PdNi / ≥ 0.05 µm Au

Operating temperature	-40...125 °C
Clearance, min.	0.4 mm
Rated current, min. number of poles (Tu=20°C)	1.9 A
Volume resistance	<25 mΩ
Insulation strength	≥ 20 MΩ
Plugging cycles	500
Plugging force/pole	0.40...0.6 N

Note Further versions on request.
 Ribbon cable pitch 0.635 mm.

FC..../26A S1 B BX

1:1 wiring, 26 pole, different lengths and cable types

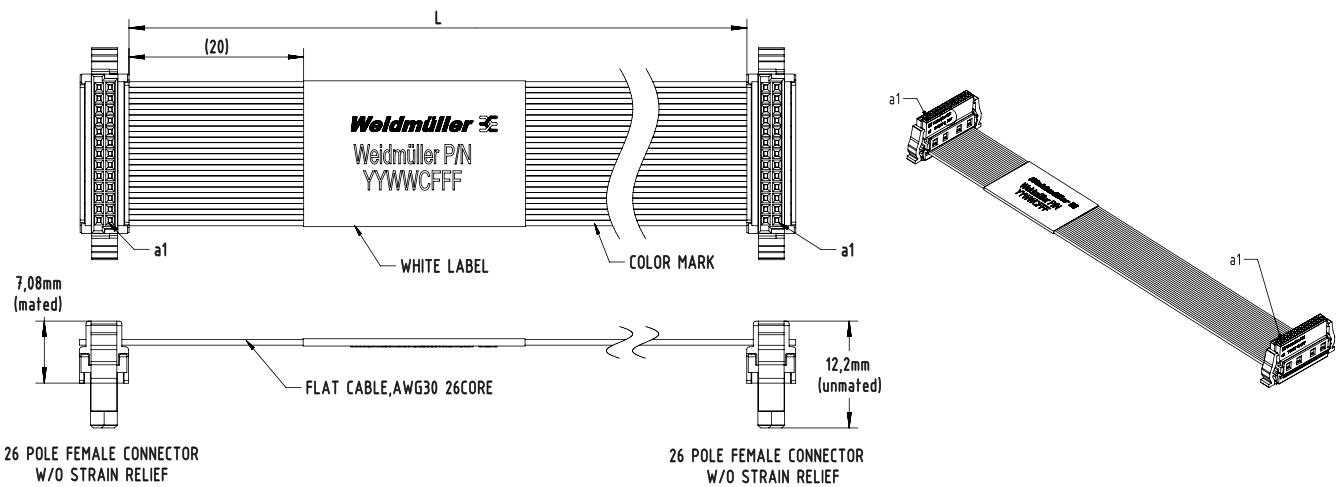

H



Ordering data

Type	Pol.	Cable length	Insulation	Qty.	Order No.
FC10 TN/12A S1 B BX	12	100 mm	TPE	10	2826910000
FC10 TN/16A S1 B BX	16	100 mm	TPE	10	2826970000
FC10 TN/20A S1 B BX	20	100 mm	TPE	10	2827030000
FC10 TN/26A S1 B BX	26	100 mm	TPE	10	2827090000
FC10 TN/32A S1 B BX	32	100 mm	TPE	10	2827150000
FC10 TN/40A S1 B BX	40	100 mm	TPE	10	2827210000
FC10 TN/50A S1 B BX	50	100 mm	TPE	10	2827270000
FC10 TN/68A S1 B BX	68	100 mm	TPE	10	2827330000
FC10 TN/80A S1 B BX	80	100 mm	TPE	10	2827390000
FC20 TN/12A S1 B BX	12	200 mm	TPE	10	2826920000
FC20 TN/16A S1 B BX	16	200 mm	TPE	10	2826980000
FC20 TN/20A S1 B BX	20	200 mm	TPE	10	2827040000
FC20 TN/26A S1 B BX	26	200 mm	TPE	10	2827100000
FC20 TN/32A S1 B BX	32	200 mm	TPE	10	2827160000
FC20 TN/40A S1 B BX	40	200 mm	TPE	10	2827220000
FC20 TN/50A S1 B BX	50	200 mm	TPE	10	2827280000
FC20 TN/68A S1 B BX	68	200 mm	TPE	10	2827340000
FC20 TN/80A S1 B BX	80	200 mm	TPE	10	2827400000
FC50 TN/12A S1 B BX	12	500 mm	TPE	10	2826930000
FC50 TN/16A S1 B BX	16	500 mm	TPE	10	2826990000
FC50 TN/20A S1 B BX	20	500 mm	TPE	10	2827050000
FC50 TN/26A S1 B BX	26	500 mm	TPE	10	2827110000
FC50 TN/32A S1 B BX	32	500 mm	TPE	10	2827170000
FC50 TN/40A S1 B BX	40	500 mm	TPE	10	2827230000
FC50 TN/50A S1 B BX	50	500 mm	TPE	10	2827290000
FC50 TN/68A S1 B BX	68	500 mm	TPE	10	2827350000
FC50 TN/80A S1 B BX	80	500 mm	TPE	10	2827410000

OMNIMATE® Signal PCB connectors in 2.50 mm pitch

OMNIMATE® Signal
PCB connectors in 2.50 mm pitch

PCB connectors in 2.50 mm pitch
Serie BLF 2.50/SL 2.50

Explanation	1.2
Quick selection	1.4
Product selection	1.6

Use compact, functional connection solutions

BLF 2.5/SL 2.5 PUSH IN device connectors

Especially for controls, I/O systems and signal interfaces in drive technology, it is now a question of ensuring components are as compact as possible while offering excellent functionality and simple handling.

The new BLF 2.5 OMNIMATE® signal plug-in connector and the associated SL 2.5 male connectors combine these requirements. This is thanks to the space-saving design and the particularly quick PUSH IN connection system – optimised for wire cross-sections of up to 0.5 mm² and a pitch dimension of 2.5 mm.

The BLF 2.5 connector has an integrated pusher to make opening the contact point easier. There is also an additional test point for user-friendly service measurements on the device. The SL 2.5 male header has two available outlet directions in various device designs and ensures excellent accessibility to the connector even in confined spaces.



Pusher gives operational safety

The contact point can be opened easily and the conductor removed by pressing the "pusher". This allows particularly fast and uniform wiring.



Flexible application

The SL 2.5 male header has two available outlet directions and can be used in many device designs. This means good connector availability can be guaranteed, even in confined spaces.



Optimum handling with minimum space requirements

All in one: the BLF 2.5 means you can benefit from a compact, pluggable connection solution for devices which is also simple.



Quick and safe wiring with high connection density: the PCB connectors in a 2.5 mm pitch enable space-saving signal interfaces for a variety of devices, for example, industrial controls.

PUSH IN connector up to 0.5 mm²

Wires with wire-end ferrules and single-stranded wires can be inserted directly thanks to the PUSH IN connection technology which saves time and ensures reliable contacting.

High component density

The compact design with PUSH IN connections and very small 2.5 mm pitch size is perfectly suited for wire cross-sections of up to 0.5 mm².



<http://www.OMNIMATE.net>

- = Wire-to-Board
- = Board-to-Board
- = Wire-to-Wire
- = Board-to-Wire

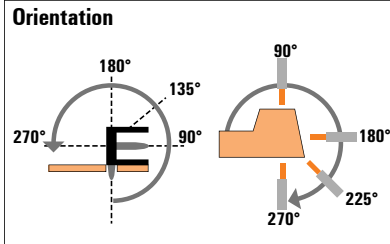
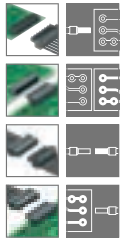

Serie BLF/2.50/SL 2.50

Levels

Type	Orientation	
	Flange options	
	IEC / UL	

Female plug

**Spring
PUSH IN**



BLF	180°	(G)	IEC: 320 V / 6 A / 0.08 - 0.5 mm ² UL: 150 V / 5 A / AWG 28 - 20
------------	------	-----	--

Female connector:

- (G)*** = Closed (without flange)
- F** = Screw flange with screw
- LH** = Release lever
- LR** = Lock & Release lever

Male header:

- G** = Closed (without flange)
- F** = Screw flange with nut
- LF** = Solder flange with nut

* not included in the article description

Male header



Solder connection



1

SL	SL
90°	180°
G	G
IEC: 320 V/6 A UL: 150 V/5 A	IEC: 320 V/6 A UL: 150 V/5 A
○	○



Connectors in 2.50 mm pitch BLF 2.50 / SL 2.50

SL 2.50/./90G and 180G

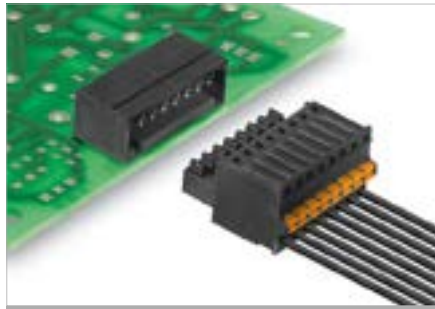

Male header for wave soldering in 2.50mm pitch.

- Plugging direction is parallel (90°) or straight 180° to the PCB
- Housing variant: Closed (G)
- Packaged in a cardboard box (BX)

Technical data

In compliance with IEC 60664-1 / IEC 61984

Clamping range, max.			
Solid core H05(07) V-U			
Stranded H07 V-R			
Flexible H05(07) V-K			
Flexible with ferrule			
Ferrule with plastic collar			
Stripping length			
Screwdriver blade	mm		
According to norm			
Tightening torque range			
Rated current, max.	6	6	
At ambient temperature	20°C	40°C	
For conductor cross-section			
Overtoltage category	III	III	II
Pollution severity	3	2	2
Rated voltage	V	80	320 320
Rated impulse voltage	kV	2.5	2.5 2.5
UL / CUL (Use Group)		B	C D
Rated voltage	V	150	
Rated current	A	5	
AWG conductor	AWG	-	
CSA (Use Group)		B	C D
Rated voltage	V	150	
Rated current	A	5	
AWG conductor	AWG	-	
General data			
Type of insulation material	PA 66		
UL 94 flammability rating	V-0		
Contact base material	Copper alloy		
Material of contact surface	tinned		
Pin dimensions = d	mm	0.8 x 0.8	
Solder eyelet Ø = D	mm	1.3	
Solder eyelet Ø tolerance	mm	+ 0,1	

Product data

IEC: 320 V / 6 A
UL: 150 V / 5 A



For additional articles and information, refer to catalog.weidmuller.com

Note:

- Rated current related to rated cross-section & min. No. of poles.
- P on drawing = pitch
- Rated data refer only to the component itself. Clearance and creepage distances to other components are to be designed in accordance with the relevant application standards.

SL 2.50/./90G Box

closed side



Dimensioned drawing

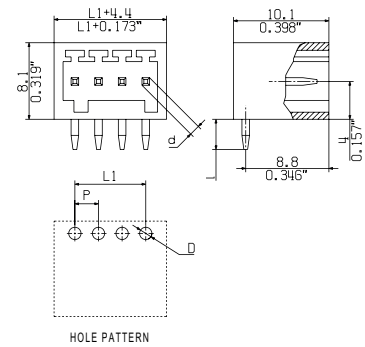

Accessories

Note: Refer to the Accessories chapter for additional accessories.

Ordering data

Solder pin length		3.2 mm		
Colour		black		
Pitch		2.50 mm		
Pol.	L1	(inch)	Qty.	Order No.
2	2.50	0.984	250	2439660000
3	5.00	1.968	250	2439760000
4	7.50	2.952	250	2439770000
5	10.00	3.936	200	2439780000
6	12.50	4.920	175	2439790000
7	15.00	5.904	125	2439800000
8	17.50	6.888	125	2439810000
9	20.00	7.872	125	2439820000
10	22.50	8.856	100	2439830000
11	25.00	9.840	100	2439840000
12	27.50	10.824	75	2439850000

2.50

90°

SL 2.50/..../180G Box

closed side



Dimensioned drawing

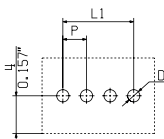
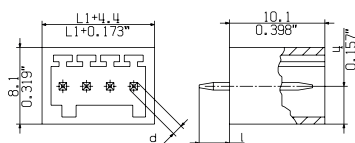

Ordering data

Solder pin length		3.2 mm		
Colour		black		
Pitch		2.50 mm		
Pol.	L1	(inch)	Qty.	Order No.
2	2.50	0.984	250	2439910000
3	5.00	1.968	250	2439920000
4	7.50	2.952	250	2439930000
5	10.00	3.936	200	2439940000
6	12.50	4.920	175	2439950000
7	15.00	5.904	125	2439960000
8	17.50	6.888	125	2439970000
9	20.00	7.872	125	2439980000
10	22.50	8.856	100	2439990000
11	25.00	9.840	100	2440000000
12	27.50	10.824	75	2440010000



Connectors in 2.50 mm pitch BLF 2.50 / SL 2.50

BLF 2.50/./180



PUSH IN - Weidmüller's innovative connection system simplifies the wire connection process.

The benefits for users and applications:

- High component density because of small pitch.
Simply insert the prepared wire - and you're done
- Simplified processing, featuring integrated push buttons for opening the wire-terminal point
- Intuitive handling - since the wire-entry area and handling area are clearly separated

Technical data

In compliance with IEC 60664-1 / IEC 61984			
Clamping range, max.	mm ²	0.08...0.5	
Solid core H05(07) V-U	mm ²	0.08...0.5	
Stranded H07 V-R		...0.5	
Flexible H05(07) V-K	mm ²	0.08...0.5	
Flexible with ferrule	mm ²	0.25...0.34	
Ferrule with plastic collar			
Stripping length	mm	8	
Screwdriver blade	mm		
According to norm		DIN 5264	
Tightening torque range			
Rated current, max.	A	6	6
At ambient temperature		20°C	40°C
For conductor cross-section			
Overtoltage category		III	III II
Pollution severity		3	2 2
Rated voltage	V	80	320 320
Rated impulse voltage	kV	2.5	2.5 2.5
UL / CUL (Use Group)		B	C D
Rated voltage	V	150	
Rated current	A	5	
AWG conductor	AWG	28-20	
CSA (Use Group)		B	C D
Rated voltage	V	150	
Rated current	A	5	
AWG conductor	AWG	28-20	
General data			
Type of insulation material		PA	
UL 94 flammability rating		V-0	
Contact base material		Copper alloy	
Material of contact surface		tinned	
Pin dimensions = d	mm		
Solder eyelet Ø = D			
Solder eyelet Ø tolerance	mm		

Product data

IEC: 320 V / 6 A / 0.08 - 0.5 mm²
UL: 150 V / 5 A / AWG 28 - 20



For additional articles and information, refer to catalog.weidmueller.com

Note:

- Rated current related to rated cross-section & min. No. of poles.
- P on drawing = pitch
- Crimp shape A for wire-end ferrules with crimping tools PZ 1,5 (order no. 9005990000) or PZ 6/5 (order no. 9011460000) for larger wire cross-sections recommended.
- Rated data refer only to the component itself. Clearance and creepage distances to other components are to be designed in accordance with the relevant application standards.

BLF 2.50/./180



Dimensioned drawing

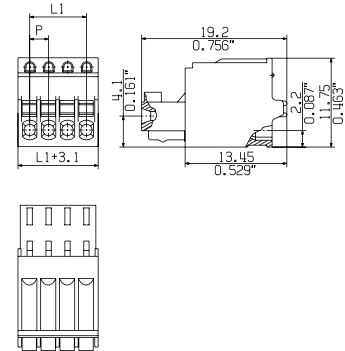

Accessories

Note: Refer to the Accessories chapter for additional accessories.

Ordering data

Solder pin length				
Colour				black
Pitch	2.50 mm		Qty.	Order No.
Pol.	L1	(inch)		
2	2.50	0.984	250	2438860000
3	5.00	1.968	250	2439650000
4	7.50	2.952	250	2439670000
5	10.00	3.936	200	2439680000
6	12.50	4.920	175	2439690000
7	15.00	5.904	125	2439700000
8	17.50	6.888	125	2439710000
9	20.00	7.872	125	2439720000
10	22.50	8.856	100	2439730000
11	25.00	9.840	100	2439740000
12	27.50	10.824	75	2439750000

2.50

180°

0.5 mm²

OMNIMATE® Signal PCB connectors in 3.50 mm pitch

OMNIMATE® Signal PCB connectors in 3.50 mm pitch

Double-row connectors in 3.50 mm pitch
Series B2C/S2C 3.50

Explanation	J.2
Quick selection	J.4
Product selection	J.6

Connectors in 3.50 mm pitch
Series BL/SL 3.50

Explanation	J.20
Quick selection	J.28
Product selection	J.30

Powerful compact connector with PUSH IN wire connection

OMNIMATE® Signal – simple and safe connection for wires up to 1.5 mm²



When designing customised device connectivity products for modern applications, it is becoming increasingly important to find the perfect fit between device miniaturisation and increased device functionality. Our new double-row OMNIMATE® B2CF Signal connector, in 3.5 mm pitch, has this perfect fit and enables a new generation of more compact installations.

This connector is easy to work with, despite the increased functionality being packed into a compact space. The PUSH IN direct-insert wire connection mechanism allows you to conveniently connect the signal wires. There are more useful features: the tool-free locking and unlocking, the touch-safe male header, and the outstanding clarity provided by easy-to-read markers that identify each terminal point.

Packing Density 2.0

Smaller devices with increased technical capabilities are being designed for more applications. They take advantage of more contacts packed onto a small surface and a large wire cross-section capacity.

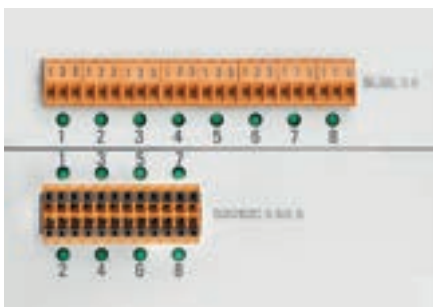

Large wire cross-sections

You can easily connect wires with cross-sections up to 1.5 mm² (when using wire-end ferrules) and up to 1.0 mm² (when using ferrules and plastic collars).

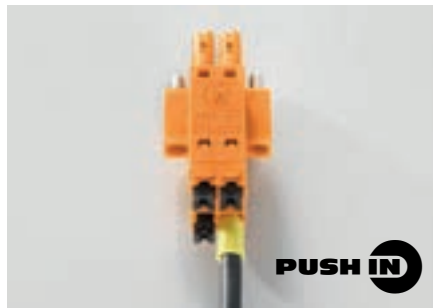

Direct insertion

PUSH IN: the quick, tool-free, intuitive connection mechanism for prepared wires. www.push-in.com

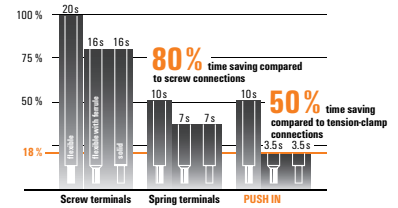

Halogen-free and IEC 60335

Halogen-free materials ensure future compatibility and extended approvals enhance the range of use for new device designs.

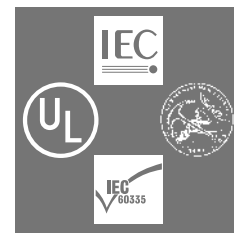

Convincing system accessories

Our matching accessories – including markers, light guides, strain relief and coding – improve operational safety and enable a professional design.



Convincing safety during use

This connector system is safe to use, with attractive features such as quick wire connections, tool-free locking and unlocking, and touch-safe design.

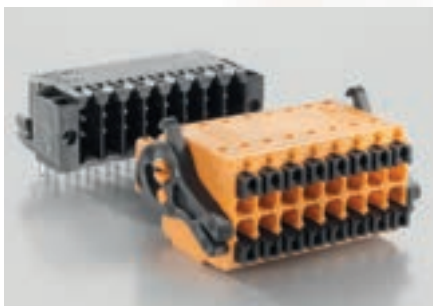





Solid PUSH IN contacts

A safe, permanent connection is ensured by the optimised spring steel and specially-shaped contact element.



<http://www.OMNIMATE.net>



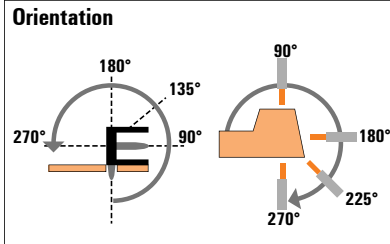
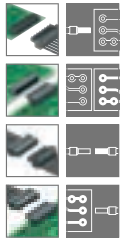

-  = Wire-to-Board
-  = Board-to-Board
-  = Wire-to-Wire
-  = Board-to-Wire



B2C/S2C 3.50 series



Type	Levels	
	Orientation	Flange options
	IEC / UL	

Female plug	 <p>Spring PUSH IN</p>		B2CF	180°	(G)/F/LR	IEC: 320 V/13.4 A/0.14 - 1.5 mm ² UL: 300 V/10 A/AWG 26 - 16
	 <p>Tension clamp (with internal cross connection)</p>		B2L QV	180°	(G)/F/LH	IEC: 200 V/10.6 A/0.2 - 1 mm ² UL: 150 V/7 A/AWG 28 - 18

Female connector:
(G)* = Closed (without flange)
F = Screw flange with screw
LH = Release lever
LR = Lock & Release lever

Male header:
G = Closed (without flange)
F = Screw flange with nut
LF = Solder flange with nut

* not included in the article description

Male header



Reflow solder connection



Solder connection



1		2		1	
S2C-SMT	S2C-SMT	S2CD-THR	S2L	S2L	
90°	180°	90°	90°	180°	
G/LF	G/LF	G/LF	G/F	G/F	
IEC: 200 V/13.4 A UL: 150 V/10 A	IEC: 200 V/13.4 A UL: 150 V/10 A	IEC: 200 V/7.9 A UL: 150 V/7 A	IEC: 250 V/10 A UL: 150 V/10 A	IEC: 250 V/10 A UL: 150 V/10 A	
○	○	○	○	○	
			○	○	



Double-row connectors in 3.50 mm pitch Series B2C/S2C 3.50

B2CF/S2C and B2L/S2C 3.50 series



High-temperature-resistant, double-row male header

- Finger-safe
- Plugging direction parallel to PCB (recumbent / 90°)
- Housing variants: closed (G) and with solder flange (LF)
- Packed either in a box (BX) or tape-on-reel (RL)
- Suitable for reflow and wave soldering applications
- Pin length of either 1.5 mm or 3.2 mm
- Can be plugged into female plug B2CF 3.50/./180..

Product data

IEC: 200 V / 13.4 A
UL: 150 V / 10 A



For additional articles and information, refer to catalog.weidmueller.com

Note:

- Gold-plated contact surfaces on request
- Rated current related to rated cross-section & min. No. of poles.
- Spacing between rows: see hole layout
- P on drawing = pitch
- Rated data refer only to the component itself. Clearance and creepage distances to other components are to be designed in accordance with the relevant application standards.
- Long term storage of the product with average temperature of 50 °C and average humidity 70%, 36 months

S2C-SMT 3.50/./90G Box

closed side



Dimensioned drawing

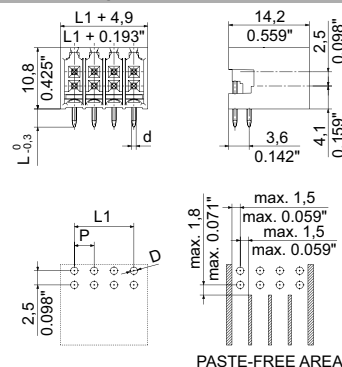

Technical data

In compliance with IEC 60664-1 / IEC 61984

Clamping range, max.			
Solid core H05(07) V-U			
Stranded H07 V-R			
Flexible H05(07) V-K			
Flexible with ferrule			
Ferrule with plastic collar			
Stripping length			
Screwdriver blade	mm		
According to norm			
Tightening torque range			
Rated current, max.		13.4	12
At ambient temperature		20°C	40°C
For conductor cross-section			
Overtoltage category		III	III II
Pollution severity		3	2 2
Rated voltage	V	80	160 200
Rated impulse voltage	kV	2.5	2.5 2.5
UL / CUL (Use Group)		B	C D
Rated voltage	V	150	50
Rated current	A	10	10
AWG conductor	AWG		-
CSA (Use Group)		B	C D
Rated voltage	V	150	50 150
Rated current	A	9.5	9.5 9.5
AWG conductor	AWG		-
General data			
Type of insulation material		LCP GF	
UL 94 flammability rating		V-0	
Contact base material		Copper alloy	
Material of contact surface		tinned	
Pin dimensions = d	mm	1.0, Octagonal	
Solder eyelet Ø = D	mm	1.3	
Solder eyelet Ø tolerance	mm	+ 0,1	

Accessories

Note: Refer to the Accessories chapter for additional accessories.

Coding	Order No.
B2L/S2L 3.50 KO OR BX	1849730000
B2L/S2L 3.50 KO BK BX	1849740000
LED light guide	
S2L/S2C 3.5 FLA 20/10 SMD	1814590000

Ordering data

Solder pin length		3.2 mm		
Colour		black		
Pitch		3.50 mm		
Pol.	L1	(inch)	Qty.	Order No.
4	3.50	0.138	216	1288980000
6	7.00	0.276	156	1289270000
8	10.50	0.413	120	1289280000
10	14.00	0.551	96	1289290000
12	17.50	0.689	78	1289300000
14	21.00	0.827	66	1289310000
16	24.50	0.965	60	1289320000
18	28.00	1.102	54	1289330000
20	31.50	1.240	48	1289340000
22	35.00	1.378	42	1289350000
24	38.50	1.516	42	1289370000



S2C-SMT 3.50/./90G Tape

closed side; tape-on-reel



Dimensioned drawing

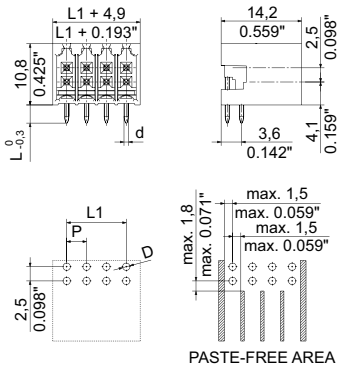

Ordering data

Solder pin length		1.5 mm	
Colour		black	
Pitch		3.50 mm	
Pol.	L1 (inch)	Qty.	Order No.
4	3.50	0.138	235 1359580000
6	7.00	0.276	235 1359590000
8	10.50	0.413	235 1359600000
10	14.00	0.551	235 1359610000
12	17.50	0.689	235 1359620000
14	21.00	0.827	235 1359630000
16	24.50	0.965	235 1359640000
18	28.00	1.102	235 1359650000
20	31.50	1.240	235 1359670000
22	35.00	1.378	235 1359680000
24	38.50	1.516	235 1359690000

Tape widths: 32, 44, 56, 72, 88

S2C-SMT 3.50/./90LF Box

with solder flange



Dimensioned drawing

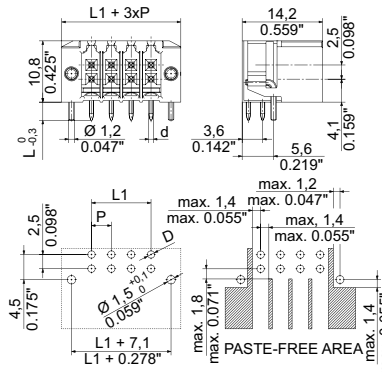

Ordering data

Solder pin length		3.2 mm	
Colour		black	
Pitch		3.50 mm	
Pol.	L1 (inch)	Qty.	Order No.
4	3.50	0.138	132 1289450000
6	7.00	0.276	102 1289460000
8	10.50	0.413	84 1289470000
10	14.00	0.551	72 1289480000
12	17.50	0.689	66 1289490000
14	21.00	0.827	54 1289500000
16	24.50	0.965	48 1289510000
18	28.00	1.102	48 1289520000
20	31.50	1.240	42 1289530000
22	35.00	1.378	36 1289540000
24	38.50	1.516	36 1289550000

S2C-SMT 3.50/./90LF Tape

with solder flange; tape-on-reel



Dimensioned drawing

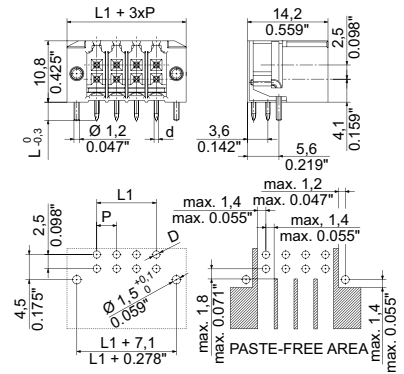

Ordering data

Solder pin length		1.5 mm	
Colour		black	
Pitch		3.50 mm	
Pol.	L1 (inch)	Qty.	Order No.
4	3.50	0.138	235 1359080000
6	7.00	0.276	235 1359090000
8	10.50	0.413	235 1359100000
10	14.00	0.551	235 1359120000
12	17.50	0.689	235 1359130000
14	21.00	0.827	235 1359140000
16	24.50	0.965	235 1359150000
18	28.00	1.102	235 1359160000
20	31.50	1.240	235 1359170000

Tape widths: 32, 44, 56, 72, 88

Double-row connectors in 3.50 mm pitch Series B2C/S2C 3.50

S2C-SMT 3.50/./180

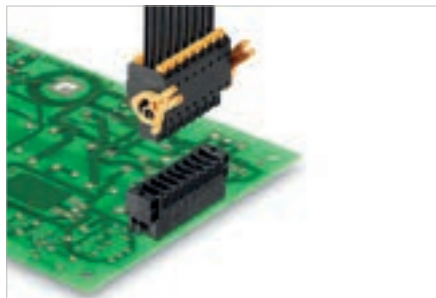

High-temperature-resistant, double-row male header

- Finger-safe
- Plugging direction vertical to PCB (standing / 180°)
- Housing variants: closed (G) and with solder flange (LF)
- Packed either in a box (BX) or tape-on-reel (RL)
- Suitable for reflow and wave soldering applications
- Pin length of either 1.5 mm or 3.2 mm
- Pluggable to female connector B2CF 3.50/./180..

Technical data

In compliance with IEC 60664-1 / IEC 61984			
Clamping range, max.			
Solid core H05(07) V-U			
Stranded H07 V-R			
Flexible H05(07) V-K			
Flexible with ferrule			
Ferrule with plastic collar			
Stripping length			
Screwdriver blade	mm		
According to norm			
Tightening torque range			
Rated current, max.		13.4	12
At ambient temperature		20°C	40°C
For conductor cross-section			
Overvoltage category		III	III II
Pollution severity		3	2 2
Rated voltage	V	80	160 200
Rated impulse voltage	kV	2.5	2.5 2.5
UL / CUL (Use Group)		B	C D
Rated voltage	V	150	50
Rated current	A	10	10
AWG conductor	AWG		-
CSA (Use Group)		B	C D
Rated voltage	V	150	50 150
Rated current	A	9.5	9.5 9.5
AWG conductor	AWG		-
General data			
Type of insulation material		LCP GF	
UL 94 flammability rating		V-0	
Contact base material		Copper alloy	
Material of contact surface		tinned	
Pin dimensions = d	mm	1.0, Octagonal	
Solder eyelet Ø = D	mm	1.3	
Solder eyelet Ø tolerance	mm	+ 0,1	

Product data

IEC: 200 V / 13.4 A
UL: 150 V / 10 A



For additional articles and information, refer to catalog.weidmuller.com

Note:

- Gold-plated contact surfaces on request
- Rated current related to rated cross-section & min. No. of poles.
- Spacing between rows: see hole layout
- P on drawing = pitch
- Rated data refer only to the component itself. Clearance and creepage distances to other components are to be designed in accordance with the relevant application standards.
- Long term storage of the product with average temperature of 50 °C and average humidity 70%, 36 months

S2C-SMT 3.50/./180G Box

closed side



Dimensioned drawing

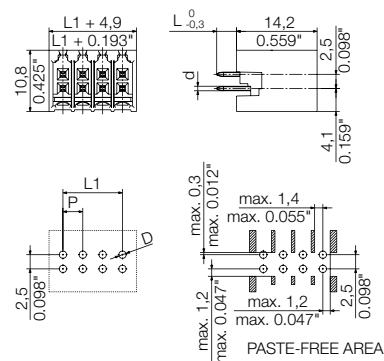

Accessories

Note: Refer to the Accessories chapter for additional accessories.

Coding	Order No.
B2L/S2L 3.50 KO OR BX	1849730000
B2L/S2L 3.50 KO BK BX	1849740000

Ordering data

Solder pin length		3.5 mm		
Colour		black		
Pitch		3.50 mm		
Pol.	L1	(inch)	Qty.	Order No.
4	3.50	0.138	216	1290030000
6	7.00	0.276	156	1290040000
8	10.50	0.413	120	1290050000
10	14.00	0.551	96	1290060000
12	17.50	0.689	78	1290070000
14	21.00	0.827	66	1290080000
16	24.50	0.965	60	1290090000
18	28.00	1.102	54	1290110000
20	31.50	1.240	48	1290120000
22	35.00	1.378	42	1290130000
24	38.50	1.516	42	1290140000

S2C-SMT 3.50/./180G Tape

closed side; tape-on-reel



Dimensioned drawing

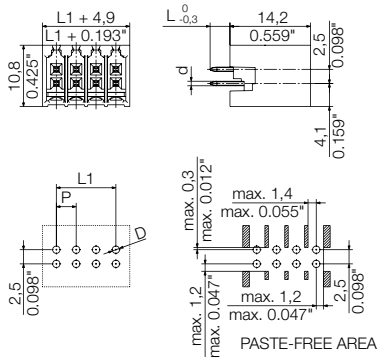

Ordering data

Solder pin length		1.5 mm	
Colour		black	
Pitch		3.50 mm	
Pol.	L1	(inch)	Qty. Order No.
4	3.50	0.138	175 1358860000
6	7.00	0.276	175 1358870000
8	10.50	0.413	175 1358880000
10	14.00	0.551	175 1358890000
12	17.50	0.689	175 1358900000
14	21.00	0.827	175 1358910000
16	24.50	0.965	175 1358920000
18	28.00	1.102	175 1358930000
20	31.50	1.240	175 1359000000
22	35.00	1.378	175 1359010000
24	38.50	1.516	150 1359060000

S2C-SMT 3.50/./180LF Box

with solder flange



Dimensioned drawing

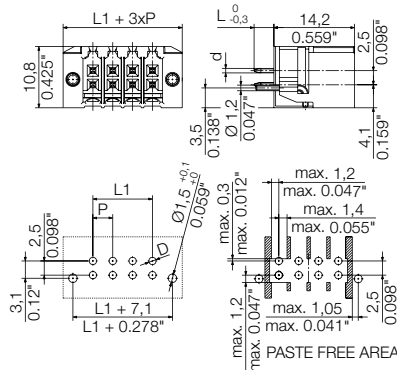

Ordering data

Solder pin length		3.5 mm	
Colour		black	
Pitch		3.50 mm	
Pol.	L1	(inch)	Qty. Order No.
4	3.50	0.138	132 1290220000
6	7.00	0.276	102 1290230000
8	10.50	0.413	84 1290240000
10	14.00	0.551	72 1290250000
12	17.50	0.689	66 1290260000
14	21.00	0.827	54 1290270000
16	24.50	0.965	48 1290280000
18	28.00	1.102	48 1290290000
20	31.50	1.240	42 1290310000
22	35.00	1.378	36 1290320000
24	38.50	1.516	36 1290330000

S2C-SMT 3.50/./180LF Tape

with solder flange; tape-on-reel



Dimensioned drawing

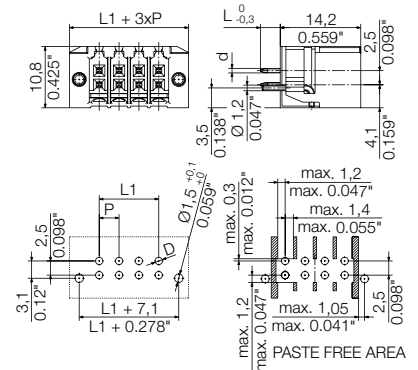

Ordering data

Solder pin length		1.5 mm	
Colour		black	
Pitch		3.50 mm	
Pol.	L1	(inch)	Qty. Order No.
4	3.50	0.138	175 1358630000
6	7.00	0.276	175 1358640000
8	10.50	0.413	175 1358650000
10	14.00	0.551	175 1358670000
12	17.50	0.689	175 1358680000
14	21.00	0.827	175 1358690000
16	24.50	0.965	175 1358700000
18	28.00	1.102	175 1358710000
20	31.50	1.240	150 1358720000

Tape widths: 32, 44, 56, 72, 88

Tape widths: 32, 44, 56, 72, 88

Double-row connectors in 3.50 mm pitch Series B2C/S2C 3.50

S2CD-THR 3.50/./90

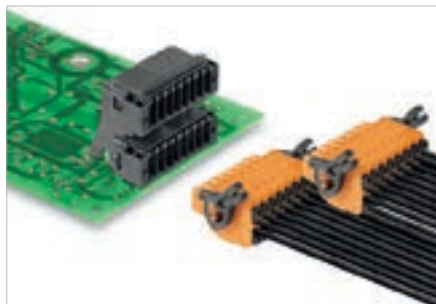

High contact density on a small surface: 75% space savings on the PCB. The only 4-row double-level male header for typical IP 20 sensor interfaces in 3.50 mm pitch.

- Finger-safe
- Plugging direction in parallel to circuit board (horizontal / 90°)
- Housing variants: closed (G) and with solder flange (LF)
- Packed in a cardboard box (BX)
- Suitable for reflow and wave soldering applications
- Pin length 3.2 mm
- Can be plugged into female plug B2CF 3.50/./180..

Product data

IEC: 200 V / 7.9 A
UL: 150 V / 9.5 A



For additional articles and information, refer to catalog.weidmueller.com

Note:

- Gold-plated contact surfaces on request
- Rated current related to rated cross-section & min. No. of poles.
- Spacing between rows: see hole layout
- P on drawing = pitch
- Rated data refer only to the component itself. Clearance and creepage distances to other components are to be designed in accordance with the relevant application standards.
- Long term storage of the product with average temperature of 50 °C and average humidity 70%, 36 months

S2CD-THR 3.50/./90G

closed side



Dimensioned drawing

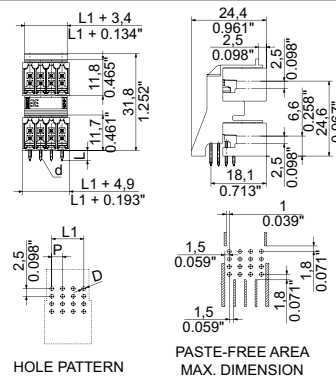

Technical data

In compliance with IEC 60664-1 / IEC 61984

Clamping range, max.			
Solid core H05(07) V-U			
Stranded H07 V-R			
Flexible H05(07) V-K			
Flexible with ferrule			
Ferrule with plastic collar			
Stripping length			
Screwdriver blade	mm		
According to norm			
Tightening torque range			
Rated current, max.	A	7.9	6.8
At ambient temperature		20°C	40°C
For conductor cross-section			
Overtoltage category		III	III
Pollution severity		3	2
Rated voltage	V	100	160
Rated impulse voltage	kV	1.5	2.5
UL / CUL (Use Group)	B	C	D
Rated voltage	V	150	50
Rated current	A	9.5	9.5
AWG conductor	AWG	-	
CSA (Use Group)	B	C	D
Rated voltage	V	50	50
Rated current	A	5	9.5
AWG conductor	AWG	-	
General data			
Type of insulation material	LCP GF		
UL 94 flammability rating	V-0		
Contact base material	Copper alloy		
Material of contact surface	tinned		
Pin dimensions = d	mm	1.0, Octagonal	
Solder eyelet Ø = D	mm	1.3	
Solder eyelet Ø tolerance	mm	+ 0,1	

Accessories

Note: Refer to the Accessories chapter for additional accessories.

Coding	Order No.
B2L/S2L 3.50 KO OR BX	1849730000
B2L/S2L 3.50 KO BK BX	1849740000

Ordering data

Solder pin length		3.2 mm	
Colour		black	
Pitch		3.50 mm	
Pol.	L1	(inch)	Qty.
8	10.50	0.413	50
12	17.50	0.689	50
16	24.50	0.965	20
20	31.50	1.240	20
24	38.50	1.516	20
28	45.50	1.791	20
32	52.50	2.067	20
36	59.50	2.343	20

1.5 mm solder pin length available on request

S2CD-THR 3.50/././90LF

with solder flange



Dimensioned drawing

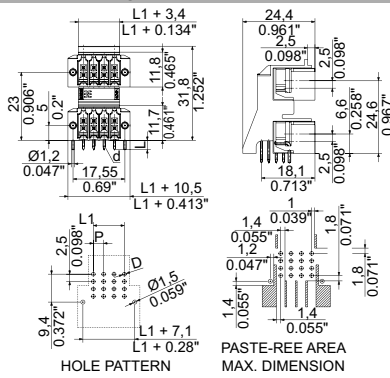

Ordering data

Solder pin length		3.2 mm		
Colour		black		
Pitch		3.50 mm		
Pol.	L1	(inch)	Qty.	Order No.
8	10.50	0.413	50	1357890000
12	17.50	0.689	50	1357900000
16	24.50	0.965	20	1357920000
20	31.50	1.240	20	1357930000
24	38.50	1.516	20	1357940000
28	45.50	1.791	20	1357950000
32	52.50	2.067	20	1357970000
36	59.50	2.343	20	1357990000

1.5 mm solder pin length available on request



Double-row connectors in 3.50 mm pitch Series B2C/S2C 3.50

B2CF 3.50/./180

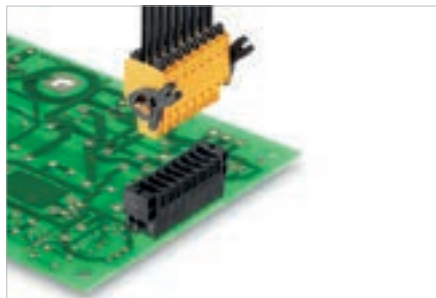

Two-row female plug with PUSH IN spring connection.

- Simply insert the prepared wires - finished
- Intuitive handling - since the wire-entry area and handling area are clearly separated.
- Integrated push-buttons for opening the terminal point
- High component density because of low heights
- Optional: the lock and release requires no tools when using Weidmüller's patented (LR) release latch
- Approval according to IEC 60335 and GL in preparation
- Also compatible with series: S2L 3.50, S2L-SMT 3.50 and S2LD-THR 3.50

Technical data

In compliance with IEC 60664-1 / IEC 61984

Clamping range, max.	mm ²	0.14...1.5
Solid core H05(07) V-U	mm²	0.14...1.5
Stranded H07 V-R		
Flexible H05(07) V-K	mm ²	0.14...1.5
Flexible with ferrule	mm ²	0.14...1.5
Ferrule with plastic collar	mm ²	0.14...1
Stripping length	mm	10
Screwdriver blade	mm	0.4 x 2.5
According to norm		DIN 5264

Tightening torque range			
Rated current, max.	A	13.4	12
At ambient temperature		20°C	40°C

For conductor cross-section	mm ²	1.5
Overvoltage category		III III II
Pollution severity		3 2 2

Rated voltage	V	160	160	320
Rated impulse voltage	kV	2.5	2.5	2.5

UL / CUL (Use Group)

Rated voltage	V	300	50	300
Rated current	A	9.5	9.5	9.5
AWG conductor	AWG	30-16		

CSA (Use Group)

Rated voltage	V	300	50	300
Rated current	A	9.5	9.5	9.5
AWG conductor	AWG	30-16		

General data

Type of insulation material		PA 66 GF 30
UL 94 flammability rating		V-0
Contact base material		Copper alloy
Material of contact surface		tinned
Pin dimensions = d	mm	
Solder eyelet Ø = D	mm	
Solder eyelet Ø tolerance	mm	

Product data

IEC: 320 V / 13.4 A / 0.14 - 1.5 mm²
UL: 300 V / 9.5 A / AWG 30 - 16



For additional articles and information, refer to catalog.weidmueller.com

Note:

- Additional variants on request
 - Gold-plated contact surfaces on request
 - Gold-plated contact surfaces on request
 - Crimp shape A for wire-end ferrules with crimping tools PZ 1,5 (order no. 9005990000) or PZ 6/5 (order no. 9011460000) for larger wire cross-sections recommended.
 - P on drawing = pitch
 - Rated data refer only to the component itself. Clearance and creepage distances to other components are to be designed in accordance with the relevant application standards.
 - Max. outer diameter of the conductor 2.6 mm
- Wire-end ferrule w/plastic collar DIN 46228/4 or Weidmüller colour code
- 1.00mm² [H1.0/18D] mtl. ferrule leng. 12mm, stripping leng. 15mm
 - 0.75mm² [H0.75/18D] mtl. ferrule leng. 12mm, stripping leng. 14mm
 - 0.50mm² [H0.5/16D] mtl. ferrule leng. 10mm, stripping leng. 12mm
 - 0.34mm² [H0.34/12] mtl. ferrule leng. 8mm, stripping leng. 10mm
 - 0.25mm² [H0.25/12] mtl. ferrule leng. 8mm, stripping leng. 10mm
 - 0.14mm² [H0.14/12] mtl. ferrule leng. 8mm, stripping leng. 10mm
- Wire-end ferrule w/o plastic collar acc. to DIN 46228/1
- 1.50mm² [H1.5/10] mtl. ferrule leng. 10mm, stripping leng. 10mm
 - Long term storage of the product with average temperature of 50 °C and average humidity 70%, 36 months

B2CF 3.50/./180



Dimensioned drawing

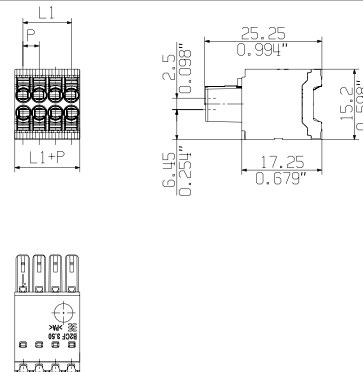

Ordering data

Solder pin length				
Colour	orange			
Pitch	3.50 mm			
Pol.	L1	(inch)	Qty.	Order No.
4	3.50	0.138	264	1277270000
6	7.00	0.276	174	1277280000
8	10.50	0.413	132	1277290000
10	14.00	0.551	102	1277310000
12	17.50	0.689	84	1277320000
14	21.00	0.827	72	1277330000
16	24.50	0.965	66	1277340000
18	28.00	1.102	54	1277350000
20	31.50	1.240	48	1277360000
22	35.00	1.378	48	1277370000
24	38.50	1.516	42	1277380000

Representative deratings curve

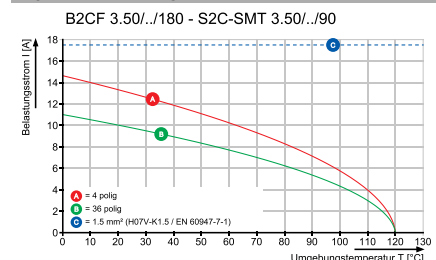

B2CF 3.50../180F

with screw flange



Dimensioned drawing

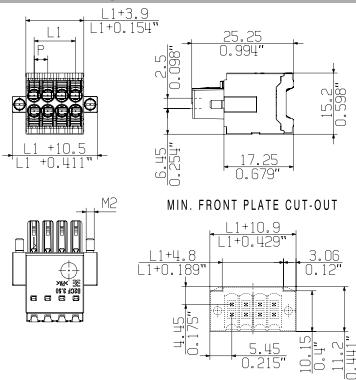

Ordering data

Solder pin length					
Colour		orange			
Pitch		3.50 mm			
Pol.	L1	(inch)	Qty.	Order No.	
4	3.50	0.138	120	1277650000	
6	7.00	0.276	102	1277670000	
8	10.50	0.413	84	1277680000	
10	14.00	0.551	72	1277690000	
12	17.50	0.689	66	1277720000	
14	21.00	0.827	54	1277730000	
16	24.50	0.965	48	1277740000	
18	28.00	1.102	48	1277750000	
20	31.50	1.240	42	1277760000	
22	35.00	1.378	36	1277770000	
24	38.50	1.516	36	1277780000	

B2CF 3.50../180LR

with release latch



Dimensioned drawing

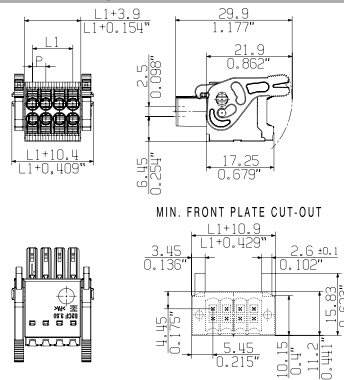

Ordering data

Solder pin length					
Colour		orange			
Pitch		3.50 mm			
Pol.	L1	(inch)	Qty.	Order No.	
4	3.50	0.138	138	1278040000	
6	7.00	0.276	108	1278050000	
8	10.50	0.413	90	1278060000	
10	14.00	0.551	78	1278070000	
12	17.50	0.689	66	1278080000	
14	21.00	0.827	60	1278090000	
16	24.50	0.965	54	1278100000	
18	28.00	1.102	48	1278110000	
20	31.50	1.240	42	1278120000	
22	35.00	1.378	42	1278130000	
24	38.50	1.516	36	1278140000	

Release lever (LH) see Online catalogue

Double-row connectors in 3.50 mm pitch Series B2L/S2L 3.50

S2L 3.50/./90

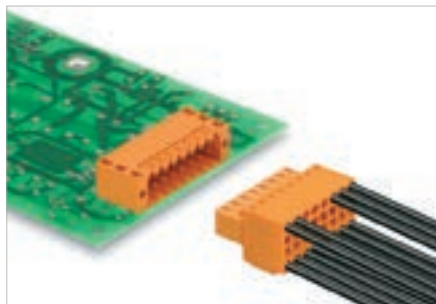

Angled, double-row male header. Male headers with 3.5 mm pins that are designed for wave soldering and are packaged in a box. Available in closed (G) version and with screw flange (F).

Technical data

In compliance with IEC 60664-1 / IEC 61984			
Clamping range, max.			
Solid core H05(07) V-U			
Stranded H07 V-R			
Flexible H05(07) V-K			
Flexible with ferrule			
Ferrule with plastic collar			
Stripping length			
Screwdriver blade			mm
According to norm			
Tightening torque range			
Rated current, max.	A	10	9
At ambient temperature		20°C	40°C
For conductor cross-section			
Overvoltage category		III	III II
Pollution severity		3	2 2
Rated voltage	V	80	125 250
Rated impulse voltage	kV	2.5	2.5 2.5
UL / CUL (Use Group)		B	C D
Rated voltage	V	150	50
Rated current	A	10	10
AWG conductor	AWG		-
CSA (Use Group)		B	C D
Rated voltage	V	150	
Rated current	A	5	
AWG conductor	AWG		-
General data			
Type of insulation material		PBT	
UL 94 flammability rating		V-0	
Contact base material		Copper alloy	
Material of contact surface		tinned	
Pin dimensions = d	mm	1.0, Octagonal	
Solder eyelet Ø = D	mm	1.3	
Solder eyelet Ø tolerance	mm	+ 0,1	

Product data

IEC: 250 V / 10 A
UL: 150 V / 10 A



For additional articles and information, refer to catalog.weidmuller.com

Note:

- Additional variants on request
- Gold-plated contact surfaces on request
- Spacing between rows: see hole layout
- Rated current related to rated cross-section & min. No. of poles.
- P on drawing = pitch
- Rated data refer only to the component itself. Clearance and creepage distances to other components are to be designed in accordance with the relevant application standards.
- Long term storage of the product with average temperature of 50 °C and average humidity 70%, 36 months

S2L 3.50/./90G

closed ends



Dimensioned drawing

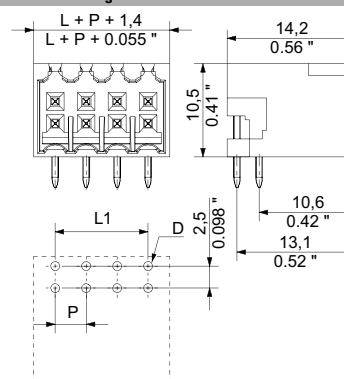

Accessories

Note: Refer to the Accessories chapter for additional accessories.

Coding	Order No.
B2L/S2L 3.50 KO OR BX	1849730000
B2L/S2L 3.50 KO BK BX	1849740000
LED light guide	
S2L/S2C 3.5 FLA 20/10	1699580000
Mounting screw	
PTSC KA 2.2X4.5 WN1412	1610740000

Ordering data

Solder pin length		3.5 mm		
Colour	orange			
Pitch	3.50 mm			
Pol.	L1	(inch)	Qty.	Order No.
6	7.00	0.276	156	1727830000
8	10.50	0.413	120	1727840000
10	14.00	0.551	96	1727850000
12	17.50	0.689	78	1727860000
14	21.00	0.827	66	1727870000
16	24.50	0.965	60	1727880000
18	28.00	1.102	54	1727890000
20	31.50	1.240	48	1727900000
22	35.00	1.378	42	1727910000
24	38.50	1.516	42	1727920000

For open version, see online catalogue

S2L 3.50/./90F

with screw flange



Dimensioned drawing

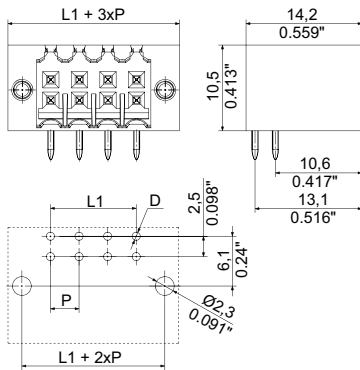

Ordering data

Solder pin length		3.5 mm	
Colour		orange	
Pitch		3.50 mm	
Pol.	L1	(inch)	Qty. Order No.
6	7.00	0.276	102 1728470000
8	10.50	0.413	84 1728480000
10	14.00	0.551	72 1728490000
12	17.50	0.689	66 1728500000
14	21.00	0.827	54 1728510000
16	24.50	0.965	48 1728520000
18	28.00	1.102	48 1728530000
20	31.50	1.240	42 1728540000
22	35.00	1.378	36 1728550000
24	38.50	1.516	36 1728560000

For open version, see online catalogue



Double-row connectors in 3.50 mm pitch Series B2L/S2L 3.50

S2L 3.50/././180

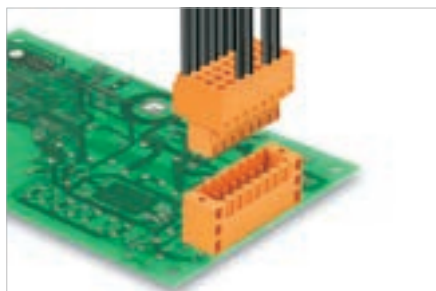

Straight, double-row male header. Male headers with 3.5 mm pins that are designed for wave soldering and are packaged in a box. The flange version can be screwed on the PCB. The male headers provide space for labelling and can be coded. Available in closed (G) version and with screw flange (LF).

Technical data

In compliance with IEC 60664-1 / IEC 61984			
Clamping range, max.			
Solid core H05(07) V-U			
Stranded H07 V-R			
Flexible H05(07) V-K			
Flexible with ferrule			
Ferrule with plastic collar			
Stripping length			
Screwdriver blade	mm		
According to norm			
Tightening torque range			
Rated current, max.	A	10	9
At ambient temperature		20°C	40°C
For conductor cross-section			
Overtoltage category		III	III II
Pollution severity		3	2 2
Rated voltage	V	80	125 250
Rated impulse voltage	kV	2.5	2.5 2.5
UL / CUL (Use Group)		B	C D
Rated voltage	V	150	50
Rated current	A	10	10
AWG conductor	AWG		-
CSA (Use Group)		B	C D
Rated voltage	V	150	
Rated current	A	5	
AWG conductor	AWG		-
General data			
Type of insulation material		PBT	
UL 94 flammability rating		V-0	
Contact base material		Copper alloy	
Material of contact surface		tinned	
Pin dimensions = d	mm	1.0, Octagonal	
Solder eyelet Ø = D	mm	1.3	
Solder eyelet Ø tolerance	mm	+ 0,1	

Product data

IEC: 250 V / 10 A
UL: 150 V / 10 A



For additional articles and information, refer to catalog.weidmuller.com

Note:

- Additional variants on request
- Gold-plated contact surfaces on request
- Spacing between rows: see hole layout
- Rated current related to rated cross-section & min. No. of poles.
- P on drawing = pitch
- Rated data refer only to the component itself. Clearance and creepage distances to other components are to be designed in accordance with the relevant application standards.
- Long term storage of the product with average temperature of 50 °C and average humidity 70%, 36 months

S2L 3.50/././180G

closed ends



Dimensioned drawing

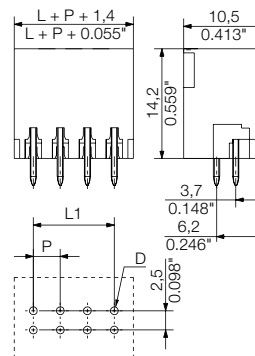

Accessories

Note: Refer to the Accessories chapter for additional accessories.

Coding	Order No.
B2L/S2L 3.50 KO OR BX	1849730000
B2L/S2L 3.50 KO BK BX	1849740000
Mounting screw	
PTSC KA 2.2X4.5 WN1412	1610740000

Ordering data

Solder pin length		3.5 mm		
Colour	orange			
Pitch	3.50 mm			
Pol.	L1	(inch)	Qty.	Order No.
6	7.00	0.276	156	1728790000
8	10.50	0.413	120	1728800000
10	14.00	0.551	96	1728810000
12	17.50	0.689	78	1728820000
14	21.00	0.827	66	1728830000
16	24.50	0.965	60	1728840000
18	28.00	1.102	54	1728850000
20	31.50	1.240	48	1728860000
22	35.00	1.378	42	1728870000
24	38.50	1.516	42	1728880000

For open version, see online catalogue

S2L 3.50/././180F

with screw flange



Dimensioned drawing

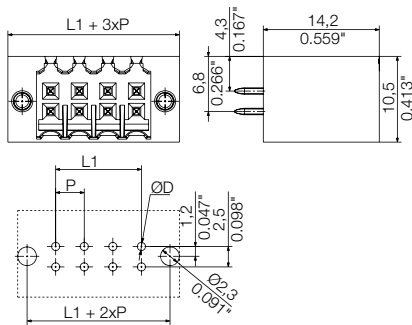

Ordering data

Solder pin length		3.5 mm		
Colour		orange		
Pitch		3.50 mm		
Pol.	L1	(inch)	Qty.	Order No.
6	7.00	0.276	102	1729430000
8	10.50	0.413	84	1729440000
10	14.00	0.551	72	1729450000
12	17.50	0.689	66	1729460000
14	21.00	0.827	54	1729470000
16	24.50	0.965	48	1729480000
18	28.00	1.102	48	1729490000
20	31.50	1.240	42	1729500000
22	35.00	1.378	36	1729510000
24	38.50	1.516	36	1729520000

For open version, see online catalogue



Double-row connectors in 3.50 mm pitch Series B2L/S2L 3.50

B2L 3.50/./180 QV

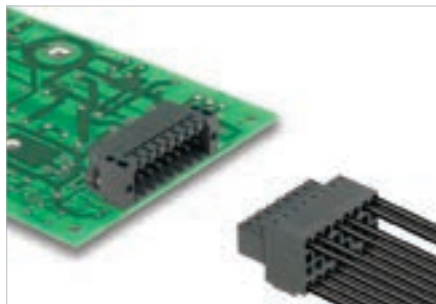

Female plugs with integral cross-connection.

- Cross-connection is positioned vertically between the poles of rows directly on top of each other.
- Tension clamp connection with straight outlet and 3.5 mm pitch.
- Flange (F) and release lever (LH) available.

Product data

IEC: 200 V / 10.6 A / 0.2 - 1 mm²
UL: 150 V / 7 A / AWG 28 - 18



For additional articles and information, refer to catalog.weidmuller.com

Note:

- Additional variants on request
- Gold-plated contact surfaces on request
- Rated current related to rated cross-section & min. No. of poles.
- Wire end ferrule with plastic collar to DIN 46228/4
- Wire end ferrule without plastic collar to DIN 46228/1
- P on drawing = pitch
- We recommend crimp shape A for wire-end ferrules with crimping tool PZ 6/5 (order no. 9011460000) for the larger wire cross-sections.
- Rated data refer only to the component itself. Clearance and creepage distances to other components are to be designed in accordance with the relevant application standards.
- Long term storage of the product with average temperature of 50 °C and average humidity 70%, 36 months

B2L 3.50/./180QV

with cross-connection



Dimensioned drawing

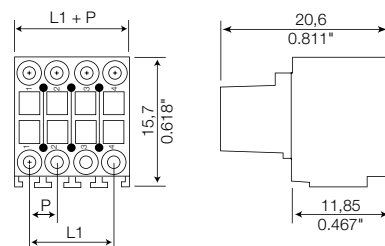

Technical data

In compliance with IEC 60664-1 / IEC 61984			
Clamping range, max.	mm ²	0.08...1	
Solid core H05(07) V-U	mm ²	0.2...1	
Stranded H07 V-R			
Flexible H05(07) V-K	mm ²	0.2...1	
Flexible with ferrule	mm ²	0.14...0.34	
Ferrule with plastic collar	mm ²	0.14...0.34	
Stripping length	mm	7	
Screwdriver blade	mm	0.4 x 2.5	
		According to norm DIN 5264	
Tightening torque range			
Rated current, max.	A	10.6	9.1
At ambient temperature		20°C	40°C
For conductor cross-section	mm ²	1	
Overvoltage category		III	III II
Pollution severity		3	2 2
Rated voltage	V	80	160 200
Rated impulse voltage	kV	1.5	2.5 2.5
UL / CUL (Use Group)		B	C D
Rated voltage	V	150	50
Rated current	A	7	7
AWG conductor	AWG	28-18	
CSA (Use Group)		B	C D
Rated voltage	V	300	
Rated current	A	7	
AWG conductor	AWG	28-18	
General data			
Type of insulation material		PBT	
UL 94 flammability rating		V-0	
Contact base material		Copper alloy	
Material of contact surface		tinned	
Pin dimensions = d	mm		
Solder eyelet Ø = D	mm		
Solder eyelet Ø tolerance	mm		

Accessories

Note: Refer to the Accessories chapter for additional accessories.		
Coding		Order No.
	B2L/S2L 3.50 KO OR BX	1849730000
	B2L/S2L 3.50 KO BK BX	1849740000
Hood		
	B2L 3.50 AH06 BK BX	1781560000
	B2L 3.50 AH08 BK BX	1781570000
	B2L 3.50 AH10 BK BX	1781580000
	B2L 3.50 AH12 BK BX	1781590000
	B2L 3.50 AH14 BK BX	1781600000
	B2L 3.50 AH16 BK BX	1781610000
	B2L 3.50 AH18 BK BX	1781620000
	B2L 3.50 AH20 BK BX	1781630000
	B2L 3.50 AH22 BK BX	1781640000
	B2L 3.50 AH24 BK BX	1781650000
	B2L 3.50 AH26 BK BX	1781660000
	B2L 3.50 AH28 BK BX	1781670000
	B2L 3.50 AH30 BK BX	1781680000
	B2L 3.50 AH32 BK BX	1781690000
	B2L 3.50 AH34 BK BX	1781700000
	B2L 3.50 AH36 BK BX	1781710000
Screwdriver		
	SDS 0.4X2.5X75	2749320000
Pressing tool		
	PZ 6/5	9011460000
	PZ 1.5	9005990000

Ordering data

Solder pin length					
Colour	black				
Pitch	3.50 mm				
Pol.	L1	(inch)	Qty.	Order No.	
6	7.00	0.276	174	1944590000	
8	10.50	0.413	132	1944600000	
10	14.00	0.551	102	1944610000	
12	17.50	0.689	84	1944620000	
14	21.00	0.827	72	1944630000	
16	24.50	0.965	66	1944640000	
18	28.00	1.102	54	1944650000	

Representative deratings curve

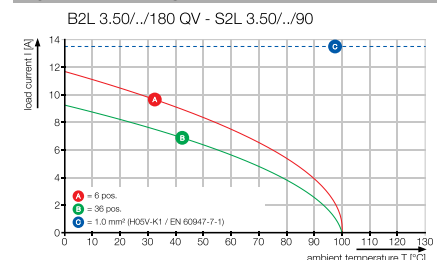

B2L 3.50/./180FQV

with cross-connection and flange



Dimensioned drawing

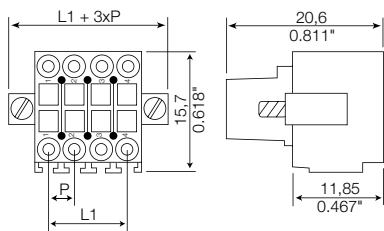

B2L 3.50/./180LHQV

with cross-connection and release lever



Dimensioned drawing

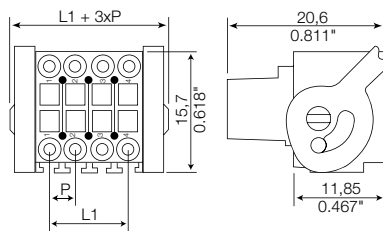

Ordering data

Solder pin length					
Colour					black
Pitch 3.50 mm					
Pol.	L1	(inch)	Qty.	Order No.	
6	7.00	0.276	108	1944670000	
8	10.50	0.413	90	1944680000	
10	14.00	0.551	72	1944690000	
12	17.50	0.689	66	1944700000	
14	21.00	0.827	20	1944710000	
16	24.50	0.965	54	1944720000	
18	28.00	1.102	48	1944730000	

Ordering data

Solder pin length					
Colour					black
Pitch 3.50 mm					
Pol.	L1	(inch)	Qty.	Order No.	
6	7.00	0.276	108	1944750000	
8	10.50	0.413	90	1944760000	
10	14.00	0.551	72	1944770000	
12	17.50	0.689	66	1944780000	
14	21.00	0.827	20	1944790000	
16	24.50	0.965	54	1944800000	
18	28.00	1.102	48	1944810000	

Excellent design & performance: the single row BL/SL Connector system with 3.50 pitch and the connection of I/Os

Extensive range of male headers and female plugs that cover different angles to the PCB and conductor angle to the field as well as a large range of accessories make the 3.50 mm pitch very versatile.

Strong in performance and connections, compact in its size:

- Wire cross-sections from 0.20 to 1.5 mm² (AWG 28-14)
- Wire connection without special tools
- More than just extra-low voltages: up to 250 V (IEC) / 300 V (UL)
- More than enough: up to 17 A (IEC) / 10 A (UL)

Reliable connection technology

Decide on the best connection technology such as the service-free standard: Weidmüller clamping yoke connection with 100 % reliability and 100 % work output: steel for strength and copper for current.

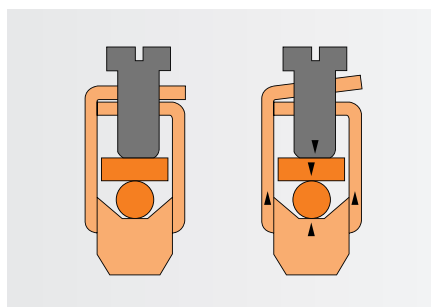

Maximum packing density

Either in a device using double layer male headers SLD or in the field using a 3 row socket connector BL-I/O.

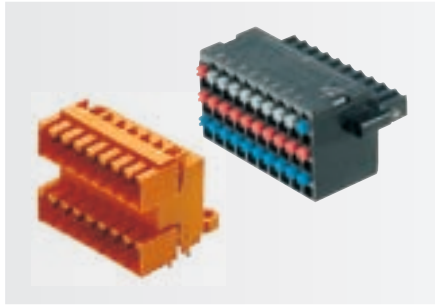

Release latch or screw flange

The release latch guarantees a good connection between the female plug and the device and also, particularly for systems with many pins, ensures an assembly protecting release of the connection. The screw flange creates a vibration and shake-proof connection between the panel connection and the device.

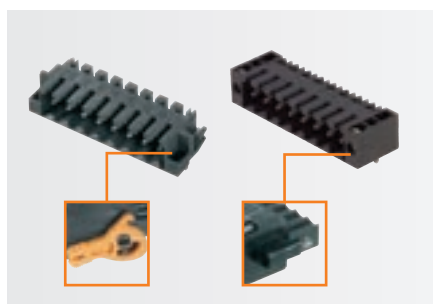

Advanced application possibilities

The extensive range of accessories increases the versatility and permits any desired combination of male headers and female plugs.

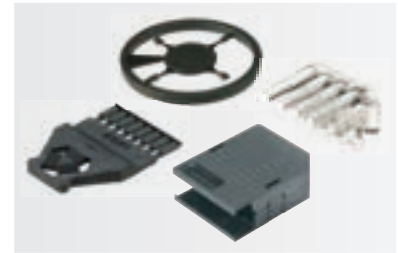

Versatile field connection

Choose your individual connection from the classic BL screw connection or the future-proof PUSH IN connection BLF or BL-I/O.



Optimum processing

The tape-on-reel packaging for high temperature-resistant male headers made of LCP guarantees a suitable product for automated processing. The integrated solder flange significantly increases the PCB's stability and replaces the screw that would normally be added later.

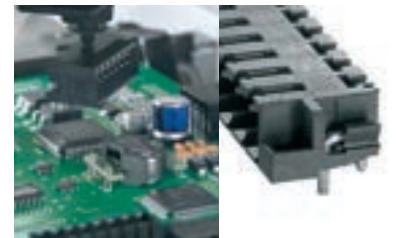

J

Efficient connections on smallest footprint BLF 3.5 PUSH IN connector in 3.50 mm pitch

Increasingly complex control systems are required in industrial automation technology. In addition, the cost pressure and the requirements for plant safety are rising. The PUSH IN connector BLF 3.5 sets new standards in order to meet these challenges optimally.

The particularly flat and compact BLF 3.5 has been developed especially for industrial automation technology. Its PUSH IN connection technology, equipped with functional release and locking levers, is suitable for conductor cross sections up to 1.5 mm² and supports a fast and reliable handling during installation and maintenance. A safety rib prevents accidentally pushing the lever when plugging.



Variable fixing options

The connector has two mounting flanges allowing for two fixing-options. One is via a Lock & Release Lever, and the other is conventional with a screw.



Pluggable cross connection

With the standard accessory ZQV 1.5N/ R3.5/2-4, pluggable cross connections can be established with up to four poles.

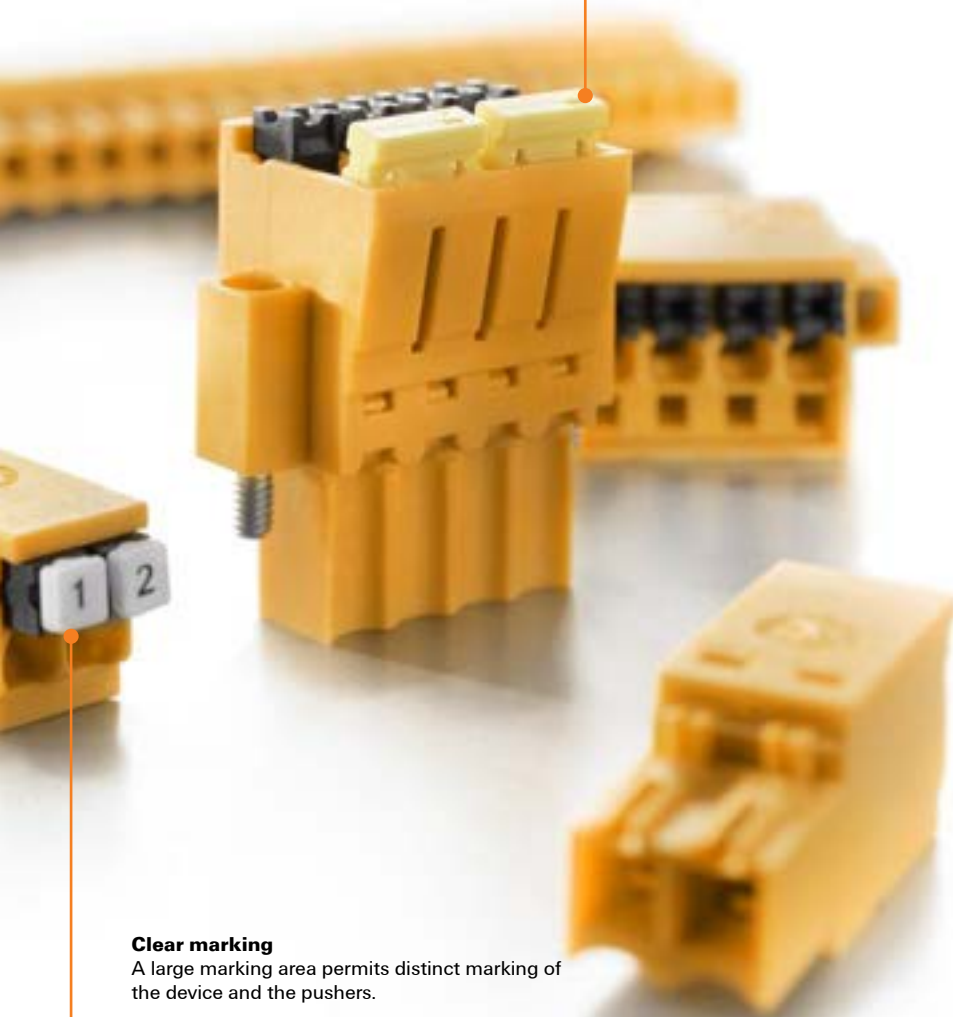
**Clear marking**

A large marking area permits distinct marking of the device and the pushers.

**Your special advantages**

- PUSH IN connectors for conductor cross sections up to 1.5 mm²
- High component density thanks to compact design
- Highly visible marking field for labelling
- Integrated mounting flanges
- Strain relief to fix and pull out the wire
- Pluggable cross connection optional



Webcode: #11410

Small – smaller – BL-I/O: minimal size – maximum functionality

You have a free choice for the field wiring: whether you prefer the compact version with our 3 row female plug BL-I/O 3.50/30-poles or rather conventional systems with terminals or interface modules lowercase's. Since the female plug BL-I/O 3.50 based I/O systems are backwards compatible with existing field connections.

The female plug BL-I/O 3.50 mm pitch is an

- extremely compact,
- 1 or 3 row female plug, suitable for connection of remote sensors and/or actuators
- with integrated LED display
- and integrated cross-connections for potential distribution.

For efficient remote functional units in the field level the female plug BL-I/O 3.50 is a space saving solution to connect I/O components.

Savings from the female connector BL-I/O are apparent in the development and the manufacturing of the PCB. The layout is simplified by 62 % and fewer layers are required.

Multiply your potential

Special cross-connectors, that are integrated into the second and third rows of the female plug, distribute the supply voltage to the individual I/O channels. In this way you can input, transfer or bridge the supply voltage. Thus you can save space with the I/O electronics, and you can reduce your wiring overhead.

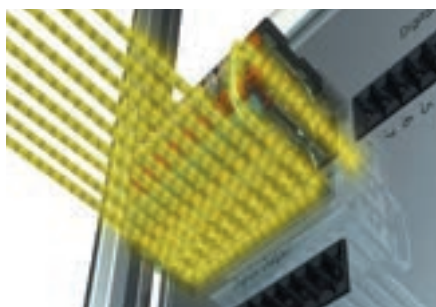

... as simple as that

Simply insert solid or flexible conductors with ferrules. The simple pressing of one button opens the terminal connections and allows you to insert the flexible wire without ferrules in no time at all. Disconnecting the wire is just as easy: press the button and pull out the wire.

PUSH IN

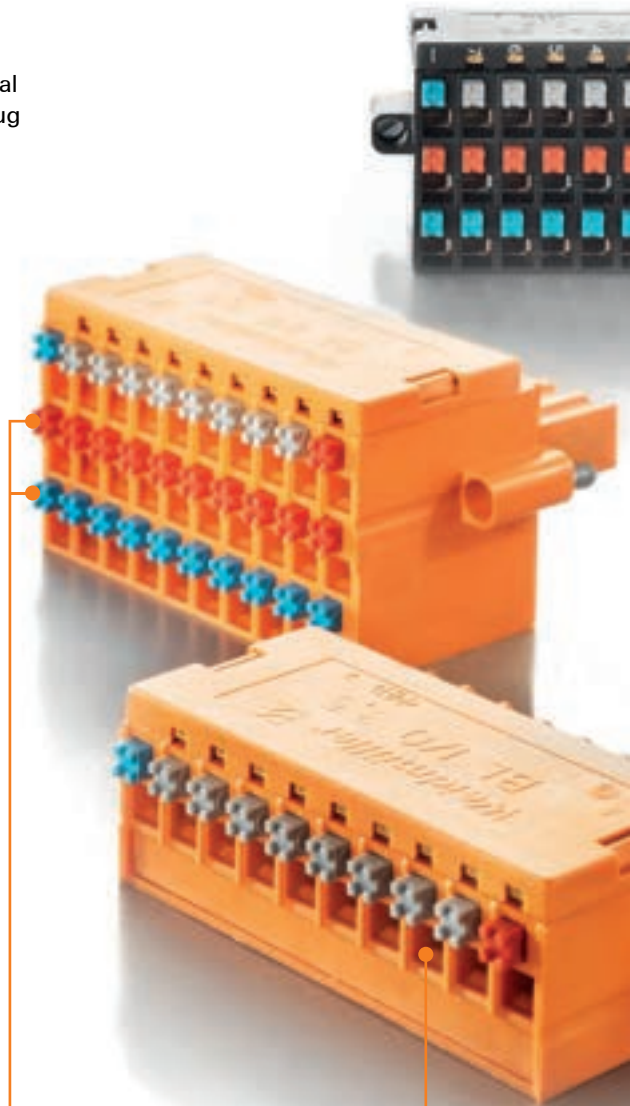

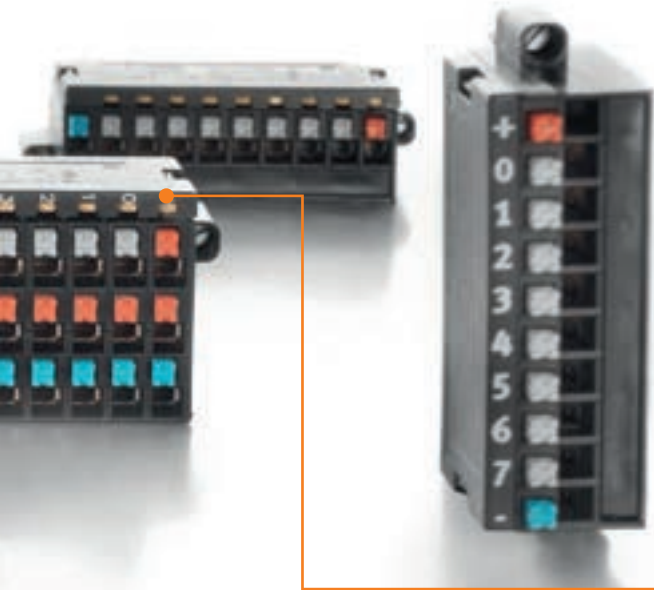

Integrated LEDs

Since power is supplied directly through the female plug BL-I/O 3.50, functional control of the sensor wiring is possible without any additionally connected I/O electronics. That simplifies initial commissioning and also clears up space on the control unit.



Intuitive locking and releasing

The 3 row female plug BL-I/O 3.50/30/180LR with lock & release lever to allow tool free interlocking and electronic assembly protecting release with the new male header SL-SMT 3.50/10/.../RF with clip-on flange

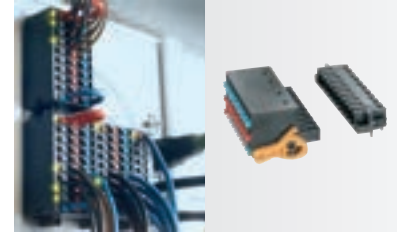

Rugged screw flange

The 3 row female plug BL-I/O 3-5/30/180F with screw flange for vibration and shock resistant interlocking in conjunction with the male header SL-SMT 3.50/10/.../LF with solder flange.

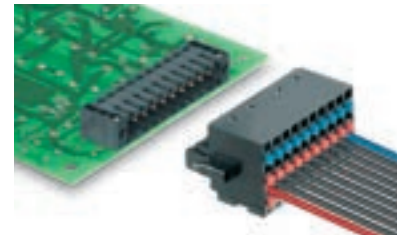

Screwless PCB fastening - suitable for automatic assembly

The male header SL-SMT has a clip-on flange for the release latch and is available as solder flange variant for the screw flange. In both variants the extra solder pin replaces the screw that would have to be added later and significantly increases the mechanical stability to the PCB.



The industrial PUSH IN smart connection

BL I/O 3.5 CJC connectors with integrated cold junction compensation

Many industrial applications demand increasingly higher accuracy of temperature measurement. At the same time, the required equipment must become cheaper and smaller. For the BL I/O 3.5 CJC, the cold junction compensation is integrated into the connector, which reduces space and costs.

The cold junction compensation of the BL I/O CJC is integrated by a thermistor in the connector. Therefore, no additional compensation is needed when connecting thermocouples to a device to measure the temperature. The integrated compensation simplifies the device and increases the measuring accuracy up to 20 %.

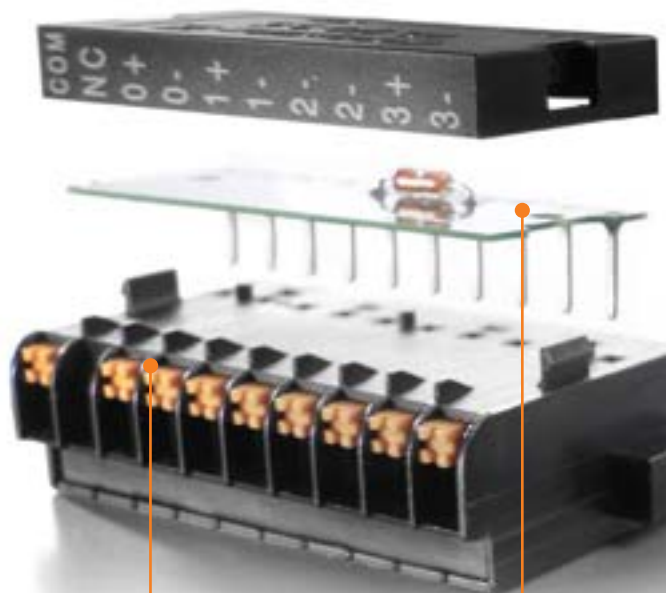

PUSH IN connection up to 1.5 mm²

With the PUSH IN connection technology, the conductor connection becomes tool-free. Solid conductors or flexible conductors with wire end ferrules are easily inserted.

J



Integrated thermistor

Cold junction compensation by integrated thermistor, to have a higher precision measuring up to 20 %. This helps for an easy device design



Clear marking



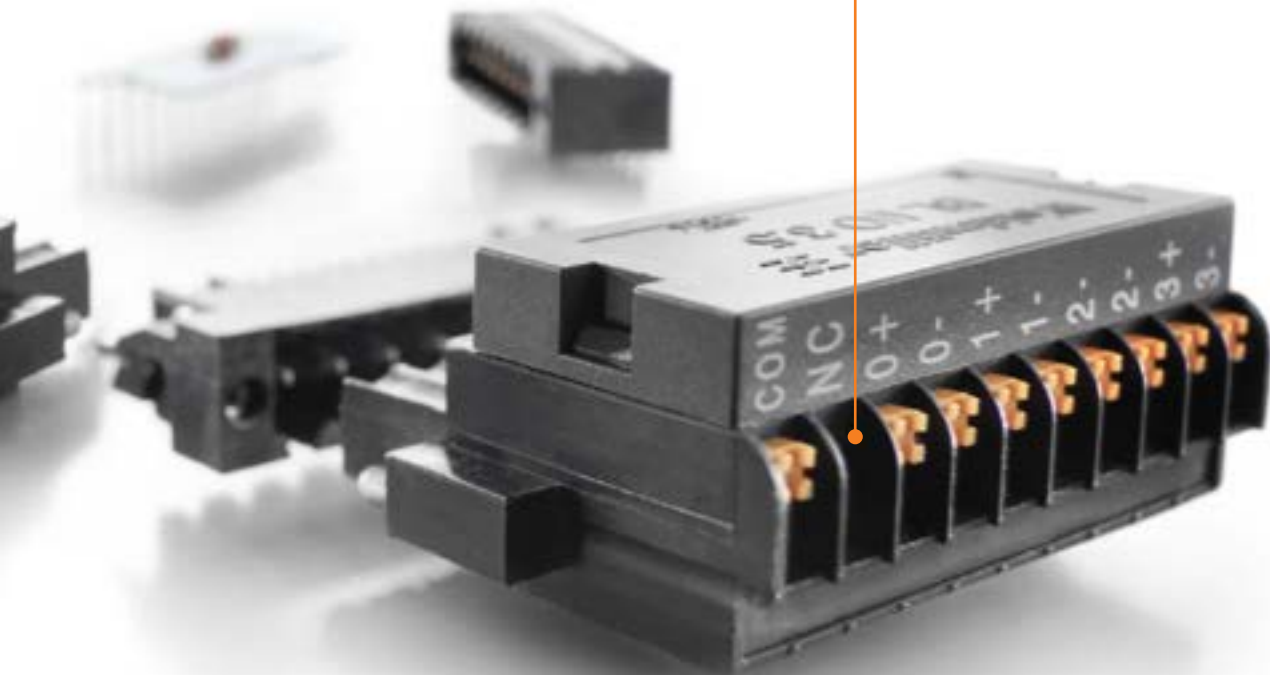
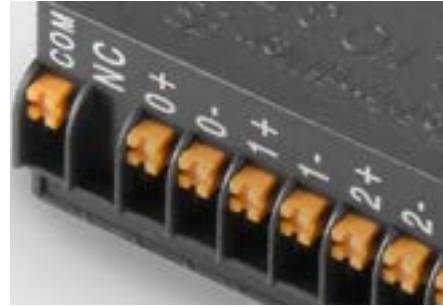

The large marking area supports a distinct and legible marking.



Your special advantages

- PUSH IN connector for conductor cross sections up to 1.5 mm²
- Cold junction compensation for the connection of thermocouples
- Up to four measuring connections for thermocouples
- High component density in a compact design
- Clearly visible marking area for labels
- Integrated mounting flanges





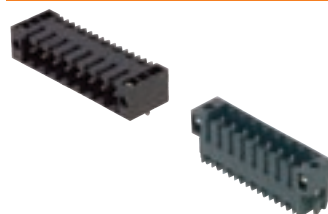
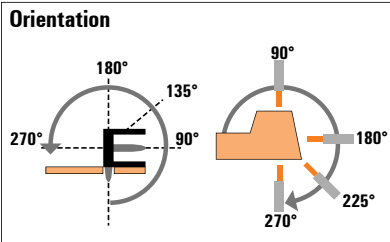
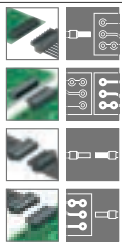





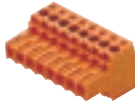







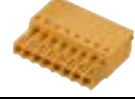

<http://www.OMNIMATE.net>

-  = Wire-to-Board
-  = Board-to-Board
-  = Wire-to-Wire
-  = Board-to-Wire

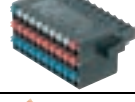

BL/SL 3.50 series

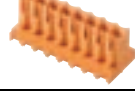

					Levels		
		Type			1		
		Orientation			SL-SMT	SL-SMT	
		Flange options			G/F/LF/RF	G/F/LF	
		IEC / UL			IEC: 320 V/15 A UL: 300 V/10 A	IEC: 320 V/15 A UL: 300 V/10 A	
Female plug	 Clamping yoke		BL	180° (G)/F/LH/LR	IEC: 320 V/17 A/0.2 - 1.5 mm ² UL: 300 V/10 A/AWG 28 - 14		
			BL	90° (G)/F	IEC: 320 V/12 A/0.2 - 1.5 mm ² UL: 300 V/8 A/AWG 28 - 14		
			BL	270° (G)/F	IEC: 320 V/12 A/0.2 - 1.5 mm ² UL: 300 V/8 A/AWG 28 - 14		
			BLF	180° (G)/F/LH/LR	IEC: 320 V/14.5 A/0.2 - 1.5 mm ² UL: 300 V/10 A/AWG 26 - 14		
			BL-I/O 10 Pole	180° F/LR/FP	IEC: 200 V/2.2 A/0.2 - 1.0 mm ² UL: ≤ 200 V/5 A/AWG 22 - 16		
		BL-I/O 30 Pole	180° F/LR/FP	IEC: 200 V/2.2 A/0.2 - 1.0 mm ² UL: ≤ 200 V/5 A/AWG 22 - 16			
Female header	 Solder con.		BLL	180° (G)	IEC: 320 V/15.1 A UL: 300 V/10 A		

Female plug:
(G)* = Closed (without flange)
F = Screw flange with screw
LH = Release lever
LR = Lock & Release lever
FP = shifted flange

Male header:
(O)* = open
G = Closed (without flange)
F = Flange with nut
LF = Solder flange with nut
RF = Locking flange for LR with solder pin

* not included in the article description

Male header



Solder connection

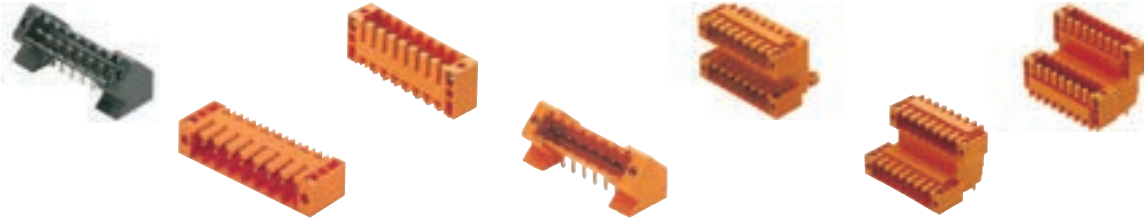

1		1			2		
SL-THR	SL	SL	SL	SLD	SLD V	SLD V	
135°	90°	180°	135°	90°	90°	180°	
F	(O)/G/F	(O)/G/F	F	G/F	G/F	G/F	
IEC: 320 V/15 A UL: 300 V/10 A	IEC: 320 V/15 A UL: 300 V/10 A	IEC: 320 V/15 A UL: 300 V/10 A	IEC: 320 V/15 A UL: 300 V/10 A	IEC: 200 V/10.5 A UL: 300 V/8 A	IEC: 200 V/10.5 A UL: 300 V/8 A	IEC: 200 V/10.5 A UL: 300 V/8 A	
○	○	○	○	○	○	○	
○	○	○	○	○	○	○	
○	○	○	○	○	○	○	
○	○	○	○	○	○	○	
○	○	○	○	○	○	○	
○	○	○	○	○	○	○	
●	●	●	●	●	●	●	

J

SL-SMT 3.50/./90

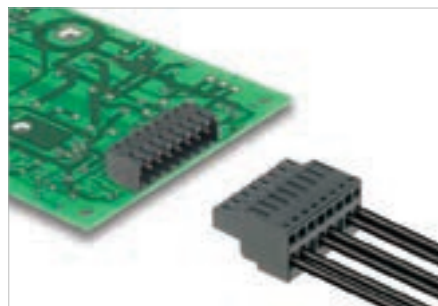

High-temperature-resistant, angled, male header for all common soldering methods in 3.5 mm pitch.

- Optimised for SMT processing.
- 3.2 mm older pin suitable for reflow and wave soldering.
- The Male headers provide space for labelling and can be coded.
- Available in closed (G) version and with solder flange (LF).
- Packed either in box (BX) or on tape-on-reel (RL).

Product data

IEC: 320 V / 15 A
UL: 300 V / 10 A



For additional articles and information, refer to catalog.weidmueller.com

Note:

- Gold-plated contact surfaces on request
- Rated current related to rated cross-section & min. No. of poles.
- Diameter of solder eyelet $D = 1.4 \pm 0.1$ mm
- Solder eyelet diameter $D = 1.5 \pm 0.1$ mm, from 9 poles
- P on drawing = pitch
- Rated data refer only to the component itself. Clearance and creepage distances to other components are to be designed in accordance with the relevant application standards.
- Long term storage of the product with average temperature of 50 °C and average humidity 70%, 36 months

SL-SMT 3.50/./90G Box



Dimensioned drawing

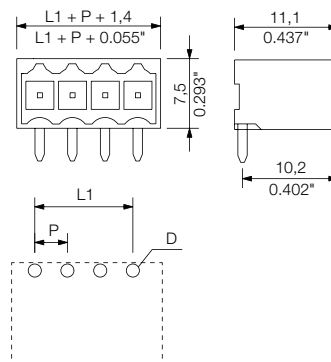

Technical data

In compliance with IEC 60664-1 / IEC 61984			
Clamping range, max.			
Solid core H05(07) V-U			
Stranded H07 V-R			
Flexible H05(07) V-K			
Flexible with ferrule			
Ferrule with plastic collar			
Stripping length			
Screwdriver blade			mm
According to norm			
Tightening torque range			
Rated current, max.	A	15	13
At ambient temperature		20°C	40°C
For conductor cross-section			
Overvoltage category		III	III II
Pollution severity		3	2 2
Rated voltage	V	160	160 320
Rated impulse voltage	kV	2.5	2.5 2.5
UL / CUL (Use Group)		B	C D
Rated voltage	V	300	300
Rated current	A	10	10
AWG conductor	AWG		-
CSA (Use Group)		B	C D
Rated voltage	V	300	300
Rated current	A	10	10
AWG conductor	AWG		-
General data			
Type of insulation material		LCP GF	
UL 94 flammability rating		V-0	
Contact base material		CuSn	
Material of contact surface		tinned	
Pin dimensions = d	mm	1.2, Octagonal	
Solder eyelet Ø = D	mm	1.4	
Solder eyelet Ø tolerance	mm	+ 0,1	

Accessories

Note: Refer to the Accessories chapter for additional accessories.		
Coding		Order No.
	BL SL 3.5 KO OR	1693430000
	BL SL 3.5 KO SW	1610100000
Interlock		
	BL/SL 3.50 VR OR BX	1669310000
	BL/SL 3.50 VR BK BX	1669300000
LED light guide		
	SL 3.5 FLA 1.5/8	1597510000
	SL 3.5 FLA 2.3/8	1597520000
	SL 3.5 FLA 4.0/8	1597530000
	SL 3.5 FLA 1.5/1.75/8	1597630000
	SL 3.5 FLA 2.3/1.75/8	1597640000
	SL 3.5 FLA 4.0/1.75/8	1597650000
Mounting screw		
	PTSC KA 2.2X4.5 WN1412	1610740000

Ordering data

Solder pin length		3.2 mm		
Colour		black		
Pitch	3.50 mm			
Pol.	L1	(inch)	Qty.	Order No.
2	3.50	0.138	100	1841630000
3	7.00	0.276	100	1841640000
4	10.50	0.413	100	1841650000
5	14.00	0.551	50	1841660000
6	17.50	0.689	50	1841670000
7	21.00	0.827	50	1841680000
8	24.50	0.965	50	1841690000
9	28.00	1.102	50	1841700000
10	31.50	1.240	50	1841710000
11	35.00	1.378	50	1841720000
12	38.50	1.516	50	1841730000

SL-SMT 3.50/./90G Tape

closed side; tape-on-reel



Dimensioned drawing

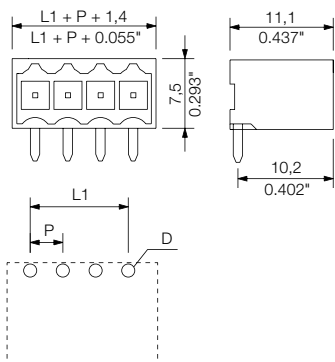

Ordering data

Solder pin length		1.5 mm	
Colour		black	
Pitch		3.50 mm	
Pol.	L1	(inch)	Qty. Order No.
2	3.50	0.138	385 1761544002
3	7.00	0.276	385 1761554002
4	10.50	0.413	385 1761564001
5	14.00	0.551	385 1761574002
6	17.50	0.689	385 1761584001
7	21.00	0.827	385 1761594001
8	24.50	0.965	385 1761604001
9	28.00	1.102	385 1761614001
10	31.50	1.240	385 1761624001
11	35.00	1.378	385 1761634001

Tape widths: 32, 44, 56, 72, 88

SL-SMT 3.50/./90LF Box

closed side; tape-on-reel



Dimensioned drawing

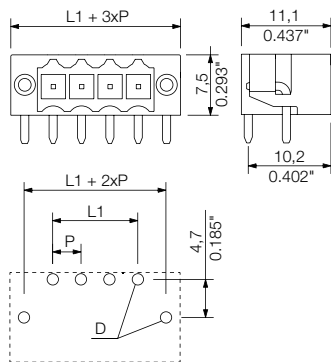

Ordering data

Solder pin length		3.2 mm	
Colour		black	
Pitch		3.50 mm	
Pol.	L1	(inch)	Qty. Order No.
2	3.50	0.138	132 1841860000
3	7.00	0.276	102 1841870000
4	10.50	0.413	84 1841880000
5	14.00	0.551	72 1841890000
6	17.50	0.689	66 1841900000
7	21.00	0.827	54 1841910000
8	24.50	0.965	48 1841920000
9	28.00	1.102	48 1841930000
10	31.50	1.240	42 1841940000
11	35.00	1.378	36 1841950000
12	38.50	1.516	36 1804340000

SL-SMT 3.50/./90LF Tape

with solder flange; tape-on-reel



Dimensioned drawing

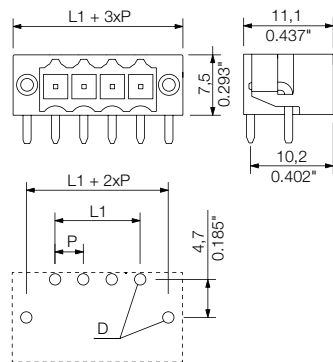

Ordering data

Solder pin length		1.5 mm	
Colour		black	
Pitch		3.50 mm	
Pol.	L1	(inch)	Qty. Order No.
2	3.50	0.138	385 1805310000
3	7.00	0.276	385 1805320000
4	10.50	0.413	385 1805330000
5	14.00	0.551	385 1805340000
6	17.50	0.689	385 1805350000
7	21.00	0.827	385 1805360000
8	24.50	0.965	385 1805370000
9	28.00	1.102	385 1805380000
10	31.50	1.240	385 1005180000

Tape widths: 32, 44, 56, 72, 88

SL-SMT 3.50/./ F & RF

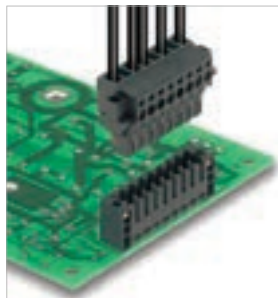

High-temperature-resistant, straight and angled, male header for all common soldering methods in 3.5 mm pitch.

- Optimised for the SMT processing.
- 3.2 mm solder pin suitable for reflow and wave soldering.
- Available with screw flange (F) and with solder flange for lock and release lever (RF).

Product data

IEC: 320 V / 15 A
UL: 300 V / 10 A



For additional articles and information, refer to catalog.weidmueller.com

Note:

- Gold-plated contact surfaces on request
- Rated current related to rated cross-section & min. No. of poles.
- Diameter of solder eyelet $D = 1.4 \pm 0.1$ mm
- Solder eyelet diameter $D = 1.5 \pm 0.1$ mm, from 9 poles
- P on drawing = pitch
- Rated data refer only to the component itself. Clearance and creepage distances to other components are to be designed in accordance with the relevant application standards.
- For additional mechanical support for male connectors with screw flange (...F), we recommend an additional cable gland with fastening screws (sheet metal screw ISO 1481-ST 2.2x4.5 C or ISO 7049-ST 2.2x4.5 C - see Accessories). Cable gland only permitted before soldering.
- Long term storage of the product with average temperature of 50 °C and average humidity 70%, 36 months

SL-SMT 3.50/./90F Box

with screw flange



Dimensioned drawing

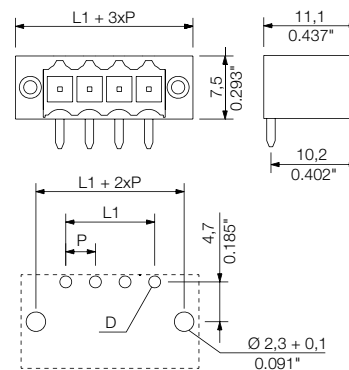

Technical data

In compliance with IEC 60664-1 / IEC 61984			
Clamping range, max.			
Solid core H05(07) V-U			
Stranded H07 V-R			
Flexible H05(07) V-K			
Flexible with ferrule			
Ferrule with plastic collar			
Stripping length			
Screwdriver blade	mm		
According to norm			
Tightening torque range			
Rated current, max.	A	15	13
At ambient temperature		20°C	40°C
For conductor cross-section			
Overvoltage category		III	III II
Pollution severity		3	2 2
Rated voltage	V	160	160 320
Rated impulse voltage	kV	2.5	2.5 2.5
UL / CUL (Use Group)		B	C D
Rated voltage	V	300	300
Rated current	A	10	10
AWG conductor	AWG		-
CSA (Use Group)		B	C D
Rated voltage	V	300	300
Rated current	A	10	10
AWG conductor	AWG		-
General data			
Type of insulation material		LCP GF	
UL 94 flammability rating		V-0	
Contact base material		CuSn	
Material of contact surface		tinned	
Pin dimensions = d	mm	1.2, Octagonal	
Solder eyelet $\varnothing = D$	mm	1.4	
Solder eyelet \varnothing tolerance	mm	+ 0,1	

Accessories

Note: Refer to the Accessories chapter for additional accessories.		
Coding		Order No.
	BL SL 3.5 KO OR	1693430000
	BL SL 3.5 KO SW	1610100000
Interlock		
	BL/SL 3.50 VR OR BX	1669310000
	BL/SL 3.50 VR BK BX	1669300000
LED light guide		
	SL 3.5 FLA 1.5/8	1597510000
	SL 3.5 FLA 2.3/8	1597520000
	SL 3.5 FLA 4.0/8	1597530000
	SL 3.5 FLA 1.5/1.75/8	1597630000
	SL 3.5 FLA 2.3/1.75/8	1597640000
	SL 3.5 FLA 4.0/1.75/8	1597650000

Ordering data

Solder pin length		3.2 mm		
Colour		black		
Pitch	3.50 mm			
Pol.	L1	(inch)	Qty.	Order No.
2	3.50	0.138	132	1842080000
3	7.00	0.276	102	1842090000
4	10.50	0.413	84	1842100000
5	14.00	0.551	72	1842110000
6	17.50	0.689	66	1842120000
7	21.00	0.827	54	1842130000
8	24.50	0.965	48	1842140000
9	28.00	1.102	48	1842150000
10	31.50	1.240	42	1842160000
11	35.00	1.378	36	1842170000
12	38.50	1.516	36	1842180000

J

3.50

90°

SL-SMT 3.50/./90RF Box

with snap-on solder flange



Dimensioned drawing

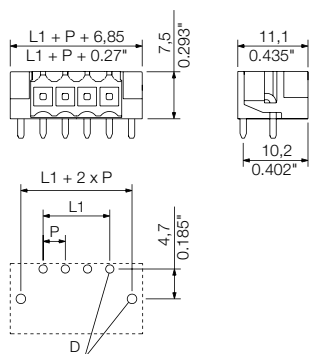

Ordering data

Solder pin length		1.5 mm	
Colour		black	
Pitch		3.50 mm	
Pol.	L1	(inch)	Qty. Order No.
2	3.50	0.138	100 1379610000
3	7.00	0.276	100 1060810000
4	10.50	0.413	100 1000600000
5	14.00	0.551	50 1000610000
6	17.50	0.689	50 1000620000
7	21.00	0.827	50 1000630000
8	24.50	0.965	50 1000640000
9	28.00	1.102	50 1000650000
10	31.50	1.240	50 1060780000
11	35.00	1.378	50 1000660000
12	38.50	1.516	50 1000670000

Compatible with release latch (LR)

Connectors in 3.50 mm pitch Series BL/SL 3.50

SL-SMT 3.50../180

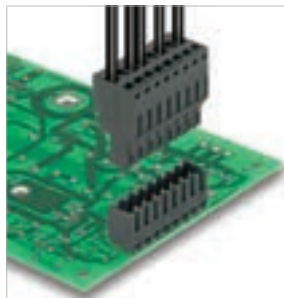

High-temperature-resistant, straight (180°) male header for all common soldering methods in 3.50 mm pitch. Optimised for the SMT process. Packed in box or tape. Pin length 1.5 mm optimised for reflow soldering methods. Pin length 3.2 mm universal for all soldering methods. The male connectors provide space for labelling and can be coded.

Technical data

In compliance with IEC 60664-1 / IEC 61984

Clamping range, max.			
Solid core H05(07) V-U			
Stranded H07 V-R			
Flexible H05(07) V-K			
Flexible with ferrule			
Ferrule with plastic collar			
Stripping length			
Screwdriver blade	mm		
According to norm			
Tightening torque range			
Rated current, max.	A	15	13
At ambient temperature		20°C	40°C
For conductor cross-section			
Overtoltage category		III	III II
Pollution severity		3	2 2
Rated voltage	V	160	160 320
Rated impulse voltage	kV	2.5	2.5 2.5
UL / CUL (Use Group)	B C D		
Rated voltage	V	300	300
Rated current	A	10	10
AWG conductor	AWG	-	
CSA (Use Group)	B C D		
Rated voltage	V	300	300
Rated current	A	10	10
AWG conductor	AWG	-	
General data			
Type of insulation material	LCP GF		
UL 94 flammability rating	V-0		
Contact base material	CuSn		
Material of contact surface	tinned		
Pin dimensions = d	mm	1.2, Octagonal	
Solder eyelet Ø = D	mm	1.4	
Solder eyelet Ø tolerance	mm	+ 0,1	

Product data

IEC: 320 V / 15 A
UL: 300 V / 10 A



For additional articles and information, refer to catalog.weidmueller.com

Note:

- Gold-plated contact surfaces on request
- Rated current related to rated cross-section & min. No. of poles.
- Diameter of solder eyelet $D = 1.4 \pm 0.1$ mm
- Solder eyelet diameter $D = 1.5 \pm 0.1$ mm, from 9 poles
- P on drawing = pitch
- Rated data refer only to the component itself. Clearance and creepage distances to other components are to be designed in accordance with the relevant application standards.
- Long term storage of the product with average temperature of 50 °C and average humidity 70%, 36 months

SL SMT 3.50../180G Box

closed side



Dimensioned drawing

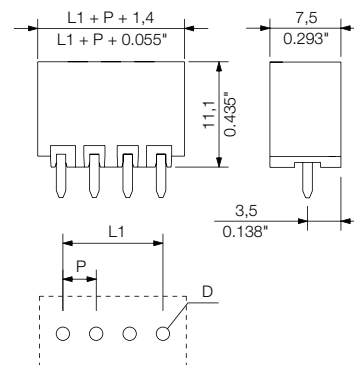

Accessories

Note: Refer to the Accessories chapter for additional accessories.

Coding		Order No.
	BL SL 3.5 KO OR	1693430000
	BL SL 3.5 KO SW	1610100000
Interlock		
	BL/SL 3.50 VR OR BX	1669310000
	BL/SL 3.50 VR BK BX	1669300000

Ordering data

Solder pin length		3.2 mm		
Colour		black		
Pitch	3.50 mm			
Pol.	L1	(inch)	Qty.	Order No.
2	3.50	0.138	100	1842320000
3	7.00	0.276	100	1842330000
4	10.50	0.413	100	1842340000
5	14.00	0.551	50	1842350000
6	17.50	0.689	50	1842360000
7	21.00	0.827	50	1842370000
8	24.50	0.965	50	1842380000
9	28.00	1.102	50	1842390000
10	31.50	1.240	50	1836990000
11	35.00	1.378	50	1842400000
12	38.50	1.516	50	1842410000

J

3.50

180°

SL SMT 3.50/./180G Tape

closed side; tape-on-reel



Dimensioned drawing

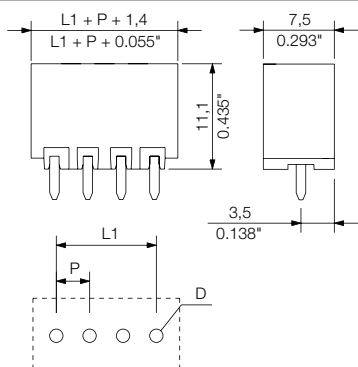

Ordering data

Solder pin length		1.5 mm	
Colour		black	
Pitch		3.50 mm	
Pol.	L1	(inch)	Qty. Order No.
2	3.50	0.138	265 1752984002
3	7.00	0.276	265 1752994002
4	10.50	0.413	265 1753004002
5	14.00	0.551	265 1753014002
6	17.50	0.689	265 1753024001
7	21.00	0.827	265 1753034001
8	24.50	0.965	265 1753044001
9	28.00	1.102	265 1753054001
10	31.50	1.240	265 1753064001
11	35.00	1.378	265 1753074001

Tape widths: 32, 44, 56, 72, 88

SL SMT 3.50/./180LF Box

with solder flange



Dimensioned drawing

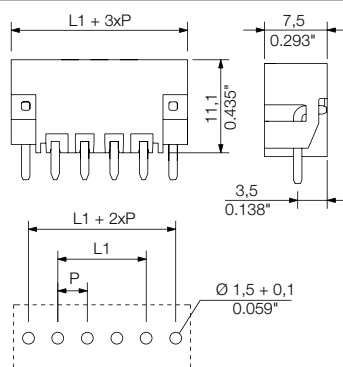

Ordering data

Solder pin length		3.2 mm	
Colour		black	
Pitch		3.50 mm	
Pol.	L1	(inch)	Qty. Order No.
2	3.50	0.138	132 1842540000
3	7.00	0.276	102 1842550000
4	10.50	0.413	84 1842560000
5	14.00	0.551	72 1842570000
6	17.50	0.689	66 1842580000
7	21.00	0.827	54 1842590000
8	24.50	0.965	48 1842600000
9	28.00	1.102	48 1842610000
10	31.50	1.240	42 1842620000
11	35.00	1.378	36 1842630000
12	38.50	1.516	36 1842640000

SL SMT 3.50/./180LF Tape

with solder flange; tape-on-reel



Dimensioned drawing

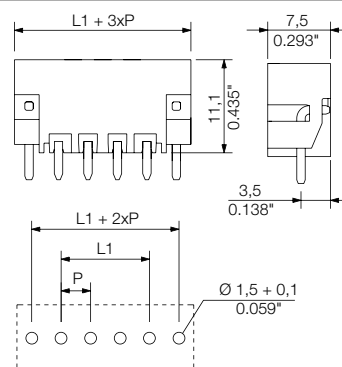

Ordering data

Solder pin length		1.5 mm	
Colour		black	
Pitch		3.50 mm	
Pol.	L1	(inch)	Qty. Order No.
2	3.50	0.138	265 1805210000
3	7.00	0.276	265 1805230000
4	10.50	0.413	265 1805240000
5	14.00	0.551	265 1805250000
6	17.50	0.689	265 1805270000
7	21.00	0.827	265 1805280000
8	24.50	0.965	265 1805290000
9	28.00	1.102	265 1805300000
10	31.50	1.240	265 1936340000

Tape widths: 32, 44, 56, 72, 88

Connectors in 3.50 mm pitch Series BL/SL 3.50

SL 3.50/./90

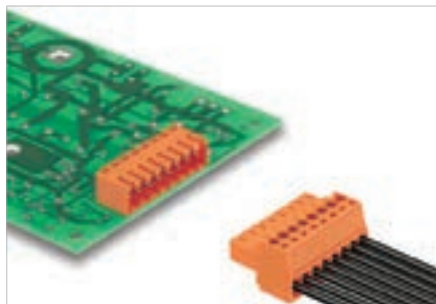

Angled male header (90° orientation) for wave soldering in 3.5 mm pitch. The male header is available in open, closed (G) and flange (F) versions. Packed in cardboard box.

Technical data

In compliance with IEC 60664-1 / IEC 61984

Clamping range, max.			
Solid core H05(07) V-U			
Stranded H07 V-R			
Flexible H05(07) V-K			
Flexible with ferrule			
Ferrule with plastic collar			
Stripping length			
Screwdriver blade	mm		
According to norm			
Tightening torque range			
Rated current, max.	A	17	14.5
At ambient temperature		20°C	40°C
For conductor cross-section		III	III II
Overvoltage category		3	2 2
Pollution severity			
Rated voltage	V	160	160 320
Rated impulse voltage	kV	2.5	2.5 2.5
UL / CUL (Use Group)		B	C D
Rated voltage	V	300	300
Rated current	A	10	10
AWG conductor	AWG		-
CSA (Use Group)		B	C D
Rated voltage	V	300	300
Rated current	A	10	10
AWG conductor	AWG		-
General data			
Type of insulation material		PBT	
UL 94 flammability rating		V-0	
Contact base material		CuSn	
Material of contact surface		tinned	
Pin dimensions = d	mm	1.2, Octagonal	
Solder eyelet Ø = D	mm	1.4	
Solder eyelet Ø tolerance	mm	+ 0,1	

Product data

IEC: 320 V / 17 A
UL: 300 V / 10 A



For additional articles and information, refer to catalog.weidmuller.com

Note:

- Additional variants on request
- Gold-plated contact surfaces on request
- Rated current related to rated cross-section & min. No. of poles.
- P on drawing = pitch
- Rated data refer only to the component itself. Clearance and creepage distances to other components are to be designed in accordance with the relevant application standards.
- Long term storage of the product with average temperature of 50 °C and average humidity 70%, 36 months

SL 3.50/./90

open side





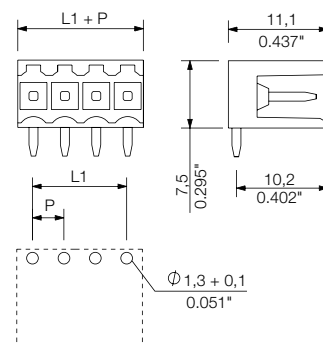







Dimensioned drawing



Accessories

Note: Refer to the Accessories chapter for additional accessories.

Coding	Order No.
 BL SL 3.5 KO OR	1693430000
 BL SL 3.5 KO SW	1610100000
Interlock	
 BL/SL 3.50 VR OR BX	1669310000
 BL/SL 3.50 VR BK BX	1669300000
LED light guide	
 SL 3.5 FLA 1.5/8	1597510000
 SL 3.5 FLA 2.3/8	1597520000
 SL 3.5 FLA 4.0/8	1597530000
 SL 3.5 FLA 1.5/1.75/8	1597630000
 SL 3.5 FLA 2.3/1.75/8	1597640000
 SL 3.5 FLA 4.0/1.75/8	1597650000
Mounting screw	
 PTSC KA 2.2X4.5 WN1412	1610740000

Ordering data

Solder pin length		3.2 mm		
Colour		orange		
Pitch		3.50 mm		
Pol.	L1	(inch)	Qty.	Order No.
2	3.50	0.138	100	1597210000
3	7.00	0.276	100	1597220000
4	10.50	0.413	100	1597230000
5	14.00	0.551	50	1597240000
6	17.50	0.689	50	1597250000
7	21.00	0.827	50	1597260000
8	24.50	0.965	50	1597270000
9	28.00	1.102	50	1597280000
10	31.50	1.240	50	1597290000
11	35.00	1.378	50	1597300000
12	38.50	1.516	50	1597310000

J

3.50

90°

SL 3.50/./90G

closed side



Dimensioned drawing

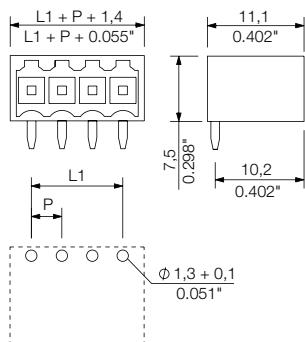

Ordering data

Solder pin length		3.2 mm	
Colour		orange	
Pitch		3.50 mm	
Pol.	L1	(inch)	Order No.
2	3.50	0.138	1605070000
3	7.00	0.276	1605080000
4	10.50	0.413	1605090000
5	14.00	0.551	1605100000
6	17.50	0.689	1605110000
7	21.00	0.827	1605120000
8	24.50	0.965	1605130000
9	28.00	1.102	1605140000
10	31.50	1.240	1605150000
11	35.00	1.378	1605160000
12	38.50	1.516	1605170000

SL 3.50/./90F

with screw flange



Dimensioned drawing

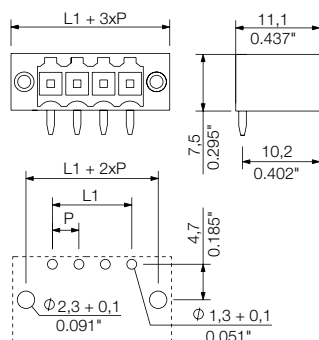

Ordering data

Solder pin length		3.2 mm	
Colour		orange	
Pitch		3.50 mm	
Pol.	L1	(inch)	Order No.
2	3.50	0.138	1607040000
3	7.00	0.276	1607050000
4	10.50	0.413	1607060000
5	14.00	0.551	1607070000
6	17.50	0.689	1607080000
7	21.00	0.827	1607090000
8	24.50	0.965	1607100000
9	28.00	1.102	1607110000
10	31.50	1.240	1607120000
11	35.00	1.378	1607130000
12	38.50	1.516	1607140000

SL 3.50/./180

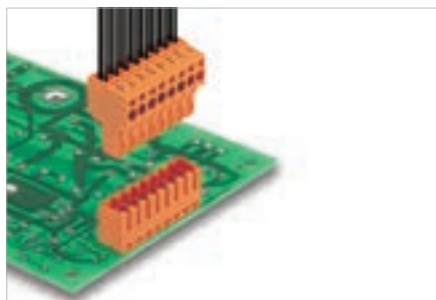

Straight male header (180° orientation) for wave soldering in 3.5 mm pitch. The male header is available in open, closed (G) and flange (F) versions. Packed in cardboard box.

Technical data

In compliance with IEC 60664-1 / IEC 61984

Clamping range, max.			
Solid core H05(07) V-U			
Stranded H07 V-R			
Flexible H05(07) V-K			
Flexible with ferrule			
Ferrule with plastic collar			
Stripping length			
Screwdriver blade	mm		
According to norm			
Tightening torque range			
Rated current, max.	A	17	14.5
At ambient temperature		20°C	40°C
For conductor cross-section			
Overvoltage category		III	III II
Pollution severity		3	2 2
Rated voltage	V	160	160 320
Rated impulse voltage	kV	2.5	2.5 2.5
UL / CUL (Use Group)		B	C D
Rated voltage	V	300	300
Rated current	A	10	10
AWG conductor	AWG		-
CSA (Use Group)		B	C D
Rated voltage	V	300	300
Rated current	A	10	10
AWG conductor	AWG		-
General data			
Type of insulation material	PBT		
UL 94 flammability rating	V-0		
Contact base material	CuSn		
Material of contact surface	tinned		
Pin dimensions = d	mm	1.2, Octagonal	
Solder eyelet Ø = D	mm	1.4	
Solder eyelet Ø tolerance	mm	+ 0,1	

Product data

IEC: 320 V / 17 A
UL: 300 V / 10 A



For additional articles and information, refer to catalog.weidmuller.com

Note:

- Additional variants on request
- Gold-plated contact surfaces on request
- Rated current related to rated cross-section & min. No. of poles.
- P on drawing = pitch
- Rated data refer only to the component itself. Clearance and creepage distances to other components are to be designed in accordance with the relevant application standards.
- Long term storage of the product with average temperature of 50 °C and average humidity 70%, 36 months

SL 3.50/./180

open side

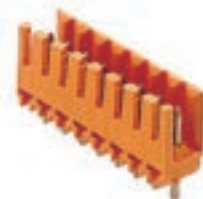

Dimensioned drawing

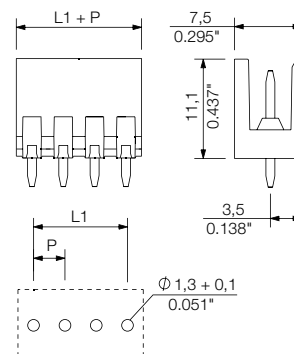

Accessories

Note: Refer to the Accessories chapter for additional accessories.

Coding		Order No.
	BL SL 3.5 KO OR	1693430000
	BL SL 3.5 KO SW	1610100000
Interlock		
	BL/SL 3.50 VR OR BX	1669310000
	BL/SL 3.50 VR BK BX	1669300000
Mounting screw		
	PTSC KA 2.2X4.5 WN1412	1610740000

Ordering data

Solder pin length		3.2 mm		
Colour		orange		
Pitch		3.50 mm		
Pol.	L1	(inch)	Qty.	Order No.
2	3.50	0.138	100	1604770000
3	7.00	0.276	100	1604780000
4	10.50	0.413	100	1604790000
5	14.00	0.551	50	1604800000
6	17.50	0.689	50	1604810000
7	21.00	0.827	50	1604820000
8	24.50	0.965	50	1604830000
9	28.00	1.102	50	1604840000
10	31.50	1.240	50	1604850000
11	35.00	1.378	50	1604860000
12	38.50	1.516	50	1604870000

SL 3.50/././180G

closed side



Dimensioned drawing

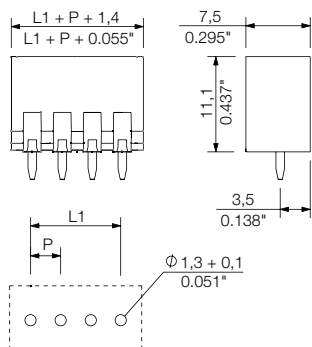

Ordering data

Solder pin length		3.2 mm			
Colour		orange			
Pitch		3.50 mm			
Pol.	L1	(inch)	Qty.	Order No.	
2	3.50	0.138	100	1604470000	
3	7.00	0.276	100	1604480000	
4	10.50	0.413	100	1604490000	
5	14.00	0.551	50	1604500000	
6	17.50	0.689	50	1604510000	
7	21.00	0.827	50	1604520000	
8	24.50	0.965	50	1604530000	
9	28.00	1.102	50	1604540000	
10	31.50	1.240	50	1604550000	
11	35.00	1.378	50	1604560000	
12	38.50	1.516	50	1604570000	

SL 3.50/././180F

with screw flange



Dimensioned drawing

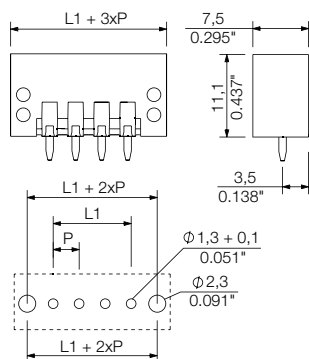

Ordering data

Solder pin length		3.2 mm			
Colour		orange			
Pitch		3.50 mm			
Pol.	L1	(inch)	Qty.	Order No.	
2	3.50	0.138	100	1607500000	
3	7.00	0.276	100	1607510000	
4	10.50	0.413	100	1607520000	
5	14.00	0.551	50	1607530000	
6	17.50	0.689	50	1607540000	
7	21.00	0.827	50	1607550000	
8	24.50	0.965	50	1607560000	
9	28.00	1.102	50	1607570000	
10	31.50	1.240	50	1607580000	
11	35.00	1.378	50	1607590000	
12	38.50	1.516	50	1607600000	

Connectors in 3.50 mm pitch Series BL/SL 3.50

SL 3.50/././135

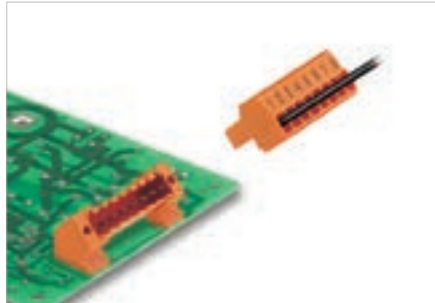

Angled male header (135° orientation) for wave soldering in 3.5 mm pitch. The male header is available in closed (G) and flange (F) versions.

Technical data

In compliance with IEC 60664-1 / IEC 61984

Clamping range, max.			
Solid core H05(07) V-U			
Stranded H07 V-R			
Flexible H05(07) V-K			
Flexible with ferrule			
Ferrule with plastic collar			
Stripping length			
Screwdriver blade	mm		
According to norm			
Tightening torque range			
Rated current, max.	A	15	13
At ambient temperature		20°C	40°C
For conductor cross-section			
Overtoltage category		III	III II
Pollution severity		3	2 2
Rated voltage	V	160	160 320
Rated impulse voltage	kV	2.5	2.5 2.5
UL / CUL (Use Group)		B	C D
Rated voltage	V	300	300
Rated current	A	10	10
AWG conductor	AWG		-
CSA (Use Group)		B	C D
Rated voltage	V	300	300
Rated current	A	10	10
AWG conductor	AWG		-
General data			
Type of insulation material		PBT	
UL 94 flammability rating		V-0	
Contact base material		CuSn	
Material of contact surface		tinned	
Pin dimensions = d	mm	1.2, Octagonal	
Solder eyelet Ø = D	mm	1.4	
Solder eyelet Ø tolerance	mm	+ 0,1	

Product data

IEC: 320 V / 15 A
UL: 300 V / 10 A



For additional articles and information, refer to catalog.weidmueller.com

Note:

- Additional variants on request
- Gold-plated contact surfaces on request
- Rated current related to rated cross-section & min. No. of poles.
- P on drawing = pitch
- Rated data refer only to the component itself. Clearance and creepage distances to other components are to be designed in accordance with the relevant application standards.
- Long term storage of the product with average temperature of 50 °C and average humidity 70%, 36 months

SL 3.50/././135F

with screw flange



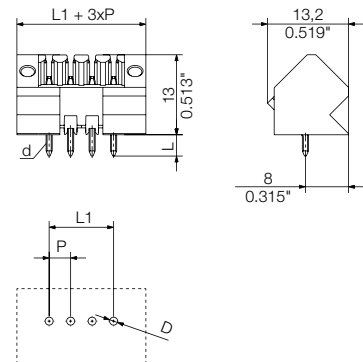

Dimensioned drawing



Accessories

Note: Refer to the Accessories chapter for additional accessories.

Coding		Order No.
	BL SL 3.5 KO OR	1693430000
	BL SL 3.5 KO SW	1610100000
Interlock		
	BL/SL 3.50 VR OR BX	1669310000
	BL/SL 3.50 VR BK BX	1669300000

Ordering data

Solder pin length		3.2 mm		
Colour		orange		
Pitch		3.50 mm		
Pol.	L1	(inch)	Qty.	Order No.
2	3.50	0.138	132	1643330000
3	7.00	0.276	102	1643340000
4	10.50	0.413	84	1643350000
5	14.00	0.551	72	1643360000
6	17.50	0.689	66	1643370000
7	21.00	0.827	54	1643380000
8	24.50	0.965	48	1643390000
9	28.00	1.102	48	1643400000
10	31.50	1.240	42	1643410000
11	35.00	1.378	36	1643420000
12	38.50	1.516	36	1643430000

J

3.50

135°

SL-THR 3.50/././135



High-temperature-resistant, 135° angled, male header for all common soldering methods in 3.5 mm pitch. 3.2 mm solder pin suitable for reflow and wave soldering. The pin headers provide space for labelling and can be coded.

Technical data

In compliance with IEC 60664-1 / IEC 61984

Clamping range, max.			
Solid core H05(07) V-U			
Stranded H07 V-R			
Flexible H05(07) V-K			
Flexible with ferrule			
Ferrule with plastic collar			
Stripping length			
Screwdriver blade	mm		
According to norm			
Tightening torque range			
Rated current, max.	A	15	13
At ambient temperature		20°C	40°C
For conductor cross-section			
Overtoltage category		III	III II
Pollution severity		3	2 2
Rated voltage	V	160	160 320
Rated impulse voltage	kV	2.5	2.5 2.5
UL / CUL (Use Group)		B	C D
Rated voltage	V	300	300
Rated current	A	10	10
AWG conductor	AWG		-
CSA (Use Group)		B	C D
Rated voltage	V	300	300
Rated current	A	10	10
AWG conductor	AWG		-
General data			
Type of insulation material		LCP GF	
UL 94 flammability rating		V-0	
Contact base material		CuSn	
Material of contact surface		tinned	
Pin dimensions = d	mm	1.2, Octagonal	
Solder eyelet Ø = D	mm	1.3	
Solder eyelet Ø tolerance	mm	+ 0,1	

Product data

IEC: 320 V / 15 A
UL: 300 V / 10 A



For additional articles and information, refer to catalog.weidmueller.com

Note:

- Gold-plated contact surfaces on request
- Rated current related to rated cross-section & min. No. of poles.
- Diameter of solder eyelet $D = 1.4 + 0.1 \text{ mm}$
- Solder eyelet diameter $D = 1.5 + 0.1 \text{ mm}$, from 9 poles
- P on drawing = pitch
- Rated data refer only to the component itself. Clearance and creepage distances to other components are to be designed in accordance with the relevant application standards.
- Long term storage of the product with average temperature of 50 °C and average humidity 70%, 36 months

SL-THR 3.50/././135F

with screw flange



Dimensioned drawing

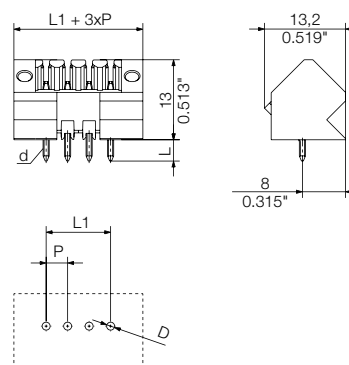

Accessories

Note: Refer to the Accessories chapter for additional accessories.

Coding		Order No.
	BL SL 3.5 KO OR	1693430000
	BL SL 3.5 KO SW	1610100000
Interlock		
	BL/SL 3.50 VR OR BX	1669310000
	BL/SL 3.50 VR BK BX	1669300000

Ordering data

Solder pin length		3.2 mm		
Colour		black		
Pitch		3.50 mm		
Pol.	L1	(inch)	Qty.	Order No.
2	3.50	0.138	132	1003510000
3	7.00	0.276	102	1003520000
4	10.50	0.413	84	1003530000
5	14.00	0.551	72	1003540000
6	17.50	0.689	66	1003550000
7	21.00	0.827	54	1003560000
8	24.50	0.965	48	1003570000
9	28.00	1.102	48	1003580000
10	31.50	1.240	42	1003590000
11	35.00	1.378	36	1003600000
12	38.50	1.516	36	1003620000

Connectors in 3.50 mm pitch Series BL/SL 3.50

SLD 3.50/./90

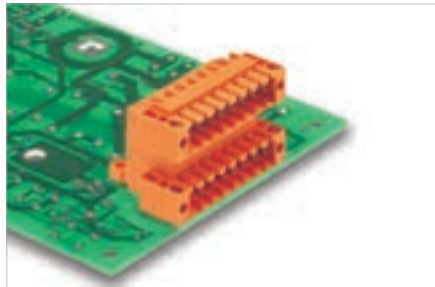

Double-level, angled male header (90° orientation) for wave soldering in 3.5 mm pitch. The male header is available in open, closed (G) and flange (F) versions.

Product data

IEC: 200 V / 10.5 A
UL: 300 V / 8 A



For additional articles and information, refer to catalog.weidmuller.com

Note:

- Additional variants on request
- Gold-plated contact surfaces on request
- Rated current related to rated cross-section & min. No. of poles.
- P on drawing = pitch
- Rated data refer only to the component itself. Clearance and creepage distances to other components are to be designed in accordance with the relevant application standards.
- Long term storage of the product with average temperature of 50 °C and average humidity 70%, 36 months

SLD 3.50/./90G

closed side

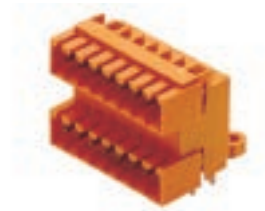

Dimensioned drawing

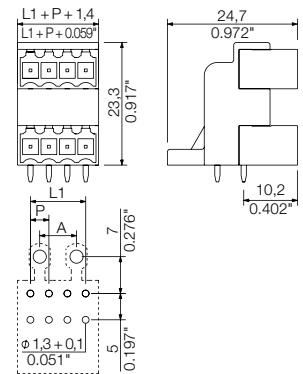

Technical data

In compliance with IEC 60664-1 / IEC 61984

Clamping range, max.			
Solid core H05(07) V-U			
Stranded H07 V-R			
Flexible H05(07) V-K			
Flexible with ferrule			
Ferrule with plastic collar			
Stripping length			
Screwdriver blade	mm		
According to norm			
Tightening torque range			
Rated current, max.	A	10.5	9
At ambient temperature		20°C	40°C
For conductor cross-section			
Overvoltage category		III	III II
Pollution severity		3	2 2
Rated voltage	V	125 160 200	
Rated impulse voltage	kV	2.5 2.5 2.5	
UL / CUL (Use Group)		B C D	
Rated voltage	V	300	300
Rated current	A	8	8
AWG conductor	AWG		-
CSA (Use Group)		B C D	
Rated voltage	V	300	300
Rated current	A	8	8
AWG conductor	AWG		-
General data			
Type of insulation material		PBT	
UL 94 flammability rating		V-0	
Contact base material		CuSn	
Material of contact surface		tinned	
Pin dimensions = d	mm	1.2, Octagonal	
Solder eyelet Ø = D	mm	1.4	
Solder eyelet Ø tolerance	mm	+ 0,1	

Accessories

Note: Refer to the Accessories chapter for additional accessories.

Coding		Order No.
	BL SL 3.5 KO OR	1693430000
	BL SL 3.5 KO SW	1610100000

Ordering data

Solder pin length		3.2 mm		
Colour		orange		
Pitch		3.50 mm		
Pol.	L1	(inch)	Qty.	Order No.
4	3.50	0.138	50	1633580000
6	7.00	0.276	50	1633590000
8	10.50	0.413	50	1633600000
10	14.00	0.551	50	1633610000
12	17.50	0.689	50	1633620000
14	21.00	0.827	20	1633630000
16	24.50	0.965	20	1633640000
18	28.00	1.102	20	1633650000
20	31.50	1.240	20	1633660000
22	35.00	1.378	10	1633670000
24	38.50	1.516	10	1633680000

J

3.50

90°

SLD 3.50/.. /90F

with screw flange



Dimensioned drawing

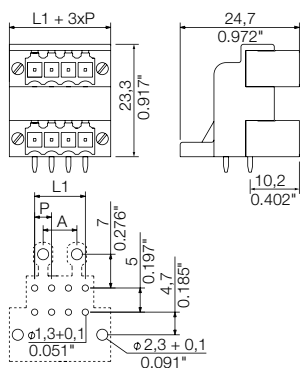

Ordering data

Solder pin length		3.2 mm	
Colour		orange	
Pitch		3.50 mm	
Pol.	L1	(inch)	Qty. Order No.
4	3.50	0.138	50 1633810000
6	7.00	0.276	50 1633820000
8	10.50	0.413	50 1633830000
10	14.00	0.551	50 1633840000
12	17.50	0.689	50 1633850000
14	21.00	0.827	20 1633860000
16	24.50	0.965	20 1633870000
18	28.00	1.102	20 1633880000
20	31.50	1.240	20 1633890000
22	35.00	1.378	10 1633900000
24	38.50	1.516	10 1633910000



Connectors in 3.50 mm pitch Series BL/SL 3.50

SLD 3.50V../90

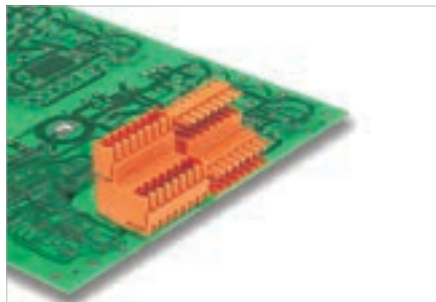

Double-level, staggered male header with angled 90° wire outlet for wave soldering in 3.5 mm pitch. The male header is available in open, closed (G) and flange (F) versions.

Technical data

In compliance with IEC 60664-1 / IEC 61984

Clamping range, max.			
Solid core H05(07) V-U			
Stranded H07 V-R			
Flexible H05(07) V-K			
Flexible with ferrule			
Ferrule with plastic collar			
Stripping length			
Screwdriver blade	mm		
According to norm			
Tightening torque range			
Rated current, max.	A	10.5	9
At ambient temperature		20°C	40°C
For conductor cross-section			
Overvoltage category		III	III II
Pollution severity		3	2 2
Rated voltage	V	125 160 200	
Rated impulse voltage	kV	2.5 2.5 2.5	
UL / CUL (Use Group)		B C D	
Rated voltage	V	300 300	
Rated current	A	8 8	
AWG conductor	AWG	-	
CSA (Use Group)		B C D	
Rated voltage	V	300	300
Rated current	A	8	8
AWG conductor	AWG	-	
General data			
Type of insulation material		PBT	
UL 94 flammability rating		V-0	
Contact base material		CuSn	
Material of contact surface		tinned	
Pin dimensions = d	mm	1.2, Octagonal	
Solder eyelet Ø = D	mm	1.4	
Solder eyelet Ø tolerance	mm	+ 0,1	

Product data

IEC: 200 V / 10.5 A

UL: 300 V / 8 A



For additional articles and information, refer to catalog.weidmueller.com

Note:

- Additional variants on request
- Rated current related to rated cross-section & min. No. of poles.
- Spacing between rows: see hole layout
- P on drawing = pitch
- Rated data refer only to the component itself. Clearance and creepage distances to other components are to be designed in accordance with the relevant application standards.
- Long term storage of the product with average temperature of 50 °C and average humidity 70%, 36 months

SLD 3.50V../90G

closed side



Dimensioned drawing

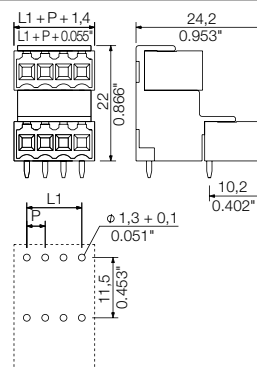

Accessories

Note: Refer to the Accessories chapter for additional accessories.

Coding		Order No.
	BL SL 3.5 KO OR	1693430000
	BL SL 3.5 KO SW	1610100000

Ordering data

Solder pin length		3.2 mm		
Colour		orange		
Pitch		3.50 mm		
Pol.	L1	(inch)	Qty.	Order No.
4	3.50	0.138	50	1642240000
6	7.00	0.276	50	1890600000
8	10.50	0.413	50	1642250000
10	14.00	0.551	50	1866770000
12	17.50	0.689	50	1642260000
14	21.00	0.827	20	1890610000
16	24.50	0.965	20	1642270000
18	28.00	1.102	20	1890620000
20	31.50	1.240	20	1642280000
22	35.00	1.378	10	1669650000
24	38.50	1.516	10	1642290000

SLD 3.50V../90F

with screw flange



Dimensioned drawing

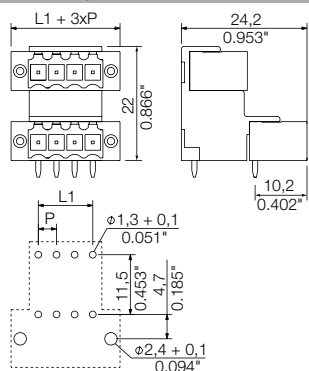

Ordering data

Solder pin length		3.2 mm	
Colour		orange	
Pitch		3.50 mm	
Pol.	L1	(inch)	Qty. Order No.
4	3.50	0.138	50 1642370000
6	7.00	0.276	50 1890790000
8	10.50	0.413	50 1642380000
10	14.00	0.551	50 1890800000
12	17.50	0.689	50 1642390000
14	21.00	0.827	20 1890810000
16	24.50	0.965	20 1642400000
18	28.00	1.102	20 1890820000
20	31.50	1.240	20 1642410000
22	35.00	1.378	10 1669660000
24	38.50	1.516	10 1642420000

Connectors in 3.50 mm pitch Series BL/SL 3.50

SLD 3.50V../180

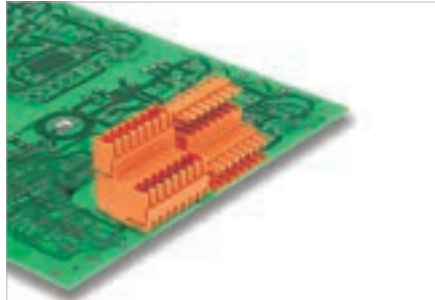

Double-level, staggered male header with straight 180° wire outlet for wave soldering in 3.5 mm pitch. The male header is available in closed (G) and flange (F) versions.

Technical data

In compliance with IEC 60664-1 / IEC 61984

Clamping range, max.			
Solid core H05(07) V-U			
Stranded H07 V-R			
Flexible H05(07) V-K			
Flexible with ferrule			
Ferrule with plastic collar			
Stripping length			
Screwdriver blade	mm		
According to norm			
Tightening torque range			
Rated current, max.	A	10.5	9
At ambient temperature		20°C	40°C
For conductor cross-section			
Overvoltage category		III	III II
Pollution severity		3	2 2
Rated voltage	V	125	160 200
Rated impulse voltage	kV	2.5	2.5 2.5
UL / CUL (Use Group)		B	C D
Rated voltage	V	300	300
Rated current	A	8	8
AWG conductor	AWG		-
CSA (Use Group)		B	C D
Rated voltage	V	300	300
Rated current	A	8	8
AWG conductor	AWG		-
General data			
Type of insulation material		PBT	
UL 94 flammability rating		V-0	
Contact base material		CuSn	
Material of contact surface		tinned	
Pin dimensions = d	mm	1.2, Octagonal	
Solder eyelet Ø = D	mm	1.4	
Solder eyelet Ø tolerance	mm	+ 0,1	

Product data

IEC: 200 V / 10.5 A
UL: 300 V / 8 A



For additional articles and information, refer to catalog.weidmuller.com

Note:

- Additional variants on request
- Rated current related to rated cross-section & min. No. of poles.
- Spacing between rows: see hole layout
- P on drawing = pitch
- Rated data refer only to the component itself. Clearance and creepage distances to other components are to be designed in accordance with the relevant application standards.
- Long term storage of the product with average temperature of 50 °C and average humidity 70%, 36 months

SLD 3.50V../180G

closed side



Dimensioned drawing

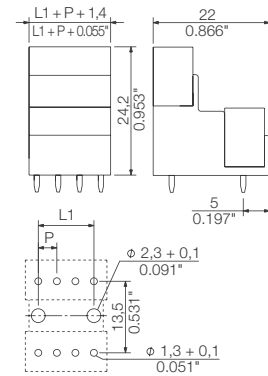

Accessories

Note: Refer to the Accessories chapter for additional accessories.

Coding	Order No.
BL SL 3.5 KO OR	1693430000
BL SL 3.5 KO SW	1610100000

Ordering data

Solder pin length		3.2 mm		
Colour		orange		
Pitch		3.50 mm		
Pol.	L1	(inch)	Qty.	Order No.
4	3.50	0.138	50	1641110000
6	7.00	0.276	50	1891190000
8	10.50	0.413	50	1641120000
10	14.00	0.551	50	1891200000
12	17.50	0.689	50	1641130000
16	24.50	0.965	20	1641140000
20	31.50	1.240	20	1641150000
24	38.50	1.516	10	1641160000

J

3.50

180°

SLD 3.50V../180F

with screw flange



Dimensioned drawing

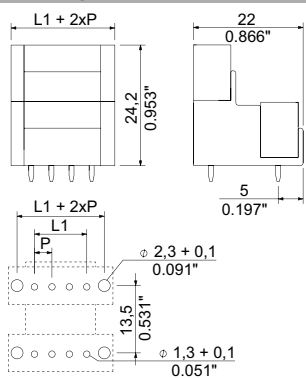

Ordering data

Solder pin length		3.2 mm		
Colour		orange		
Pitch		3.50 mm		
Pol.	L1	(inch)	Qty.	Order No.
4	3.50	0.138	50	1641240000
6	7.00	0.276	50	1891060000
8	10.50	0.413	50	1641250000
10	14.00	0.551	50	1891070000
12	17.50	0.689	50	1641260000
14	21.00	0.827	20	1891080000
16	24.50	0.965	20	1641270000
18	28.00	1.102	20	1891090000
20	31.50	1.240	20	1641280000
22	35.00	1.378	20	1891100000
24	38.50	1.516	10	1641290000

BL 3.50/././180

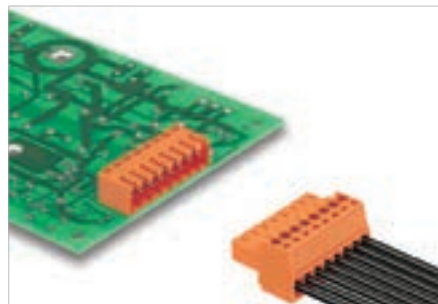

Female plug with clamping-yoke screw system for connecting wires with straight outlet direction in 3.5 mm pitch. Available with a screw flange (F), release lever (LH) or lock and release lever (LR). They include space for labelling and can be coded.

Technical data

In compliance with IEC 60664-1 / IEC 61984			
Clamping range, max.	mm ²	0.08...1.5	
Solid core H05(07) V-U	mm ²	0.2...1.5	
Stranded H07 V-R			
Flexible H05(07) V-K	mm ²	0.2...1.5	
Flexible with ferrule	mm ²	0.2...1.5	
Ferrule with plastic collar	mm ²	0.2...1.5	
Stripping length	mm	6	
Screwdriver blade	mm	0.4 x 2.5	
		According to norm	
Tightening torque range			
Rated current, max.	A	17	14.5
At ambient temperature		20°C	40°C
For conductor cross-section	mm ²	1.5	
Overvoltage category		III	III II
Pollution severity		3	2 2
Rated voltage	V	160	160 320
Rated impulse voltage	kV	2.5	2.5 2.5
UL / CUL (Use Group)		B	C D
Rated voltage	V	300	300
Rated current	A	10	10
AWG conductor	AWG	28-14	
CSA (Use Group)		B	C D
Rated voltage	V	300	300
Rated current	A	10	10
AWG conductor	AWG	28-14	
General data			
Type of insulation material		PBT	
UL 94 flammability rating		V-0	
Contact base material		Copper alloy	
Material of contact surface		tinned	
Pin dimensions = d	mm		
Solder eyelet Ø = D	mm		
Solder eyelet Ø tolerance	mm		

Product data

IEC: 320 V / 17 A / 0.2 - 1.5 mm²
UL: 300 V / 10 A / AWG 28 - 14



For additional articles and information, refer to catalog.weidmueller.com

Note:

- Additional variants on request
- Gold-plated contact surfaces on request
- Rated current related to rated cross-section & min. No. of poles.
- Max. outer diameter of the conductor: 2.9 mm
- Wire end ferrule without plastic collar to DIN 46228/1
- Wire end ferrule with plastic collar to DIN 46228/4
- P on drawing = pitch
- Rated data refer only to the component itself. Clearance and creepage distances to other components are to be designed in accordance with the relevant application standards.
- Long term storage of the product with average temperature of 50 °C and average humidity 70%, 36 months

BL 3.50/././180

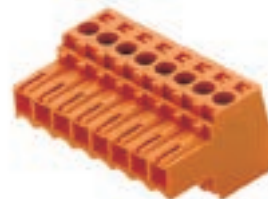

Dimensioned drawing

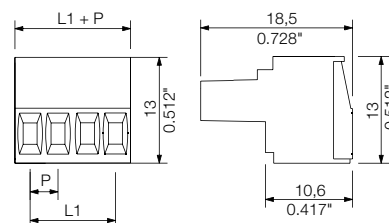

Accessories

Note: Refer to the Accessories chapter for additional accessories.

Coding	Order No.
BL SL 3.5 KO OR	1693430000
BL SL 3.5 KO SW	1610100000
Hood	
BL 3.50 AH03 BK BX	1745580000
BL 3.50 AH04 BK BX	1745590000
BL 3.50 AH05 BK BX	1745600000
BL 3.50 AH06 BK BX	1745610000
BL 3.50 AH07 BK BX	1745620000
BL 3.50 AH08 BK BX	1745630000
BL 3.50 AH09 BK BX	1745640000
BL 3.50 AH10 BK BX	1745650000
BL 3.50 AH11 BK BX	1745660000
BL 3.50 AH12 BK BX	1745670000
BL 3.50 AH13 BK BX	1745680000
BL 3.50 AH14 BK BX	1745690000
BL 3.50 AH15 BK BX	1745700000
BL 3.50 AH16 BK BX	1745710000
Strain relief	
BL 3.50 ZE03 OR BX	1629680000
BL 3.50 ZE03 BK BX	1627820000
BL 3.50 ZE08 OR BX	1629690000
Interlock	
BL/SL 3.50 VR OR BX	1669310000
BL/SL 3.50 VR BK BX	1669300000
Screwdriver	
SDS 0.4X2.5X75	2749320000
SDIS 0.4X2.5X75	2749790000

Ordering data

Solder pin length				
Colour	orange			
Pitch	3.50 mm			
Pol.	L1	(inch)	Qty.	Order No.
2	3.50	0.138	264	1597360000
3	7.00	0.276	174	1597370000
4	10.50	0.413	132	1597380000
5	14.00	0.551	102	1597390000
6	17.50	0.689	84	1597400000
7	21.00	0.827	72	1597410000
8	24.50	0.965	66	1597420000
9	28.00	1.102	54	1597430000
10	31.50	1.240	48	1597440000
11	35.00	1.378	48	1597450000
12	38.50	1.516	42	1597460000

Representative deratings curve

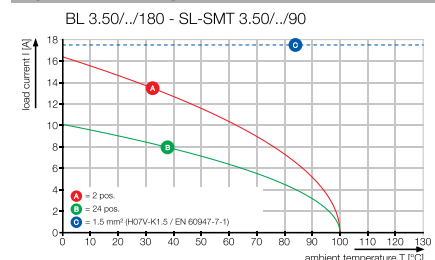

BL 3.50/././180F

with screw flange



Dimensioned drawing

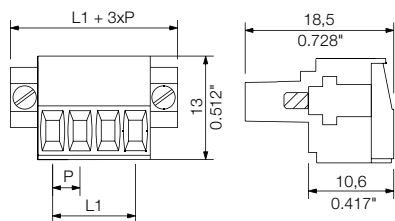

Ordering data

Solder pin length					
Colour		orange			
Pitch		3.50 mm			
Pol.	L1	(inch)	Qty.	Order No.	
2	3.50	0.138	132	1606640000	
3	7.00	0.276	102	1606650000	
4	10.50	0.413	84	1606660000	
5	14.00	0.551	72	1606670000	
6	17.50	0.689	66	1606680000	
7	21.00	0.827	54	1606690000	
8	24.50	0.965	48	1606700000	
9	28.00	1.102	48	1606710000	
10	31.50	1.240	42	1606720000	
11	35.00	1.378	36	1606730000	
12	38.50	1.516	36	1606740000	

BL 3.50/././180LR

with release latch



Dimensioned drawing

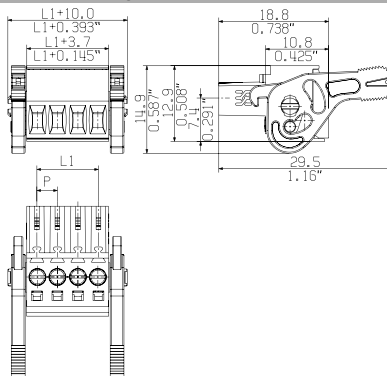

Ordering data

Solder pin length					
Colour		orange			
Pitch		3.50 mm			
Pol.	L1	(inch)	Qty.	Order No.	
2	3.50	0.138	132	1530990000	
3	7.00	0.276	102	1531000000	
4	10.50	0.413	84	1531010000	
5	14.00	0.551	72	1531020000	
6	17.50	0.689	66	1531030000	
7	21.00	0.827	54	1531040000	
8	24.50	0.965	48	1531050000	
9	28.00	1.102	48	1531070000	
10	31.50	1.240	42	1531080000	
11	35.00	1.378	36	1531090000	
12	38.50	1.516	36	1531100000	

J

Additional deratings curves

BL 3.50/././180 - SLD 3.50/././90

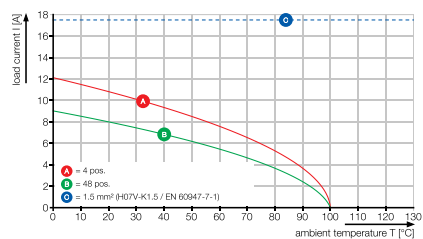

BL 3.50/././180 - SL 3.50/././90

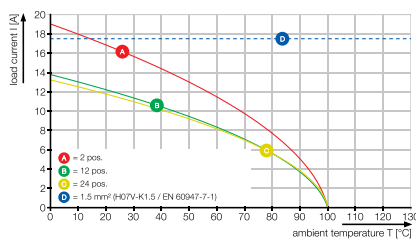

Connectors in 3.50 mm pitch Series BL/SL 3.50

BL 3.50/..../90 & 270

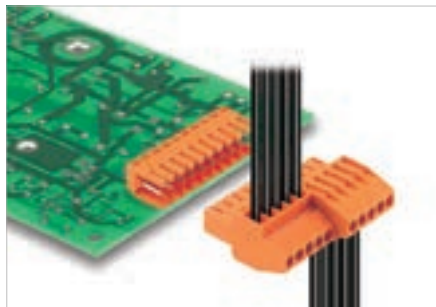

Female plug with clamping-yoke screw system for connecting wires with 90° and 270° angled orientation in 3.5 mm pitch. The female plugs are also available with a screw flange (F). They include space for labelling and can be coded.

Technical data

In compliance with IEC 60664-1 / IEC 61984

Clamping range, max.	mm ²	0.08...1.5
Solid core H05(07) V-U	mm²	0.2...1.5
Stranded H07 V-R		
Flexible H05(07) V-K	mm ²	0.2...1.5
Flexible with ferrule	mm ²	0.2...1.5
Ferrule with plastic collar	mm ²	0.2...1.5
Stripping length	mm	6
Screwdriver blade	mm	0.4 x 2.5
According to norm		DIN 5264

Tightening torque range		
Rated current, max.	A	12 10
At ambient temperature	20°C	40°C

For conductor cross-section	mm ²	1.5
Overtolerance category		III III II
Pollution severity		3 2 2

Rated voltage	V	160 160 320
Rated impulse voltage	kV	2.5 2.5 2.5

UL / CUL (Use Group)

Rated voltage	V	300 300
Rated current	A	8 8
AWG conductor	AWG	28-14

CSA (Use Group)

Rated voltage	V	300 300
Rated current	A	10 10
AWG conductor	AWG	28-14

General data

Type of insulation material		PBT
UL 94 flammability rating		V-0
Contact base material		Copper alloy
Material of contact surface		tinned
Pin dimensions = d	mm	
Solder eyelet Ø = D	mm	
Solder eyelet Ø tolerance	mm	

Product data

IEC: 320 V / 12 A / 0.2 - 1.5 mm²
UL: 300 V / 8 A / AWG 28 - 14



For additional articles and information, refer to catalog.weidmueller.com

Note:

- Additional variants on request
- Gold-plated contact surfaces on request
- Rated current related to rated cross-section & min. No. of poles.
- Max. outer diameter of the conductor: 2.9 mm
- Wire end ferrule without plastic collar to DIN 46228/1
- Wire end ferrule with plastic collar to DIN 46228/4
- P on drawing = pitch
- Rated data refer only to the component itself. Clearance and creepage distances to other components are to be designed in accordance with the relevant application standards.
- Long term storage of the product with average temperature of 50 °C and average humidity 70%, 36 months

BL 3.50/..../90



Dimensioned drawing

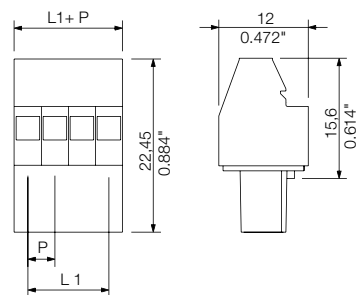

Accessories

Note: Refer to the Accessories chapter for additional accessories.

Coding		Order No.
	BL SL 3.5 KO OR	1693430000
	BL SL 3.5 KO SW	1610100000
Screwdriver		
	SDS 0.4X2.5X75	2749320000
	SDIS 0.4X2.5X75	2749790000

Ordering data

Solder pin length				
Colour	orange			
Pitch	3.50 mm			
Pol.	L1	(inch)	Qty.	Order No.
2	3.50	0.138	258	1638550000
3	7.00	0.276	174	1638560000
4	10.50	0.413	132	1638570000
5	14.00	0.551	102	1638580000
6	17.50	0.689	84	1638590000
7	21.00	0.827	72	1638600000
8	24.50	0.965	66	1638610000
9	28.00	1.102	54	1638620000
10	31.50	1.240	48	1638630000
11	35.00	1.378	48	1638640000
12	38.50	1.516	42	1638650000

Representative deratings curve

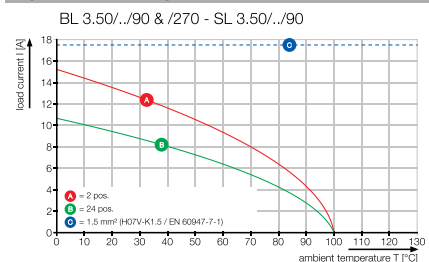

BL 3.50/./90F

with screw flange



Dimensioned drawing

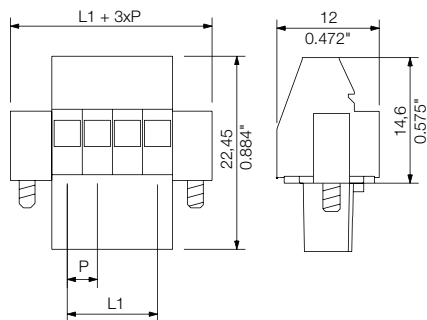

Ordering data

Solder pin length					
Colour		orange			
Pitch 3.50 mm					
Pol.	L1	(inch)	Qty.	Order No.	
2	3.50	0.138	132	1639010000	
3	7.00	0.276	108	1639020000	
4	10.50	0.413	90	1639030000	
5	14.00	0.551	72	1639040000	
6	17.50	0.689	66	1639050000	
7	21.00	0.827	60	1639060000	
8	24.50	0.965	54	1639070000	
9	28.00	1.102	48	1639080000	
10	31.50	1.240	42	1639090000	
11	35.00	1.378	36	1639100000	
12	38.50	1.516	36	1639110000	

BL 3.50/./270

with screw flange



Dimensioned drawing

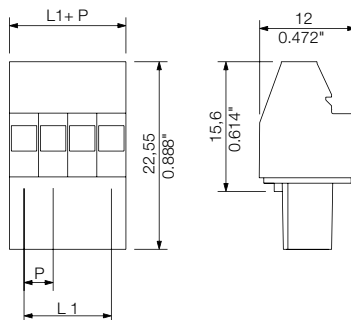

Ordering data

Solder pin length					
Colour		orange			
Pitch 3.50 mm					
Pol.	L1	(inch)	Qty.	Order No.	
2	3.50	0.138	258	1639470000	
3	7.00	0.276	174	1639480000	
4	10.50	0.413	132	1639490000	
5	14.00	0.551	102	1639500000	
6	17.50	0.689	84	1639510000	
7	21.00	0.827	72	1639520000	
8	24.50	0.965	66	1639530000	
9	28.00	1.102	54	1639540000	
10	31.50	1.240	48	1639550000	
11	35.00	1.378	48	1639560000	
12	38.50	1.516	42	1639570000	

BL 3.50/./270F

with screw flange



Dimensioned drawing

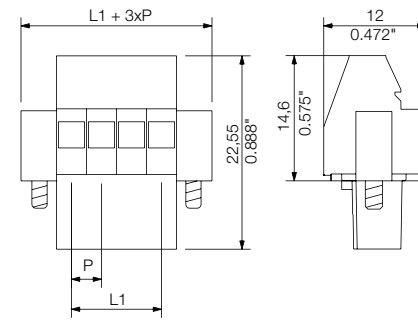

Ordering data

Solder pin length					
Colour		orange			
Pitch 3.50 mm					
Pol.	L1	(inch)	Qty.	Order No.	
2	3.50	0.138	132	1639930000	
3	7.00	0.276	108	1639940000	
4	10.50	0.413	90	1639950000	
5	14.00	0.551	72	1639960000	
6	17.50	0.689	66	1639970000	
7	21.00	0.827	60	1639980000	
8	24.50	0.965	54	1639990000	
9	28.00	1.102	48	1640000000	
10	31.50	1.240	42	1640010000	
11	35.00	1.378	36	1640020000	
12	38.50	1.516	36	1640030000	

BL-I/O 3.5/./180

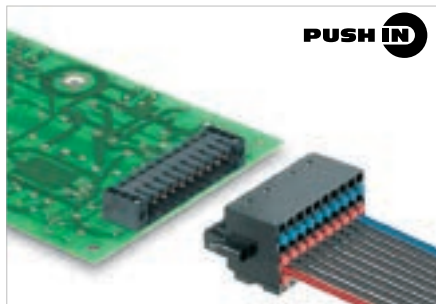

Female plug provides pluggable connection level for decentralized I/O electronics. It is used together with male headers in 3.5 mm pitch. Available with a screw flange (F) or a lock and release lever (LR).

Technical data

In compliance with IEC 60664-1 / IEC 61984			
Clamping range, max.	mm ²	0.2...1.5	
Solid core H05(07) V-U	mm²	0.2...1.5	
Stranded H07 V-R			
Flexible H05(07) V-K	mm ²	0.2...1.5	
Flexible with ferrule	mm ²	0.2...1	
Ferrule with plastic collar	mm ²	0.2...0.75	
Stripping length	mm	8	
Screwdriver blade	mm	0.4 x 2.5	
		According to norm	
Tightening torque range			
Rated current, max.	A	2.2	2.2
At ambient temperature		20°C	40°C
For conductor cross-section	mm ²	1	
Overvoltage category		III	III II
Pollution severity		3	2 2
Rated voltage	V	50	160 200
Rated impulse voltage	kV	0.8	2.5 2.5
UL / CUL (Use Group)		B	C D
Rated voltage	V	50	50
Rated current	A	5	5
AWG conductor	AWG	24-16	
CSA (Use Group)		B	C D
Rated voltage	V	50	50
Rated current	A	5	5
AWG conductor	AWG	22-16	
General data			
Type of insulation material		PBT	
UL 94 flammability rating		V-0	
Contact base material		Copper alloy	
Material of contact surface		tinned	
Pin dimensions = d	mm		
Solder eyelet Ø = D			
Solder eyelet Ø tolerance	mm		

Product data

IEC: 200 V / 2.2 A / 0.2 - 1.5 mm²
UL: 50 V / 5 A / AWG 24 - 16



For additional articles and information, refer to catalog.weidmuller.com

Note:

- Additional variants on request
- P on drawing = pitch
- Crimp form A for wire end ferrules with PZ 6/5 crimping tool are recommended for the largest cable sizes.
- Total load-carrying capacity of the potential bridges when feeding with 1.5 mm² is max. 17.5 A (so the capacity is 2.18 A for poles 2 through 9)
- Wire end ferrule without plastic collar to DIN 46228/1
- Wire end ferrule with plastic collar to DIN 46228/4
- Conductor < 0.2 mm² tinned
- Max. outer diameter of the conductor: 2.9 mm
- Rated data refer only to the component itself. Clearance and creepage distances to other components are to be designed in accordance with the relevant application standards.
- Long term storage of the product with average temperature of 50 °C and average humidity 70%, 36 months

BL-I/O 3.50/10/180F

with screw flange



Dimensioned drawing

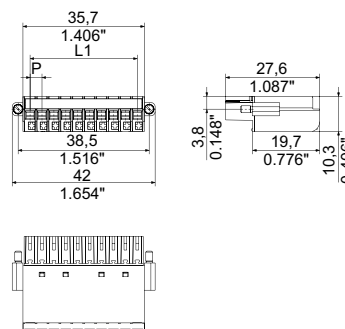

Accessories

Note: Refer to the Accessories chapter for additional accessories.

Coding		Order No.
	BL SL 3.5 KO OR	1693430000
	BL SL 3.5 KO SW	1610100000
Screwdriver		
	SDS 0.4X2.5X75	2749320000
	SDIS 0.4X2.5X75	2749790000
Pressing tool		
	PZ 6/5	9011460000
	PZ 1.5	9005990000

Ordering data

Solder pin length						
Colour		Light Grey	black			
Pitch	3.50 mm					
Pol.	L1	(inch)	Qty.	Order No.	Order No.	
10	31.50	1.240	20	1871690000	1779880000	

Representative deratings curve

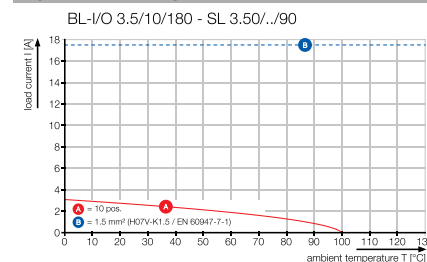

BL-I/O 3.50/10/180LR

with release latch



Dimensioned drawing

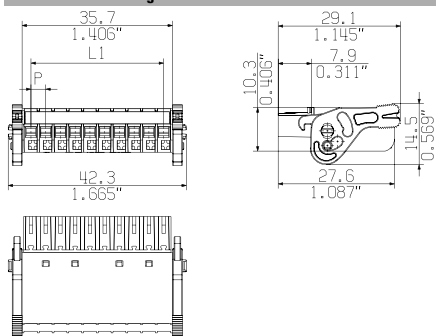

Ordering data

Solder pin length					
Colour					black
Pitch 3.50 mm					
Pol.	L1	(inch)	Qty.	Order No.	
10	31.50	1.240	20	1531180000	

BL-I/O 3.50/30/180F

with screw flange



Dimensioned drawing

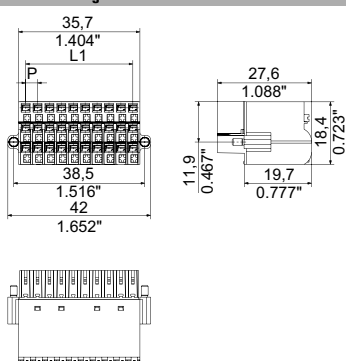

Ordering data

Solder pin length					
Colour					black
Pitch 3.50 mm					
Pol.	L1	(inch)	Qty.	Order No.	
30	31.50	1.240	20	1779920000	

BL-I/O 3.50/30/180LR

with release latch



Dimensioned drawing

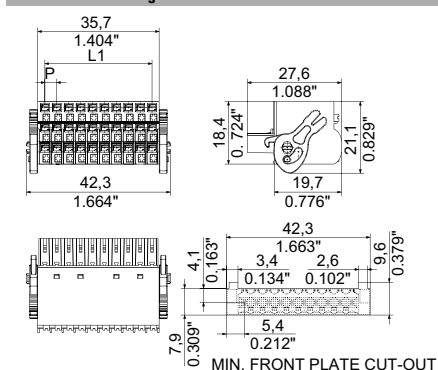

Ordering data

Solder pin length					
Colour					black
Pitch 3.50 mm					
Pol.	L1	(inch)	Qty.	Order No.	
30	31.50	1.240	20	1000550000	

Compatible with SL-SMT 3.50/.../90RF

Additional deratings curves

BL-I/O 3.50/30/180 - SL 3.50/.../90

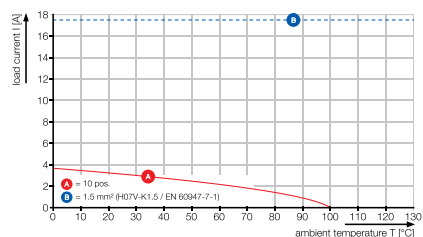

Connectors in 3.50 mm pitch Series BL/SL 3.50

BL-I/O 3.50/./180 PNP LED

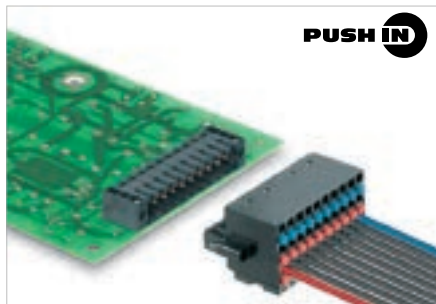

Female plug provides pluggable connection level with common minus (PNP sensor) for decentralized I/O electronics with integrated LED display; used together with male headers in 3.5 mm pitch. Available with a screw flange (F) or a lock an release lever (LR).

Technical data

In compliance with IEC 60664-1 / IEC 61984			
Clamping range, max.	mm ²	0.2...1.5	
Solid core H05(07) V-U	mm²	0.2...1.5	
Stranded H07 V-R			
Flexible H05(07) V-K	mm ²	0.2...1.5	
Flexible with ferrule	mm ²	0.2...1	
Ferrule with plastic collar	mm ²	0.2...0.75	
Stripping length	mm	8	
Screwdriver blade	mm	0.4 x 2.5	
		According to norm	
Tightening torque range			
Rated current, max.	A	2.2	2.2
At ambient temperature		20°C	40°C
For conductor cross-section	mm ²	1	
Overvoltage category		III	III II
Pollution severity		3	2 2
Rated voltage		50	
Rated impulse voltage		0.8	
UL / CUL (Use Group)	B C D		
Rated voltage	V	50	50
Rated current	A	5	5
AWG conductor	AWG	24-16	
CSA (Use Group)	B C D		
Rated voltage	V	50	50
Rated current	A	5	5
AWG conductor	AWG	22-16	
General data			
Type of insulation material		PBT	
UL 94 flammability rating		V-0	
Contact base material		Copper alloy	
Material of contact surface		tinned	
Pin dimensions = d	mm		
Solder eyelet Ø = D	mm		
Solder eyelet Ø tolerance	mm		

Product data

IEC: / 2.2 A / 0.2 - 1.5 mm²
UL: 50 V / 5 A / AWG 24 - 16



For additional articles and information, refer to catalog.weidmueller.com

Note:

- Additional variants on request
- P on drawing = pitch
- Crimp shape A for wire-end ferrules with crimping tools PZ 1,5 (order no. 9005990000) or PZ 6/5 (order no. 9011460000) for larger wire cross-sections recommended.
- Total load-carrying capacity of the potential bridges when feeding with 1.5 mm² is max. 17.5 A (so the capacity is 2.18 A for poles 2 through 9)
- Wire end ferrule without plastic collar to DIN 46228/1
- Wire end ferrule with plastic collar to DIN 46228/4
- Conductor < 0.2 mm² tinned
- Max. outer diameter of the conductor: 2.9 mm
- Rated data refer only to the component itself. Clearance and creepage distances to other components are to be designed in accordance with the relevant application standards.
- Long term storage of the product with average temperature of 50 °C and average humidity 70%, 36 months

Accessories

Note: Refer to the Accessories chapter for additional accessories.

Coding		Order No.
	BL SL 3.5 KO OR	1693430000
	BL SL 3.5 KO SW	1610100000
Screwdriver		
	SDS 0.4X2.5X75	2749320000
	SDIS 0.4X2.5X75	2749790000
Pressing tool		
	PZ 6/5	9011460000
	PZ 1.5	9005990000

BL-I/O 3.50/10/180F PNP LED

with screw flange



Dimensioned drawing

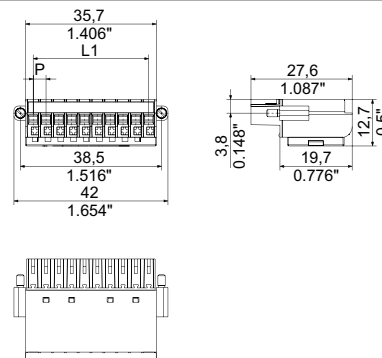

Ordering data

Solder pin length					
Colour	Light Grey		black		
Pitch	3.50 mm				
Pol.	L1	(inch)	Qty.	Order No.	Order No.
10	31.50	1.240	20	1965940000	1789090000

LED series resistors designed for 24 V

Representative deratings curve

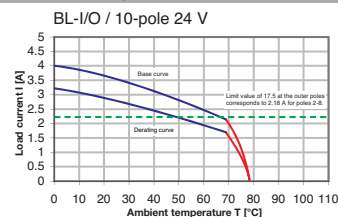

LED series resistors designed for 24 V

BL-I/O 3.50/10/180LR PNP LED

with release latch



Dimensioned drawing

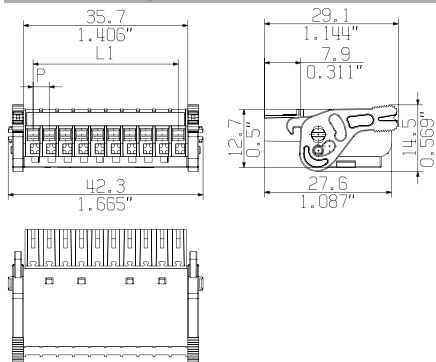

Ordering data

Solder pin length					
Colour					black
Pitch 3.50 mm					
Pol.	L1	(inch)	Qty.	Order No.	
10	31.50	1.240	20	1531190000	

BL-I/O 3.50/30/180F PNP LED

with screw flange



Dimensioned drawing

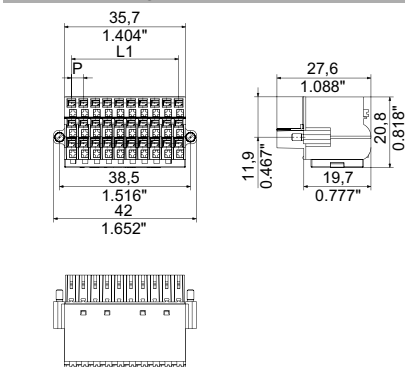

Ordering data

Solder pin length						
Colour					Light Grey	black
Pitch 3.50 mm						
Pol.	L1	(inch)	Qty.	Order No.	Order No.	
30	31.50	1.240	20	1965970000	1789110000	

BL-I/O 3.50/30/180LR PNP LED

with release latch



Dimensioned drawing

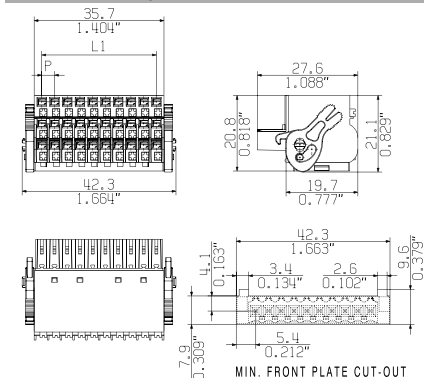

Ordering data

Solder pin length					
Colour					black
Pitch 3.50 mm					
Pol.	L1	(inch)	Qty.	Order No.	
30	31.50	1.240	20	1000570000	

LED series resistors configured for 24V; compatible with SL-SMT 3.50 /./ 90RF

LED series resistors designed for 24 V

LED series resistors designed for 24 V

Additional deratings curves

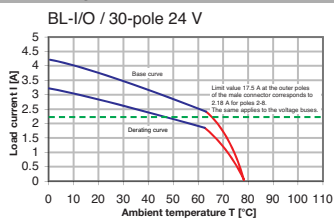

Connectors in 3.50 mm pitch Series BL/SL 3.50

BL-I/O 3.50/./180 NPN LED

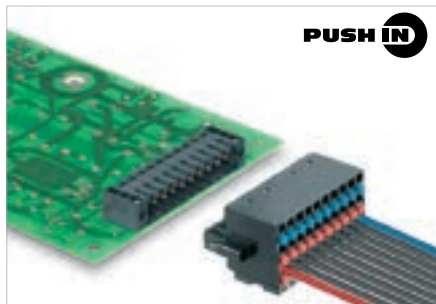

Female plug provides pluggable connection level with common positive (NPN sensor) for decentralized I/O electronics with integrated LED display; used together with male headers in 3.5 mm pitch. Available with a screw flange (F) or a lock an release lever (LR).

Technical data

In compliance with IEC 60664-1 / IEC 61984			
Clamping range, max.	mm ²	0.2...1.5	
Solid core H05(07) V-U	mm²	0.2...1.5	
Stranded H07 V-R			
Flexible H05(07) V-K	mm ²	0.2...1.5	
Flexible with ferrule	mm ²	0.2...1	
Ferrule with plastic collar	mm ²	0.2...0.75	
Stripping length	mm	8	
Screwdriver blade	mm	0.4 x 2.5	
		According to norm	
Tightening torque range			
Rated current, max.	A	2.2	2.2
At ambient temperature		20°C	40°C
For conductor cross-section	mm ²	1	
Overvoltage category		III	III II
Pollution severity		3	2 2
Rated voltage		50	
Rated impulse voltage		0.8	
UL / CUL (Use Group)	B C D		
Rated voltage	V	50	50
Rated current	A	5	5
AWG conductor	AWG	24-16	
CSA (Use Group)	B C D		
Rated voltage	V	50	50
Rated current	A	5	5
AWG conductor	AWG	22-16	
General data			
Type of insulation material		PBT	
UL 94 flammability rating		V-0	
Contact base material		Copper alloy	
Material of contact surface		tinned	
Pin dimensions = d	mm		
Solder eyelet Ø = D	mm		
Solder eyelet Ø tolerance	mm		

Product data

IEC: / 2.2 A / 0.2 - 1.5 mm²
UL: 50 V / 5 A / AWG 24 - 16



For additional articles and information, refer to catalog.weidmuller.com

Note:

- Additional variants on request
- P on drawing = pitch
- Crimp form A for wire end ferrules with PZ 6/5 crimping tool are recommended for the largest cable sizes.
- Total load-carrying capacity of the potential bridges when feeding with 1.5 mm² is max. 17.5 A (so the capacity is 2.18 A for poles 2 through 9)
- Wire end ferrule without plastic collar to DIN 46228/1
- Wire end ferrule with plastic collar to DIN 46228/4
- Conductor < 0.2 mm² tinned
- Max. outer diameter of the conductor: 2.9 mm
- Rated data refer only to the component itself. Clearance and creepage distances to other components are to be designed in accordance with the relevant application standards.
- Long term storage of the product with average temperature of 50 °C and average humidity 70%, 36 months

BL-I/O 3.50/10/180F NPN LED

with screw flange



Dimensioned drawing

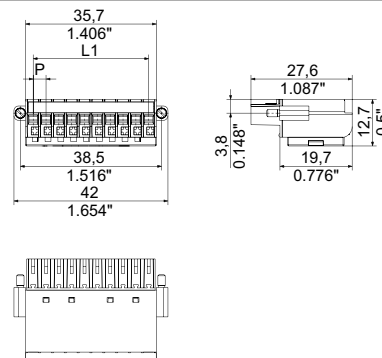

Accessories

Note: Refer to the Accessories chapter for additional accessories.

Coding		Order No.
	BL SL 3.5 KO OR	1693430000
	BL SL 3.5 KO SW	1610100000
Screwdriver		
	SDS 0.4X2.5X75	2749320000
	SDIS 0.4X2.5X75	2749790000
Pressing tool		
	PZ 6/5	9011460000
	PZ 1.5	9005990000

Ordering data

Solder pin length				
Colour	black			
Pitch	3.50 mm			
Pol.	L1	(inch)	Qty.	Order No.
10	31.50	1.240	20	1938010000

LED series resistors designed for 24 V

Representative deratings curve

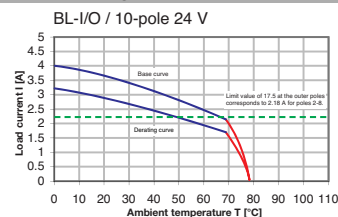

LED series resistors designed for 24 V

BL-I/O 3.50/10/180LR NPN LED

with release latch



Dimensioned drawing

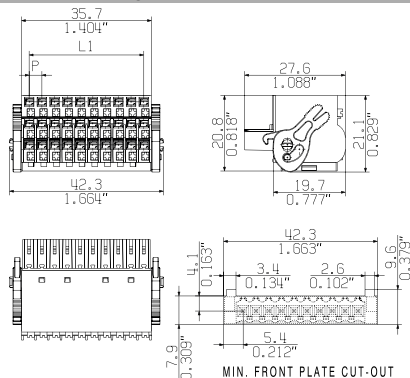

Ordering data

Solder pin length					
Colour	black				
Pitch	3.50 mm				
Pol.	L1	(inch)	Qty.	Order No.	
10	31.50	1.240	20	1531200000	

BL-I/O 3.50/30/180F NPN LED

with screw flange



Dimensioned drawing

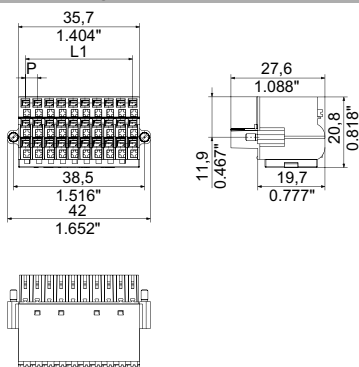

Ordering data

Solder pin length					
Colour	black				
Pitch	3.50 mm				
Pol.	L1	(inch)	Qty.	Order No.	
30	31.50	1.240	20	1938020000	

BL-I/O 3.50/30/180LR NPN LED

with release latch



Dimensioned drawing

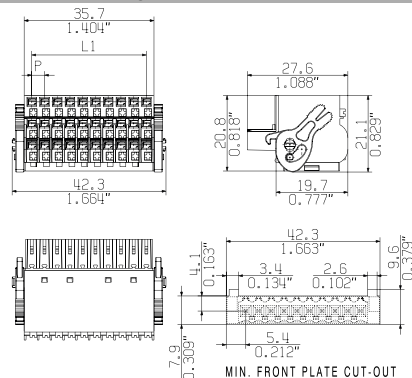

Ordering data

Solder pin length					
Colour	black				
Pitch	3.50 mm				
Pol.	L1	(inch)	Qty.	Order No.	
30	31.50	1.240	20	1000590000	

LED series resistors configured for 24V; compatible with SL-SMT 3.50 / ./ 90RF

LED series resistors designed for 24 V

LED series resistors designed for 24 V

Additional deratings curves

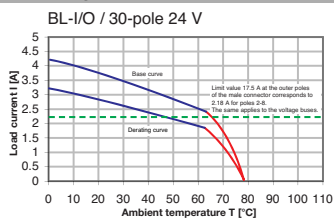

Connectors in 3.50 mm pitch Series BL/SL 3.50

BL I/O 3.50../180 CJC



Many industrial applications demand an increasingly higher accuracy of temperature measurement. At the same time, the required equipment must become cheaper and smaller. For the BL I/O 3.5 CJC, the cold junction compensation is integrated into the connector, which reduces space and costs.

The cold junction compensation of the BL I/O CJC is integrated by a thermistor in the connector. Therefore, no additional compensation is needed when connecting thermocouples to a device to measure the temperature. The integrated compensation simplifies the device and increases the measuring accuracy up to 20%.

Technical data

In compliance with IEC 60664-1 / IEC 61984

Clamping range, max.	mm ²	0.2...1.5
Solid core H05(07) V-U	mm²	0.2...1.5
Stranded H07 V-R		
Flexible H05(07) V-K	mm ²	0.2...1.5
Flexible with ferrule	mm ²	0.2...1
Ferrule with plastic collar	mm ²	0.2...0.75
Stripping length	mm	8
Screwdriver blade	mm	0.4 x 2.5
According to norm		DIN 5264

Tightening torque range			
Rated current, max.	A	2.2	2.2
At ambient temperature		20°C	40°C
For conductor cross-section	mm ²	1	
Overvoltage category		III	III II
Pollution severity		3	2 2
Rated voltage		50	
Rated impulse voltage		0.8	

UL / CUL (Use Group)	B	C	D
Rated voltage	V	50	50
Rated current	A	5	5
AWG conductor	AWG	24-16	
CSA (Use Group)	B	C	D
Rated voltage	V	50	50
Rated current	A	5	5
AWG conductor	AWG	22-16	

General data	
Type of insulation material	PBT
UL 94 flammability rating	V-0
Contact base material	Copper alloy
Material of contact surface	Gold-plated
Pin dimensions = d	mm
Solder eyelet Ø = D	
Solder eyelet Ø tolerance	mm

Product data

IEC: / 2.2 A / 0.2 - 1.5 mm²
UL: 50 V / 5 A / AWG 24 - 16



For additional articles and information, refer to catalog.weidmueller.com

Note:

- Additional variants on request
- P on drawing = pitch
- Crimp form A for wire end ferrules with PZ 6/5 crimping tool are recommended for the largest cable sizes.
- Total load-carrying capacity of the potential bridges when feeding with 1.5 mm² is max. 17.5 A (so the capacity is 2.18 A for poles 2 through 9)
- Wire end ferrule without plastic collar to DIN 46228/1
- Wire end ferrule with plastic collar to DIN 46228/4
- Conductor < 0.2 mm² tinned
- Max. outer diameter of the conductor: 2.9 mm
- Rated data refer only to the component itself. Clearance and creepage distances to other components are to be designed in accordance with the relevant application standards.
- Long term storage of the product with average temperature of 50 °C and average humidity 70%, 36 months

BL I/O 3.5 CJC



Dimensioned drawing

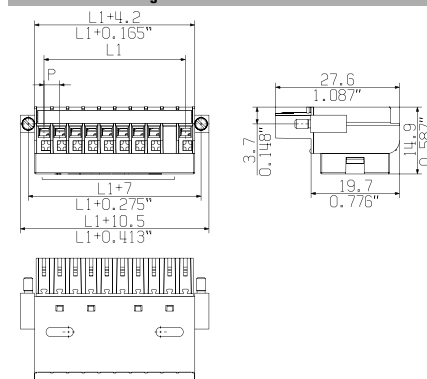

Accessories

Note: Refer to the Accessories chapter for additional accessories.

Coding		Order No.
	BL SL 3.5 KO OR	1693430000
	BL SL 3.5 KO SW	1610100000
Screwdriver		
	SDS 0.4X2.5X75	2749320000
	SDIS 0.4X2.5X75	2749790000
Pressing tool		
	PZ 6/5	9011460000
	PZ 1.5	9005990000

Ordering data

Solder pin length				
Colour	black			
Pitch	3.50 mm			
Pol.	L1	(inch)	Qty.	Order No.
10	31.50	1.240	20	2471390000

BL-I/O 3.50/./180

BL-I/O 3.5 30-pin

- Pluggable connection terminals for remote I/O electronics
- Directly from the control or industrial PC etc. to the sensor or actuator level
- Significant space savings as well as savings in design time and wiring.

BL-I/O 3.50/./180 PNP LED

BL-I/O 3.5 30-pin

- Pluggable connection terminals for remote I/O electronics
- Directly from the control or industrial PC etc. to the sensor or actuator level
- Significant space savings as well as savings in design time and wiring.

BL-I/O 3.50/./180 NPN LED

BL-I/O 3.5 30-pin

- Pluggable connection terminals for remote I/O electronics
- Directly from the control or industrial PC etc. to the sensor or actuator level
- Significant space savings as well as savings in design time and wiring.

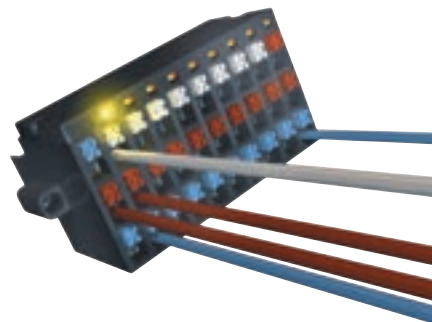
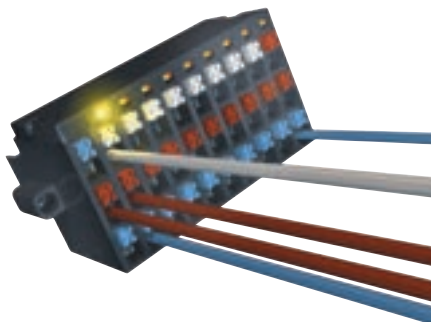

Integrated LED version

- Available for all the BL-I/Os
- Test the sensor or actuator cabling before commissioning the controller
- Eliminates the need for function displays in the housing

Integrated LED version

- Available for all the BL-I/Os
- Test the sensor or actuator cabling before commissioning the controller
- Eliminates the need for function displays in the housing

Diagram of BL-I/O 30 pin with SL 3.5 10 pin

- Direct connection possibilities for sensors and actuators including their power supply
- Can be used for external or internal power supply sources

Diagram of BL-I/O 30 pin with SL 3.5 10 pin

- Direct connection possibilities for sensors and actuators including their power supply
- Can be used for external or internal power supply sources

Diagram of BL-I/O 30 pin with SL 3.5 10 pin

- Direct connection possibilities for sensors and actuators including their power supply
- Can be used for external or internal power supply sources

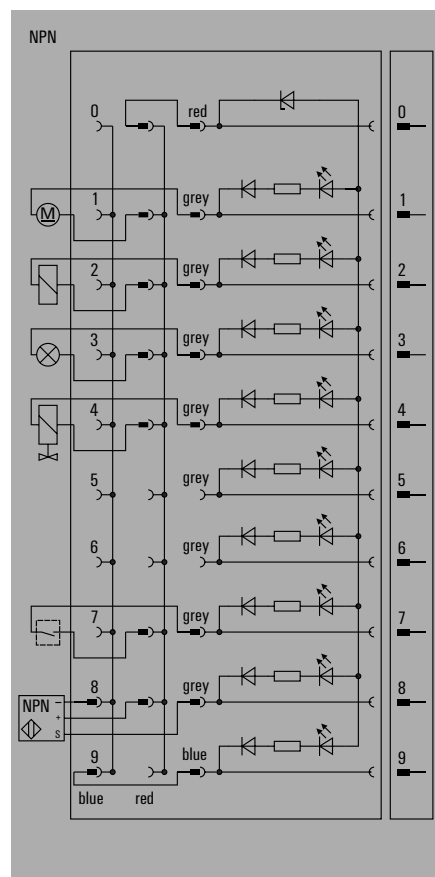
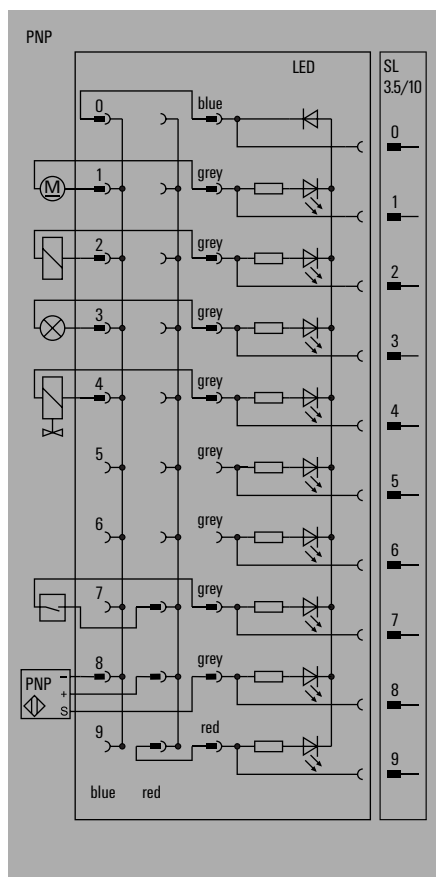
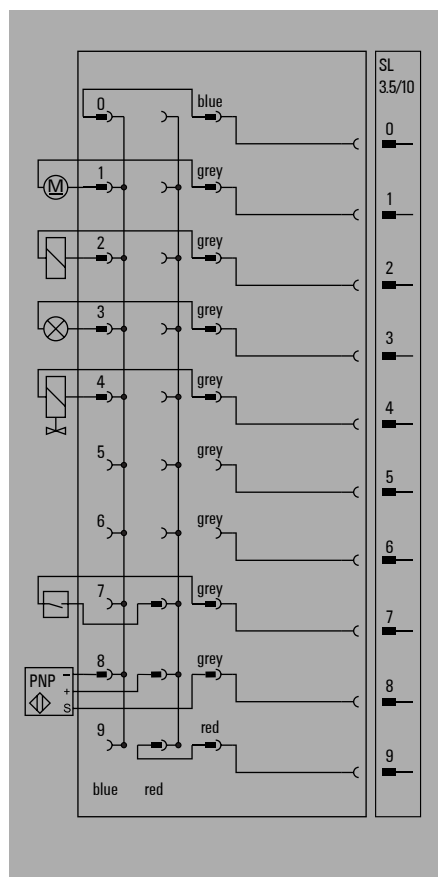

Connectors in 3.50 mm pitch Series BL/SL 3.50

BLL 3.50/./180

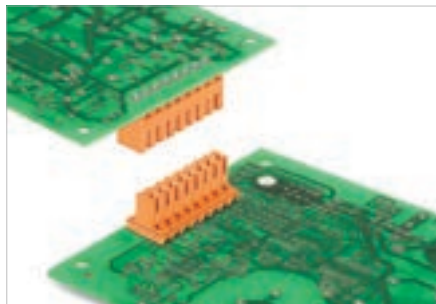

Inverted female headers for:

- touch-safety on the PCB
- board-to-board connection of modules (with SL/SL-SMT)
- Wave soldering
- Outlet direction: 180° (standing, perpendicular to PCB)

Technical data

In compliance with IEC 60664-1 / IEC 61984

Clamping range, max.			
Solid core H05(07) V-U			
Stranded H07 V-R			
Flexible H05(07) V-K			
Flexible with ferrule			
Ferrule with plastic collar			
Stripping length			
Screwdriver blade	mm		
According to norm			
Tightening torque range			
Rated current, max.	A	15.1	13
At ambient temperature		20°C	40°C
For conductor cross-section			
Overtolerance category		III	III II
Pollution severity		3	2 2
Rated voltage	V	160	160 320
Rated impulse voltage	kV	2.5	2.5 2.5
UL / CUL (Use Group)		B	C D
Rated voltage	V	300	300
Rated current	A	9	9
AWG conductor	AWG		-
CSA (Use Group)		B	C D
Rated voltage	V	300	
Rated current	A	9	
AWG conductor	AWG	-	
General data			
Type of insulation material		PBT	
UL 94 flammability rating		V-0	
Contact base material		CuSn	
Material of contact surface		tinned	
Pin dimensions = d	mm	0.8	
Solder eyelet Ø = D	mm	1.3	
Solder eyelet Ø tolerance	mm	+ 0,1	

Product data

IEC: 320 V / 15.1 A

UL: 300 V / 9 A



For additional articles and information, refer to catalog.weidmuller.com

Note:

- Additional variants on request
- Gold-plated contact surfaces on request
- Rated current related to rated cross-section & min. No. of poles.
- P on drawing = pitch
- Rated data refer only to the component itself. Clearance and creepage distances to other components are to be designed in accordance with the relevant application standards.
- Long term storage of the product with average temperature of 50 °C and average humidity 70%, 36 months

BLL 3.50/./180



Dimensioned drawing

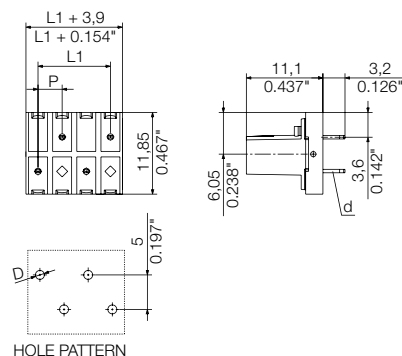

Ordering data

Solder pin length	3.2 mm			
Colour	orange			
Pitch	3.50 mm			
Pol.	L1	(inch)	Qty.	Order No.
2	3.50	0.138	75	1376310000
3	7.00	0.276	50	1376320000
4	10.50	0.413	38	1376330000
5	14.00	0.551	30	1376340000
6	17.50	0.689	25	1376430000
7	21.00	0.827	22	1376350000
8	24.50	0.965	19	1376440000
9	28.00	1.102	17	1376450000
10	31.50	1.240	15	1376470000
11	35.00	1.378	14	1376370000
12	38.50	1.516	13	1376480000

Representative deratings curve

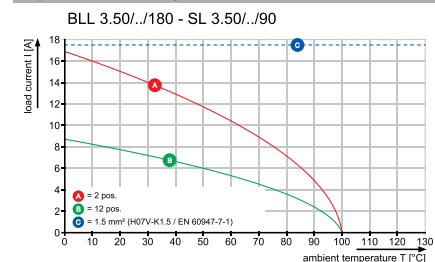

OMNIMATE® Signal PCB connectors in 3.81 mm pitch

OMNIMATE® Signal
PCB connectors in 3.81 mm pitch

Connectors in 3.81 mm pitch
Series BC/SC 3.81

Explanation	K.2
Quick selection	K.6
Product selection	K.8



Plug-in connector OMNIMATE® Signal 3.81

Opens up new dimensions for your application

Large variety of products and an extensive accessory range

- All combinations are possible: wire-to-board, wire-to-wire, board-to-board, board-to-wire
- Wide range of reflow ready strips
- Individually configurable with accessories and specific printing or coding
- Compact design to connect 1.5 mm² wires

Unique performance offering high levels of redundancy

- Rated current: 17.5 A
- Up to 65 °C without derating
- Ambient temperature up to 120 °C

Safe handling characteristics

- Lock & Release lever allows tool-free locking and module-safe loosening
- Vibration resistant PUSH IN connection offers tool free wiring connection
- Proven screw connection

Simple handling

Reliable flange connections are easy to use and protect the electronic modules when they are removed: screw flange, release lever or lock & release lever.



Unique performance

High power reserves allow applications without restrictions up to the maximum wiring power rating - even in high ambient temperatures.

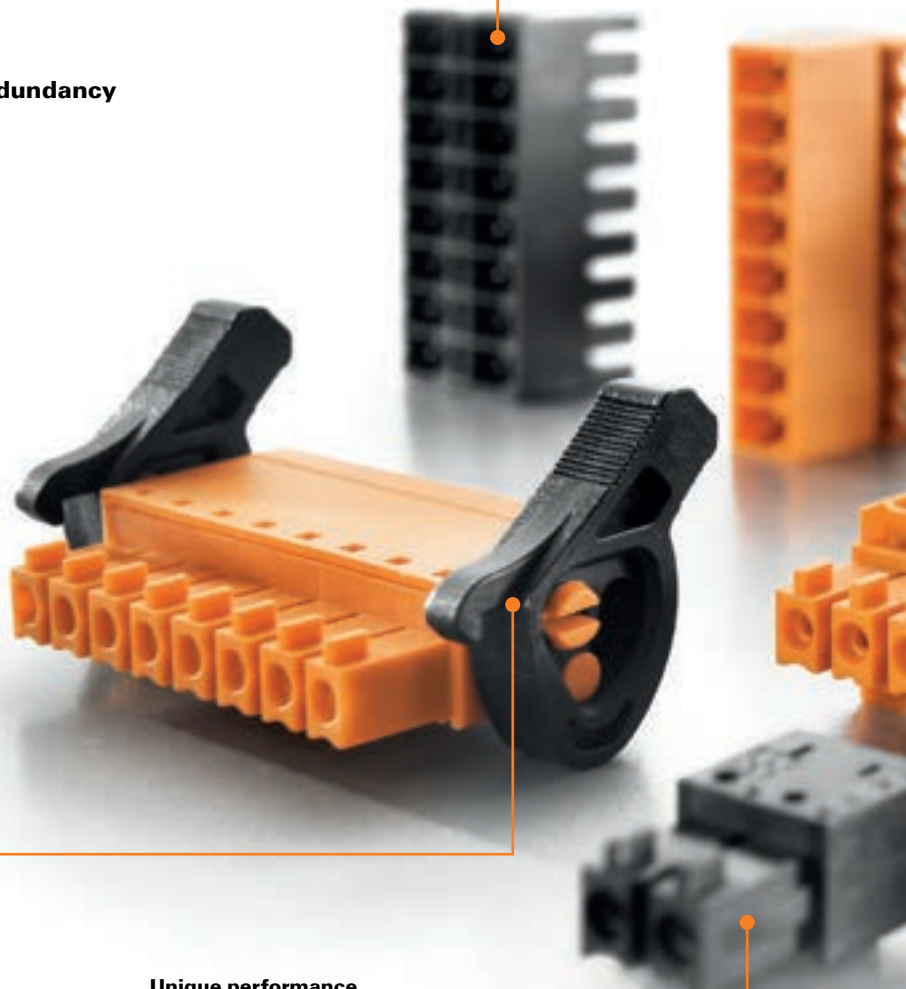
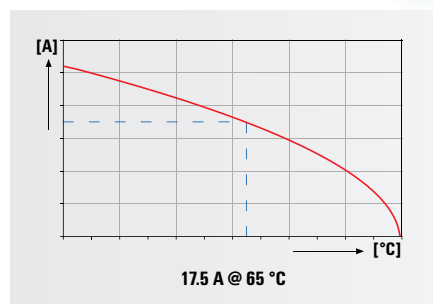

Less space required

Minimum stack height, maximum clamping force and PUSH IN: the SCDN 3.81 simply handles two 7.9 mm flat BCF 3.81 with 1.5 mm² wire end ferrules.



Maintenance-free, secure, vibration-proof

PUSH IN spring connection technology: direct connection without tools – simply plug in the prepared conductors – finished! Intuitive operation using large release buttons.



Complete system for all possible combinations and a comprehensive range of accessories

Wire-to-Board

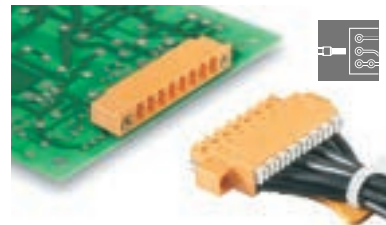

Wire-to-Wire

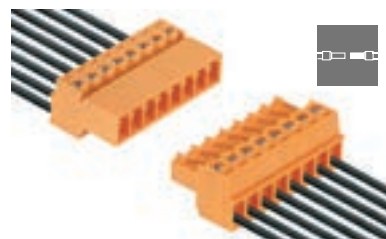

Board-to-Board

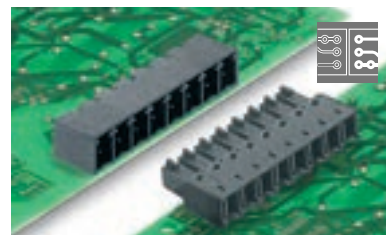

Board-to-Wire

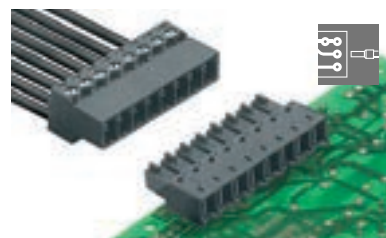

Accessories

- Coding
SC-SMT KO GR
- Light guide
display SC FLA
- Cover hood
BCZ AH



Plug-in connector OMNIMATE® Signal 3.81

Brings new dimensions into handling

Best choice for reflow soldering

- Reflow strips made from the high temperature material LCP
- Form at high soldering temperatures stability
- Dimensionally stable
- Can be processed without drying (MSL 1)
- Thermal expansion properties similar to a FR4 PCB

Unique handling

- Suitable for automatic machine handling, antistatic packaging in tape, tray or tube
- Optional Pick & Place pad supports feeder systems
- Solder flange fixes the strip to the PCB without the use of screws
- An optimised pin end which permits AOI (automated optical inspection)
- Variable pin length to support placement on both sides of the PCB
- Integrated spacing bars improve the flow of heat during the solder process
- Free space in the pin area facilitate the development of the solder meniscus.

Packaging suitable for use in automated assembly

Standard belt widths for simple integration into the assembly process.



Code in advance – process universally

No additional work required for factory-side reflow-compatible coding.

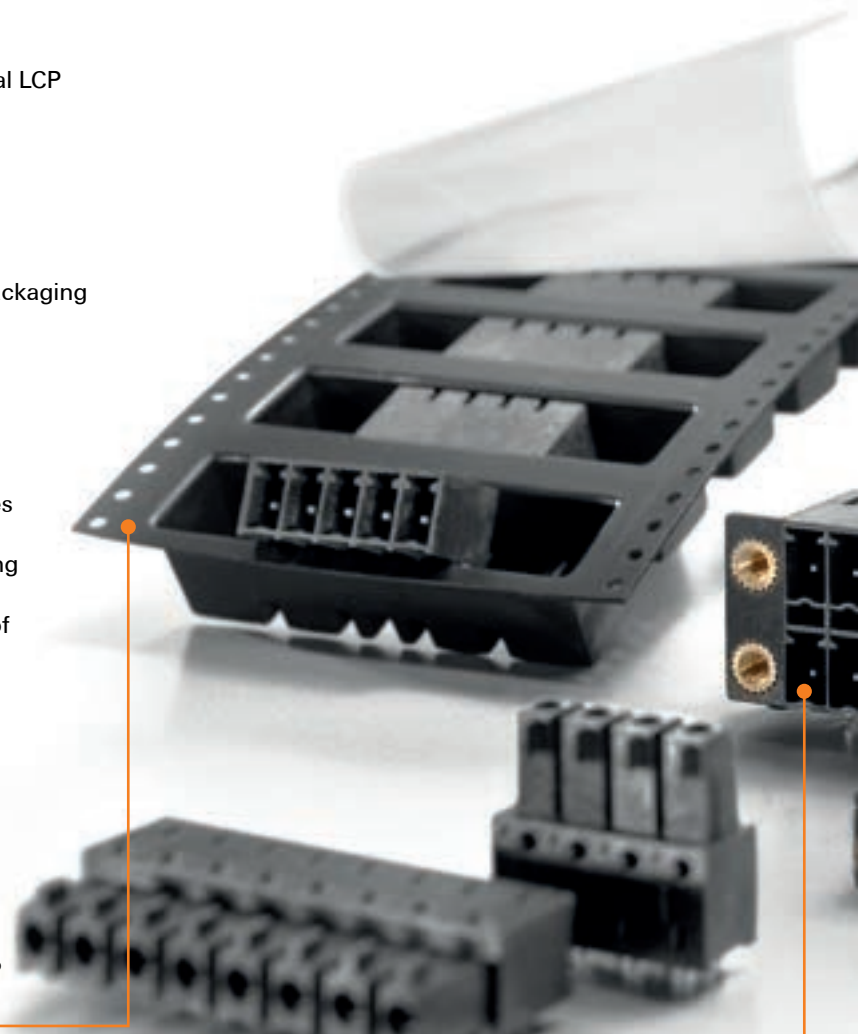

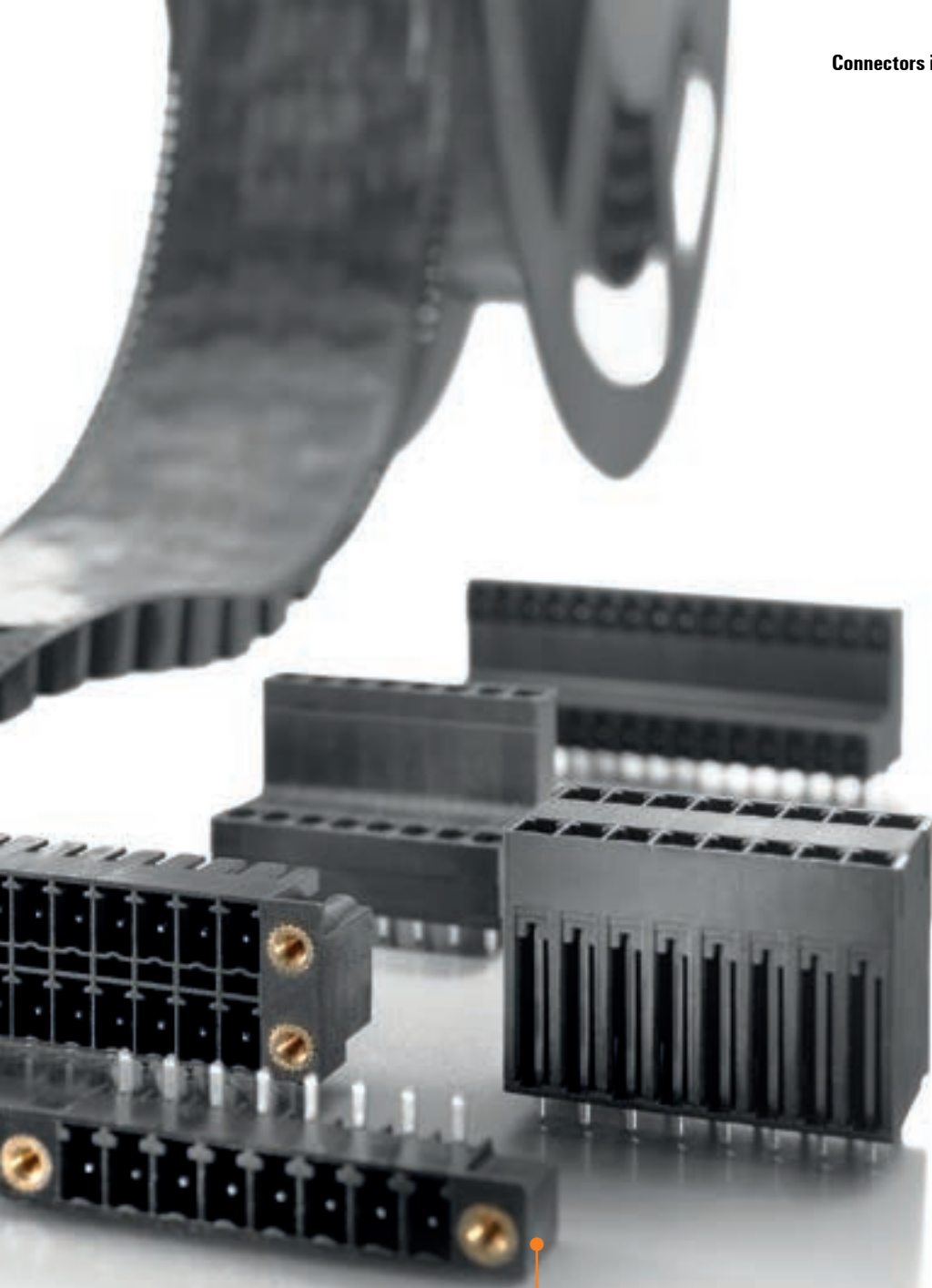

Solder flange pin

Secures to the PCB without a screw

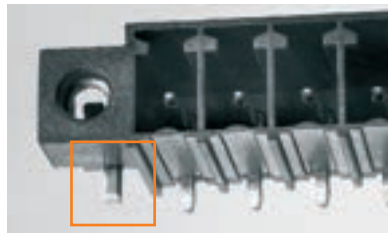

Integrated bars

Optimal airflow during reflow soldering

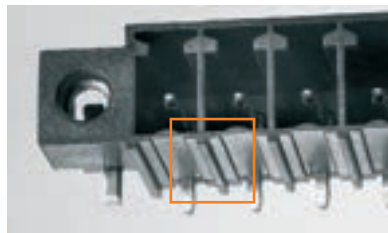

Rebates in the area of the pin

Space for the development of the solder meniscus

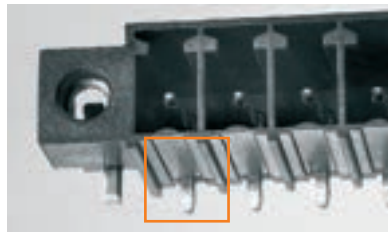

Pin tips

Optimal recognition by the automatic optical inspection device (AOI)

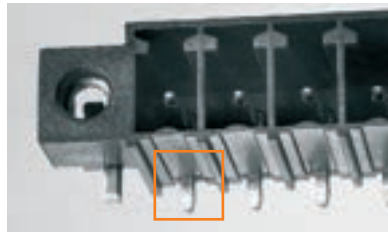





SMT

No need for pre-treatment, high temperature material LCP is safe to use during the soldering process.



<http://www.OMNIMATE.net>

-  = Wire-to-Board
-  = Board-to-Board
-  = Wire-to-Wire
-  = Board-to-Wire

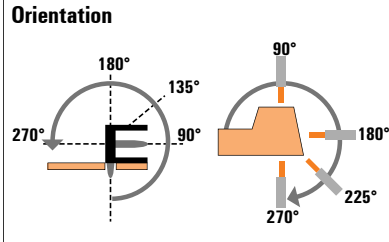
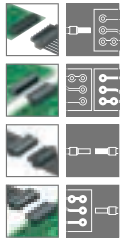



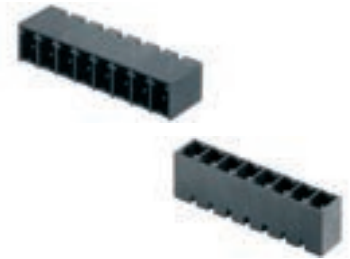

















Male header



BC/SC 3.81 series



		Levels	
		1	
Orientation		90°	180°
IEC / UL		IEC: 320 V/17.5 A UL: 300 V/10 A	IEC: 320 V/17.5 A UL: 300 V/10 A
Type		SC	SC
Flange options		G/F	G/F
		 Solder connection	
		 Reflow solder connection	
Type		SC-SMT	SC-SMT
Flange options		G/LF	G/LF

		Flange options			
Female plug	 Screw		BCZ 180° (G)/F/LR IEC: 320 V/17.5 A/0.2 - 1.5 mm ² UL: 300 V/10 A/AWG 28 - 16		
			BCZ 90° (G)/F IEC: 320 V/17.5 A/0.2 - 1.5 mm ² UL: 300 V/10 A/AWG 28 - 16		
			BCZ 270° (G)/F IEC: 320 V/17.5 A/0.2 - 1.5 mm ² UL: 300 V/10 A/AWG 28 - 16		
Female plug	 PUSH IN		BCF 180° (G)/F/LR IEC: 320 V/17.5 A/0.14 - 1.5 mm ² UL: 300 V/10 A/AWG 24 - 16		
		Female header	 Solder connection		BCL SMT 90° (G)/F/LFI IEC: 320 V/17.5 A UL: 300 V/10 A
	BCL SMT 180° (G)/LFI IEC: 320 V/17.5 A UL: 300 V/10 A				

Female plug and header:
(G)* = Closed (without flange)
F = Flange with screw
LFI = Inverted solder flange with nut
LR = Lock & Release lever

Male header and plug:
G = Closed (without flange)
F = Screw flange with nut
LF = Solder flange with nut
LR = Lock & Release lever
LFI = Inverted flange with screw

* not included in the article description

Male header **Male plug**



1		2					1
135°	270°	90°	180°	90°	90°	180°	180°
IEC: 320 V/17.5 A UL: 300 V/10 A	IEC: 320 V/17.5 A UL: 300 V/10 A	IEC: 320 V/17.5 A UL: 300 V/10 A	IEC: 320 V/17.5 A UL: 300 V/10 A	IEC: 320 V/17.5 A UL: 300 V/10 A	IEC: 320 V/17.5 A UL: 300 V/10 A	IEC: 320 V/17.5 A UL: 300 V/10 A	IEC: 320 V/17.5 A/ 0.2 - 1.5 mm ² UL: 300 V/10 A/ AWG 28 - 16

Solder connection

Screw

SC	SC	SCD	SCD	SCDN	SCDV	SCDV	SCZ
G/F	G/F	G/F	G/F	G/F	G/F	G/F	G/F/FI/LR

Reflow solder connection

SC-SMT	SC-SMT	SCD-THR	SCD-THR	SCDN-THR	SCDV-THR	SCDV-THR	
G/LF	G/F	G/F	G/F	G/F	G/F	G/F	
○	○	○	○	○	○	○	●
○	○	○	○	○	○	○	●
○	○	○	○	○	○	○	●
○	○	○	○	○	○	○	●
●	●	●	●	●	●	●	●
●	●	●	●	●	●	●	●

K

SC-SMT 3.81/./90

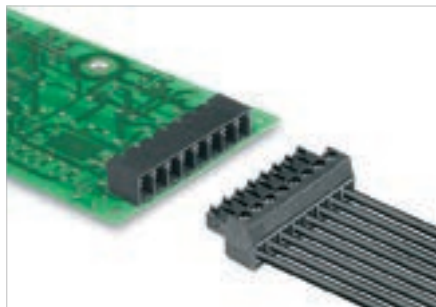

High-temperature-resistant male header.

- Plugging direction parallel to PCB
- Available in closed (G) and with solder flange (LF).
- Packed either in box (BX) or on anti-static roll (tape-on-reel, RL)
- Pin length of either 1.5 mm or 3.2 mm

Weidmüller's 3.81 mm pitch (0.15 inch) plug-in connectors are compatible with the layouts of standard connectors and offer space for labelling and coding.

Product data

IEC: 320 V / 17.5 A
UL: 300 V / 11 A



For additional articles and information, refer to catalog.weidmueller.com

Note:

- Rated current related to rated cross-section & min. No. of poles.
- Rated data refer only to the component itself. Clearance and creepage distances to other components are to be designed in accordance with the relevant application standards.
- P on drawing = pitch

SC-SMT 3.81/./90G Box

closed side



Dimensioned drawing

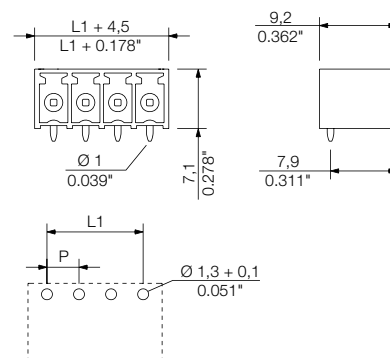

Technical data

In compliance with IEC 60664-1 / IEC 61984

Clamping range, max.			
Solid core H05(07) V-U			
Stranded H07 V-R			
Flexible H05(07) V-K			
Flexible with ferrule			
Ferrule with plastic collar			
Stripping length			
Screwdriver blade	mm		
According to norm			
Tightening torque range			
Rated current, max.	A	17.5	17
At ambient temperature		20°C	40°C
For conductor cross-section			
Overvoltage category		III	III II
Pollution severity		3	2 2
Rated voltage	V	160	160 320
Rated impulse voltage	kV	2.5	2.5 2.5
UL / CUL (Use Group)		B	C D
Rated voltage	V	300	300
Rated current	A	11	11
AWG conductor	AWG		-
CSA (Use Group)		B	C D
Rated voltage	V	300	
Rated current	A	11	
AWG conductor	AWG		-
General data			
Type of insulation material		LCP GF	
UL 94 flammability rating		V-0	
Contact base material		Copper alloy	
Material of contact surface		tinned	
Pin dimensions = d	mm	1.0, Octagonal	
Solder eyelet Ø = D	mm	1.3	
Solder eyelet Ø tolerance	mm	+ 0,1	

Accessories

Note: Refer to the Accessories chapter for additional accessories.

Coding	Order No.
SC-SMT 3.81 KO GY BX	1968900000

Ordering data

Solder pin length		3.2 mm		
Colour		black		
Pitch	3.81 mm			
Pol.	L1	(inch)	Qty.	Order No.
2	3.81	0.150	50	1862460000
3	7.62	0.300	50	1862480000
4	11.43	0.450	50	1862490000
5	15.24	0.600	50	1862500000
6	19.05	0.750	50	1862510000
7	22.86	0.900	50	1862520000
8	26.67	1.050	50	1862530000
9	30.48	1.200	50	1862540000
10	34.29	1.350	50	1862550000
11	38.10	1.500	50	1862570000
12	41.91	1.650	50	1862730000

K

3.81

90°

SC-SMT 3.81/./90G Tape

closed side; tape-on-reel



Dimensioned drawing

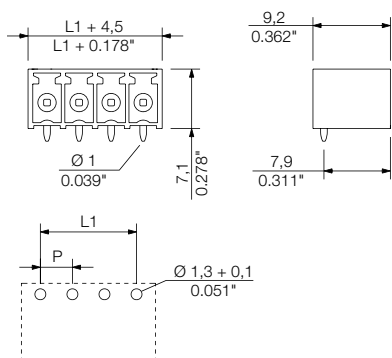

Ordering data

Solder pin length		1.5 mm	
Colour		black	
Pitch		3.81 mm	
Pol.	L1	(inch)	Qty. Order No.
2	3.81	0.150	400 1863140000
3	7.62	0.300	400 1863150000
4	11.43	0.450	400 1863160000
5	15.24	0.600	400 1863170000
6	19.05	0.750	400 1863180000
7	22.86	0.900	400 1863190000
8	26.67	1.050	400 1863200000
9	30.48	1.200	400 1863210000
10	34.29	1.350	400 1863220000

Tape widths: 32, 44, 56, 72, 88

SC-SMT 3.81/./90LF Box

with solder flange



Dimensioned drawing

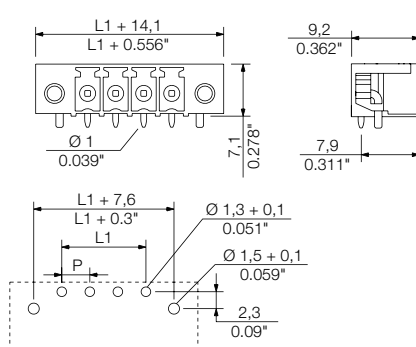

Ordering data

Solder pin length		3.2 mm	
Colour		black	
Pitch		3.81 mm	
Pol.	L1	(inch)	Qty. Order No.
2	3.81	0.150	50 1863670000
3	7.62	0.300	50 1863680000
4	11.43	0.450	50 1863690000
5	15.24	0.600	50 1863700000
6	19.05	0.750	50 1863710000
7	22.86	0.900	50 1863740000
8	26.67	1.050	50 1863760000
9	30.48	1.200	50 1863770000
10	34.29	1.350	50 1863790000
11	38.10	1.500	50 1863810000
12	41.91	1.650	50 1863820000

SC-SMT 3.81/./90LF Tape

with solder flange; tape-on-reel



Dimensioned drawing

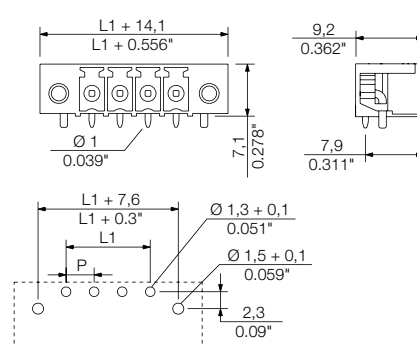

Ordering data

Solder pin length		1.5 mm	
Colour		black	
Pitch		3.81 mm	
Pol.	L1	(inch)	Qty. Order No.
2	3.81	0.150	400 1862720000
3	7.62	0.300	400 1862750000
4	11.43	0.450	400 1862770000
5	15.24	0.600	400 1862790000
6	19.05	0.750	400 1862820000
7	22.86	0.900	400 1862830000
8	26.67	1.050	400 1862850000

Tape widths: 32, 44, 56, 72, 88

Connectors in 3.81 mm pitch Series BC/SC 3.81

SC-SMT 3.81../180

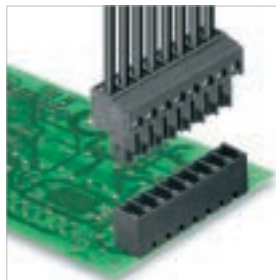

High-temperature-resistant male header.

- Plugging direction is perpendicular to PCB
- Available in closed (G) and with solder flange (LF).
- Packed either in box (BX) or on anti-static roll (tape-on-reel, RL)
- Pin length of either 1.5 mm or 3.2 mm

Weidmüller's 3.81 mm pitch (0.15 inch) plug-in connectors are compatible with the layouts of standard connectors and offer space for labelling and coding.

Technical data

In compliance with IEC 60664-1 / IEC 61984

Clamping range, max.			
Solid core H05(07) V-U			
Stranded H07 V-R			
Flexible H05(07) V-K			
Flexible with ferrule			
Ferrule with plastic collar			
Stripping length			
Screwdriver blade	mm		
According to norm			
Tightening torque range			
Rated current, max.	A	17.5	17
At ambient temperature		20°C	40°C
For conductor cross-section			
Overvoltage category		III	III II
Pollution severity		3	2 2
Rated voltage	V	160	160 320
Rated impulse voltage	kV	2.5	2.5 2.5
UL / CUL (Use Group)		B	C D
Rated voltage	V	300	300
Rated current	A	11	11
AWG conductor	AWG		-
CSA (Use Group)		B	C D
Rated voltage	V	300	
Rated current	A	11	
AWG conductor	AWG		-
General data			
Type of insulation material	LCP GF		
UL 94 flammability rating	V-0		
Contact base material	Copper alloy		
Material of contact surface	tinned		
Pin dimensions = d	mm	1.0, Octagonal	
Solder eyelet Ø = D	mm	1.3	
Solder eyelet Ø tolerance	mm	+ 0,1	

Product data

IEC: 320 V / 17.5 A
UL: 300 V / 11 A



For additional articles and information, refer to catalog.weidmueller.com

Note:

- Rated current related to rated cross-section & min. No. of poles.
- Rated data refer only to the component itself. Clearance and creepage distances to other components are to be designed in accordance with the relevant application standards.
- P on drawing = pitch

SC-SMT 3.81../180G Box

closed side



Dimensioned drawing

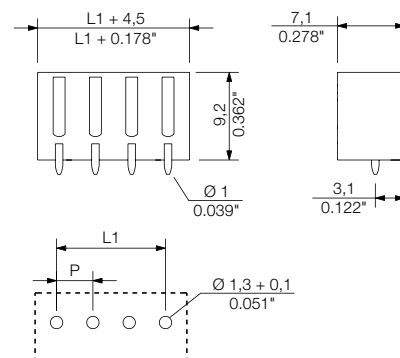

Ordering data

Solder pin length		3.2 mm		
Colour		black		
Pitch		3.81 mm		
Pol.	L1	(inch)	Qty.	Order No.
2	3.81	0.150	50	1862920000
3	7.62	0.300	50	1862940000
4	11.43	0.450	50	1862950000
5	15.24	0.600	50	1863010000
6	19.05	0.750	50	1863020000
7	22.86	0.900	50	1863030000
8	26.67	1.050	50	1863240000
9	30.48	1.200	50	1863270000
10	34.29	1.350	50	1863290000
11	38.10	1.500	50	1863320000
12	41.91	1.650	50	1863330000

Accessories

Note: Refer to the Accessories chapter for additional accessories.

Coding	Order No.
SC-SMT 3.81 KO GY BX	1968900000



SC-SMT 3.81/./180G Tape

closed side; tape-on-reel



Dimensioned drawing

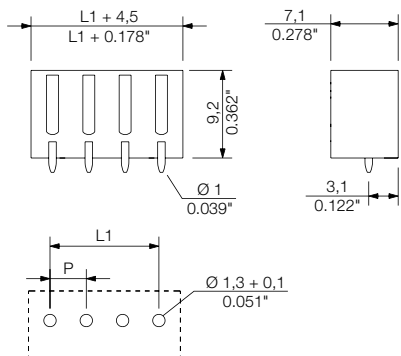

Ordering data

Solder pin length		1.5 mm	3.2 mm		
Colour		black	black		
Pitch 3.81 mm					
Pol.	L1	(inch)	Qty.	Order No.	Order No.
2	3.81	0.150	300	1864050000	
3	7.62	0.300	300	1864060000	
4	11.43	0.450	300	1864290000	1863490000
5	15.24	0.600	300	1864300000	
6	19.05	0.750	300	1864310000	
7	22.86	0.900	300	1864320000	
8	26.67	1.050	300	1864330000	
9	30.48	1.200	300	1864340000	
10	34.29	1.350	300	1864350000	

Tape widths: 32, 44, 56, 72, 88

SC-SMT 3.81/./180LF Box

with solder flange



Dimensioned drawing

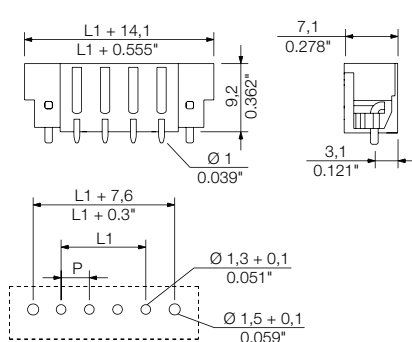

Ordering data

Solder pin length		3.2 mm			
Colour		black			
Pitch 3.81 mm					
Pol.	L1	(inch)	Qty.	Order No.	Order No.
2	3.81	0.150	50	1863230000	
3	7.62	0.300	50	1863250000	
4	11.43	0.450	50	1863260000	
5	15.24	0.600	50	1863280000	
6	19.05	0.750	50	1863300000	
7	22.86	0.900	50	1863310000	
8	26.67	1.050	50	1863340000	
9	30.48	1.200	50	1863360000	
10	34.29	1.350	50	1863380000	
11	38.10	1.500	50	1863390000	
12	41.91	1.650	50	1863410000	

SC-SMT 3.81/./180LF Tape

with solder flange; tape-on-reel



Dimensioned drawing

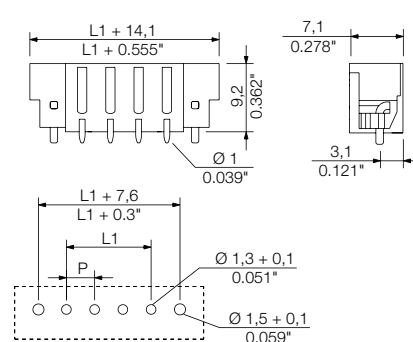

Ordering data

Solder pin length		1.5 mm			
Colour		black			
Pitch 3.81 mm					
Pol.	L1	(inch)	Qty.	Order No.	Order No.
2	3.81	0.150	300	1864220000	
3	7.62	0.300	300	1864230000	
4	11.43	0.450	300	1864240000	
5	15.24	0.600	300	1864250000	
6	19.05	0.750	300	1864260000	
7	22.86	0.900	300	1864270000	
8	26.67	1.050	300	1864280000	

Tape widths: 32, 44, 56, 72, 88

Connectors in 3.81 mm pitch Series BC/SC 3.81

SC-SMT 3.81../135

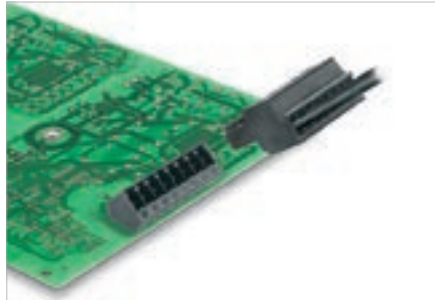

Male header with 135° plugging angle (135° angle between the plugging direction and the solder pin). This corresponds to a 45° angle between the wire orientation and the circuit board.

- Reflow compatible
- Available in closed (G) and with solder flange (LF).
- Pin length of either 1.5 mm or 3.2 mm

Weidmüller's 3.81 mm pitch (0.15 inch) plug-in connectors are compatible with the layouts of standard connectors and offer space for labelling and coding.

Technical data

In compliance with IEC 60664-1 / IEC 61984

Clamping range, max.			
Solid core H05(07) V-U			
Stranded H07 V-R			
Flexible H05(07) V-K			
Flexible with ferrule			
Ferrule with plastic collar			
Stripping length			
Screwdriver blade	mm		
According to norm			
Tightening torque range			
Rated current, max.	A	17.5	17.5
At ambient temperature		20°C	40°C
For conductor cross-section			
Overvoltage category		III	III II
Pollution severity		3	2 2
Rated voltage	V	160	160 320
Rated impulse voltage	kV	2.5	2.5 2.5
UL / CUL (Use Group)	B C D		
Rated voltage	V	300	300
Rated current	A	11	11
AWG conductor	AWG	-	
CSA (Use Group)	B C D		
Rated voltage	V	300	
Rated current	A	11	
AWG conductor	AWG	-	
General data			
Type of insulation material	LCP GF		
UL 94 flammability rating	V-0		
Contact base material	Copper alloy		
Material of contact surface	tinned		
Pin dimensions = d	mm	1.0, Octagonal	
Solder eyelet Ø = D	mm	1.3	
Solder eyelet Ø tolerance	mm	+ 0,1	

Product data

IEC: 320 V / 17.5 A
UL: 300 V / 11 A



For additional articles and information, refer to catalog.weidmuller.com

Note:

- Rated current related to rated cross-section & min. No. of poles.
- Rated data refer only to the component itself. Clearance and creepage distances to other components are to be designed in accordance with the relevant application standards.
- P on drawing = pitch

SC-SMT 3.81../135G

closed side



Dimensioned drawing

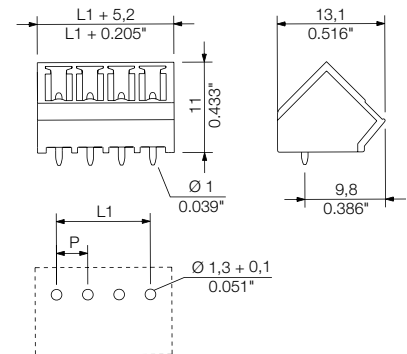

Accessories

Note: Refer to the Accessories chapter for additional accessories.

Coding	Order No.
SC-SMT 3.81 KO GY BX	1968900000

Ordering data

Solder pin length		3.2 mm		
Colour		black		
Pitch		3.81 mm		
Pol.	L1	(inch)	Qty.	Order No.
2	3.81	0.150	50	1977200000
3	7.62	0.300	50	1977210000
4	11.43	0.450	50	1977220000
5	15.24	0.600	50	1977230000
6	19.05	0.750	50	1977240000
7	22.86	0.900	50	1977250000
8	26.67	1.050	50	1977690000
9	30.48	1.200	50	1977700000
10	34.29	1.350	50	1977710000
11	38.10	1.500	50	1977720000
12	41.91	1.650	50	1977730000

SC-SMT 3.81/./135LF

with solder flange



Dimensioned drawing

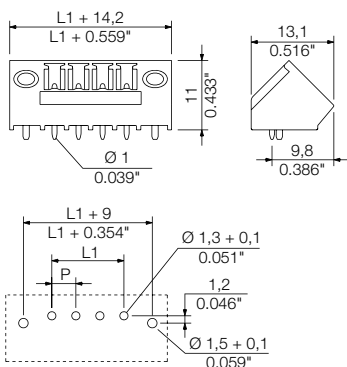

Ordering data

Solder pin length		3.2 mm	
Colour		black	
Pitch		3.81 mm	
Pol.	L1	(inch)	Qty. Order No.
2	3.81	0.150	50 1978080000
3	7.62	0.300	50 1978090000
4	11.43	0.450	50 1978100000
5	15.24	0.600	50 1978110000
6	19.05	0.750	50 1978120000
7	22.86	0.900	50 1978130000
8	26.67	1.050	50 1978140000
9	30.48	1.200	50 1978150000
10	34.29	1.350	50 1978160000
11	38.10	1.500	50 1978170000
12	41.91	1.650	50 1978180000

Connectors in 3.81 mm pitch Series BC/SC 3.81

SC-SMT 3.81../270

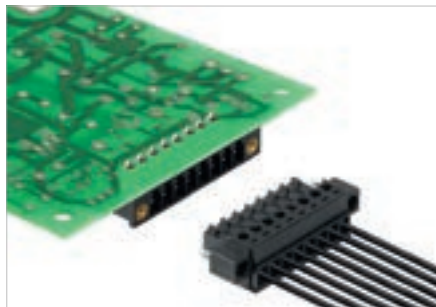

High-temperature-resistant male header with 270° plugging angle (the angle between the plugging direction and the solder pin). This angle has a plugging direction that is parallel to the circuit board with female plugs plugged in upside down.

- Reflow compatible
- Available in closed (G) version and with screw flange (F).
- Pin length of either 1.5 mm or 3.2 mm

Weidmüller's 3.81 mm pitch (0.15 inch) plug-in connectors are compatible with the layouts of standard connectors and offer space for labelling and coding.

Technical data

In compliance with IEC 60664-1 / IEC 61984

Clamping range, max.			
Solid core H05(07) V-U			
Stranded H07 V-R			
Flexible H05(07) V-K			
Flexible with ferrule			
Ferrule with plastic collar			
Stripping length			
Screwdriver blade	mm		
According to norm			
Tightening torque range			
Rated current, max.	A	17.5	17.5
At ambient temperature		20°C	40°C
For conductor cross-section			
Overvoltage category		III	III II
Pollution severity		3	2 2
Rated voltage	V	160	160 320
Rated impulse voltage	kV	2.5	2.5 2.5
UL / CUL (Use Group)		B	C D
Rated voltage	V	300	300
Rated current	A	11	11
AWG conductor	AWG		-
CSA (Use Group)		B	C D
Rated voltage	V	300	
Rated current	A	11	
AWG conductor	AWG		-
General data			
Type of insulation material	LCP GF		
UL 94 flammability rating	V-0		
Contact base material	Copper alloy		
Material of contact surface	tinned		
Pin dimensions = d	mm	1.0, Octagonal	
Solder eyelet Ø = D	mm	1.3	
Solder eyelet Ø tolerance	mm	+ 0,1	

Product data

IEC: 320 V / 17.5 A
UL: 300 V / 11 A



For additional articles and information, refer to catalog.weidmueller.com

Note:

- Rated current related to rated cross-section & min. No. of poles.
- Rated data refer only to the component itself. Clearance and creepage distances to other components are to be designed in accordance with the relevant application standards.
- P on drawing = pitch

SC-SMT 3.81../270G

closed side



Dimensioned drawing

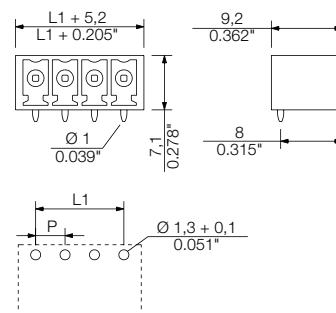

Accessories

Note: Refer to the Accessories chapter for additional accessories.

Coding	Order No.
SC-SMT 3.81 KO GY BX	1968900000

Ordering data

Solder pin length		3.2 mm		
Colour		black		
Pitch		3.81 mm		
Pol.	L1	(inch)	Qty.	Order No.
2	3.81	0.150	50	1036480000
3	7.62	0.300	50	1036490000
4	11.43	0.450	50	1036510000
5	15.24	0.600	50	1036520000
6	19.05	0.750	50	1036530000
7	22.86	0.900	50	1036540000
8	26.67	1.050	50	1036550000
9	30.48	1.200	50	1036560000
10	34.29	1.350	50	1036570000
11	38.10	1.500	50	1036580000
12	41.91	1.650	50	1036590000

SC-SMT 3.81/./270F

with screw flange



Dimensioned drawing

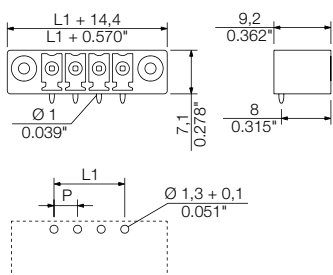

Ordering data

Solder pin length		3.2 mm	
Colour		black	
Pitch		3.81 mm	
Pol.	L1	(inch)	Qty. Order No.
2	3.81	0.150	50 1036990000
3	7.62	0.300	50 1037010000
4	11.43	0.450	50 1037020000
5	15.24	0.600	50 1037030000
6	19.05	0.750	50 1037040000
7	22.86	0.900	50 1037050000
8	26.67	1.050	50 1037060000
9	30.48	1.200	50 1037070000
10	34.29	1.350	50 1037080000
11	38.10	1.500	50 1037090000
12	41.91	1.650	50 1037110000



Connectors in 3.81 mm pitch Series BC/SC 3.81

SCD-THR 3.81../90

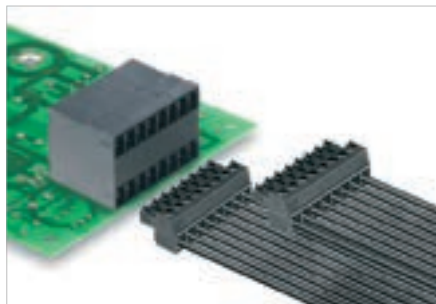

High-temperature-resistant, double-level male header for reflow soldering.

- Orientation: 90°
- Designed for front panel applications.
- Available in closed (G) version and with screw flange (F).

Weidmüller's 3.81 mm pitch (0.15 inch) plug-in connectors are compatible with the layouts of standard connectors and offer space for labelling and coding.

Technical data

In compliance with IEC 60664-1 / IEC 61984

Clamping range, max.			
Solid core H05(07) V-U			
Stranded H07 V-R			
Flexible H05(07) V-K			
Flexible with ferrule			
Ferrule with plastic collar			
Stripping length			
Screwdriver blade	mm		
According to norm			
Tightening torque range			
Rated current, max.	A	17.5	17
At ambient temperature		20°C	40°C
For conductor cross-section			
Overvoltage category		III	III II
Pollution severity		3	2 2
Rated voltage	V	160	160 320
Rated impulse voltage	kV	2.5	2.5 2.5
UL / CUL (Use Group)	B C D		
Rated voltage	V	300	300
Rated current	A	11	11
AWG conductor	AWG	-	
CSA (Use Group)	B C D		
Rated voltage	V	300	
Rated current	A	11	
AWG conductor	AWG	-	
General data			
Type of insulation material	LCP GF		
UL 94 flammability rating	V-0		
Contact base material	Copper alloy		
Material of contact surface	tinned		
Pin dimensions = d	mm	1.0, Octagonal	
Solder eyelet Ø = D	mm	1.3	
Solder eyelet Ø tolerance	mm	+ 0,1	

Product data

IEC: 320 V / 17.5 A
UL: 300 V / 11 A



For additional articles and information, refer to catalog.weidmueller.com

Note:

- Rated current related to rated cross-section & min. No. of poles.
- Rated data refer only to the component itself. Clearance and creepage distances to other components are to be designed in accordance with the relevant application standards.
- P on drawing = pitch

SCD-THR 3.81../90G

closed side



Dimensioned drawing

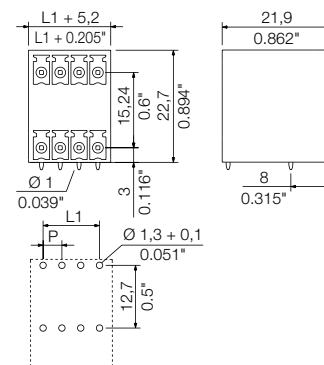

Accessories

Note: Refer to the Accessories chapter for additional accessories.

Coding	Order No.
SC-SMT 3.81 KO GY BX	1968900000

Ordering data

Solder pin length		3.2 mm		
Colour		black		
Pitch		3.81 mm		
Pol.	L1	(inch)	Qty.	Order No.
4	3.81	0.150	50	1973730000
6	7.62	0.300	50	1973740000
8	11.43	0.450	50	1973750000
10	15.24	0.600	50	1973760000
12	19.05	0.750	50	1973770000
14	22.86	0.900	50	1973780000
16	26.67	1.050	50	1973790000
18	30.48	1.200	50	1973800000
20	34.29	1.350	50	1973810000
22	38.10	1.500	50	1973820000
24	41.91	1.650	50	1973830000

SCD-THR 3.81../90F

with screw flange



Dimensioned drawing

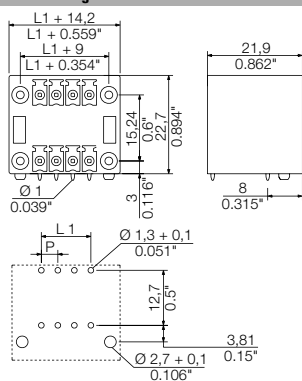

Ordering data

Solder pin length		3.2 mm		
Colour		black		
Pitch		3.81 mm		
Pol.	L1	(inch)	Qty.	Order No.
4	3.81	0.150	50	1974180000
6	7.62	0.300	50	1974190000
8	11.43	0.450	50	1974200000
10	15.24	0.600	50	1974210000
12	19.05	0.750	50	1974220000
14	22.86	0.900	50	1974230000
16	26.67	1.050	50	1974240000
18	30.48	1.200	50	1974250000
20	34.29	1.350	50	1974290000
22	38.10	1.500	50	1974310000
24	41.91	1.650	50	1974330000

Connectors in 3.81 mm pitch Series BC/SC 3.81

SCD-THR 3.81../180

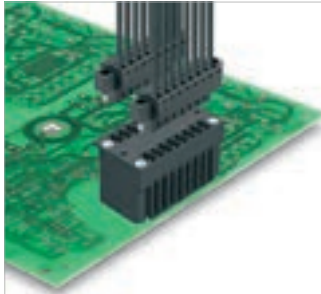

High-temperature-resistant, double-level male header for reflow soldering.

- It allows you to use two interfaces on only one surface and with only one step in the work flow.
- Orientation: 180° (recumbent)
- Connections at the same level and with access that is flush over the front board.
- Space for labelling and coding
- Packed in cardboard box.

Weidmüller's 3.81 mm pitch (0.15 inch) plug-in connectors are compatible with the layouts of standard connectors and offer space for labelling and coding.

Technical data

In compliance with IEC 60664-1 / IEC 61984

Clamping range, max.			
Solid core H05(07) V-U			
Stranded H07 V-R			
Flexible H05(07) V-K			
Flexible with ferrule			
Ferrule with plastic collar			
Stripping length			
Screwdriver blade	mm		
According to norm			
Tightening torque range			
Rated current, max.	A	17.5	17
At ambient temperature		20°C	40°C
For conductor cross-section			
Overvoltage category		III	III II
Pollution severity		3	2 2
Rated voltage	V	160	160 320
Rated impulse voltage	kV	2.5	2.5 2.5
UL / CUL (Use Group)	B C D		
Rated voltage	V	300	300
Rated current	A	11	11
AWG conductor	AWG	-	
CSA (Use Group)	B C D		
Rated voltage	V	300	
Rated current	A	11	
AWG conductor	AWG	-	
General data			
Type of insulation material	LCP GF		
UL 94 flammability rating	V-0		
Contact base material	Copper alloy		
Material of contact surface	tinned		
Pin dimensions = d	mm	1.0, Octagonal	
Solder eyelet Ø = D	mm	1.3	
Solder eyelet Ø tolerance	mm	+ 0,1	

Product data

IEC: 320 V / 17.5 A
UL: 300 V / 11 A



For additional articles and information, refer to catalog.weidmueller.com

Note:

- Rated current related to rated cross-section & min. No. of poles.
- Rated data refer only to the component itself. Clearance and creepage distances to other components are to be designed in accordance with the relevant application standards.
- P on drawing = pitch

SCD-THR 3.81../180G

closed side



Dimensioned drawing

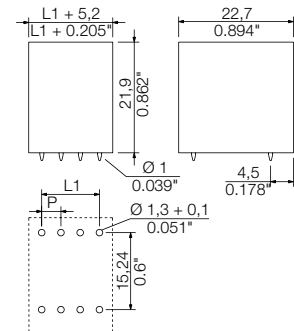

Accessories

Note: Refer to the Accessories chapter for additional accessories.

Coding	Order No.
SC-SMT 3.81 KO GY BX	1968900000
Mounting screw	
PTSC KA 2.2X4.5 WN1412	1610740000

Ordering data

Solder pin length		3.2 mm		
Colour		black		
Pitch		3.81 mm		
Pol.	L1	(inch)	Qty.	Order No.
4	3.81	0.150	50	1030950000
6	7.62	0.300	50	1030960000
8	11.43	0.450	50	1030970000
10	15.24	0.600	50	1030980000
12	19.05	0.750	50	1030990000
14	22.86	0.900	50	1031010000
16	26.67	1.050	50	1031020000
18	30.48	1.200	50	1031030000
20	34.29	1.350	50	1031040000
22	38.10	1.500	50	1031050000
24	41.91	1.650	50	1031060000

K

3.81

180°

SCD-THR 3.81/././180F

with screw flange



Dimensioned drawing

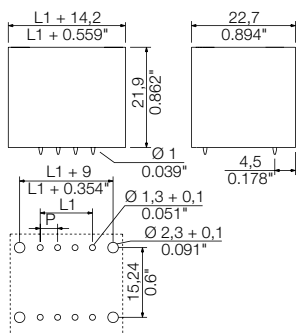

Ordering data

Solder pin length		3.2 mm		
Colour		black		
Pitch		3.81 mm		
Pol.	L1	(inch)	Qty.	Order No.
4	3.81	0.150	50	1031460000
6	7.62	0.300	50	1031470000
8	11.43	0.450	50	1031490000
10	15.24	0.600	50	1031510000
12	19.05	0.750	50	1031520000
14	22.86	0.900	50	1031530000
16	26.67	1.050	50	1031540000
18	30.48	1.200	50	1031560000
20	34.29	1.350	50	1031570000
22	38.10	1.500	50	1031590000
24	41.91	1.650	50	1031610000

Connectors in 3.81 mm pitch Series BC/SC 3.81

SCDN-THR 3.81/./90

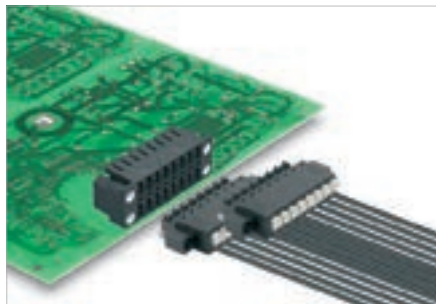

Compact double-level male header for reflow soldering process. For use with BCF 3.81 plugs.

- Orientation: 90°
- Designed for front panel applications.
- Available in closed (G) version and with screw flange (F).

Weidmüller's 3.81 mm pitch (0.15 inch) plug-in connectors are compatible with the layouts of standard connectors and offer space for labelling and coding.

Technical data

In compliance with IEC 60664-1 / IEC 61984

Clamping range, max.			
Solid core H05(07) V-U			
Stranded H07 V-R			
Flexible H05(07) V-K			
Flexible with ferrule			
Ferrule with plastic collar			
Stripping length			
Screwdriver blade	mm		
According to norm			
Tightening torque range			
Rated current, max.	A	17.5	17
At ambient temperature		20°C	40°C
For conductor cross-section			
Overvoltage category		III	III II
Pollution severity		3	2 2
Rated voltage	V	160	160 320
Rated impulse voltage	kV	2.5	2.5 2.5
UL / CUL (Use Group)	B C D		
Rated voltage	V	300	300
Rated current	A	11	11
AWG conductor	AWG	-	
CSA (Use Group)	B C D		
Rated voltage	V	300	300
Rated current	A	11	11
AWG conductor	AWG	-	
General data			
Type of insulation material	LCP GF		
UL 94 flammability rating	V-0		
Contact base material	Copper alloy		
Material of contact surface	tinned		
Pin dimensions = d	mm	1.0, Octagonal	
Solder eyelet Ø = D	mm	1.3	
Solder eyelet Ø tolerance	mm	+ 0,1	

Product data

IEC: 320 V / 17.5 A
UL: 300 V / 11 A



For additional articles and information, refer to catalog.weidmueller.com

Note:

- Rated current related to rated cross-section & min. No. of poles.
- Rated data refer only to the component itself. Clearance and creepage distances to other components are to be designed in accordance with the relevant application standards.
- P on drawing = pitch

SCDN-THR 3.81/./90G

closed side



Dimensioned drawing

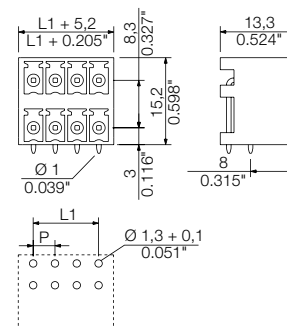

Accessories

Note: Refer to the Accessories chapter for additional accessories.

Coding	Order No.
SC-SMT 3.81 KO GY BX	1968900000

Ordering data

Solder pin length		3.2 mm		
Colour		black		
Pitch		3.81 mm		
Pol.	L1	(inch)	Qty.	Order No.
4	3.81	0.150	50	1038950000
6	7.62	0.300	50	1038960000
8	11.43	0.450	50	1038970000
10	15.24	0.600	50	1038980000
12	19.05	0.750	50	1038990000
14	22.86	0.900	50	1039010000
16	26.67	1.050	50	1039020000
18	30.48	1.200	50	1039030000
20	34.29	1.350	50	1039040000
22	38.10	1.500	50	1039050000
24	41.91	1.650	50	1039060000

SCDN-THR 3.81/././90F

with screw flange



Dimensioned drawing

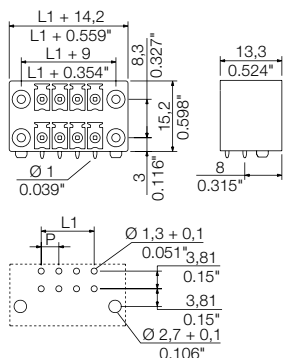

Ordering data

Solder pin length		3.2 mm		
Colour		black		
Pitch		3.81 mm		
Pol.	L1	(inch)	Qty.	Order No.
4	3.81	0.150	50	1039440000
6	7.62	0.300	50	1039450000
8	11.43	0.450	50	1039460000
10	15.24	0.600	50	1039520000
12	19.05	0.750	50	1039530000
14	22.86	0.900	50	1039540000
16	26.67	1.050	50	1039550000
18	30.48	1.200	50	1039560000
20	34.29	1.350	50	1039570000
22	38.10	1.500	50	1039580000
24	41.91	1.650	50	1039590000

Connectors in 3.81 mm pitch Series BC/SC 3.81

SCDV-THR 3.81/..../90

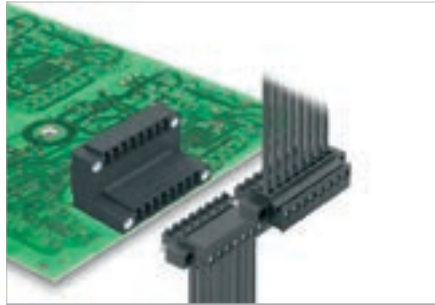

High-temperature-resistant, double-level male header for reflow soldering.

- Orientation: 90°
- Connections at two offset levels and open access to each row.
- Available in closed (G) version and with screw flange (F).

Weidmüller's 3.81 mm pitch (0.15 inch) plug-in connectors are compatible with the layouts of standard connectors and offer space for labelling and coding.

Technical data

In compliance with IEC 60664-1 / IEC 61984

Clamping range, max.			
Solid core H05(07) V-U			
Stranded H07 V-R			
Flexible H05(07) V-K			
Flexible with ferrule			
Ferrule with plastic collar			
Stripping length			
Screwdriver blade	mm		
According to norm			
Tightening torque range			
Rated current, max.	17.5	17	
At ambient temperature	20°C	40°C	
For conductor cross-section			
Overvoltage category	III	III	II
Pollution severity	3	2	2
Rated voltage	V	160	160 320
Rated impulse voltage	kV	2.5	2.5 2.5
UL / CUL (Use Group)		B	C D
Rated voltage	V	300	300
Rated current	A	11	11
AWG conductor	AWG	-	-
CSA (Use Group)		B	C D
Rated voltage	V	300	300
Rated current	A	11	11
AWG conductor	AWG	-	-
General data			
Type of insulation material	LCP GF		
UL 94 flammability rating	V-0		
Contact base material	Copper alloy		
Material of contact surface	tinned		
Pin dimensions = d	mm	1.0, Octagonal	
Solder eyelet Ø = D	mm	1.3	
Solder eyelet Ø tolerance	mm	+ 0,1	

Product data

IEC: 320 V / 17.5 A
UL: 300 V / 11 A



For additional articles and information, refer to catalog.weidmueller.com

Note:

- Rated current related to rated cross-section & min. No. of poles.
- Rated data refer only to the component itself. Clearance and creepage distances to other components are to be designed in accordance with the relevant application standards.
- P on drawing = pitch

SCDV-THR 3.81/..../90G

closed side



Dimensioned drawing

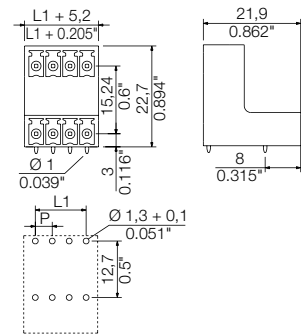

Accessories

Note: Refer to the Accessories chapter for additional accessories.

Coding	Order No.
SC-SMT 3.81 KO GY BX	1968900000

Ordering data

Solder pin length		3.2 mm		
Colour		black		
Pitch	3.81 mm			
Pol.	L1	(inch)	Qty.	Order No.
4	3.81	0.150	50	1033490000
6	7.62	0.300	50	1033510000
8	11.43	0.450	50	1033520000
10	15.24	0.600	50	1033530000
12	19.05	0.750	50	1033540000
14	22.86	0.900	50	1033550000
16	26.67	1.050	50	1033560000
18	30.48	1.200	50	1033570000
20	34.29	1.350	50	1033580000
22	38.10	1.500	50	1033590000
24	41.91	1.650	50	1033600000

K

3.81

90°

SCDV-THR 3.81/././90F

with screw flange



Dimensioned drawing

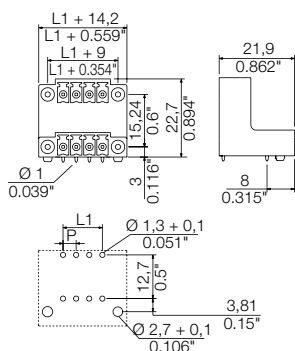

Ordering data

Solder pin length		3.2 mm		
Colour		black		
Pitch		3.81 mm		
Pol.	L1	(inch)	Qty.	Order No.
4	3.81	0.150	50	1033970000
6	7.62	0.300	50	1033980000
8	11.43	0.450	50	1033990000
10	15.24	0.600	50	1034010000
12	19.05	0.750	50	1034020000
14	22.86	0.900	50	1034030000
16	26.67	1.050	50	1034040000
18	30.48	1.200	50	1034050000
20	34.29	1.350	50	1034060000
22	38.10	1.500	50	1034070000
24	41.91	1.650	50	1034080000

Connectors in 3.81 mm pitch Series BC/SC 3.81

SCDV-THR 3.81/./180

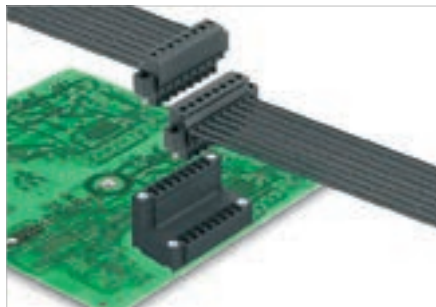

High-temperature-resistant, double-level male header for reflow soldering.

- Orientation: 180°
- Connections at two offset levels and open access to each row.
- Available in closed (G) version and with screw flange (F).

Weidmüller's 3.81 mm pitch (0.15 inch) plug-in connectors are compatible with the layouts of standard connectors and offer space for labelling and coding.

Technical data

In compliance with IEC 60664-1 / IEC 61984

Clamping range, max.			
Solid core H05(07) V-U			
Stranded H07 V-R			
Flexible H05(07) V-K			
Flexible with ferrule			
Ferrule with plastic collar			
Stripping length			
Screwdriver blade	mm		
According to norm			
Tightening torque range			
Rated current, max.	A	17.5	17
At ambient temperature		20°C	40°C
For conductor cross-section			
Overvoltage category		III	III II
Pollution severity		3	2 2
Rated voltage	V	160	160 320
Rated impulse voltage	kV	2.5	2.5 2.5
UL / CUL (Use Group)		B	C D
Rated voltage	V	300	300
Rated current	A	11	11
AWG conductor	AWG		-
CSA (Use Group)		B	C D
Rated voltage	V	300	300
Rated current	A	11	11
AWG conductor	AWG		-
General data			
Type of insulation material		LCP GF	
UL 94 flammability rating		V-0	
Contact base material		Copper alloy	
Material of contact surface		tinned	
Pin dimensions = d	mm	1.0, Octagonal	
Solder eyelet Ø = D	mm	1.3	
Solder eyelet Ø tolerance	mm	+ 0,1	

Product data

IEC: 320 V / 17.5 A
UL: 300 V / 11 A



For additional articles and information, refer to catalog.weidmueller.com

Note:

- Rated current related to rated cross-section & min. No. of poles.
- Rated data refer only to the component itself. Clearance and creepage distances to other components are to be designed in accordance with the relevant application standards.
- P on drawing = pitch

SCDV-THR 3.81/./180G

closed side



Dimensioned drawing

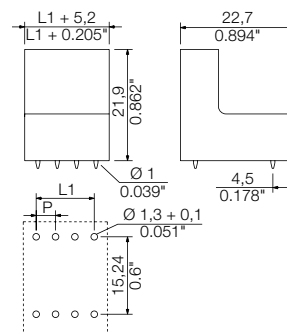

Accessories

Note: Refer to the Accessories chapter for additional accessories.

Coding	Order No.
SC-SMT 3.81 KO GY BX	1968900000
Mounting screw	
PTSC KA 2.2X4.5 WN1412	1610740000

Ordering data

Solder pin length		3.2 mm		
Colour		black		
Pitch	3.81 mm			
Pol.	L1	(inch)	Qty.	Order No.
4	3.81	0.150	50	1035470000
6	7.62	0.300	50	1035480000
8	11.43	0.450	50	1035490000
10	15.24	0.600	50	1035510000
12	19.05	0.750	50	1035520000
14	22.86	0.900	50	1035530000
16	26.67	1.050	50	1035540000
18	30.48	1.200	50	1035550000
20	34.29	1.350	50	1035560000
22	38.10	1.500	50	1035570000
24	41.91	1.650	50	1035580000

SCDV-THR 3.81/././180F

with screw flange



Dimensioned drawing

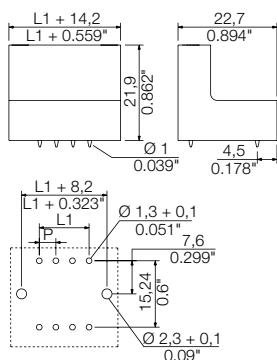

Ordering data

Solder pin length		3.2 mm		
Colour		black		
Pitch		3.81 mm		
Pol.	L1	(inch)	Qty.	Order No.
4	3.81	0.150	50	1035950000
6	7.62	0.300	50	1035960000
8	11.43	0.450	50	1035970000
10	15.24	0.600	50	1035980000
12	19.05	0.750	50	1035990000
14	22.86	0.900	50	1036010000
16	26.67	1.050	50	1036020000
18	30.48	1.200	50	1036030000
20	34.29	1.350	50	1036040000
22	38.10	1.500	50	1036050000
24	41.91	1.650	50	1036060000



SC 3.81/./90

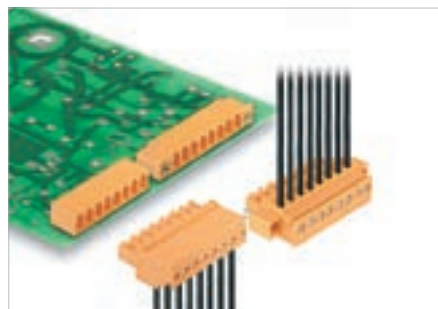

Male header with plugging direction in parallel to the circuit board.

- Available in closed (G) version and with screw flange (F)

Weidmüller's 3.81 mm pitch (0.15 inch) plug-in connectors are compatible with the layouts of standard connectors. They support a flood-light display and offer space for labelling and coding.

Technical data

In compliance with IEC 60664-1 / IEC 61984			
Clamping range, max.			
Solid core H05(07) V-U			
Stranded H07 V-R			
Flexible H05(07) V-K			
Flexible with ferrule			
Ferrule with plastic collar			
Stripping length			
Screwdriver blade	mm		
According to norm			
Tightening torque range			
Rated current, max.	A	17.5	17.5
At ambient temperature		20°C	40°C
For conductor cross-section			
Overvoltage category		III	III II
Pollution severity		3	2 2
Rated voltage	V	160	160 320
Rated impulse voltage	kV	2.5	2.5 2.5
UL / CUL (Use Group)		B	C D
Rated voltage	V	300	300
Rated current	A	10	10
AWG conductor	AWG		-
CSA (Use Group)		B	C D
Rated voltage	V	300	
Rated current	A	8	
AWG conductor	AWG		-
General data			
Type of insulation material		PA GF	
UL 94 flammability rating		V-0	
Contact base material		Copper alloy	
Material of contact surface		tinned	
Pin dimensions = d	mm	1.0, Octagonal	
Solder eyelet Ø = D	mm	1.2	
Solder eyelet Ø tolerance	mm	+ 0,1	

Product data

IEC: 320 V / 17.5 A
UL: 300 V / 10 A



For additional articles and information, refer to catalog.weidmueller.com

Note:

- Additional colours on request
- Rated current related to rated cross-section & min. No. of poles.
- Rated data refer only to the component itself. Clearance and creepage distances to other components are to be designed in accordance with the relevant application standards.
- P on drawing = pitch

SC 3.81/./90G

closed side



Dimensioned drawing

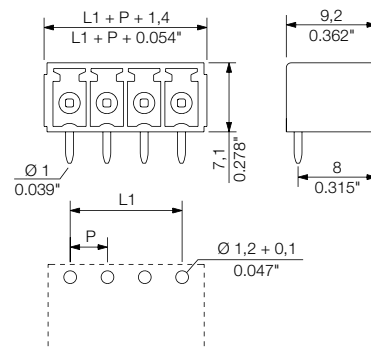

Accessories

Note: Refer to the Accessories chapter for additional accessories.

Coding		Order No.
	SC-SMT 3.81 KO GY BX	1968900000
LED light guide		
	SC 3.81 FLA 1.5/14.25	1979730000
	SC 3.81 FLA 2.3/14.25	1979750000
	SC 3.81 FLA 1.5/16	1979720000
	SC 3.81 FLA 2.3/16	1979740000

Ordering data

Solder pin length		3.2 mm		
Colour		orange		
Pitch		3.81 mm		
Pol.	L1	(inch)	Qty.	Order No.
2	3.81	0.150	198	1942020000
3	7.62	0.300	138	1942040000
4	11.43	0.450	108	1942070000
5	15.24	0.600	84	1942090000
6	19.05	0.750	72	1942100000
7	22.86	0.900	60	1942120000
8	26.67	1.050	54	1942130000
9	30.48	1.200	48	1942140000
10	34.29	1.350	42	1942150000
11	38.10	1.500	42	1942160000
12	41.91	1.650	36	1942170000

SC 3.81/..../90F

with screw flange



Dimensioned drawing

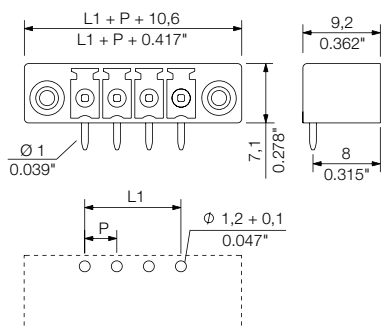

Ordering data

Solder pin length		3.2 mm	
Colour		orange	
Pitch		3.81 mm	
Pol.	L1	(inch)	Qty. Order No.
2	3.81	0.150	96 1942450000
3	7.62	0.300	78 1942460000
4	11.43	0.450	66 1942470000
5	15.24	0.600	60 1942480000
6	19.05	0.750	54 1942490000
7	22.86	0.900	48 1942500000
8	26.67	1.050	42 1942510000
9	30.48	1.200	36 1942520000
10	34.29	1.350	36 1942530000
11	38.10	1.500	30 1942540000
12	41.91	1.650	30 1942550000



Connectors in 3.81 mm pitch Series BC/SC 3.81

SC 3.81../180

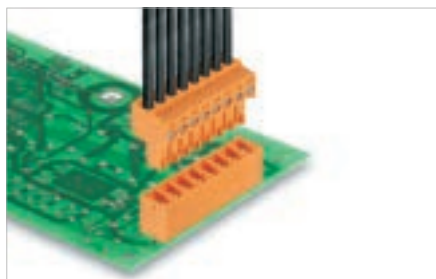

The 180° male header has a perpendicular plugging direction in relation to the circuit board. It is available in closed (G) and screw flange (F) versions.

Weidmüller's 3.81 mm pitch (0.15 inch) plug-in connectors are compatible with the layouts of standard connectors and offer space for labelling and coding.

Technical data

In compliance with IEC 60664-1 / IEC 61984

Clamping range, max.			
Solid core H05(07) V-U			
Stranded H07 V-R			
Flexible H05(07) V-K			
Flexible with ferrule			
Ferrule with plastic collar			
Stripping length			
Screwdriver blade	mm		
According to norm			
Tightening torque range			
Rated current, max.	A	17.5	17.5
At ambient temperature		20°C	40°C
For conductor cross-section			
Overvoltage category		III	III II
Pollution severity		3	2 2
Rated voltage	V	160	160 320
Rated impulse voltage	kV	2.5	2.5 2.5
UL / CUL (Use Group)		B	C D
Rated voltage	V	300	300
Rated current	A	10	10
AWG conductor	AWG		-
CSA (Use Group)		B	C D
Rated voltage	V	300	
Rated current	A	8	
AWG conductor	AWG		-
General data			
Type of insulation material		PA GF	
UL 94 flammability rating		V-0	
Contact base material		Copper alloy	
Material of contact surface		tinned	
Pin dimensions = d	mm	1.0, Octagonal	
Solder eyelet Ø = D	mm	1.2	
Solder eyelet Ø tolerance	mm	+ 0,1	

Product data

IEC: 320 V / 17.5 A
UL: 300 V / 10 A



For additional articles and information, refer to catalog.weidmueller.com

Note:

- Additional colours on request
- Rated current related to rated cross-section & min. No. of poles.
- Rated data refer only to the component itself. Clearance and creepage distances to other components are to be designed in accordance with the relevant application standards.
- P on drawing = pitch

SC 3.81../180G

closed side



Dimensioned drawing

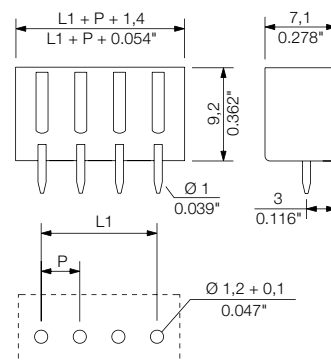

Accessories

Note: Refer to the Accessories chapter for additional accessories.

Coding	Order No.
SC-SMT 3.81 KO GY BX	1968900000
Mounting screw	
PTSC KA 2.2X4.5 WN1412	1610740000

Ordering data

Solder pin length		3.2 mm		
Colour		orange		
Pitch	3.81 mm			
Pol.	L1	(inch)	Qty.	Order No.
2	3.81	0.150	198	1942840000
3	7.62	0.300	138	1942850000
4	11.43	0.450	50	1942860000
5	15.24	0.600	84	1942870000
6	19.05	0.750	72	1942880000
7	22.86	0.900	60	1942890000
8	26.67	1.050	54	1942900000
9	30.48	1.200	48	1942910000
10	34.29	1.350	42	1942920000
11	38.10	1.500	42	1942930000
12	41.91	1.650	36	1942940000

SC 3.81/././180F

with screw flange



Dimensioned drawing

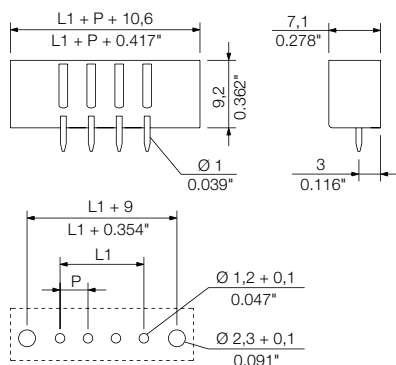

Ordering data

Solder pin length		3.2 mm	
Colour		orange	
Pitch		3.81 mm	
Pol.	L1	(inch)	Qty. Order No.
2	3.81	0.150	96 1943180000
3	7.62	0.300	78 1943190000
4	11.43	0.450	66 1943200000
5	15.24	0.600	60 1943210000
6	19.05	0.750	54 1943220000
7	22.86	0.900	48 1943230000
8	26.67	1.050	42 1943240000
9	30.48	1.200	36 1943250000
10	34.29	1.350	36 1943260000
11	38.10	1.500	30 1943270000
12	41.91	1.650	30 1943280000

Connectors in 3.81 mm pitch Series BC/SC 3.81

SC 3.81../135

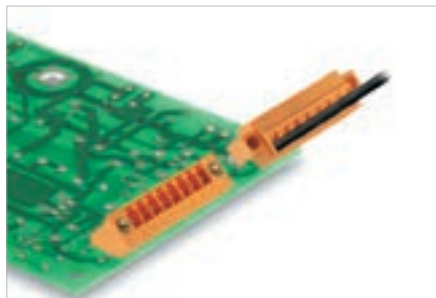

Male header with 135° plugging angle – (135° angle between the plugging direction and the solder pin). This corresponds to a 45° angle between the wire outlet and the circuit board.

- Available in Closed (G) version and with screw flange (F).

Weidmüller's 3.81 mm pitch (0.15 inch) plug-in connectors are compatible with the layouts of standard connectors and offer space for labelling and coding.

Technical data

In compliance with IEC 60664-1 / IEC 61984

Clamping range, max.			
Solid core H05(07) V-U			
Stranded H07 V-R			
Flexible H05(07) V-K			
Flexible with ferrule			
Ferrule with plastic collar			
Stripping length			
Screwdriver blade	mm		
According to norm			
Tightening torque range			
Rated current, max.	A	17.5	17.5
At ambient temperature		20°C	40°C
For conductor cross-section			
Overtolerance category		III	III II
Pollution severity		3	2 2
Rated voltage	V	160	160 320
Rated impulse voltage	kV	2.5	2.5 2.5
UL / CUL (Use Group)		B	C D
Rated voltage	V	300	300
Rated current	A	10	10
AWG conductor	AWG		-
CSA (Use Group)		B	C D
Rated voltage	V	300	
Rated current	A	11	
AWG conductor	AWG		-
General data			
Type of insulation material		PA GF	
UL 94 flammability rating		V-0	
Contact base material		Copper alloy	
Material of contact surface		tinned	
Pin dimensions = d	mm	1.0, Octagonal	
Solder eyelet Ø = D	mm	1.2	
Solder eyelet Ø tolerance	mm	+ 0,1	

Product data

IEC: 320 V / 17.5 A
UL: 300 V / 10 A



For additional articles and information, refer to catalog.weidmueller.com

Note:

- Additional colours on request
- Rated current related to rated cross-section & min. No. of poles.
- Rated data refer only to the component itself. Clearance and creepage distances to other components are to be designed in accordance with the relevant application standards.
- P on drawing = pitch

SC 3.81../135G

closed side



Dimensioned drawing

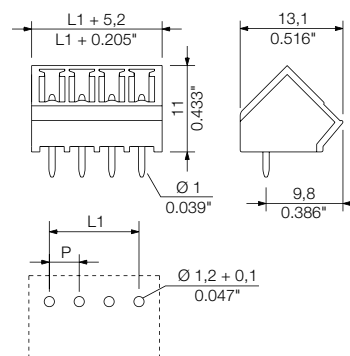

Accessories

Note: Refer to the Accessories chapter for additional accessories.

Coding	Order No.
SC-SMT 3.81 KO GY BX	1968900000

Ordering data

Solder pin length		3.2 mm		
Colour		orange		
Pitch	3.81 mm			
Pol.	L1	(inch)	Qty.	Order No.
2	3.81	0.150	50	1975720000
3	7.62	0.300	50	1975770000
4	11.43	0.450	50	1975800000
5	15.24	0.600	50	1975810000
6	19.05	0.750	50	1975880000
7	22.86	0.900	50	1975900000
8	26.67	1.050	50	1975920000
9	30.48	1.200	50	1975930000
10	34.29	1.350	50	1975940000
11	38.10	1.500	50	1975950000
12	41.91	1.650	50	1975960000

K

3.81

135°

SC 3.81/..../135F

with screw flange



Dimensioned drawing

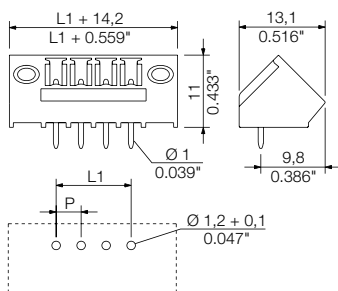

Ordering data

Solder pin length		3.2 mm	
Colour		orange	
Pitch		3.81 mm	
Pol.	L1	(inch)	Qty. Order No.
2	3.81	0.150	50 1976740000
3	7.62	0.300	50 1976750000
4	11.43	0.450	50 1976760000
5	15.24	0.600	50 1976770000
6	19.05	0.750	50 1976780000
7	22.86	0.900	50 1976790000
8	26.67	1.050	50 1976800000
9	30.48	1.200	50 1976810000
10	34.29	1.350	50 1976820000
11	38.10	1.500	50 1976830000
12	41.91	1.650	50 1976840000



SC 3.81/./270

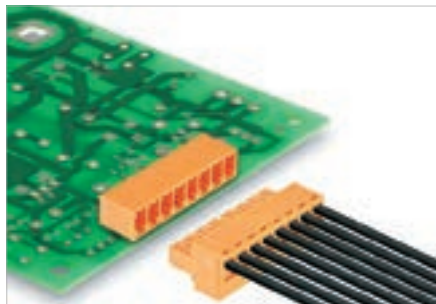

Male header with 270° plugging angle (270° angle between the plugging direction and the solder pin). This angle has a plugging direction that is parallel to the circuit board with female plugs plugged in upside down.

- Available in closed (G) version and with screw flange (F).

Weidmüller's 3.81 mm pitch (0.15 inch) plug-in connectors are compatible with the layouts of standard connectors and offer space for labelling and coding.

Technical data

In compliance with IEC 60664-1 / IEC 61984

Clamping range, max.			
Solid core H05(07) V-U			
Stranded H07 V-R			
Flexible H05(07) V-K			
Flexible with ferrule			
Ferrule with plastic collar			
Stripping length			
Screwdriver blade	mm		
According to norm			
Tightening torque range			
Rated current, max.	A	17.5	17.5
At ambient temperature		20°C	40°C
For conductor cross-section			
Overvoltage category		III	III II
Pollution severity		3	2 2
Rated voltage	V	160	160 320
Rated impulse voltage	kV	2.5	2.5 2.5
UL / CUL (Use Group)		B	C D
Rated voltage	V	300	300
Rated current	A	10	10
AWG conductor	AWG		-
CSA (Use Group)		B	C D
Rated voltage	V	300	
Rated current	A	8	
AWG conductor	AWG		-
General data			
Type of insulation material		PA GF	
UL 94 flammability rating		V-0	
Contact base material		Copper alloy	
Material of contact surface		tinned	
Pin dimensions = d	mm	1.0, Octagonal	
Solder eyelet Ø = D	mm	1.2	
Solder eyelet Ø tolerance	mm	+ 0,1	

Product data

IEC: 320 V / 17.5 A
UL: 300 V / 10 A



For additional articles and information, refer to catalog.weidmuller.com

Note:

- Additional colours on request
- Rated current related to rated cross-section & min. No. of poles.
- Rated data refer only to the component itself. Clearance and creepage distances to other components are to be designed in accordance with the relevant application standards.
- P on drawing = pitch

SC 3.81/./270G

closed side



Dimensioned drawing

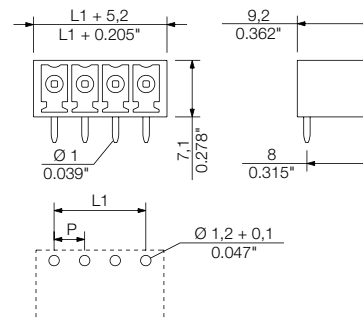

Accessories

Note: Refer to the Accessories chapter for additional accessories.

Coding	Order No.
SC-SMT 3.81 KO GY BX	1968900000

Ordering data

Solder pin length		3.2 mm		
Colour		orange		
Pitch	3.81 mm			
Pol.	L1	(inch)	Qty.	Order No.
2	3.81	0.150	50	1037490000
3	7.62	0.300	50	1037510000
4	11.43	0.450	50	1037520000
5	15.24	0.600	50	1037530000
6	19.05	0.750	50	1037540000
7	22.86	0.900	50	1037550000
8	26.67	1.050	50	1037560000
9	30.48	1.200	50	1037570000
10	34.29	1.350	50	1037580000
11	38.10	1.500	50	1037590000
12	41.91	1.650	50	1037610000

SC 3.81/..../270F

with screw flange



Dimensioned drawing

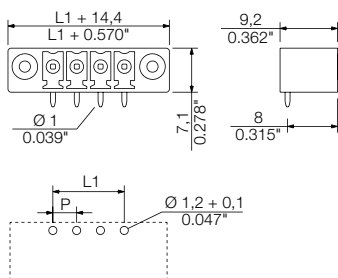

Ordering data

Solder pin length		3.2 mm	
Colour		orange	
Pitch		3.81 mm	
Pol.	L1	(inch)	Qty. Order No.
2	3.81	0.150	50 1038040000
3	7.62	0.300	50 1038050000
4	11.43	0.450	50 1038060000
5	15.24	0.600	50 1038070000
6	19.05	0.750	50 1038080000
7	22.86	0.900	50 1038090000
8	26.67	1.050	50 1038110000
9	30.48	1.200	50 1038130000
10	34.29	1.350	50 1038140000
11	38.10	1.500	50 1038150000
12	41.91	1.650	50 1038160000



SCD 3.81../90

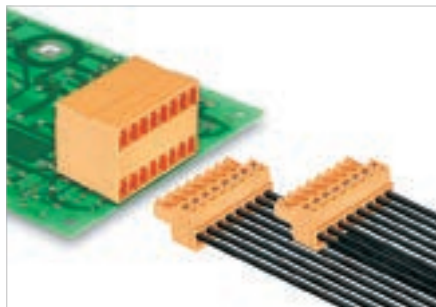

Double-level male header for wave soldering.

- Orientation: 90°
- Connections at the same level with access that is flush over the front of the board.
- Available in closed (G) version and with screw flange (F).

Weidmüller's 3.81 mm pitch (0.15 inch) plug-in connectors are compatible with the layouts of standard connectors and offer space for labelling and coding.

Technical data

In compliance with IEC 60664-1 / IEC 61984

Clamping range, max.			
Solid core H05(07) V-U			
Stranded H07 V-R			
Flexible H05(07) V-K			
Flexible with ferrule			
Ferrule with plastic collar			
Stripping length			
Screwdriver blade	mm		
According to norm			
Tightening torque range			
Rated current, max.	A	17.5	17
At ambient temperature		20°C	40°C
For conductor cross-section			
Overvoltage category		III	III II
Pollution severity		3	2 2
Rated voltage	V	160	160 320
Rated impulse voltage	kV	2.5	2.5 2.5
UL / CUL (Use Group)		B	C D
Rated voltage	V	300	300
Rated current	A	10	10
AWG conductor	AWG		-
CSA (Use Group)		B	C D
Rated voltage	V	300	
Rated current	A	11	
AWG conductor	AWG		-
General data			
Type of insulation material		PA GF	
UL 94 flammability rating		V-0	
Contact base material		Copper alloy	
Material of contact surface		tinned	
Pin dimensions = d	mm	1.0, Octagonal	
Solder eyelet Ø = D	mm	1.2	
Solder eyelet Ø tolerance	mm	+ 0,1	

Product data

IEC: 320 V / 17.5 A
UL: 300 V / 10 A



For additional articles and information, refer to catalog.weidmueller.com

Note:

- Additional colours on request
- Rated current related to rated cross-section & min. No. of poles.
- Rated data refer only to the component itself. Clearance and creepage distances to other components are to be designed in accordance with the relevant application standards.
- P on drawing = pitch

SCD 3.81../90G

closed side



Dimensioned drawing

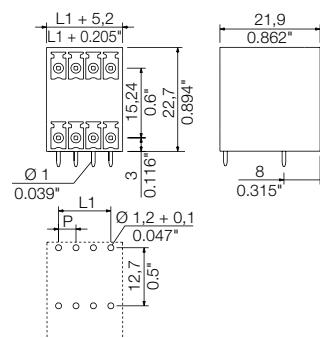

Accessories

Note: Refer to the Accessories chapter for additional accessories.

Coding	Order No.
SC-SMT 3.81 KO GY BX	1968900000

Ordering data

Solder pin length		3.2 mm		
Colour		orange		
Pitch	3.81 mm			
Pol.	L1	(inch)	Qty.	Order No.
4	3.81	0.150	132	1972790000
6	7.62	0.300	92	1972800000
8	11.43	0.450	72	1972810000
10	15.24	0.600	56	1972820000
12	19.05	0.750	48	1972830000
14	22.86	0.900	40	1972840000
16	26.67	1.050	36	1972850000
18	30.48	1.200	32	1972860000
20	34.29	1.350	28	1972870000
22	38.10	1.500	24	1972880000
24	41.91	1.650	24	1972890000

K

3.81

90°

SCD 3.81/.. /90F

with screw flange



Dimensioned drawing

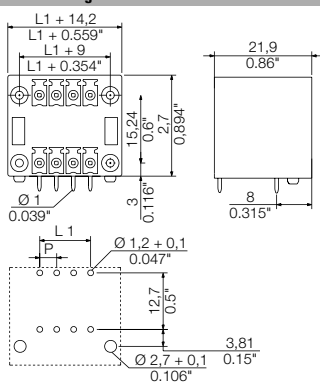

Ordering data

Solder pin length		3.2 mm		
Colour		orange		
Pitch		3.81 mm		
Pol.	L1	(inch)	Qty.	Order No.
4	3.81	0.150	64	1973260000
6	7.62	0.300	52	1973270000
8	11.43	0.450	44	1973280000
10	15.24	0.600	40	1973290000
12	19.05	0.750	36	1973300000
14	22.86	0.900	32	1973310000
16	26.67	1.050	28	1973320000
18	30.48	1.200	24	1973330000
20	34.29	1.350	24	1973340000
22	38.10	1.500	20	1973350000
24	41.91	1.650	20	1973360000



Connectors in 3.81 mm pitch Series BC/SC 3.81

SCD 3.81/./180

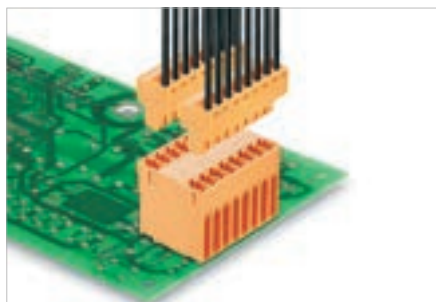

Double-level male header for wave soldering.

- Outlet direction: 180°
- Available in closed (G) version and with screw flange (F).

Weidmüller's 3.81 mm pitch (0.15 inch) plug-in connectors are compatible with the layouts of standard connectors and offer space for labelling and coding.

Technical data

In compliance with IEC 60664-1 / IEC 61984

Clamping range, max.			
Solid core H05(07) V-U			
Stranded H07 V-R			
Flexible H05(07) V-K			
Flexible with ferrule			
Ferrule with plastic collar			
Stripping length			
Screwdriver blade	mm		
According to norm			
Tightening torque range			
Rated current, max.	17.5	17	
At ambient temperature	20°C	40°C	
For conductor cross-section			
Overvoltage category	III	III	II
Pollution severity	3	2	2
Rated voltage	V	160	160 320
Rated impulse voltage	kV	2.5	2.5 2.5
UL / CUL (Use Group)		B	C D
Rated voltage	V	300	300
Rated current	A	10	10
AWG conductor	AWG	-	-
CSA (Use Group)		B	C D
Rated voltage	V	300	
Rated current	A	11	
AWG conductor	AWG	-	
General data			
Type of insulation material	PA GF		
UL 94 flammability rating	V-0		
Contact base material	Copper alloy		
Material of contact surface	tinned		
Pin dimensions = d	mm	1.0, Octagonal	
Solder eyelet Ø = D	mm	1.2	
Solder eyelet Ø tolerance	mm	+ 0,1	

Product data

IEC: 320 V / 17.5 A
UL: 300 V / 10 A



For additional articles and information, refer to catalog.weidmueller.com

Note:

- Additional colours on request
- Rated current related to rated cross-section & min. No. of poles.
- Rated data refer only to the component itself. Clearance and creepage distances to other components are to be designed in accordance with the relevant application standards.
- P on drawing = pitch

SCD 3.81/./180G

closed side



Dimensioned drawing

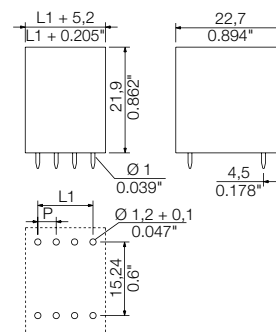

Accessories

Note: Refer to the Accessories chapter for additional accessories.

Coding	Order No.
SC-SMT 3.81 KO GY BX	1968900000
Mounting screw	
PTSC KA 2.2X4.5 WN1412	1610740000

Ordering data

Solder pin length		3.2 mm		
Colour		orange		
Pitch		3.81 mm		
Pol.	L1	(inch)	Qty.	Order No.
4	3.81	0.150	132	1029920000
6	7.62	0.300	92	1029940000
8	11.43	0.450	72	1029950000
10	15.24	0.600	56	1029960000
12	19.05	0.750	48	1029970000
14	22.86	0.900	40	1029980000
16	26.67	1.050	36	1029990000
18	30.48	1.200	32	1030010000
20	34.29	1.350	28	1030020000
22	38.10	1.500	24	1030030000
24	41.91	1.650	24	1030040000

K

3.81

180°

SCD 3.81/..../180F

with screw flange



Dimensioned drawing

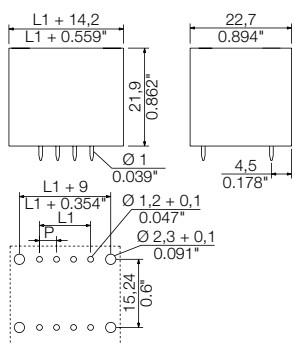

Ordering data

Solder pin length		3.2 mm		
Colour		orange		
Pitch		3.81 mm		
Pol.	L1	(inch)	Qty.	Order No.
4	3.81	0.150	64	1030440000
6	7.62	0.300	52	1030450000
8	11.43	0.450	44	1030460000
10	15.24	0.600	40	1030470000
12	19.05	0.750	36	1030480000
14	22.86	0.900	32	1030490000
16	26.67	1.050	28	1030510000
18	30.48	1.200	24	1030520000
20	34.29	1.350	24	1030530000
22	38.10	1.500	20	1030540000
24	41.91	1.650	20	1030550000

Connectors in 3.81 mm pitch Series BC/SC 3.81

SCDN 3.81/./90

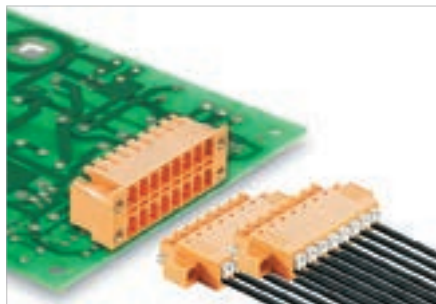

Compact double-level male header for wave soldering.

- For use with BCF 3.81 (PUSH IN) plugs.
- Orientation: 90°
- Designed for front panel applications.
- Available in closed (G) version or with screw flange (F).

Weidmüller's 3.81 mm pitch (0.15 inch) plug-in connectors are compatible with the layouts of standard connectors and offer space for labelling and coding.

Technical data

In compliance with IEC 60664-1 / IEC 61984

Clamping range, max.			
Solid core H05(07) V-U			
Stranded H07 V-R			
Flexible H05(07) V-K			
Flexible with ferrule			
Ferrule with plastic collar			
Stripping length			
Screwdriver blade	mm		
According to norm			
Tightening torque range			
Rated current, max.	A	17.5	17
At ambient temperature		20°C	40°C
For conductor cross-section			
Overvoltage category		III	III II
Pollution severity		3	2 2
Rated voltage	V	160	160 320
Rated impulse voltage	kV	2.5	2.5 2.5
UL / CUL (Use Group)	B C D		
Rated voltage	V	300	300
Rated current	A	10	10
AWG conductor	AWG	-	
CSA (Use Group)	B C D		
Rated voltage	V	300	300
Rated current	A	11	11
AWG conductor	AWG	-	
General data			
Type of insulation material	PA GF		
UL 94 flammability rating	V-0		
Contact base material	Copper alloy		
Material of contact surface	tinned		
Pin dimensions = d	mm	1.0, Octagonal	
Solder eyelet Ø = D	mm	1.2	
Solder eyelet Ø tolerance	mm	+ 0,1	

Product data

IEC: 320 V / 17.5 A
UL: 300 V / 10 A



For additional articles and information, refer to catalog.weidmueller.com

Note:

- Additional colours on request
- Rated current related to rated cross-section & min. No. of poles.
- Rated data refer only to the component itself. Clearance and creepage distances to other components are to be designed in accordance with the relevant application standards.
- P on drawing = pitch

SCDN 3.81/./90G

closed side



Dimensioned drawing

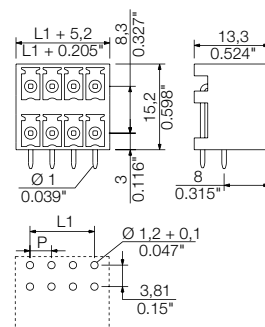

Accessories

Note: Refer to the Accessories chapter for additional accessories.

Coding	Order No.
SC-SMT 3.81 KO GY BX	1968900000

Ordering data

Solder pin length		3.2 mm		
Colour		orange		
Pitch	3.81 mm			
Pol.	L1	(inch)	Qty.	Order No.
4	3.81	0.150	50	1040410000
6	7.62	0.300	50	1040420000
8	11.43	0.450	50	1040430000
10	15.24	0.600	50	1040440000
12	19.05	0.750	50	1040450000
14	22.86	0.900	50	1040460000
16	26.67	1.050	50	1040470000
18	30.48	1.200	50	1040490000
20	34.29	1.350	50	1040510000
22	38.10	1.500	50	1040520000
24	41.91	1.650	50	1040530000

SCDN 3.81../90F

with screw flange



Dimensioned drawing

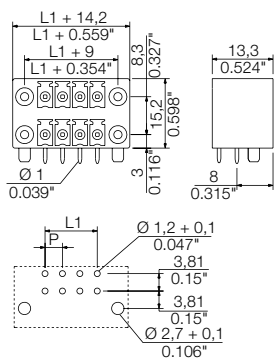

Ordering data

Solder pin length		3.2 mm		
Colour		orange		
Pitch		3.81 mm		
Pol.	L1	(inch)	Qty.	Order No.
4	3.81	0.150	50	1040960000
6	7.62	0.300	50	1040970000
8	11.43	0.450	50	1040980000
10	15.24	0.600	50	1040990000
12	19.05	0.750	50	1041000000
14	22.86	0.900	50	1041010000
16	26.67	1.050	50	1041020000
18	30.48	1.200	50	1041030000
20	34.29	1.350	50	1041040000
22	38.10	1.500	50	1041050000
24	41.91	1.650	50	1041060000



Connectors in 3.81 mm pitch Series BC/SC 3.81

SCDV 3.81../90

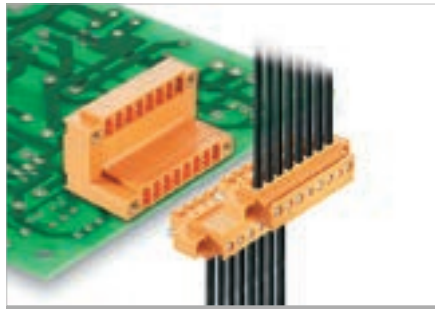

Double level male header for wave soldering.

- Orientation: 90°
- Connections at two offset levels with open access to each row.
- Available in closed (G) version or with screw flange (F).

Weidmüller's 3.81 mm pitch (0.15 inch) plug-in connectors are compatible with the layouts of standard connectors and offer space for labelling and coding.

Technical data

In compliance with IEC 60664-1 / IEC 61984

Clamping range, max.			
Solid core H05(07) V-U			
Stranded H07 V-R			
Flexible H05(07) V-K			
Flexible with ferrule			
Ferrule with plastic collar			
Stripping length			
Screwdriver blade	mm		
According to norm			
Tightening torque range			
Rated current, max.	17.5	17	
At ambient temperature	20°C	40°C	
For conductor cross-section			
Overvoltage category	III	III	II
Pollution severity	3	2	2
Rated voltage	V	160	160 320
Rated impulse voltage	kV	2.5	2.5 2.5
UL / CUL (Use Group)		B	C D
Rated voltage	V	300	300
Rated current	A	10	10
AWG conductor	AWG	-	-
CSA (Use Group)		B	C D
Rated voltage	V	300	300
Rated current	A	11	11
AWG conductor	AWG	-	-
General data			
Type of insulation material	PA GF		
UL 94 flammability rating	V-0		
Contact base material	Copper alloy		
Material of contact surface	tinned		
Pin dimensions = d	mm	1.0, Octagonal	
Solder eyelet Ø = D	mm	1.2	
Solder eyelet Ø tolerance	mm	+ 0,1	

Product data

IEC: 320 V / 17.5 A
UL: 300 V / 10 A



For additional articles and information, refer to catalog.weidmueller.com

Note:

- Additional colours on request
- Rated current related to rated cross-section & min. No. of poles.
- Rated data refer only to the component itself. Clearance and creepage distances to other components are to be designed in accordance with the relevant application standards.
- P on drawing = pitch

SCDV 3.81../90G

closed side



Dimensioned drawing

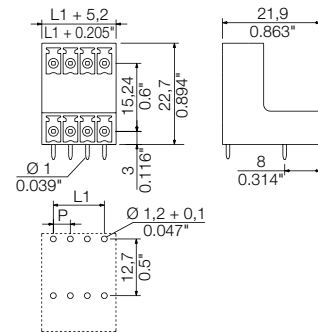

Accessories

Note: Refer to the Accessories chapter for additional accessories.

Coding	Order No.
SC-SMT 3.81 KO GY BX	1968900000

Ordering data

Solder pin length		3.2 mm		
Colour		orange		
Pitch	3.81 mm			
Pol.	L1	(inch)	Qty.	Order No.
4	3.81	0.150	50	1032090000
6	7.62	0.300	50	1032100000
8	11.43	0.450	50	1032120000
10	15.24	0.600	50	1032130000
12	19.05	0.750	50	1032140000
14	22.86	0.900	50	1032150000
16	26.67	1.050	50	1032160000
18	30.48	1.200	50	1032170000
20	34.29	1.350	50	1032190000
22	38.10	1.500	50	1032200000
24	41.91	1.650	50	1032210000

K

3.81

90°

SCDV 3.81/./90F

with screw flange



Dimensioned drawing

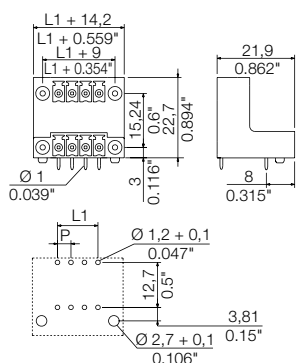

Ordering data

Solder pin length		3.2 mm		
Colour		orange		
Pitch		3.81 mm		
Pol.	L1	(inch)	Qty.	Order No.
4	3.81	0.150	50	1032580000
6	7.62	0.300	50	1032590000
8	11.43	0.450	50	1032600000
10	15.24	0.600	50	1032610000
12	19.05	0.750	50	1032620000
14	22.86	0.900	50	1032630000
16	26.67	1.050	50	1032640000
18	30.48	1.200	50	1032650000
20	34.29	1.350	50	1032660000
22	38.10	1.500	50	1032670000
24	41.91	1.650	50	1032680000

Connectors in 3.81 mm pitch Series BC/SC 3.81

SCDV 3.81/./180

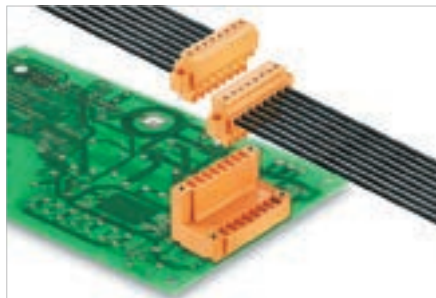

Double-level male header for wave soldering.

- Orientation: 180°.
- Connections at two offset levels with open access to each row.
- Available in closed (G) version or with screw flange (F).

Weidmüller's 3.81 mm pitch (0.15 inch) plug-in connectors are compatible with the layouts of standard connectors and offer space for labelling and coding.

Product data

IEC: 320 V / 17.5 A
UL: 300 V / 10 A



For additional articles and information, refer to catalog.weidmueller.com

Note:

- Additional colours on request
- Rated current related to rated cross-section & min. No. of poles.
- Rated data refer only to the component itself. Clearance and creepage distances to other components are to be designed in accordance with the relevant application standards.
- P on drawing = pitch
- Rated data refer only to the component itself. Clearance and creepage distances to other components are to be designed in accordance with the relevant application standards.
- For additional mechanical support for male connectors with screw flange (...F), we recommend an additional cable gland with fastening screws (sheet metal screw ISO 1481-ST 2.2x4.5 C or ISO 7049-ST 2.2x4.5 C - see Accessories). Cable gland only permitted before soldering.

SCDV 3.81/./180G

closed side



Dimensioned drawing

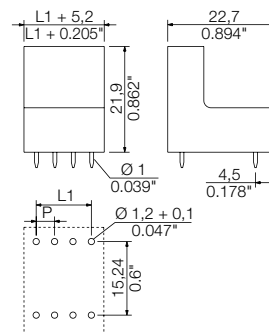

Technical data

In compliance with IEC 60664-1 / IEC 61984

Clamping range, max.			
Solid core H05(07) V-U			
Stranded H07 V-R			
Flexible H05(07) V-K			
Flexible with ferrule			
Ferrule with plastic collar			
Stripping length			
Screwdriver blade	mm		
According to norm			
Tightening torque range			
Rated current, max.		17.5	17
At ambient temperature		20°C	40°C
For conductor cross-section			
Overvoltage category		III	III II
Pollution severity		3	2 2
Rated voltage	V	160	160 320
Rated impulse voltage	kV	2.5	2.5 2.5
UL / CUL (Use Group)		B	C D
Rated voltage	V	300	300
Rated current	A	10	10
AWG conductor	AWG		-
CSA (Use Group)		B	C D
Rated voltage	V	300	300
Rated current	A	11	11
AWG conductor	AWG		-
General data			
Type of insulation material		PA GF	
UL 94 flammability rating		V-0	
Contact base material		Copper alloy	
Material of contact surface		tinned	
Pin dimensions = d	mm	1.0, Octagonal	
Solder eyelet Ø = D	mm	1.2	
Solder eyelet Ø tolerance	mm	+ 0,1	

Accessories

Note: Refer to the Accessories chapter for additional accessories.

Coding		Order No.
	SC-SMT 3.81 KO GY BX	1968900000
Mounting screw		
	PTSC KA 2.2x4.5 WN1412	1610740000

Ordering data

Solder pin length		3.2 mm		
Colour		orange		
Pitch	3.81 mm			
Pol.	L1	(inch)	Qty.	Order No.
4	3.81	0.150	50	1034470000
6	7.62	0.300	50	1034490000
8	11.43	0.450	50	1034510000
10	15.24	0.600	50	1034520000
12	19.05	0.750	50	1034530000
14	22.86	0.900	50	1034540000
16	26.67	1.050	50	1034550000
18	30.48	1.200	50	1034560000
20	34.29	1.350	50	1034570000
22	38.10	1.500	50	1034580000
24	41.91	1.650	50	1034590000

SCDV 3.81/./180F

with screw flange



Dimensioned drawing

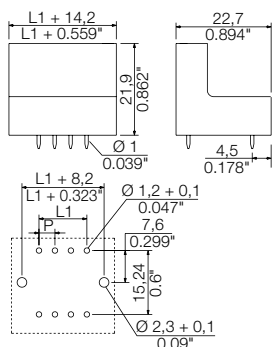

Ordering data

Solder pin length		3.2 mm		
Colour		orange		
Pitch		3.81 mm		
Pol.	L1	(inch)	Qty.	Order No.
4	3.81	0.150	50	1034980000
6	7.62	0.300	50	1034990000
8	11.43	0.450	50	1035010000
10	15.24	0.600	50	1035020000
12	19.05	0.750	50	1035030000
14	22.86	0.900	50	1035040000
16	26.67	1.050	50	1035050000
18	30.48	1.200	50	1035060000
20	34.29	1.350	50	1035070000
22	38.10	1.500	50	1035080000
24	41.91	1.650	50	1035090000

SCZ 3.81../180



Inverted male plug with screw connection:

- Wire-to-wire connection with the BCZ female plug
- Board-to-wire connection with the BCL-SMT female header.
- Available in closed (G) version, screw flange (F), inverted flange (FI) and with lock and release lever (LR).

Weidmüller's 3.81 mm pitch (0.15 inch) plug-in connectors are compatible with the layouts of standard connectors and offer space for labelling and coding.

Technical data

In compliance with IEC 60664-1 / IEC 61984			
Clamping range, max.	mm ²	0.08...1.5	
Solid core H05(07) V-U	mm²	0.2...1.5	
Stranded H07 V-R			
Flexible H05(07) V-K	mm ²	0.2...1.5	
Flexible with ferrule	mm ²	0.2...1.5	
Ferrule with plastic collar	mm ²	0.2...1.5	
Stripping length	mm	7	
Screwdriver blade	mm	0.4 x 2.5	
		According to norm	
Tightening torque range			
Rated current, max.	A	17.5	17.5
At ambient temperature		20°C	40°C
For conductor cross-section	mm ²	1	
Overtoltage category		III	III II
Pollution severity		3	2 2
Rated voltage	V	160	160 320
Rated impulse voltage	kV	2.5	2.5 2.5
UL / CUL (Use Group)		B	C D
Rated voltage	V	300	300
Rated current	A	10	10
AWG conductor	AWG	28-16	
CSA (Use Group)		B	C D
Rated voltage	V	300	50
Rated current	A	11	11
AWG conductor	AWG	28-16	
General data			
Type of insulation material		PA 66 GF 30	
UL 94 flammability rating		V-0	
Contact base material		Copper alloy	
Material of contact surface		tinned	
Pin dimensions = d	mm		
Solder eyelet Ø = D	mm		
Solder eyelet Ø tolerance	mm		

Product data

IEC: 320 V / 17.5 A / 0.2 - 1.5 mm²
UL: 300 V / 10 A / AWG 28 - 16



For additional articles and information, refer to catalog.weidmueller.com

Note:

- Additional colours on request
- Rated current related to rated cross-section & min. No. of poles.
- Wire end ferrule with plastic collar to DIN 46228/4
- P on drawing = pitch
- Rated data refer only to the component itself. Clearance and creepage distances to other components are to be designed in accordance with the relevant application standards.

SCZ 3.81../180G



Dimensioned drawing

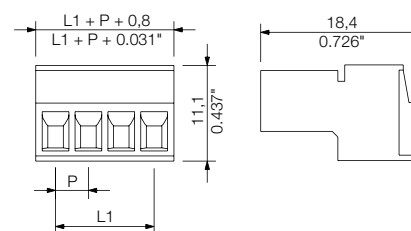

Accessories

Note: Refer to the Accessories chapter for additional accessories.

Coding		Order No.
	SC-SMT 3.81 KO GY BX	1968900000
Screwdriver		
	SDS 0.4X2.5X75	2749320000
	SDIS 0.4X2.5X75	2749790000

Ordering data

Solder pin length					
Colour	orange				
Pitch	3.81 mm				
Pol.	L1	(inch)	Qty.	Order No.	
2	3.81	0.150	50	1969520000	
3	7.62	0.300	50	1969540000	
4	11.43	0.450	50	1969560000	
5	15.24	0.600	50	1969570000	
6	19.05	0.750	50	1969580000	
7	22.86	0.900	50	1969590000	
8	26.67	1.050	50	1969610000	
9	30.48	1.200	50	1969630000	
10	34.29	1.350	50	1969640000	
11	38.10	1.500	50	1969660000	
12	41.91	1.650	50	1969670000	

Representative deratings curve

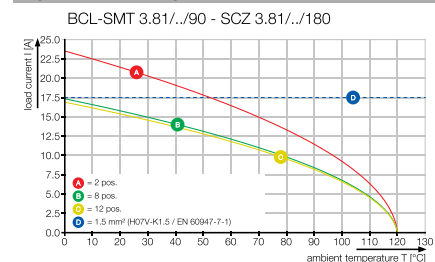

SCZ 3.81../180F

with screw flange



Dimensioned drawing

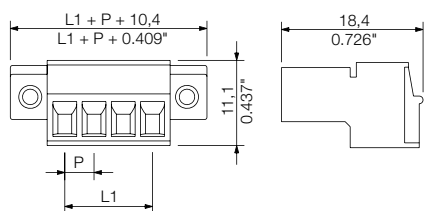

Ordering data

Solder pin length					
Colour					orange
Pitch 3.81 mm					
Pol.	L1	(inch)	Qty.	Order No.	
2	3.81	0.150	50	1970910000	
3	7.62	0.300	50	1970920000	
4	11.43	0.450	50	1970930000	
5	15.24	0.600	50	1970940000	
6	19.05	0.750	50	1970960000	
7	22.86	0.900	50	1970970000	
8	26.67	1.050	50	1970980000	
9	30.48	1.200	50	1970990000	
10	34.29	1.350	50	1971000000	
11	38.10	1.500	50	1971010000	
12	41.91	1.650	50	1971020000	

SCZ 3.81../180FI

with inverted flange



Dimensioned drawing

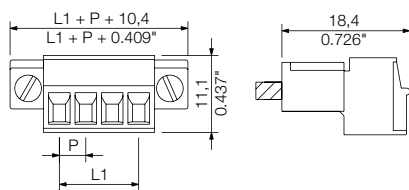

Ordering data

Solder pin length					
Colour					orange
Pitch 3.81 mm					
Pol.	L1	(inch)	Qty.	Order No.	
2	3.81	0.150	50	1970260000	
3	7.62	0.300	50	1970270000	
4	11.43	0.450	50	1970310000	
5	15.24	0.600	50	1970320000	
6	19.05	0.750	50	1970340000	
7	22.86	0.900	50	1970350000	
8	26.67	1.050	50	1970360000	
9	30.48	1.200	50	1970390000	
10	34.29	1.350	50	1970410000	
11	38.10	1.500	50	1970420000	
12	41.91	1.650	50	1970430000	

SCZ 3.81../180LR



Dimensioned drawing

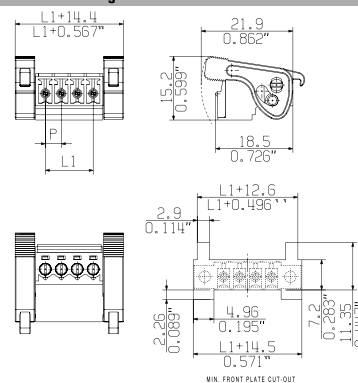

Ordering data

Solder pin length					
Colour					orange
Pitch 3.81 mm					
Pol.	L1	(inch)	Qty.	Order No.	
2	3.81	0.150	50	2442050000	
3	7.62	0.300	50	2444060000	
4	11.43	0.450	50	2444090000	
5	15.24	0.600	50	2444100000	
6	19.05	0.750	50	2444110000	
7	22.86	0.900	50	2444120000	
8	26.67	1.050	50	2444130000	
9	30.48	1.200	50	2444140000	
10	34.29	1.350	50	2444150000	
11	38.10	1.500	50	2444160000	
12	41.91	1.650	50	2444170000	

K

Additional deratings curves

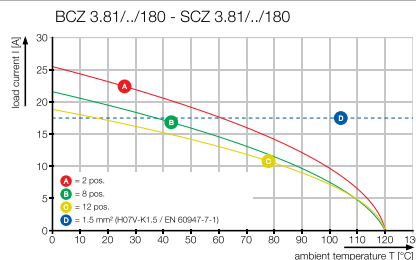
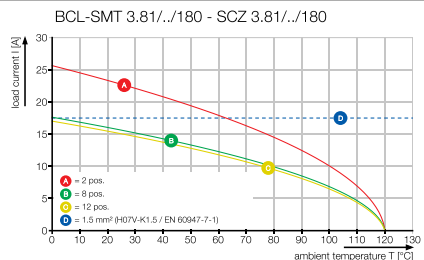

SCZ 3.81../180 ZE



Inverted male plug with screw connection and strain relief for the connected wire.

- Wire-to-wire connection with female plugs.
- Board-to-wire connection with BCL-SMT female header.
- Available in closed (G) version, screw flange (F), inverted flange (FI) and with lock and release lever (LR).

Weidmüller's 3.81 mm pitch (0.15 inch) plug-in connectors are compatible with the layouts of standard connectors and offer space for labelling and coding.

Technical data

In compliance with IEC 60664-1 / IEC 61984

Clamping range, max.	mm ²	0.08...1.5
Solid core H05(07) V-U	mm ²	0.2...1.5
Stranded H07 V-R		
Flexible H05(07) V-K	mm ²	0.2...1.5
Flexible with ferrule	mm ²	0.2...1.5
Ferrule with plastic collar	mm ²	0.2...1.5
Stripping length	mm	7
Screwdriver blade	mm	0.4 x 2.5
According to norm		DIN 5264
Tightening torque range		
Rated current, max.	A	17.5 17.5
At ambient temperature	20°C 40°C	
For conductor cross-section	mm ²	1
Overtoltage category		III III II
Pollution severity		3 2 2
Rated voltage	V	160 160 320
Rated impulse voltage	kV	2.5 2.5 2.5
UL / CUL (Use Group)	B C D	
Rated voltage	V	300 300
Rated current	A	10 10
AWG conductor	AWG	28-16
CSA (Use Group)	B C D	
Rated voltage	V	300 50
Rated current	A	11 11
AWG conductor	AWG	28-16
General data		
Type of insulation material		PA 66 GF 30
UL 94 flammability rating		V-0
Contact base material		Copper alloy
Material of contact surface		tinned
Pin dimensions = d	mm	
Solder eyelet Ø = D	mm	
Solder eyelet Ø tolerance	mm	

Product data

IEC: 320 V / 17.5 A / 0.2 - 1.5 mm²
UL: 300 V / 10 A / AWG 28 - 16



For additional articles and information, refer to catalog.weidmueller.com

Note:

- Additional colours on request
- Rated current related to rated cross-section & min. No. of poles.
- Wire end ferrule with plastic collar to DIN 46228/4
- P on drawing = pitch
- Rated data refer only to the component itself. Clearance and creepage distances to other components are to be designed in accordance with the relevant application standards.

SCZ 3.81../180GZE

with strain relief



Dimensioned drawing

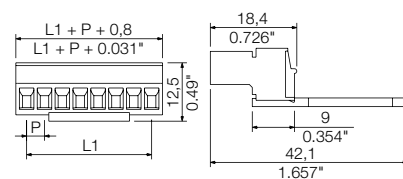

Accessories

Note: Refer to the Accessories chapter for additional accessories.

Coding	Order No.
SC-SMT 3.81 KO GY BX	1968900000
Screwdriver	
SDS 0.4X2.5X75	2749320000
SDIS 0.4X2.5X75	2749790000

Ordering data

Solder pin length				
Colour	orange			
Pitch	3.81 mm			
Pol.	L1	(inch)	Qty.	Order No.
4	11.43	0.450	50	1237000000
5	15.24	0.600	50	1237010000
6	19.05	0.750	50	1237020000
7	22.86	0.900	50	1237030000
8	26.67	1.050	50	1237040000
9	30.48	1.200	50	1237070000
10	34.29	1.350	50	1237080000
11	38.10	1.500	50	1237090000
12	41.91	1.650	50	1237100000

from 10 pole 2 strain reliefs per plug-in connector

Representative deratings curve

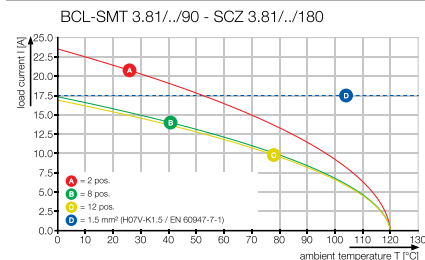

from 10 pole 2 strain reliefs per plug-in connector

SCZ 3.81../180FZE

with screw flange and strain relief



Dimensioned drawing

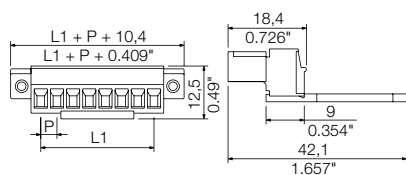

Ordering data

Solder pin length					
Colour		orange			
Pitch 3.81 mm					
Pol.	L1	(inch)	Qty.	Order No.	
4	11.43	0.450	50	1237120000	
5	15.24	0.600	50	1237130000	
6	19.05	0.750	50	1237140000	
7	22.86	0.900	50	1237170000	
8	26.67	1.050	50	1237180000	
9	30.48	1.200	50	1237190000	
10	34.29	1.350	50	1237200000	
11	38.10	1.500	50	1237210000	
12	41.91	1.650	50	1237220000	

SCZ 3.81../180FZE

with inverted screw flange and strain relief



Dimensioned drawing

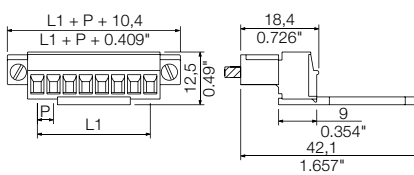

Ordering data

Solder pin length					
Colour		orange			
Pitch 3.81 mm					
Pol.	L1	(inch)	Qty.	Order No.	
4	11.43	0.450	50	1237550000	
5	15.24	0.600	50	1237560000	
6	19.05	0.750	50	1237570000	
7	22.86	0.900	50	1237580000	
8	26.67	1.050	50	1237590000	
9	30.48	1.200	50	1237610000	
10	34.29	1.350	50	1237620000	
11	38.10	1.500	50	1237630000	
12	41.91	1.650	50	1237640000	

SCZ 3.81../180LRZE

with screw flange and strain relief



Dimensioned drawing

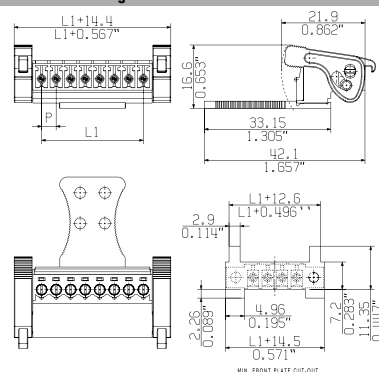

Ordering data

Solder pin length					
Colour		orange			
Pitch 3.81 mm					
Pol.	L1	(inch)	Qty.	Order No.	
4	11.43	0.450	50	2444240000	
5	15.24	0.600	50	2444220000	
6	19.05	0.750	50	2444270000	
7	22.86	0.900	50	2444200000	
8	26.67	1.050	50	2444260000	
9	30.48	1.200	50	2444230000	
10	34.29	1.350	50	2444290000	
11	38.10	1.500	50	2444250000	
12	41.91	1.650	50	2444280000	

from 10 pole 2 strain reliefs per plug-in connector

from 10 pole 2 strain reliefs per plug-in connector

Additional deratings curves

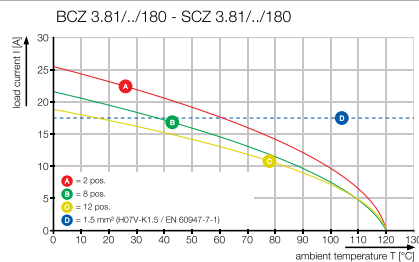
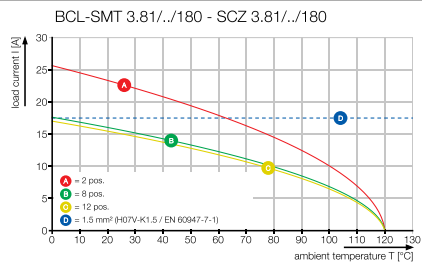

Connectors in 3.81 mm pitch Series BC/SC 3.81

BCZ 3.81../180

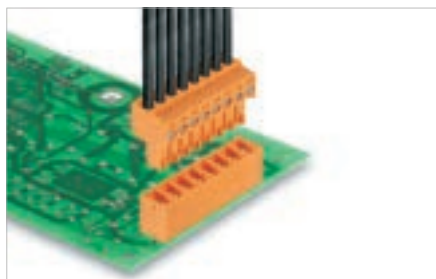

Female plug with screw connection. Wire outlet 180° (wire is straight on to the direction of plugging).

- Available in closed version, with screw flange (F) and lock and release-lever (LR).

Weidmüller's 3.81 mm pitch (0.15 inch) plug-in connectors are compatible with the layouts of standard connectors and offer space for labelling and coding.

Technical data

In compliance with IEC 60664-1 / IEC 61984			
Clamping range, max.	mm ²	0.08...1.5	
Solid core H05(07) V-U	mm²	0.2...1.5	
Stranded H07 V-R			
Flexible H05(07) V-K	mm ²	0.2...1.5	
Flexible with ferrule	mm ²	0.2...1.5	
Ferrule with plastic collar	mm ²	0.2...1.5	
Stripping length	mm	7	
Screwdriver blade	mm	0.4 x 2.5	
		According to norm DIN 5264	
Tightening torque range			
Rated current, max.	A	17.5	17
At ambient temperature		20°C	40°C
For conductor cross-section	mm ²	1	
Overvoltage category		III	III II
Pollution severity		3	2 2
Rated voltage	V	160	160 320
Rated impulse voltage	kV	2.5	2.5 2.5
UL / CUL (Use Group)		B	C D
Rated voltage	V	300	300
Rated current	A	10	10
AWG conductor	AWG	28-16	
CSA (Use Group)		B	C D
Rated voltage	V	300	50
Rated current	A	8	8
AWG conductor	AWG	28-16	
General data			
Type of insulation material		PA 66 GF 30	
UL 94 flammability rating		V-0	
Contact base material		Copper alloy	
Material of contact surface		tinned	
Pin dimensions = d	mm		
Solder eyelet Ø = D	mm		
Solder eyelet Ø tolerance	mm		

Product data

IEC: 320 V / 17.5 A / 0.2 - 1.5 mm²
UL: 300 V / 10 A / AWG 28 - 16



For additional articles and information, refer to catalog.weidmueller.com

Note:

- Additional colours on request
- Rated current related to rated cross-section & min. No. of poles.
- Wire end ferrule without plastic collar to DIN 46228/1
- Wire end ferrule with plastic collar to DIN 46228/4
- P on drawing = pitch
- Rated data refer only to the component itself. Clearance and creepage distances to other components are to be designed in accordance with the relevant application standards.

BCZ 3.81../180



Dimensioned drawing

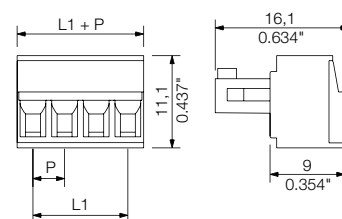

Accessories

Note: Refer to the Accessories chapter for additional accessories.

Hood	Order No.
BCZ 3.81 AH03 BK BX	1005280000
BCZ 3.81 AH04 BK BX	1005290000
BCZ 3.81 AH05 BK BX	1005300000
BCZ 3.81 AH06 BK BX	1005310000
BCZ 3.81 AH07 BK BX	1005320000
BCZ 3.81 AH08 BK BX	1005330000
BCZ 3.81 AH09 BK BX	1005340000
BCZ 3.81 AH10 BK BX	1005350000
BCZ 3.81 AH12 BK BX	1005370000
BCZ 3.81 AH13 BK BX	1005380000
BCZ 3.81 AH14 BK BX	1005390000
BCZ 3.81 AH15 BK BX	1005400000
BCZ 3.81 AH16 BK BX	1005410000

Screwdriver	Order No.
SDS 0.4X2.5X75	2749320000
SDIS 0.4X2.5X75	2749790000

Ordering data

Solder pin length				
Colour	orange			
Pitch	3.81 mm			
Pol.	L1	(inch)	Qty.	Order No.
2	3.81	0.150	50	1940730000
3	7.62	0.300	50	1940740000
4	11.43	0.450	50	1940750000
5	15.24	0.600	50	1940760000
6	19.05	0.750	50	1940770000
7	22.86	0.900	50	1940780000
8	26.67	1.050	50	1940790000
9	30.48	1.200	50	1940800000
10	34.29	1.350	50	1940810000
11	38.10	1.500	50	1940820000
12	41.91	1.650	50	1940830000

Representative deratings curve

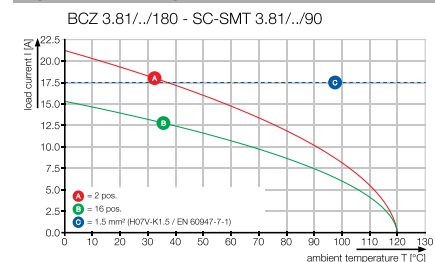

K

3.81

180°

1.5 mm²

BCZ 3.81../180F

with screw flange



Dimensioned drawing

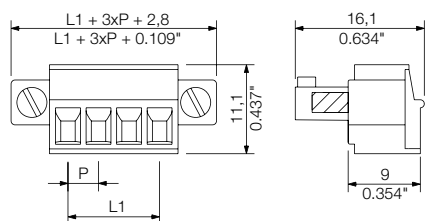

Ordering data

Solder pin length					
Colour		orange			
Pitch		3.81 mm			
Pol.	L1	(inch)	Qty.	Order No.	
2	3.81	0.150	50	1941010000	
3	7.62	0.300	50	1941020000	
4	11.43	0.450	50	1941030000	
5	15.24	0.600	50	1941040000	
6	19.05	0.750	50	1941050000	
7	22.86	0.900	50	1941060000	
8	26.67	1.050	50	1941070000	
9	30.48	1.200	50	1941080000	
10	34.29	1.350	50	1941090000	
11	38.10	1.500	50	1941100000	
12	41.91	1.650	50	1941110000	

BCZ 3.81../180LR



Dimensioned drawing

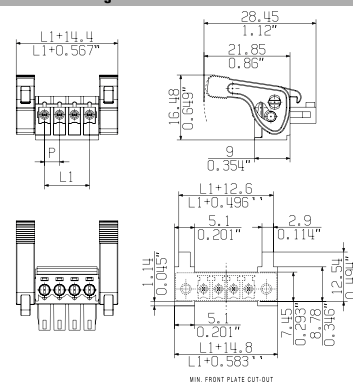

Ordering data

Solder pin length					
Colour		orange			
Pitch		3.81 mm			
Pol.	L1	(inch)	Qty.	Order No.	
2	3.81	0.150	50	2442360000	
3	7.62	0.300	50	2442370000	
4	11.43	0.450	50	2442310000	
5	15.24	0.600	50	2442320000	
6	19.05	0.750	50	2442330000	
7	22.86	0.900	50	2442340000	
8	26.67	1.050	50	2442380000	
9	30.48	1.200	50	2442390000	
10	34.29	1.350	50	2442400000	
11	38.10	1.500	50	2442350000	
12	41.91	1.650	50	2442410000	



Additional deratings curves

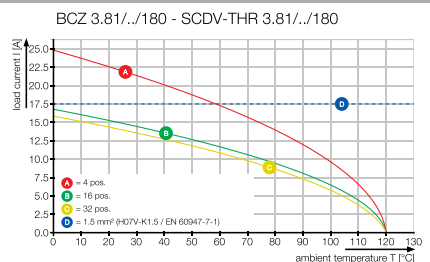
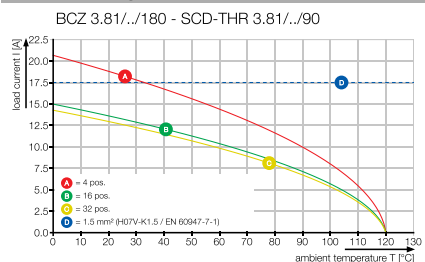

Connectors in 3.81 mm pitch Series BC/SC 3.81

BCZ 3.81../180 ZE



Female plug with screw connection and strain relief for the connected wire. Wire outlet 180° (wire is straight on to the direction of plugging).

- Available in closed version, with screw flange (F) and lock and release-lever (LR).

Weidmüller's 3.81 mm pitch (0.15 inch) plug-in connectors are compatible with the layouts of standard connectors and offer space for labelling and coding.

Technical data

In compliance with IEC 60664-1 / IEC 61984

Clamping range, max.	mm ²	0.08...1.5
Solid core H05(07) V-U	mm²	0.2...1.5
Stranded H07 V-R		
Flexible H05(07) V-K	mm ²	0.2...1.5
Flexible with ferrule	mm ²	0.2...1.5
Ferrule with plastic collar	mm ²	0.2...1.5
Stripping length	mm	7
Screwdriver blade	mm	0.4 x 2.5
According to norm		DIN 5264

Tightening torque range

Rated current, max.	A	17.5	17
At ambient temperature		20°C	40°C

For conductor cross-section	mm ²	1
Overtoltage category		III III II
Pollution severity		3 2 2

Rated voltage	V	160	160	320
Rated impulse voltage	kV	2.5	2.5	2.5

UL / CUL (Use Group)

Rated voltage	V	300	300
Rated current	A	10	10
AWG conductor	AWG	28-16	

CSA (Use Group)

Rated voltage	V	300	50
Rated current	A	8	8
AWG conductor	AWG	28-16	

General data

Type of insulation material		PA 66 GF 30
UL 94 flammability rating		V-0
Contact base material		Copper alloy
Material of contact surface		tinned
Pin dimensions = d	mm	
Solder eyelet Ø = D	mm	
Solder eyelet Ø tolerance	mm	

Product data

IEC: 320 V / 17.5 A / 0.2 - 1.5 mm²
UL: 300 V / 10 A / AWG 28 - 16



For additional articles and information, refer to catalog.weidmueller.com

Note:

- Additional colours on request
- Rated current related to rated cross-section & min. No. of poles.
- Wire end ferrule without plastic collar to DIN 46228/1
- Wire end ferrule with plastic collar to DIN 46228/4
- P on drawing = pitch
- Rated data refer only to the component itself. Clearance and creepage distances to other components are to be designed in accordance with the relevant application standards.

BCZ 3.81../180ZE

with strain relief



Dimensioned drawing

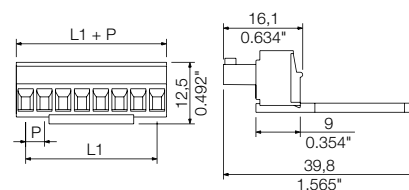

Accessories

Note: Refer to the Accessories chapter for additional accessories.

Screwdriver		Order No.
	SDS 0.4X2.5X75	2749320000
	SDIS 0.4X2.5X75	2749790000

Ordering data

Solder pin length				
Colour	orange			
Pitch	3.81 mm			
Pol.	L1	(inch)	Qty.	Order No.
5	15.24	0.600	50	1236270000
6	19.05	0.750	50	1236280000
7	22.86	0.900	50	1236290000
8	26.67	1.050	50	1236300000
9	30.48	1.200	50	1236320000
10	34.29	1.350	50	1236330000
11	38.10	1.500	50	1236340000
12	41.91	1.650	50	1236370000

from 10 pole 2 strain reliefs per plug-in connector

Representative deratings curve

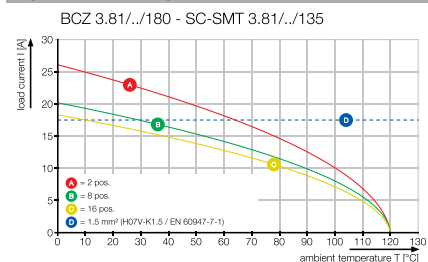

from 10 pole 2 strain reliefs per plug-in connector

K

3.81

180°

1.5 mm²

BCZ 3.81../180FZE

with screw flange and strain relief



Dimensioned drawing

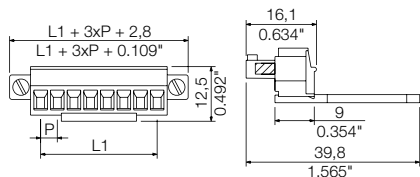

Ordering data

Solder pin length					
Colour		orange			
Pitch		3.81 mm			
Pol.	L1	(inch)	Qty.	Order No.	
5	15.24	0.600	50	1236530000	
6	19.05	0.750	50	1236540000	
7	22.86	0.900	50	1236570000	
8	26.67	1.050	50	1236590000	
9	30.48	1.200	50	1236600000	
10	34.29	1.350	50	1236610000	
11	38.10	1.500	50	1236620000	
12	41.91	1.650	50	1236630000	

BCZ 3.81../180LRZE



Dimensioned drawing

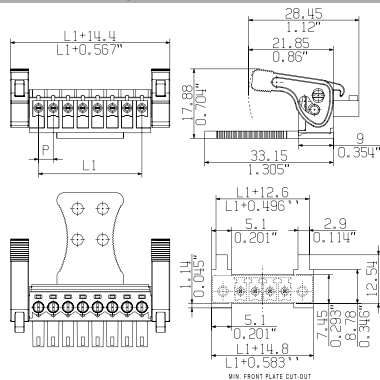

Ordering data

Solder pin length					
Colour		orange			
Pitch		3.81 mm			
Pol.	L1	(inch)	Qty.	Order No.	
5	15.24	0.600	50	2442030000	
6	19.05	0.750	50	2442260000	
7	22.86	0.900	50	2442210000	
8	26.67	1.050	50	2442290000	
9	30.48	1.200	50	2442300000	
10	34.29	1.350	50	2442240000	
11	38.10	1.500	50	2442220000	
12	41.91	1.650	50	2442270000	

from 10 pole 2 strain reliefs per plug-in connector

Additional deratings curves

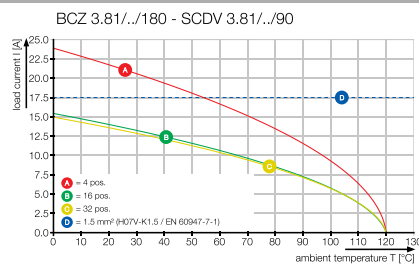
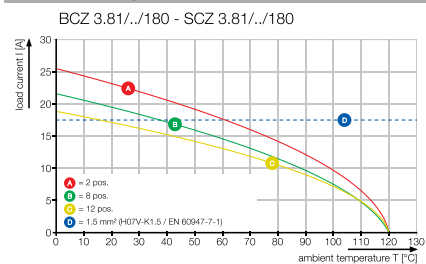

BCZ 3.81../90 & 270

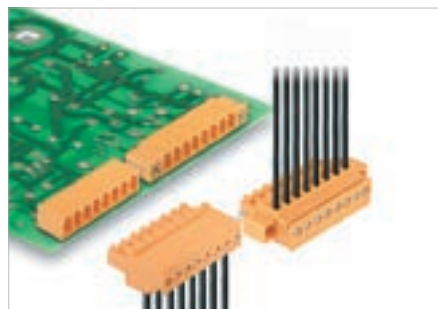

Female plug with screw connection.

Wire outlet direction:

- 90° - wire perpendicular to plugging direction and above
- 270° - wire perpendicular to plugging direction and below
- Available in closed version and with screw flange (F).

Weidmüller's 3.81 mm pitch (0.15 inch) plug-in connectors are compatible with the layouts of standard connectors and offer space for labelling and coding.

Product data

IEC: 320 V / 17.5 A / 0.2 - 1.5 mm²
UL: 300 V / 10 A / AWG 28 - 16



For additional articles and information, refer to catalog.weidmueller.com

Note:

- Additional colours on request
- Rated current related to rated cross-section & min. No. of poles.
- Wire end ferrule without plastic collar to DIN 46228/1
- Wire end ferrule with plastic collar to DIN 46228/4
- P on drawing = pitch
- Rated data refer only to the component itself. Clearance and creepage distances to other components are to be designed in accordance with the relevant application standards.

BCZ 3.81../90



Dimensioned drawing

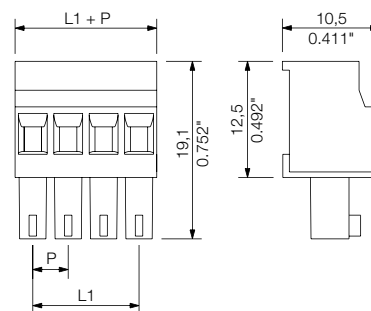

Technical data

In compliance with IEC 60664-1 / IEC 61984			
Clamping range, max.	mm ²	0.08...1.5	
Solid core H05(07) V-U	mm²	0.2...1.5	
Stranded H07 V-R			
Flexible H05(07) V-K	mm ²	0.2...1.5	
Flexible with ferrule	mm ²	0.2...1.5	
Ferrule with plastic collar	mm ²	0.2...1.5	
Stripping length	mm	7	
Screwdriver blade	mm	0.4 x 2.5	
According to norm		DIN 5264	
Tightening torque range			
Rated current, max.	A	17.5	17.5
At ambient temperature		20°C	40°C
For conductor cross-section	mm ²	1	
Overtoltage category		III	III II
Pollution severity		3	2 2
Rated voltage	V	160	160 320
Rated impulse voltage	kV	2.5	2.5 2.5
UL / CUL (Use Group)		B	C D
Rated voltage	V	300	300
Rated current	A	10	10
AWG conductor	AWG	28-16	
CSA (Use Group)		B	C D
Rated voltage	V	300	50
Rated current	A	8	8
AWG conductor	AWG	28-16	
General data			
Type of insulation material		PA 66 GF 30	
UL 94 flammability rating		V-0	
Contact base material		Copper alloy	
Material of contact surface		tinned	
Pin dimensions = d	mm		
Solder eyelet Ø = D	mm		
Solder eyelet Ø tolerance	mm		

Accessories

Note: Refer to the Accessories chapter for additional accessories.

Screwdriver		Order No.
	SDS 0.4X2.5X75	2749320000
	SDIS 0.4X2.5X75	2749790000

Ordering data

Solder pin length				
Colour	orange			
Pitch	3.81 mm			
Pol.	L1	(inch)	Qty.	Order No.
2	3.81	0.150	50	1939820000
3	7.62	0.300	50	1939830000
4	11.43	0.450	50	1939840000
5	15.24	0.600	50	1939860000
6	19.05	0.750	50	1939870000
7	22.86	0.900	50	1939880000
8	26.67	1.050	50	1939890000
9	30.48	1.200	50	1939900000
10	34.29	1.350	50	1939910000
11	38.10	1.500	50	1939920000
12	41.91	1.650	50	1939930000

Representative deratings curve

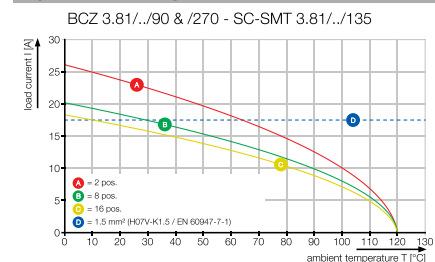

BCZ 3.81/./90F

with screw flange



Dimensioned drawing

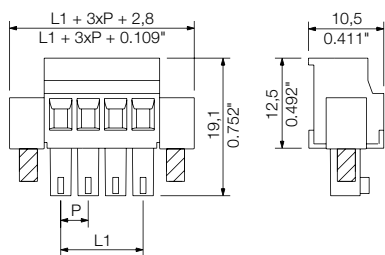

Ordering data

Solder pin length					
Colour		orange			
Pitch		3.81 mm			
Pol.	L1	(inch)	Qty.	Order No.	
2	3.81	0.150	50	1939980000	
3	7.62	0.300	50	1939990000	
4	11.43	0.450	50	1940000000	
5	15.24	0.600	50	1940010000	
6	19.05	0.750	50	1940020000	
7	22.86	0.900	50	1940030000	
8	26.67	1.050	50	1940040000	
9	30.48	1.200	50	1940050000	
10	34.29	1.350	50	1940060000	
11	38.10	1.500	50	1940070000	
12	41.91	1.650	50	1940080000	

BCZ 3.81/./270

with screw flange



Dimensioned drawing

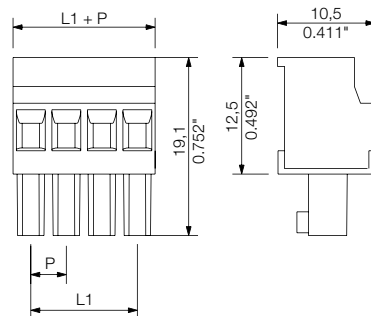

Ordering data

Solder pin length					
Colour		orange			
Pitch		3.81 mm			
Pol.	L1	(inch)	Qty.	Order No.	
2	3.81	0.150	50	1940190000	
3	7.62	0.300	50	1940200000	
4	11.43	0.450	50	1940210000	
5	15.24	0.600	50	1940220000	
6	19.05	0.750	50	1940230000	
7	22.86	0.900	50	1940240000	
8	26.67	1.050	50	1940250000	
9	30.48	1.200	50	1940260000	
10	34.29	1.350	50	1940270000	
11	38.10	1.500	50	1940280000	
12	41.91	1.650	50	1940290000	

BCZ 3.81/./270F

with screw flange



Dimensioned drawing

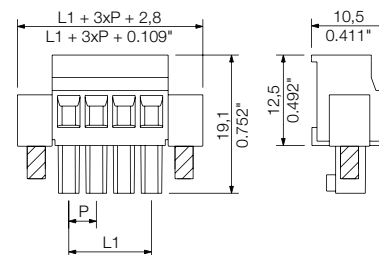

Ordering data

Solder pin length					
Colour		orange			
Pitch		3.81 mm			
Pol.	L1	(inch)	Qty.	Order No.	
2	3.81	0.150	50	1940460000	
3	7.62	0.300	50	1940470000	
4	11.43	0.450	50	1940480000	
5	15.24	0.600	50	1940490000	
6	19.05	0.750	50	1940500000	
7	22.86	0.900	50	1940510000	
8	26.67	1.050	50	1940520000	
9	30.48	1.200	50	1940530000	
10	34.29	1.350	50	1940540000	
11	38.10	1.500	50	1940550000	
12	41.91	1.650	50	1940560000	



Additional deratings curves

BCZ 3.81/./90 & /270 - SC 3.81/./135

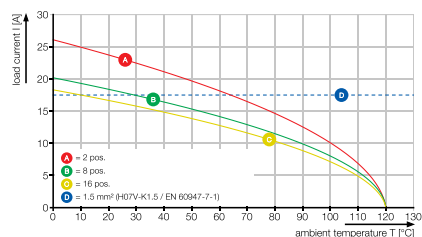

BCF 3.81/./180

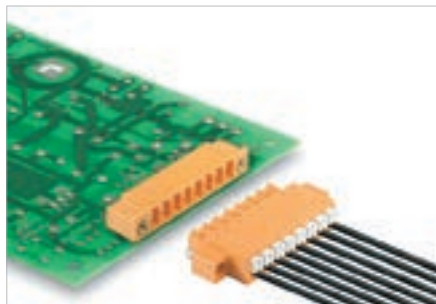

Female plug with PUSH IN wire connection.

- Simply insert the wire and it's ready.
- Integrated push-button for opening the terminal point
- High component density because of very low height, especially when combined with the compact double-level SCDN / SCDN-THR male header.
- Available in closed version, with screw flange (F) and lock a release-lever (LR).

Weidmüller's 3.81 mm pitch (0.15 inch) plug-in connectors are compatible with the layouts of standard connectors and offer space for labelling and coding.

Product data

IEC: 320 V / 17.5 A / 0.14 - 1.5 mm²
UL: 300 V / 10 A / AWG 26 - 16



For additional articles and information, refer to catalog.weidmueller.com

Note:

- Additional colours on request
- Rated current related to rated cross-section & min. No. of poles.
- P on drawing = pitch
- Conductors suitable for connection: 1.5 mm² with wire-end ferrule with plastic collar, DIN 46 228/1, with a rated voltage of 125V/2.5 kV with III/3 or 250 V/2.5 kV with II/2
- Crimp shape A for wire-end ferrules with crimping tools PZ 1,5 (order no. 9005990000) or PZ 6/5 (order no. 9011460000) for larger wire cross-sections recommended.
- Wire end ferrule without plastic collar to DIN 46228/1
- Wire end ferrule with plastic collar to DIN 46228/4
- Rated data refer only to the component itself. Clearance and creepage distances to other components are to be designed in accordance with the relevant application standards.
- The test point can only be used as potential-pickup point.

BCF 3.81/./180



Dimensioned drawing

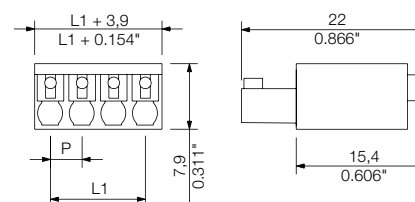



Technical data

In compliance with IEC 60664-1 / IEC 61984

Clamping range, max.	mm ²	0.14...1.5
Solid core H05(07) V-U	mm²	0.14...1.5
Stranded H07 V-R		
Flexible H05(07) V-K	mm ²	0.14...1.5
Flexible with ferrule	mm ²	0.25...1.5
Ferrule with plastic collar	mm ²	0.25...1
Stripping length	mm	9
Screwdriver blade	mm	0.4 x 2.5
According to norm		DIN 5264
Tightening torque range		
Rated current, max.	A	17.5 17.5
At ambient temperature	20°C	40°C
For conductor cross-section	mm ²	1
Overtoltage category		III III II
Pollution severity		3 2 2
Rated voltage	V	160 160 320
Rated impulse voltage	kV	2.5 2.5 2.5
UL / CUL (Use Group)	B C D	
Rated voltage	V	300 300
Rated current	A	10 10
AWG conductor	AWG	26-16
CSA (Use Group)	B C D	
Rated voltage	V	300 50 300
Rated current	A	11 11 11
AWG conductor	AWG	26-16
General data		
Type of insulation material		PA 66 GF 30
UL 94 flammability rating		V-0
Contact base material		Copper alloy
Material of contact surface		tinned
Pin dimensions = d	mm	
Solder eyelet Ø = D	mm	
Solder eyelet Ø tolerance	mm	

Accessories

Note: Refer to the Accessories chapter for additional accessories.

Screwdriver		Order No.
	SDS 0.4X2.5X75	2749320000
	SDIS 0.4X2.5X75	2749790000
Pressing tool		
	PZ 6/5	9011460000
	PZ 1.5	9005990000

Ordering data

Solder pin length				
Colour	orange			
Pitch	3.81 mm			
Pol.	L1	(inch)	Qty.	Order No.
2	3.81	0.150	50	1969090000
3	7.62	0.300	50	1969100000
4	11.43	0.450	50	1969110000
5	15.24	0.600	50	1969120000
6	19.05	0.750	50	1969130000
7	22.86	0.900	50	1969140000
8	26.67	1.050	50	1969150000
9	30.48	1.200	50	1969160000
10	34.29	1.350	50	1969170000
11	38.10	1.500	50	1969180000
12	41.91	1.650	50	1969190000

Representative deratings curve

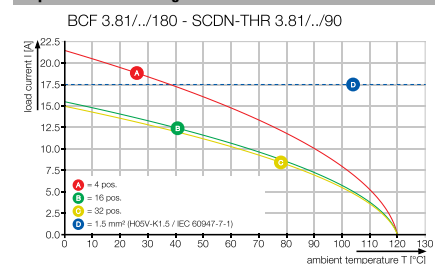

BCF 3.81../180F

with screw flange

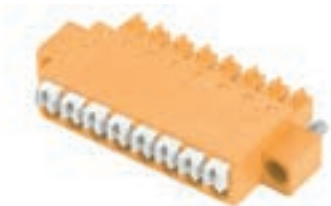

Dimensioned drawing

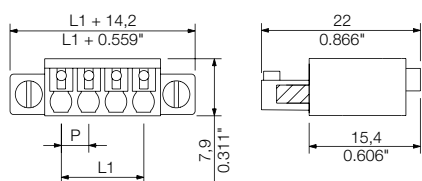

Ordering data

Solder pin length					
Colour					orange
Pitch 3.81 mm					
Pol.	L1	(inch)	Qty.	Order No.	
2	3.81	0.150	50	1970300000	
3	7.62	0.300	50	1970330000	
4	11.43	0.450	50	1970370000	
5	15.24	0.600	50	1970380000	
6	19.05	0.750	50	1970400000	
7	22.86	0.900	50	1970440000	
8	26.67	1.050	50	1970550000	
9	30.48	1.200	50	1970570000	
10	34.29	1.350	50	1970580000	
11	38.10	1.500	50	1970620000	
12	41.91	1.650	50	1970650000	

BCF 3.81../180LR



Dimensioned drawing

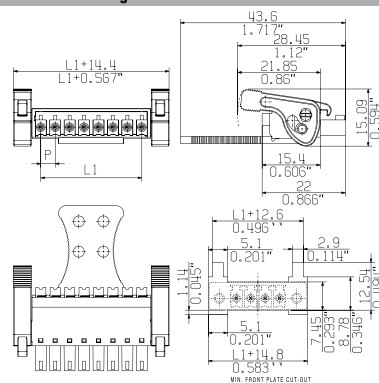

Ordering data

Solder pin length					
Colour					orange
Pitch 3.81 mm					
Pol.	L1	(inch)	Qty.	Order No.	
2	3.81	0.150	50	2442040000	
3	7.62	0.300	50	2442610000	
4	11.43	0.450	50	2442620000	
5	15.24	0.600	50	2442630000	
6	19.05	0.750	50	2442640000	
7	22.86	0.900	50	2442650000	
8	26.67	1.050	50	2442660000	
9	30.48	1.200	50	2442670000	
10	34.29	1.350	50	2442680000	
11	38.10	1.500	50	2442690000	
12	41.91	1.650	50	2442700000	



Additional deratings curves

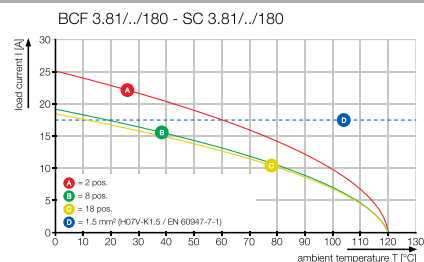
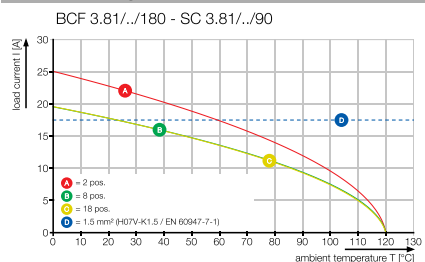

BCF 3.81../180 ZE

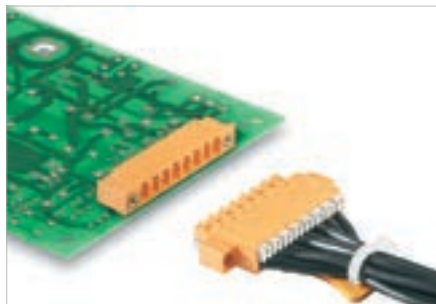

Female plug with strain relief (ZE) for the connected wire.

- PUSH IN wire connection method
- Simply insert the prepared wire and attach the strain relief mechanism
- Intuitive handling - since the wire-entry area and handling area are clearly separated.

Weidmüller's 3.81 mm pitch (0.15 inch) plug-in connectors are compatible with the layouts of standard connectors and offer space for labelling and coding.

Product data

IEC: 320 V / 17.5 A / 0.14 - 1.5 mm²
UL: 300 V / 10 A / AWG 26 - 16



For additional articles and information, refer to catalog.weidmuller.com

Note:

- Additional colours on request
- Rated current related to rated cross-section & min. No. of poles.
- P on drawing = pitch
- Conductors suitable for connection: 1.5 mm² with wire-end ferrule with plastic collar, DIN 46 228/1, with a rated voltage of 125V/2.5 kV with III/3 or 250 V/2.5 kV with II/2
- Crimp shape A for wire-end ferrules with crimping tools PZ 1,5 (order no. 9005990000) or PZ 6/5 (order no. 9011460000) for larger wire cross-sections recommended.
- Wire end ferrule without plastic collar to DIN 46228/1
- Wire end ferrule with plastic collar to DIN 46228/4
- Rated data refer only to the component itself. Clearance and creepage distances to other components are to be designed in accordance with the relevant application standards.
- The test point can only be used as potential-pickup point.

BCF 3.81../180ZE

with strain relief



Dimensioned drawing

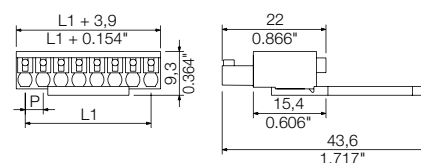

Technical data

In compliance with IEC 60664-1 / IEC 61984			
Clamping range, max.	mm ²	0.14...1.5	
Solid core H05(07) V-U	mm²	0.14...1.5	
Stranded H07 V-R			
Flexible H05(07) V-K	mm ²	0.14...1.5	
Flexible with ferrule	mm ²	0.25...1.5	
Ferrule with plastic collar	mm ²	0.25...1	
Stripping length	mm	9	
Screwdriver blade	mm	0.4 x 2.5	
According to norm			
Tightening torque range			
Rated current, max.	A	17.5	17.5
At ambient temperature		20°C	40°C
For conductor cross-section	mm ²	1	
Overtoltage category		III	III II
Pollution severity		3	2 2
Rated voltage	V	160	160 320
Rated impulse voltage	kV	2.5	2.5 2.5
UL / CUL (Use Group)		B	C D
Rated voltage	V	300	300
Rated current	A	10	10
AWG conductor	AWG	26-16	
CSA (Use Group)		B	C D
Rated voltage	V	300	50 300
Rated current	A	11	11 11
AWG conductor	AWG	26-16	
General data			
Type of insulation material		PA 66 GF 30	
UL 94 flammability rating		V-0	
Contact base material		Copper alloy	
Material of contact surface		tinned	
Pin dimensions = d	mm		
Solder eyelet Ø = D			
Solder eyelet Ø tolerance	mm		

Accessories

Note: Refer to the Accessories chapter for additional accessories.

Screwdriver		Order No.
	SDS 0.4X2.5X75	2749320000
	SDIS 0.4X2.5X75	2749790000
Pressing tool		
	PZ 6/5	9011460000
	PZ 1.5	9005990000

Ordering data

Solder pin length					
Colour	orange				
Pitch	3.81 mm				
Pol.	L1	(inch)	Qty.	Order No.	
5	15.24	0.600	50	1235790000	
6	19.05	0.750	50	1235800000	
7	22.86	0.900	50	1235810000	
8	26.67	1.050	50	1235820000	
9	30.48	1.200	50	1235830000	
10	34.29	1.350	50	1235840000	
11	38.10	1.500	50	1235870000	
12	41.91	1.650	50	1235880000	

from 10 pole 2 strain reliefs per plug-in connector

Representative deratings curve

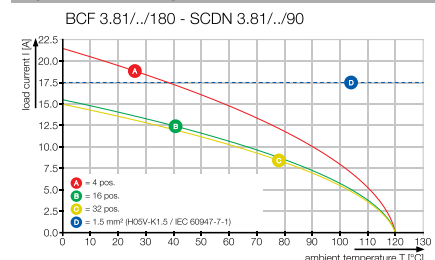

from 10 pole 2 strain reliefs per plug-in connector

K

3.81

180°

1.5 mm²

BCF 3.81../180FZE

with screw flange and strain relief



Dimensioned drawing

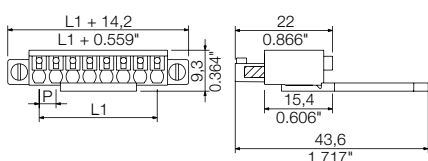

Ordering data

Solder pin length					
Colour		orange			
Pitch		3.81 mm			
Pol.	L1	(inch)	Qty.	Order No.	
5	15.24	0.600	50	1235970000	
6	19.05	0.750	50	1235980000	
7	22.86	0.900	50	1235990000	
8	26.67	1.050	50	1236000000	
9	30.48	1.200	50	1236010000	
10	34.29	1.350	50	1236020000	
11	38.10	1.500	50	1236030000	
12	41.91	1.650	50	1236040000	

BCF 3.81../180LRZE



Dimensioned drawing

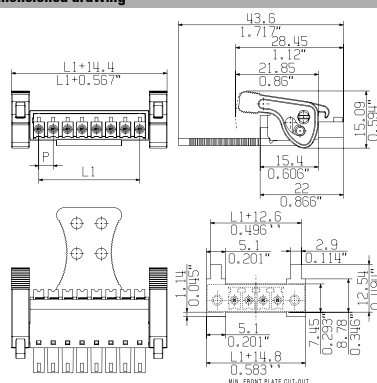

Ordering data

Solder pin length					
Colour		orange			
Pitch		3.81 mm			
Pol.	L1	(inch)	Qty.	Order No.	
5	15.24	0.600	50	2442960000	
6	19.05	0.750	50	2443010000	
7	22.86	0.900	50	2443060000	
8	26.67	1.050	50	2443020000	
9	30.48	1.200	50	2443030000	
10	34.29	1.350	50	2442910000	
11	38.10	1.500	50	2442920000	
12	41.91	1.650	50	2443050000	

from 10 pole 2 strain reliefs per plug-in connector

Additional deratings curves

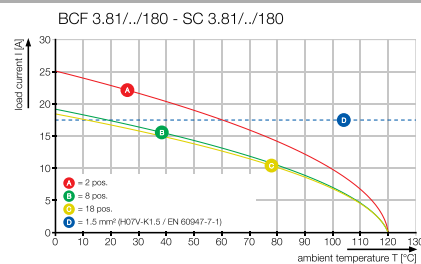
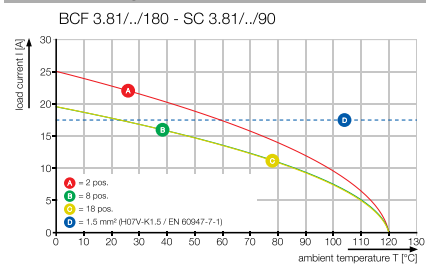

Connectors in 3.81 mm pitch Series BC/SC 3.81

BCL-SMT 3.81/./90



Inverted female headers for:

- Touch-safety on the circuit board with board-to-wire connection (with the SCZ)
- Board-to-board component connection (with SC/SC-SMT)
- Works with reflow soldering and automatic placement.
- Orientation: 90°
- Available in closed version with screw Flange (F) and inverted solder flange (LFI).

Weidmüller's 3.81 mm pitch (0.15 inch) plug-in connectors are compatible with the layouts of standard connectors and offer space for labelling and coding.

Product data

IEC: 320 V / 17.5 A
UL: 300 V / 10 A



For additional articles and information, refer to catalog.weidmueller.com

Note:

- Rated current related to rated cross-section & min. No. of poles.
- P on drawing = pitch
- Rated data refer only to the component itself. Clearance and creepage distances to other components are to be designed in accordance with the relevant application standards.

BCL-SMT 3.81/./90



Dimensioned drawing

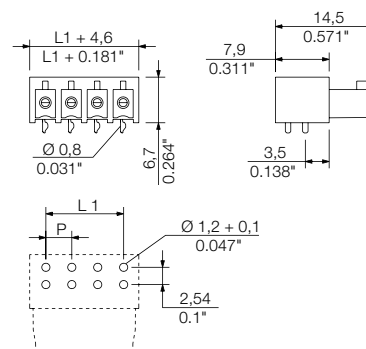

Technical data

In compliance with IEC 60664-1 / IEC 61984

Clamping range, max.			
Solid core H05(07) V-U			
Stranded H07 V-R			
Flexible H05(07) V-K			
Flexible with ferrule			
Ferrule with plastic collar			
Stripping length			
Screwdriver blade	mm		
According to norm			
Tightening torque range			
Rated current, max.	A	17.5	17.5
At ambient temperature		20°C	40°C
For conductor cross-section			
Overtoltage category		III	III II
Pollution severity		3	2 2
Rated voltage	V	160	160 320
Rated impulse voltage	kV	2.5	2.5 2.5
UL / CUL (Use Group)		B	C D
Rated voltage	V	300	300
Rated current	A	10	10
AWG conductor	AWG		-
CSA (Use Group)		B	C D
Rated voltage	V	300	50
Rated current	A	11	11
AWG conductor	AWG		-
General data			
Type of insulation material		LCP GF	
UL 94 flammability rating		V-0	
Contact base material		Copper alloy	
Material of contact surface		tinned	
Pin dimensions = d	mm	0.8	
Solder eyelet Ø = D	mm	1.2	
Solder eyelet Ø tolerance	mm	+ 0,1	

Accessories

Note: Refer to the Accessories chapter for additional accessories.

Ordering data

Solder pin length	1.5 mm			
Colour	black			
Pitch	3.81 mm			
Pol.	L1	(inch)	Qty.	Order No.
2	3.81	0.150	50	1974750000
3	7.62	0.300	50	1974770000
4	11.43	0.450	50	1974780000
5	15.24	0.600	50	1974800000
6	19.05	0.750	50	1974820000
7	22.86	0.900	50	1974840000
8	26.67	1.050	50	1974850000
9	30.48	1.200	50	1974880000
10	34.29	1.350	50	1974890000
11	38.10	1.500	50	1974910000
12	41.91	1.650	50	1974930000

Representative deratings curve

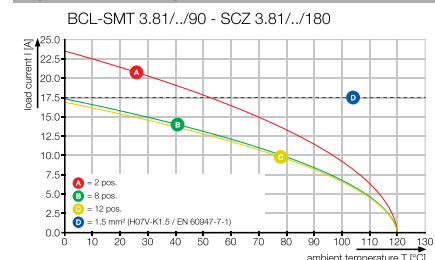

K

3.81

90°

BCL-SMT 3.81/./90LF1

with inverted solder flange



Dimensioned drawing

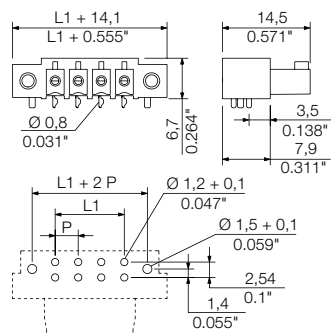

BCL-SMT 3.81/./90F

with screw flange



Dimensioned drawing

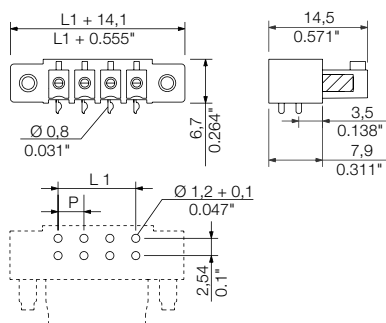

Ordering data

Solder pin length		1.5 mm	
Colour		black	
Pitch		3.81 mm	
Pol.	L1	(inch)	Qty. Order No.
2	3.81	0.150	50 1028720000
3	7.62	0.300	50 1028730000
4	11.43	0.450	50 1028740000
5	15.24	0.600	50 1028750000
6	19.05	0.750	50 1028760000
7	22.86	0.900	50 1028770000
8	26.67	1.050	50 1028790000
9	30.48	1.200	50 1028810000
10	34.29	1.350	50 1028820000
11	38.10	1.500	50 1028830000
12	41.91	1.650	50 1028840000

Ordering data

Solder pin length		1.5 mm	
Colour		black	
Pitch		3.81 mm	
Pol.	L1	(inch)	Qty. Order No.
2	3.81	0.150	50 1975690000
3	7.62	0.300	50 1975700000
4	11.43	0.450	50 1975710000
5	15.24	0.600	50 1975730000
6	19.05	0.750	50 1975740000
7	22.86	0.900	50 1975750000
8	26.67	1.050	50 1975760000
9	30.48	1.200	50 1975780000
10	34.29	1.350	50 1975790000
11	38.10	1.500	50 1975820000
12	41.91	1.650	50 1975830000

Connectors in 3.81 mm pitch Series BC/SC 3.81

BCL-SMT 3.81../180

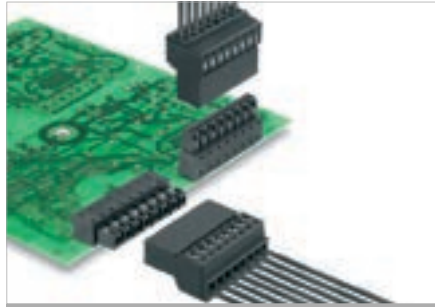

Inverted female headers for:

- Touch-safety on the circuit board with board-to-wire (when connecting with the SCZ)
- Board-to-board component connection (with SC/SC-SMT)
- Works with reflow soldering and automatic placement.
- Orientation: 180°
- Available in closed version and with inverted solder flange (LFI).

Weidmüller's 3.81 mm pitch (0.15 inch) plug-in connectors are compatible with the layouts of standard connectors and offer space for labelling and coding.

Product data

IEC: 320 V / 17.5 A
UL: 300 V / 10 A



For additional articles and information, refer to catalog.weidmueller.com

Note:

- Rated current related to rated cross-section & min. No. of poles.
- P on drawing = pitch
- Rated data refer only to the component itself. Clearance and creepage distances to other components are to be designed in accordance with the relevant application standards.

BCL-SMT 3.81../180



Dimensioned drawing

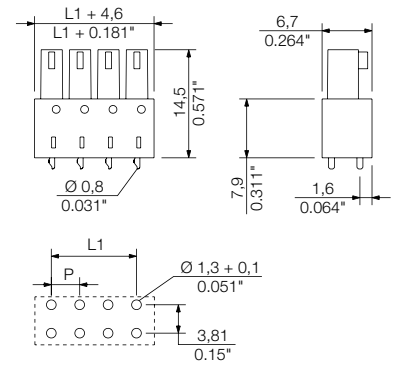

Technical data

In compliance with IEC 60664-1 / IEC 61984

Clamping range, max.			
Solid core H05(07) V-U			
Stranded H07 V-R			
Flexible H05(07) V-K			
Flexible with ferrule			
Ferrule with plastic collar			
Stripping length			
Screwdriver blade	mm		
According to norm			
Tightening torque range			
Rated current, max.	A	17.5	17.5
At ambient temperature		20°C	40°C
For conductor cross-section			
Overtoltage category		III	III II
Pollution severity		3	2 2
Rated voltage	V	160	160 320
Rated impulse voltage	kV	2.5	2.5 2.5
UL / CUL (Use Group)		B	C D
Rated voltage	V	300	300
Rated current	A	10	10
AWG conductor	AWG		-
CSA (Use Group)		B	C D
Rated voltage	V	300	50
Rated current	A	11	11
AWG conductor	AWG		-
General data			
Type of insulation material		LCP GF	
UL 94 flammability rating		V-0	
Contact base material		Copper alloy	
Material of contact surface		tinned	
Pin dimensions = d	mm	0.8	
Solder eyelet Ø = D	mm	1.2	
Solder eyelet Ø tolerance	mm	+ 0,1	

Accessories

Note: Refer to the Accessories chapter for additional accessories.

Ordering data

Solder pin length		1.5 mm		
Colour		black		
Pitch		3.81 mm		
Pol.	L1	(inch)	Qty.	Order No.
2	3.81	0.150	50	1976490000
3	7.62	0.300	50	1976500000
4	11.43	0.450	50	1976520000
5	15.24	0.600	50	1976530000
6	19.05	0.750	50	1976550000
7	22.86	0.900	50	1976570000
8	26.67	1.050	50	1976580000
9	30.48	1.200	50	1976590000
10	34.29	1.350	50	1976610000
11	38.10	1.500	50	1976620000
12	41.91	1.650	50	1976640000

Representative deratings curve

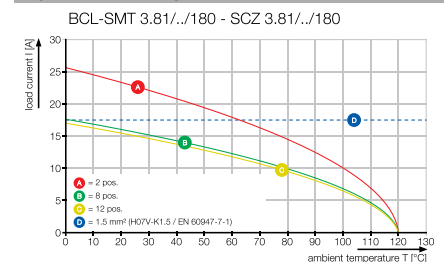

BCL-SMT 3.81/./180LFI

with inverted solder flange



Dimensioned drawing

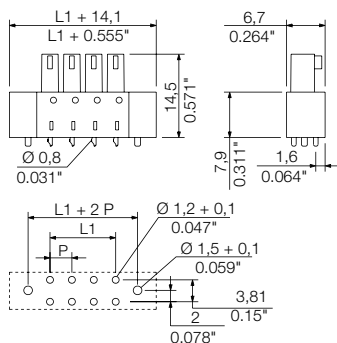

Ordering data

Solder pin length		1.5 mm		
Colour		black		
Pitch		3.81 mm		
Pol.	L1	(inch)	Qty.	Order No.
2	3.81	0.150	50	1029260000
3	7.62	0.300	50	1029270000
4	11.43	0.450	50	1029280000
5	15.24	0.600	50	1029290000
6	19.05	0.750	50	1029310000
7	22.86	0.900	50	1029320000
8	26.67	1.050	50	1029330000
9	30.48	1.200	50	1029340000
10	34.29	1.350	50	1029350000
11	38.10	1.500	50	1029360000
12	41.91	1.650	50	1029370000



OMNIMATE® Signal

PCB connectors in 5.00 mm and 5.08 mm pitch

OMNIMATE® Signal
PCB connectors in 5.00 mm and 5.08 mm pitch

Connectors in 5.00 mm pitch and 5.08 mm pitch

Explanation	L2
Quick selection 5.00 mm	L14
Quick selection 5.08 mm	L16
Product selection 5.00 mm	L22
Product selection 5.08 mm	L50

Male header SL-SMT 5.0x HC

The connecting element in the reflow process

Optimised for SMT (Surface Mount Technology)

Innovative, application oriented male headers made from high temperature insulating material LCP (Liquid crystal polymer) permits seamless integration of the connections into the automated SMT production process, including reflow soldering. HC represents additional performance.

The comprehensive portfolio impresses with significant gains in efficiency in assembly production, i.e. a reduction of manufacturing costs of up to 30 %, with increased process security and proven reliability.

Absolute process reliability

Using glass-fibre reinforced plastic with the SL 5.08 HC and SL-SMT 5.08 pin headers ensures a high level of dimensional stability and prevents what is known as the "banana effect" – the printed-circuit board sagging – in the soldering process.

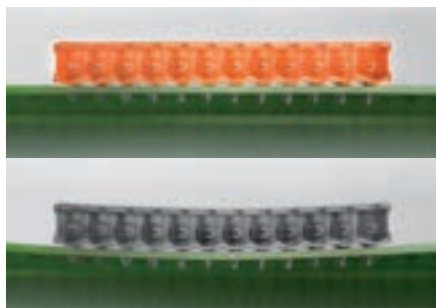

Standard-compliant fixing

More use with less effort: the soldering flange reduces 3 steps to one while protecting the soldering points from regular mechanical stress. A uniform drill hole diameter, no fixing of the fastening screw – additional fastening takes place automatically in the soldering process.



Delivered to fit your process:

Tape packaging with optimised tape pockets customised to match the width and pole count: this ensures that the feeders are used optimally and that the male headers are securely positioned on the tape.



OMNIMATE® Signal
PCB connectors in 5.00 mm and 5.08 mm pitch

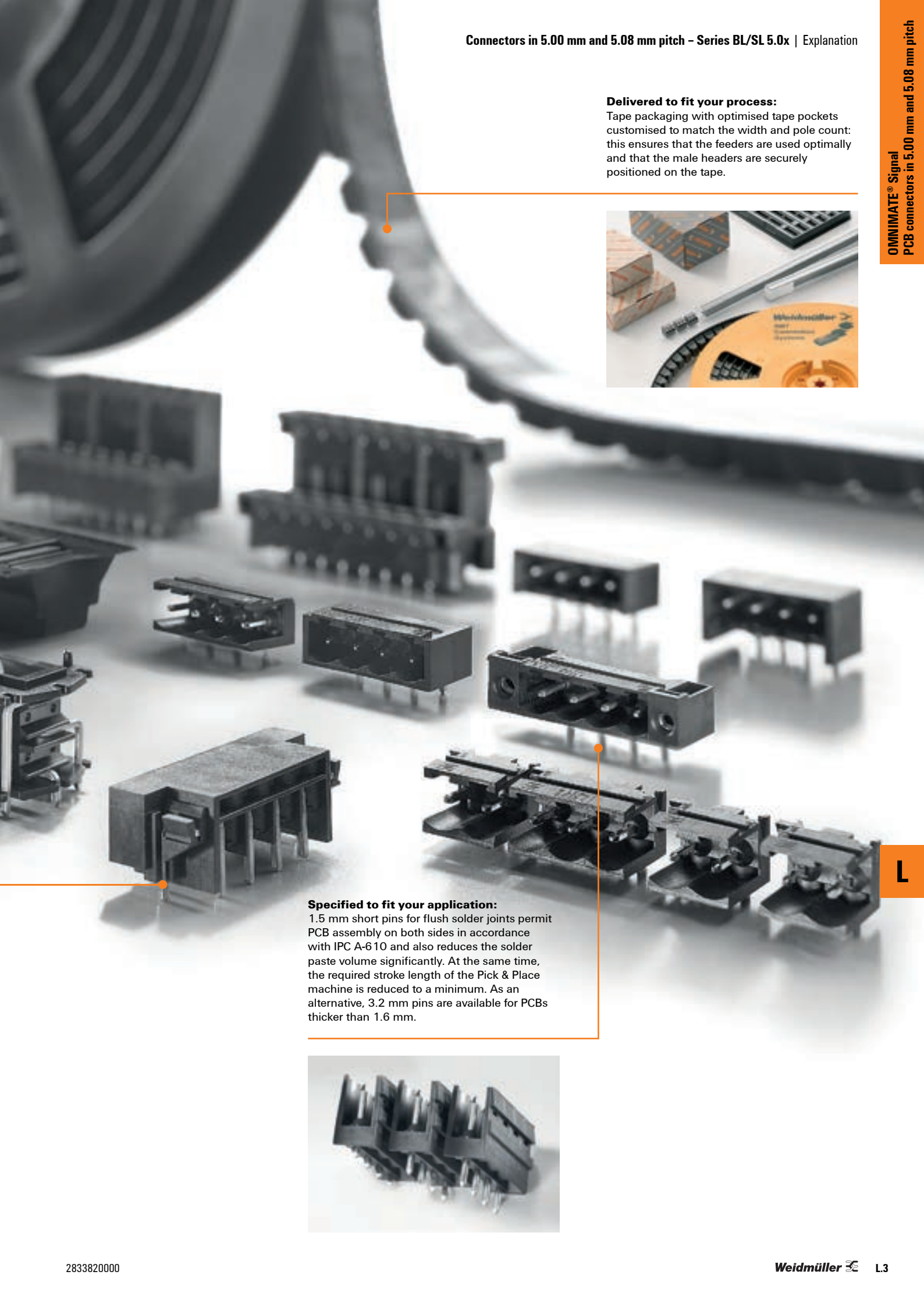

Specified to fit your application:

1.5 mm short pins for flush solder joints permit PCB assembly on both sides in accordance with IPC A-610 and also reduces the solder paste volume significantly. At the same time, the required stroke length of the Pick & Place machine is reduced to a minimum. As an alternative, 3.2 mm pins are available for PCBs thicker than 1.6 mm.



Male header SL 5.00 / SL 5.08 HC Optimised for wave soldering

These male headers in 5.00 mm and 5.08 mm pitch with the characteristic wave design in the mating face are the standard headers used in industrial automation. This male header has already enjoyed decades of market success; it is the basis for device connection systems for both wave and manual soldering. HC represents additional performance.

Increased density for device connections:

You can maximise connection density by using double level male headers together with your choice of connection systems on the field side.

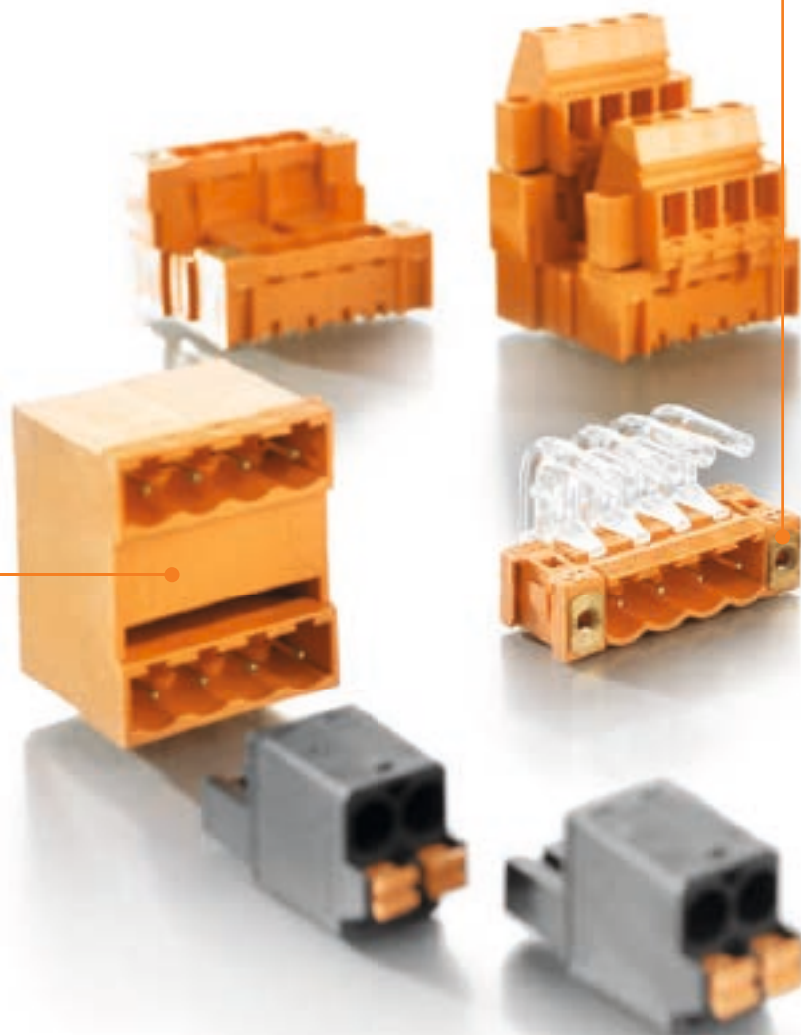
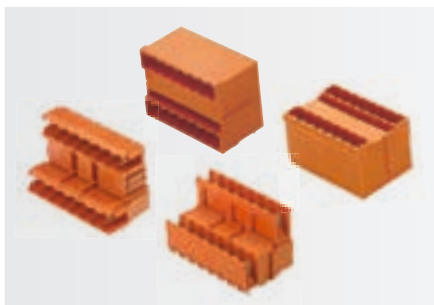

Three outlet directions:

There are more device design possibilities created by the different conductor path angles.

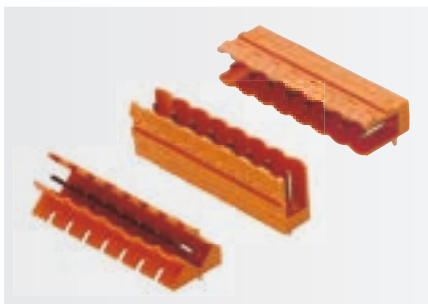

Safe under vibration and shock

- Vibration proof connection between male header and female plug
- The male header can also be screwed to the PCB
- Available with gold-plated surfaces

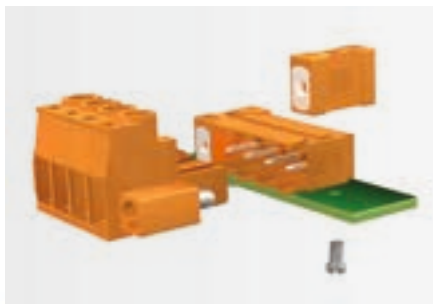

Specified to fit your assembly process

Gold-plated male headers have gold plating on the functional surfaces but not on the solder surfaces. This prevents contamination of the solder bath.

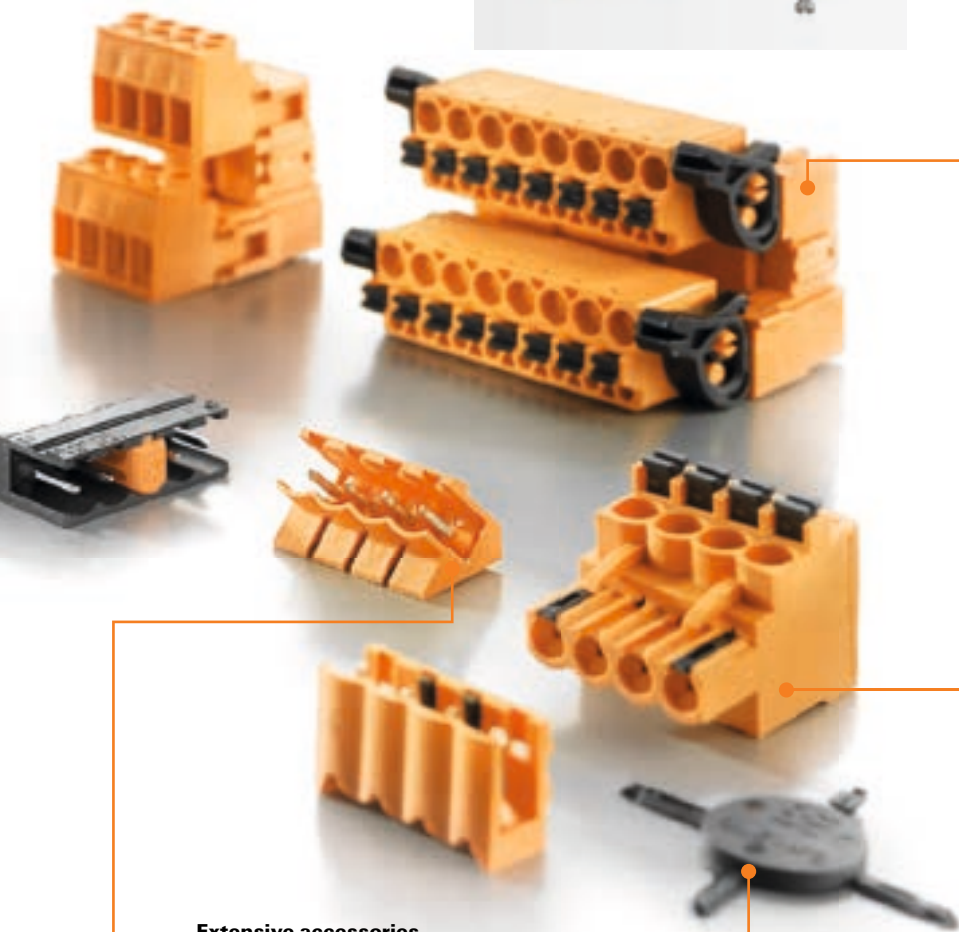

Integrated to fit your design

Adaptable connection system - the colour of the plug connectors fits to the device design and not the other way around.



Extensive accessories

- Light guides carry signals from the PCB LEDs to the front plate
- Partitions can be used to visually separate the different functional areas of the male header.
- All male headers can be manually coded or ordered as pre-coded headers.

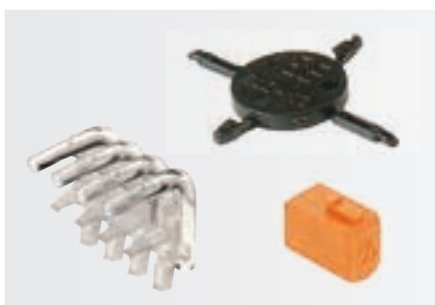

Female plug BLZP 5.0x HC

Pluggable, universal screw connection

The BLZP is the functional extension of the BLZ series, which has proven itself on the market for decades.

The “P” in the part name stands for a “plus” in security and the “HC” a “plus” in performance during processing and usage. Resulting from this are additional customer benefits, such as a continuous function and safety chain, increased efficiency and process reliability and much more user friendly operation.



Folded steel clamping yoke

When the screw on the clamp is tightened, there is a counter effect in the clamping yoke's threaded area. This ensures a maintenance free and durable gas-tight connection. In addition, the elastic behaviour of the clamping yoke compensates for the setting of the connected wire and any temperature induced deviations.



L

Hybrid contacts

The current bar and the tulip contact are made from two different materials and then welded together. The current bar has high conductivity and the tulip contact is characterised by its excellent spring properties.



Safe connection – error-free wiring

The integrated “wire guard” feature prevents dangerous insertion of the wire below the clamping area and thus protects against contact or insertion errors.



Safe contacting – universal operation

The globally compatible screw head (in conformity with ISO 2880/2, ISO 8764/2-PH and ISO 8764/2-PHZ) that fits all tools – for non-positive and uncomplicated operation with common hand tools or the efficient use of power tools.

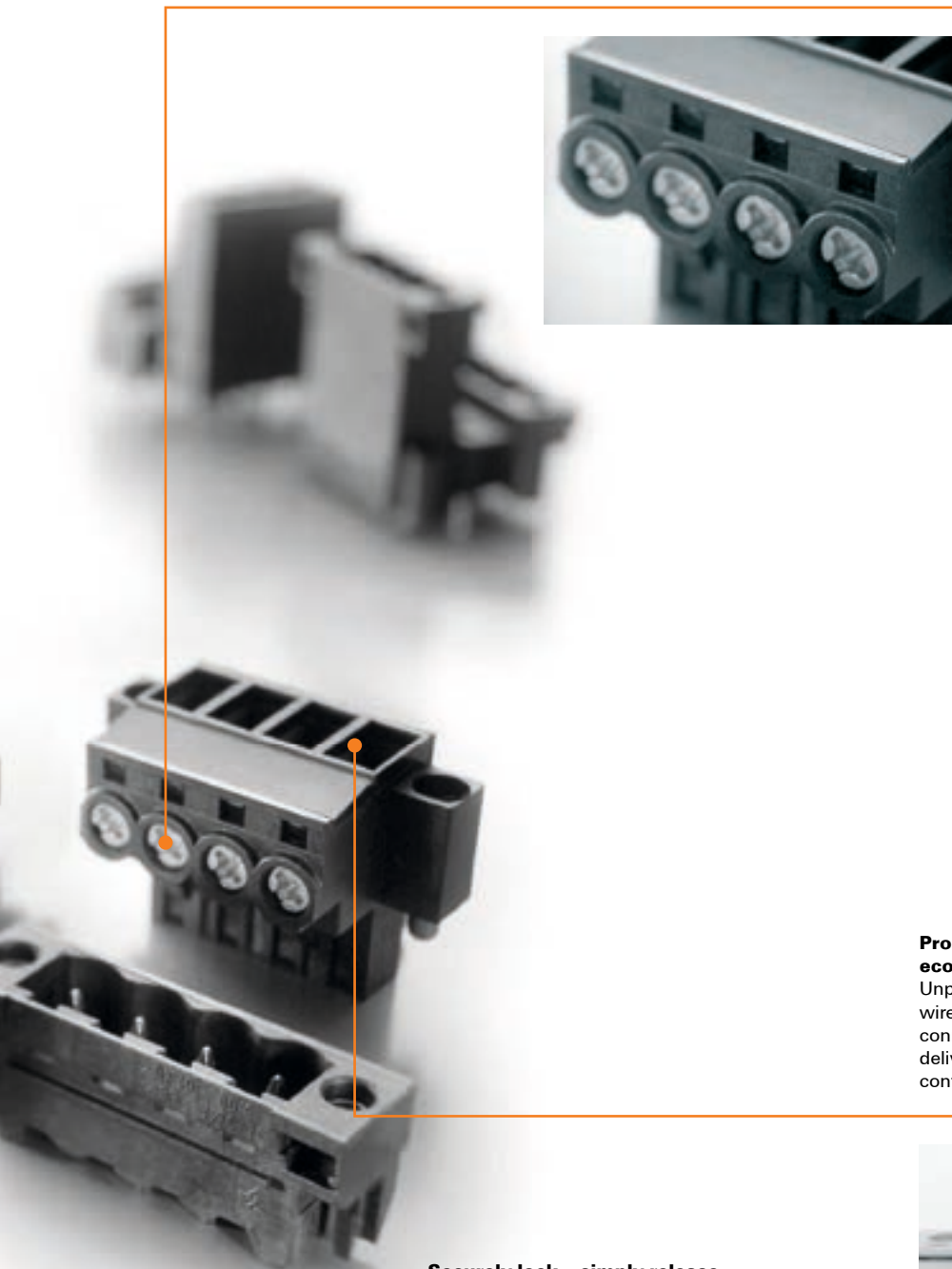

Conductor outlet direction up/down



Conductor outlet direction straight/inclined



Locking options

F = screw flange / LR = Lock & Release lever

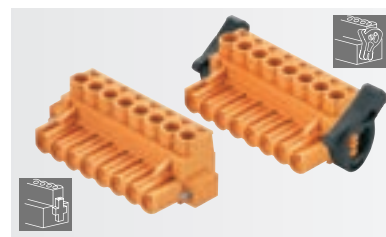

Process-compatible by default – economical processing

Unpack – wire ready – connect up. Our wire-ready technology makes sure that all connecting points are completely opened when delivered, even after global transport (in conformity with ISO 13355).

Securely lock – simply release

Fast, self-locking with the male header for tool-free handling. Releasing of the female plug is gentle on components.

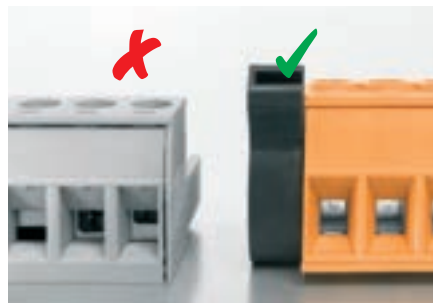

Female plug BLT 5.08 HC

The specialist for tight installation spaces

The BLT range is the most compact TOP connection of its type available in 5.08 mm pitch. This greatly simplifies device design because the cable entry and screw are located in the same plane of the plug-in connector. With the wire connection parallel to the circuit board, the BLT is specialised for use in limited installation spaces and high packing densities. HC represents additional performance.



High component density

Normal screw terminals have a 90° angle between the directions of the cable entry and the screw. The required space must then be taken into account when designing the device. However with the TOP connection system, the directions for wire entry and clamping operations are the same.

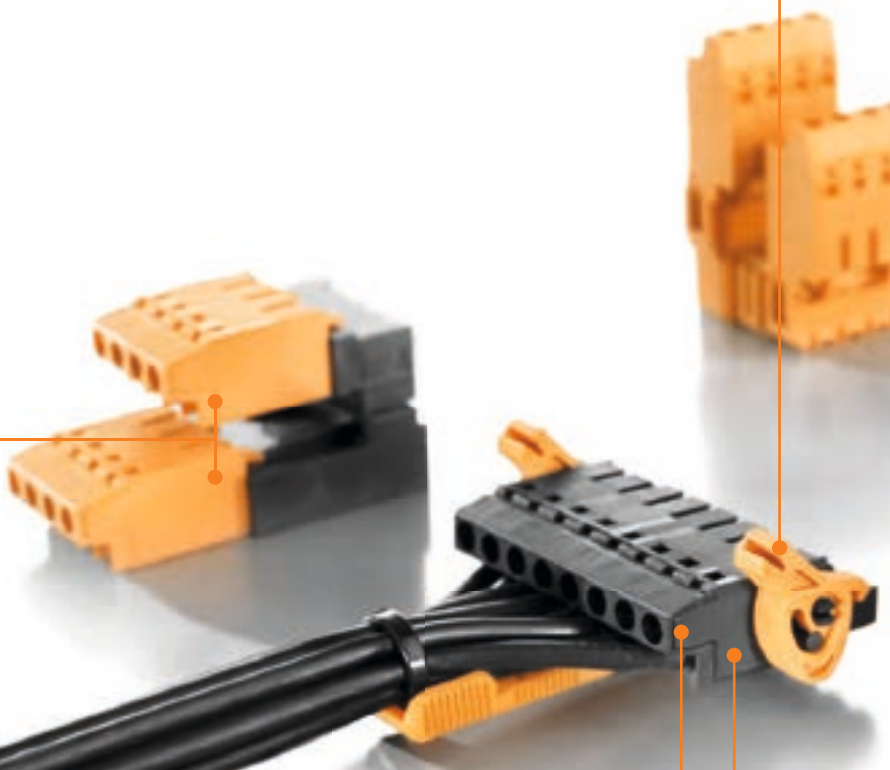
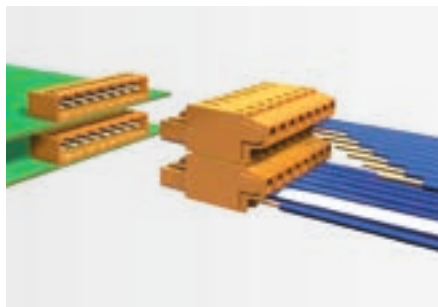

Hybrid contacts

For every function, the best material. The current bar and the tulip contact are made from two different materials and then welded together. The current bar has high conductivity and the tulip contact is characterised by its excellent spring properties.



Secure interlock and simple release

Fast, self-locking with the male header for tool-free handling. Releasing of the female plug is gentle on components.



Process-compatible by default – economical processing

Unpack – “Wire Ready” – Connect. The “Wire Ready” technology ensures that all clamping units are fully open on delivery, even after world-wide shipping.

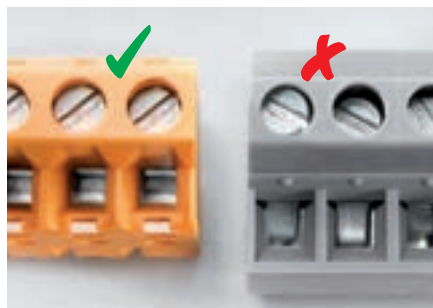
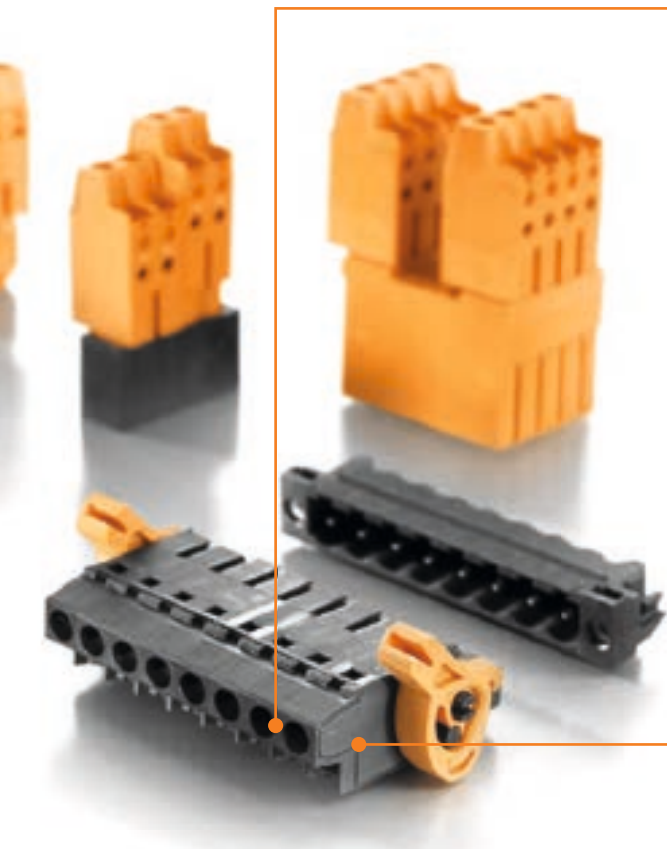

Safe to use with no-fault wiring:

The BLT’s “pull effect” ensures that the connected wire is pulled in to the clamping point for a securely established contact.



Minimal height

With a height of only 12.2 mm, the BLT is currently the smallest TOP connection available.

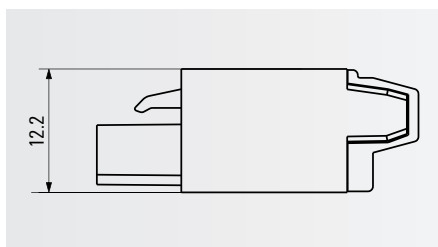

Female plug BLF 5.0x HC and BLDF 5.08 PUSH IN for fast conductor connection without any tools



The quick PUSH IN connection is now also available in pitches of 5.00 mm and 5.08 mm. The products are simple, safe and can be used in a variety of applications: The plugs are available for all wire outlet directions (90°, 180° and 270°) and also as a double connector with integrated cross-connection for bus applications.

HC represents additional performance.

The hybrid contacts used in combination with PUSH IN guarantee a vibration resistant and maintenance free connection, even under extreme conditions.

Hybrid contacts

The current bar and the tulip contact are made from two different materials and then welded together. The current bar has high conductivity and the tulip contact is characterised by its excellent spring properties.

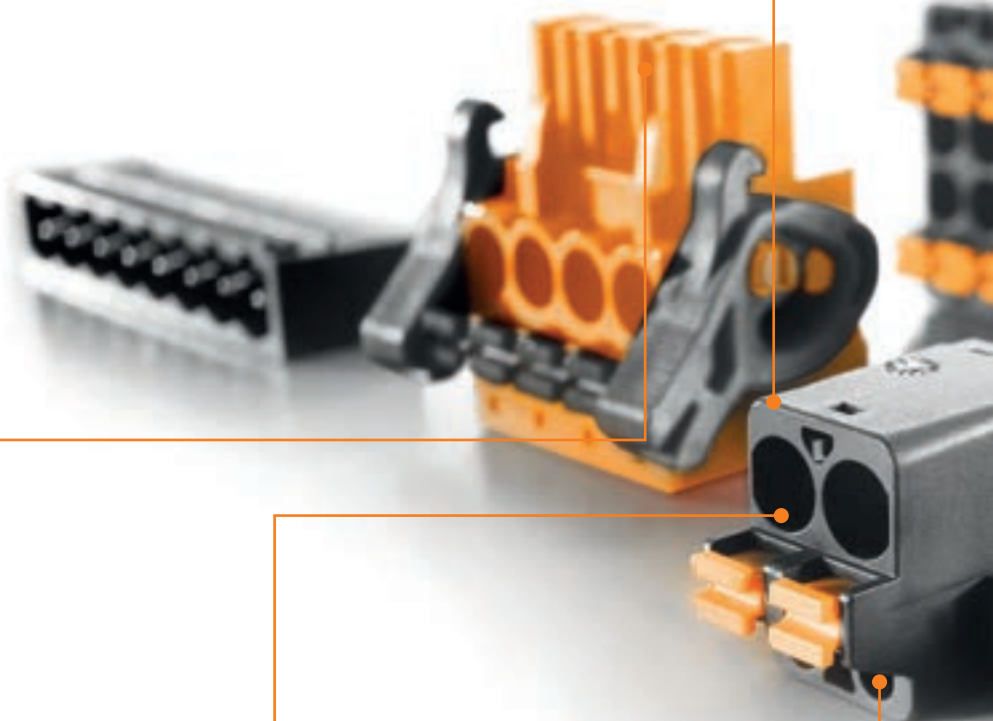

Can be tested at any time

Simplified functional testing using easily accessible diagnostic test points.



All-purpose usage

Very large clamping range from 0.2 mm² to 2.5 mm² –even when using ferrules with plastic collars.



Safe to operate

Rounded edges and large, non-slip control buttons ensure user-friendly operation.



Extremely durable

The integrated cross-connector is designed for a low voltage drop and allows a powerful 22 A bus power which can supply a high number of notes in the bus system.



Directly plugged in

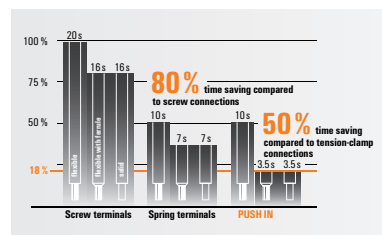

Simply fast

PUSH IN: tool-free connections of pre-prepared wires into the wire-entry funnel. www.PUSH-IN.com



Simple and self-explanatory

Intuitive opening of the terminal point using conspicuous push buttons.



All-round safety

A stainless steel cage enclosure prevents subsidence in the contact area. To prevent any drop in clamping force plastic parts were deliberately not used.



Female plug BLC 5.08

Cost effective and pre-assembled using a crimp connection

The BLC product family with crimp connections provides an affordable solution with pre-assembled female plugs that is also appropriate for large batch jobs. The contacts can be crimped by using hand tools or with a crimping machine in the factory when producing large batches.

Minimal height

With a height of only 12.2 mm, the BLT is currently the smallest TOP connection available.

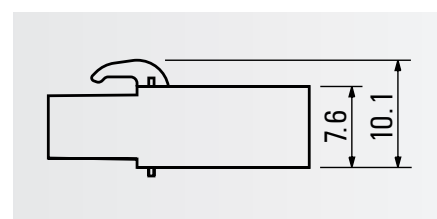

Effective and cost-effective

By using high performance metals, a costly over-spring on the tulip contact can be avoided. This cost saving is passed directly to the customer.

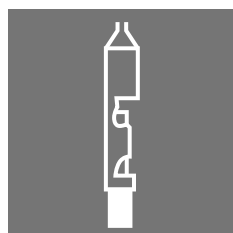

L



Process-compatible by default – economical processing

Delivery of the crimp contacts loose in bags, or as tape-packaged carrier strips. For the following conductor sizes: 0.22 to 0.35 mm², 0.50 to 1.00 mm², 1.50 to 2.50 mm².

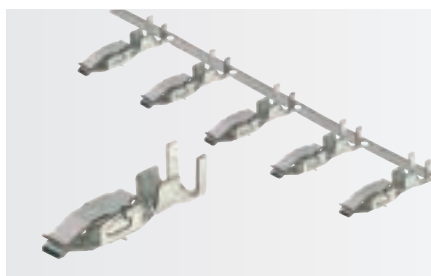

Flexible for a variety of applications

Affordable machine crimping or with hand tools in the field.

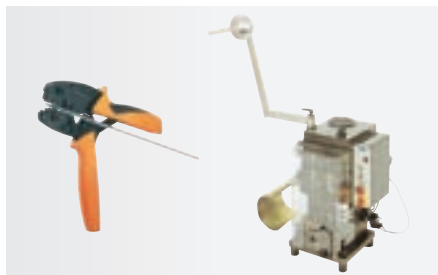

High component density

Screw terminals have a 90° angle between the directions of the cable entry and the screw. The required space must then be taken into account when designing the device. In the crimp connector system, however, the conductor insertion and operation is parallel to the circuit board.

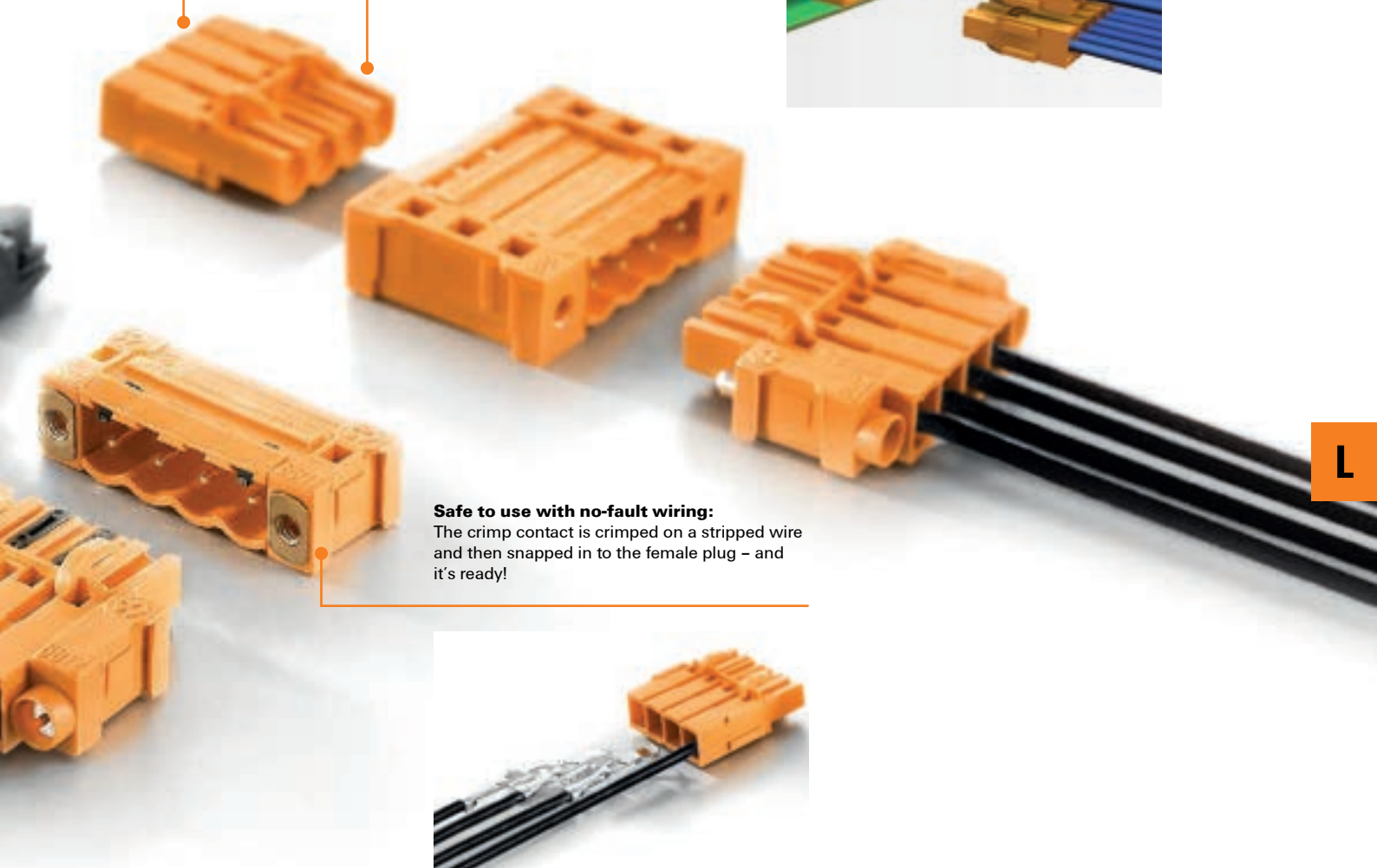
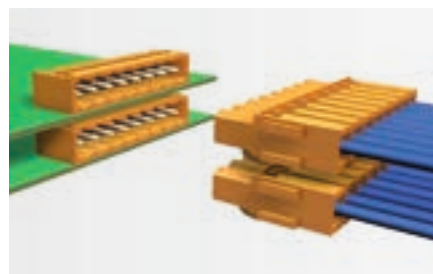





Safe to use with no-fault wiring:

The crimp contact is crimped on a stripped wire and then snapped in to the female plug – and it's ready!



<http://www.OMNIMATE.net>

-  = Wire-to-Board
-  = Board-to-Board
-  = Wire-to-Wire
-  = Board-to-Wire

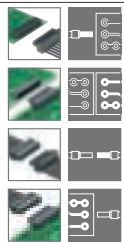

Orientation

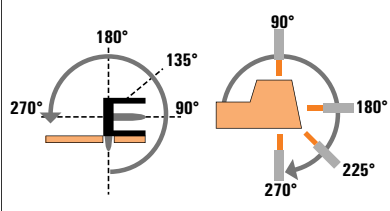

Male header





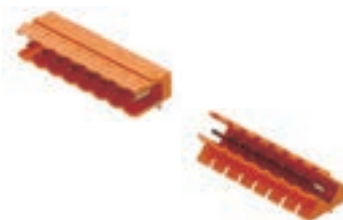



Solder connection



BL/SL 5.00 series



Type	Levels				
	1				
	SL	SL			
	90°	135°			
Orientation	(O)/B	(O)/B			
Flange options					
IEC / UL	IEC: 400 V/18 A UL: 300 V/15 A	IEC: 400 V/17 A UL: 300 V/15 A			
 Screw: Clamping yoke	 BLZP HC 180° (G)/F/LR	IEC: 400 V/19 A/0.2 - 4 mm ² UL: 300 V/10 A/AWG 26 - 12	<input type="radio"/>	<input type="radio"/>	
	 BLZP HC 90° (G)/F/LR	IEC: 400 V/15.5 A/0.2 - 4 mm ² UL: 300 V/10 A/AWG 26 - 12	<input type="radio"/>	<input type="radio"/>	
	 BLZP HC 270° (G)/F/LR	IEC: 400 V/15.5 A/0.2 - 4 mm ² UL: 300 V/10 A/AWG 26 - 12	<input type="radio"/>	<input type="radio"/>	
	 Spring: PUSH IN	 BLF HC 180° (G)/F/LR	IEC: 400 V/20.5 A/0.2 - 2.5 mm ² UL: 300 V/10 A/AWG 26 - 12	<input type="radio"/>	<input type="radio"/>
		 BLF HC 90° (G)/F/LR	IEC: 400 V/20 A/ 0.2 - 2.5 mm ² UL: 300 V/10 A/ AWG 26 - 12	<input type="radio"/>	<input type="radio"/>

Female plug and header:

(G)* = Closed (without flange)

F = Flange with screw

LR = Lock & Release lever

HC = High current

* not included in the article description

Male header and plug:

(O)* = open

B = Dovetail for fixing blocks with a nut

G = closed

F = Screw flange with nut

LF = Solder flange with nut

GLF = closed with additional solder flange

FLF = Flange with nut and additional solder flange

HC = High current

Male header



Solder connection





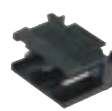

Reflow solder connection



1		2		1		1		2
SL	SLD	SLD	SL-SMT HC	SL-SMT HC	SL-SMaT HC	SL-SMaT HC	SLDV-THR	
180°	90°	180°	90°	180°	90°	180°	180°	180°
(O)/B	G	G	(O)/G/LF	(O)/G/LF	(O)	(O)	(O)	G/GLF/F/FLF
IEC: 400 V/18 A UL: 300 V/15 A	IEC: 400 V/11 A UL: 300 V/10 A	IEC: 400 V/11 A UL: 300 V/10 A	IEC: 400 V/19 A UL: 300 V/15 A	IEC: 400 V/19 A UL: 300 V/15 A	IEC: 400 V/16.5 A UL: 300 V/15 A	IEC: 400 V/16.5 A UL: 300 V/15 A	IEC: 400 V/15 A UL: 300 V/10 A	IEC: 400 V/15 A UL: 300 V/10 A
○	○	○	○	○	○	○	○	○
○			○	○	○	○	○	○
○			○	○	○	○	○	
○	○	○	○	○	○	○	○	○
○			○	○	○	○	○	○



<http://www.OMNIMATE.net>

-  = Wire-to-Board
-  = Board-to-Board
-  = Wire-to-Wire
-  = Board-to-Wire

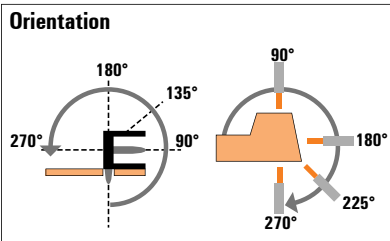
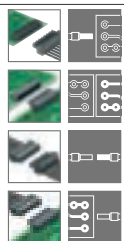

Solder connection

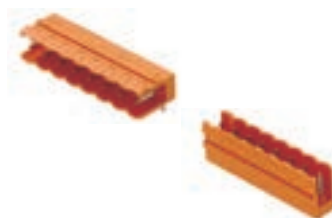

BL/SL 5.08 series, Part 1 of 3



Type	Levels	
	1	
	SL HC	SL HC
	90°	180°
Orientation	(0)/G/B/F/LF	(0)/G/B/F/LF
Flange options		
IEC / UL	IEC: 400 V/24 A UL: 300 V/15 A	IEC: 400 V/24 A UL: 300 V/16 A

	Icon	Type	Orientation	Flange options	IEC / UL	Levels	
						SL HC	SL HC
Female plug		BLZP HC	180°	(G)/F/LR	IEC: 400 V/19 A/0.2 - 4 mm ² UL: 300 V/10 A/AWG 26 - 12	<input type="radio"/>	<input type="radio"/>
			90°	(G)/F/LR	IEC: 400 V/15.5 A/0.2 - 4 mm ² UL: 300 V/10 A/AWG 26 - 12	<input type="radio"/>	<input type="radio"/>
			270°	(G)/F/LR	IEC: 400 V/15.5 A/0.2 - 4 mm ² UL: 300 V/10 A/AWG 26 - 12	<input type="radio"/>	<input type="radio"/>
			225°	(G)/F/LR	IEC: 400 V/17.5 A/0.2 - 4 mm ² UL: 300 V/10 A/AWG 26 - 12	<input type="radio"/>	<input type="radio"/>
TOP		BLT HC	180°	(G)/F/LR/DF	IEC: 400 V/17 A/0.2 - 2.5 mm ² UL: 300 V/10 A/AWG 26 - 14	<input type="radio"/>	<input type="radio"/>
Clamping yoke (twin connector)		BLZ QV	180°	(G)	IEC: 400 V/17.5 A/0.2 - 2.5 mm ² UL: 300 V/15 A/AWG 26 - 14	<input type="radio"/>	<input type="radio"/>
Female header		BLL	90°	(G)/FI	IEC: 400 V/23 A UL: 300 V/15 A	<input type="radio"/>	<input type="radio"/>
			180°	(G)/B	IEC: 400 V/23 A UL: 300 V/15 A	<input type="radio"/>	<input type="radio"/>

Female plug and header:

- (G)* = Closed (without flange)
- F = Flange with screw
- DF = Implementation

- LR = Lock & Release lever
- B = Dovetail for fixing blocks with a nut
- FI = Inverted flange with nut

- HC = High current
- * not included in the article description

Male header



Solder connection



Reflow solder connection



	2				1		
	SLD	SLD	SLDV	SLDV	SL-SMT HC	SL-SMT HC	SL-SMT HC
	90°	180°	90°	180°	90°	180°	270°
	G	G	(O)/B	(O)/B	(O)/G/F/LF	(O)/G/F/LF	G/LF
	IEC: 400 V/11 A UL: 300 V/10 A	IEC: 400 V/14 A UL: 300 V/10 A	IEC: 400 V/17 A UL: 300 V/10 A	IEC: 400 V/17 A UL: 300 V/10 A	IEC: 400 V/19 A UL: 300 V/15 A	IEC: 400 V/19 A UL: 300 V/15 A	IEC: 400 V/19 A UL: 300 V/15 A
	○	○	○	○	○	○	○
			○	○	○	○	○
					○	○	○
	○	○			○	○	○
	○	○	○	○	○	○	○
	○	○			○	○	○
	○	○	○	○	○	○	○
	●	●	●	●	●	●	●
	●	●	●	●	●	●	●

Male header and plug:





- (O)* = open
- B = Dovetail for fixing blocks with a nut
- G = closed

- F = Screw flange with nut
- LF = Solder flange with nut
- DF = Implementation

- HC = High current
- * not included in the article description



<http://www.OMNIMATE.net>

-  = Wire-to-Board
-  = Board-to-Board
-  = Wire-to-Wire
-  = Board-to-Wire

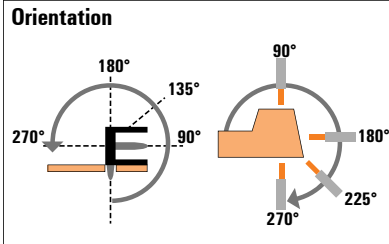
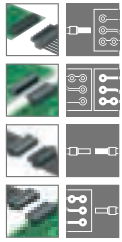











Male header



BL/SL 5.08 series Part 2 of 3

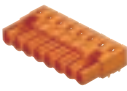

Type	Levels	2
Orientation		180°
Flange options		G/FLF
IEC / UL		IEC: 400 V/15 A UL: 300 V/10 A

Category	Icon	Model	Orientation	Flange options	IEC / UL	Wire-to-Board	Board-to-Board	Wire-to-Wire	Board-to-Wire
Female plug		 BLZP HC 180° (G)/F/LR	180°	(G)/F/LR	IEC: 400 V/19 A/0.2 - 4 mm ² UL: 300 V/10 A/AWG 26 - 12	<input type="radio"/>	<input type="radio"/>	<input type="radio"/>	<input type="radio"/>
		 BLZP HC 90° (G)/F/LR	90°	(G)/F/LR	IEC: 400 V/15.5 A/0.2 - 4 mm ² UL: 300 V/10 A/AWG 26 - 12	<input type="radio"/>	<input type="radio"/>	<input type="radio"/>	<input type="radio"/>
		 BLZP HC 270° (G)/F/LR	270°	(G)/F/LR	IEC: 400 V/15.5 A/0.2 - 4 mm ² UL: 300 V/10 A/AWG 26 - 12	<input type="radio"/>	<input type="radio"/>	<input type="radio"/>	<input type="radio"/>
		 BLZP HC 225° (G)/F/LR	225°	(G)/F/LR	IEC: 400 V/17.5 A/0.2 - 4 mm ² UL: 300 V/10 A/AWG 26 - 12	<input type="radio"/>	<input type="radio"/>	<input type="radio"/>	<input type="radio"/>
TOP		 BLT HC 180° (G)/F/LR/DF	180°	(G)/F/LR/DF	IEC: 400 V/17 A/0.2 - 2.5 mm ² UL: 300 V/10 A/AWG 26 - 14	<input type="radio"/>	<input type="radio"/>	<input type="radio"/>	<input type="radio"/>
		 BLZ QV 180° (G)	180°	(G)	IEC: 400 V/17.5 A/0.2 - 2.5 mm ² UL: 300 V/15 A/AWG 26 - 14	<input type="radio"/>	<input type="radio"/>	<input type="radio"/>	<input type="radio"/>
Female header		 BLL 90° (G)/FI	90°	(G)/FI	IEC: 400 V/23 A UL: 300 V/15 A	<input type="radio"/>	<input checked="" type="radio"/>	<input type="radio"/>	<input type="radio"/>
		 BLL 180° (G)/B	180°	(G)/B	IEC: 400 V/23 A UL: 300 V/15 A	<input type="radio"/>	<input checked="" type="radio"/>	<input type="radio"/>	<input type="radio"/>

Female plug and header:
(G)* = Closed (without flange)
F = Flange with screw
DF = Implementation

LR = Lock & Release lever
B = Dovetail for fixing blocks with a nut
FI = Inverted flange with nut

HC = High current
 * not included in the article description

<http://www.OMNIMATE.net>

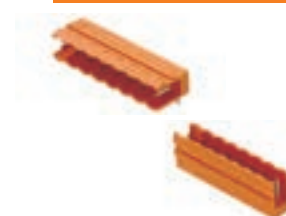
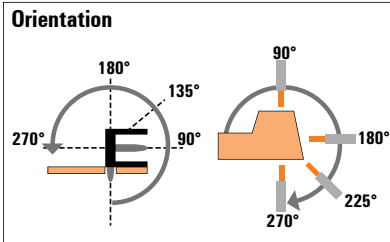
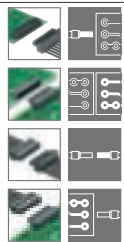

- = Wire-to-Board
- = Board-to-Board
- = Wire-to-Wire
- = Board-to-Wire



BL/SL 5.08 series Part 3 of 3

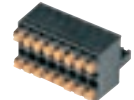
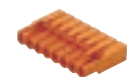

Type	Levels	
	1	
	SL HC	SL HC
	Orientation	90°
Flange options	(O)/G/B/F/LF	(O)/G/B/F/LF
IEC / UL	IEC: 400 V/24 A UL: 300 V/15 A	IEC: 400 V/24 A UL: 300 V/16 A

Female plug	PUSH IN		BLF HC	180°	(G)/F/LR/DF	IEC: 400 V/24 A/0.2 - 2.5 mm ² UL: 300 V/16 A/AWG 12 - AWG 26	○	○	
		PUSH IN (twin connector)		BLF HC	90°	(G)/F/LR	IEC: 400 V/24 A/0.2 - 2.5 mm ² UL: 300 V/16 A/AWG 12 - AWG 26	○	○
				BLF HC	270°	(G)/F/LR	IEC: 400 V/24 A/0.2 - 2.5 mm ² UL: 300 V/16 A/AWG 12 - AWG 26	○	○
			BLDF	180°	(G)/F/LR	IEC: 400 V/26.1 A/0.2 - 2.5 mm ² UL: 300 V/10 A/AWG 26-12	○	○	
	Crimp		BLC	180°	(G)/B	IEC: 400 V/21 A UL: 300 V/10 A	○	○	

Female plug and header:

- (G)* = Closed (without flange)
- F = Flange with screw
- LR = Lock & Release lever

- DF = Implementation
- B = Dovetail for fixing blocks with a nut
- HC = High current

* not included in the article description

Male header	Male plug
 Solder connection	 Reflow solder connection
 PUSH IN	



	2				1			2	1
	SLD	SLD	SLDV	SLDV	SL-SMT HC	SL-SMT HC	SL-SMT HC	SLDV-THR	SLF
	90°	180°	90°	180°	90°	180°	270°	180°	180°
	G	G	(O)/B	(O)/B	(O)/G/F/FL	(O)/G/F/FL	G/FL	G/FL	B/F/FL/DF
	IEC: 400 V/11 A UL: 300 V/10 A	IEC: 400 V/14 A UL: 300 V/10 A	IEC: 400 V/17 A UL: 300 V/10 A	IEC: 400 V/17 A UL: 300 V/10 A	IEC: 400 V/19 A UL: 300 V/15 A	IEC: 400 V/19 A UL: 300 V/15 A	IEC: 400 V/19 A UL: 300 V/15 A	IEC: 400 V/15 A UL: 300 V/10 A	IEC: 400 V/21.5 A/ 0.2 - 2.5 mm ² UL: 300 V/15 A/ AWG 26 - 12
	○	○	○	○	○	○	○	○	●
			○	○	○	○	○	○	●
					○	○	○		●
	○	○	○	○	○	○	○	○	●
	○	○	○	○	○	○	○	○	●

Male header and plug:

- (O)* = open
- B = Dovetail for fixing blocks with a nut
- G = closed

- F = Screw flange with nut
- LF = Solder flange with nut
- FLF = Flange with nut and additional solder flange

- HC = High current
- * not included in the article description



Connectors in 5.00 mm pitch Series BL/SL 5.00

SL-SMT 5.00HC../90

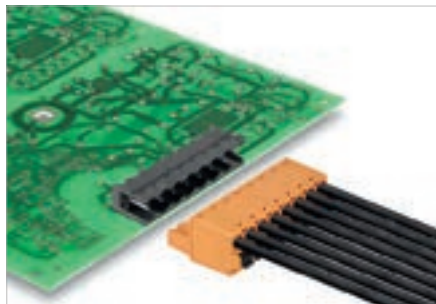

High-temperature-resistant, 90°-angled male header, optimised for SMT processing. The male headers can be manually coded or ordered as pre-coded headers.

- Available in open, closed (G) or with solder Flange (LF).
- The solder flange makes an additional screw-fixation to the PCB unnecessary and protects the solder joints against mechanical stress.
- Available with 1.5 mm or 3.2 mm solder pins.
- Packed either in box (BX) or an anti-static roll (tape-on-reel, RL)
- The 1.5 mm solder pin reduces the solder paste to a minimum without losing holding force to the PCB.

Technical data

In compliance with IEC 60664-1 / IEC 61984			
Clamping range, max.			
Solid core H05(07) V-U			
Stranded H07 V-R			
Flexible H05(07) V-K			
Flexible with ferrule			
Ferrule with plastic collar			
Stripping length			
Screwdriver blade	mm		
According to norm			
Tightening torque range			
Rated current, max.	A	27.5	24
At ambient temperature		20°C	40°C
For conductor cross-section			
Overvoltage category		III	III II
Pollution severity		3	2 2
Rated voltage	V	250	320 400
Rated impulse voltage	kV	4	4 4
UL / CUL (Use Group)		B	C D
Rated voltage	V	300	300
Rated current	A	18.5	10
AWG conductor	AWG		
CSA (Use Group)		B	C D
Rated voltage	V	300	300
Rated current	A	15	15
AWG conductor	AWG		
General data			
Type of insulation material		LCP GF	
UL 94 flammability rating		V-0	
Contact base material		CuMg	
Material of contact surface		tinned	
Pin dimensions = d	mm	1.2, Octagonal	
Solder eyelet Ø = D	mm	1.4	
Solder eyelet Ø tolerance	mm	+ 0,1	

Product data

IEC: 400 V / 27.5 A
UL: 300 V / 18.5 A



For additional articles and information, refer to catalog.weidmueller.com

Note:

- Gold-plated contact surfaces on request
- Rated current related to rated cross-section & min. No. of poles.
- Diameter of solder eyelet D = 1.4 ± 0.1 mm
- Solder eyelet diameter D = 1.5 ± 0.1 mm, from 9 poles
- P on drawing = pitch
- Rated data refer only to the component itself. Clearance and creepage distances to other components are to be designed in accordance with the relevant application standards.

SL-SMT 5.00HC../90 Box

Packaged in box



Dimensioned drawing

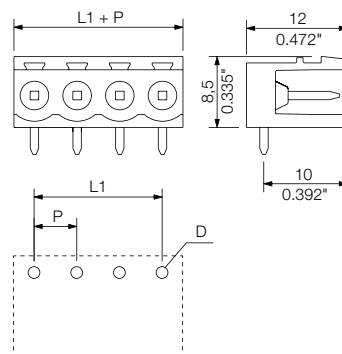

Accessories

Note: Refer to the Accessories chapter for additional accessories.

Coding	Order No.
BLZ/SL KO OR BX	1573010000
BLZ/SL KO BK BX	1545710000
Spacer	
SL AT OR	1598300000
SL AT SW	1770240000
LED light guide	
SL FLA 1.5/1	1580100000
SL FLA 2,3/1	1636670000
SL FLA 2,3/24	1636680000
SL FLA 3,8/1	1580110000
SL FLA 9,0/1	1580120000

Ordering data

Solder pin length		3.2 mm		
Colour		black		
Pitch	5.00 mm			
Pol.	L1	(inch)	Qty.	Order No.
2	5.00	0.197	100	1839890000
3	10.00	0.394	100	1839900000
4	15.00	0.591	100	1839910000
5	20.00	0.787	50	1839920000
6	25.00	0.984	50	1839930000
7	30.00	1.181	50	1839940000
8	35.00	1.378	50	1839950000
9	40.00	1.575	50	1839960000
10	45.00	1.772	50	1839970000
11	50.00	1.969	50	1839980000
12	55.00	2.165	50	1839990000

SL-SMT 5.00HC../90 Tape

Tape-on-reel



Dimensioned drawing

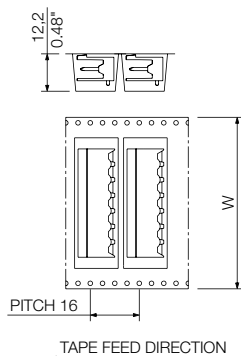

Ordering data

Solder pin length		1.5 mm	
Colour		black	
Pitch		5.00 mm	
Pol.	L1 (inch)	Qty.	Order No.
2	5.00	350	1797620000
3	10.00	350	1797630000
4	15.00	350	1797640000
5	20.00	350	1797650000
6	25.00	350	1797660000
7	30.00	350	1797670000
8	35.00	350	1797680000

Tape widths: 32, 44, 56, 72, 88

SL-SMT 5.00HC../90G Box

Packaged in box



Dimensioned drawing

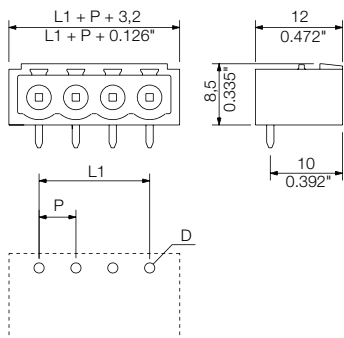

Ordering data

Solder pin length		3.2 mm	
Colour		black	
Pitch		5.00 mm	
Pol.	L1 (inch)	Qty.	Order No.
2	5.00	100	1840120000
3	10.00	100	1840130000
4	15.00	100	1840140000
5	20.00	50	1840150000
6	25.00	50	1840160000
7	30.00	50	1840170000
8	35.00	50	1840180000
9	40.00	50	1840190000
10	45.00	50	1840200000
11	50.00	50	1840210000
12	55.00	50	1840220000

SL-SMT 5.00HC../90G Tape

Tape-on-reel



Dimensioned drawing

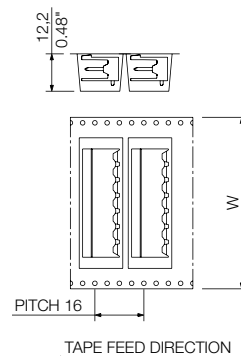

Ordering data

Solder pin length		1.5 mm	
Colour		black	
Pitch		5.00 mm	
Pol.	L1 (inch)	Qty.	Order No.
2	5.00	350	1797690000
3	10.00	350	1797700000
4	15.00	350	1797710000
5	20.00	350	1797720000
6	25.00	350	1797730000
7	30.00	350	1797740000

Tape widths: 32, 44, 56, 72, 88

Connectors in 5.00 mm pitch Series BL/SL 5.00

SL-SMT 5.00HC/./90

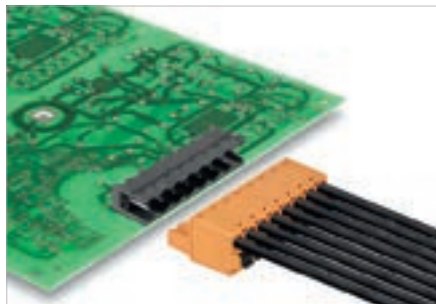

High-temperature-resistant, 90°-angled male header, optimised for SMT processing. The male headers can be manually coded or ordered as pre-coded headers.

- Available in open, closed (G) or with solder Flange (LF).
- The solder flange makes an additional screw-fixation to the PCB unnecessary and protects the solder joints against mechanical stress.
- Available with 1.5 mm or 3.2 mm solder pins.
- Packed either in box (BX) or an anti-static roll (tape-on-reel, RL)
- The 1.5 mm solder pin reduces the solder paste to a minimum without losing holding force to the PCB.

Technical data

In compliance with IEC 60664-1 / IEC 61984			
Clamping range, max.			
Solid core H05(07) V-U			
Stranded H07 V-R			
Flexible H05(07) V-K			
Flexible with ferrule			
Ferrule with plastic collar			
Stripping length			
Screwdriver blade	mm		
According to norm			
Tightening torque range			
Rated current, max.	A	27.5	24
At ambient temperature		20°C	40°C
For conductor cross-section			
Overvoltage category		III	III II
Pollution severity		3	2 2
Rated voltage	V	250	320 400
Rated impulse voltage	kV	4	4 4
UL / CUL (Use Group)		B	C D
Rated voltage	V	300	300
Rated current	A	18.5	10
AWG conductor	AWG		-
CSA (Use Group)		B	C D
Rated voltage	V	300	300
Rated current	A	15	15
AWG conductor	AWG		-
General data			
Type of insulation material		LCP GF	
UL 94 flammability rating		V-0	
Contact base material		CuMg	
Material of contact surface		tinned	
Pin dimensions = d	mm	1.2, Octagonal	
Solder eyelet Ø = D	mm	1.5	
Solder eyelet Ø tolerance	mm	+ 0,1	

Product data

IEC: 400 V / 27.5 A
UL: 300 V / 18.5 A



For additional articles and information, refer to catalog.weidmueller.com

Note:

- Gold-plated contact surfaces on request
- Rated current related to rated cross-section & min. No. of poles.
- P on drawing = pitch
- Rated data refer only to the component itself. Clearance and creepage distances to other components are to be designed in accordance with the relevant application standards.

SL-SMT 5.00HC/./90LF Box

Packaged in box; with solder flange



Dimensioned drawing

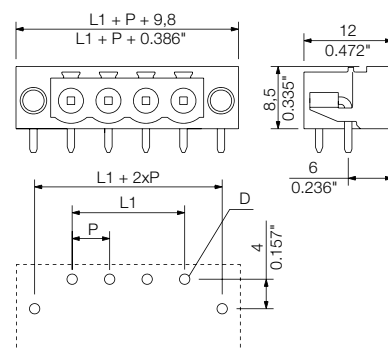

Accessories

Note: Refer to the Accessories chapter for additional accessories.

Coding	Order No.
BLZ/SL KO OR BX	1573010000
BLZ/SL KO BK BX	1545710000
Spacer	
SL AT OR	1598300000
SL AT SW	1770240000
LED light guide	
SL FLA 1.5/1	1580100000
SL FLA 2,3/1	1636670000
SL FLA 2,3/24	1636680000
SL FLA 3,8/1	1580110000
SL FLA 9,0/1	1580120000

Ordering data

Solder pin length		3.2 mm		
Colour		black		
Pitch	5.00 mm			
Pol.	L1	(inch)	Qty.	Order No.
2	5.00	0.197	90	1840350000
3	10.00	0.394	72	1840360000
4	15.00	0.591	60	1840370000
5	20.00	0.787	48	1840380000
6	25.00	0.984	42	1840390000
7	30.00	1.181	42	1840400000
8	35.00	1.378	36	1840410000
9	40.00	1.575	30	1840420000
10	45.00	1.772	30	1840430000
11	50.00	1.969	24	1840440000
12	55.00	2.165	24	1840450000

L

5.00

90°

SL-SMT 5.00HC/./90LF Tape

Tape-on-reel; with solder flange



Dimensioned drawing

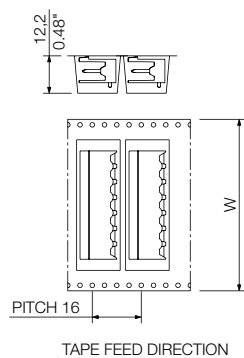

Solder flange (LF)

Normally you use a pin header with fastening flanges (F) in combination with a screw from the rear side of the PCB to increase the fixation forces of the pin headers. The disadvantages are additional process steps that make the PCB mounting complex and cost intensive. The patented solder flange was designed to solve exactly this problem and find a simple and cheap solution. The additional solder pins substitute the present screw flanges and they get soldered together with the pin header. This terminates additional process steps and thus reduces production costs. The additional fixation protects the soldered connections from tensile strain and avoids permanent mechanical stress such as caused by the post-fastened screw forces.



Ordering data

Solder pin length		1.5 mm		
Colour		black		
Pitch		5.00 mm		
Pol.	L1	(inch)	Qty.	Order No.
2	5.00	0.197	350	1797750000
3	10.00	0.394	350	1797760000
4	15.00	0.591	350	1797770000
5	20.00	0.787	350	1797780000
6	25.00	0.984	350	1797790000

Tape widths: 32, 44, 56, 72, 88

Connectors in 5.00 mm pitch Series BL/SL 5.00

SL-SMT 5.00HC../180

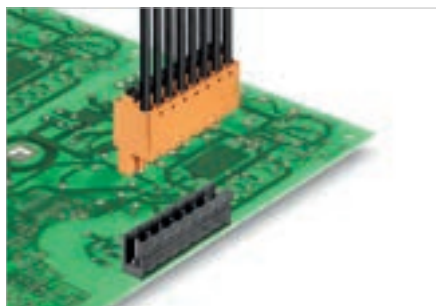

High-temperature-resistant, 180°-angled male header, optimised for SMT processing. The male headers can be manually coded or ordered as pre-coded headers.

- Available in open, closed (G) or with solder Flange (LF).
- The solder flange makes an additional screw-fixation to the PCB unnecessary and protects the solder joints against mechanical stress.
- Available with 1.5 mm or 3.2 mm solder pins.
- Packed either in box (BX) or an anti-static roll (tape-on-reel, RL)
- The 1.5 mm solder pin reduces the solder paste to a minimum without losing holding force to the PCB.

Technical data

In compliance with IEC 60664-1 / IEC 61984			
Clamping range, max.			
Solid core H05(07) V-U			
Stranded H07 V-R			
Flexible H05(07) V-K			
Flexible with ferrule			
Ferrule with plastic collar			
Stripping length			
Screwdriver blade	mm		
According to norm			
Tightening torque range			
Rated current, max.	A	27.5	24
At ambient temperature		20°C	40°C
For conductor cross-section			
Overvoltage category		III	III II
Pollution severity		3	2 2
Rated voltage	V	250	320 400
Rated impulse voltage	kV	4	4 4
UL / CUL (Use Group)		B	C D
Rated voltage	V	300	300
Rated current	A	18.5	10
AWG conductor	AWG		-
CSA (Use Group)		B	C D
Rated voltage	V	300	300
Rated current	A	15	15
AWG conductor	AWG		-
General data			
Type of insulation material		LCP GF	
UL 94 flammability rating		V-0	
Contact base material		CuMg	
Material of contact surface		tinned	
Pin dimensions = d	mm	1.2, Octagonal	
Solder eyelet Ø = D	mm	1.4	
Solder eyelet Ø tolerance	mm	+ 0,1	

Product data

IEC: 400 V / 27.5 A
UL: 300 V / 18.5 A



For additional articles and information, refer to catalog.weidmuller.com

Note:

- Gold-plated contact surfaces on request
- Rated current related to rated cross-section & min. No. of poles.
- Diameter of solder eyelet D = 1.4±0.1 mm
- Solder eyelet diameter D = 1.5 + 0.1 mm, from 9 poles
- P on drawing = pitch
- Rated data refer only to the component itself. Clearance and creepage distances to other components are to be designed in accordance with the relevant application standards.

SL-SMT 5.00HC../180 Box

Packaged in box



Dimensioned drawing

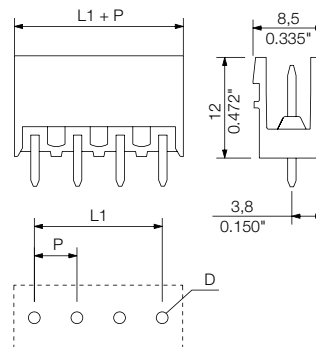

Accessories

Note: Refer to the Accessories chapter for additional accessories.

Coding	Order No.
BLZ/SL KO OR BX	1573010000
BLZ/SL KO BK BX	1545710000
Spacer	
SL AT OR	1598300000
SL AT SW	1770240000

Ordering data

Solder pin length		3.2 mm		
Colour		black		
Pitch	5.00 mm			
Pol.	L1	(inch)	Qty.	Order No.
2	5.00	0.197	100	1840920000
3	10.00	0.394	100	1840930000
4	15.00	0.591	100	1840940000
5	20.00	0.787	50	1840950000
6	25.00	0.984	50	1840960000
7	30.00	1.181	50	1840970000
8	35.00	1.378	50	1840980000
9	40.00	1.575	50	1840990000
10	45.00	1.772	50	1841000000
11	50.00	1.969	50	1841020000
12	55.00	2.165	50	1841030000

SL-SMT 5.00HC../180 Tape

Tape-on-reel



Dimensioned drawing

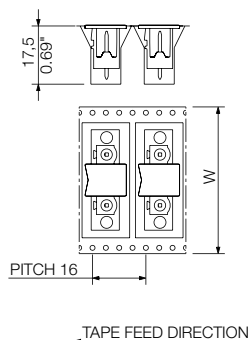

Ordering data

Solder pin length		1.5 mm	
Colour		black	
Pitch		5.00 mm	
Pol.	L1	(inch)	Qty. Order No.
2	5.00	0.197	250 1797800000
3	10.00	0.394	250 1797810000
4	15.00	0.591	250 1797820000
5	20.00	0.787	250 1797830000
6	25.00	0.984	250 1797840000
7	30.00	1.181	250 1797850000
8	35.00	1.378	250 1797860000

SL-SMT 5.00HC../180G Box

Packaged in box



Dimensioned drawing

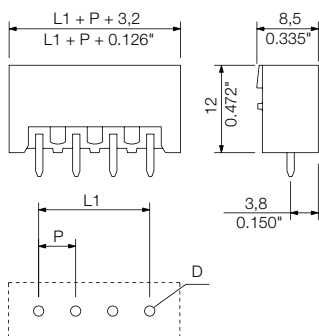

Ordering data

Solder pin length		3.2 mm	
Colour		black	
Pitch		5.00 mm	
Pol.	L1	(inch)	Qty. Order No.
2	5.00	0.197	100 1841160000
3	10.00	0.394	100 1841170000
4	15.00	0.591	100 1841180000
5	20.00	0.787	50 1841190000
6	25.00	0.984	50 1841200000
7	30.00	1.181	50 1841210000
8	35.00	1.378	50 1841220000
9	40.00	1.575	50 1841230000
10	45.00	1.772	50 1841240000
11	50.00	1.969	50 1841250000
12	55.00	2.165	50 1841260000

SL-SMT 5.00HC../180G Tape

Tape-on-reel



Dimensioned drawing

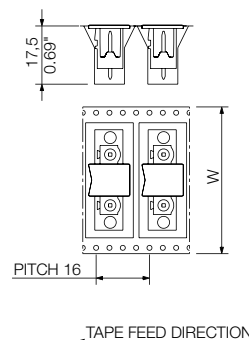

Ordering data

Solder pin length		1.5 mm	
Colour		black	
Pitch		5.00 mm	
Pol.	L1	(inch)	Qty. Order No.
2	5.00	0.197	250 1797870000
3	10.00	0.394	250 1797880000
4	15.00	0.591	250 1797890000
5	20.00	0.787	250 1797900000
6	25.00	0.984	250 1797910000
7	30.00	1.181	250 1797920000
8	35.00	1.378	205 1110720000

Tape widths: 32, 44, 56, 72, 88

Tape widths: 32, 44, 56, 72, 88

Connectors in 5.00 mm pitch Series BL/SL 5.00

SL-SMT 5.00HC../180

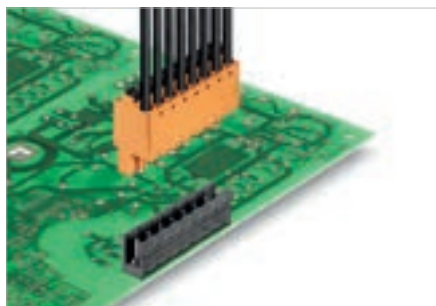

High-temperature-resistant, 180°-angled male header, optimised for SMT processing. The male headers can be manually coded or ordered as pre-coded headers.

- Available in open, closed (G) or with solder Flange (LF).
- The solder flange makes an additional screw-fixation to the PCB unnecessary and protects the solder joints against mechanical stress.
- Available with 1.5 mm or 3.2 mm solder pins.
- Packed either in box (BX) or an anti-static roll (tape-on-reel, RL)
- The 1.5 mm solder pin reduces the solder paste to a minimum without losing holding force to the PCB.

Technical data

In compliance with IEC 60664-1 / IEC 61984			
Clamping range, max.			
Solid core H05(07) V-U			
Stranded H07 V-R			
Flexible H05(07) V-K			
Flexible with ferrule			
Ferrule with plastic collar			
Stripping length			
Screwdriver blade	mm		
According to norm			
Tightening torque range			
Rated current, max.	A	27.5	24
At ambient temperature		20°C	40°C
For conductor cross-section			
Overvoltage category		III	III II
Pollution severity		3	2 2
Rated voltage	V	250	320 400
Rated impulse voltage	kV	4	4 4
UL / CUL (Use Group)		B	C D
Rated voltage	V	300	300
Rated current	A	18.5	10
AWG conductor	AWG		-
CSA (Use Group)		B	C D
Rated voltage	V	300	300
Rated current	A	15	15
AWG conductor	AWG		-
General data			
Type of insulation material		LCP GF	
UL 94 flammability rating		V-0	
Contact base material		CuMg	
Material of contact surface		tinned	
Pin dimensions = d	mm	1.2, Octagonal	
Solder eyelet Ø = D	mm	1.5	
Solder eyelet Ø tolerance	mm	+ 0,1	

Product data

IEC: 400 V / 27.5 A
UL: 300 V / 18.5 A



For additional articles and information, refer to catalog.weidmuller.com

Note:

- Gold-plated contact surfaces on request
- Rated current related to rated cross-section & min. No. of poles.
- P on drawing = pitch
- Rated data refer only to the component itself. Clearance and creepage distances to other components are to be designed in accordance with the relevant application standards.

SL-SMT 5.00HC../180LF Box

Packaged in box; with solder flange



Dimensioned drawing

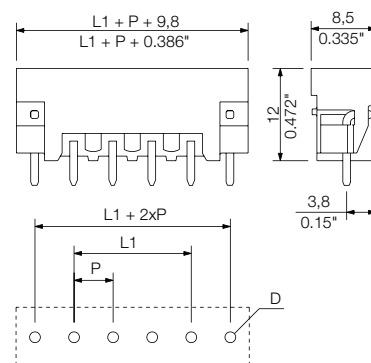

Accessories

Note: Refer to the Accessories chapter for additional accessories.

Coding	Order No.
BLZ/SL KO OR BX	1573010000
BLZ/SL KO BK BX	1545710000
Spacer	
SL AT OR	1598300000
SL AT SW	1770240000

Ordering data

Solder pin length		3.2 mm		
Colour		black		
Pitch	5.00 mm			
Pol.	L1	(inch)	Qty.	Order No.
2	5.00	0.197	90	1841390000
3	10.00	0.394	72	1841400000
4	15.00	0.591	60	1841410000
5	20.00	0.787	54	1841420000
6	25.00	0.984	42	1841430000
7	30.00	1.181	42	1841440000
8	35.00	1.378	36	1841450000
9	40.00	1.575	30	1841460000
10	45.00	1.772	30	1841470000
11	50.00	1.969	24	1841480000
12	55.00	2.165	24	1841490000

SL-SMT 5.00HC/./180LF Tape

Tape-on-reel; with solder flange



Dimensioned drawing

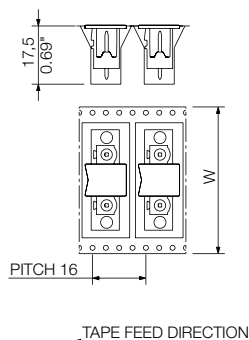

Solder flange (LF)

Normally you use a pin header with fastening flanges (F) in combination with a screw from the rear side of the PCB to increase the fixation forces of the pin headers. The disadvantages are additional process steps that make the PCB mounting complex and cost intensive. The patented solder flange was designed to solve exactly this problem and find a simple and cheap solution. The additional solder pins substitute the present screw flanges and they get soldered together with the pin header. This terminates additional process steps and thus reduces production costs. The additional fixation protects the soldered connections from tensile strain and avoids permanent mechanical stress such as caused by the post-fastened screw forces.



Ordering data

Solder pin length		1.5 mm		
Colour		black		
Pitch		5.00 mm		
Pol.	L1	(inch)	Qty.	Order No.
2	5.00	0.197	250	1797930000
3	10.00	0.394	250	1797940000
4	15.00	0.591	250	1797950000
5	20.00	0.787	250	1797960000
6	25.00	0.984	250	1797970000

Tape widths: 32, 44, 56, 72, 88

Connectors in 5.00 mm pitch Series BL/SL 5.00

SLDV-THR 5.00/./180

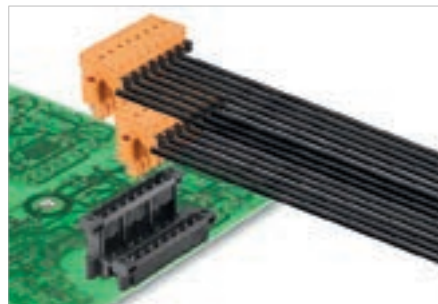

Double-level, 180° male header, optimised for the SMT process. The connection levels are offset and designed for a female plug with screw connection or PUSH IN wire connect. The male headers can be manually coded or ordered as pre-coded headers.

- Available in closed (G), with solder flange (GLF), screw flange (F) or screw & solder flange (FLF).
- The solder flange makes an additional screw-fixation to the PCB unnecessary and protects the solder joints against mechanical stress.
- Available with 1.5 mm or 3.2 mm solder pins.
- The 1.5 mm solder pin reduces the solder paste to a minimum without losing holding force to the PCB.
- The FLF version is featured with a soldering flange and an additional screw-fastening possibility to the PCB.

Technical data

In compliance with IEC 60664-1 / IEC 61984

Clamping range, max.			
Solid core H05(07) V-U			
Stranded H07 V-R			
Flexible H05(07) V-K			
Flexible with ferrule			
Ferrule with plastic collar			
Stripping length			
Screwdriver blade	mm		
According to norm			
Tightening torque range			
Rated current, max.	A	15	13
At ambient temperature		20°C	40°C
For conductor cross-section			
Overvoltage category		III	III II
Pollution severity		3	2 2
Rated voltage	V	250	320 400
Rated impulse voltage	kV	4	4 4
UL / CUL (Use Group)		B	C D
Rated voltage	V	300	300
Rated current	A	10	10
AWG conductor	AWG		-
CSA (Use Group)		B	C D
Rated voltage	V	300	300
Rated current	A	10	10
AWG conductor	AWG		-
General data			
Type of insulation material		LCP GF	
UL 94 flammability rating		V-0	
Contact base material		CuSn	
Material of contact surface		tinned	
Pin dimensions = d	mm	1.2, Octagonal	
Solder eyelet Ø = D	mm	1.5	
Solder eyelet Ø tolerance	mm	+ 0,1	

Product data

IEC: 400 V / 15 A
UL: 300 V / 10 A



For additional articles and information, refer to catalog.weidmuller.com

Note:

- Rated current related to rated cross-section & min. No. of poles.
- Spacing between rows: see hole layout
- P on drawing = pitch
- Rated data refer only to the component itself. Clearance and creepage distances to other components are to be designed in accordance with the relevant application standards.

SLDV-THR 5.00/./180G

without solder flange



Dimensioned drawing

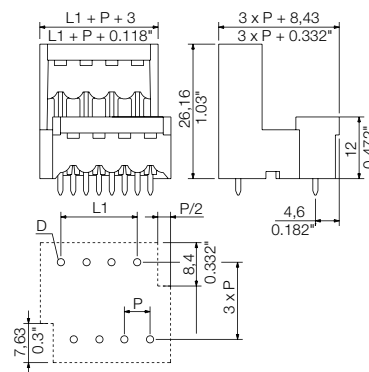

Accessories

Note: Refer to the Accessories chapter for additional accessories.

Coding	Order No.
BLZ/SL KO OR BX	1573010000
BLZ/SL KO BK BX	1545710000
Spacer	
SL AT OR	1598300000
SL AT SW	1770240000

Ordering data

Solder pin length		3.2 mm		
Colour		black		
Pitch	5.00 mm			
Pol.	L1	(inch)	Qty.	Order No.
4	5.00	0.197	50	1882690000
6	10.00	0.394	50	1882700000
8	15.00	0.591	50	1862370000
10	20.00	0.787	50	1882710000
12	25.00	0.984	50	1882720000
14	30.00	1.181	20	1882730000
16	35.00	1.378	20	1862380000
18	40.00	1.575	20	1882740000
20	45.00	1.772	20	1862390000
22	50.00	1.969	10	1882750000
24	55.00	2.165	10	1882760000

SLDV-THR 5.00../180GLF

with solder flange



Dimensioned drawing

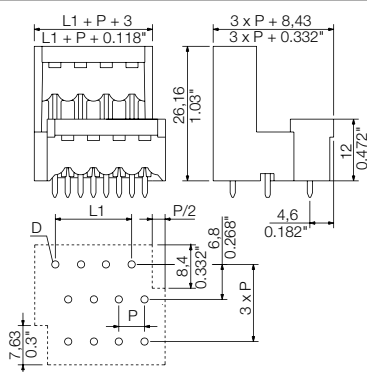

Ordering data

Solder pin length		3.2 mm	
Colour		black	
Pitch	5.00 mm		
Pol.	L1	(inch)	Qty. Order No.
4	5.00	0.197	50 1911290000
6	10.00	0.394	50 1911310000
8	15.00	0.591	50 1911320000
10	20.00	0.787	50 1911330000
12	25.00	0.984	50 1911340000
14	30.00	1.181	20 1911350000
16	35.00	1.378	20 1911360000
18	40.00	1.575	20 1911370000
20	45.00	1.772	20 1911410000
22	50.00	1.969	10 1911470000
24	55.00	2.165	10 1911500000

SLDV-THR 5.00../180F

without solder flange



Dimensioned drawing

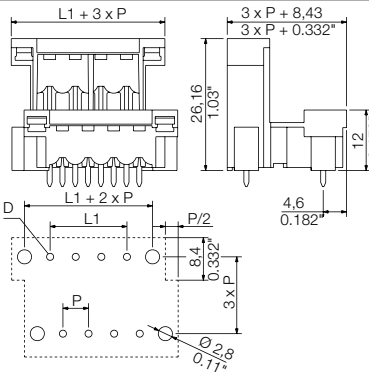

Ordering data

Solder pin length		3.2 mm	
Colour		black	
Pitch	5.00 mm		
Pol.	L1	(inch)	Qty. Order No.
4	5.00	0.197	50 1882930000
6	10.00	0.394	50 1882940000
8	15.00	0.591	50 1882950000
10	20.00	0.787	50 1882960000
12	25.00	0.984	50 1882970000
14	30.00	1.181	20 1882980000
16	35.00	1.378	20 1882990000
18	40.00	1.575	20 1883000000
20	45.00	1.772	20 1881340000
22	50.00	1.969	10 1883010000
24	55.00	2.165	10 1881370000

SLDV-THR 5.00../180FLF

with solder flange



Dimensioned drawing

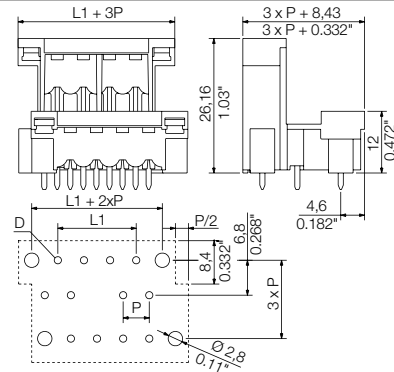

Ordering data

Solder pin length		3.2 mm	
Colour		black	
Pitch	5.00 mm		
Pol.	L1	(inch)	Qty. Order No.
4	5.00	0.197	50 1883100000
6	10.00	0.394	50 1883110000
8	15.00	0.591	50 1883120000
10	20.00	0.787	50 1883130000
12	25.00	0.984	50 1883140000
14	30.00	1.181	20 1883150000
16	35.00	1.378	20 1883160000
18	40.00	1.575	20 1883170000
20	45.00	1.772	20 1883180000
22	50.00	1.969	10 1883190000
24	55.00	2.165	10 1883200000



Connectors in 5.00 mm pitch Series BL/SL 5.00

SL 5.00/./90

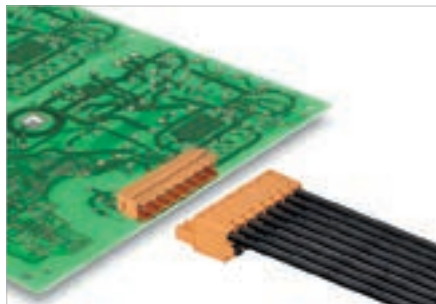

Male headers with 90° orientation, optimised for wave soldering. Available in versions with either open or closed ends (B). Mounting blocks can be attached into the closed variants. The blocks can be used to screw on to the female plug of the circuit board. The male headers can be manually coded or ordered as pre-coded headers.

Technical data

In compliance with IEC 60664-1 / IEC 61984

Clamping range, max.			
Solid core H05(07) V-U			
Stranded H07 V-R			
Flexible H05(07) V-K			
Flexible with ferrule			
Ferrule with plastic collar			
Stripping length			
Screwdriver blade	mm		
According to norm			
Tightening torque range			
Rated current, max.	A	18	15
At ambient temperature		20°C	40°C
For conductor cross-section			
Overvoltage category		III	III II
Pollution severity		3	2 2
Rated voltage	V	250	320 400
Rated impulse voltage	kV	4	4 4
UL / CUL (Use Group)	B C D		
Rated voltage	V	300	300
Rated current	A	15	10
AWG conductor	AWG		-
CSA (Use Group)	B C D		
Rated voltage	V	300	300
Rated current	A	15	10
AWG conductor	AWG		-
General data			
Type of insulation material		PBT	
UL 94 flammability rating		V-0	
Contact base material		CuSn	
Material of contact surface		tinned	
Pin dimensions = d	mm	1.2, Octagonal	
Solder eyelet Ø = D	mm	1.3	
Solder eyelet Ø tolerance	mm	+ 0,1	

Product data

IEC: 400 V / 18 A
UL: 300 V / 15 A



For additional articles and information, refer to catalog.weidmuller.com

Note:

- Additional colours on request
- Gold-plated contact surfaces on request
- Rated current related to rated cross-section & min. No. of poles.
- P on drawing = pitch
- Rated data refer only to the component itself. Clearance and creepage distances to other components are to be designed in accordance with the relevant application standards.

SL 5.00/./90



Dimensioned drawing

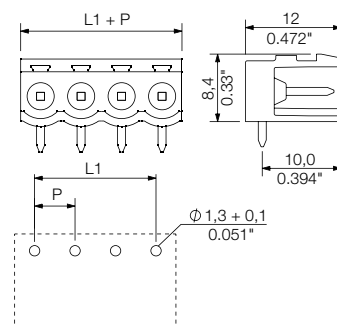

Accessories

Note: Refer to the Accessories chapter for additional accessories.

Coding	Order No.
BLZ/SL KO OR BX	1573010000
BLZ/SL KO BK BX	1545710000
Spacer	
SL AT OR	1598300000
SL AT SW	1770240000
LED light guide	
SL FLA 1.5/1	1580100000
SL FLA 2,3/1	1636670000
SL FLA 2,3/24	1636680000
SL FLA 3.8/1	1580110000
SL FLA 9.0/1	1580120000
Mounting block	
SLA BB11R OR	1604120000
SLA BB11R SW	1692340000

Ordering data

Solder pin length		3.2 mm		
Colour		orange		
Pitch	5.00 mm			
Pol.	L1	(inch)	Qty.	Order No.
2	5.00	0.197	100	1571130000
3	10.00	0.394	100	1571140000
4	15.00	0.591	100	1571150000
5	20.00	0.787	50	1571160000
6	25.00	0.984	50	1571170000
7	30.00	1.181	50	1571180000
8	35.00	1.378	50	1571190000
9	40.00	1.575	50	1571200000
10	45.00	1.772	50	1571210000
11	50.00	1.969	50	1571220000
12	55.00	2.165	50	1571110000

SL 5.00/..90B



Dimensioned drawing

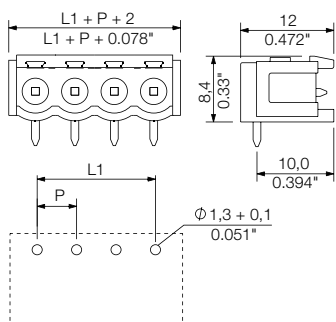

Ordering data

Solder pin length		3.2 mm	
Colour		orange	
Pitch		5.00 mm	
Pol.	L1	(inch)	Qty. Order No.
2	5.00	0.197	100 1580860000
3	10.00	0.394	100 1580870000
4	15.00	0.591	100 1580880000
5	20.00	0.787	50 1580890000
6	25.00	0.984	50 1580900000
7	30.00	1.181	50 1580910000
8	35.00	1.378	50 1580920000
9	40.00	1.575	50 1580930000
10	45.00	1.772	50 1580940000
11	50.00	1.969	50 1580950000
12	55.00	2.165	50 1580960000

Connectors in 5.00 mm pitch Series BL/SL 5.00

SL 5.00/././180

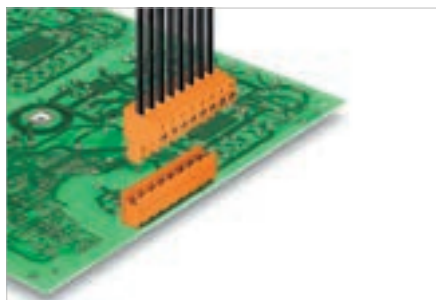

Male headers with 180° wire outlet, optimised for wave soldering. Available in versions with either open or closed ends (B). Mounting blocks can be attached onto the closed variants. The blocks can be used to screw on to the female plug of the circuit board. The male headers can be manually coded or ordered as pre-coded headers.

Technical data

In compliance with IEC 60664-1 / IEC 61984

Clamping range, max.			
Solid core H05(07) V-U			
Stranded H07 V-R			
Flexible H05(07) V-K			
Flexible with ferrule			
Ferrule with plastic collar			
Stripping length			
Screwdriver blade	mm		
According to norm			
Tightening torque range			
Rated current, max.	A	18	15
At ambient temperature		20°C	40°C
For conductor cross-section			
Overvoltage category		III	III II
Pollution severity		3	2 2
Rated voltage	V	250	320 400
Rated impulse voltage	kV	4	4 4
UL / CUL (Use Group)		B	C D
Rated voltage	V	300	300
Rated current	A	15	10
AWG conductor	AWG		-
CSA (Use Group)		B	C D
Rated voltage	V	300	300
Rated current	A	15	10
AWG conductor	AWG		-
General data			
Type of insulation material		PBT	
UL 94 flammability rating		V-0	
Contact base material		CuSn	
Material of contact surface		tinned	
Pin dimensions = d	mm	1.2, Octagonal	
Solder eyelet Ø = D	mm	1.3	
Solder eyelet Ø tolerance	mm	+ 0,1	

Product data

IEC: 400 V / 18 A
UL: 300 V / 15 A



For additional articles and information, refer to catalog.weidmuller.com

Note:

- Additional colours on request
- Gold-plated contact surfaces on request
- Rated current related to rated cross-section & min. No. of poles.
- P on drawing = pitch
- Rated data refer only to the component itself. Clearance and creepage distances to other components are to be designed in accordance with the relevant application standards.

SL 5.00/././180

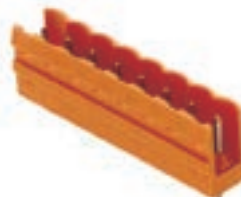

Dimensioned drawing

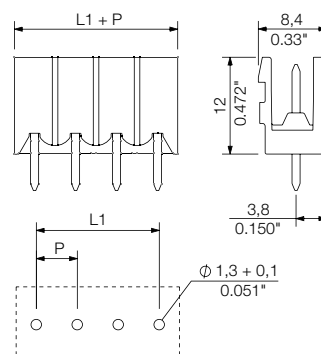

Accessories

Note: Refer to the Accessories chapter for additional accessories.

Coding	Order No.
BLZ/SL KO OR BX	1573010000
BLZ/SL KO BK BX	1545710000
Spacer	
SL AT OR	1598300000
SL AT SW	1770240000
Mounting block	
SLA BB11R OR	1604120000
SLA BB11R SW	1692340000

Ordering data

Solder pin length		3.2 mm		
Colour		orange		
Pitch	5.00 mm			
Pol.	L1	(inch)	Qty.	Order No.
2	5.00	0.197	100	1581320000
3	10.00	0.394	100	1581330000
4	15.00	0.591	100	1581340000
5	20.00	0.787	50	1581350000
6	25.00	0.984	50	1581360000
7	30.00	1.181	50	1581370000
8	35.00	1.378	50	1581380000
9	40.00	1.575	50	1581390000
10	45.00	1.772	50	1581400000
11	50.00	1.969	50	1581410000
12	55.00	2.165	50	1581420000

L

5.00

180°

SL 5.00/.. /180B



Dimensioned drawing

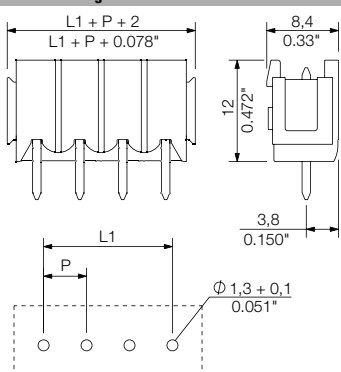

Ordering data

Solder pin length		3.2 mm	
Colour		orange	
Pitch		5.00 mm	
Pol.	L1	(inch)	Qty. Order No.
2	5.00	0.197	100 1581780000
3	10.00	0.394	100 1581790000
4	15.00	0.591	100 1581800000
5	20.00	0.787	50 1581810000
6	25.00	0.984	50 1581820000
7	30.00	1.181	50 1581830000
8	35.00	1.378	50 1581840000
9	40.00	1.575	50 1581850000
10	45.00	1.772	50 1581860000
11	50.00	1.969	50 1581870000
12	55.00	2.165	50 1581880000



Connectors in 5.00 mm pitch Series BL/SL 5.00

SL 5.00/././135

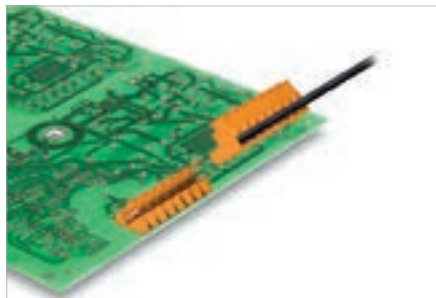

Male headers with 135° wire outlet, optimised for wave soldering. Available in versions with either open or closed ends (B). Mounting blocks can be attached onto the closed variants. The blocks can be used to screw on to the female plug of the circuit board. The male headers can be manually coded or ordered as pre-coded headers.

Technical data

In compliance with IEC 60664-1 / IEC 61984			
Clamping range, max.			
Solid core H05(07) V-U			
Stranded H07 V-R			
Flexible H05(07) V-K			
Flexible with ferrule			
Ferrule with plastic collar			
Stripping length			
Screwdriver blade	mm		
According to norm			
Tightening torque range			
Rated current, max.	A	17	15
At ambient temperature		20°C	40°C
For conductor cross-section			
Overvoltage category		III	III II
Pollution severity		3	2 2
Rated voltage	V	250	320 400
Rated impulse voltage	kV	4	4 4
UL / CUL (Use Group)		B	C D
Rated voltage	V	300	300
Rated current	A	15	10
AWG conductor	AWG		-
CSA (Use Group)		B	C D
Rated voltage	V	300	300
Rated current	A	15	10
AWG conductor	AWG		-
General data			
Type of insulation material		PBT	
UL 94 flammability rating		V-0	
Contact base material		CuSn	
Material of contact surface		tinned	
Pin dimensions = d	mm	1.2, Octagonal	
Solder eyelet Ø = D	mm	1.3	
Solder eyelet Ø tolerance	mm	+ 0,1	

Product data

IEC: 400 V / 17 A
UL: 300 V / 15 A



For additional articles and information, refer to catalog.weidmueller.com

Note:

- Additional colours on request
- Gold-plated contact surfaces on request
- Rated current related to rated cross-section & min. No. of poles.
- P on drawing = pitch
- Rated data refer only to the component itself. Clearance and creepage distances to other components are to be designed in accordance with the relevant application standards.

SL 5.00/././135



Dimensioned drawing

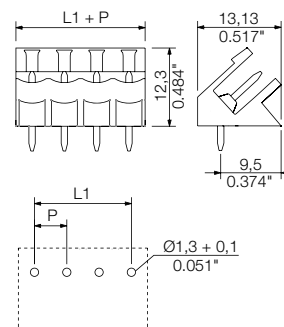

Accessories

Note: Refer to the Accessories chapter for additional accessories.

Coding	Order No.
BLZ/SL KO OR BX	1573010000
BLZ/SL KO BK BX	1545710000
Spacer	
SL AT OR	1598300000
SL AT SW	1770240000
Mounting block	
SL 135 BB15R OR	1606450000
SL 135 BB15R SW	1636370000

Ordering data

Solder pin length		3.2 mm		
Colour		orange		
Pitch	5.00 mm			
Pol.	L1	(inch)	Qty.	Order No.
2	5.00	0.197	100	1630250000
3	10.00	0.394	100	1630260000
4	15.00	0.591	100	1630270000
5	20.00	0.787	50	1630280000
6	25.00	0.984	50	1630290000
7	30.00	1.181	50	1630300000
8	35.00	1.378	50	1630310000
9	40.00	1.575	50	1630320000
10	45.00	1.772	50	1630330000
11	50.00	1.969	50	1630340000
12	55.00	2.165	50	1630350000

SL 5.00/..../135B



Dimensioned drawing

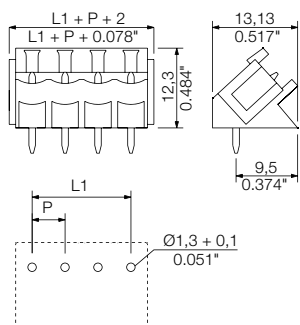

Ordering data

Solder pin length		3.2 mm	
Colour		orange	
Pitch		5.00 mm	
Pol.	L1	(inch)	Qty. Order No.
2	5.00	0.197	100 1630480000
3	10.00	0.394	100 1630490000
4	15.00	0.591	100 1630500000
5	20.00	0.787	50 1630510000
6	25.00	0.984	50 1630520000
7	30.00	1.181	50 1630530000
8	35.00	1.378	50 1630540000
9	40.00	1.575	50 1630550000
10	45.00	1.772	50 1630560000
11	50.00	1.969	50 1630570000
12	55.00	2.165	50 1630580000

Connectors in 5.00 mm pitch Series BL/SL 5.00

SLD 5.00/./90 & 180

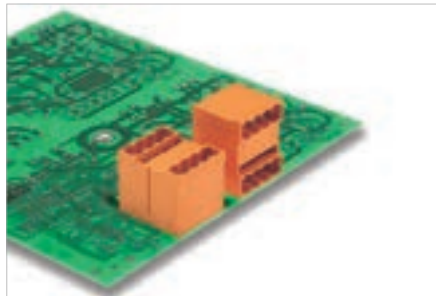

Double-level male header optimised for wave soldering. The connections are at the same level – with access that is flush over the front board. The male headers can be manually coded or ordered as pre-coded headers.

Technical data

In compliance with IEC 60664-1 / IEC 61984

Clamping range, max.			
Solid core H05(07) V-U			
Stranded H07 V-R			
Flexible H05(07) V-K			
Flexible with ferrule			
Ferrule with plastic collar			
Stripping length			
Screwdriver blade	mm		
According to norm			
Tightening torque range			
Rated current, max.	A	11	9.5
At ambient temperature		20°C	40°C
For conductor cross-section			
Overvoltage category		III	III II
Pollution severity		3	2 2
Rated voltage	V	250	320 400
Rated impulse voltage	kV	4	4 4
UL / CUL (Use Group)	B C D		
Rated voltage	V	300	300
Rated current	A	10	10
AWG conductor	AWG	-	
CSA (Use Group)	B C D		
Rated voltage	V	300	300
Rated current	A	10	10
AWG conductor	AWG	-	
General data			
Type of insulation material	PBT		
UL 94 flammability rating	V-0		
Contact base material	CuSn		
Material of contact surface	tinned		
Pin dimensions = d	mm	1.2, Octagonal	
Solder eyelet Ø = D	mm	1.3	
Solder eyelet Ø tolerance	mm	+ 0,1	

Product data

IEC: 400 V / 11 A
UL: 300 V / 10 A



For additional articles and information, refer to catalog.weidmueller.com

Note:

- Additional colours on request
- Rated current related to rated cross-section & min. No. of poles.
- Spacing between rows: see hole layout
- P on drawing = pitch
- Rated data refer only to the component itself. Clearance and creepage distances to other components are to be designed in accordance with the relevant application standards.

SLD 5.00/./90G



Dimensioned drawing

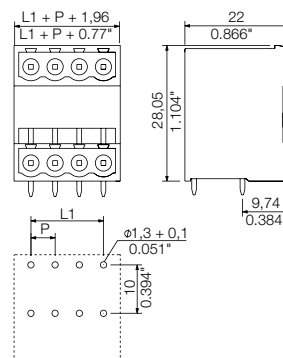

Accessories

Note: Refer to the Accessories chapter for additional accessories.

Coding	Order No.
BLZ/SL KO OR BX	1573010000
BLZ/SL KO BK BX	1545710000
Spacer	
SL AT OR	1598300000
SL AT SW	1770240000

Ordering data

Solder pin length		3.2 mm		
Colour		orange		
Pitch	5.00 mm			
Pol.	L1	(inch)	Qty.	Order No.
4	5.00	0.197	50	1614350000
6	10.00	0.394	50	1614360000
8	15.00	0.591	50	1614370000
10	20.00	0.787	50	1614380000
12	25.00	0.984	50	1614390000
14	30.00	1.181	20	1614400000
16	35.00	1.378	20	1614410000
18	40.00	1.575	20	1614420000
20	45.00	1.772	20	1614430000
22	50.00	1.969	10	1614440000
24	55.00	2.165	10	1614450000

L

5.00

90°

SLD 5.00/./180G

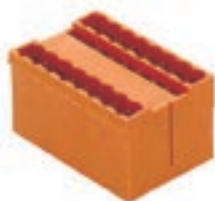

Dimensioned drawing

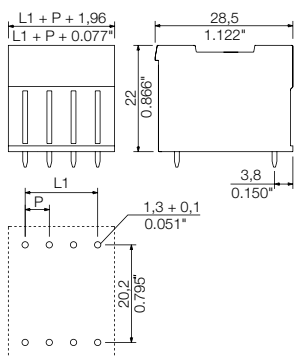

Ordering data

Solder pin length		3.2 mm		
Colour		orange		
Pitch		5.00 mm		
Pol.	L1	(inch)	Qty.	Order No.
4	5.00	0.197	50	1614810000
6	10.00	0.394	50	1614820000
8	15.00	0.591	50	1614830000
10	20.00	0.787	50	1614840000
12	25.00	0.984	50	1614850000
14	30.00	1.181	20	1614860000
16	35.00	1.378	20	1614870000
18	40.00	1.575	20	1614880000
20	45.00	1.772	20	1614890000
22	50.00	1.969	10	1614900000
24	55.00	2.165	10	1614910000



Connectors in 5.00 mm pitch Series BL/SL 5.00

BLZP 5.00HC../180



The BLZP is the functional extension of the BLZ series. The "P" in the part name stands for a plus in security and performance in processing and use.

- WIRE READY - delivered with terminal points already opened
- Power tools can be used with the globally compatible plus/minus screw head
- Folded steel clamping yoke accommodates the connected wire and compensates for temperature fluctuations
- The integrated wire guard prevents dangerous under-insertion of the wire from occurring.
- Lock and release-lever: tool-less locking and gentle releasing of the connector reduces the mechanical stress on the solder joints.

Technical data

In compliance with IEC 60664-1 / IEC 61984			
Clamping range, max.	mm ²	0.13...4	
Solid core H05(07) V-U	mm²	0.2...4	
Stranded H07 V-R			
Flexible H05(07) V-K	mm ²	0.2...4	
Flexible with ferrule	mm ²	0.2...4	
Ferrule with plastic collar	mm ²	0.2...2.5	
Stripping length	mm	7	
Screwdriver blade	mm	0.6 x 3.5, PH 1, PZ 1	
According to norm			
Tightening torque range			
Rated current, max.	A	23	21
At ambient temperature		20°C	40°C
For conductor cross-section	mm ²	4	
Overvoltage category		III	II
Pollution severity		3	2
Rated voltage	V	250	320
Rated impulse voltage	kV	4	4
UL / CUL (Use Group)		B	C
Rated voltage	V	300	300
Rated current	A	20	10
AWG conductor	AWG	26-12	
CSA (Use Group)		B	C
Rated voltage	V	300	300
Rated current	A	20	20
AWG conductor	AWG	30-12	
General data			
Type of insulation material		PBT	
UL 94 flammability rating		V-0	
Contact base material		Copper alloy	
Material of contact surface		tinned	
Pin dimensions = d	mm		
Solder eyelet Ø = D	mm		
Solder eyelet Ø tolerance	mm		

Product data

IEC: 400 V / 23 A / 0.2 - 4 mm²
UL: 300 V / 20 A / AWG 26 - 12



For additional articles and information, refer to catalog.weidmuller.com

Note:

- Additional colours on request
- Gold-plated contact surfaces on request
- Rated current related to rated cross-section & min. No. of poles.
- Wire end ferrule without plastic collar to DIN 46228/1
- Wire end ferrule with plastic collar to DIN 46228/4
- P on drawing = pitch
- Rated data refer only to the component itself. Clearance and creepage distances to other components are to be designed in accordance with the relevant application standards.

BLZP 5.00HC../180



Dimensioned drawing

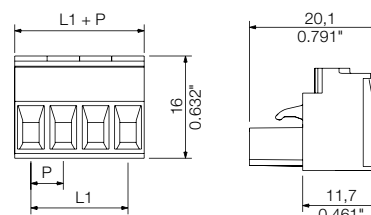

Accessories

Note: Refer to the Accessories chapter for additional accessories.

Strain relief		Order No.
	BLZ 5.00 ZE04 OR BX	1652100000
	BLZ 5.00 ZE08 OR BX	1652040000
	BLZ 5.00 ZE08 BK BX	1652060000
Coding		
	BLZ/SL KO OR BX	1573010000
	BLZ/SL KO BK BX	1545710000
Screwdriver		
	SDS 0.6X3.5X100	2749340000
	SDIS 0.6X3.5X100	2749810000
	SDK PH1 X 80	2749410000
	SDK PZ1 X 80	2749440000

Ordering data

Solder pin length				
Colour	orange			
Pitch	5.00 mm			
Pol.	L1	(inch)	Qty.	Order No.
2	5.00	0.197	180	1954490000
3	10.00	0.394	120	1954480000
4	15.00	0.591	90	1954470000
5	20.00	0.788	72	1954460000
6	25.00	0.985	60	1954450000
7	30.00	1.182	48	1954440000
8	35.00	1.379	42	1954430000
9	40.00	1.576	36	1954420000
10	45.00	1.773	36	1954410000
11	50.00	1.970	30	1954400000
12	55.00	2.167	30	1954390000

Representative deratings curve

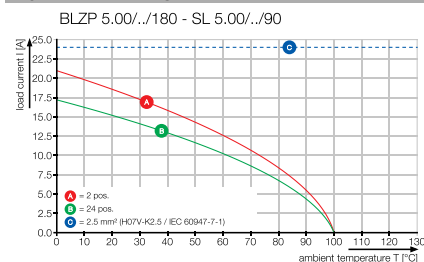

BLZP 5.00HC../180F



Dimensioned drawing

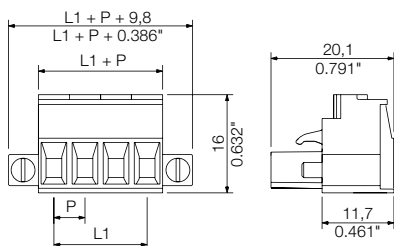

Ordering data

Solder pin length					
Colour					orange
Pitch 5.00 mm					
Pol.	L1	(inch)	Qty.	Order No.	
2	5.00	0.197	90	1955800000	
3	10.00	0.394	72	1955790000	
4	15.00	0.591	60	1955780000	
5	20.00	0.788	48	1955770000	
6	25.00	0.985	42	1955760000	
7	30.00	1.182	36	1955750000	
8	35.00	1.379	36	1955740000	
9	40.00	1.576	30	1955730000	
10	45.00	1.773	30	1955720000	
11	50.00	1.970	24	1955710000	
12	55.00	2.167	24	1955700000	

BLZP 5.00HC../180LR

with lock and release lever



Dimensioned drawing

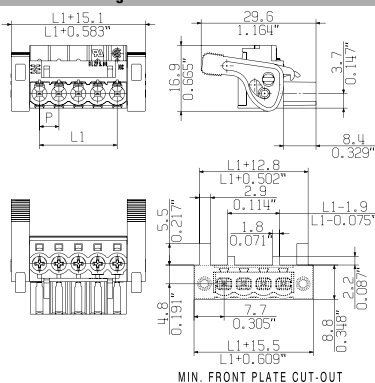

Ordering data

Solder pin length					
Colour					orange
Pitch 5.00 mm					
Pol.	L1	(inch)	Qty.	Order No.	
2	5.00	0.197	90	1956370000	
3	10.00	0.394	72	1956360000	
4	15.00	0.591	60	1956350000	
5	20.00	0.788	48	1956340000	
6	25.00	0.985	42	1956330000	
7	30.00	1.182	36	1956320000	
8	35.00	1.379	36	1956310000	
9	40.00	1.576	30	1956300000	
10	45.00	1.773	30	1956290000	
11	50.00	1.970	24	1956280000	
12	55.00	2.167	24	1956270000	

The 2-in-1 contact

Every pluggable connector covers two contact points and thus must meet two different requirements: First, the wire termination and second, the connection between plug and pin header. Referring to the 5.0x pitch series, Weidmüller offers different wire connection technologies, but one platform contact for the male / female connection since years. This well-designed hybride platform contact ensures a constant quality on a very high level. Hybride means, that we combine metal material featuring different characteristics by welding, in order to devide the contact system into different function zones: Further to the high electric conductance, the current bar is characterized by its hardness, and the tulip contact by its excellent tension properties. The advantage: each function is supported by the most suitable material to reliably and constantly meet the different electrical and mechanical requirements. To put it in a nutshell: Instead of either ... or, it's even both - perfect for the current, and perfect for the force.



Additional deratings curves

BLZP 5.00../180 - SLD 5.00../90G

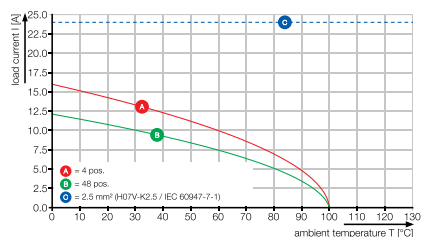

BLZP 5.00../180 - SLDV-THR 5.00../180

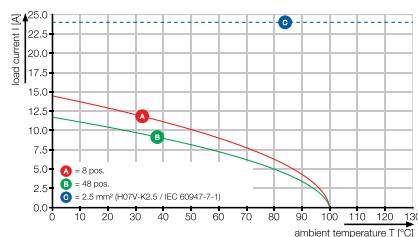

Connectors in 5.00 mm pitch Series BL/SL 5.00

BLZP 5.00HC../90

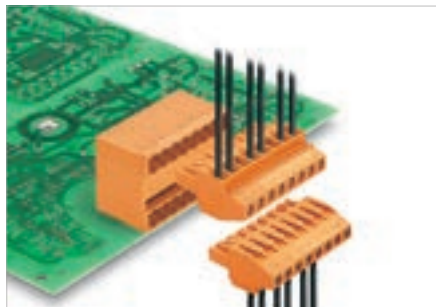

The BLZP is the functional extension of the BLZ series. The "P" in the part name stands for a plus in security and performance in processing and use.

- WIRE READY - delivered with terminal points already opened
- Power tools can be used with the globally compatible plus/minus screw head
- Folded steel clamping yoke accommodates the connected wire and compensates for temperature fluctuations
- The integrated wire guard prevents dangerous under-insertion of the wire from occurring.
- Lock and release-lever: tool-less locking and gentle releasing of the connector reduces the mechanical stress on the solder joints.

Technical data

In compliance with IEC 60664-1 / IEC 61984			
Clamping range, max.	mm ²	0.13...4	
Solid core H05(07) V-U	mm ²	0.2...4	
Stranded H07 V-R			
Flexible H05(07) V-K	mm ²	0.2...4	
Flexible with ferrule	mm ²	0.2...4	
Ferrule with plastic collar	mm ²	0.2...2.5	
Stripping length	mm	7	
Screwdriver blade	mm	0.6 x 3.5, PH 1, PZ 1	
According to norm			
Tightening torque range			
Rated current, max.	A	23	21
At ambient temperature		20°C	40°C
For conductor cross-section	mm ²	4	
Overtoltage category		III	III II
Pollution severity		3	2 2
Rated voltage	V	250	320 400
Rated impulse voltage	kV	4	4 4
UL / CUL (Use Group)		B	C D
Rated voltage	V	300	300
Rated current	A	20	10
AWG conductor	AWG	26-12	
CSA (Use Group)		B	C D
Rated voltage	V	300	50 300
Rated current	A	20	20
AWG conductor	AWG	30-12	
General data			
Type of insulation material		PBT	
UL 94 flammability rating		V-0	
Contact base material		Copper alloy	
Material of contact surface		tinned	
Pin dimensions = d	mm		
Solder eyelet Ø = D			
Solder eyelet Ø tolerance	mm		

Product data

IEC: 400 V / 23 A / 0.2 - 4 mm²
UL: 300 V / 20 A / AWG 26 - 12



For additional articles and information, refer to catalog.weidmueller.com

Note:

- Additional colours on request
- Gold-plated contact surfaces on request
- Rated current related to rated cross-section & min. No. of poles.
- Wire end ferrule without plastic collar to DIN 46228/1
- Wire end ferrule with plastic collar to DIN 46228/4
- P on drawing = pitch
- Rated data refer only to the component itself. Clearance and creepage distances to other components are to be designed in accordance with the relevant application standards.

BLZP 5.00HC../90



Dimensioned drawing

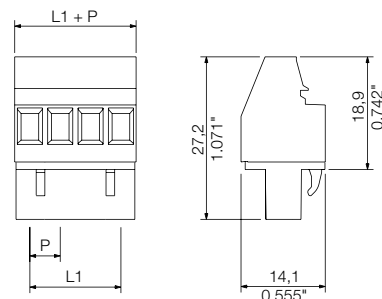

Accessories

Note: Refer to the Accessories chapter for additional accessories.

Coding	Order No.
BLZ/SL KO OR BX	1573010000
BLZ/SL KO BK BX	1545710000
Screwdriver	
SDS 0.6X3.5X100	2749340000
SDIS 0.6X3.5X100	2749810000
SDK PH1 X 80	2749410000
SDK PZ1 X 80	2749440000

Ordering data

Solder pin length				
Colour	orange			
Pitch	5.00 mm			
Pol.	L1	(inch)	Qty.	Order No.
2	5.00	0.197	180	1958300000
3	10.00	0.394	120	1958290000
4	15.00	0.591	90	1958280000
5	20.00	0.788	72	1958270000
6	25.00	0.985	60	1958260000
7	30.00	1.182	48	1958250000
8	35.00	1.379	42	1958230000
9	40.00	1.576	36	1958190000
10	45.00	1.773	36	1958160000
11	50.00	1.970	30	1958130000
12	55.00	2.167	30	1958120000

Representative deratings curve

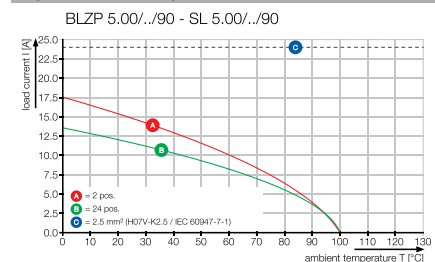

BLZP 5.00HC/./90F



Dimensioned drawing

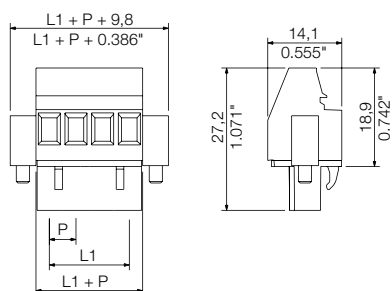

Ordering data

Solder pin length					
Colour					
					orange
Pitch 5.00 mm					
Pol.	L1	(inch)	Qty.	Order No.	
2	5.00	0.197	90	1959520000	
3	10.00	0.394	72	1959510000	
4	15.00	0.591	60	1959500000	
5	20.00	0.788	48	1959490000	
6	25.00	0.985	42	1959480000	
7	30.00	1.182	36	1959470000	
8	35.00	1.379	36	1959460000	
9	40.00	1.576	30	1959440000	
10	45.00	1.773	30	1959430000	
11	50.00	1.970	24	1959390000	
12	55.00	2.167	24	1959370000	

The 2-in-1 contact

Every pluggable connector covers two contact points and thus must meet two different requirements: First, the wire termination and second, the connection between plug and pin header. Referring to the 5.0x pitch series, Weidmüller offers different wire connection technologies, but one platform contact for the male / female connection since years. This well-designed hybrid platform contact ensures a constant quality on a very high level.

Hybride means, that we combine metal material featuring different characteristics by welding, in order to divide the contact system into different function zones: Further to the high electric conductance, the current bar is characterized by its hardness, and the tulip contact by its excellent tension properties. The advantage: each function is supported by the most suitable material to reliably and constantly meet the different electrical and mechanical requirements. To put it in a nutshell: Instead of either ... or, it's even both - perfect for the current, and perfect for the force.



Additional deratings curves

BLZP 5.00/./90 - SL-SMT 5.00/./90

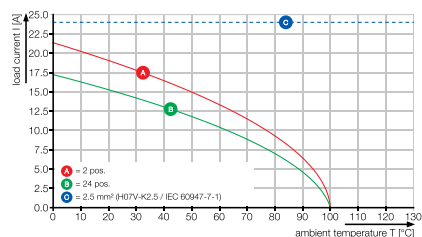

Connectors in 5.00 mm pitch Series BL/SL 5.00

BLZP 5.00HC../270

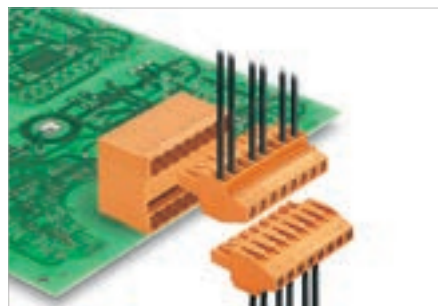

The BLZP is the functional extension of the BLZ series. The "P" in the part name stands for a plus in security and performance in processing and use.

- WIRE READY - delivered with terminal points already opened
- Power tools can be used with the globally compatible plus/minus screw head
- Folded steel clamping yoke accommodates the connected wire and compensates for temperature fluctuations
- The integrated wire guard prevents dangerous under-insertion of the wire from occurring.
- Lock and release-lever: tool-less locking and gentle releasing of the connector reduces the mechanical stress on the solder joints.

Technical data

In compliance with IEC 60664-1 / IEC 61984			
Clamping range, max.	mm ²	0.13...4	
Solid core H05(07) V-U	mm ²	0.2...4	
Stranded H07 V-R			
Flexible H05(07) V-K	mm ²	0.2...4	
Flexible with ferrule	mm ²	0.2...4	
Ferrule with plastic collar	mm ²	0.2...2.5	
Stripping length	mm	7	
Screwdriver blade	mm	0.6 x 3.5, PH 1, PZ 1	
According to norm			
Tightening torque range			
Rated current, max.	A	23	21
At ambient temperature		20°C	40°C
For conductor cross-section	mm ²	4	
Overtoltage category		III	III II
Pollution severity		3	2 2
Rated voltage	V	250	320 400
Rated impulse voltage	kV	4	4 4
UL / CUL (Use Group)		B	C D
Rated voltage	V	300	300
Rated current	A	20	10
AWG conductor	AWG	26-12	
CSA (Use Group)		B	C D
Rated voltage	V	300	50 300
Rated current	A	20	20
AWG conductor	AWG	30-12	
General data			
Type of insulation material		PBT	
UL 94 flammability rating		V-0	
Contact base material		Copper alloy	
Material of contact surface		tinned	
Pin dimensions = d	mm		
Solder eyelet Ø = D	mm		
Solder eyelet Ø tolerance	mm		

Product data

IEC: 400 V / 23 A / 0.2 - 4 mm²
UL: 300 V / 20 A / AWG 26 - 12



For additional articles and information, refer to catalog.weidmueller.com

Note:

- Additional colours on request
- Gold-plated contact surfaces on request
- Rated current related to rated cross-section & min. No. of poles.
- Wire end ferrule without plastic collar to DIN 46228/1
- Wire end ferrule with plastic collar to DIN 46228/4
- P on drawing = pitch
- Rated data refer only to the component itself. Clearance and creepage distances to other components are to be designed in accordance with the relevant application standards.

BLZP 5.00HC../270



Dimensioned drawing

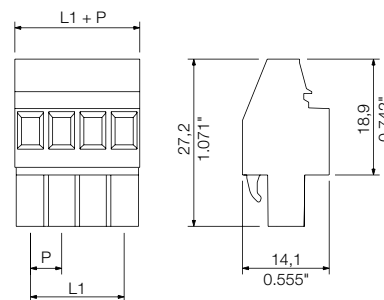

Accessories

Note: Refer to the Accessories chapter for additional accessories.

Coding	Order No.
BLZ/SL KO OR BX	1573010000
BLZ/SL KO BK BX	1545710000
Screwdriver	
SDS 0.6X3.5X100	2749340000
SDIS 0.6X3.5X100	2749810000
SDK PH1 X 80	2749410000
SDK PZ1 X 80	2749440000

Ordering data

Solder pin length				
Colour	orange			
Pitch	5.00 mm			
Pol.	L1	(inch)	Qty.	Order No.
2	5.00	0.197	180	1958870000
3	10.00	0.394	120	1958860000
4	15.00	0.591	90	1958850000
5	20.00	0.788	72	1958840000
6	25.00	0.985	60	1958830000
7	30.00	1.182	48	1958820000
8	35.00	1.379	42	1958810000
9	40.00	1.576	36	1958800000
10	45.00	1.773	36	1958790000
11	50.00	1.970	30	1958780000
12	55.00	2.167	30	1959150000

Representative deratings curve

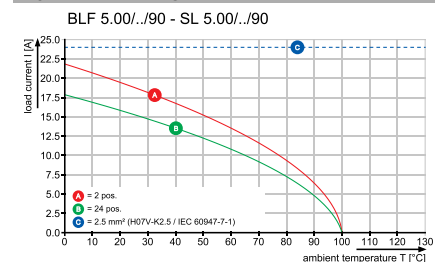

BLZP 5.00HC/./270F



Dimensioned drawing

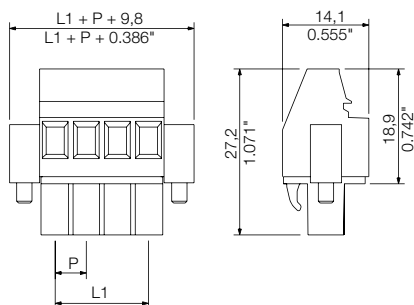

Ordering data

Solder pin length					
Colour					orange
Pitch 5.00 mm					
Pol.	L1	(inch)	Qty.	Order No.	
2	5.00	0.197	90	1960460000	
3	10.00	0.394	72	1960450000	
4	15.00	0.591	60	1960440000	
5	20.00	0.788	48	1960430000	
6	25.00	0.985	42	1960420000	
7	30.00	1.182	36	1960410000	
8	35.00	1.379	36	1960400000	
9	40.00	1.576	30	1960390000	
10	45.00	1.773	30	1960380000	
11	50.00	1.970	24	1960370000	
12	55.00	2.167	24	1959450000	

BLZP 5.00HC/./270LR

with lock and release lever



Dimensioned drawing

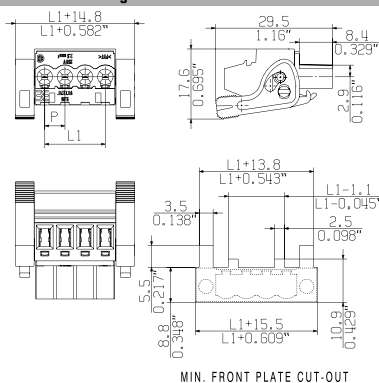

Ordering data

Solder pin length					
Colour					orange
Pitch 5.00 mm					
Pol.	L1	(inch)	Qty.	Order No.	
2	5.00	0.197	90	1960960000	
3	10.00	0.394	72	1960950000	
4	15.00	0.591	60	1960940000	
5	20.00	0.788	48	1960930000	
6	25.00	0.985	42	1960920000	
7	30.00	1.182	36	1960910000	
8	35.00	1.379	36	1960900000	
9	40.00	1.576	30	1960890000	
10	45.00	1.773	30	1960880000	
11	50.00	1.970	24	1960870000	
12	55.00	2.167	24	1960860000	

The 2-in-1 contact

Every pluggable connector covers two contact points and thus must meet two different requirements: First, the wire termination and second, the connection between plug and pin header. Referring to the 5.0x pitch series, Weidmüller offers different wire connection technologies, but one platform contact for the male / female connection since years. This well-designed hybride platform contact ensures a constant quality on a very high level. Hybride means, that we combine metal material featuring different characteristics by welding, in order to devide the contact system into different function zones: Further to the high electric conductance, the current bar is characterized by its hardness, and the tulip contact by its excellent tension properties. The advantage: each function is supported by the most suitable material to reliably and constantly meet the different electrical and mechanical requirements. To put it in a nutshell: Instead of either ... or, it's even both - perfect for the current, and perfect for the force.



Connectors in 5.00 mm pitch Series BL/SL 5.00

BLF 5.00HC../180

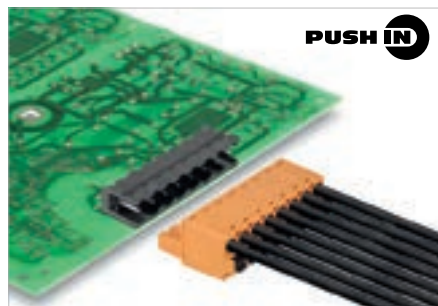

PUSH IN - Weidmüller's innovative connection system simplifies and accelerates the wire connection process.

- Solid wires and stranded wires with ferrules need only to be inserted and they are ready.
- The actuator must be used when connecting stranded wires without ferrules.
- Intuitive handling - since the wire-entry area and handling area are clearly separated.
- User-friendly handling with rounded outer edges and large, no-slip push buttons.
- Lock and release lever: tool-less locking and a gentle releasing of the connector reduces the mechanical stress to the solder joints.

Technical data

In compliance with IEC 60664-1 / IEC 61984			
Clamping range, max.	mm ²	0.13...3.31	
Solid core H05(07) V-U	mm ²	0.2...2.5	
Stranded H07 V-R			
Flexible H05(07) V-K	mm ²	0.2...2.5	
Flexible with ferrule	mm ²	0.25...2.5	
Ferrule with plastic collar		...2.5	
Stripping length	mm	10	
Screwdriver blade	mm	0.6 x 3.5	
		According to norm DIN 5264	
Tightening torque range			
Rated current, max.	A	23	21
At ambient temperature		20°C	40°C
For conductor cross-section	mm ²	2.5	
Overvoltage category		III	III II
Pollution severity		3	2 2
Rated voltage	V	250	320 400
Rated impulse voltage	kV	4	4 4
UL / CUL (Use Group)		B	C D
Rated voltage	V	300	300
Rated current	A	18.5	10
AWG conductor	AWG	26-12	
CSA (Use Group)		B	C D
Rated voltage	V	300	300
Rated current	A	10	10
AWG conductor	AWG	12-26	
General data			
Type of insulation material		PBT	
UL 94 flammability rating		V-0	
Contact base material		CuSn	
Material of contact surface		tinned	
Pin dimensions = d	mm		
Solder eyelet Ø = D	mm		
Solder eyelet Ø tolerance	mm		

Product data

IEC: 400 V / 23 A / 0.2 - 2.5 mm²
UL: 300 V / 18.5 A / AWG 26 - 12



For additional articles and information, refer to catalog.weidmueller.com

Note:

- Additional colours on request
- Gold-plated contact surfaces on request
- Rated current related to rated cross-section & min. No. of poles.
- Wire end ferrule without plastic collar to DIN 46228/1
- Wire end ferrule with plastic collar to DIN 46228/4
- P on drawing = pitch
- Crimping shape "A" for wire end ferrules with PZ 6/5 crimping tool recommended.
- The test point can only be used as potential-pickup point.

BLF 5.00HC../180



Dimensioned drawing

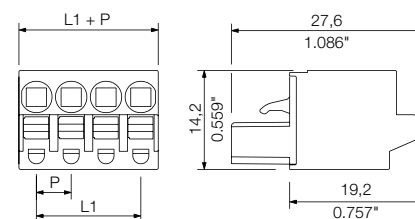

Accessories

Note: Refer to the Accessories chapter for additional accessories.

Coding	Order No.
BLZ/SL KO OR BX	1573010000
BLZ/SL KO BK BX	1545710000
Screwdriver	
SDS 0.6X3.5X100	2749340000
SDIS 0.6X3.5X100	2749810000
Wire-end ferrule	
H0,5/14S W	9004590000
H1,0/14S R	9018560000
H1,5/14DS SW	9025240000
H2,5/14DS BL	1333100000

Ordering data

Solder pin length				
Colour	orange			
Pitch	5.00 mm			
Pol.	L1	(inch)	Qty.	Order No.
2	5.00	0.197	180	1017860000
3	10.00	0.394	120	1017870000
4	15.00	0.591	90	1017880000
5	20.00	0.788	72	1017890000
6	25.00	0.985	60	1017910000
7	30.00	1.182	48	1017920000
8	35.00	1.379	42	1017930000
9	40.00	1.576	36	1017950000
10	45.00	1.773	36	1017960000
11	50.00	1.970	30	1017970000
12	55.00	2.167	30	1017980000

Representative deratings curve

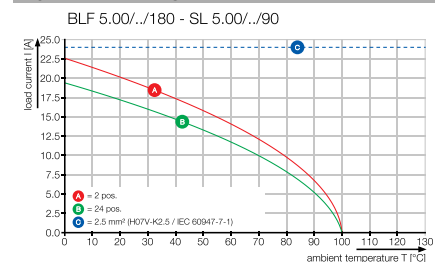

BLF 5.00HC../180F



Dimensioned drawing

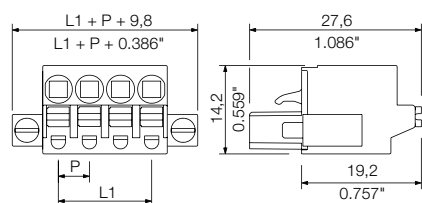

Ordering data

Solder pin length					
Colour					orange
Pitch 5.00 mm					
Pol.	L1	(inch)	Qty.	Order No.	
2	5.00	0.197	90	1017420000	
3	10.00	0.394	72	1017430000	
4	15.00	0.591	60	1017440000	
5	20.00	0.788	48	1017450000	
6	25.00	0.985	42	1017470000	
7	30.00	1.182	36	1017480000	
8	35.00	1.379	36	1017490000	
9	40.00	1.576	30	1017510000	
10	45.00	1.773	30	1017520000	
11	50.00	1.970	24	1017530000	
12	55.00	2.167	24	1017540000	

BLF 5.00HC../180LR



Dimensioned drawing

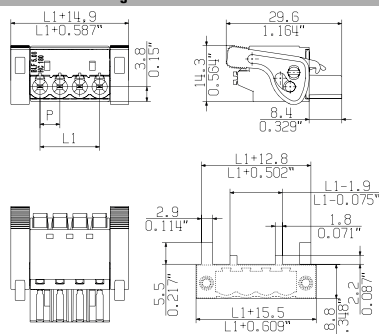

MIN. FRONT PLATE CUT-OUT

Ordering data

Solder pin length					
Colour					orange
Pitch 5.00 mm					
Pol.	L1	(inch)	Qty.	Order No.	
2	5.00	0.197	90	1016340000	
3	10.00	0.394	72	1016350000	
4	15.00	0.591	60	1016360000	
5	20.00	0.788	48	1016370000	
6	25.00	0.985	42	1016380000	
7	30.00	1.182	36	1016390000	
8	35.00	1.379	36	1016410000	
9	40.00	1.576	30	1016420000	
10	45.00	1.773	30	1016430000	
11	50.00	1.970	24	1016440000	
12	55.00	2.167	24	1016450000	

PUSH IN connection technology

PUSH IN connection technology reduces the wiring efforts especially for solid wires and wires with ferrule to a minimum. These connectors are self-explanatory and enable tool-less handling. The contact element made of stainless steel ensures a vibration proof, maintenance free wire termination. The established principle "STEEL FOR THE FORCE, COPPER FOR THE CURRENT" by Weidmüller offers both, maximum conductor clamping forces, as well as minimum power loss at the same time.



The 2-in-1 contact

Every pluggable connector covers two different requirements: First, the wire termination and second, the connection between plug and pin header. Referring to the 5.0x pitch series, Weidmüller offers different wire connection technologies, but one platform contact for the male / female connection since years. This well-designed hybride platform contact ensures a constant quality on a very high level. Hybride means, that we combine metal material featuring different characteristics by welding, in order to divide the contact system into different function zones: Further to the high electric conductance, the current bar is characterized by its hardness, and the tulip contact by its excellent tension properties. The advantage: each function is supported by the most suitable material to reliably and constantly meet the different electrical and mechanical requirements. To put it in a nutshell: Instead of either ... or, it's even both - perfect for the current, and perfect for the force.



Connectors in 5.00 mm pitch Series BL/SL 5.00

BLF 5.00HC/./90

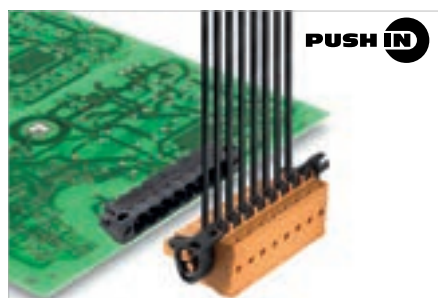

PUSH IN - Weidmüller's innovative connection system simplifies and accelerates the wire connection process.

- Solid wires and stranded wires with ferrules need only to be inserted and they are ready.
- The actuator must be used when connecting stranded wires without ferrules.
- Intuitive handling - since the wire-entry area and handling area are clearly separated.
- User-friendly handling with rounded outer edges and large, no-slip push buttons.
- Lock and release lever: tool-less locking and a gentle releasing of the connector reduces the mechanical stress to the solder joints.

Technical data

In compliance with IEC 60664-1 / IEC 61984			
Clamping range, max.	mm ²	0.13...3.31	
Solid core H05(07) V-U	mm ²	0.2...2.5	
Stranded H07 V-R			
Flexible H05(07) V-K	mm ²	0.2...2.5	
Flexible with ferrule	mm ²	0.25...2.5	
Ferrule with plastic collar	mm ²	0.25...2.5	
Stripping length	mm	10	
Screwdriver blade	mm	0.6 x 3.5	
		According to norm DIN 5264	
Tightening torque range			
Rated current, max.	A	24	21
At ambient temperature		20°C	40°C
For conductor cross-section	mm ²	2.5	
Overvoltage category		III	III II
Pollution severity		3	2 2
Rated voltage	V	250	320 400
Rated impulse voltage	kV	4	4 4
UL / CUL (Use Group)		B	C D
Rated voltage	V	300	300
Rated current	A	18.5	10
AWG conductor	AWG	26-12	
CSA (Use Group)		B	C D
Rated voltage	V	300	300
Rated current	A	10	10
AWG conductor	AWG	12-26	
General data			
Type of insulation material		PBT	
UL 94 flammability rating		V-0	
Contact base material		CuSn	
Material of contact surface		tinned	
Pin dimensions = d	mm		
Solder eyelet Ø = D	mm		
Solder eyelet Ø tolerance	mm		

Product data

IEC: 400 V / 24 A / 0.2 - 2.5 mm²
UL: 300 V / 18.5 A / AWG 26 - 12



For additional articles and information, refer to catalog.weidmueller.com

Note:

- Additional colours on request
- Gold-plated contact surfaces on request
- Rated current related to rated cross-section & min. No. of poles.
- Wire end ferrule without plastic collar to DIN 46228/1
- Wire end ferrule with plastic collar to DIN 46228/4
- P on drawing = pitch
- Crimping shape "A" for wire end ferrules with PZ 6/5 crimping tool recommended.
- The test point can only be used as potential-pickup point.

BLF 5.00HC/./90



Dimensioned drawing

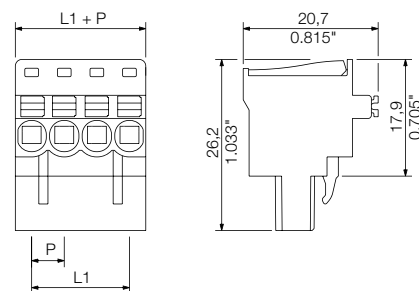

Accessories

Note: Refer to the Accessories chapter for additional accessories.

Coding	Order No.
BLZ/SL KO OR BX	1573010000
BLZ/SL KO BK BX	1545710000
Screwdriver	
SDS 0.6X3.5X100	2749340000
SDIS 0.6X3.5X100	2749810000
Wire-end ferrule	
H0,5/14S W	9004590000
H1,0/14S R	9018560000
H1,5/14DS SW	9025240000
H2,5/14DS BL	1333100000

Ordering data

Solder pin length				
Colour	orange			
Pitch	5.00 mm			
Pol.	L1	(inch)	Qty.	Order No.
2	5.00	0.197	180	1980170000
3	10.00	0.394	120	1980180000
4	15.00	0.591	90	1980190000
5	20.00	0.788	72	1980200000
6	25.00	0.985	60	1980210000
7	30.00	1.182	48	1980220000
8	35.00	1.379	42	1980230000
9	40.00	1.576	36	1980240000
10	45.00	1.773	36	1980250000
11	50.00	1.970	30	1980260000
12	55.00	2.167	30	1980270000

Representative deratings curve

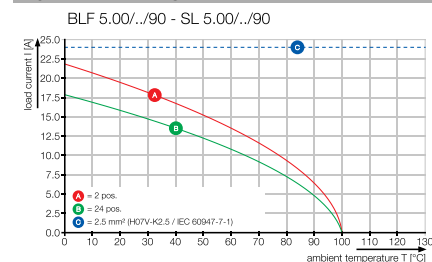

BLF 5.00HC/././90F



Dimensioned drawing

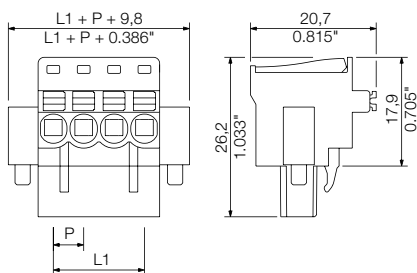

Ordering data

Solder pin length					
Colour					orange
Pitch 5.00 mm					
Pol.	L1	(inch)	Qty.	Order No.	
2	5.00	0.197	90	1980640000	
3	10.00	0.394	72	1980650000	
4	15.00	0.591	60	1980660000	
5	20.00	0.788	48	1980670000	
6	25.00	0.985	42	1980680000	
7	30.00	1.182	36	1980690000	
8	35.00	1.379	36	1980700000	
9	40.00	1.576	30	1980710000	
10	45.00	1.773	30	1980720000	
11	50.00	1.970	24	1980730000	
12	55.00	2.167	24	1980740000	

BLF 5.00HC/././90LR

with lock and release lever



Dimensioned drawing

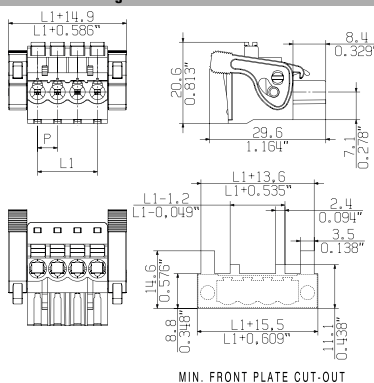

Ordering data

Solder pin length					
Colour					orange
Pitch 5.00 mm					
Pol.	L1	(inch)	Qty.	Order No.	
2	5.00	0.197	90	1980870000	
3	10.00	0.394	72	1980880000	
4	15.00	0.591	60	1980890000	
5	20.00	0.788	48	1980900000	
6	25.00	0.985	42	1980910000	
7	30.00	1.182	36	1980920000	
8	35.00	1.379	36	1980930000	
9	40.00	1.576	30	1980940000	
10	45.00	1.773	30	1980950000	
11	50.00	1.970	24	1980960000	
12	55.00	2.167	24	1980970000	

PUSH IN connection technology

PUSH IN connection technology reduces the wiring efforts especially for solid wires and wires with ferrule to a minimum. These connectors are self-explanatory and enable tool-less handling. The contact element made of stainless steel ensures a vibration proof, maintenance free wire termination. The established principle "STEEL FOR THE FORCE, COPPER FOR THE CURRENT" by Weidmüller offers both, maximum conductor clamping forces, as well as minimum power loss at the same time.



The 2-in-1 contact

Every pluggable connector covers two different requirements: First, the wire termination and second, the connection between plug and pin header. Referring to the 5.0x pitch series, Weidmüller offers different wire connection technologies, but one platform contact for the male / female connection since years. This well-designed hybride platform contact ensures a constant quality on a very high level. Hybride means, that we combine metal material featuring different characteristics by welding, in order to divide the contact system into different function zones: Further to the high electric conductance, the current bar is characterized by its hardness, and the tulip contact by its excellent tension properties. The advantage: each function is supported by the most suitable material to reliably and constantly meet the different electrical and mechanical requirements. To put it in a nutshell: Instead of either ... or, it's even both - perfect for the current, and perfect for the force.



Connectors in 5.08 mm pitch Series BL/SL 5.08

SL-SMT 5.08HC/./90

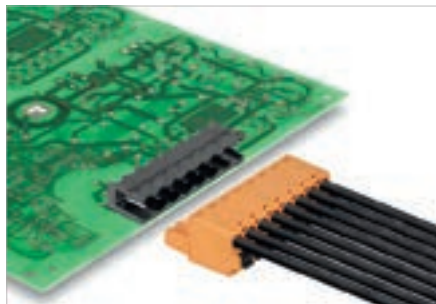

High-temperature-resistant, 90°-angled male header, optimised for SMT processing. The male headers can be manually coded or ordered as pre-coded headers.

- Available in open, closed (G), with screw flange (F) or with solder Flange (LF).
- The solder flange substitutes a screw fastening to the PCB and protects the solder joints against mechanical stress.
- Available with 1.5 mm or 3.2 mm solder pins.
- The short 1.5 mm pins enable a double-sided PCB mounting and reduce the needed amount of solder paste without losing holding force to the PCB.
- Packed either in box (BX) or on anti-static roll (tape-on-reel, RL).

Technical data

In compliance with IEC 60664-1 / IEC 61984

Clamping range, max.			
Solid core H05(07) V-U			
Stranded H07 V-R			
Flexible H05(07) V-K			
Flexible with ferrule			
Ferrule with plastic collar			
Stripping length			
Screwdriver blade	mm		
According to norm			
Tightening torque range			
Rated current, max.	A	27.5	24
At ambient temperature		20°C	40°C
For conductor cross-section			
Overvoltage category		III	III II
Pollution severity		3	2 2
Rated voltage	V	250	320 400
Rated impulse voltage	kV	4	4 4
UL / CUL (Use Group)		B	C D
Rated voltage	V	300	300
Rated current	A	18.5	10
AWG conductor	AWG		-
CSA (Use Group)		B	C D
Rated voltage	V	300	300
Rated current	A	18.5	18.5
AWG conductor	AWG		-
General data			
Type of insulation material		LCP GF	
UL 94 flammability rating		V-0	
Contact base material		CuMg	
Material of contact surface		tinned	
Pin dimensions = d	mm	1.2, Octagonal	
Solder eyelet Ø = D	mm	1.4	
Solder eyelet Ø tolerance	mm	+ 0,1	

Product data

IEC: 400 V / 27.5 A
UL: 300 V / 18.5 A



For additional articles and information, refer to catalog.weidmuller.com

Note:

- Gold-plated contact surfaces on request
- Rated current related to rated cross-section & min. No. of poles.
- Diameter of solder eyelet D = 1.4±0.1mm
- Solder eyelet diameter D = 1.5 + 0.1 mm, from 9 poles
- P on drawing = pitch
- Rated data refer only to the component itself. Clearance and creepage distances to other components are to be designed in accordance with the relevant application standards.

SL-SMT 5.08HC/./90 Box

Packaged in box



Dimensioned drawing

Accessories

Note: Refer to the Accessories chapter for additional accessories.

Coding	Order No.
BLZ/SL KO OR BX	1573010000
BLZ/SL KO BK BX	1545710000
Spacer	
SL AT OR	1598300000
SL AT SW	1770240000
LED light guide	
SL FLA 1.5/1	1580100000
SL FLA 2,3/1	1636670000
SL FLA 2,3/24	1636680000
SL FLA 3,8/1	1580110000
SL FLA 9,0/1	1580120000

Ordering data

Solder pin length		3.2 mm		
Colour		black		
Pitch	5.08 mm			
Pol.	L1	(inch)	Qty.	Order No.
2	5.08	0.200	100	1779950000
3	10.16	0.400	100	1779960000
4	15.24	0.600	100	1779970000
5	20.32	0.800	50	1779980000
6	25.40	1.000	50	1779990000
7	30.48	1.200	50	1780000000
8	35.56	1.400	50	1780010000
9	40.64	1.600	50	1780020000
10	45.72	1.800	50	1780030000
11	50.80	2.000	50	1780040000
12	55.88	2.200	50	1780050000

SL-SMT 5.08HC../90 Tape

Tape-on-reel



Dimensioned drawing

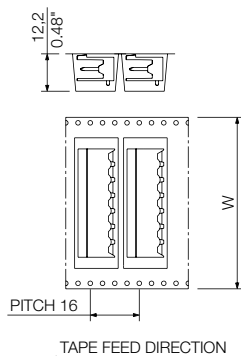

Ordering data

Solder pin length		1.5 mm			
Colour		black			
Pitch		5.08 mm			
Pol.	L1	(inch)	Qty.	Order No.	
2	5.08	0.200	350	1821160000	
3	10.16	0.400	350	1821170000	
4	15.24	0.600	350	1774784001	
5	20.32	0.800	350	1774794001	
6	25.40	1.000	350	1774804001	
7	30.48	1.200	350	1774814001	
8	35.56	1.400	350	1774824001	

Tape widths: 32, 44, 56, 72, 88

SL-SMT 5.08HC../90G Box

Packaged in box



Dimensioned drawing

Ordering data

Solder pin length		3.2 mm			
Colour		black			
Pitch		5.08 mm			
Pol.	L1	(inch)	Qty.	Order No.	
2	5.08	0.200	100	1780180000	
3	10.16	0.400	100	1780190000	
4	15.24	0.600	100	1780200000	
5	20.32	0.800	50	1780210000	
6	25.40	1.000	50	1780220000	
7	30.48	1.200	50	1780230000	
8	35.56	1.400	50	1780240000	
9	40.64	1.600	50	1780250000	
10	45.72	1.800	50	1780260000	
11	50.80	2.000	50	1780270000	
12	55.88	2.200	50	1780280000	

Tape widths: 32, 44, 56, 72, 88

SL-SMT 5.08HC../90G Tape

Tape-on-reel



Dimensioned drawing

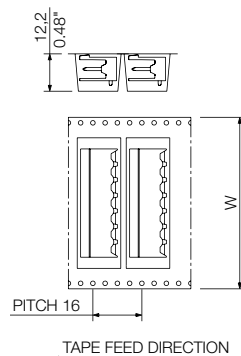

Ordering data

Solder pin length		1.5 mm			
Colour		black			
Pitch		5.08 mm			
Pol.	L1	(inch)	Qty.	Order No.	
2	5.08	0.200	350	1821140000	
3	10.16	0.400	350	1775014001	
4	15.24	0.600	350	1775024001	
5	20.32	0.800	350	1775034001	
6	25.40	1.000	350	1775044001	
7	30.48	1.200	350	1775054001	

Tape widths: 32, 44, 56, 72, 88

Connectors in 5.08 mm pitch Series BL/SL 5.08

SL-SMT 5.08HC../90

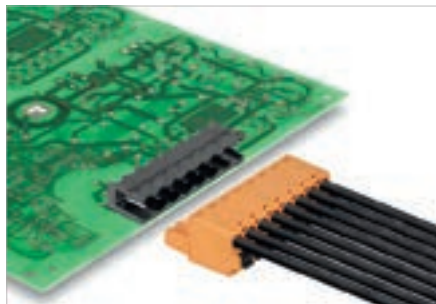

High-temperature-resistant, 90°-angled male header, optimised for SMT processing. The male headers can be manually coded or ordered as pre-coded headers.

- Available in open, closed (G), with screw flange (F) or with solder flange (LF).
- The solder flange substitutes a screw fastening to the PCB and protects the solder joints against mechanical stress.
- Available with 1.5 mm or 3.2 mm solder pins.
- The short 1.5 mm pins enable a double-sided PCB mounting and reduce the needed amount of solder paste without losing holding force to the PCB.
- Packed either in box (BX) or on anti-static roll (tape-on-reel, RL).

Technical data

In compliance with IEC 60664-1 / IEC 61984			
Clamping range, max.			
Solid core H05(07) V-U			
Stranded H07 V-R			
Flexible H05(07) V-K			
Flexible with ferrule			
Ferrule with plastic collar			
Stripping length			
Screwdriver blade	mm		
According to norm			
Tightening torque range			
Rated current, max.	A	27.5	24
At ambient temperature		20°C	40°C
For conductor cross-section			
Overvoltage category		III	III II
Pollution severity		3	2 2
Rated voltage	V	250	320 400
Rated impulse voltage	kV	4	4 4
UL / CUL (Use Group)		B	C D
Rated voltage	V	300	300
Rated current	A	18.5	10
AWG conductor	AWG		
CSA (Use Group)		B	C D
Rated voltage	V	300	300
Rated current	A	18.5	18.5
AWG conductor	AWG		
General data			
Type of insulation material		LCP GF	
UL 94 flammability rating		V-0	
Contact base material		CuMg	
Material of contact surface		tinned	
Pin dimensions = d	mm	1.2, Octagonal	
Solder eyelet Ø = D	mm	1.5	
Solder eyelet Ø tolerance	mm	+ 0,1	

Product data

IEC: 400 V / 27.5 A
UL: 300 V / 18.5 A



For additional articles and information, refer to catalog.weidmueller.com

Note:

- Gold-plated contact surfaces on request
- Rated current related to rated cross-section & min. No. of poles.
- Diameter of solder eyelet $D = 1.4 \pm 0.1$ mm
- Solder eyelet diameter $D = 1.5 \pm 0.1$ mm, from 9 poles
- P on drawing = pitch
- Rated data refer only to the component itself. Clearance and creepage distances to other components are to be designed in accordance with the relevant application standards.

SL-SMT 5.08HC../90F Box

Packaged in box



Dimensioned drawing

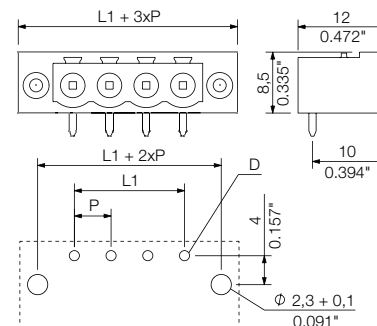

Accessories

Note: Refer to the Accessories chapter for additional accessories.

Coding	Order No.
BLZ/SL KO OR BX	1573010000
BLZ/SL KO BK BX	1545710000
Spacer	
SL AT OR	1598300000
SL AT SW	1770240000
LED light guide	
SL FLA 1.5/1	1580100000
SL FLA 2,3/1	1636670000
SL FLA 2,3/24	1636680000
SL FLA 3,8/1	1580110000
SL FLA 9,0/1	1580120000

Ordering data

Solder pin length		3.2 mm		
Colour		black		
Pitch	5.08 mm			
Pol.	L1	(inch)	Qty.	Order No.
2	5.08	0.200	90	1837630000
3	10.16	0.400	72	1837640000
4	15.24	0.600	60	1837650000
5	20.32	0.800	48	1837660000
6	25.40	1.000	42	1837670000
7	30.48	1.200	36	1837680000
8	35.56	1.400	36	1837690000
9	40.64	1.600	30	1837700000
10	45.72	1.800	30	1837710000
11	50.80	2.000	24	1837720000
12	55.88	2.200	24	1837730000

L

5.08

90°



Connectors in 5.08 mm pitch Series BL/SL 5.08

SL-SMT 5.08HC../90

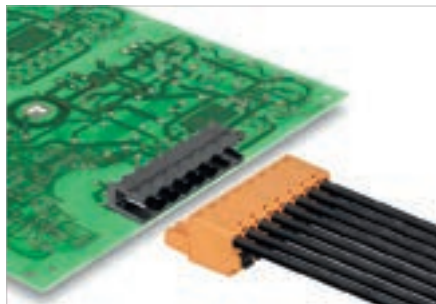

High-temperature-resistant, 90°-angled male header, optimised for SMT processing. The male headers can be manually coded or ordered as pre-coded headers.

- Available in open, closed (G), with screw flange (F) or with solder flange (LF).
- The solder flange substitutes a screw fastening to the PCB and protects the solder joints against mechanical stress.
- Available with 1.5 mm or 3.2 mm solder pins.
- The short 1.5 mm pins enable a double-sided PCB mounting and reduce the needed amount of solder paste without losing holding force to the PCB.
- Packed either in box (BX) or on anti-static roll (tape-on-reel, RL).

Technical data

In compliance with IEC 60664-1 / IEC 61984			
Clamping range, max.			
Solid core H05(07) V-U			
Stranded H07 V-R			
Flexible H05(07) V-K			
Flexible with ferrule			
Ferrule with plastic collar			
Stripping length			
Screwdriver blade	mm		
According to norm			
Tightening torque range			
Rated current, max.	A	27.5	24
At ambient temperature		20°C	40°C
For conductor cross-section			
Overvoltage category		III	III II
Pollution severity		3	2 2
Rated voltage	V	250	320 400
Rated impulse voltage	kV	4	4 4
UL / CUL (Use Group)		B	C D
Rated voltage	V	300	300
Rated current	A	18.5	10
AWG conductor	AWG		
CSA (Use Group)		B	C D
Rated voltage	V	300	300
Rated current	A	18.5	18.5
AWG conductor	AWG		
General data			
Type of insulation material		LCP GF	
UL 94 flammability rating		V-0	
Contact base material		CuMg	
Material of contact surface		tinned	
Pin dimensions = d	mm	1.2, Octagonal	
Solder eyelet Ø = D	mm	1.5	
Solder eyelet Ø tolerance	mm	+ 0,1	

Product data

IEC: 400 V / 27.5 A
UL: 300 V / 18.5 A



For additional articles and information, refer to catalog.weidmuller.com

Note:

- Gold-plated contact surfaces on request
- Rated current related to rated cross-section & min. No. of poles.
- Diameter of solder eyelet $D = 1.4 \pm 0.1$ mm
- Solder eyelet diameter $D = 1.5 \pm 0.1$ mm, from 9 poles
- P on drawing = pitch
- Rated data refer only to the component itself. Clearance and creepage distances to other components are to be designed in accordance with the relevant application standards.

SL-SMT 5.08HC../90LF Box

Packaged in box; with solder flange



Dimensioned drawing

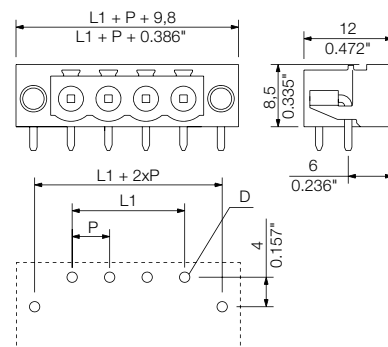

Accessories

Note: Refer to the Accessories chapter for additional accessories.

Coding	Order No.
BLZ/SL KO OR BX	1573010000
BLZ/SL KO BK BX	1545710000
Spacer	
SL AT OR	1598300000
SL AT SW	1770240000
LED light guide	
SL FLA 1.5/1	1580100000
SL FLA 2,3/1	1636670000
SL FLA 2,3/24	1636680000
SL FLA 3,8/1	1580110000
SL FLA 9,0/1	1580120000

Ordering data

Solder pin length		3.2 mm		
Colour		black		
Pitch	5.08 mm			
Pol.	L1	(inch)	Qty.	Order No.
2	5.08	0.200	90	1780410000
3	10.16	0.400	72	1780420000
4	15.24	0.600	60	1780430000
5	20.32	0.800	48	1780440000
6	25.40	1.000	42	1780450000
7	30.48	1.200	36	1780460000
8	35.56	1.400	36	1780470000
9	40.64	1.600	30	1780480000
10	45.72	1.800	30	1780490000
11	50.80	2.000	24	1780500000
12	55.88	2.200	24	1780510000

SL-SMT 5.08HC/./90LF Tape

Tape-on-reel; with solder flange



Dimensioned drawing

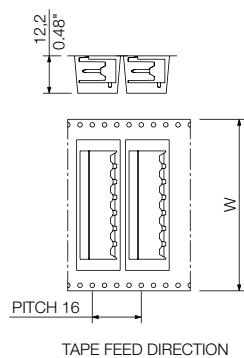

Solder flange (LF)

Normally you use a pin header with fastening flanges (F) in combination with a screw from the rear side of the PCB to increase the fixation forces of the pin headers. The disadvantages are additional process steps that make the PCB mounting complex and cost intensive. The patented solder flange was designed to solve exactly this problem and find a simple and cheap solution. The additional solder pins substitute the present screw flanges and they get soldered together with the pin header. This terminates additional process steps and thus reduces production costs. The additional fixation protects the soldered connections from tensile strain and avoids permanent mechanical stress such as caused by the post-fastened screw forces.



Ordering data

Solder pin length		1.5 mm		
Colour		black		
Pitch		5.08 mm		
Pol.	L1	(inch)	Qty.	Order No.
2	5.08	0.200	350	1775234001
3	10.16	0.400	350	1775244001
4	15.24	0.600	350	1775254001
5	20.32	0.800	350	1775264001
6	25.40	1.000	350	1775274001

Tape widths: 32, 44, 56, 72, 88

Connectors in 5.08 mm pitch Series BL/SL 5.08

SL-SMT 5.08HC../180

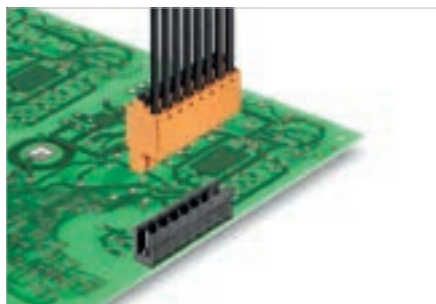

High-temperature-resistant, 180°-angled male header, optimised for SMT processing. The male headers can be manually coded or ordered as pre-coded headers.

- Available in open, closed (G), with screw flange (F) or with solder flange (LF).
- The solder flange substitutes a screw fastening to the PCB and protects the solder joints against mechanical stress.
- Available with 1.5 mm or 3.2 mm solder pins.
- The short 1.5 mm pins enable a double-sided PCB mounting and reduce the needed amount of solder paste without losing holding force to the PCB.
- Packed either in box (BX) or on anti-static roll (tape-on-reel, RL).

Technical data

In compliance with IEC 60664-1 / IEC 61984			
Clamping range, max.			
Solid core H05(07) V-U			
Stranded H07 V-R			
Flexible H05(07) V-K			
Flexible with ferrule			
Ferrule with plastic collar			
Stripping length			
Screwdriver blade	mm		
According to norm			
Tightening torque range			
Rated current, max.	A	27.5	24
At ambient temperature		20°C	40°C
For conductor cross-section			
Overvoltage category		III	III II
Pollution severity		3	2 2
Rated voltage	V	250	320 400
Rated impulse voltage	kV	4	4 4
UL / CUL (Use Group)		B	C D
Rated voltage	V	300	300
Rated current	A	18.5	10
AWG conductor	AWG		-
CSA (Use Group)		B	C D
Rated voltage	V	300	300
Rated current	A		18.5
AWG conductor	AWG		-
General data			
Type of insulation material		LCP GF	
UL 94 flammability rating		V-0	
Contact base material		CuMg	
Material of contact surface		tinned	
Pin dimensions = d	mm	1.2, Octagonal	
Solder eyelet Ø = D	mm	1.4	
Solder eyelet Ø tolerance	mm	+ 0,1	

Product data

IEC: 400 V / 27.5 A
UL: 300 V / 18.5 A



For additional articles and information, refer to catalog.weidmueller.com

Note:

- Gold-plated contact surfaces on request
- Rated current related to rated cross-section & min. No. of poles.
- Diameter of solder eyelet $D = 1.4 \pm 0.1$ mm
- Solder eyelet diameter $D = 1.5 \pm 0.1$ mm, from 9 poles
- P on drawing = pitch
- Rated data refer only to the component itself. Clearance and creepage distances to other components are to be designed in accordance with the relevant application standards.

SL-SMT 5.08HC../180 Box

Packaged in box



Dimensioned drawing

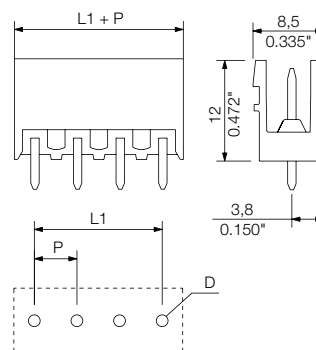

Accessories

Note: Refer to the Accessories chapter for additional accessories.

Coding	Order No.
BLZ/SL KO OR BX	1573010000
BLZ/SL KO BK BX	1545710000
Spacer	
SL AT OR	1598300000
SL AT SW	1770240000

Ordering data

Solder pin length		3.2 mm		
Colour		black		
Pitch	5.08 mm			
Pol.	L1	(inch)	Qty.	Order No.
2	5.08	0.200	100	1837980000
3	10.16	0.400	100	1837990000
4	15.24	0.600	100	1838000000
5	20.32	0.800	50	1838010000
6	25.40	1.000	50	1838020000
7	30.48	1.200	50	1838030000
8	35.56	1.400	50	1838040000
9	40.64	1.600	50	1838050000
10	45.72	1.800	50	1838060000
11	50.80	2.000	50	1838070000
12	55.88	2.200	50	1838080000

SL-SMT 5.08HC../180 Tape

Tape-on-reel



Dimensioned drawing

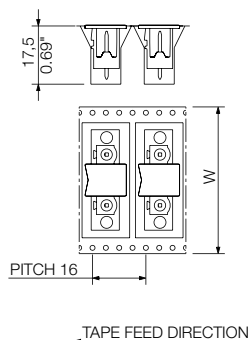

Ordering data

Solder pin length		1.5 mm	
Colour		black	
Pitch		5.08 mm	
Pol.	L1	(inch)	Qty. Order No.
2	5.08	0.200	250 1821100000
3	10.16	0.400	250 1821110000
4	15.24	0.600	250 1775594001
5	20.32	0.800	250 1775634001
6	25.40	1.000	250 1775644001
7	30.48	1.200	250 1775654001
8	35.56	1.400	250 1775664001

Tape widths: 32, 44, 56, 72, 88

SL-SMT 5.08HC../180G Box

Packaged in box



Dimensioned drawing

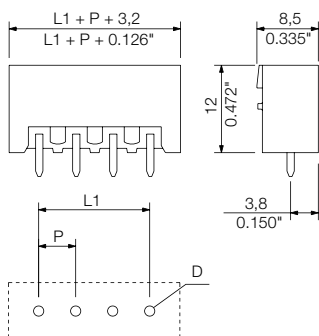

Ordering data

Solder pin length		3.2 mm	
Colour		black	
Pitch		5.08 mm	
Pol.	L1	(inch)	Qty. Order No.
2	5.08	0.200	100 1838210000
3	10.16	0.400	100 1838220000
4	15.24	0.600	100 1838230000
5	20.32	0.800	50 1838240000
6	25.40	1.000	50 1838250000
7	30.48	1.200	50 1838260000
8	35.56	1.400	50 1838270000
9	40.64	1.600	50 1838280000
10	45.72	1.800	50 1838290000
11	50.80	2.000	50 1838300000
12	55.88	2.200	50 1838310000

SL-SMT 5.08HC../180G Tape

Tape-on-reel



Dimensioned drawing

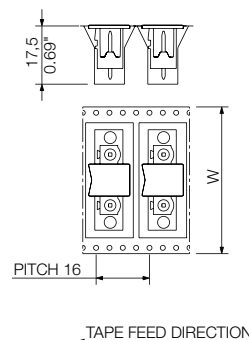

Ordering data

Solder pin length		1.5 mm	
Colour		black	
Pitch		5.08 mm	
Pol.	L1	(inch)	Qty. Order No.
2	5.08	0.200	250 1820170000
3	10.16	0.400	250 1775934001
4	15.24	0.600	250 1775944001
5	20.32	0.800	250 1775954001
6	25.40	1.000	250 1775964001
7	30.48	1.200	250 1775974001

Tape widths: 32, 44, 56, 72, 88

Connectors in 5.08 mm pitch Series BL/SL 5.08

SL-SMT 5.08HC../180

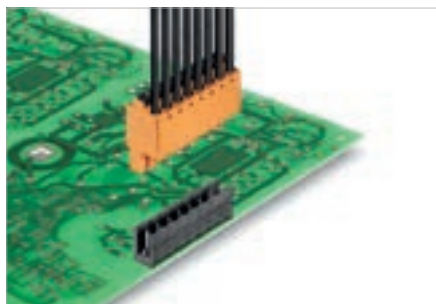

High-temperature-resistant, 180°-angled male header, optimised for SMT processing. The male headers can be manually coded or ordered as pre-coded headers.

- Available in open, closed (G), with screw flange (F) or with solder Flange (LF).
- The solder flange substitutes a screw fastening to the PCB and protects the solder joints against mechanical stress.
- Available with 1.5 mm or 3.2 mm solder pins.
- The short 1.5 mm pins enable a double-sided PCB mounting and reduce the needed amount of solder paste without losing holding force to the PCB.
- Packed either in box (BX) or on anti-static roll (tape-on-reel, RL).

Technical data

In compliance with IEC 60664-1 / IEC 61984			
Clamping range, max.			
Solid core H05(07) V-U			
Stranded H07 V-R			
Flexible H05(07) V-K			
Flexible with ferrule			
Ferrule with plastic collar			
Stripping length			
Screwdriver blade	mm		
According to norm			
Tightening torque range			
Rated current, max.	A	27.5	24
At ambient temperature		20°C	40°C
For conductor cross-section			
Overvoltage category		III	III II
Pollution severity		3	2 2
Rated voltage	V	250	320 400
Rated impulse voltage	kV	4	4 4
UL / CUL (Use Group)		B	C D
Rated voltage	V	300	300
Rated current	A	18.5	10
AWG conductor	AWG		
CSA (Use Group)		B	C D
Rated voltage	V	300	300
Rated current	A		18.5
AWG conductor	AWG		
General data			
Type of insulation material		LCP GF	
UL 94 flammability rating		V-0	
Contact base material		CuMg	
Material of contact surface		tinned	
Pin dimensions = d	mm	1.2, Octagonal	
Solder eyelet Ø = D	mm	1.4	
Solder eyelet Ø tolerance	mm	+ 0,1	

Product data

IEC: 400 V / 27.5 A
UL: 300 V / 18.5 A



For additional articles and information, refer to catalog.weidmuller.com

Note:

- Gold-plated contact surfaces on request
- Rated current related to rated cross-section & min. No. of poles.
- Diameter of solder eyelet $D = 1.4 \pm 0.1$ mm
- Solder eyelet diameter $D = 1.5 \pm 0.1$ mm, from 9 poles
- P on drawing = pitch
- Rated data refer only to the component itself. Clearance and creepage distances to other components are to be designed in accordance with the relevant application standards.

SL-SMT 5.08HC../180F Box

Packaged in box



Dimensioned drawing

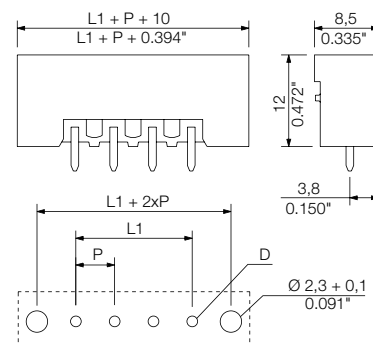

Accessories

Note: Refer to the Accessories chapter for additional accessories.

Coding	Order No.
BLZ/SL KO OR BX	1573010000
BLZ/SL KO BK BX	1545710000
Spacer	
SL AT OR	1598300000
SL AT SW	1770240000

Ordering data

Solder pin length		3.2 mm		
Colour		black		
Pitch		5.08 mm		
Pol.	L1	(inch)	Qty.	Order No.
2	5.08	0.200	90	1837860000
3	10.16	0.400	72	1820600000
4	15.24	0.600	60	1837870000
5	20.32	0.800	48	1820770000
6	25.40	1.000	42	1820610000
7	30.48	1.200	36	1837880000
8	35.56	1.400	36	1820620000
9	40.64	1.600	30	1837890000
10	45.72	1.800	30	1820780000
11	50.80	2.000	24	1837900000
12	55.88	2.200	24	1820630000



Connectors in 5.08 mm pitch Series BL/SL 5.08

SL-SMT 5.08HC../180

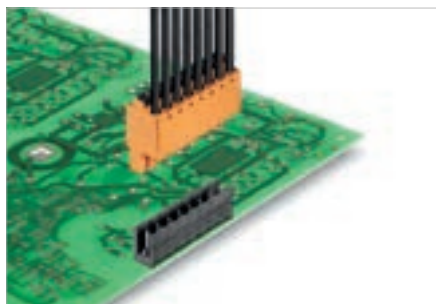

High-temperature-resistant, 180°-angled male header, optimised for SMT processing. The male headers can be manually coded or ordered as pre-coded headers.

- Available in open, closed (G), with screw flange (F) or with solder flange (LF).
- The solder flange substitutes a screw fastening to the PCB and protects the solder joints against mechanical stress.
- Available with 1.5 mm or 3.2 mm solder pins.
- The short 1.5 mm pins enable a double-sided PCB mounting and reduce the needed amount of solder paste without losing holding force to the PCB.
- Packed either in box (BX) or on anti-static roll (tape-on-reel, RL).

Technical data

In compliance with IEC 60664-1 / IEC 61984

Clamping range, max.			
Solid core H05(07) V-U			
Stranded H07 V-R			
Flexible H05(07) V-K			
Flexible with ferrule			
Ferrule with plastic collar			
Stripping length			
Screwdriver blade	mm		
According to norm			
Tightening torque range			
Rated current, max.	A	27.5	24
At ambient temperature		20°C	40°C
For conductor cross-section			
Overvoltage category		III	III II
Pollution severity		3	2 2
Rated voltage	V	250	320 400
Rated impulse voltage	kV	4	4 4
UL / CUL (Use Group)		B	C D
Rated voltage	V	300	300
Rated current	A	18.5	10
AWG conductor	AWG		-
CSA (Use Group)		B	C D
Rated voltage	V	300	300
Rated current	A		18.5
AWG conductor	AWG		-
General data			
Type of insulation material		LCP GF	
UL 94 flammability rating		V-0	
Contact base material		CuMg	
Material of contact surface		tinned	
Pin dimensions = d	mm	1.2, Octagonal	
Solder eyelet Ø = D	mm	1.5	
Solder eyelet Ø tolerance	mm	+ 0,1	

Product data

IEC: 400 V / 27.5 A
UL: 300 V / 18.5 A



For additional articles and information, refer to catalog.weidmueller.com

Note:

- Gold-plated contact surfaces on request
- Rated current related to rated cross-section & min. No. of poles.
- Diameter of solder eyelet $D = 1.4 \pm 0.1$ mm
- Solder eyelet diameter $D = 1.5 \pm 0.1$ mm, from 9 poles
- P on drawing = pitch
- Rated data refer only to the component itself. Clearance and creepage distances to other components are to be designed in accordance with the relevant application standards.

SL-SMT 5.08HC../180LF Box

Packaged in box; with solder flange





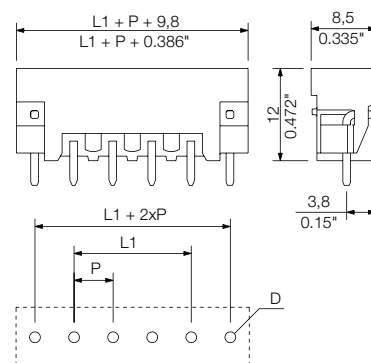

Dimensioned drawing



Accessories

Note: Refer to the Accessories chapter for additional accessories.

Coding	Order No.
 BLZ/SL KO OR BX	1573010000
 BLZ/SL KO BK BX	1545710000
Spacer	
 SL AT OR	1598300000
 SL AT SW	1770240000

Ordering data

Solder pin length		3.2 mm		
Colour		black		
Pitch	5.08 mm			
Pol.	L1	(inch)	Qty.	Order No.
2	5.08	0.200	90	1838440000
3	10.16	0.400	72	1838450000
4	15.24	0.600	60	1838460000
5	20.32	0.800	48	1838470000
6	25.40	1.000	42	1838480000
7	30.48	1.200	36	1838490000
8	35.56	1.400	36	1838500000
9	40.64	1.600	30	1838510000
10	45.72	1.800	30	1838520000
11	50.80	2.000	24	1838530000
12	55.88	2.200	24	1838540000

SL-SMT 5.08HC/./180LF Tape

Packaged in box; with solder flange



Dimensioned drawing

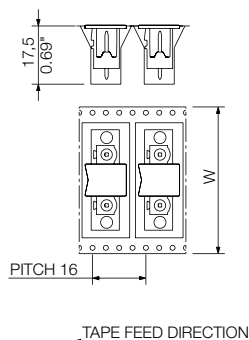

Solder flange (LF)

Normally you use a pin header with fastening flanges (F) in combination with a screw from the rear side of the PCB to increase the fixation forces of the pin headers. The disadvantages are additional process steps that make the PCB mounting complex and cost intensive. The patented solder flange was designed to solve exactly this problem and find a simple and cheap solution. The additional solder pins substitute the present screw flanges and they get soldered together with the pin header. This terminates additional process steps and thus reduces production costs. The additional fixation protects the soldered connections from tensile strain and avoids permanent mechanical stress such as caused by the post-fastened screw forces.



Ordering data

Solder pin length		1.5 mm		
Colour		black		
Pitch		5.08 mm		
Pol.	L1	(inch)	Qty.	Order No.
2	5.08	0.200	250	1776364001
3	10.16	0.400	250	1776374001
4	15.24	0.600	250	1776384001
5	20.32	0.800	250	1776394001
6	25.40	1.000	250	1776404001

Tape widths: 32, 44, 56, 72, 88

Connectors in 5.08 mm pitch Series BL/SL 5.08

SL-SMT 5.08HC../270

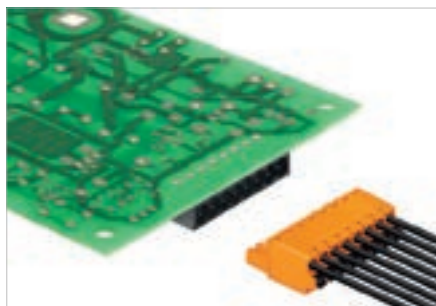

High-temperature-resistant, 270°-angled male connector, optimised for the SMT process. When using the flat-shaped version (L), a circuit board cut-out is required to accommodate the snap-on finger of the counterpart. There is no need for an extra screw connecting the circuit board when the solder flange version is used. This also protects the solder points from mechanical strain. As an option, the 1.5-mm short solder pins allow the PCB to be attached to both sides and minimise the need for solder paste. The male connectors can be manually coded or ordered as pre-coded connectors. Packaged in tape-on-reel or in a cardboard box.

Technical data

In compliance with IEC 60664-1 / IEC 61984

Clamping range, max.			
Solid core H05(07) V-U			
Stranded H07 V-R			
Flexible H05(07) V-K			
Flexible with ferrule			
Ferrule with plastic collar			
Stripping length			
Screwdriver blade	mm		
According to norm			
Tightening torque range			
Rated current, max.	A	27.5	24
At ambient temperature		20°C	40°C
For conductor cross-section			
Overvoltage category		III	III II
Pollution severity		3	2 2
Rated voltage	V	250	320 400
Rated impulse voltage	kV	4	4 4
UL / CUL (Use Group)		B	C D
Rated voltage	V	300	300
Rated current	A	18.5	10
AWG conductor	AWG		
CSA (Use Group)		B	C D
Rated voltage	V	300	300
Rated current	A	18.5	18.5
AWG conductor	AWG		
General data			
Type of insulation material		LCP GF	
UL 94 flammability rating		V-0	
Contact base material		CuMg	
Material of contact surface		tinned	
Pin dimensions = d	mm	1.2, Octagonal	
Solder eyelet Ø = D	mm	1.4	
Solder eyelet Ø tolerance	mm	+ 0,1	

Product data

IEC: 400 V / 27.5 A
UL: 300 V / 18.5 A



For additional articles and information, refer to catalog.weidmueller.com

Note:

- Gold-plated contact surfaces on request
- Rated current related to rated cross-section & min. No. of poles.
- Diameter of solder eyelet $D = 1.4 \pm 0.1$ mm
- Solder eyelet diameter $D = 1.5 \pm 0.1$ mm, from 9 poles
- P on drawing = pitch
- Rated data refer only to the component itself. Clearance and creepage distances to other components are to be designed in accordance with the relevant application standards.

SL-SMT 5.08HC../270GL Box

Packaged in box



Dimensioned drawing

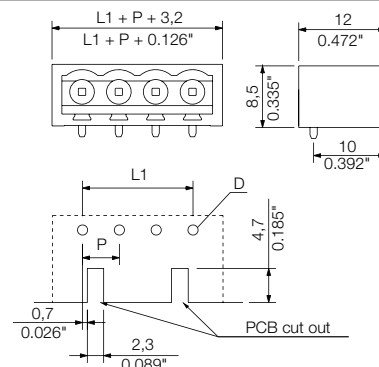

Accessories

Note: Refer to the Accessories chapter for additional accessories.

Coding	Order No.
BLZ/SL KO OR BX	1573010000
BLZ/SL KO BK BX	1545710000
Spacer	
SL AT OR	1598300000
SL AT SW	1770240000

Ordering data

Solder pin length		3.2 mm		
Colour		black		
Pitch	5.08 mm			
Pol.	L1	(inch)	Qty.	Order No.
2	5.08	0.200	100	1877470000
3	10.16	0.400	100	1877490000
4	15.24	0.600	100	1877510000
5	20.32	0.800	50	1877520000
6	25.40	1.000	50	1877530000
7	30.48	1.200	50	1877540000
8	35.56	1.400	50	1877550000

SL-SMT 5.08HC/./270GL Tape

Tape-on-reel



Dimensioned drawing

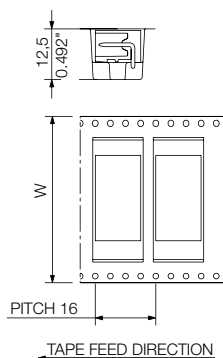

Ordering data

Solder pin length		1.5 mm			
Colour		black			
Pitch		5.08 mm			
Pol.	L1	(inch)	Qty.	Order No.	
2	5.08	0.200	350	1877740000	
3	10.16	0.400	350	1877750000	
4	15.24	0.600	350	1877760000	
5	20.32	0.800	350	1877770000	
6	25.40	1.000	350	1877780000	
7	30.48	1.200	350	1877790000	
8	35.56	1.400	350	1877800000	

Tape widths: 32, 44, 56, 72, 88

SL-SMT 5.08HC/./270GH Box

Packaged in box



Dimensioned drawing

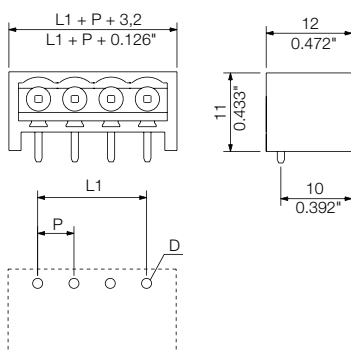

Ordering data

Solder pin length		3.2 mm			
Colour		black			
Pitch		5.08 mm			
Pol.	L1	(inch)	Qty.	Order No.	
2	5.08	0.200	100	1877370000	
3	10.16	0.400	100	1877380000	
4	15.24	0.600	100	1877390000	
5	20.32	0.800	50	1877400000	
6	25.40	1.000	50	1877410000	
7	30.48	1.200	50	1877420000	
8	35.56	1.400	50	1877450000	

SL-SMT 5.08HC/./270GH Tape

Tape-on-reel



Dimensioned drawing

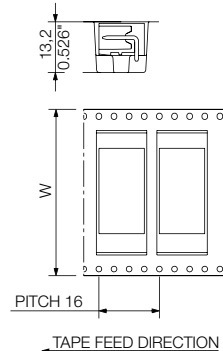

Ordering data

Solder pin length		1.5 mm			
Colour		black			
Pitch		5.08 mm			
Pol.	L1	(inch)	Qty.	Order No.	
2	5.08	0.200	335	1877560000	
3	10.16	0.400	335	1877600000	
4	15.24	0.600	335	1877610000	
5	20.32	0.800	225	1877620000	
6	25.40	1.000	265	1877630000	
7	30.48	1.200	335	1877640000	
8	35.56	1.400	285	1877650000	

Tape widths: 32, 44, 56, 72, 88



Connectors in 5.08 mm pitch Series BL/SL 5.08

SL-SMT 5.08HC../270

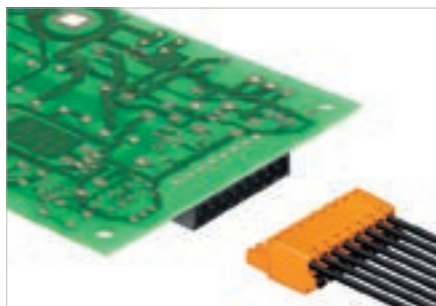

High-temperature-resistant, 270°-angled male connector, optimised for the SMT process. When using the flat-shaped version (L), a circuit board cut-out is required to accommodate the snap-on finger of the counterpart. There is no need for an extra screw connecting the circuit board when the solder flange version is used. This also protects the solder points from mechanical strain. As an option, the 1.5-mm short solder pins allow the PCB to be attached to both sides and minimise the need for solder paste. The male connectors can be manually coded or ordered as pre-coded connectors. Packaged in tape-on-reel or in a cardboard box.

Technical data

In compliance with IEC 60664-1 / IEC 61984

Clamping range, max.			
Solid core H05(07) V-U			
Stranded H07 V-R			
Flexible H05(07) V-K			
Flexible with ferrule			
Ferrule with plastic collar			
Stripping length			
Screwdriver blade	mm		
According to norm			
Tightening torque range			
Rated current, max.	A	27.5	24
At ambient temperature		20°C	40°C
For conductor cross-section			
Overvoltage category		III	III II
Pollution severity		3	2 2
Rated voltage	V	250	320 400
Rated impulse voltage	kV	4	4 4
UL / CUL (Use Group)		B	C D
Rated voltage	V	300	300
Rated current	A	18.5	10
AWG conductor	AWG		
CSA (Use Group)		B	C D
Rated voltage	V	300	300
Rated current	A	18.5	18.5
AWG conductor	AWG		
General data			
Type of insulation material		LCP GF	
UL 94 flammability rating		V-0	
Contact base material		CuMg	
Material of contact surface		tinned	
Pin dimensions = d	mm	1.2, Octagonal	
Solder eyelet Ø = D	mm	1.4	
Solder eyelet Ø tolerance	mm	+ 0,1	

Product data

IEC: 400 V / 27.5 A
UL: 300 V / 18.5 A



For additional articles and information, refer to catalog.weidmueller.com

Note:

- Gold-plated contact surfaces on request
- Rated current related to rated cross-section & min. No. of poles.
- Diameter of solder eyelet $D = 1.4 \pm 0.1$ mm
- Solder eyelet diameter $D = 1.5 \pm 0.1$ mm, from 9 poles
- P on drawing = pitch
- Rated data refer only to the component itself. Clearance and creepage distances to other components are to be designed in accordance with the relevant application standards.

SL-SMT 5.08HC../270FL Box

Packaged in box; with solder flange



Dimensioned drawing

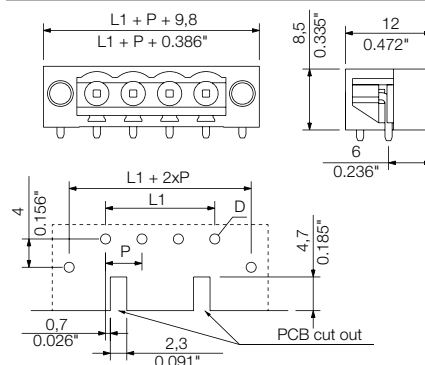

Accessories

Note: Refer to the Accessories chapter for additional accessories.

Coding	Order No.
BLZ/SL KO OR BX	1573010000
BLZ/SL KO BK BX	1545710000
Spacer	
SL AT OR	1598300000
SL AT SW	1770240000

Ordering data

Solder pin length		3.2 mm		
Colour		black		
Pitch		5.08 mm		
Pol.	L1	(inch)	Qty.	Order No.
2	5.08	0.200	100	1876850000
3	10.16	0.400	100	1876860000
4	15.24	0.600	100	1876870000
5	20.32	0.800	50	1876880000
6	25.40	1.000	50	1876890000
7	30.48	1.200	50	1876900000
8	35.56	1.400	50	1876910000

SL-SMT 5.08HC/./270FL Tape

Tape-on-reel; with solder flange



Dimensioned drawing

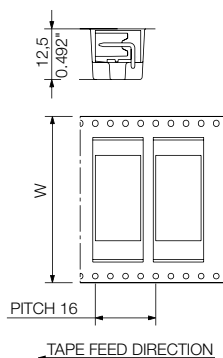

Ordering data

Solder pin length		1.5 mm			
Colour		black			
Pitch		5.08 mm			
Pol.	L1	(inch)	Qty.	Order No.	
2	5.08	0.200	350	1876990000	
3	10.16	0.400	350	1877000000	
4	15.24	0.600	350	1877020000	
5	20.32	0.800	350	1877070000	
6	25.40	1.000	350	1877090000	
7	30.48	1.200	300	1877110000	
8	35.56	1.400	300	1877120000	

Tape widths: 32, 44, 56, 72, 88

SL-SMT 5.08HC/./270FH Box

Packaged in box; with solder flange



Dimensioned drawing

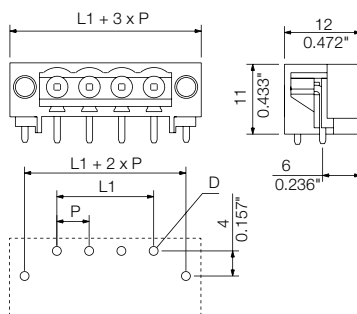

Ordering data

Solder pin length		3.2 mm			
Colour		black			
Pitch		5.08 mm			
Pol.	L1	(inch)	Qty.	Order No.	
2	5.08	0.200	100	1877190000	
3	10.16	0.400	100	1877210000	
4	15.24	0.600	100	1877330000	
5	20.32	0.800	50	1877430000	
6	25.40	1.000	50	1877460000	
7	30.48	1.200	50	1877480000	
8	35.56	1.400	50	1877500000	

Tape widths: 32, 44, 56, 72, 88

SL-SMT 5.08HC/./270FH Tape

Tape-on-reel; with solder flange



Dimensioned drawing

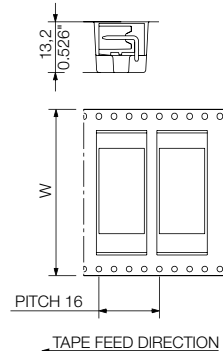

Ordering data

Solder pin length		1.5 mm			
Colour		black			
Pitch		5.08 mm			
Pol.	L1	(inch)	Qty.	Order No.	
2	5.08	0.200	335	1876920000	
3	10.16	0.400	225	1876930000	
4	15.24	0.600	225	1876940000	
5	20.32	0.800	335	1876950000	
6	25.40	1.000	225	1876960000	
7	30.48	1.200	195	1876970000	
8	35.56	1.400	195	1876980000	

Tape widths: 32, 44, 56, 72, 88



Connectors in 5.08 mm pitch Series BL/SL 5.08

SLDV-THR 5.08/./180

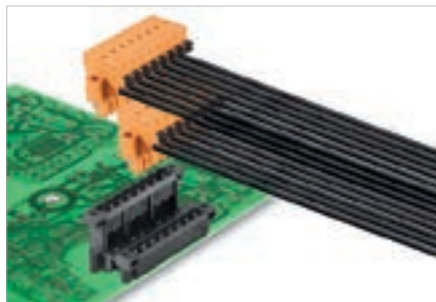

Double-level, high-temperature-resistant male header, optimised for SMT processing. The connection levels are offset and designed for a female plug with screw connection or PUSH IN wire connect. The male headers can be manually coded or ordered as pre-coded headers.

- Available with screw flange (F) or screw & solder flange (FLF).
- The solder flange makes an additional screw-fixation to the PCB unnecessary and protects the solder joints against mechanical stress.
- Available with 1.5 mm or 3.2 mm solder pins.
- The FLF version is featured with a soldering flange and an additional screw-fastening possibility to the PCB.

Technical data

In compliance with IEC 60664-1 / IEC 61984

Clamping range, max.			
Solid core H05(07) V-U			
Stranded H07 V-R			
Flexible H05(07) V-K			
Flexible with ferrule			
Ferrule with plastic collar			
Stripping length			
Screwdriver blade	mm		
According to norm			
Tightening torque range			
Rated current, max.	A	15	13
At ambient temperature		20°C	40°C
For conductor cross-section			
Overvoltage category		III	III II
Pollution severity		3	2 2
Rated voltage	V	250	320 400
Rated impulse voltage	kV	4	4 4
UL / CUL (Use Group)	B C D		
Rated voltage	V	300	300
Rated current	A	10	10
AWG conductor	AWG	-	
CSA (Use Group)	B C D		
Rated voltage	V	300	300
Rated current	A	10	10
AWG conductor	AWG	-	
General data			
Type of insulation material	LCP GF		
UL 94 flammability rating	V-0		
Contact base material	CuSn		
Material of contact surface	tinned		
Pin dimensions = d	mm	1.2, Octagonal	
Solder eyelet Ø = D	mm	1.4	
Solder eyelet Ø tolerance	mm	+ 0,1	

Product data

IEC: 400 V / 15 A
UL: 300 V / 10 A



For additional articles and information, refer to catalog.weidmuller.com

Note:

- Rated current related to rated cross-section & min. No. of poles.
- Spacing between rows: see hole layout
- P on drawing = pitch
- Rated data refer only to the component itself. Clearance and creepage distances to other components are to be designed in accordance with the relevant application standards.

SLDV-THR 5.08/./180F

Packaged in box



Dimensioned drawing

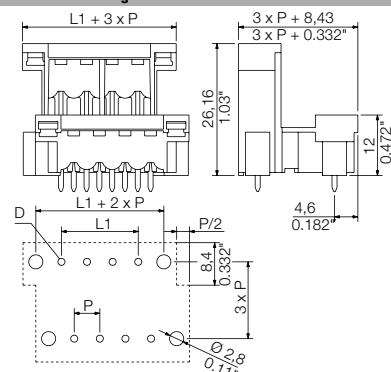

Accessories

Note: Refer to the Accessories chapter for additional accessories.

Coding	Order No.
BLZ/SL KO OR BX	1573010000
BLZ/SL KO BK BX	1545710000
Spacer	
SL AT OR	1598300000
SL AT SW	1770240000

Ordering data

Solder pin length		3.2 mm		
Colour		black		
Pitch	5.08 mm			
Pol.	L1	(inch)	Qty.	Order No.
4	5.08	0.200	50	1828770000
6	10.16	0.400	50	1828780000
8	15.24	0.600	50	1828790000
10	20.32	0.800	50	1828800000
12	25.40	1.000	50	1828810000
14	30.48	1.200	20	1828820000
16	35.56	1.400	20	1828830000
18	40.64	1.600	20	1828840000
20	45.72	1.800	20	1828850000
22	50.80	2.000	10	1828860000
24	55.88	2.200	10	1828870000

SLDV-THR 5.08/./180FLF

Packaged in box; with solder flange



Dimensioned drawing

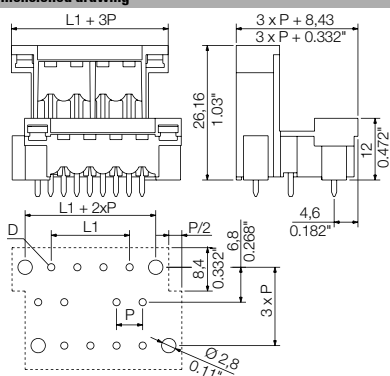

Ordering data

Solder pin length		3.2 mm		
Colour		black		
Pitch		5.08 mm		
Pol.	L1	(inch)	Qty.	Order No.
4	5.08	0.200	50	1829010000
6	10.16	0.400	50	1829020000
8	15.24	0.600	50	1829030000
10	20.32	0.800	50	1829040000
12	25.40	1.000	50	1829050000
14	30.48	1.200	20	1829060000
16	35.56	1.400	20	1829070000
18	40.64	1.600	20	1829080000
20	45.72	1.800	20	1829090000
22	50.80	2.000	10	1829100000
24	55.88	2.200	10	1829110000

Connectors in 5.08 mm pitch Series BL/SL 5.08

SL 5.08HC/./90



Male headers made from glass-fibre-reinforced plastic with 90° wire outlet; optimised for wave soldering, absolut dimension stable. The male headers can be manually coded or ordered as pre-coded headers.

- Available in open, closed (G), with screw flange (F) or with solder Flange (LF).
- The solder flange makes an additional screw-fixation to the PCB unnecessary and protects the solder joints against mechanical stress.

Technical data

In compliance with IEC 60664-1 / IEC 61984			
Clamping range, max.			
Solid core H05(07) V-U			
Stranded H07 V-R			
Flexible H05(07) V-K			
Flexible with ferrule			
Ferrule with plastic collar			
Stripping length			
Screwdriver blade	mm		
According to norm			
Tightening torque range			
Rated current, max.	A	24	21
At ambient temperature		20°C	40°C
For conductor cross-section			
Overvoltage category		III	III II
Pollution severity		3	2 2
Rated voltage	V	250	320 400
Rated impulse voltage	kV	4	4 4
UL / CUL (Use Group)		B	C D
Rated voltage	V	300	300
Rated current	A	18.5	10
AWG conductor	AWG		-
CSA (Use Group)		B	C D
Rated voltage	V	300	300
Rated current	A	18.5	10
AWG conductor	AWG		-
General data			
Type of insulation material		PA GF	
UL 94 flammability rating		V-0	
Contact base material		CuMg	
Material of contact surface		tinned	
Pin dimensions = d	mm	1.2, Octagonal	
Solder eyelet Ø = D	mm	1.3	
Solder eyelet Ø tolerance	mm	+ 0,1	

Product data

IEC: 400 V / 24 A
UL: 300 V / 18.5 A



For additional articles and information, refer to catalog.weidmuller.com

Note:

- Additional colours on request
- Gold-plated contact surfaces on request
- Rated current related to rated cross-section & min. No. of poles.
- P on drawing = pitch
- Rated data refer only to the component itself. Clearance and creepage distances to other components are to be designed in accordance with the relevant application standards.

SL 5.08HC/./90



Dimensioned drawing

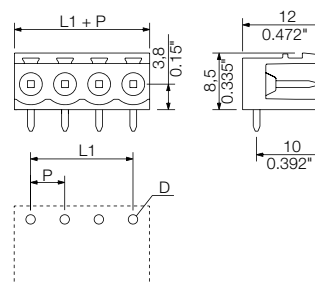

Accessories

Note: Refer to the Accessories chapter for additional accessories.

Coding	Order No.
BLZ/SL KO OR BX	1573010000
BLZ/SL KO BK BX	1545710000
Spacer	
SL AT OR	1598300000
SL AT SW	1770240000
LED light guide	
SL FLA 1.5/1	1580100000
SL FLA 2,3/1	1636670000
SL FLA 2,3/24	1636680000
SL FLA 3.8/1	1580110000
SL FLA 9.0/1	1580120000
Mounting block	
SLA BB11R OR	1604120000
SLA BB11R SW	1692340000

Ordering data

Solder pin length		3.2 mm		
Colour		orange		
Pitch	5.08 mm			
Pol.	L1	(inch)	Qty.	Order No.
2	5.08	0.200	100	1146720000
3	10.16	0.400	100	1146740000
4	15.24	0.600	100	1146770000
5	20.32	0.800	50	1146790000
6	25.40	1.000	50	1146810000
7	30.48	1.200	50	1146830000
8	35.56	1.400	50	1146850000
9	40.64	1.600	50	1146880000
10	45.72	1.800	50	1146900000
11	50.80	2.000	50	1146920000
12	55.88	2.200	50	1146940000

L

5.08

90°

SL 5.08HC../90G



Dimensioned drawing

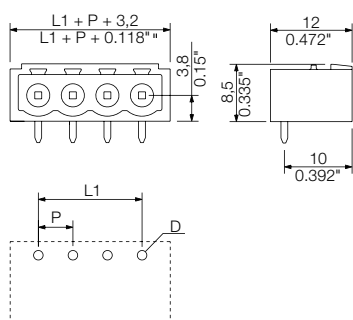

Ordering data

Solder pin length		3.2 mm			
Colour		orange			
Pitch		5.08 mm			
Pol.	L1	(inch)	Qty.	Order No.	
2	5.08	0.200	100	1147280000	
3	10.16	0.400	100	1147310000	
4	15.24	0.600	100	1147340000	
5	20.32	0.800	50	1147370000	
6	25.40	1.000	50	1147400000	
7	30.48	1.200	50	1147420000	
8	35.56	1.400	50	1147450000	
9	40.64	1.600	50	1147490000	
10	45.72	1.800	50	1147530000	
11	50.80	2.000	50	1147570000	
12	55.88	2.200	50	1147600000	

SL 5.08HC../90B



Dimensioned drawing

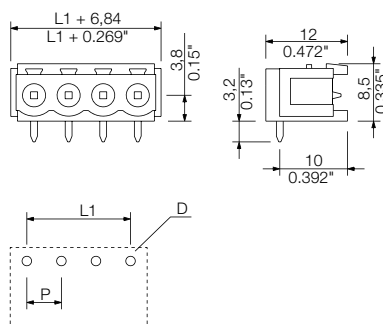

Ordering data

Solder pin length		3.2 mm			
Colour		orange			
Pitch		5.08 mm			
Pol.	L1	(inch)	Qty.	Order No.	
2	5.08	0.200	100	1148030000	
3	10.16	0.400	100	1148070000	
4	15.24	0.600	100	1148100000	
5	20.32	0.800	50	1148130000	
6	25.40	1.000	50	1148170000	
7	30.48	1.200	50	1148200000	
8	35.56	1.400	50	1154830000	
9	40.64	1.600	50	1154840000	
10	45.72	1.800	50	1154850000	
11	50.80	2.000	50	1154870000	
12	55.88	2.200	50	1154880000	

Connectors in 5.08 mm pitch Series BL/SL 5.08

SL 5.08HC/./90



Male headers made from glass-fibre-reinforced plastic with 90° wire outlet; optimised for wave soldering, absolut dimension stable. The male headers can be manually coded or ordered as pre-coded headers.

- Available in open, closed (G), with screw flange (F) or with solder Flange (LF).
- The solder flange makes an additional screw-fixation to the PCB unnecessary and protects the solder joints against mechanical stress.

Technical data

In compliance with IEC 60664-1 / IEC 61984

Clamping range, max.			
Solid core H05(07) V-U			
Stranded H07 V-R			
Flexible H05(07) V-K			
Flexible with ferrule			
Ferrule with plastic collar			
Stripping length			
Screwdriver blade	mm		
According to norm			
Tightening torque range			
Rated current, max.	A	24	21
At ambient temperature		20°C	40°C
For conductor cross-section			
Overvoltage category		III	III II
Pollution severity		3	2 2
Rated voltage	V	250	320 400
Rated impulse voltage	kV	4	4 4
UL / CUL (Use Group)	B C D		
Rated voltage	V	300	300
Rated current	A	18.5	10
AWG conductor	AWG	-	
CSA (Use Group)	B C D		
Rated voltage	V	300	300
Rated current	A	18.5	10
AWG conductor	AWG	-	
General data			
Type of insulation material		PA GF	
UL 94 flammability rating		V-0	
Contact base material		CuMg	
Material of contact surface		tinned	
Pin dimensions = d	mm	1.2, Octagonal	
Solder eyelet Ø = D	mm	1.3	
Solder eyelet Ø tolerance	mm	+ 0,1	

Product data

IEC: 400 V / 24 A
UL: 300 V / 18.5 A



For additional articles and information, refer to catalog.weidmueller.com

Note:

- Additional colours on request
- Gold-plated contact surfaces on request
- Rated current related to rated cross-section & min. No. of poles.
- P on drawing = pitch
- Rated data refer only to the component itself. Clearance and creepage distances to other components are to be designed in accordance with the relevant application standards.

SL 5.08HC/./90F



Dimensioned drawing

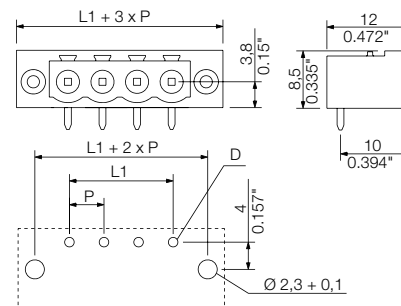

Accessories

Note: Refer to the Accessories chapter for additional accessories.

Coding	Order No.
BLZ/SL KO OR BX	1573010000
BLZ/SL KO BK BX	1545710000
Spacer	
SL AT OR	1598300000
SL AT SW	1770240000
LED light guide	
SL FLA 1.5/1	1580100000
SL FLA 2,3/1	1636670000
SL FLA 2,3/24	1636680000
SL FLA 3,8/1	1580110000
SL FLA 9,0/1	1580120000

Ordering data

Solder pin length		3.2 mm		
Colour		orange		
Pitch	5.08 mm			
Pol.	L1	(inch)	Qty.	Order No.
2	5.08	0.200	90	1148610000
3	10.16	0.400	72	1148640000
4	15.24	0.600	60	1148680000
5	20.32	0.800	48	1148710000
6	25.40	1.000	42	1148740000
7	30.48	1.200	36	1148780000
8	35.56	1.400	36	1148810000
9	40.64	1.600	30	1148840000
10	45.72	1.800	30	1148880000
11	50.80	2.000	24	1148910000
12	55.88	2.200	24	1148940000

SL 5.08HC/./90LF

with solder flange



Dimensioned drawing

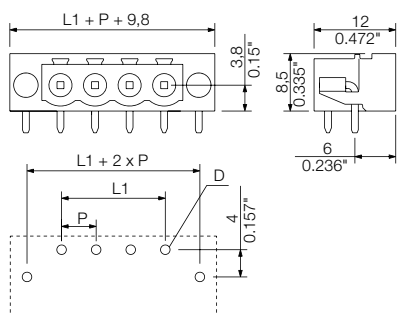

Solder flange (LF)

Normally you use a pin header with fastening flanges (F) in combination with a screw from the rear side of the PCB to increase the fixation forces of the pin headers. The disadvantages are additional process steps that make the PCB mounting complex and cost intensive. The patented solder flange was designed to solve exactly this problem and find a simple and cheap solution. The additional solder pins substitute the present screw flanges and they get soldered together with the pin header. This terminates additional process steps and thus reduces production costs. The additional fixation protects the soldered connections from tensile strain and avoids permanent mechanical stress such as caused by the post-fastened screw forces.



Ordering data

Solder pin length		3.2 mm		
Colour		orange		
Pitch		5.08 mm		
Pol.	L1	(inch)	Qty.	Order No.
2	5.08	0.200	90	1149380000
3	10.16	0.400	72	1149410000
4	15.24	0.600	60	1149440000
5	20.32	0.800	48	1149480000
6	25.40	1.000	42	1149510000
7	30.48	1.200	36	1149540000
8	35.56	1.400	36	1149580000
9	40.64	1.600	30	1149610000
10	45.72	1.800	30	1149640000
11	50.80	2.000	24	1149680000
12	55.88	2.200	24	1149710000

Connectors in 5.08 mm pitch Series BL/SL 5.08

SL 5.08HC/./180

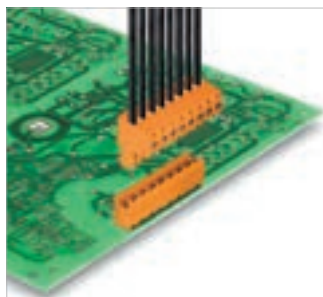

Male headers made from glass-fibre-reinforced plastic with 180° wire outlet; optimised for wave soldering, absolut dimension stable. The male headers can be manually coded or ordered as pre-coded headers.

- Available in open, closed (G), with screw flange (F) or with solder flange (LF).
- The solder flange makes an additional screw-fixation to the PCB unnecessary and protects the solder joints against mechanical stress.

Technical data

In compliance with IEC 60664-1 / IEC 61984			
Clamping range, max.			
Solid core H05(07) V-U			
Stranded H07 V-R			
Flexible H05(07) V-K			
Flexible with ferrule			
Ferrule with plastic collar			
Stripping length			
Screwdriver blade	mm		
According to norm			
Tightening torque range			
Rated current, max.	A	24	21
At ambient temperature		20°C	40°C
For conductor cross-section			
Overvoltage category		III	III II
Pollution severity		3	2 2
Rated voltage	V	250	320 400
Rated impulse voltage	kV	4	4 4
UL / CUL (Use Group)		B	C D
Rated voltage	V	300	300
Rated current	A	18.5	10
AWG conductor	AWG		-
CSA (Use Group)		B	C D
Rated voltage	V	300	300
Rated current	A	18.5	18.5
AWG conductor	AWG		-
General data			
Type of insulation material		PA GF	
UL 94 flammability rating		V-0	
Contact base material		CuMg	
Material of contact surface		tinned	
Pin dimensions = d	mm	1.2, Octagonal	
Solder eyelet Ø = D	mm	1.3	
Solder eyelet Ø tolerance	mm	+ 0,1	

Product data

IEC: 400 V / 24 A
UL: 300 V / 18.5 A



For additional articles and information, refer to catalog.weidmueller.com

Note:

- Additional colours on request
- Gold-plated contact surfaces on request
- Rated current related to rated cross-section & min. No. of poles.
- P on drawing = pitch
- Rated data refer only to the component itself. Clearance and creepage distances to other components are to be designed in accordance with the relevant application standards.

SL 5.08HC/./180



Dimensioned drawing

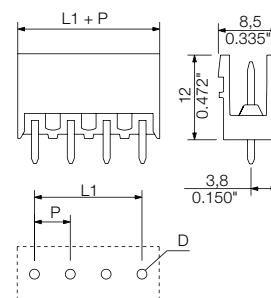

Accessories

Note: Refer to the Accessories chapter for additional accessories.

Coding	Order No.
BLZ/SL KO OR BX	1573010000
BLZ/SL KO BK BX	1545710000
Spacer	
SL AT OR	1598300000
SL AT SW	1770240000
Mounting block	
SLA BB11R OR	1604120000
SLA BB11R SW	1692340000

Ordering data

Solder pin length		3.2 mm		
Colour		orange		
Pitch	5.08 mm			
Pol.	L1	(inch)	Qty.	Order No.
2	5.08	0.200	100	1146320000
3	10.16	0.400	100	1146340000
4	15.24	0.600	100	1146380000
5	20.32	0.800	50	1146410000
6	25.40	1.000	50	1146450000
7	30.48	1.200	50	1146470000
8	35.56	1.400	50	1146490000
9	40.64	1.600	50	1146510000
10	45.72	1.800	50	1146530000
11	50.80	2.000	50	1146550000
12	55.88	2.200	50	1146570000

L

5.08

180°

SL 5.08HC../180G



Dimensioned drawing

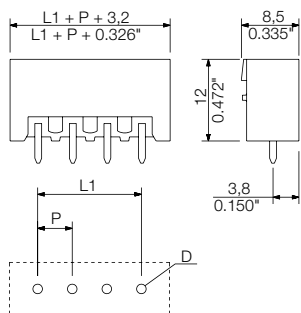

Ordering data

Solder pin length		3.2 mm	
Colour		orange	
Pitch		5.08 mm	
Pol.	L1	(inch)	Order No.
2	5.08	0.200	1146730000
3	10.16	0.400	1146750000
4	15.24	0.600	1146780000
5	20.32	0.800	1146800000
6	25.40	1.000	1146820000
7	30.48	1.200	1146840000
8	35.56	1.400	1146870000
9	40.64	1.600	1146890000
10	45.72	1.800	1146910000
11	50.80	2.000	1146930000
12	55.88	2.200	1146950000

SL 5.08HC../180B



Dimensioned drawing

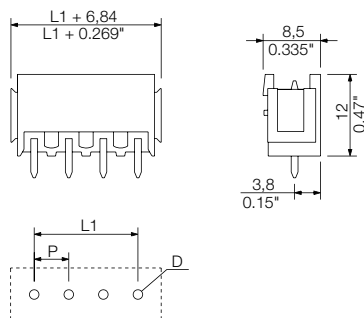

Ordering data

Solder pin length		3.2 mm	
Colour		orange	
Pitch		5.08 mm	
Pol.	L1	(inch)	Order No.
2	5.08	0.200	1147300000
3	10.16	0.400	1147330000
4	15.24	0.600	1147360000
5	20.32	0.800	1147390000
6	25.40	1.000	1147430000
7	30.48	1.200	1147470000
8	35.56	1.400	1147510000
9	40.64	1.600	1147540000
10	45.72	1.800	1147580000
11	50.80	2.000	1147610000
12	55.88	2.200	1147640000

Connectors in 5.08 mm pitch Series BL/SL 5.08

SL 5.08HC/./180

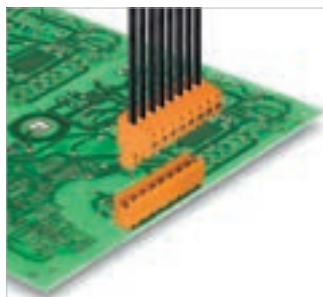

Male headers made from glass-fibre-reinforced plastic with 180° wire outlet; optimised for wave soldering, absolut dimension stable. The male headers can be manually coded or ordered as pre-coded headers.

- Available in open, closed (G), with screw flange (F) or with solder flange (LF).
- The solder flange makes an additional screw-fixation to the PCB unnecessary and protects the solder joints against mechanical stress.

Technical data

In compliance with IEC 60664-1 / IEC 61984

Clamping range, max.			
Solid core H05(07) V-U			
Stranded H07 V-R			
Flexible H05(07) V-K			
Flexible with ferrule			
Ferrule with plastic collar			
Stripping length			
Screwdriver blade	mm		
According to norm			
Tightening torque range			
Rated current, max.	A	24	21
At ambient temperature		20°C	40°C
For conductor cross-section			
Overvoltage category		III	III II
Pollution severity		3	2 2
Rated voltage	V	250	320 400
Rated impulse voltage	kV	4	4 4
UL / CUL (Use Group)	B C D		
Rated voltage	V	300	300
Rated current	A	18.5	10
AWG conductor	AWG	-	
CSA (Use Group)	B C D		
Rated voltage	V	300	300
Rated current	A	18.5	18.5
AWG conductor	AWG	-	
General data			
Type of insulation material	PA GF		
UL 94 flammability rating	V-0		
Contact base material	CuMg		
Material of contact surface	tinned		
Pin dimensions = d	mm	1.2, Octagonal	
Solder eyelet Ø = D	mm	1.3	
Solder eyelet Ø tolerance	mm	+ 0,1	

Product data

IEC: 400 V / 24 A
UL: 300 V / 18.5 A



For additional articles and information, refer to catalog.weidmueller.com

Note:

- Additional colours on request
- Gold-plated contact surfaces on request
- Rated current related to rated cross-section & min. No. of poles.
- P on drawing = pitch
- Rated data refer only to the component itself. Clearance and creepage distances to other components are to be designed in accordance with the relevant application standards.

SL 5.08HC/./180F



Dimensioned drawing

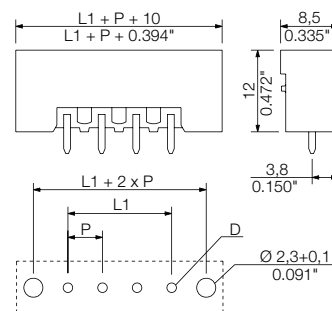

Accessories

Note: Refer to the Accessories chapter for additional accessories.

Coding	Order No.
BLZ/SL KO OR BX	1573010000
BLZ/SL KO BK BX	1545710000
Spacer	
SL AT OR	1598300000
SL AT SW	1770240000

Ordering data

Solder pin length		3.2 mm		
Colour		orange		
Pitch		5.08 mm		
Pol.	L1	(inch)	Qty.	Order No.
2	5.08	0.200	90	1147130000
3	10.16	0.400	72	1147170000
4	15.24	0.600	60	1147200000
5	20.32	0.800	48	1147230000
6	25.40	1.000	42	1147260000
7	30.48	1.200	36	1147290000
8	35.56	1.400	36	1147320000
9	40.64	1.600	30	1147350000
10	45.72	1.800	30	1147380000
11	50.80	2.000	24	1147410000
12	55.88	2.200	24	1147440000

SL 5.08HC../180LF

with solder flange



Dimensioned drawing

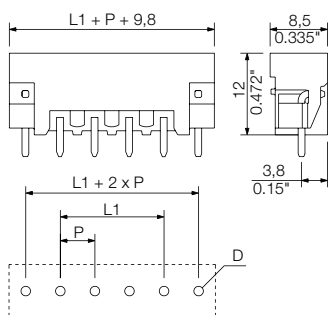

Ordering data

Solder pin length		3.2 mm	
Colour		orange	
Pitch		5.08 mm	
Pol.	L1	(inch)	Qty. Order No.
2	5.08	0.200	90 1147890000
3	10.16	0.400	72 1147920000
4	15.24	0.600	60 1147950000
5	20.32	0.800	48 1147990000
6	25.40	1.000	42 1148020000
7	30.48	1.200	36 1148050000
8	35.56	1.400	36 1148090000
9	40.64	1.600	30 1148120000
10	45.72	1.800	30 1148150000
11	50.80	2.000	24 1148190000
12	55.88	2.200	24 1148220000

Connectors in 5.08 mm pitch Series BL/SL 5.08

SLD 5.08V../90 & 180

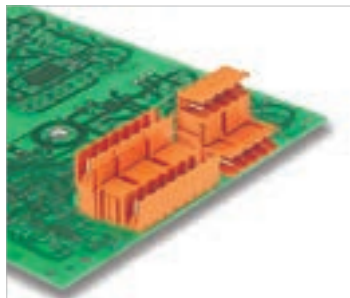

Double-level male header optimised for wave soldering. The connection levels are offset and designed for a female plug with screw- or PUSH IN wire connect. All male headers can be manually coded or ordered as pre-coded headers.

Technical data

In compliance with IEC 60664-1 / IEC 61984

Clamping range, max.			
Solid core H05(07) V-U			
Stranded H07 V-R			
Flexible H05(07) V-K			
Flexible with ferrule			
Ferrule with plastic collar			
Stripping length			
Screwdriver blade	mm		
According to norm			
Tightening torque range			
Rated current, max.	17	15	
At ambient temperature	20°C	40°C	
For conductor cross-section			
Overvoltage category	III	III	II
Pollution severity	3	2	2
Rated voltage	V	250	320
Rated impulse voltage	kV	4	4
UL / CUL (Use Group)		B	C
Rated voltage	V	300	300
Rated current	A	10	10
AWG conductor	AWG	-	-
CSA (Use Group)		B	C
Rated voltage	V	300	300
Rated current	A	10	10
AWG conductor	AWG	-	-
General data			
Type of insulation material	PBT		
UL 94 flammability rating	V-0		
Contact base material	CuSn		
Material of contact surface	tinned		
Pin dimensions = d	mm	1.2, Octagonal	
Solder eyelet Ø = D	mm	1.3	
Solder eyelet Ø tolerance	mm	+ 0,1	

Product data

IEC: 400 V / 17 A
UL: 300 V / 10 A



For additional articles and information, refer to catalog.weidmuller.com

Note:

- Additional colours on request
- Rated current related to rated cross-section & min. No. of poles.
- Spacing between rows: see hole layout
- P on drawing = pitch
- Rated data refer only to the component itself. Clearance and creepage distances to other components are to be designed in accordance with the relevant application standards.

SLD 5.08V/90



Dimensioned drawing

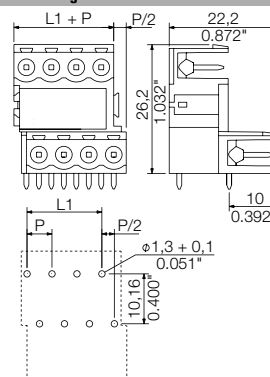

Accessories

Note: Refer to the Accessories chapter for additional accessories.

Mounting block		Order No.
	SLA BB14 OR	1594200000
	SLA BB14 SW	1774460000
Coding		
	BLZ/SL KO OR BX	1573010000
	BLZ/SL KO BK BX	1545710000
Spacer		
	SL AT OR	1598300000
	SL AT SW	1770240000

Ordering data

Solder pin length		3.2 mm		
Colour		orange		
Pitch		5.08 mm		
Pol.	L1	(inch)	Qty.	Order No.
4	5.08	0.200	50	1725170000
6	10.16	0.400	50	1725180000
8	15.24	0.600	50	1725190000
10	20.32	0.800	50	1725200000
12	25.40	1.000	50	1725210000
14	30.48	1.200	20	1725220000
16	35.56	1.400	20	1725230000
18	40.64	1.600	20	1725240000
20	45.72	1.800	20	1725250000
22	50.80	2.000	10	1725260000
24	55.88	2.200	10	1725270000

L

5.08

90°

SLD 5.08V/180



Dimensioned drawing

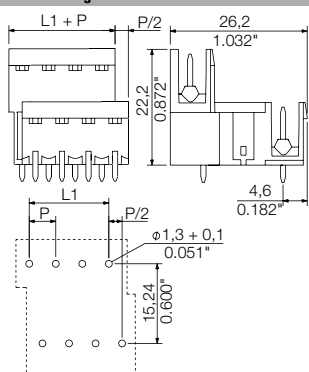

Ordering data

Solder pin length		3.2 mm		
Colour		orange		
Pitch		5.08 mm		
Pol.	L1	(inch)	Qty.	Order No.
4	5.08	0.200	50	1725650000
6	10.16	0.400	50	1725660000
8	15.24	0.600	50	1725670000
10	20.32	0.800	50	1725680000
12	25.40	1.000	50	1725690000
14	30.48	1.200	20	1725700000
16	35.56	1.400	20	1725710000
18	40.64	1.600	20	1725720000
20	45.72	1.800	20	1725730000
22	50.80	2.000	10	1725740000
24	55.88	2.200	10	1725750000



Connectors in 5.08 mm pitch Series BL/SL 5.08

SLD 5.08../90 & 180

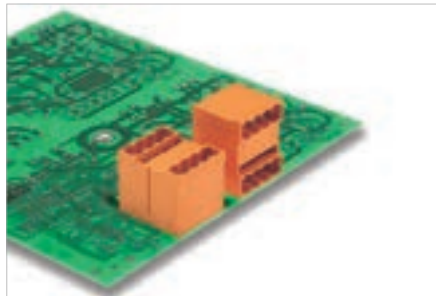

Double-level male header optimised for wave soldering. The connections are at the same level – with access that is flush over the front board. The male headers can be manually coded or ordered as pre-coded headers.

Technical data

In compliance with IEC 60664-1 / IEC 61984

Clamping range, max.			
Solid core H05(07) V-U			
Stranded H07 V-R			
Flexible H05(07) V-K			
Flexible with ferrule			
Ferrule with plastic collar			
Stripping length			
Screwdriver blade	mm		
According to norm			
Tightening torque range			
Rated current, max.	A	11	9.5
At ambient temperature		20°C	40°C
For conductor cross-section			
Overvoltage category		III	III II
Pollution severity		3	2 2
Rated voltage	V	250	320 400
Rated impulse voltage	kV	4	4 4
UL / CUL (Use Group)	B C D		
Rated voltage	V	300	300
Rated current	A	10	10
AWG conductor	AWG	-	
CSA (Use Group)	B C D		
Rated voltage	V	300	300
Rated current	A	10	10
AWG conductor	AWG	-	
General data			
Type of insulation material	PBT		
UL 94 flammability rating	V-0		
Contact base material	CuSn		
Material of contact surface	tinned		
Pin dimensions = d	mm	1.2, Octagonal	
Solder eyelet Ø = D	mm	1.3	
Solder eyelet Ø tolerance	mm	+ 0,1	

Product data

IEC: 400 V / 11 A
UL: 300 V / 10 A



For additional articles and information, refer to catalog.weidmuller.com

Note:

- Additional colours on request
- Rated current related to rated cross-section & min. No. of poles.
- Spacing between rows: see hole layout
- P on drawing = pitch
- Rated data refer only to the component itself. Clearance and creepage distances to other components are to be designed in accordance with the relevant application standards.

SLD 5.08../90G



Dimensioned drawing

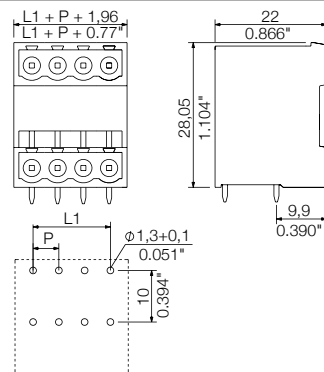

Accessories

Note: Refer to the Accessories chapter for additional accessories.

Coding	Order No.
BLZ/SL KO OR BX	1573010000
BLZ/SL KO BK BX	1545710000
Spacer	Order No.
SL AT OR	1598300000
SL AT SW	1770240000

Ordering data

Solder pin length		3.2 mm		
Colour		orange		
Pitch		5.08 mm		
Pol.	L1	(inch)	Qty.	Order No.
4	5.08	0.200	50	1601790000
6	10.16	0.400	50	1601800000
8	15.24	0.600	50	1601810000
10	20.32	0.800	50	1601820000
12	25.40	1.000	50	1601830000
14	30.48	1.200	20	1601840000
16	35.56	1.400	20	1601850000
18	40.64	1.600	20	1601860000
20	45.72	1.800	20	1601870000
22	50.80	2.000	10	1601880000
24	55.88	2.200	10	1601890000

L

5.08

90°

SLD 5.08/.. /180G

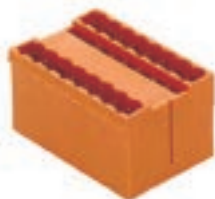

Dimensioned drawing

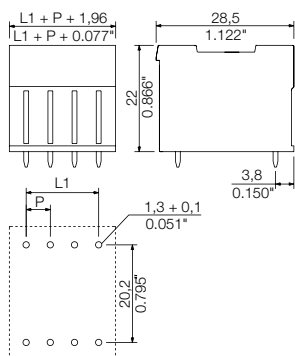

Ordering data

Solder pin length		3.2 mm		
Colour		orange		
Pitch		5.08 mm		
Pol.	L1	(inch)	Qty.	Order No.
4	5.08	0.200	50	1602390000
6	10.16	0.400	50	1602400000
8	15.24	0.600	50	1602410000
10	20.32	0.800	50	1602420000
12	25.40	1.000	50	1602430000
14	30.48	1.200	20	1602440000
16	35.56	1.400	20	1602450000
18	40.64	1.600	20	1602460000
20	45.72	1.800	20	1602470000
22	50.80	2.000	10	1602480000
24	55.88	2.200	10	1602490000



Connectors in 5.08 mm pitch Series BL/SL 5.08

SLDF 5.08 L/F..



Feed-through male connector with optional locking function, for mounting on front plate. Internal connection as flat-blade or solder connection. All male headers can be manually coded or ordered as pre-coded headers.

Technical data

In compliance with IEC 60664-1 / IEC 61984

Clamping range, max.			
Solid core H05(07) V-U			
Stranded H07 V-R			
Flexible H05(07) V-K			
Flexible with ferrule			
Ferrule with plastic collar			
Stripping length			
Screwdriver blade	mm		
According to norm			
Tightening torque range			
Rated current, max.	15	13	
At ambient temperature	20°C	40°C	
For conductor cross-section			
Overvoltage category	III	III	II
Pollution severity	3	2	2
Rated voltage	V	250	320
Rated impulse voltage	kV	4	4
UL / CUL (Use Group)	B	C	D
Rated voltage	V	300	300
Rated current	A	10	10
AWG conductor	AWG	-	-
CSA (Use Group)	B	C	D
Rated voltage	V	300	300
Rated current	A	10	10
AWG conductor	AWG	-	-
General data			
Type of insulation material	PBT		
UL 94 flammability rating	V-0		
Contact base material	CuSn		
Material of contact surface	tinned		
Pin dimensions = d	mm		
Solder eyelet Ø = D	mm		
Solder eyelet Ø tolerance	mm		

Product data

IEC: 400 V / 15 A
UL: 300 V / 10 A



For additional articles and information, refer to catalog.weidmueller.com

Note:

- Additional colours on request
- Rated current related to rated cross-section & min. No. of poles.
- Connectable cables with solder connection solid and flexible up to 2.5 mm² with insulating/shrink-wrap sleeve or from 2.8 mm flat blade receptacles with insulated sleeves acc. to DIN IEC 760
- P on drawing = pitch
- Rated data refer only to the component itself. Clearance and creepage distances to other components are to be designed in accordance with the relevant application standards.

SLDF 5.08 L/F..



Dimensioned drawing

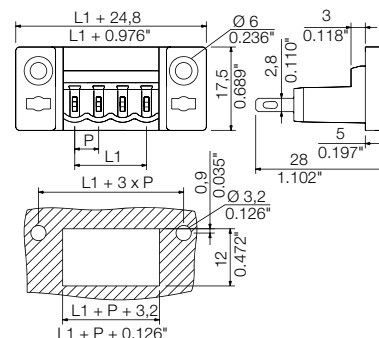

Accessories

Note: Refer to the Accessories chapter for additional accessories.

Coding	Order No.
BLZ/SL KO OR BX	1573010000
BLZ/SL KO BK BX	1545710000
Spacer	
SL AT OR	1598300000
SL AT SW	1770240000
Interlock	
SLDF VR BK	1599120000

Ordering data

Solder pin length				
Colour	orange			
Pitch	5.08 mm			
Pol.	L1	(inch)	Qty.	Order No.
2	5.08	0.200	60	1599130000
3	10.16	0.400	48	1599140000
4	15.24	0.600	42	1599150000
5	20.32	0.800	36	1599160000
6	25.40	1.000	36	1599170000
7	30.48	1.200	30	1599180000
8	35.56	1.400	30	1599190000
9	40.64	1.600	24	1599200000
10	45.72	1.800	24	1599210000
11	50.80	2.000	24	1599220000
12	55.88	2.200	18	1599230000



Connectors in 5.08 mm pitch Series BL/SL 5.08

SLS 5.08../180DF

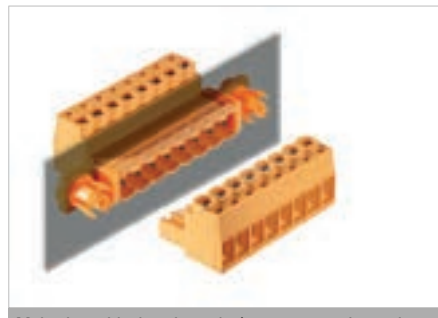

Male plug with clamping yoke/screw connection and straight wire outlet. The male plugs feature space for labelling and can be coded. Packed in a cardboard box.

- SLS 5.08 F & BLZP 5.08 F for wire-to-wire applications as wall or device feed-through
- SLS 5.08 F & BLZP 5.08 F for wire-to-wire applications / flying lead couplings
- SLS 5.08 FI & BLL 5.08 FI for board-to-wire connections (power supply for actuators)
- Folded steel clamping yoke accommodates the connected wire and compensates for temperature fluctuations

Technical data

In compliance with IEC 60664-1 / IEC 61984			
Clamping range, max.	mm ²	0.13...3.31	
Solid core H05(07) V-U	mm²	0.2...2.5	
Stranded H07 V-R			
Flexible H05(07) V-K	mm ²	0.2...2.5	
Flexible with ferrule	mm ²	0.2...2.5	
Ferrule with plastic collar	mm ²	0.2...2.5	
Stripping length	mm	7	
Screwdriver blade	mm	0.6 x 3.5	
According to norm		DIN 5264-A	
Tightening torque range	Nm	0.4...0.5	
Rated current, max.	A	21.5	18
At ambient temperature		20°C	40°C
For conductor cross-section			
Overvoltage category		III	III II
Pollution severity		3	2 2
Rated voltage	V	250	320 400
Rated impulse voltage	kV	4	4 4
UL / CUL (Use Group)	B C D	B	C D
Rated voltage	V	300	300
Rated current	A	14	10
AWG conductor	AWG	26-12	
CSA (Use Group)	B C D	B	C D
Rated voltage	V	300	300
Rated current	A	15	10
AWG conductor	AWG	26-12	
General data			
Type of insulation material		PBT	
UL 94 flammability rating		V-0	
Contact base material		CuSn	
Material of contact surface		tinned	
Pin dimensions = d	mm		
Solder eyelet Ø = D	mm		
Solder eyelet Ø tolerance	mm		

Product data

IEC: 400 V / 21.5 A / 0.2 - 2.5 mm²
UL: 300 V / 14 A / AWG 26 - 12



For additional articles and information, refer to catalog.weidmueller.com

Note:

- Additional colours on request
- Rated current related to rated cross-section & min. No. of poles.
- Wire end ferrule without plastic collar to DIN 46228/1
- Wire end ferrule with plastic collar to DIN 46228/4
- P on drawing = pitch
- Rated data refer only to the component itself. Clearance and creepage distances to other components are to be designed in accordance with the relevant application standards.

SLS 5.08../180DF



Dimensioned drawing

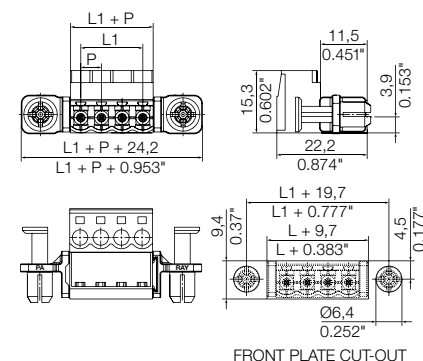

Accessories

Note: Refer to the Accessories chapter for additional accessories.

Strain relief		Order No.
	BLZ 5.08 ZE04 OR BX	1652110000
	BLZ 5.08 ZE04 BK BX	1652130000
	BLZ 5.08 ZE08 OR BX	1652050000
	BLZ 5.08 ZE08 BK BX	1652070000
Coding		
	BLZ/SL KO QR BX	1573010000
	BLZ/SL KO BK BX	1545710000
Screwdriver		
	SDS 0.6X3.5X100	2749340000
	SDIS 0.6X3.5X100	2749810000
Spacer		
	SL AT OR	1598300000
	SL AT SW	1770240000

Ordering data

Solder pin length				
Colour	orange			
Pitch	5.08 mm			
Pol.	L1	(inch)	Qty.	Order No.
2	5.08	0.200	54	1353470000
3	10.16	0.400	42	1353480000
4	15.24	0.600	42	1353490000
5	20.32	0.800	36	1353500000
6	25.40	1.000	30	1353520000
7	30.48	1.200	30	1353530000
8	35.56	1.400	24	1353540000
9	40.64	1.600	24	1353550000
10	45.72	1.800	24	1353570000

Representative deratings curve

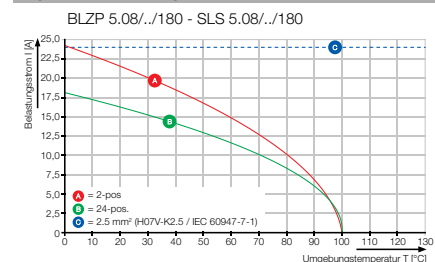

Flexibility & safety

Maximum flexibility and optimum safety should be guaranteed when designing this equipment.

This application can be made with various connection systems: a TOP connection with a screw, clamping yoke or PUSH IN. It is necessary to adapt the hole size, as appropriate, to the expanding rivets so that they are able to respond to the thickness of the customers' housing wall whilst still being able to guarantee the highest level of safety. This means we strike just the right balance between easy pin insertion without using a tool and optimum stability and vibration resistance for the entire coupling during the application.

BBDF sectional drawing in the wall of the housing

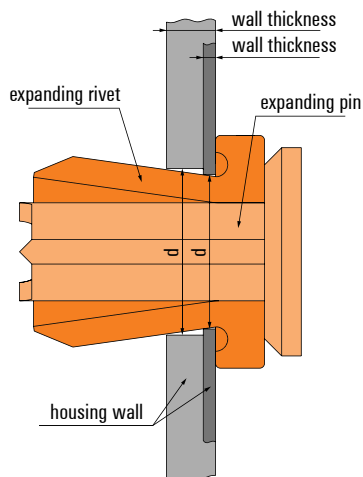

hole size table

	housing wall thickness	hole size (p)
mm	0.5 - 0.8	6.3
	1	6.4
	1.5	6.5
	2	6.7
inch	0.019 - 0.031	0.248
	0.039	0.252
	0.059	0.256
	0.079	0.264

assembly description

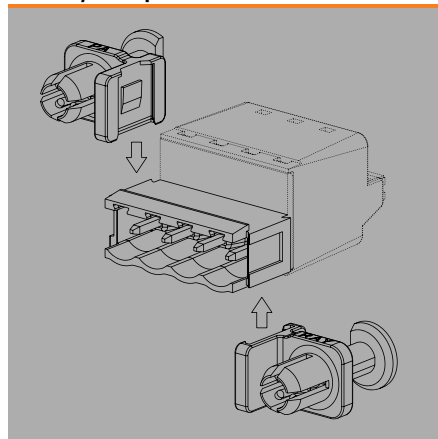

Connectors in 5.08 mm pitch Series BL/SL 5.08

SLF 5.08../180DF

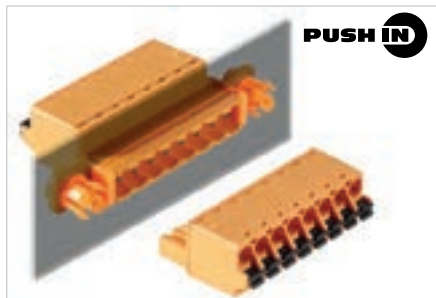

PUSH IN

Male plug with PUSH IN wire connection system, with straight wire outlet. The male plugs feature space for labelling and can be coded. Packed in a cardboard box.

- SLF 5.08 DF & BLF 5.08 for wire-to-wire applications in the form of panel or device feed-through)
- SLF 5.08 F & BLF 5.08 F for wire-to-wire applications / flying lead couplings
- SLF 5.08 FI & BLL 5.08 FI for board-to-wire connections (power supply for actuators)

Technical data

In compliance with IEC 60664-1 / IEC 61984			
Clamping range, max.	mm ²	0.13...3.31	
Solid core H05(07) V-U	mm ²	0.2...2.5	
Stranded H07 V-R			
Flexible H05(07) V-K	mm ²	0.2...2.5	
Flexible with ferrule	mm ²	0.2...2.5	
Ferrule with plastic collar	mm ²	0.2...2.5	
Stripping length	mm	10	
Screwdriver blade	mm	0.6 x 3.5	
According to norm		DIN 5264	
Tightening torque range			
Rated current, max.	A	25.9	22.5
At ambient temperature	20°C	40°C	
For conductor cross-section	mm ²	2.5	
Overvoltage category		III	II
Pollution severity		3	2
Rated voltage	V	250	320
Rated impulse voltage	kV	4	4
UL / CUL (Use Group)		B	C
Rated voltage	V	300	300
Rated current	A	14	10
AWG conductor	AWG	26-12	
CSA (Use Group)		B	C
Rated voltage	V	300	300
Rated current	A	10	10
AWG conductor	AWG	26-12	
General data			
Type of insulation material		PBT	
UL 94 flammability rating		V-0	
Contact base material		CuSn	
Material of contact surface		tinned	
Pin dimensions = d	mm		
Solder eyelet Ø = D			
Solder eyelet Ø tolerance	mm		

Product data

IEC: 400 V / 25.9 A / 0.2 - 2.5 mm²
UL: 300 V / 14 A / AWG 26 - 12



For additional articles and information, refer to catalog.weidmuller.com

Note:

- Additional colours on request
- Gold-plated contact surfaces on request
- Rated current related to rated cross-section & min. No. of poles.
- Wire end ferrule without plastic collar to DIN 46228/1
- Wire end ferrule with plastic collar to DIN 46228/4
- P on drawing = pitch
- Crimping shape "A" for wire end ferrules with PZ 6/5 crimping tool recommended.
- The test point can only be used as potential-pickup point.

SLF 5.08../180DF



Dimensioned drawing

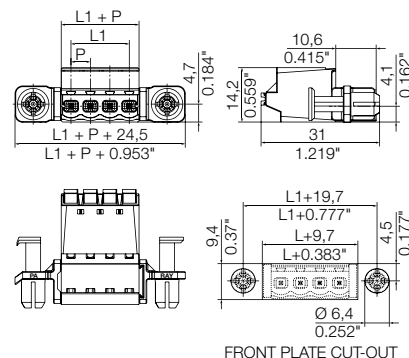

Accessories

Note: Refer to the Accessories chapter for additional accessories.

Coding	Order No.
BLZ/SL KO OR BX	1573010000
BLZ/SL KO BK BX	1545710000
Screwdriver	
SDS 0.6X3.5X100	2749340000
SDIS 0.6X3.5X100	2749810000
Wire-end ferrule	
H0,5/14S W	9004590000
H1,5/14DS SW	9025240000
H2,5/14DS BL	1333100000

Ordering data

Solder pin length				
Colour	orange			
Pitch	5.08 mm			
Pol.	L1	(inch)	Qty.	Order No.
2	5.08	0.200	54	1353580000
3	10.16	0.400	42	1353590000
4	15.24	0.600	42	1353600000
5	20.32	0.800	36	1353620000
6	25.40	1.000	30	1353630000
7	30.48	1.200	30	1353640000
8	35.56	1.400	24	1353650000
9	40.64	1.600	24	1353670000
10	45.72	1.800	24	1353680000

L

5.08

180°

2.5 mm²

Flexibility & safety

Maximum flexibility and optimum safety should be guaranteed when designing this equipment.

This application can be made with various connection systems: a TOP connection with a screw, clamping yoke or PUSH IN. It is necessary to adapt the hole size, as appropriate, to the expanding rivets so that they are able to respond to the thickness of the customers' housing wall whilst still being able to guarantee the highest level of safety. This means we strike just the right balance between easy pin insertion without using a tool and optimum stability and vibration resistance for the entire coupling during the application.

BBDF sectional drawing in the wall of the housing

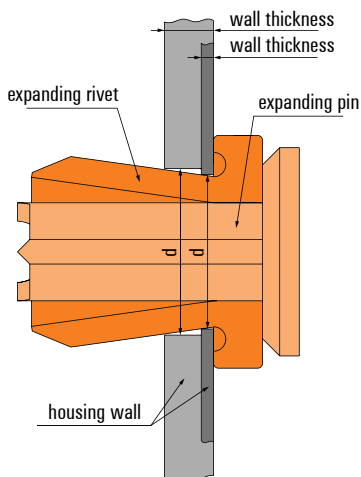

hole size table

	housing wall thickness	hole size (p)
mm	0.5 - 0.8	6.3
	1	6.4
	1.5	6.5
	2	6.7
inch	0.019 - 0.031	0.248
	0.039	0.252
	0.059	0.256
	0.079	0.264

assembly description

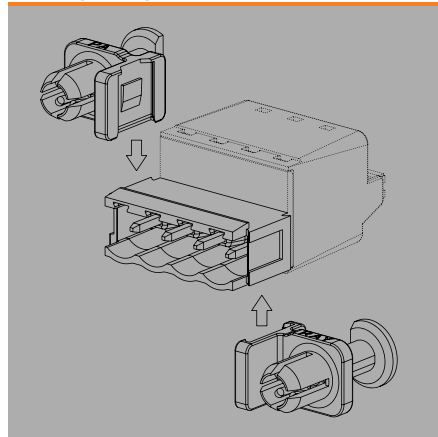

Connectors in 5.08 mm pitch Series BL/SL 5.08

BLT 5.08../180DF

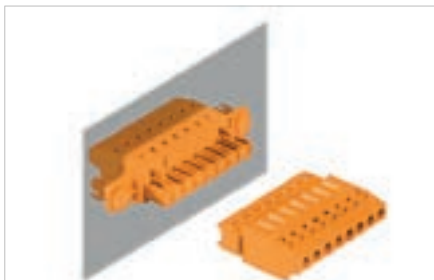

Female plug with clamping-yoke screw connection system and straight wire outlet. The female connectors provide space for labelling and can be coded. Packed in a cardboard box. HC = High Current.

- SLT 5.08 & BLT 5.08HC 180DF for wire-to-wire applications, for wall or device feed-through

Product data

IEC: 400 V / 27 A / 0.2 - 2.5 mm²
UL: 300 V / 17 A / AWG 26 - 14



For additional articles and information, refer to catalog.weidmueller.com

Note:

- Additional colours on request
- Gold-plated contact surfaces on request
- Rated current related to rated cross-section & min. No. of poles.
- Wire end ferrule without plastic collar to DIN 46228/1
- Wire end ferrule with plastic collar to DIN 46228/4
- Crimp form A for wire end ferrules with PZ 6/5 crimping tool are recommended for the largest cable sizes.
- P on drawing = pitch
- Rated data refer only to the component itself. Clearance and creepage distances to other components are to be designed in accordance with the relevant application standards.

BLT 5.08../180DF



Dimensioned drawing

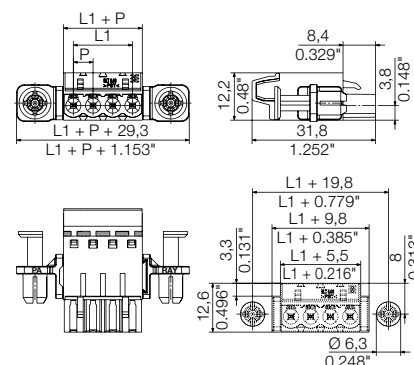

Technical data

In compliance with IEC 60664-1 / IEC 61984			
Clamping range, max.	mm ²	0.13...2.5	
Solid core H05(07) V-U	mm ²	0.2...2.5	
Stranded H07 V-R			
Flexible H05(07) V-K	mm ²	0.2...1.5	
Flexible with ferrule	mm ²	0.2...1.5	
Ferrule with plastic collar	mm ²	0.2...1.5	
Stripping length	mm	13	
Screwdriver blade	mm		
According to norm		DIN 5264	
Tightening torque range			
Rated current, max.	A	27	24
At ambient temperature		20°C	40°C
For conductor cross-section	mm ²	2.5	
Overvoltage category		III	III II
Pollution severity		3	2 2
Rated voltage	V	250	320 400
Rated impulse voltage	kV	4	4 4
UL / CUL (Use Group)		B	C D
Rated voltage	V	300	300
Rated current	A	17	10
AWG conductor	AWG	26-14	
CSA (Use Group)		B	C D
Rated voltage	V	300	300
Rated current	A	15	15
AWG conductor	AWG	26-14	
General data			
Type of insulation material		PBT	
UL 94 flammability rating		V-0	
Contact base material		CuSn	
Material of contact surface		tinned	
Pin dimensions = d	mm		
Solder eyelet Ø = D			
Solder eyelet Ø tolerance	mm		

Accessories

Note: Refer to the Accessories chapter for additional accessories.

Coding	Order No.
BLZ/SL KO OR BX	1573010000
BLZ/SL KO BK BX	1545710000
Screwdriver	
SDIS 0.6X3.5X100	2749810000
SDS 0.6X3.5X100	2749340000
Spacer	
SL AT OR	1598300000
SL AT SW	1770240000

Ordering data

Solder pin length				
Colour	orange			
Pitch	5.08 mm			
Pol.	L1	(inch)	Qty.	Order No.
2	5.08	0.200	54	1353130000
3	10.16	0.400	42	1353140000
4	15.24	0.600	42	1353150000
5	20.32	0.800	36	1353170000
6	25.40	1.000	30	1353180000
7	30.48	1.200	30	1353190000
8	35.56	1.400	24	1353200000
9	40.64	1.600	24	1353220000
10	45.72	1.800	24	1353230000

5.08

180°

2.5 mm²

Flexibility & safety

Maximum flexibility and optimum safety should be guaranteed when designing this equipment.

This application can be made with various connection systems: a TOP connection with a screw, clamping yoke or PUSH IN. It is necessary to adapt the hole size, as appropriate, to the expanding rivets so that they are able to respond to the thickness of the customers' housing wall whilst still being able to guarantee the highest level of safety. This means we strike just the right balance between easy pin insertion without using a tool and optimum stability and vibration resistance for the entire coupling during the application.

BBDF sectional drawing in the wall of the housing

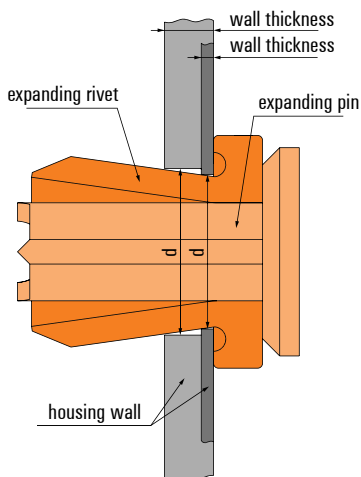

hole size table

	housing wall thickness	hole size (p)
mm	0.5 - 0.8	6.3
	1	6.4
	1.5	6.5
	2	6.7
inch	0.019 - 0.031	0.248
	0.039	0.252
	0.059	0.256
	0.079	0.264

assembly description

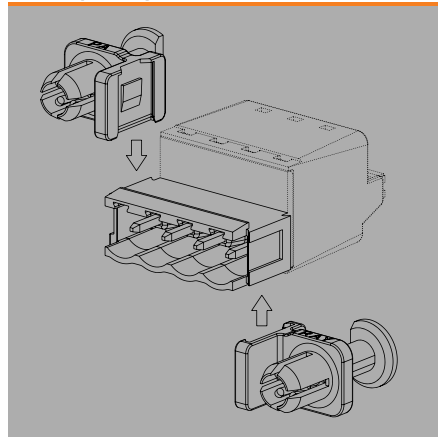

Connectors in 5.08 mm pitch Series BL/SL 5.08

BLF 5.08../180DF

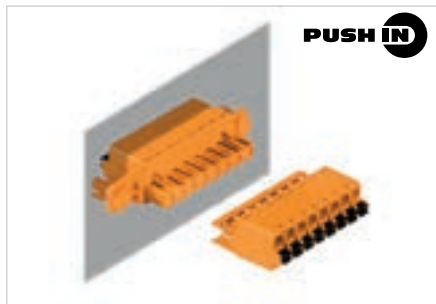

PUSH IN

Female plug with PUSH IN wire connection system and straight outlet direction. The female connectors provide space for labelling and can be coded. Packed in a cardboard box. HC = High Current.

- SLF 5.08 & BLF 5.08HC DF for wire-to-wire applications, for wall or device feed-through

Technical data

In compliance with IEC 60664-1 / IEC 61984			
Clamping range, max.	mm ²	0.13...3.31	
Solid core H05(07) V-U	mm ²	0.2...2.5	
Stranded H07 V-R			
Flexible H05(07) V-K	mm ²	0.2...2.5	
Flexible with ferrule	mm ²	0.25...2.5	
Ferrule with plastic collar	mm ²	0.25...2.5	
Stripping length	mm	10	
Screwdriver blade	mm	0.6 x 3.5	
		According to norm DIN 5264	
Tightening torque range			
Rated current, max.	A	24	21
At ambient temperature		20°C	40°C
For conductor cross-section	mm ²	2.5	
Overvoltage category		III	III II
Pollution severity		3	2 2
Rated voltage	V	250	320 400
Rated impulse voltage	kV	4	4 4
UL / CUL (Use Group)		B	C D
Rated voltage	V	300	300
Rated current	A	18.5	10
AWG conductor	AWG	26-12	
CSA (Use Group)		B	C D
Rated voltage	V	300	300
Rated current	A		10
AWG conductor	AWG	26-12	
General data			
Type of insulation material		PBT	
UL 94 flammability rating		V-0	
Contact base material		CuSn	
Material of contact surface		tinned	
Pin dimensions = d	mm		
Solder eyelet Ø = D			
Solder eyelet Ø tolerance	mm		

Product data

IEC: 400 V / 24 A / 0.2 - 2.5 mm²
UL: 300 V / 18.5 A / AWG 26 - 12



For additional articles and information, refer to catalog.weidmueller.com

Note:

- Additional colours on request
- Gold-plated contact surfaces on request
- Rated current related to rated cross-section & min. No. of poles.
- Wire end ferrule without plastic collar to DIN 46228/1
- Wire end ferrule with plastic collar to DIN 46228/4
- P on drawing = pitch
- Crimping shape "A" for wire end ferrules with PZ 6/5 crimping tool recommended.
- The test point can only be used as potential-pickup point.

BLF 5.08../180DF



Dimensioned drawing

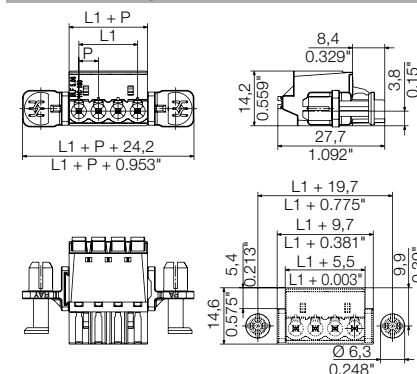

Accessories

Note: Refer to the Accessories chapter for additional accessories.

Coding	Order No.
BLZ/SL KO OR BX	1573010000
BLZ/SL KO BK BX	1545710000
Screwdriver	
SDIS 0.6X3.5X100	2749810000
SDS 0.6X3.5X100	2749340000
Wire-end ferrule	
H0,5/14S W	9004590000
H1,5/14DS SW	9025240000
H2,5/14DS BL	1333100000

Ordering data

Solder pin length				
Colour	orange			
Pitch	5.08 mm			
Pol.	L1	(inch)	Qty.	Order No.
2	5.08	0.200	54	1353240000
3	10.16	0.400	42	1353250000
4	15.24	0.600	42	1353270000
5	20.32	0.800	36	1353280000
6	25.40	1.000	30	1353340000
7	30.48	1.200	30	1353290000
8	35.56	1.400	24	1353300000
9	40.64	1.600	24	1353320000
10	45.72	1.800	24	1353330000

L

5.08

180°

2.5 mm²

Flexibility & safety

Maximum flexibility and optimum safety should be guaranteed when designing this equipment.

This application can be made with various connection systems: a TOP connection with a screw, clamping yoke or PUSH IN. It is necessary to adapt the hole size, as appropriate, to the expanding rivets so that they are able to respond to the thickness of the customers' housing wall whilst still being able to guarantee the highest level of safety. This means we strike just the right balance between easy pin insertion without using a tool and optimum stability and vibration resistance for the entire coupling during the application.

BBDF sectional drawing in the wall of the housing

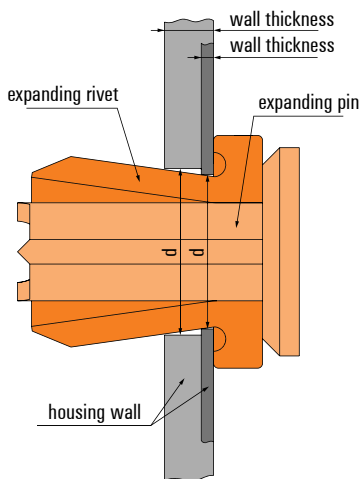

hole size table

	housing wall thickness	hole size (p)
mm	0.5 - 0.8	6.3
	1	6.4
	1.5	6.5
	2	6.7
inch	0.019 - 0.031	0.248
	0.039	0.252
	0.059	0.256
	0.079	0.264

assembly description

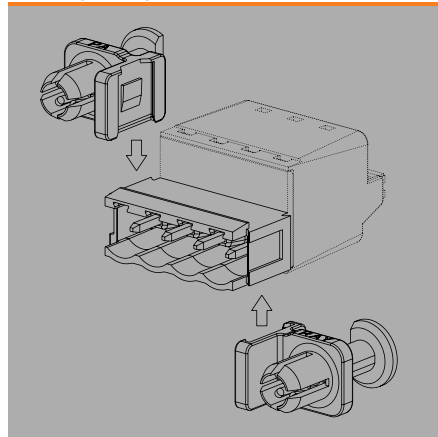

PUSH IN connection technology

PUSH IN connection technology reduces the wiring affords especially for solid wires and wires with ferrule to a minimum. These connectors are self-explanatory and enable tool-less handling. The contact element made of stainless steel ensures a vibration proofed, maintenance free wire termination. The established principle "STEEL FOR THE FORCE, COPPER FOR THE CURRENT" by Weidmüller offers both, maximum conductor clamping forces, as well as minimum power loss at the same time.



The 2-in-1 contact

Every pluggable connector covers two contact points and thus must meet two different requirements: First, the wire termination and second, the connection between plug and pin header. Referring to the 5.0x pitch series, Weidmüller offers different wire connection technologies, but one platform contact for the male / female connection since years. This well-designed hybride platform contact ensures a constant quality on a very high level. Hybride means, that we combine metal material featuring different characteristics by welding, in order to divide the contact system into different function zones: Further to the high electric conductance, the current bar is characterized by its hardness, and the tulip contact by its excellent tension properties. The advantage: each function is supported by the most suitable material to reliably and constantly meet the different electrical and mechanical requirements. To put it in a nutshell: Instead of either ... or, it's even both - perfect for the current, and perfect for the force.



Connectors in 5.08 mm pitch Series BL/SL 5.08

SLS 5.08../180

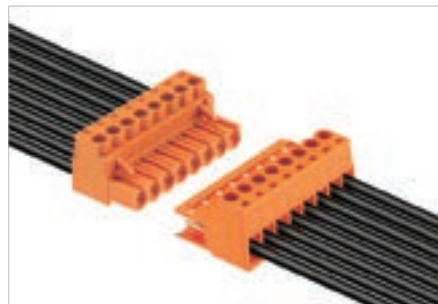

Male plug with clamping yoke screw connection and straight wire outlet. The male plugs provide space for labelling and can be coded. Packed in cardboard box.

- SLS 5.08 F & BLZP 5.08 F for wire-to-wire applications / flying lead couplings
- SLS 5.08 FI & BLL 5.08 FI for board-to-wire connections (power supply for actuators)
- Folded steel clamping yoke accommodates the connected wire and compensates for temperature fluctuations

Technical data

In compliance with IEC 60664-1 / IEC 61984			
Clamping range, max.	mm ²	0.13...3.31	
Solid core H05(07) V-U	mm²	0.2...2.5	
Stranded H07 V-R			
Flexible H05(07) V-K	mm ²	0.2...2.5	
Flexible with ferrule	mm ²	0.2...2.5	
Ferrule with plastic collar	mm ²	0.2...2.5	
Stripping length	mm	7	
Screwdriver blade	mm	0.6 x 3.5	
According to norm		DIN 5264-A	
Tightening torque range			
Rated current, max.	A	21.5	18
At ambient temperature		20°C	40°C
For conductor cross-section			
Overvoltage category		III	III II
Pollution severity		3	2 2
Rated voltage	V	250	320 400
Rated impulse voltage	kV	4	4 4
UL / CUL (Use Group)		B	C D
Rated voltage	V	300	300
Rated current	A	14	10
AWG conductor	AWG	26-12	
CSA (Use Group)		B	C D
Rated voltage	V	300	300
Rated current	A	15	10
AWG conductor	AWG	26-12	
General data			
Type of insulation material		PBT	
UL 94 flammability rating			
Contact base material		CuSn	
Material of contact surface		tinned	
Pin dimensions = d	mm		
Solder eyelet Ø = D	mm		
Solder eyelet Ø tolerance	mm		

Product data

IEC: 400 V / 21.5 A / 0.2 - 2.5 mm²
UL: 300 V / 14 A / AWG 26 - 12



For additional articles and information, refer to catalog.weidmueller.com

Note:

- Additional colours on request
- Rated current related to rated cross-section & min. No. of poles.
- Wire end ferrule without plastic collar to DIN 46228/1
- Wire end ferrule with plastic collar to DIN 46228/4
- P on drawing = pitch
- Rated data refer only to the component itself. Clearance and creepage distances to other components are to be designed in accordance with the relevant application standards.

SLS 5.08../180



Dimensioned drawing

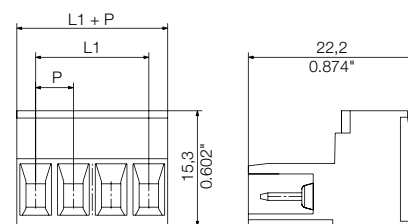

Accessories

Note: Refer to the Accessories chapter for additional accessories.

Strain relief		Order No.
	BLZ 5.08 ZE04 OR BX	1652110000
	BLZ 5.08 ZE04 BK BX	1652130000
	BLZ 5.08 ZE08 OR BX	1652050000
	BLZ 5.08 ZE08 BK BX	1652070000
Coding		
	BLZ/SL KO QR BX	1573010000
	BLZ/SL KO BK BX	1545710000
Screwdriver		
	SDS 0.6X3.5X100	2749340000
	SDIS 0.6X3.5X100	2749810000
Spacer		
	SL AT OR	1598300000
	SL AT SW	1770240000
Mounting block		
	SLA BB11R OR	1604120000
	SLA BB11R SW	1692340000

Ordering data

Solder pin length					
Colour	orange				
Pitch	5.08 mm				
Pol.	L1	(inch)	Qty.	Order No.	
2	5.08	0.200	180	1627090000	
3	10.16	0.400	120	1627100000	
4	15.24	0.600	90	1627110000	
5	20.32	0.800	72	1627120000	
6	25.40	1.000	60	1627130000	
7	30.48	1.200	48	1627140000	
8	35.56	1.400	42	1627150000	
9	40.64	1.600	36	1627160000	
10	45.72	1.800	36	1627170000	
11	50.80	2.000	30	1627180000	
12	55.88	2.200	30	1627190000	

Representative deratings curve

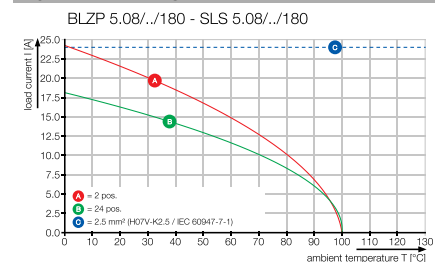

SLS 5.08../180B



Dimensioned drawing

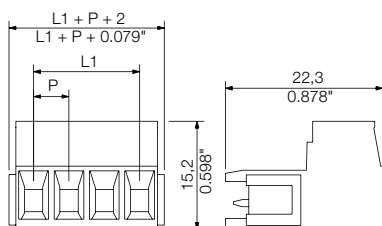

SLS 5.08../180F



Dimensioned drawing

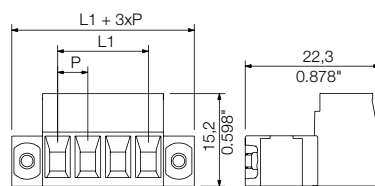

SLS 5.08../180FI



Dimensioned drawing

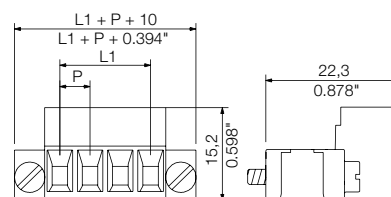

Ordering data

Solder pin length					
Colour					orange
Pitch 5.08 mm					
Pol.	L1	(inch)	Qty.	Order No.	
2	5.08	0.200	150	1627240000	
3	10.16	0.400	108	1627250000	
4	15.24	0.600	84	1627260000	
5	20.32	0.800	66	1627270000	
6	25.40	1.000	54	1627280000	
7	30.48	1.200	48	1627290000	
8	35.56	1.400	42	1627300000	
9	40.64	1.600	36	1627310000	
10	45.72	1.800	30	1627320000	
11	50.80	2.000	30	1627330000	
12	55.88	2.200	24	1627340000	

Ordering data

Solder pin length					
Colour					orange
Pitch 5.08 mm					
Pol.	L1	(inch)	Qty.	Order No.	
2	5.08	0.200	90	1846360000	
3	10.16	0.400	72	1846370000	
4	15.24	0.600	60	1846380000	
5	20.32	0.800	48	1846390000	
6	25.40	1.000	42	1846400000	
7	30.48	1.200	36	1846410000	
8	35.56	1.400	36	1846420000	
9	40.64	1.600	30	1846430000	
10	45.72	1.800	30	1846440000	
11	50.80	2.000	24	1846450000	
12	55.88	2.200	24	1846460000	

Ordering data

Solder pin length					
Colour					orange
Pitch 5.08 mm					
Pol.	L1	(inch)	Qty.	Order No.	
2	5.08	0.200	90	1846210000	
3	10.16	0.400	72	1846220000	
4	15.24	0.600	60	1846230000	
5	20.32	0.800	48	1846240000	
6	25.40	1.000	42	1846250000	
7	30.48	1.200	36	1846260000	
8	35.56	1.400	36	1846270000	
9	40.64	1.600	30	1846280000	
10	45.72	1.800	30	1846290000	
11	50.80	2.000	24	1846300000	
12	55.88	2.200	24	1846310000	

Additional deratings curves

BLZP 5.08../180 - SLS 5.08../180

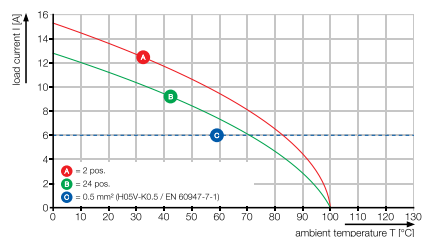

BLL 5.08../180 - SLS 5.08../180

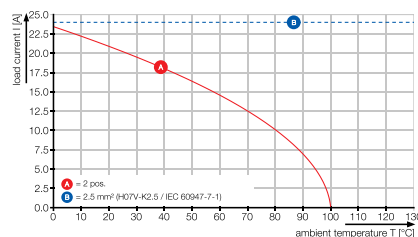

Connectors in 5.08 mm pitch Series BL/SL 5.08

SLS 5.08../180TB RF15



Male plug with clamping yoke screw connection and straight wire outlet. The male plug provides space for labelling and can be coded.

- The clip-on foot makes it easy to attach to the DIN rail (TS15).
- SLS 5.08 F & BLZP 5.08 F for wire-to-wire applications (flying lead assemblies)
- Folded steel clamping yoke accommodates the connected wire and compensates for temperature fluctuations

Technical data

In compliance with IEC 60664-1 / IEC 61984			
Clamping range, max.	mm ²	0.13...3.31	
Solid core H05(07) V-U	mm ²	0.2...2.5	
Stranded H07 V-R			
Flexible H05(07) V-K	mm ²	0.2...2.5	
Flexible with ferrule	mm ²	0.2...2.5	
Ferrule with plastic collar	mm ²	0.2...2.5	
Stripping length	mm	7	
Screwdriver blade	mm	0.6 x 3.5	
According to norm DIN 5264			
Tightening torque range			
Rated current, max.	A	21.5	18
At ambient temperature 20°C 40°C			
For conductor cross-section			
Overvoltage category		III	III II
Pollution severity		3	2 2
Rated voltage	V	250 320 400	
Rated impulse voltage	kV	4 4 4	4
UL / CUL (Use Group)		B C D	D
Rated voltage	V	300	300
Rated current	A	14	10
AWG conductor	AWG	26-12	
CSA (Use Group)		B C D	D
Rated voltage	V	300	300
Rated current	A	15	10
AWG conductor	AWG	26-12	
General data			
Type of insulation material		PBT	
UL 94 flammability rating		V-0	
Contact base material		CuSn	
Material of contact surface		tinned	
Pin dimensions = d	mm		
Solder eyelet Ø = D	mm		
Solder eyelet Ø tolerance	mm		

Product data

IEC: 400 V / 21.5 A / 0.2 - 2.5 mm²
UL: 300 V / 14 A / AWG 26 - 12



For additional articles and information, refer to catalog.weidmuller.com

Note:

- Additional colours on request
- Rated current related to rated cross-section & min. No. of poles.
- Wire end ferrule without plastic collar to DIN 46228/1
- Wire end ferrule with plastic collar to DIN 46228/4
- P on drawing = pitch
- Rated data refer only to the component itself. Clearance and creepage distances to other components are to be designed in accordance with the relevant application standards.

SLS 5.08../180TB RF15



Dimensioned drawing

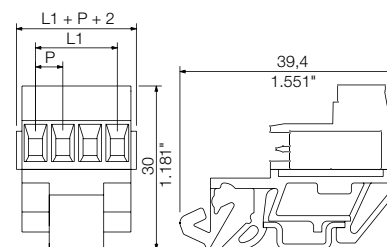

Accessories

Note: Refer to the Accessories chapter for additional accessories.

Coding	Order No.
BLZ/SL KO OR BX	1573010000
BLZ/SL KO BK BX	1545710000
Screwdriver	
SDS 0.6X3.5X100	2749340000
SDIS 0.6X3.5X100	2749810000
Spacer	
SL AT OR	1598300000
SL AT SW	1770240000
Mounting block	
SLA BB8 RH OR	1446060000
SLA BB4 OR	1571720000

Ordering data

Solder pin length				
Colour	orange			
Pitch	5.08 mm			
Pol.	L1	(inch)	Qty.	Order No.
4	15.24	0.600	20	1846050000
6	25.40	1.000	20	1846060000
8	35.56	1.400	10	1846070000
10	45.72	1.800	10	1846080000
12	55.88	2.200	10	1846090000

Representative deratings curve

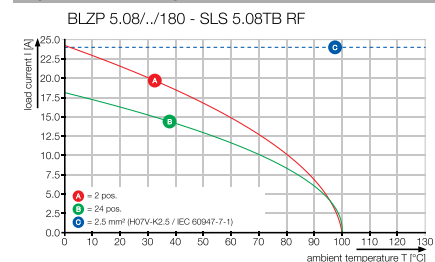

SLS 5.08../180TB KF35

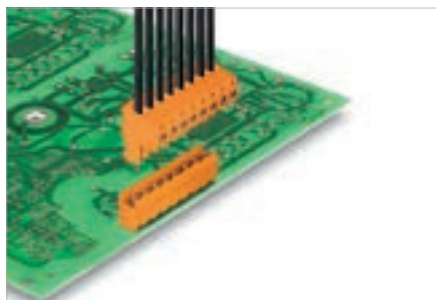

Male plug with clamping yoke screw connection and straight wire outlet. The male plug provides space for labelling and can be coded.

- The clip-on foot makes it easy to attach to the DIN rail (TS32 / TS35).
- SLS 5.08 F & BLZP 5.08 F for wire-to-wire applications (flying lead assemblies)
- Folded steel clamping yoke accommodates the connected wire and compensates for temperature fluctuations

Technical data

In compliance with IEC 60664-1 / IEC 61984			
Clamping range, max.	mm ²	0.13...3.31	
Solid core H05(07) V-U	mm²	0.2...2.5	
Stranded H07 V-R			
Flexible H05(07) V-K	mm ²	0.2...2.5	
Flexible with ferrule	mm ²	0.2...2.5	
Ferrule with plastic collar	mm ²	0.2...2.5	
Stripping length	mm	7	
Screwdriver blade	mm	0.6 x 3.5	
According to norm			
Tightening torque range			
Rated current, max.	A	21.5	18
At ambient temperature 20°C 40°C			
For conductor cross-section			
Overvoltage category		III	III II
Pollution severity		3	2 2
Rated voltage	V	250	320 400
Rated impulse voltage	kV	4	4 4
UL / CUL (Use Group)		B	C D
Rated voltage	V	300	300
Rated current	A	14	10
AWG conductor	AWG	26-12	
CSA (Use Group)		B	C D
Rated voltage	V	300	300
Rated current	A	15	10
AWG conductor	AWG	26-12	
General data			
Type of insulation material		PBT	
UL 94 flammability rating		V-0	
Contact base material		CuSn	
Material of contact surface		tinned	
Pin dimensions = d	mm		
Solder eyelet Ø = D			
Solder eyelet Ø tolerance	mm		

Product data

IEC: 400 V / 21.5 A / 0.2 - 2.5 mm²
UL: 300 V / 14 A / AWG 26 - 12



For additional articles and information, refer to catalog.weidmueller.com

Note:

- Additional colours on request
- Rated current related to rated cross-section & min. No. of poles.
- Wire end ferrule without plastic collar to DIN 46228/1
- Wire end ferrule with plastic collar to DIN 46228/4
- P on drawing = pitch
- Rated data refer only to the component itself. Clearance and creepage distances to other components are to be designed in accordance with the relevant application standards.

SLS 5.08../180TB KF35



Dimensioned drawing

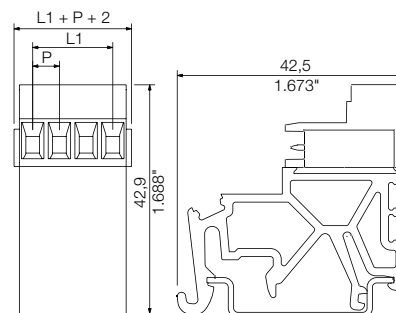

Accessories

Note: Refer to the Accessories chapter for additional accessories.

Coding	Order No.
BLZ/SL KO OR BX	1573010000
BLZ/SL KO BK BX	1545710000
Screwdriver	
SDS 0.6X3.5X100	2749340000
SDIS 0.6X3.5X100	2749810000
Spacer	
SL AT OR	1598300000
SL AT SW	1770240000
Mounting block	
SLA BB8 RH OR	1446060000
SLA BB4 OR	1571720000

Ordering data

Solder pin length					
Colour					orange
Pitch		5.08 mm			
Pol.	L1	(inch)	Qty.	Order No.	
4	15.24	0.600	20	1846130000	
6	25.40	1.000	20	1846140000	
8	35.56	1.400	10	1846150000	
10	45.72	1.800	10	1846160000	
12	55.88	2.200	10	1846170000	

Representative deratings curve

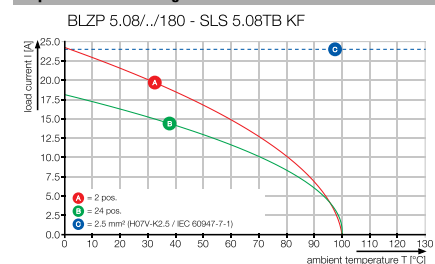

Connectors in 5.08 mm pitch Series BL/SL 5.08

SLF 5.08

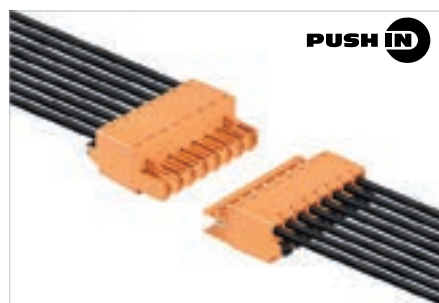

Male plug with PUSH IN wire connection system, with straight wire outlet. The male plugs feature space for labelling and can be coded. Packed in a cardboard box.

- SLF 5.08 DF & BLF 5.08 for wire-to-wire applications in the form of panel or device feed-through)
- SLF 5.08 F & BLF 5.08 F for wire-to-wire applications / flying lead couplings
- SLF 5.08 FI & BLL 5.08 FI for board-to-wire connections (power supply for actuators)

Technical data

In compliance with IEC 60664-1 / IEC 61984			
Clamping range, max.	mm ²	0.13...3.31	
Solid core H05(07) V-U	mm²	0.2...2.5	
Stranded H07 V-R			
Flexible H05(07) V-K	mm ²	0.2...2.5	
Flexible with ferrule	mm ²	0.2...2.5	
Ferrule with plastic collar	mm ²	0.2...2.5	
Stripping length	mm	10	
Screwdriver blade	mm	0.6 x 3.5	
		According to norm DIN 5264	
Tightening torque range			
Rated current, max.	A	25.9	22.5
At ambient temperature	20°C	40°C	
For conductor cross-section	mm ²	2.5	
Overvoltage category		III	II
Pollution severity		3	2
Rated voltage	V	250	320
Rated impulse voltage	kV	4	4
UL / CUL (Use Group)		B	C
Rated voltage	V	300	300
Rated current	A	14	10
AWG conductor	AWG	26-12	
CSA (Use Group)		B	C
Rated voltage	V	300	300
Rated current	A	10	10
AWG conductor	AWG	26-12	
General data			
Type of insulation material		PBT	
UL 94 flammability rating		V-0	
Contact base material		CuSn	
Material of contact surface		tinned	
Pin dimensions = d	mm		
Solder eyelet Ø = D			
Solder eyelet Ø tolerance	mm		

Product data

IEC: 400 V / 25.9 A / 0.2 - 2.5 mm²
UL: 300 V / 14 A / AWG 26 - 12



For additional articles and information, refer to catalog.weidmuller.com

Note:

- Additional colours on request
- Gold-plated contact surfaces on request
- Rated current related to rated cross-section & min. No. of poles.
- Wire end ferrule without plastic collar to DIN 46228/1
- Wire end ferrule with plastic collar to DIN 46228/4
- P on drawing = pitch
- Crimping shape "A" for wire end ferrules with PZ 6/5 crimping tool recommended.
- The test point can only be used as potential-pickup point.

SLF 5.08../180



Dimensioned drawing

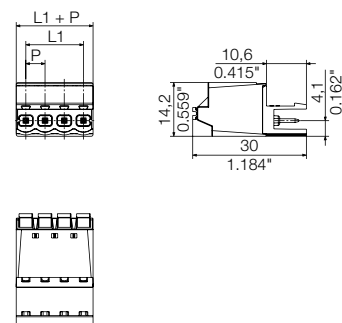

Ordering data

Solder pin length				
Colour	orange			
Pitch	5.08 mm			
Pol.	L1	(inch)	Qty.	Order No.
2	5.08	0.200	180	1335330000
3	10.16	0.400	120	1335340000
4	15.24	0.600	90	1335350000
5	20.32	0.800	72	1335360000
6	25.40	1.000	60	1335370000
7	30.48	1.200	48	1335380000
8	35.56	1.400	42	1335390000
9	40.64	1.600	36	1335400000
10	45.72	1.800	36	1335410000
11	50.80	2.000	30	1335420000
12	55.88	2.200	30	1335430000

Accessories

Note: Refer to the Accessories chapter for additional accessories.

Coding	Order No.
BLZ/SL KO OR BX	1573010000
BLZ/SL KO BK BX	1545710000
Screwdriver	
SDS 0.6X3.5X100	2749340000
SDIS 0.6X3.5X100	2749810000
Wire-end ferrule	
H0,5/14S W	9004590000
H1,0/14S R	9018560000
H1,5/14DS SW	9025240000
H2,5/14DS BL	1333100000

5.08

180°

2.5 mm²

SLF 5.08/./180B



Dimensioned drawing

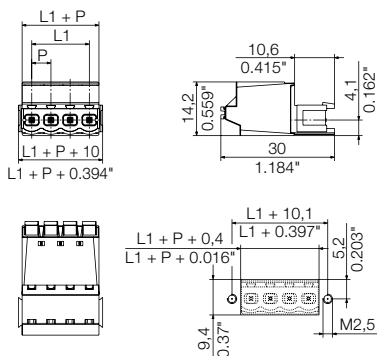

Ordering data

Solder pin length					
Colour					orange
Pitch 5.08 mm					
Pol.	L1	(inch)	Qty.	Order No.	
2	5.08	0.200	150	1335440000	
3	10.16	0.400	108	1335450000	
4	15.24	0.600	78	1335460000	
5	20.32	0.800	66	1335470000	
6	25.40	1.000	54	1335480000	
7	30.48	1.200	48	1335490000	
8	35.56	1.400	42	1335510000	
9	40.64	1.600	36	1335520000	
10	45.72	1.800	30	1335530000	
11	50.80	2.000	30	1335540000	
12	55.88	2.200	24	1335550000	

SLF 5.08/./180F



Dimensioned drawing

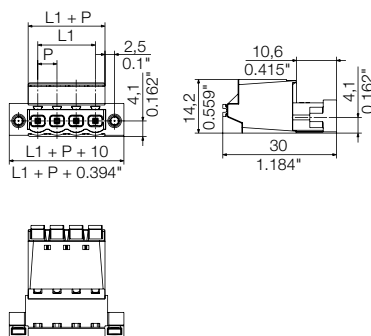

Ordering data

Solder pin length					
Colour					orange
Pitch 5.08 mm					
Pol.	L1	(inch)	Qty.	Order No.	
2	5.08	0.200	90	1335590000	
3	10.16	0.400	72	1335620000	
4	15.24	0.600	60	1335640000	
5	20.32	0.800	54	1335660000	
6	25.40	1.000	42	1335680000	
7	30.48	1.200	42	1335700000	
8	35.56	1.400	36	1335720000	
9	40.64	1.600	30	1335740000	
10	45.72	1.800	30	1335760000	
11	50.80	2.000	24	1335780000	
12	55.88	2.200	24	1335800000	

SLF 5.08/./180FI



Dimensioned drawing

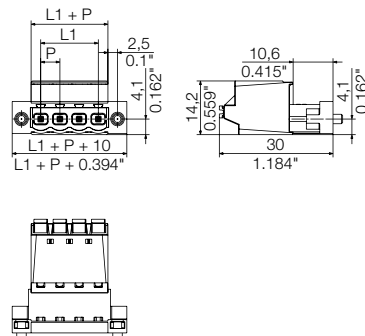

Ordering data

Solder pin length					
Colour					orange
Pitch 5.08 mm					
Pol.	L1	(inch)	Qty.	Order No.	
2	5.08	0.200	90	1336400000	
3	10.16	0.400	72	1336410000	
4	15.24	0.600	60	1336420000	
5	20.32	0.800	54	1336430000	
6	25.40	1.000	42	1336440000	
7	30.48	1.200	42	1336450000	
8	35.56	1.400	36	1336470000	
9	40.64	1.600	30	1336480000	
10	45.72	1.800	30	1336490000	
11	50.80	2.000	24	1336500000	
12	55.88	2.200	24	1336510000	



Connectors in 5.08 mm pitch Series BL/SL 5.08

BLZP 5.08HC../180



The BLZP is the functional extension of the BLZ series. The "P" in the part name stands for a plus in security and performance in processing and use.

- WIRE READY - delivered with terminal points already opened
- Power tools can be used with the globally compatible plus/minus screw head
- Folded steel clamping yoke accommodates the connected wire and compensates for temperature fluctuations
- The integrated wire guard prevents dangerous under-insertion of the wire from occurring.
- Lock and release-lever: tool-less locking and gentle releasing of the connector reduces the mechanical stress on the solder joints.

Technical data

In compliance with IEC 60664-1 / IEC 61984			
Clamping range, max.	mm ²	0.13...4	
Solid core H05(07) V-U	mm²	0.2...4	
Stranded H07 V-R			
Flexible H05(07) V-K	mm ²	0.2...4	
Flexible with ferrule	mm ²	0.2...4	
Ferrule with plastic collar	mm ²	0.2...2.5	
Stripping length	mm	7	
Screwdriver blade	mm	0.6 x 3.5, PH 1, PZ 1	
According to norm			
Tightening torque range			
Rated current, max.	A	23	21
At ambient temperature		20°C	40°C
For conductor cross-section	mm ²	4	
Overvoltage category		III	III II
Pollution severity		3	2 2
Rated voltage	V	250	320 400
Rated impulse voltage	kV	4 4 4	
UL / CUL (Use Group)		B	C D
Rated voltage	V	300	300
Rated current	A	20	10
AWG conductor	AWG	26-12	
CSA (Use Group)		B	C D
Rated voltage	V	300	50 300
Rated current	A	20	20
AWG conductor	AWG	30-12	
General data			
Type of insulation material		PBT	
UL 94 flammability rating		V-0	
Contact base material		Copper alloy	
Material of contact surface		tinned	
Pin dimensions = d	mm		
Solder eyelet Ø = D	mm		
Solder eyelet Ø tolerance	mm		

Product data

IEC: 400 V / 23 A / 0.2 - 4 mm²
UL: 300 V / 20 A / AWG 26 - 12



For additional articles and information, refer to catalog.weidmuller.com

Note:

- Additional colours on request
- Gold-plated contact surfaces on request
- Rated current related to rated cross-section & min. No. of poles.
- Wire end ferrule without plastic collar to DIN 46228/1
- Wire end ferrule with plastic collar to DIN 46228/4
- P on drawing = pitch
- Rated data refer only to the component itself. Clearance and creepage distances to other components are to be designed in accordance with the relevant application standards.

BLZP 5.08HC../180



Dimensioned drawing

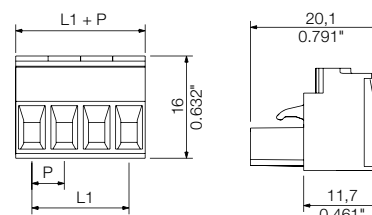

Accessories

Note: Refer to the Accessories chapter for additional accessories.

Strain relief		Order No.
	BLZ 5.08 ZE04 OR BX	1652110000
	BLZ 5.08 ZE04 BK BX	1652130000
	BLZ 5.08 ZE08 OR BX	1652050000
	BLZ 5.08 ZE08 BK BX	1652070000
Coding		
	BLZ/SL KO QR BX	1573010000
	BLZ/SL KO BK BX	1545710000
Screwdriver		
	SDS 0.6X3.5X100	2749340000
	SDIS 0.6X3.5X100	2749810000
	SDK PH1 X 80	2749410000
	SDK PZ1 X 80	2749440000

Ordering data

Solder pin length					
Colour	orange				
Pitch	5.08 mm				
Pol.	L1	(inch)	Qty.	Order No.	
2	5.08	0.200	180	1943580000	
3	10.16	0.400	120	1943590000	
4	15.24	0.600	90	1943600000	
5	20.32	0.800	72	1943610000	
6	25.40	1.000	60	1943620000	
7	30.48	1.200	48	1943630000	
8	35.56	1.400	42	1943640000	
9	40.64	1.600	36	1943650000	
10	45.72	1.800	36	1943660000	
11	50.80	2.000	30	1943670000	
12	55.88	2.200	30	1943680000	

Representative deratings curve

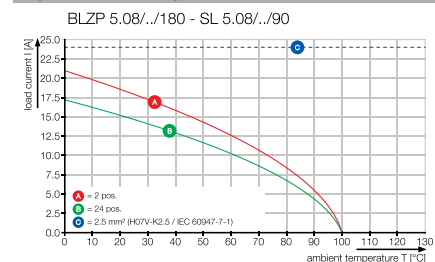

BLZP 5.08HC../180F



Dimensioned drawing

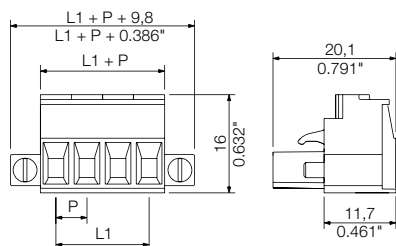

Ordering data

Solder pin length					
Colour					orange
Pitch 5.08 mm					
Pol.	L1	(inch)	Qty.	Order No.	
2	5.08	0.200	90	1944090000	
3	10.16	0.400	72	1944100000	
4	15.24	0.600	60	1944110000	
5	20.32	0.800	48	1944120000	
6	25.40	1.000	42	1944130000	
7	30.48	1.200	36	1944140000	
8	35.56	1.400	36	1944150000	
9	40.64	1.600	30	1944160000	
10	45.72	1.800	30	1944170000	
11	50.80	2.000	24	1944180000	
12	55.88	2.200	24	1944190000	

BLZP 5.08HC../180LR

with release latch



Dimensioned drawing

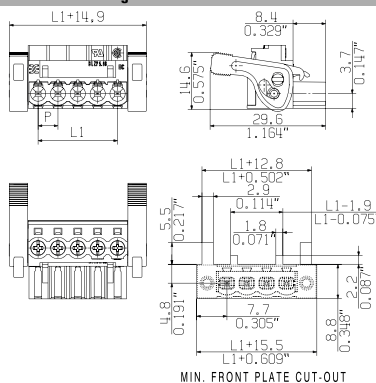

Ordering data

Solder pin length					
Colour					orange
Pitch 5.08 mm					
Pol.	L1	(inch)	Qty.	Order No.	
2	5.08	0.200	90	1944830000	
3	10.16	0.400	72	1944840000	
4	15.24	0.600	60	1944850000	
5	20.32	0.800	48	1944860000	
6	25.40	1.000	42	1944870000	
7	30.48	1.200	36	1944880000	
8	35.56	1.400	36	1944890000	
9	40.64	1.600	30	1944900000	
10	45.72	1.800	30	1944910000	
11	50.80	2.000	24	1944920000	
12	55.88	2.200	24	1944930000	

The 2-in-1 contact

Every pluggable connector covers two contact points and thus must meet two different requirements: First, the wire termination and second, the connection between plug and pin header. Referring to the 5.0x pitch series, Weidmüller offers different wire connection technologies, but one platform contact for the male / female connection since years. This well-designed hybride platform contact ensures a constant quality on a very high level. Hybride means, that we combine metal material featuring different characteristics by welding, in order to devide the contact system into different function zones: Further to the high electric conductance, the current bar is characterized by its hardness, and the tulip contact by its excellent tension properties. The advantage: each function is supported by the most suitable material to reliably and constantly meet the different electrical and mechanical requirements. To put it in a nutshell: Instead of either ... or, it's even both - perfect for the current, and perfect for the force.



Additional deratings curves

BLZP 5.08../180 - SLDV-THR 5.08../180

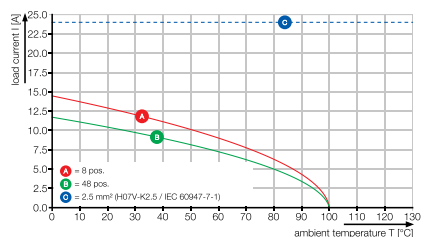

BLZP 5.08../180 - SLD 5.08../180G

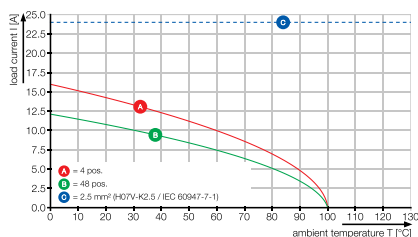

Connectors in 5.08 mm pitch Series BL/SL 5.08

BLZP 5.08HC/./90

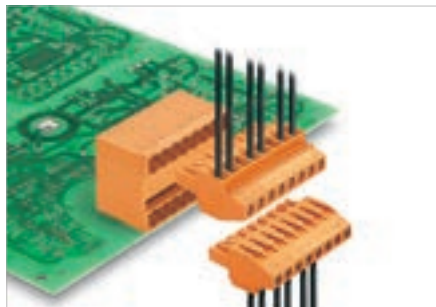

The BLZP is the functional extension of the BLZ series. The "P" in the part name stands for a plus in security and performance in processing and use.

- WIRE READY - delivered with terminal points already opened
- Power tools can be used with the globally compatible plus/minus screw head
- Folded steel clamping yoke accommodates the connected wire and compensates for temperature fluctuations
- The integrated wire guard prevents dangerous under-insertion of the wire from occurring.
- Lock and release-lever: tool-less locking and gentle releasing of the connector reduces the mechanical stress on the solder joints.

Technical data

In compliance with IEC 60664-1 / IEC 61984			
Clamping range, max.	mm ²	0.13...4	
Solid core H05(07) V-U	mm ²	0.2...4	
Stranded H07 V-R			
Flexible H05(07) V-K	mm ²	0.2...4	
Flexible with ferrule	mm ²	0.2...4	
Ferrule with plastic collar	mm ²	0.2...2.5	
Stripping length	mm	7	
Screwdriver blade	mm	0.6 x 3.5, PH 1, PZ 1	
According to norm			
Tightening torque range			
Rated current, max.	A	23	21
At ambient temperature		20°C	40°C
For conductor cross-section	mm ²	4	
Overtoltage category		III	III II
Pollution severity		3	2 2
Rated voltage	V	250	320 400
Rated impulse voltage	kV	4	4 4
UL / CUL (Use Group)		B	C D
Rated voltage	V	300	300
Rated current	A	20	10
AWG conductor	AWG	26-12	
CSA (Use Group)		B	C D
Rated voltage	V	300	50 300
Rated current	A	20	20
AWG conductor	AWG	30-12	
General data			
Type of insulation material		PBT	
UL 94 flammability rating		V-0	
Contact base material		Copper alloy	
Material of contact surface		tinned	
Pin dimensions = d	mm		
Solder eyelet Ø = D			
Solder eyelet Ø tolerance	mm		

Product data

IEC: 400 V / 23 A / 0.2 - 4 mm²
UL: 300 V / 20 A / AWG 26 - 12



For additional articles and information, refer to catalog.weidmueller.com

Note:

- Additional colours on request
- Gold-plated contact surfaces on request
- Rated current related to rated cross-section & min. No. of poles.
- Wire end ferrule without plastic collar to DIN 46228/1
- Wire end ferrule with plastic collar to DIN 46228/4
- P on drawing = pitch
- Rated data refer only to the component itself. Clearance and creepage distances to other components are to be designed in accordance with the relevant application standards.

BLZP 5.08HC/./90



Dimensioned drawing

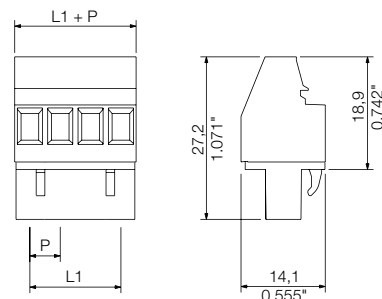

Accessories

Note: Refer to the Accessories chapter for additional accessories.

Coding	Order No.
BLZ/SL KO OR BX	1573010000
BLZ/SL KO BK BX	1545710000
Screwdriver	
SDS 0.6X3.5X100	2749340000
SDIS 0.6X3.5X100	2749810000
SDK PH1 X 80	2749410000
SDK PZ1 X 80	2749440000

Ordering data

Solder pin length					
Colour	orange				
Pitch	5.08 mm				
Pol.	L1	(inch)	Qty.	Order No.	
2	5.08	0.200	180	1948000000	
3	10.16	0.400	120	1948010000	
4	15.24	0.600	90	1948020000	
5	20.32	0.800	72	1948030000	
6	25.40	1.000	60	1948040000	
7	30.48	1.200	48	1948050000	
8	35.56	1.400	42	1948060000	
9	40.64	1.600	36	1948070000	
10	45.72	1.800	36	1948080000	
11	50.80	2.000	30	1948100000	
12	55.88	2.200	30	1948110000	

Representative deratings curve

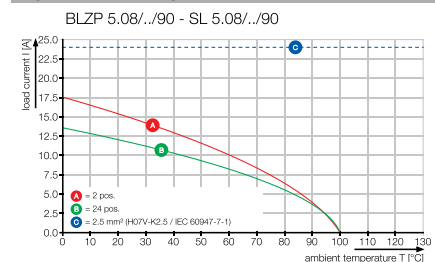

BLZP 5.08HC../90F



Dimensioned drawing

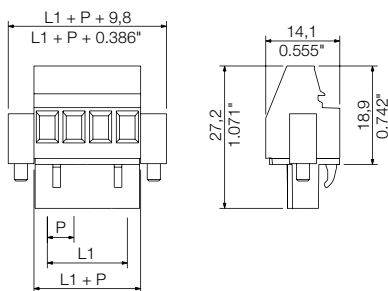

Ordering data

Solder pin length					
Colour					orange
Pitch 5.08 mm					
Pol.	L1	(inch)	Qty.	Order No.	
2	5.08	0.200	90	1949800000	
3	10.16	0.400	72	1949810000	
4	15.24	0.600	60	1949820000	
5	20.32	0.800	48	1949830000	
6	25.40	1.000	42	1949840000	
7	30.48	1.200	36	1949850000	
8	35.56	1.400	36	1949860000	
9	40.64	1.600	30	1949870000	
10	45.72	1.800	30	1949880000	
11	50.80	2.000	24	1949890000	
12	55.88	2.200	24	1949900000	

BLZP 5.08HC../90LR

with release latch



Dimensioned drawing

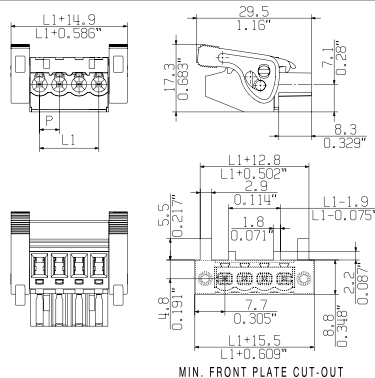

Ordering data

Solder pin length					
Colour					orange
Pitch 5.08 mm					
Pol.	L1	(inch)	Qty.	Order No.	
2	5.08	0.200	90	1087250000	
3	10.16	0.400	72	1087260000	
4	15.24	0.600	60	1087270000	
5	20.32	0.800	48	1087280000	
6	25.40	1.000	42	1087290000	
7	30.48	1.200	36	1087300000	
8	35.56	1.400	36	1087310000	
9	40.64	1.600	30	1087320000	
10	45.72	1.800	30	1087330000	
11	50.80	2.000	24	1087340000	
12	55.88	2.200	24	1087350000	

The 2-in-1 contact

Every pluggable connector covers two contact points and thus must meet two different requirements: First, the wire termination and second, the connection between plug and pin header. Referring to the 5.0x pitch series, Weidmüller offers different wire connection technologies, but one platform contact for the male / female connection since years. This well-designed hybride platform contact ensures a constant quality on a very high level. Hybride means, that we combine metal material featuring different characteristics by welding, in order to devide the contact system into different function zones: Further to the high electric conductance, the current bar is characterized by its hardness, and the tulip contact by its excellent tension properties. The advantage: each function is supported by the most suitable material to reliably and constantly meet the different electrical and mechanical requirements. To put it in a nutshell: Instead of either ... or, it 's even both - perfect for the current, and perfect for the force.



Connectors in 5.08 mm pitch Series BL/SL 5.08

BLZP 5.08HC../270

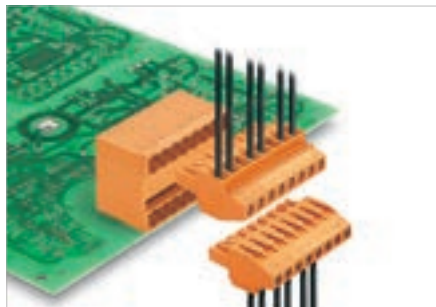

The BLZP is the functional extension of the BLZ series. The "P" in the part name stands for a plus in security and performance in processing and use.

- WIRE READY - delivered with terminal points already opened
- Power tools can be used with the globally compatible plus/minus screw head
- Folded steel clamping yoke accommodates the connected wire and compensates for temperature fluctuations
- The integrated wire guard prevents dangerous under-insertion of the wire from occurring.
- Lock and release-lever: tool-less locking and gentle releasing of the connector reduces the mechanical stress on the solder joints.

Technical data

In compliance with IEC 60664-1 / IEC 61984			
Clamping range, max.	mm ²	0.13...4	
Solid core H05(07) V-U	mm ²	0.2...4	
Stranded H07 V-R			
Flexible H05(07) V-K	mm ²	0.2...4	
Flexible with ferrule	mm ²	0.2...4	
Ferrule with plastic collar	mm ²	0.2...2.5	
Stripping length	mm	7	
Screwdriver blade	mm	0.6 x 3.5, PH 1, PZ 1	
According to norm			
Tightening torque range			
Rated current, max.	A	23	21
At ambient temperature		20°C	40°C
For conductor cross-section	mm ²	4	
Overtension category		III	III II
Pollution severity		3	2 2
Rated voltage	V	250	320 400
Rated impulse voltage	kV	4	4 4
UL / CUL (Use Group)		B	C D
Rated voltage	V	300	300
Rated current	A	20	10
AWG conductor	AWG	26-12	
CSA (Use Group)		B	C D
Rated voltage	V	300	50 300
Rated current	A	20	20
AWG conductor	AWG	30-12	
General data			
Type of insulation material		PBT	
UL 94 flammability rating		V-0	
Contact base material		Copper alloy	
Material of contact surface		tinned	
Pin dimensions = d	mm		
Solder eyelet Ø = D			
Solder eyelet Ø tolerance	mm		

Product data

IEC: 400 V / 23 A / 0.2 - 4 mm²
UL: 300 V / 20 A / AWG 26 - 12



For additional articles and information, refer to catalog.weidmueller.com

Note:

- Additional colours on request
- Gold-plated contact surfaces on request
- Rated current related to rated cross-section & min. No. of poles.
- Wire end ferrule without plastic collar to DIN 46228/1
- Wire end ferrule with plastic collar to DIN 46228/4
- P on drawing = pitch
- Rated data refer only to the component itself. Clearance and creepage distances to other components are to be designed in accordance with the relevant application standards.

BLZP 5.08HC../270



Dimensioned drawing

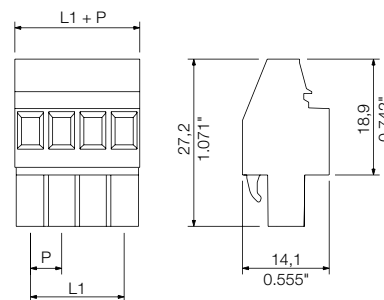

Accessories

Note: Refer to the Accessories chapter for additional accessories.

Coding	Order No.
BLZ/SL KO OR BX	1573010000
BLZ/SL KO BK BX	1545710000
Screwdriver	
SDS 0.6X3.5X100	2749340000
SDIS 0.6X3.5X100	2749810000
SDK PH1 X 80	2749410000
SDK PZ1 X 80	2749440000

Ordering data

Solder pin length					
Colour	orange				
Pitch	5.08 mm				
Pol.	L1	(inch)	Qty.	Order No.	
2	5.08	0.200	180	1948790000	
3	10.16	0.400	120	1948800000	
4	15.24	0.600	90	1948810000	
5	20.32	0.800	72	1948820000	
6	25.40	1.000	60	1948830000	
7	30.48	1.200	48	1948840000	
8	35.56	1.400	42	1948850000	
9	40.64	1.600	36	1948860000	
10	45.72	1.800	36	1948870000	
11	50.80	2.000	30	1948880000	
12	55.88	2.200	30	1948890000	

Representative deratings curve

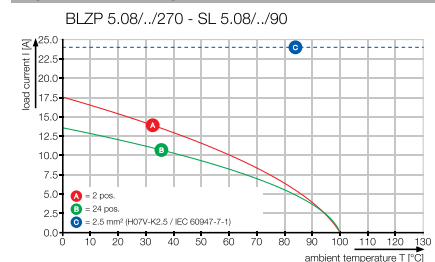

L

5.08

270°

4 mm²

BLZP 5.08HC/././270F



Dimensioned drawing

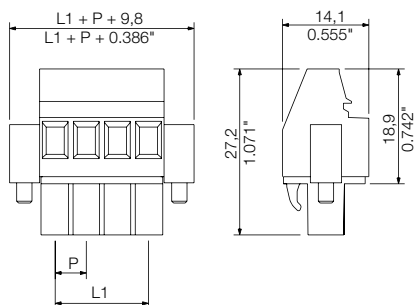

Ordering data

Solder pin length					
Colour		orange			
Pitch 5.08 mm					
Pol.	L1	(inch)	Qty.	Order No.	
2	5.08	0.200	90	1950310000	
3	10.16	0.400	72	1950320000	
4	15.24	0.600	60	1950330000	
5	20.32	0.800	48	1950340000	
6	25.40	1.000	42	1950350000	
7	30.48	1.200	36	1950360000	
8	35.56	1.400	36	1950370000	
9	40.64	1.600	30	1950380000	
10	45.72	1.800	30	1950390000	
11	50.80	2.000	24	1950400000	
12	55.88	2.200	24	1950410000	

BLZP 5.08HC/././270LR

with release latch



Dimensioned drawing

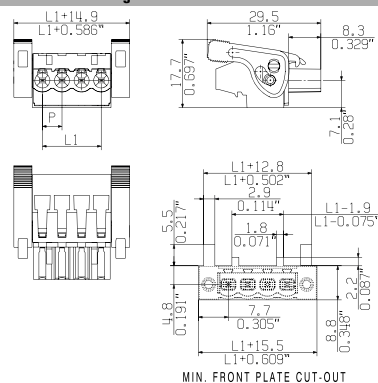

Ordering data

Solder pin length					
Colour		orange			
Pitch 5.08 mm					
Pol.	L1	(inch)	Qty.	Order No.	
2	5.08	0.200	90	1947530000	
3	10.16	0.400	72	1947540000	
4	15.24	0.600	60	1947550000	
5	20.32	0.800	48	1947560000	
6	25.40	1.000	42	1947570000	
7	30.48	1.200	36	1947580000	
8	35.56	1.400	36	1947590000	
9	40.64	1.600	30	1947600000	
10	45.72	1.800	30	1947610000	
11	50.80	2.000	24	1947620000	
12	55.88	2.200	24	1947630000	

The 2-in-1 contact

Every pluggable connector covers two contact points and thus must meet two different requirements: First, the wire termination and second, the connection between plug and pin header. Referring to the 5.0x pitch series, Weidmüller offers different wire connection technologies, but one platform contact for the male / female connection since years. This well-designed hybride platform contact ensures a constant quality on a very high level. Hybride means, that we combine metal material featuring different characteristics by welding, in order to devide the contact system into different function zones: Further to the high electric conductance, the current bar is characterized by its hardness, and the tulip contact by its excellent tension properties. The advantage: each function is supported by the most suitable material to reliably and constantly meet the different electrical and mechanical requirements. To put it in a nutshell: Instead of either ... or, it 's even both - perfect for the current, and perfect for the force.



Connectors in 5.08 mm pitch Series BL/SL 5.08

BLZP 5.08HC../225

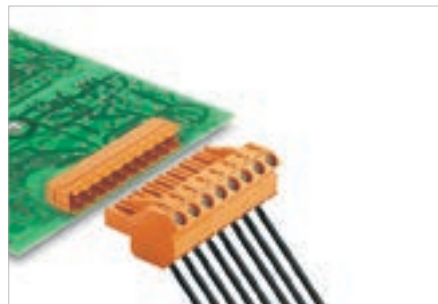

The BLZP is the functional extension of the BLZ series. The "P" in the part name stands for a plus in security and performance in processing and use.

- WIRE READY - delivered with terminal points already opened
- Power tools can be used with the globally compatible plus/minus screw head
- Folded steel clamping yoke accommodates the connected wire and compensates for temperature fluctuations
- The integrated wire guard prevents dangerous under-insertion of the wire from occurring.
- Lock and release-lever: tool-less locking and gentle releasing of the connector reduces the mechanical stress on the solder joints.

Technical data

In compliance with IEC 60664-1 / IEC 61984			
Clamping range, max.	mm ²	0.13...4	
Solid core H05(07) V-U	mm ²	0.2...4	
Stranded H07 V-R			
Flexible H05(07) V-K	mm ²	0.2...4	
Flexible with ferrule	mm ²	0.2...4	
Ferrule with plastic collar	mm ²	0.2...2.5	
Stripping length	mm	7	
Screwdriver blade	mm	0.6 x 3.5, PH 1, PZ 1	
According to norm			
Tightening torque range			
Rated current, max.	A	17.5	14
At ambient temperature		20°C	40°C
For conductor cross-section	mm ²	4	
Overtoltage category		III	III II
Pollution severity		3	2 2
Rated voltage	V	250	320 400
Rated impulse voltage	kV	4	4 4
UL / CUL (Use Group)		B	C D
Rated voltage	V	300	300
Rated current	A	15	10
AWG conductor	AWG	26-12	
CSA (Use Group)		B	C D
Rated voltage	V	300	50 300
Rated current	A	15	15
AWG conductor	AWG	30-12	
General data			
Type of insulation material		PBT	
UL 94 flammability rating		V-0	
Contact base material		Copper alloy	
Material of contact surface		tinned	
Pin dimensions = d	mm		
Solder eyelet Ø = D	mm		
Solder eyelet Ø tolerance	mm		

Product data

IEC: 400 V / 17.5 A / 0.2 - 4 mm²
UL: 300 V / 15 A / AWG 26 - 12



For additional articles and information, refer to catalog.weidmuller.com

Note:

- Additional colours on request
- Gold-plated contact surfaces on request
- Rated current related to rated cross-section & min. No. of poles.
- Wire end ferrule without plastic collar to DIN 46228/1
- Wire end ferrule with plastic collar to DIN 46228/4
- P on drawing = pitch
- Rated data refer only to the component itself. Clearance and creepage distances to other components are to be designed in accordance with the relevant application standards.

BLZP 5.08HC../225



Dimensioned drawing

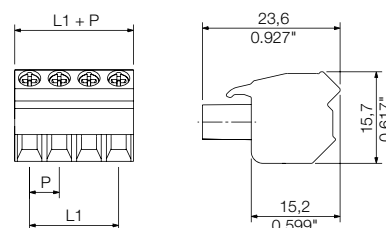

Accessories

Note: Refer to the Accessories chapter for additional accessories.

Coding	Order No.
BLZ/SL KO OR BX	1573010000
BLZ/SL KO BK BX	1545710000
Screwdriver	
SDS 0.6X3.5X100	2749340000
SDIS 0.6X3.5X100	2749810000
SDK PH1 X 80	2749410000
SDK PZ1 X 80	2749440000

Ordering data

Solder pin length				
Colour	orange			
Pitch	5.08 mm			
Pol.	L1	(inch)	Qty.	Order No.
2	5.08	0.200	180	1946250000
3	10.16	0.400	120	1946260000
4	15.24	0.600	90	1946270000
5	20.32	0.800	72	1946280000
6	25.40	1.000	60	1946290000
7	30.48	1.200	48	1946300000
8	35.56	1.400	42	1946310000
9	40.64	1.600	36	1946320000
10	45.72	1.800	36	1946330000
11	50.80	2.000	30	1946340000
12	55.88	2.200	30	1946350000

Representative deratings curve

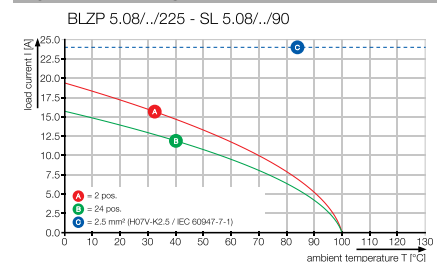

BLZP 5.08HC../225B



Dimensioned drawing

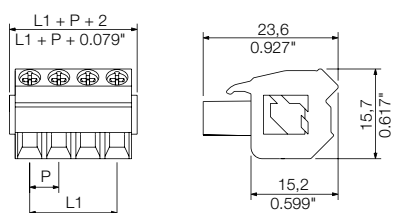

Ordering data

Solder pin length				
Colour				orange
Pitch		5.08 mm		
Pol.	L1	(inch)	Qty.	Order No.
2	5.08	0.200	150	1945750000
3	10.16	0.400	108	1945760000
4	15.24	0.600	78	1945770000
5	20.32	0.800	66	1945780000
6	25.40	1.000	54	1945790000
7	30.48	1.200	48	1945800000
8	35.56	1.400	42	1945810000
9	40.64	1.600	36	1945820000
10	45.72	1.800	30	1945830000
11	50.80	2.000	30	1945840000
12	55.88	2.200	24	1945850000

The 2-in-1 contact

Every pluggable connector covers two contact points and thus must meet two different requirements: First, the wire termination and second, the connection between plug and pin header. Referring to the 5.0x pitch series, Weidmüller offers different wire connection technologies, but one platform contact for the male / female connection since years. This well-designed hybrid platform contact ensures a constant quality on a very high level.

Hybrid means, that we combine metal material featuring different characteristics by welding, in order to divide the contact system into different function zones: Further to the high electric conductance, the current bar is characterized by its hardness, and the tulip contact by its excellent tension properties. The advantage: each function is supported by the most suitable material to reliably and constantly meet the different electrical and mechanical requirements. To put it in a nutshell: Instead of either ... or, it's even both - perfect for the current, and perfect for the force.



Connectors in 5.08 mm pitch Series BL/SL 5.08

BLT 5.08HC../180

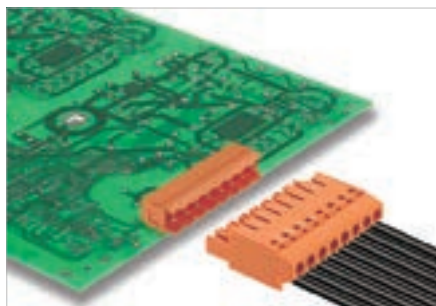

The BLT is currently the most compact TOP connection of its type available in 5.08 mm pitch.

- The BLT's "pull effect" ensures that the connected wire is pulled in to the clamping point.
- The extra flat shape allows for dense component assembly.
- The specialist for cramped installations
- The screw connect and the cable entry are located on the same side of the connector.
- Lock and release-lever: tool-less locking and gentle releasing of the connector reduces the mechanical stress on the solder joints.

Technical data

In compliance with IEC 60664-1 / IEC 61984			
Clamping range, max.	mm ²	0.13...2.5	
Solid core H05(07) V-U	mm ²	0.2...2.5	
Stranded H07 V-R			
Flexible H05(07) V-K	mm ²	0.2...1.5	
Flexible with ferrule	mm ²	0.2...1.5	
Ferrule with plastic collar	mm ²	0.2...1.5	
Stripping length	mm	13	
Screwdriver blade	mm	0.6 x 3.5	
		According to norm DIN 5264	
Tightening torque range			
Rated current, max.	A	27	24
At ambient temperature		20°C	40°C
For conductor cross-section	mm ²	2.5	
Overvoltage category		III	II
Pollution severity		3	2
Rated voltage	V	250	320
Rated impulse voltage	kV	4	4
UL / CUL (Use Group)		B	C
Rated voltage	V	300	300
Rated current	A	17	10
AWG conductor	AWG	26-14	
CSA (Use Group)		B	C
Rated voltage	V	300	300
Rated current	A	15	15
AWG conductor	AWG	26-14	
General data			
Type of insulation material		PBT	
UL 94 flammability rating		V-0	
Contact base material		CuSn	
Material of contact surface		tinned	
Pin dimensions = d	mm		
Solder eyelet Ø = D	mm		
Solder eyelet Ø tolerance	mm		

Product data

IEC: 400 V / 27 A / 0.2 - 2.5 mm²
UL: 300 V / 17 A / AWG 26 - 14



For additional articles and information, refer to catalog.weidmuller.com

Note:

- Additional colours on request
- Gold-plated contact surfaces on request
- Rated current related to rated cross-section & min. No. of poles.
- Wire end ferrule without plastic collar to DIN 46228/1
- Wire end ferrule with plastic collar to DIN 46228/4
- Crimp form A for wire end ferrules with PZ 6/5 crimping tool are recommended for the largest cable sizes.
- P on drawing = pitch
- Rated data refer only to the component itself. Clearance and creepage distances to other components are to be designed in accordance with the relevant application standards.

BLT 5.08HC../180



Dimensioned drawing

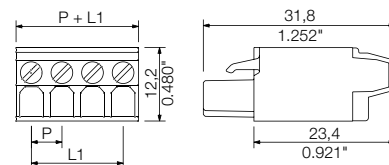

Accessories

Note: Refer to the Accessories chapter for additional accessories.

Strain relief		Order No.
	BLAT ZE04 OR BX	1577980000
	BLAT ZE08 OR BX	1578010000
Coding		
	BLZ/SL KO OR BX	1573010000
	BLZ/SL KO BK BX	1545710000
Screwdriver		
	SDS 0.6X3.5X100	2749340000
	SDIS 0.6X3.5X100	2749810000

Ordering data

Solder pin length					
Colour	orange				
Pitch	5.08 mm				
Pol.	L1	(inch)	Qty.	Order No.	
2	5.08	0.200	180	1499560000	
3	10.16	0.400	120	1499660000	
4	15.24	0.600	90	1499760000	
5	20.32	0.800	72	1499860000	
6	25.40	1.000	60	1499960000	
7	30.48	1.200	48	1500060000	
8	35.56	1.400	42	1500160000	
9	40.64	1.600	36	1500260000	
10	45.72	1.800	36	1500360000	
11	50.80	2.000	30	1500460000	
12	55.88	2.200	30	1500560000	

Representative deratings curve

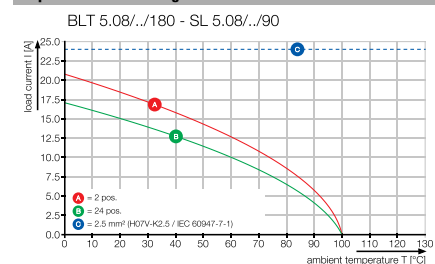

BLT 5.08HC../180F



Dimensioned drawing

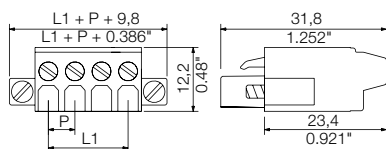

Ordering data

Solder pin length					
Colour					orange
Pitch 5.08 mm					
Pol.	L1	(inch)	Qty.	Order No.	
2	5.08	0.200	90	1843990000	
3	10.16	0.400	72	1844000000	
4	15.24	0.600	60	1844010000	
5	20.32	0.800	48	1844020000	
6	25.40	1.000	42	1844030000	
7	30.48	1.200	36	1844040000	
8	35.56	1.400	36	1844050000	
9	40.64	1.600	30	1844060000	
10	45.72	1.800	30	1844070000	
11	50.80	2.000	24	1844080000	
12	55.88	2.200	24	1844090000	

BLT 5.08HC../180LR

with release bar



Dimensioned drawing

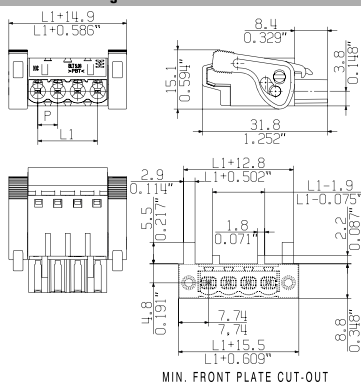

Ordering data

Solder pin length					
Colour					orange
Pitch 5.08 mm					
Pol.	L1	(inch)	Qty.	Order No.	
2	5.08	0.200	90	1890220000	
3	10.16	0.400	72	1890230000	
4	15.24	0.600	60	1890240000	
5	20.32	0.800	48	1890250000	
6	25.40	1.000	42	1890260000	
7	30.48	1.200	36	1890270000	
8	35.56	1.400	36	1890280000	
9	40.64	1.600	30	1890290000	
10	45.72	1.800	30	1890300000	
11	50.80	2.000	24	1890310000	
12	55.88	2.200	24	1890320000	

The 2-in-1 contact

Every pluggable connector covers two contact points and thus must meet two different requirements: First, the wire termination and second, the connection between plug and pin header. Referring to the 5.0x pitch series, Weidmüller offers different wire connection technologies, but one platform contact for the male / female connection since years. This well-designed hybride platform contact ensures a constant quality on a very high level. Hybride means, that we combine metal material featuring different characteristics by welding, in order to devide the contact system into different function zones: Further to the high electric conductance, the current bar is characterized by its hardness, and the tulip contact by its excellent tension properties. The advantage: each function is supported by the most suitable material to reliably and constantly meet the different electrical and mechanical requirements. To put it in a nutshell: Instead of either ... or, it's even both - perfect for the current, and perfect for the force.



Connectors in 5.08 mm pitch Series BL/SL 5.08

BLZ 5.08/./180 QV2

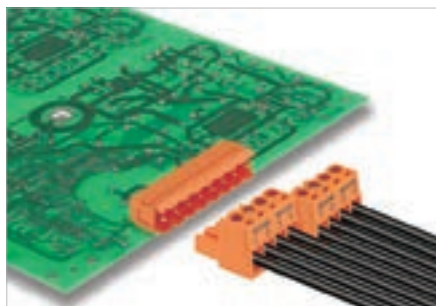

Female plug with clamping yoke screw connection and internal cross-connections for the 1-2 & 3-4 wire connections; with straight wire outlet.

- Bus signals of up to 32 A can be safely looped through
- This permits an interruption-free decoupling of individual modules from the network
- Folded steel clamping yoke accommodates the connected wire and compensates for temperature fluctuations
- The cross-connections are clearly marked

Technical data

In compliance with IEC 60664-1 / IEC 61984			
Clamping range, max.	mm ²	0.13...4	
Solid core H05(07) V-U	mm²	0.2...2.5	
Stranded H07 V-R			
Flexible H05(07) V-K	mm ²	0.2...4	
Flexible with ferrule	mm ²	0.2...2.5	
Ferrule with plastic collar	mm ²	0.2...2.5	
Stripping length	mm	7	
Screwdriver blade	mm	0.6 x 3.5	
According to norm		DIN 5264	
Tightening torque range			
Rated current, max.		17.5	15
At ambient temperature		20°C	40°C
For conductor cross-section	mm ²	2.5	
Overvoltage category		III	III II
Pollution severity		3	2 2
Rated voltage	V	250	320 400
Rated impulse voltage	kV	4	4 4
UL / CUL (Use Group)		B	C D
Rated voltage	V	300	300
Rated current	A	15	10
AWG conductor	AWG	30-12	
CSA (Use Group)		B	C D
Rated voltage	V	300	300
Rated current	A	15	10
AWG conductor	AWG	30-12	
General data			
Type of insulation material		PBT	
UL 94 flammability rating		V-0	
Contact base material		Copper alloy	
Material of contact surface		tinned	
Pin dimensions = d	mm		
Solder eyelet Ø = D	mm		
Solder eyelet Ø tolerance	mm		

Product data

IEC: 400 V / 17.5 A / 0.2 - 4 mm²
UL: 300 V / 15 A / AWG 30 - 12



For additional articles and information, refer to catalog.weidmueller.com

Note:

- Additional colours on request
- Gold-plated contact surfaces on request
- Rated current related to rated cross-section & min. No. of poles.
- Wire end ferrule without plastic collar to DIN 46228/1
- Wire end ferrule with plastic collar to DIN 46228/4
- P on drawing = pitch
- Rated data refer only to the component itself. Clearance and creepage distances to other components are to be designed in accordance with the relevant application standards.

BLZ 5.08/./180 QV2

with cross-connection



Dimensioned drawing

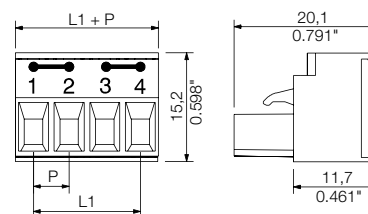

Accessories

Note: Refer to the Accessories chapter for additional accessories.

Strain relief		Order No.
	BLZ 5.08 ZE04 OR BX	1652110000
	BLZ 5.08 ZE04 BK BX	1652130000
	BLZ 5.08 ZE08 OR BX	1652050000
	BLZ 5.08 ZE08 BK BX	1652070000
Coding		
	BLZ/SL KO QR BX	1573010000
	BLZ/SL KO BK BX	1545710000
Screwdriver		
	SDS 0.6X3.5X100	2749340000
	SDIS 0.6X3.5X100	2749810000

Ordering data

Solder pin length					
Colour	orange				
Pitch	5.08 mm				
Pol.	L1	(inch)	Qty.	Order No.	
4	15.24	0.600	90	1839770000	

Representative deratings curve

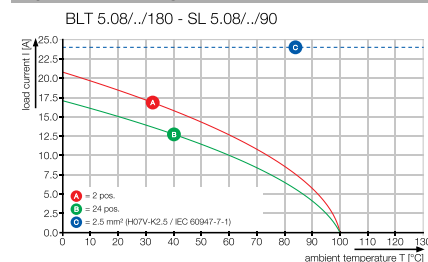

L

5.08

180°

1.5 mm²

BLZ 5.08/./180F QV2

with cross-connection



Dimensioned drawing

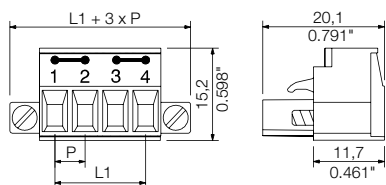

Ordering data

Solder pin length					
Colour					orange
Pitch 5.08 mm					
Pol.	L1	(inch)	Qty.	Order No.	
4	15.24	0.600	60	1846870000	

Examples of applications

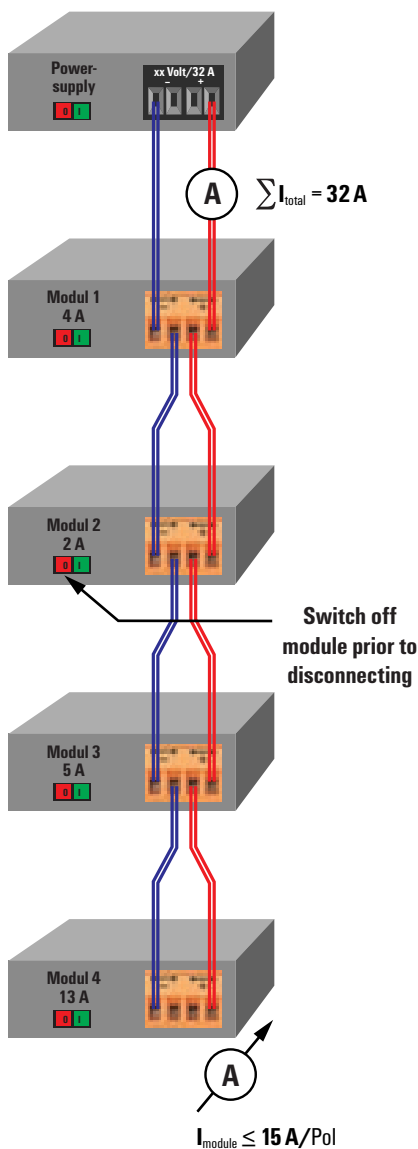

32 A maximum bus current
15 A maximum module current

The 2-in-1 contact

Every pluggable connector covers two contact points and thus must meet two different requirements: First, the wire termination and second, the connection between plug and pin header. Referring to the 5.0x pitch series, Weidmüller offers different wire connection technologies, but one platform contact for the male / female connection since years. This well-designed hybride platform contact ensures a constant quality on a very high level. Hybride means, that we combine metal material featuring different characteristics by welding, in order to divide the contact system into different function zones: Further to the high electric conductance, the current bar is characterized by its hardness, and the tulip contact by its excellent tension properties. The advantage: each function is supported by the most suitable material to reliably and constantly meet the different electrical and mechanical requirements. To put it in a nutshell: Instead of either ... or, it 's even both - perfect for the current, and perfect for the force.



Connectors in 5.08 mm pitch Series BL/SL 5.08

BLF 5.08HC../180

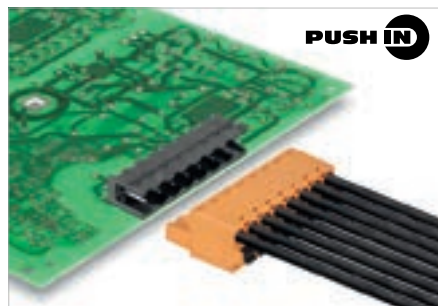

PUSH IN - Weidmüller's innovative connection system simplifies and accelerates the wire connection process.

- Solid wires and stranded wires with ferrules need only to be inserted and they are ready.
- The actuator must be used when connecting stranded wires without ferrules.
- Intuitive handling - since the wire-entry area and handling area are clearly separated.
- User-friendly handling with rounded outer edges and large, no-slip push buttons.
- Lock and release lever: tool-less locking and a gentle releasing of the connector reduces the mechanical stress to the solder joints.

Technical data

In compliance with IEC 60664-1 / IEC 61984			
Clamping range, max.	mm ²	0.13...3.31	
Solid core H05(07) V-U	mm ²	0.2...2.5	
Stranded H07 V-R			
Flexible H05(07) V-K	mm ²	0.2...2.5	
Flexible with ferrule	mm ²	0.25...2.5	
Ferrule with plastic collar	mm ²	0.25...2.5	
Stripping length	mm	10	
Screwdriver blade	mm	0.6 x 3.5	
		According to norm DIN 5264	
Tightening torque range			
Rated current, max.	A	24	21
At ambient temperature		20°C	40°C
For conductor cross-section	mm ²	2.5	
Overvoltage category		III	III II
Pollution severity		3	2 2
Rated voltage	V	250	320 400
Rated impulse voltage	kV	4	4 4
UL / CUL (Use Group)		B	C D
Rated voltage	V	300	300
Rated current	A	18.5	10
AWG conductor	AWG	26-12	
CSA (Use Group)		B	C D
Rated voltage	V	300	300
Rated current	A		10
AWG conductor	AWG	26-12	
General data			
Type of insulation material		PBT	
UL 94 flammability rating		V-0	
Contact base material		CuSn	
Material of contact surface		tinned	
Pin dimensions = d	mm		
Solder eyelet Ø = D	mm		
Solder eyelet Ø tolerance	mm		

Product data

IEC: 400 V / 24 A / 0.2 - 2.5 mm²
UL: 300 V / 18.5 A / AWG 26 - 12



For additional articles and information, refer to catalog.weidmueller.com

Note:

- Additional colours on request
- Gold-plated contact surfaces on request
- Rated current related to rated cross-section & min. No. of poles.
- Wire end ferrule without plastic collar to DIN 46228/1
- Wire end ferrule with plastic collar to DIN 46228/4
- P on drawing = pitch
- Crimping shape "A" for wire end ferrules with PZ 6/5 crimping tool recommended.
- The test point can only be used as potential-pickup point.

BLF 5.08HC../180



Dimensioned drawing

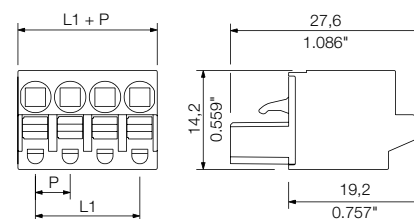

Accessories

Note: Refer to the Accessories chapter for additional accessories.

Coding	Order No.
BLZ/SL KO OR BX	1573010000
BLZ/SL KO BK BX	1545710000
Screwdriver	
SDS 0.6X3.5X100	2749340000
SDIS 0.6X3.5X100	2749810000
Wire-end ferrule	
H0,5/14S W	9004590000
H1,0/14S R	9018560000
H1,5/14DS SW	9025240000
H2,5/14DS BL	1333100000

Ordering data

Solder pin length				
Colour	orange			
Pitch	5.08 mm			
Pol.	L1	(inch)	Qty.	Order No.
2	5.08	0.200	180	1013680000
3	10.16	0.400	120	1013690000
4	15.24	0.600	90	1013710000
5	20.32	0.800	72	1013720000
6	25.40	1.000	60	1013730000
7	30.48	1.200	48	1013740000
8	35.56	1.400	42	1013750000
9	40.64	1.600	36	1013760000
10	45.72	1.800	36	1013770000
11	50.80	2.000	30	1013780000
12	55.88	2.200	30	1013790000

Representative deratings curve

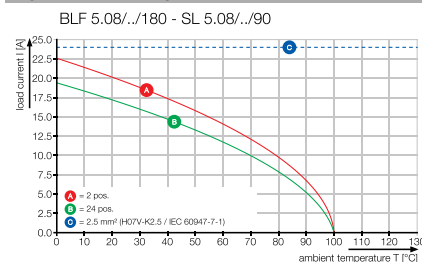

BLF 5.08HC../180F



Dimensioned drawing

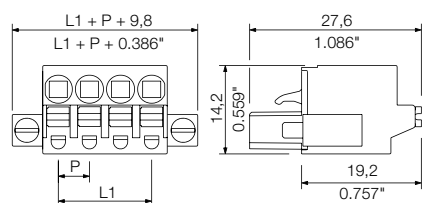

Ordering data

Solder pin length					
Colour					orange
Pitch 5.08 mm					
Pol.	L1	(inch)	Qty.	Order No.	
2	5.08	0.200	90	1013070000	
3	10.16	0.400	72	1013090000	
4	15.24	0.600	60	1013110000	
5	20.32	0.800	48	1013120000	
6	25.40	1.000	42	1013130000	
7	30.48	1.200	36	1013140000	
8	35.56	1.400	36	1013150000	
9	40.64	1.600	30	1013160000	
10	45.72	1.800	30	1013170000	
11	50.80	2.000	24	1013180000	
12	55.88	2.200	24	1013190000	

BLF 5.08HC../180LR

with release latch



Dimensioned drawing

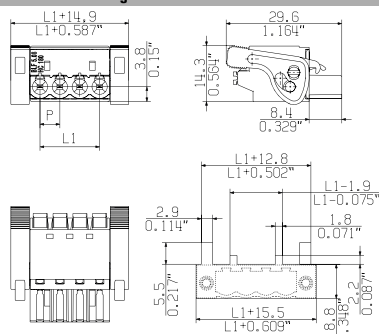

MIN. FRONT PLATE CUT-OUT

Ordering data

Solder pin length					
Colour					orange
Pitch 5.08 mm					
Pol.	L1	(inch)	Qty.	Order No.	
2	5.08	0.200	90	1014370000	
3	10.16	0.400	72	1014380000	
4	15.24	0.600	60	1014390000	
5	20.32	0.800	48	1014410000	
6	25.40	1.000	42	1014420000	
7	30.48	1.200	36	1014430000	
8	35.56	1.400	36	1014440000	
9	40.64	1.600	30	1014450000	
10	45.72	1.800	30	1014460000	
11	50.80	2.000	24	1014470000	
12	55.88	2.200	24	1014480000	

PUSH IN connection technology

PUSH IN connection technology reduces the wiring efforts especially for solid wires and wires with ferrule to a minimum. These connectors are self-explanatory and enable tool-less handling. The contact element made of stainless steel ensures a vibration proof, maintenance free wire termination. The established principle "STEEL FOR THE FORCE, COPPER FOR THE CURRENT" by Weidmüller offers both, maximum conductor clamping forces, as well as minimum power loss at the same time.



The 2-in-1 contact

Every pluggable connector covers two different requirements: First, the wire termination and second, the connection between plug and pin header. Referring to the 5.0x pitch series, Weidmüller offers different wire connection technologies, but one platform contact for the male / female connection since years. This well-designed hybride platform contact ensures a constant quality on a very high level. Hybride means, that we combine metal material featuring different characteristics by welding, in order to divide the contact system into different function zones: Further to the high electric conductance, the current bar is characterized by its hardness, and the tulip contact by its excellent tension properties. The advantage: each function is supported by the most suitable material to reliably and constantly meet the different electrical and mechanical requirements. To put it in a nutshell: Instead of either ... or, it's even both - perfect for the current, and perfect for the force.



Connectors in 5.08 mm pitch Series BL/SL 5.08

BLF 5.08HC../90

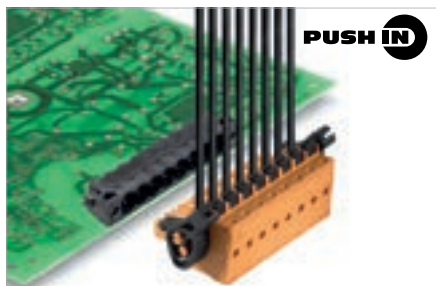

PUSH IN - Weidmüller's innovative connection system simplifies and accelerates the wire connection process.

- Solid wires and stranded wires with ferrules need only to be inserted and they are ready.
- The actuator must be used when connecting stranded wires without ferrules.
- Intuitive handling - since the wire-entry area and handling area are clearly separated.
- User-friendly handling with rounded outer edges and large, no-slip push buttons.
- Lock and release lever: tool-less locking and a gentle releasing of the connector reduces the mechanical stress to the solder joints.

Technical data

In compliance with IEC 60664-1 / IEC 61984			
Clamping range, max.	mm ²	0.13...3.31	
Solid core H05(07) V-U	mm²	0.2...2.5	
Stranded H07 V-R			
Flexible H05(07) V-K	mm ²	0.2...2.5	
Flexible with ferrule	mm ²	0.25...2.5	
Ferrule with plastic collar	mm ²	0.25...2.5	
Stripping length	mm	10	
Screwdriver blade	mm	0.6 x 3.5	
		According to norm DIN 5264	
Tightening torque range			
Rated current, max.	A	24	21
At ambient temperature		20°C	40°C
For conductor cross-section	mm ²	2.5	
Overvoltage category		III	II
Pollution severity		3	2
Rated voltage	V	250	320
Rated impulse voltage	kV	4	4
UL / CUL (Use Group)		B	C
Rated voltage	V	300	300
Rated current	A	18.5	10
AWG conductor	AWG	26-12	
CSA (Use Group)		B	C
Rated voltage	V	300	300
Rated current	A	10	10
AWG conductor	AWG	12-26	
General data			
Type of insulation material		PBT	
UL 94 flammability rating		V-0	
Contact base material		CuSn	
Material of contact surface		tinned	
Pin dimensions = d	mm		
Solder eyelet Ø = D	mm		
Solder eyelet Ø tolerance	mm		

5.08

90°

2.5 mm²

Product data

IEC: 400 V / 24 A / 0.2 - 2.5 mm²
UL: 300 V / 18.5 A / AWG 26 - 12



For additional articles and information, refer to catalog.weidmueller.com

Note:

- Additional colours on request
- Gold-plated contact surfaces on request
- Rated current related to rated cross-section & min. No. of poles.
- Wire end ferrule without plastic collar to DIN 46228/1
- Wire end ferrule with plastic collar to DIN 46228/4
- P on drawing = pitch
- Crimping shape "A" for wire end ferrules with PZ 6/5 crimping tool recommended.
- The test point can only be used as potential-pickup point.

BLF 5.08HC../90



Dimensioned drawing

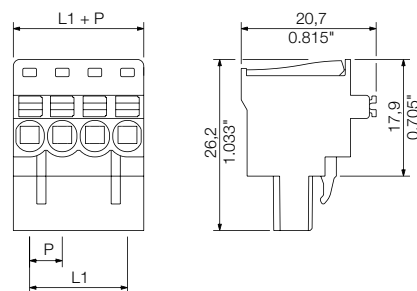

Accessories

Note: Refer to the Accessories chapter for additional accessories.

Coding	Order No.
BLZ/SL KO OR BX	1573010000
BLZ/SL KO BK BX	1545710000
Screwdriver	
SDS 0.6X3.5X100	2749340000
SDIS 0.6X3.5X100	2749810000
Wire-end ferrule	
H0,5/14S W	9004590000
H1,0/14S R	9018560000
H1,5/14DS SW	9025240000
H2,5/14DS BL	1333100000

Ordering data

Solder pin length				
Colour	orange			
Pitch	5.08 mm			
Pol.	L1	(inch)	Qty.	Order No.
2	5.08	0.200	180	1001530000
3	10.16	0.400	120	1001540000
4	15.24	0.600	90	1001550000
5	20.32	0.800	72	1001560000
6	25.40	1.000	60	1001570000
7	30.48	1.200	48	1001580000
8	35.56	1.400	42	1001590000
9	40.64	1.600	36	1001600000
10	45.72	1.800	36	1001610000
11	50.80	2.000	30	1001620000
12	55.88	2.200	30	1001630000

Representative deratings curve

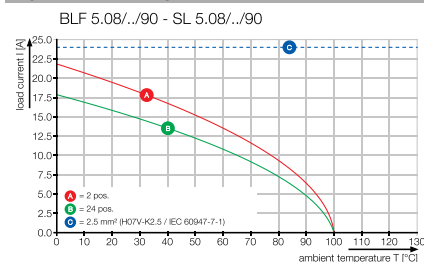

BLF 5.08HC/././90F



Dimensioned drawing

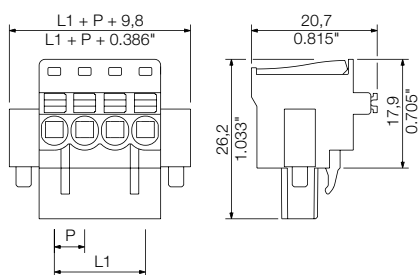

Ordering data

Solder pin length					
Colour					orange
Pitch 5.08 mm					
Pol.	L1	(inch)	Qty.	Order No.	
2	5.08	0.200	90	1002090000	
3	10.16	0.400	72	1002100000	
4	15.24	0.600	60	1002110000	
5	20.32	0.800	48	1002120000	
6	25.40	1.000	42	1002130000	
7	30.48	1.200	36	1002140000	
8	35.56	1.400	36	1002150000	
9	40.64	1.600	30	1002160000	
10	45.72	1.800	30	1002170000	
11	50.80	2.000	24	1002180000	
12	55.88	2.200	24	1002190000	

BLF 5.08HC/././90LR

with release latch



Dimensioned drawing

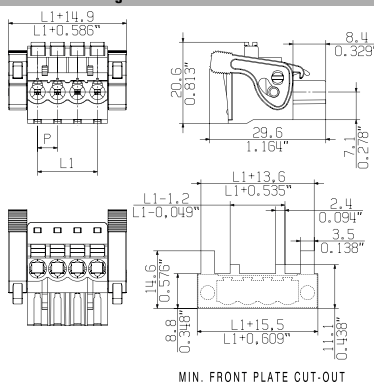

Ordering data

Solder pin length					
Colour					orange
Pitch 5.08 mm					
Pol.	L1	(inch)	Qty.	Order No.	
2	5.08	0.200	90	1002280000	
3	10.16	0.400	72	1002290000	
4	15.24	0.600	60	1002300000	
5	20.32	0.800	48	1002310000	
6	25.40	1.000	42	1002320000	
7	30.48	1.200	36	1002330000	
8	35.56	1.400	36	1002340000	
9	40.64	1.600	30	1002350000	
10	45.72	1.800	30	1002360000	
11	50.80	2.000	24	1002370000	
12	55.88	2.200	24	1002380000	

PUSH IN connection technology

PUSH IN connection technology reduces the wiring efforts especially for solid wires and wires with ferrule to a minimum. These connectors are self-explanatory and enable tool-less handling. The contact element made of stainless steel ensures a vibration proof, maintenance free wire termination. The established principle "STEEL FOR THE FORCE, COPPER FOR THE CURRENT" by Weidmüller offers both, maximum conductor clamping forces, as well as minimum power loss at the same time.



The 2-in-1 contact

Every pluggable connector covers two different requirements: First, the wire termination and second, the connection between plug and pin header. Referring to the 5.0x pitch series, Weidmüller offers different wire connection technologies, but one platform contact for the male / female connection since years. This well-designed hybride platform contact ensures a constant quality on a very high level. Hybride means, that we combine metal material featuring different characteristics by welding, in order to divide the contact system into different function zones: Further to the high electric conductance, the current bar is characterized by its hardness, and the tulip contact by its excellent tension properties. The advantage: each function is supported by the most suitable material to reliably and constantly meet the different electrical and mechanical requirements. To put it in a nutshell: Instead of either ... or, it's even both - perfect for the current, and perfect for the force.



Connectors in 5.08 mm pitch Series BL/SL 5.08

BLF 5.08HC/./270

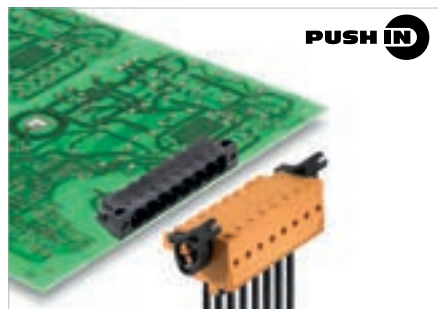

PUSH IN - Weidmüller's innovative connection system simplifies and accelerates the wire connection process.

- Solid wires and stranded wires with ferrules need only to be inserted and they are ready.
- The actuator must be used when connecting stranded wires without ferrules.
- Intuitive handling - since the wire-entry area and handling area are clearly separated.
- User-friendly handling with rounded outer edges and large, no-slip push buttons.
- Lock and release lever: tool-less locking and a gentle releasing of the connector reduces the mechanical stress to the solder joints.

Technical data

In compliance with IEC 60664-1 / IEC 61984			
Clamping range, max.	mm ²	0.13...3.31	
Solid core H05(07) V-U	mm ²	0.2...2.5	
Stranded H07 V-R			
Flexible H05(07) V-K	mm ²	0.2...2.5	
Flexible with ferrule	mm ²	0.25...2.5	
Ferrule with plastic collar	mm ²	0.25...2.5	
Stripping length	mm	10	
Screwdriver blade	mm	0.6 x 3.5	
		According to norm DIN 5264	
Tightening torque range			
Rated current, max.	A	24	21
At ambient temperature		20°C	40°C
For conductor cross-section	mm ²	2.5	
Overvoltage category		III	II
Pollution severity		3	2
Rated voltage	V	250	320
Rated impulse voltage	kV	4	4
UL / CUL (Use Group)		B	C
Rated voltage	V	300	300
Rated current	A	18.5	10
AWG conductor	AWG	26-12	
CSA (Use Group)		B	C
Rated voltage	V	300	300
Rated current	A	10	10
AWG conductor	AWG	12-26	
General data			
Type of insulation material		PBT	
UL 94 flammability rating		V-0	
Contact base material		CuSn	
Material of contact surface		tinned	
Pin dimensions = d	mm		
Solder eyelet Ø = D	mm		
Solder eyelet Ø tolerance	mm		

Product data

IEC: 400 V / 24 A / 0.2 - 2.5 mm²
UL: 300 V / 18.5 A / AWG 26 - 12



For additional articles and information, refer to catalog.weidmueller.com

Note:

- Additional colours on request
- Gold-plated contact surfaces on request
- Rated current related to rated cross-section & min. No. of poles.
- Wire end ferrule without plastic collar to DIN 46228/1
- Wire end ferrule with plastic collar to DIN 46228/4
- P on drawing = pitch
- Crimping shape "A" for wire end ferrules with PZ 6/5 crimping tool recommended.
- The test point can only be used as potential-pickup point.

BLF 5.08HC/./270



Dimensioned drawing

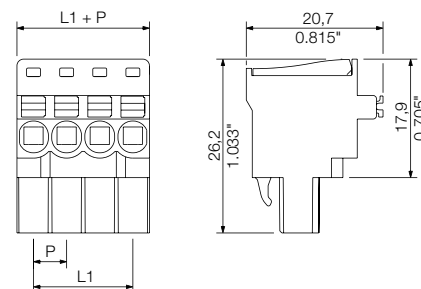

Accessories

Note: Refer to the Accessories chapter for additional accessories.

Coding	Order No.
BLZ/SL KO OR BX	1573010000
BLZ/SL KO BK BX	1545710000
Screwdriver	
SDS 0.6X3.5X100	2749340000
SDIS 0.6X3.5X100	2749810000
Wire-end ferrule	
H0,5/14S W	9004590000
H1,0/14S R	9018560000
H1,5/14DS SW	9025240000
H2,5/14DS BL	1333100000

Ordering data

Solder pin length					
Colour	orange				
Pitch	5.08 mm				
Pol.	L1	(inch)	Qty.	Order No.	
2	5.08	0.200	180	1982700000	
3	10.16	0.400	120	1982710000	
4	15.24	0.600	90	1982720000	
5	20.32	0.800	72	1982730000	
6	25.40	1.000	60	1982740000	
7	30.48	1.200	48	1982750000	
8	35.56	1.400	42	1982760000	
9	40.64	1.600	36	1982770000	
10	45.72	1.800	36	1982780000	
11	50.80	2.000	30	1982790000	
12	55.88	2.200	30	1982800000	

Representative deratings curve

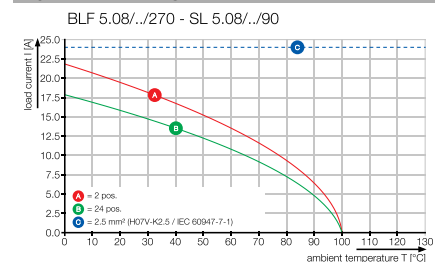

BLF 5.08HC../270F



Dimensioned drawing

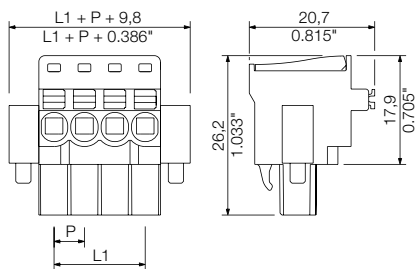

Ordering data

Solder pin length					
Colour					orange
Pitch 5.08 mm					
Pol.	L1	(inch)	Qty.	Order No.	
2	5.08	0.200	90	1982890000	
3	10.16	0.400	72	1982900000	
4	15.24	0.600	60	1982910000	
5	20.32	0.800	48	1982920000	
6	25.40	1.000	42	1982930000	
7	30.48	1.200	36	1982940000	
8	35.56	1.400	36	1982950000	
9	40.64	1.600	30	1982960000	
10	45.72	1.800	30	1982970000	
11	50.80	2.000	24	1982980000	
12	55.88	2.200	24	1982990000	

BLF 5.08HC../270LR

with release latch



Dimensioned drawing

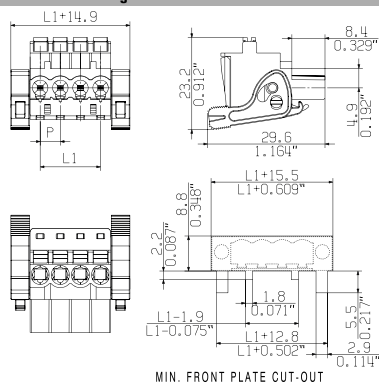

Ordering data

Solder pin length					
Colour					orange
Pitch 5.08 mm					
Pol.	L1	(inch)	Qty.	Order No.	
2	5.08	0.200	90	1983080000	
3	10.16	0.400	72	1983090000	
4	15.24	0.600	60	1983100000	
5	20.32	0.800	48	1983110000	
6	25.40	1.000	42	1983120000	
7	30.48	1.200	36	1983130000	
8	35.56	1.400	36	1983140000	
9	40.64	1.600	30	1983150000	
10	45.72	1.800	30	1983160000	
11	50.80	2.000	24	1983170000	
12	55.88	2.200	24	1983180000	

PUSH IN connection technology

PUSH IN connection technology reduces the wiring efforts especially for solid wires and wires with ferrule to a minimum. These connectors are self-explanatory and enable tool-less handling. The contact element made of stainless steel ensures a vibration proof, maintenance free wire termination. The established principle "STEEL FOR THE FORCE, COPPER FOR THE CURRENT" by Weidmüller offers both, maximum conductor clamping forces, as well as minimum power loss at the same time.



The 2-in-1 contact

Every pluggable connector covers two different requirements: First, the wire termination and second, the connection between plug and pin header. Referring to the 5.0x pitch series, Weidmüller offers different wire connection technologies, but one platform contact for the male / female connection since years. This well-designed hybride platform contact ensures a constant quality on a very high level. Hybride means, that we combine metal material featuring different characteristics by welding, in order to divide the contact system into different function zones: Further to the high electric conductance, the current bar is characterized by its hardness, and the tulip contact by its excellent tension properties. The advantage: each function is supported by the most suitable material to reliably and constantly meet the different electrical and mechanical requirements. To put it in a nutshell: Instead of either ... or, it's even both - perfect for the current, and perfect for the force.



Connectors in 5.08 mm pitch Series BL/SL 5.08

BLDF 5.08/./180

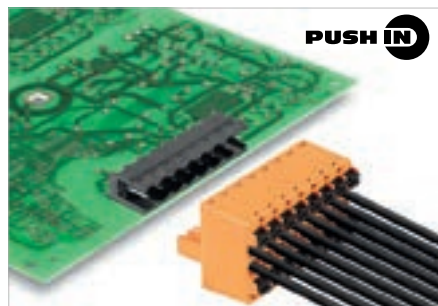

PUSH IN

Bus connector with two connections per pole with the time-saving PUSH IN connection system.

- The extremely short cross-connection allows you to safely loop through bus currents of up to 22 A.
- This permits an interruption-free decoupling of individual modules from the network.
- Solid wires and stranded wires with ferrules need only to be inserted and they are ready.
- An actuator must be used when connecting stranded wires with ferrules.
- Lock and release-lever: tool-less locking and gentle releasing of the connector reduces the mechanical stress on the solder joints.

Technical data

In compliance with IEC 60664-1 / IEC 61984			
Clamping range, max.	mm ²	0.13...3.31	
Solid core H05(07) V-U	mm ²	0.2...2.5	
Stranded H07 V-R			
Flexible H05(07) V-K	mm ²	0.2...2.5	
Flexible with ferrule	mm ²	0.25...2.5	
Ferrule with plastic collar	mm ²	0.25...2.5	
Stripping length	mm	10	
Screwdriver blade	mm	0.6 x 3.5	
According to norm			
Tightening torque range			
Rated current, max.	A	20.8	17.9
At ambient temperature		20°C	40°C
For conductor cross-section	mm ²	2.5	
Overvoltage category		III	III II
Pollution severity		3	2 2
Rated voltage	V	250	320 400
Rated impulse voltage	kV	4	4 4
UL / CUL (Use Group)		B	C D
Rated voltage	V	300	300
Rated current	A	18.5	10
AWG conductor	AWG	12-26	
CSA (Use Group)		B	C D
Rated voltage	V	300	300
Rated current	A	18.5	10
AWG conductor	AWG	12-26	
General data			
Type of insulation material		PBT	
UL 94 flammability rating		V-0	
Contact base material		CuSn	
Material of contact surface		tinned	
Pin dimensions = d	mm		
Solder eyelet Ø = D			
Solder eyelet Ø tolerance	mm		

Product data

IEC: 400 V / 20.8 A / 0.2 - 2.5 mm²
UL: 300 V / 18.5 A / AWG 12 - 26



For additional articles and information, refer to catalog.weidmuller.com

Note:

- Additional colours on request
- Gold-plated contact surfaces on request
- Rated current related to rated cross-section & min. No. of poles.
- Wire end ferrule without plastic collar to DIN 46228/1
- Wire end ferrule with plastic collar to DIN 46228/4
- P on drawing = pitch
- Crimping shape "A" for wire end ferrules with PZ 6/5 crimping tool recommended.
- The test point can only be used as potential-pickup point.

BLDF 5.08/./180



Dimensioned drawing

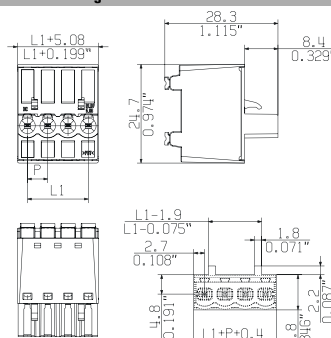

Accessories

Note: Refer to the Accessories chapter for additional accessories.

Coding	Order No.
BLZ/SL KO OR BX	1573010000
BLZ/SL KO BK BX	1545710000
Screwdriver	
SDS 0.6X3.5X100	2749340000
SDIS 0.6X3.5X100	2749810000
Wire-end ferrule	
H0,5/14S W	9004590000
H1,0/14S R	9018560000
H1,5/14DS SW	9025240000
H2,5/14DS BL	1333100000

Ordering data

Solder pin length				
Colour	orange			
Pitch	5.08 mm			
Pol.	L1	(inch)	Qty.	Order No.
2	5.08	0.200	120	1001150000
3	10.16	0.400	80	1001160000
4	15.24	0.600	60	1001170000
5	20.32	0.800	48	1001180000
6	25.40	1.000	40	1001190000
7	30.48	1.200	32	1001200000
8	35.56	1.400	28	1001210000

L

5.08

180°

2.5 mm²

BLDF 5.08../180F



Dimensioned drawing

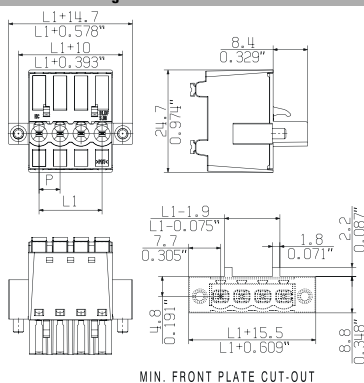

Ordering data

Solder pin length					
Colour					orange
Pitch 5.08 mm					
Pol.	L1	(inch)	Qty.	Order No.	
2	5.08	0.200	60	1001220000	
3	10.16	0.400	48	1012060000	
4	15.24	0.600	40	1059420000	
5	20.32	0.800	32	1065080000	
6	25.40	1.000	28	1065090000	
7	30.48	1.200	24	1065110000	
8	35.56	1.400	24	1065120000	

BLDF 5.08../180LR

with release latch



Dimensioned drawing

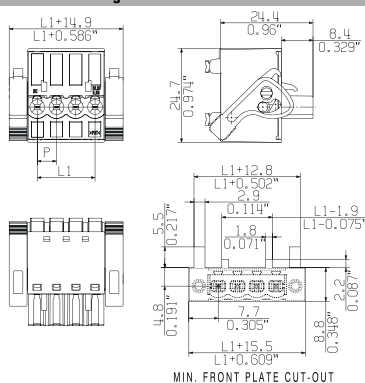

Ordering data

Solder pin length					
Colour					orange
Pitch 5.08 mm					
Pol.	L1	(inch)	Qty.	Order No.	
2	5.08	0.200	60	1065130000	
3	10.16	0.400	48	1065140000	
4	15.24	0.600	40	1065150000	
5	20.32	0.800	32	1065160000	
6	25.40	1.000	28	1065170000	
7	30.48	1.200	24	1065180000	
8	35.56	1.400	24	1065190000	

PUSH IN connection technology

PUSH IN connection technology reduces the wiring efforts especially for solid wires and wires with ferrule to a minimum. These connectors are self-explanatory and enable tool-less handling. The contact element made of stainless steel ensures a vibration proof, maintenance free wire termination. The established principle "STEEL FOR THE FORCE, COPPER FOR THE CURRENT" by Weidmüller offers both, maximum conductor clamping forces, as well as minimum power loss at the same time.



The 2-in-1 contact

Every pluggable connector covers two different requirements: First, the wire termination and second, the connection between plug and pin header. Referring to the 5.0x pitch series, Weidmüller offers different wire connection technologies, but one platform contact for the male / female connection since years. This well-designed hybride platform contact ensures a constant quality on a very high level. Hybride means, that we combine metal material featuring different characteristics by welding, in order to divide the contact system into different function zones: Further to the high electric conductance, the current bar is characterized by its hardness, and the tulip contact by its excellent tension properties. The advantage: each function is supported by the most suitable material to reliably and constantly meet the different electrical and mechanical requirements. To put it in a nutshell: Instead of either ... or, it's even both - perfect for the current, and perfect for the force.



Connectors in 5.08 mm pitch Series BL/SL 5.08

BLC 5.08/./180

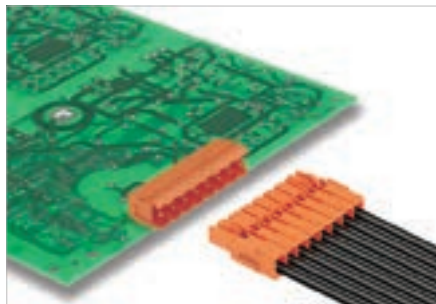

The female plugs with crimp connection can be used for automatically pre-assembled cable harnesses. This results in significant cost savings.

- The contacts are optimised for crimping machines (factory wiring).
- Contacts can also be connected with manual tools (field wiring).
- High component density because of very low height
- Large wire clamping range: 0.22-2.5 mm²
- Contacts can be delivered loose in bulk, or in tape-packaged strips.

Technical data

In compliance with IEC 60664-1 / IEC 61984			
Clamping range, max.	mm ²	0.22...2.5	
Solid core H05(07) V-U			
Stranded H07 V-R			
Flexible H05(07) V-K	mm ²	0.5...2.5	
Flexible with ferrule			
Ferrule with plastic collar			
Stripping length	mm	5	
Screwdriver blade	mm		
According to norm			
Tightening torque range			
Rated current, max.	A	21	18
At ambient temperature	20°C	40°C	
For conductor cross-section	mm ²	2.5	
Overvoltage category		III	II
Pollution severity		3	2
Rated voltage	V	250	320 400
Rated impulse voltage	kV	4	4 4
UL / CUL (Use Group)		B	C D
Rated voltage	V	300	300
Rated current	A	10	10
AWG conductor	AWG	26-14	
CSA (Use Group)		B	C D
Rated voltage	V	300	300
Rated current	A	10	10
AWG conductor	AWG	26-14	
General data			
Type of insulation material		PBT GF	
UL 94 flammability rating		V-0	
Contact base material		Copper alloy	
Material of contact surface			
Pin dimensions = d	mm		
Solder eyelet Ø = D	mm		
Solder eyelet Ø tolerance	mm		

Product data

IEC: 400 V / 21 A
UL: 300 V / 10 A / AWG 26 - 14



For additional articles and information, refer to catalog.weidmueller.com

Note:

- Additional colours on request
- Rated current related to rated cross-section & min. No. of poles.
- Rated cross-section depends on crimp contact used.
- P on drawing = pitch
- Rated data refer only to the component itself. Clearance and creepage distances to other components are to be designed in accordance with the relevant application standards.

BLC 5.08/./180R



Dimensioned drawing

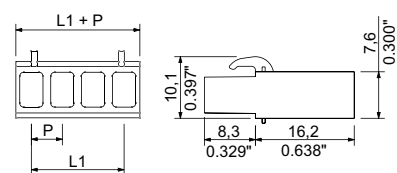

Accessories

Note: Refer to the Accessories chapter for additional accessories.

Coding	Order No.
BLZ/SL KO OR BX	1573010000
BLZ/SL KO BK BX	1545710000
DFFC 0.22-0.35 SN 3000	1604230000
DFFC 0.22-0.35 SN E	1604250000
DFFC 0.5-1.0 SN 3000	1480000000
DFFC 0.5-1.0 SN E	1567060000
DFFC 1.5-2.5 SN 2500	1480100000
DFFC 1.5-2.5 SN E	1567070000
Pressing tool	
HTF DFF	9014140000

Ordering data

Solder pin length					
Colour	orange				
Pitch	5.08 mm				
Pol.	L1	(inch)	Qty.	Order No.	
2	5.08	0.200	100	1610490000	
3	10.16	0.400	100	1610500000	
4	15.24	0.600	100	1610510000	
5	20.32	0.800	50	1610520000	
6	25.40	1.000	50	1610530000	
7	30.48	1.200	50	1610540000	
8	35.56	1.400	50	1610550000	
9	40.64	1.600	50	1610560000	
10	45.72	1.800	50	1610570000	
11	50.80	2.000	50	1610580000	
12	55.88	2.200	50	1610590000	

Representative deratings curve

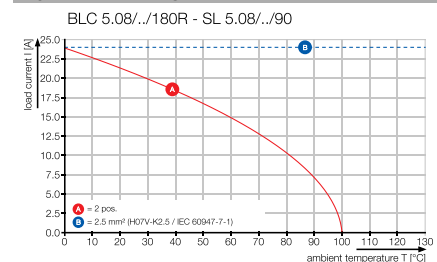

L

5.08

180°

BLC 5.08/.../180BR



Dimensioned drawing

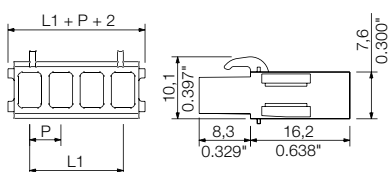

Ordering data

Solder pin length				
Colour				orange
Pitch		5.08 mm		
Pol.	L1	(inch)	Qty.	Order No.
2	5.08	0.200	100	1649370000
3	10.16	0.400	100	1649380000
4	15.24	0.600	100	1649390000
5	20.32	0.800	50	1649400000
6	25.40	1.000	50	1649410000
7	30.48	1.200	50	1649420000
8	35.56	1.400	50	1649430000
9	40.64	1.600	50	1649440000
10	45.72	1.800	50	1649450000
11	50.80	2.000	50	1649460000
12	55.88	2.200	50	1649470000



Connectors in 5.08 mm pitch Series BL/SL 5.08

BLL 5.08/./90

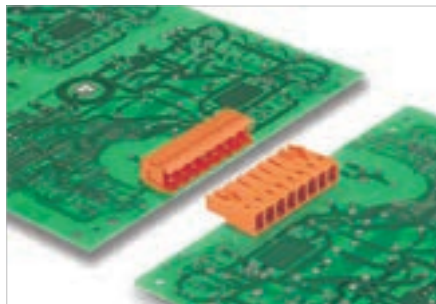

Female headers for mounting on the circuit board; with 90° wire outlet, optimised for the wave soldering process.

- BLL 5.08 & SL 5.08 for board-to-board connections (e.g., backplanes)
- BLL 5.08 & SLS / SLT 5.08 for board-to-wire applications (e.g., power supply for actuators)
- Available with a screw flange (F).

Technical data

In compliance with IEC 60664-1 / IEC 61984

Clamping range, max.			
Solid core H05(07) V-U			
Stranded H07 V-R			
Flexible H05(07) V-K			
Flexible with ferrule			
Ferrule with plastic collar			
Stripping length			
Screwdriver blade	mm		
According to norm			
Tightening torque range			
Rated current, max.	A	23	20
At ambient temperature		20°C	40°C
For conductor cross-section			
Overvoltage category		III	III II
Pollution severity		3	2 2
Rated voltage	V	250	320 400
Rated impulse voltage	kV	4	4 4
UL / CUL (Use Group)		B	C D
Rated voltage	V	300	300
Rated current	A	15	10
AWG conductor	AWG		-
CSA (Use Group)		B	C D
Rated voltage	V	300	300
Rated current	A	15	10
AWG conductor	AWG		-
General data			
Type of insulation material	PBT GF		
UL 94 flammability rating	V-0		
Contact base material	Copper alloy		
Material of contact surface	tinned		
Pin dimensions = d	mm	0.4 x 1.00	
Solder eyelet Ø = D	mm	1.3	
Solder eyelet Ø tolerance	mm	+ 0,1	

Product data

IEC: 400 V / 23 A
UL: 300 V / 15 A



For additional articles and information, refer to catalog.weidmueller.com

Note:

- Additional colours on request
- Gold-plated contact surfaces on request
- Rated current related to rated cross-section & min. No. of poles.
- P on drawing = pitch
- Rated data refer only to the component itself. Clearance and creepage distances to other components are to be designed in accordance with the relevant application standards.

BLL 5.08/./90



Dimensioned drawing

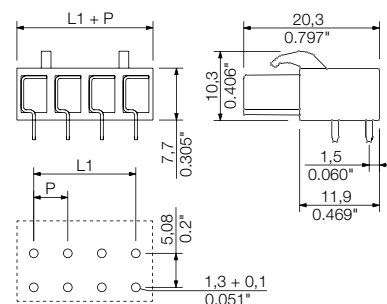

Accessories

Note: Refer to the Accessories chapter for additional accessories.

Coding	Order No.
BLZ/SL KO OR BX	1573010000
BLZ/SL KO BK BX	1545710000
Mounting block	
SLA BB11R OR	1604120000
SLA BB11R SW	1692340000

Ordering data

Solder pin length		3.2 mm		
Colour		orange		
Pitch		5.08 mm		
Pol.	L1	(inch)	Qty.	Order No.
2	5.08	0.200	180	1622940000
3	10.16	0.400	120	1622950000
4	15.24	0.600	90	1622960000
5	20.32	0.800	72	1622970000
6	25.40	1.000	60	1622980000
7	30.48	1.200	48	1622990000
8	35.56	1.400	42	1623000000
9	40.64	1.600	36	1623010000
10	45.72	1.800	36	1623020000
11	50.80	2.000	30	1623030000
12	55.88	2.200	30	1623040000

L

5.08

90°

BLL 5.08/./90FI



Dimensioned drawing

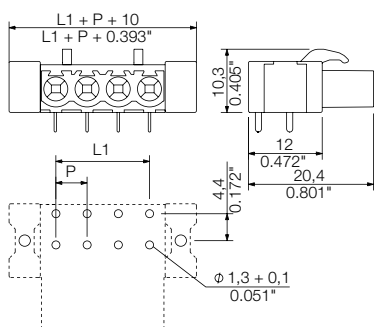

Ordering data

Solder pin length		3.2 mm	
Colour		orange	
Pitch		5.08 mm	
Pol.	L1	(inch)	Qty. Order No.
2	5.08	0.200	90 1843750000
3	10.16	0.400	72 1843760000
4	15.24	0.600	60 1843770000
5	20.32	0.800	48 1843780000
6	25.40	1.000	42 1843790000
7	30.48	1.200	36 1843800000
8	35.56	1.400	36 1843810000
9	40.64	1.600	30 1843820000
10	45.72	1.800	30 1843830000
11	50.80	2.000	24 1843840000
12	55.88	2.200	24 1843850000



Connectors in 5.08 mm pitch Series BL/SL 5.08

BLL 5.08/./180

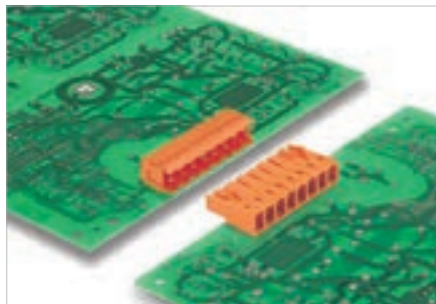

Female headers for mounting on the circuit board; with straight wire outlet, optimised for the wave soldering process.

- BLL 5.08 & SL 5.08 for board-to-board connections (e.g., backplanes)
- BLL 5.08 & SLS / SLT 5.08 for board-to-wire applications (e.g., power supply for actuators)

Product data

IEC: 400 V / 23 A
UL: 300 V / 15 A



For additional articles and information, refer to catalog.weidmuller.com

Note:

- Additional colours on request
- Gold-plated contact surfaces on request
- Rated current related to rated cross-section & min. No. of poles.
- P on drawing = pitch
- Rated data refer only to the component itself. Clearance and creepage distances to other components are to be designed in accordance with the relevant application standards.

BLL 5.08/./180



Dimensioned drawing

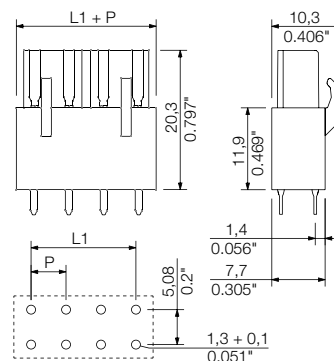

Technical data

In compliance with IEC 60664-1 / IEC 61984

Clamping range, max.			
Solid core H05(07) V-U			
Stranded H07 V-R			
Flexible H05(07) V-K			
Flexible with ferrule			
Ferrule with plastic collar			
Stripping length			
Screwdriver blade	mm		
According to norm			
Tightening torque range			
Rated current, max.	A	23	20
At ambient temperature		20°C	40°C
For conductor cross-section			
Overvoltage category		III	III II
Pollution severity		3	2 2
Rated voltage	V	250	320 400
Rated impulse voltage	kV	4	4 4
UL / CUL (Use Group)		B	C D
Rated voltage	V	300	300
Rated current	A	15	10
AWG conductor	AWG		-
CSA (Use Group)		B	C D
Rated voltage	V	300	300
Rated current	A	15	10
AWG conductor	AWG		-
General data			
Type of insulation material		PBT GF	
UL 94 flammability rating		V-0	
Contact base material		Copper alloy	
Material of contact surface		tinned	
Pin dimensions = d	mm	0.4 x 1.00	
Solder eyelet Ø = D	mm	1.3	
Solder eyelet Ø tolerance	mm	+ 0,1	

Accessories

Note: Refer to the Accessories chapter for additional accessories.

Coding	Order No.
BLZ/SL KO OR BX	1573010000
BLZ/SL KO BK BX	1545710000
Mounting block	
SLA BB11R OR	1604120000
SLA BB11R SW	1692340000

Ordering data

Solder pin length		3.2 mm		
Colour		orange		
Pitch	5.08 mm			
Pol.	L1	(inch)	Qty.	Order No.
2	5.08	0.200	180	1630710000
3	10.16	0.400	120	1630720000
4	15.24	0.600	90	1630730000
5	20.32	0.800	72	1630740000
6	25.40	1.000	60	1630750000
7	30.48	1.200	48	1630760000
8	35.56	1.400	42	1630770000
9	40.64	1.600	36	1630780000
10	45.72	1.800	36	1630790000
11	50.80	2.000	30	1630800000
12	55.88	2.200	30	1630810000



5.08

180°

BLL 5.08/./180B



Dimensioned drawing

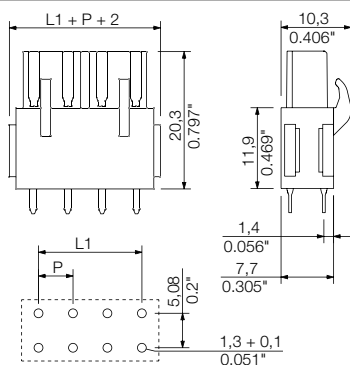

Ordering data

Solder pin length		3.2 mm	
Colour		orange	
Pitch		5.08 mm	
Pol.	L1	(inch)	Qty. Order No.
2	5.08	0.200	204 1682730000
3	10.16	0.400	108 1682740000
4	15.24	0.600	84 1682750000
5	20.32	0.800	66 1682760000
6	25.40	1.000	54 1682770000
7	30.48	1.200	48 1682780000
8	35.56	1.400	42 1682790000
9	40.64	1.600	36 1682800000
10	45.72	1.800	30 1682810000
11	50.80	2.000	30 1682820000
12	55.88	2.200	24 1682830000





OMNIMATE® Signal PCB connectors Series RSV

**OMNIMATE® Signal
PCB connectors Series RSV**

Connectors in 5.00 mm pitch
Series RSV

Explanation	M.2
Quick selection	M.4
Product selection	M.6

RSV 1.6 CB / CS

Highest flexibility with the highest density

A space miracle for the PCB and the field wiring permits up to 36 contacts to be inserted in one operation. The crimp contacts ensure that the contacts can be quickly and flexibly assembled – their plastic cases automatically snap together when joined. This system can be used for many signalling purposes: whether it is soldered on to the circuit board, mounted on the rail using a mounting-rail foot, or built in to the front of the device. This product line also includes versatile coding elements, a choice between tin or gold surfaces, and snap-on plug hoods.

Versatile system-based wiring

Very versatile assembly: different functions can be combined with different wire cross-sections (from 0.14 mm² to 2.5 mm²). Tin-plated or gold-plated contact surfaces can be custom selected from pole to pole based on your application requirements. This delivers clear cost savings. Higher voltages may require larger clearance gaps between the contacts. This problem can be solved without changing to a different type of connector by simply occupying every second pole.



Also with gold contacts to meet application requirements

Gold-plated contacts are the best solution for very low currents or voltages, such as those used with measurements. Gold surfaces are a reliable safeguard against friction corrosion caused by long-term vibrations. Compared to tin contacts which are rated for 100 plugging cycles, gold-plated contacts have an increased rating of 500 plugging cycles.

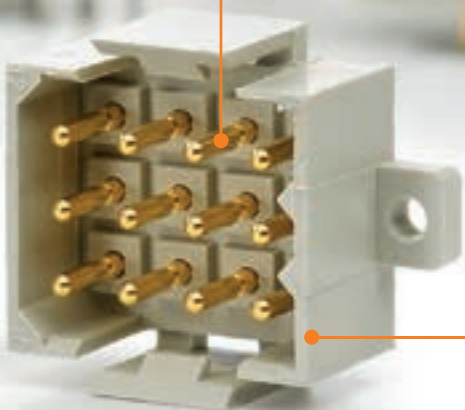
**Highest component assembly density for 5-mm pitch**

Every square mm is crucial on the circuit board. The RSV permit 36 poles to fit in a 5-mm pitch on a 40 mm x 29 mm surface.



<http://www.OMNIMATE.net>

○ = Wire-to-Board	
● = Board-to-Board	
● = Wire-to-Wire	
● = Board-to-Wire	

Series RSV





Levels

Type	Contact surface	Flange options	IEC / UL
------	-----------------	----------------	----------

Female plug	Crimp	Image	Type	Contact surface	Flange options	IEC / UL
			RSV1.6 CB..	Tin / Gold	(G)	IEC: 630 V/17 A UL: 600 V/10 A/AWG 26 - 12
Female header	Solder connection		RSV1.6 LB.. SN	Tin	(G)/F	IEC: 500 V/14 A UL: 300 V/10 A
			RSV1.6 LB.. AU	Gold	(G)/F	IEC: 500 V/14 A UL: 300 V/10 A

(G)* = Closed (without flange)
F = Flange

* = not included in the article description

Male header	Male plug
 Solder connection	 Crimp



1		1
RSV1.6 LS.. SN	RSV1.6 LS.. AU	RSV1.6 CS..
Tin	Gold	Tin / Gold
(G)/F	(G)/F	(G)
IEC: 500 V/14 A UL: 300 V/10 A	IEC: 500 V/14 A UL: 300 V/10 A	IEC: 630 V/17 A UL: 600 V/10 A/AWG 26 - 12
○	○	●
●		●
	●	●

Connectors in 5.00 mm pitch Series RSV

RSV1.6 LS..

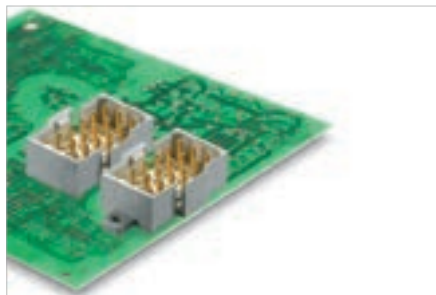

Rectangular plug-in male connector with solder contacts for PCB applications. High connection density achieved by using several rows and crimp contacts in the mating connector. The plug-in connectors can be coded and locked to the mating connector. Supplied in cardboard box.

Technical data

In compliance with IEC 60664-1 / IEC 61984

Clamping range, max.			
Solid core H05(07) V-U			
Stranded H07 V-R			
Flexible H05(07) V-K			
Flexible with ferrule			
Ferrule with plastic collar			
Stripping length			
Screwdriver blade	mm		
According to norm			
Tightening torque range			
Rated current, max.	A	14	12
At ambient temperature		20°C	40°C
For conductor cross-section			
Overvoltage category		III	III II
Pollution severity		3	2 2
Rated voltage	V	250	320 500
Rated impulse voltage	kV	4	2.5 2.5
UL / CUL (Use Group)		B	C D

Rated voltage			
Rated current			
AWG conductor	AWG	-	
CSA (Use Group)		B	C D
Rated voltage		300	
Rated current		13	
AWG conductor	AWG	-	

General data			
Type of insulation material		PA	
UL 94 flammability rating		V-0	
Contact base material		Copper alloy	
Material of contact surface		tinned	
Pin dimensions = d	mm	0.97	
Solder eyelet Ø = D	mm	1.3	
Solder eyelet Ø tolerance	mm	+ 0,1	

Product data

IEC: 500 V / 14 A
UL: 300 V / 10 A



For additional articles and information, refer to catalog.weidmueller.com

Note:

- Additional colours on request
- Rated current related to rated cross-section & min. No. of poles.
- Spacing between rows: see hole layout
- Rated data refer only to the component itself. Clearance and creepage distances to other components are to be designed in accordance with the relevant application standards.

RSV1.6 LS.. SN



Dimensioned drawing

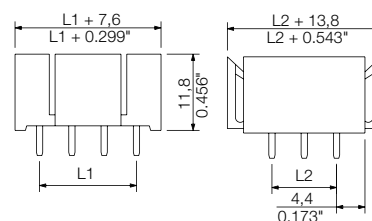

Accessories

Note: Refer to the Accessories chapter for additional accessories.

Coding		Order No.
	RSV1,6 KO	1567430000

Ordering data

Solder pin length		3.2 mm	
Colour		Pebble grey	
Pitch	5.00 mm		
Pol.	L1	(inch)	Qty. Order No.
4	5.00	0.197	100 1440500000
6	10.00	0.394	50 1441500000
9	10.00	0.394	50 1442500000
12	15.00	0.591	25 1443500000
18	25.00	0.984	25 1444500000
24	25.00	0.984	20 1445500000
36	40.00	1.575	10 1446500000

Representative deratings curve

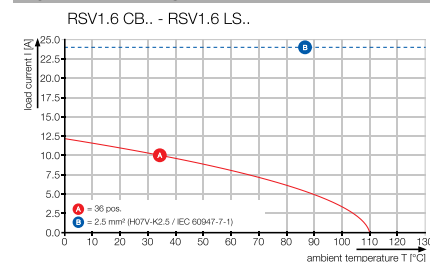

RSV1.6 LSF.. SN



Dimensioned drawing

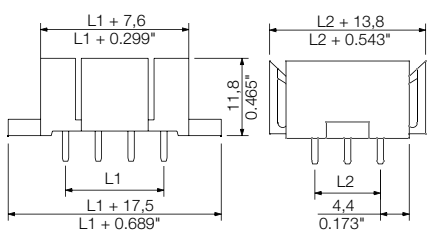

Ordering data

Solder pin length		3.2 mm		
Colour		Pebble grey		
Pitch		5.00 mm		
Pol.	L1	(inch)	Qty.	Order No.
4	5.00	0.197	100	1440900000
6	10.00	0.394	50	1441900000
9	10.00	0.394	50	1442900000
12	15.00	0.591	25	1443900000
18	25.00	0.984	25	1444900000
24	25.00	0.984	20	1445900000
36	40.00	1.575	10	1446900000

Drilling diagrams

4-pole

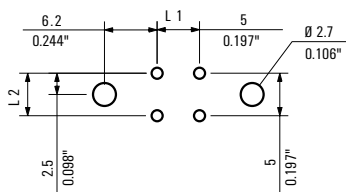

6-pole

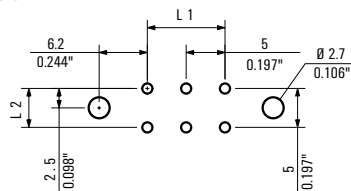

9-pole

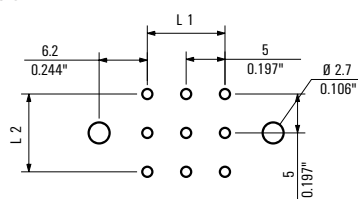

12-pole

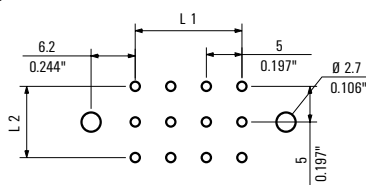

18-pole

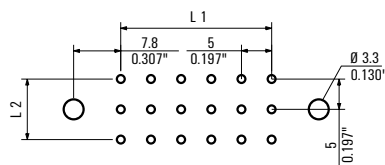

24-pole

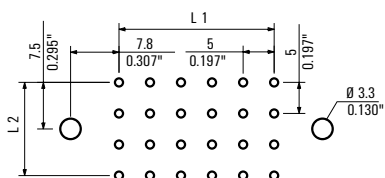

36-pole

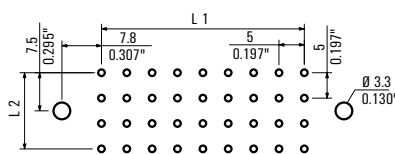

Additional deratings curves

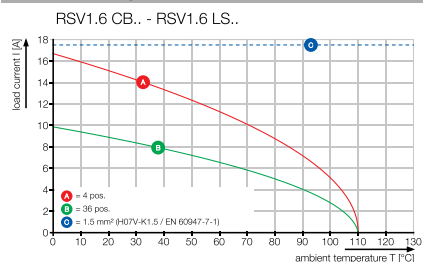

Connectors in 5.00 mm pitch Series RSV

RSV1.6 LB..

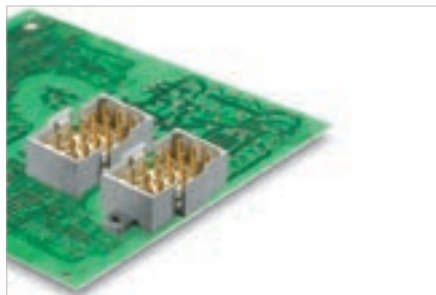

Rectangular plug-in female connector with solder contacts for PCB applications. High connection density achieved by using several rows and crimp contacts in the mating connector. The plug-in connectors can be coded and locked to the mating connector. Supplied in cardboard box.

Technical data

In compliance with IEC 60664-1 / IEC 61984

Clamping range, max.			
Solid core H05(07) V-U			
Stranded H07 V-R			
Flexible H05(07) V-K			
Flexible with ferrule			
Ferrule with plastic collar			
Stripping length			
Screwdriver blade	mm		
According to norm			
Tightening torque range			
Rated current, max.	A	14	12
At ambient temperature		20°C	40°C
For conductor cross-section			
Overvoltage category		III	III II
Pollution severity		3	2 2
Rated voltage	V	250	320 500
Rated impulse voltage	kV	4	2.5 2.5
UL / CUL (Use Group)	B	C	D
Rated voltage	300		
Rated current	10		
AWG conductor	AWG	-	
CSA (Use Group)	B	C	D
Rated voltage	300		
Rated current	13		
AWG conductor	AWG	-	
General data			
Type of insulation material	PA		
UL 94 flammability rating	V-0		
Contact base material	Copper alloy		
Material of contact surface	tinned		
Pin dimensions = d	mm	0.97	
Solder eyelet Ø = D	mm	1.3	
Solder eyelet Ø tolerance	mm	+ 0,1	

Product data

IEC: 500 V / 14 A
UL: 300 V / 10 A



For additional articles and information, refer to catalog.weidmueller.com

Note:

- Additional colours on request
- Rated current related to rated cross-section & min. No. of poles.
- Spacing between rows: see hole layout
- Rated data refer only to the component itself. Clearance and creepage distances to other components are to be designed in accordance with the relevant application standards.

RSV1.6 LB.. SN



Dimensioned drawing

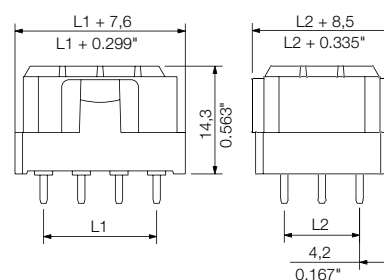

Accessories

Note: Refer to the Accessories chapter for additional accessories.

Coding	Order No.
RSV1,6 K0	1567430000

Ordering data

Solder pin length		3.2 mm		
Colour		Pebble grey		
Pitch	5.00 mm			
Pol.	L1	(inch)	Qty.	Order No.
4	5.00	0.197	100	1440300000
6	10.00	0.394	50	1441300000
9	10.00	0.394	50	1442300000
12	15.00	0.591	25	1443300000
18	25.00	0.984	25	1444300000
24	25.00	0.984	20	1445300000
36	40.00	1.575	10	1446300000

Representative deratings curve

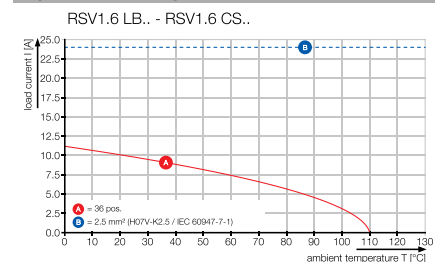

RSV1.6 LBF.. SN



Dimensioned drawing

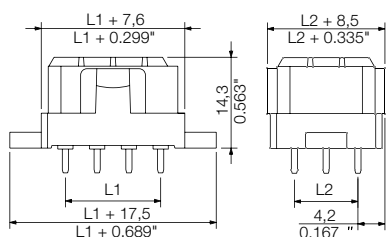

Ordering data

Solder pin length		3.2 mm		
Colour		Pebble grey		
Pitch		5.00 mm		
Pol.	L1	(inch)	Qty.	Order No.
4	5.00	0.197	100	1440700000
6	10.00	0.394	50	1441700000
9	10.00	0.394	50	1442700000
12	15.00	0.591	25	1443700000
18	25.00	0.984	25	1444700000
24	25.00	0.984	20	1445700000
36	40.00	1.575	10	1446700000

Drilling diagrams

4-pole

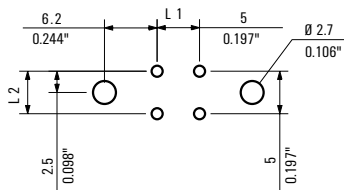

6-pole

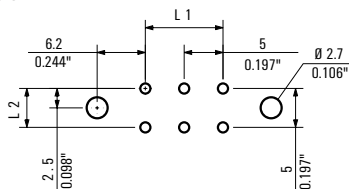

9-pole

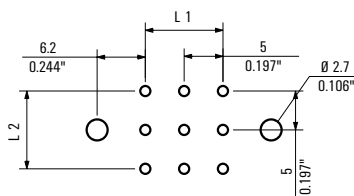

12-pole

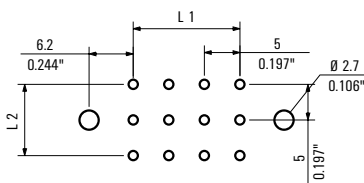

18-pole

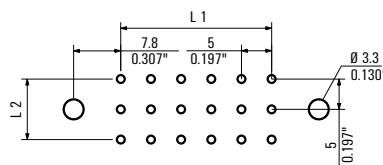

24-pole

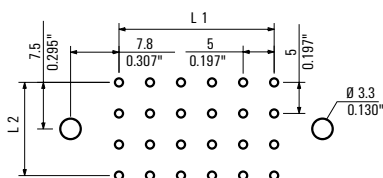

36-pole

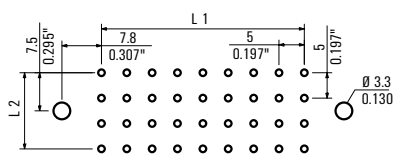

Additional deratings curves

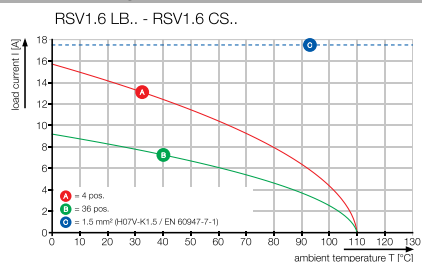

Connectors in 5.00 mm pitch Series RSV

RSV1.6 LS.. AU

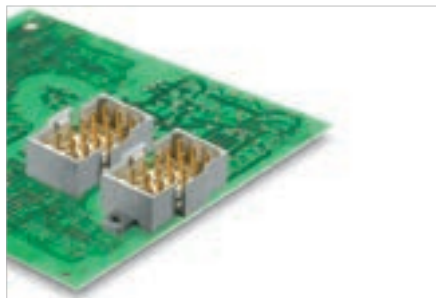

Rectangular plug-in male connector with solder contacts for PCB applications. High connection density achieved by using several rows and crimp contacts in the mating connector. The plug-in connectors can be coded and locked to the mating connector. Supplied in cardboard box.

Technical data

In compliance with IEC 60664-1 / IEC 61984

Clamping range, max.			
Solid core H05(07) V-U			
Stranded H07 V-R			
Flexible H05(07) V-K			
Flexible with ferrule			
Ferrule with plastic collar			
Stripping length			
Screwdriver blade	mm		
According to norm			
Tightening torque range			
Rated current, max.	A	14	12
At ambient temperature		20°C	40°C
For conductor cross-section			
Overvoltage category		III	III II
Pollution severity		3	2 2
Rated voltage	V	250	320 500
Rated impulse voltage	kV	4	2.5 2.5
UL / CUL (Use Group)		B	C D

Rated voltage			
Rated current			
AWG conductor	AWG	-	
CSA (Use Group)		B	C D
Rated voltage		300	
Rated current		13	
AWG conductor	AWG	-	

General data			
Type of insulation material		PA	
UL 94 flammability rating		V-0	
Contact base material		Copper alloy	
Material of contact surface		Gold-plated	
Pin dimensions = d	mm	0.97	
Solder eyelet Ø = D	mm	1.3	
Solder eyelet Ø tolerance	mm	+ 0,1	

Product data

IEC: 500 V / 14 A
UL: 300 V / 10 A



For additional articles and information, refer to catalog.weidmueller.com

Note:

- Additional colours on request
- Rated current related to rated cross-section & min. No. of poles.
- Spacing between rows: see hole layout
- Rated data refer only to the component itself. Clearance and creepage distances to other components are to be designed in accordance with the relevant application standards.

RSV1.6 LS.. AU



Dimensioned drawing

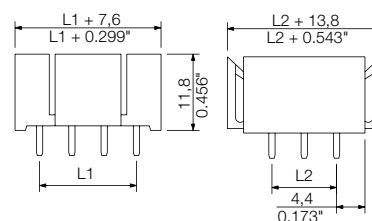

Accessories

Note: Refer to the Accessories chapter for additional accessories.

Coding	Order No.
RSV1,6 KO	1567430000

Ordering data

Solder pin length		3.2 mm	
Colour		Pebble grey	
Pitch	5.00 mm		
Pol.	L1	(inch)	Qty. Order No.
4	5.00	0.197	100 1440400000
6	10.00	0.394	50 1441400000
9	10.00	0.394	50 1442400000
12	15.00	0.591	25 1443400000
18	25.00	0.984	25 1444400000
24	25.00	0.984	20 1445400000
36	40.00	1.575	10 1446400000

Representative deratings curve

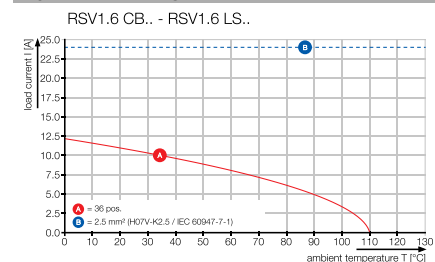

RSV1.6 LSF.. AU



Dimensioned drawing

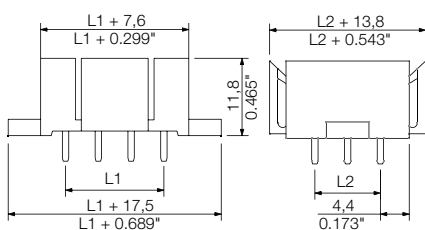

Ordering data

Solder pin length		3.2 mm	
Colour		Pebble grey	
Pitch		5.00 mm	
Pol.	L1	(inch)	Qty. Order No.
4	5.00	0.197	100 1440800000
6	10.00	0.394	50 1441800000
9	10.00	0.394	50 1442800000
12	15.00	0.591	25 1443800000
18	25.00	0.984	25 1444800000
24	25.00	0.984	20 1445800000
36	40.00	1.575	10 1446800000

Drilling diagrams

4-pole

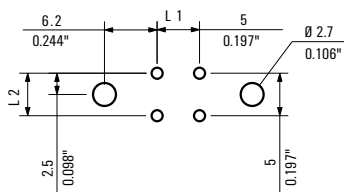

6-pole

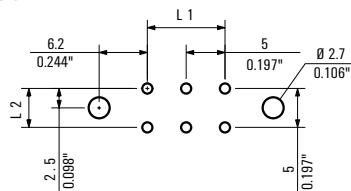

9-pole

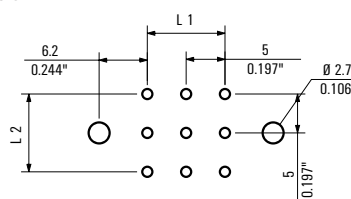

12-pole

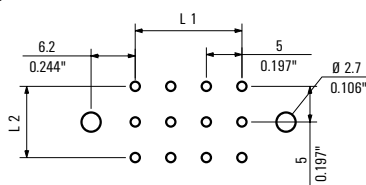

18-pole

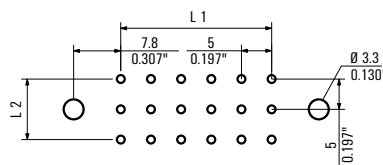

24-pole

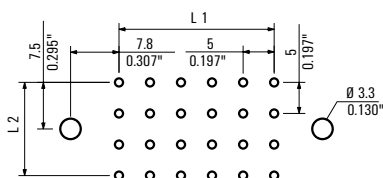

36-pole

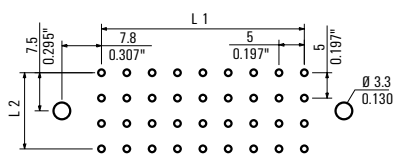

Additional deratings curves

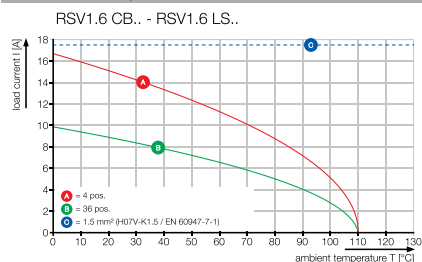

Connectors in 5.00 mm pitch Series RSV

RSV1.6 LB.. AU

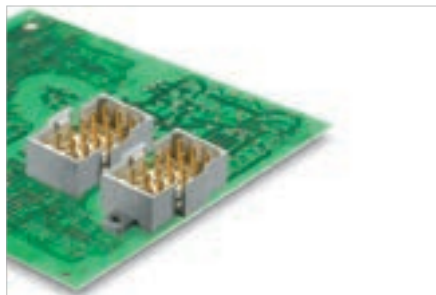

Rectangular plug-in female connector with solder contacts for PCB applications. High connection density achieved by using several rows and crimp contacts in the mating connector. The plug-in connectors can be coded and locked to the mating connector. Supplied in cardboard box.

Technical data

In compliance with IEC 60664-1 / IEC 61984

Clamping range, max.			
Solid core H05(07) V-U			
Stranded H07 V-R			
Flexible H05(07) V-K			
Flexible with ferrule			
Ferrule with plastic collar			
Stripping length			
Screwdriver blade	mm		
According to norm			
Tightening torque range			
Rated current, max.	A	14	12
At ambient temperature		20°C	40°C
For conductor cross-section			
Overvoltage category		III	III II
Pollution severity		3	2 2
Rated voltage	V	250	320 500
Rated impulse voltage	kV	4	2.5 2.5
UL / CUL (Use Group)	B	C	D
Rated voltage	300		
Rated current	10		
AWG conductor	AWG	-	
CSA (Use Group)	B	C	D
Rated voltage	300		
Rated current	13		
AWG conductor	AWG	-	
General data			
Type of insulation material	PA		
UL 94 flammability rating	V-0		
Contact base material	Copper alloy		
Material of contact surface	Gold-plated		
Pin dimensions = d	mm	0.97	
Solder eyelet Ø = D	mm	1.3	
Solder eyelet Ø tolerance	mm	+ 0,1	

Product data

IEC: 500 V / 14 A
UL: 300 V / 10 A



For additional articles and information, refer to catalog.weidmueller.com

Note:

- Additional colours on request
- Rated current related to rated cross-section & min. No. of poles.
- Spacing between rows: see hole layout
- Rated data refer only to the component itself. Clearance and creepage distances to other components are to be designed in accordance with the relevant application standards.

RSV1.6 LB.. AU



Dimensioned drawing

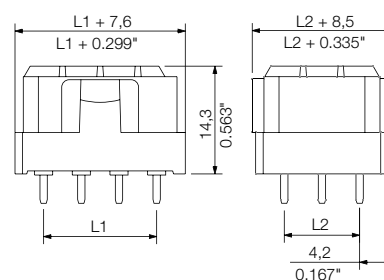

Accessories

Note: Refer to the Accessories chapter for additional accessories.

Coding	Order No.
RSV1,6 K0	1567430000

Ordering data

Solder pin length		3.2 mm	
Colour		Pebble grey	
Pitch	5.00 mm		
Pol.	L1	(inch)	Qty. Order No.
4	5.00	0.197	100 1440200000
6	10.00	0.394	50 1441200000
9	10.00	0.394	50 1442200000
12	15.00	0.591	25 1443200000
18	25.00	0.984	25 1444200000
24	25.00	0.984	20 1445200000
36	40.00	1.575	10 1446200000

Representative deratings curve

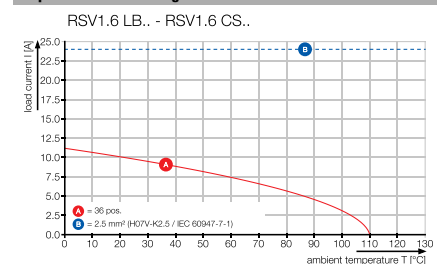

RSV1.6 LBF.. AU



Dimensioned drawing

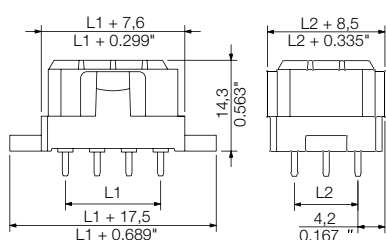

Ordering data

Solder pin length		3.2 mm		
Colour		Pebble grey		
Pitch		5.00 mm		
Pol.	L1	(inch)	Qty.	Order No.
4	5.00	0.197	100	1440600000
6	10.00	0.394	50	1441600000
9	10.00	0.394	50	1442600000
12	15.00	0.591	25	1443600000
18	25.00	0.984	25	1444600000
24	25.00	0.984	20	1445600000
36	40.00	1.575	10	1446600000

Drilling diagrams

4-pole

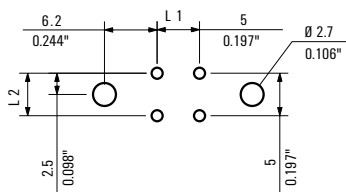

6-pole

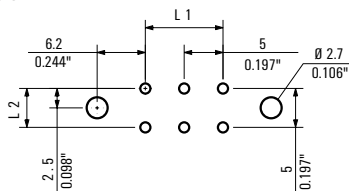

9-pole

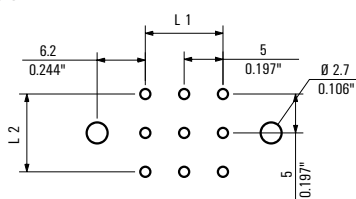

12-pole

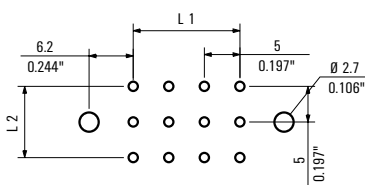

18-pole

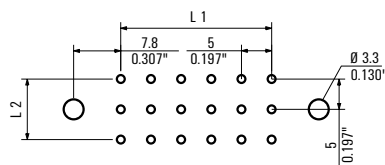

24-pole

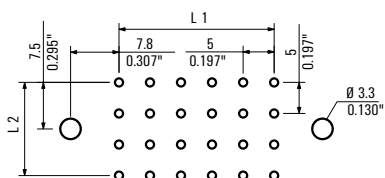

36-pole

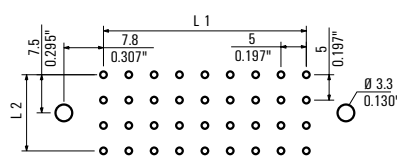

Additional deratings curves

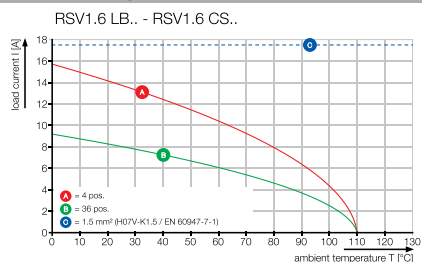

Connectors in 5.00 mm pitch Series RSV

RSV1.6 CS.. & CB..



Rectangular plug-in connector for use with crimp contacts. Can be used as universal coupling, but also with the PCB variations. The crimp contacts guarantee a high connection density. The CS 1.6 or CB 1.6 contacts are used here. The connectors can be coded and locked together with their mates. Supplied in cardboard box.

Technical data

In compliance with IEC 60664-1 / IEC 61984			
Clamping range, max.	mm ²	0.13...3.31	
Solid core H05(07) V-U			
Stranded H07 V-R	mm ²	0.2...2.5	
Flexible H05(07) V-K	mm ²	0.2...2.5	
Flexible with ferrule			
Ferrule with plastic collar			
Stripping length	mm	4	
Screwdriver blade	mm		
According to norm			
Tightening torque range			
Rated current, max.	A	17	15
At ambient temperature	20°C	40°C	
For conductor cross-section		III	II
Overvoltage category	V	250	400 630
Pollution severity		3	2 2
Rated voltage	V	250	400 630
Rated impulse voltage	kV	4	4 4
UL / CUL (Use Group)		B	C D
Rated voltage			
Rated current			
AWG conductor	AWG		
CSA (Use Group)		B	C D
Rated voltage		600	
Rated current		13	
AWG conductor	AWG	26-12	
General data			
Type of insulation material		PA	
UL 94 flammability rating		V-0	
Contact base material		Copper alloy	
Material of contact surface			
Pin dimensions = d	mm		
Solder eyelet Ø = D	mm		
Solder eyelet Ø tolerance	mm		

Product data

IEC: 630 V / 17 A
UL: 600 V / 10 A / AWG 26 - 12



For additional articles and information, refer to catalog.weidmueller.com

Note:

- Additional colours on request
- Rated current related to rated cross-section & min. No. of poles.
- Spacing between rows: see hole layout
- Rated cross-section depends on crimp contact used.
- Rated data refer only to the component itself. Clearance and creepage distances to other components are to be designed in accordance with the relevant application standards.
- Max. outer diameter of the cable (with insulation): 3.5 mm

RSV1.6 CS..



Dimensioned drawing

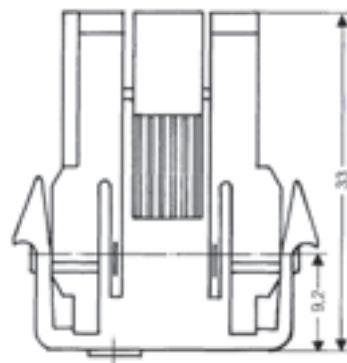

Ordering data

Solder pin length					
Colour					Pebble grey
Pitch	5.00 mm		Qty.	Order No.	
4	5.00	0.197	25	1413100000	
6	10.00	0.394	25	1414100000	
9	10.00	0.394	25	1415100000	
12	15.00	0.591	25	1416100000	
18	25.00	0.984	25	1417100000	
24	25.00	0.984	20	1418100000	
36	40.00	1.575	10	1419100000	

Accessories

Note: Refer to the Accessories chapter for additional accessories.

Release tool		Order No.
	DW RSV 1.6	9004530000
Pressing tool		
	HTF RSV 16	9013560000
Clip-in foot		
	RSV1,6 RF12/35X15 SW	1690140000
	RSV1,6 RF12/35X7.5 SW	1582940000
	RSV1,6 RF18/35X15 SW	1690150000
	RSV1,6 RF18/35X7.5 SW	1582950000
	RSV1,6 RF24/35X15 SW	1690160000
	RSV1,6 RF24/35X7.5 SW	1582960000
	RSV1,6 RF36/35X15 SW	1690170000
	RSV1,6 RF36/35X7.5 SW	1582970000
	RSV1,6 RF4/35X15 SW	1690110000
	RSV1,6 RF4/35X7.5 SW	1582910000
	RSV1,6 RF6/35X15 SW	1690120000
	RSV1,6 RF6/35X7.5 SW	1582920000
	RSV1,6 RF9/35X15 SW	1690130000
	RSV1,6 RF9/35X7.5 SW	1582930000
Strain relief		
	RSV1,6 ZE12 BK BX	1563300000
	RSV1,6 ZE18 BK BX	1563200000
	RSV1,6 ZE24 BK BX	1563100000
	RSV1,6 ZE36 BK BX	1563000000
	RSV1,6 ZE04 BK BX	1563600000
	RSV1,6 ZE06 BK BX	1563500000
	RSV1,6 ZE09 BK BX	1563400000
Coding		
	RSV1,6 KO	1567430000

Representative deratings curve

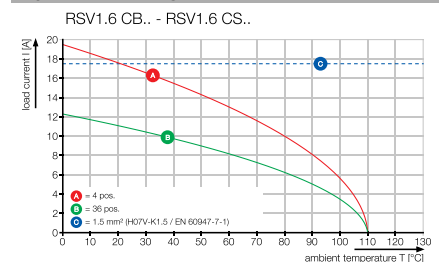

RSV1.6 CB..

Mounting cutout



Dimensioned drawing

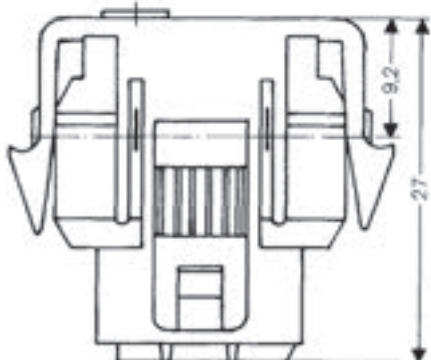

- Spring clips ensure firm hold in enclosure wall

Ordering data

Solder pin length				
Colour				Pebble grey
Pitch		5.00 mm		
Pol.	L1	(inch)	Qty.	Order No.
4	5.00	0.197	25	1413000000
6	10.00	0.394	25	1414000000
9	10.00	0.394	25	1415000000
12	15.00	0.591	25	1416000000
18	25.00	0.984	25	1417000000
24	25.00	0.984	20	1418000000
36	40.00	1.575	10	1419000000

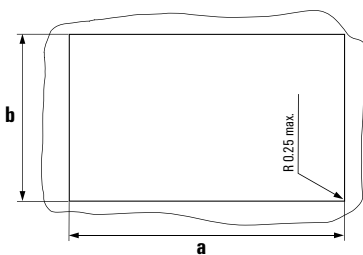

Mounting cutout for enclosure RSV 1.6
Wall thickness 1.5...2.0 mm

No. of poles	Dim. a (mm)*	Dim. b (mm)*
4	20.3	17.8
6	25.1	18.1
9	25.1	24.0
12	30.0	24.0
18	40.5	24.0
24	40.5	28.3
36	55.5	28.3

*) Tolerance: +0.3 mm

Contact system CB 1.6 / CS 1.6

CB 1.6 / CS 1.6

Crimp contacts

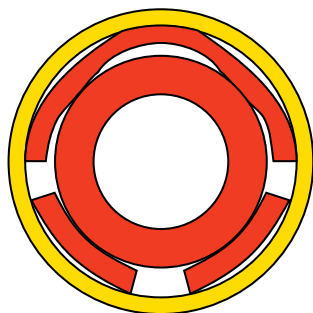
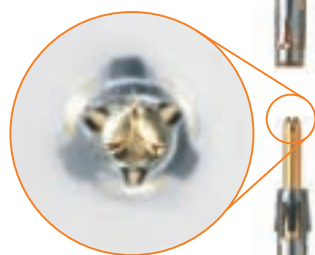
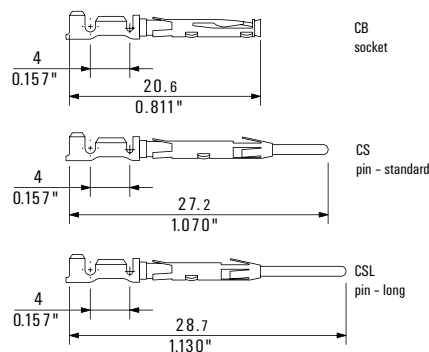

Ordering data

Tinned contacts			
For cable size mm ²	AWG	Insulation diameter mm	
0.14 - 0.25	26 - 24	0.8 - 1.4	pin - standard
			pin - long
			socket
0.34 - 0.5	22 - 20	1.1 - 1.8	pin - standard
			pin - long
			socket
0.34 - 0.5	22 - 20	2.0 - 2.5	pin - standard
			pin - long
			socket
0.75 - 1.5	18 - 16	2.0 - 2.5	pin - standard
			pin - long
			socket
0.75 - 1.5	18 - 16	2.0 - 3.5	pin - standard
			pin - long
			socket
2.5	14 - 12	2.8 - 3.5	pin - standard
			pin - long
			socket
2.5	14 - 12	2.8 - 4.2	pin - standard
			pin - long
			socket

Separate contacts		Cont. on a strip	
Order No.	Qty.	Order No.	Qty.
1421600000	250	1421500000	5000
1421700000	250	1565900000	5000
1421900000	250	1421800000	5000
1423600000	250	1423500000	5000
1423700000	250	1565870000	5000
1423900000	250	1423800000	5000
1425600000	250	1425500000	5000
1425700000	250	1565840000	5000
1425900000	250	1425800000	5000
1427600000	250	1427500000	5000
1427700000	250	1565810000	5000
1427900000	250	1427800000	5000
1582270000	250	1582280000	3000
1582350000	250	1582360000	3000
1582430000	250	1582440000	3000
1429600000	250	1429500000	3000
1429700000	250	1565780000	3000
1429900000	250	1429800000	3000
1582310000	250	1582320000	3000
1582390000	250	1582400000	3000
1582470000	250	1582480000	3000

Ordering data

Tinned contacts			
For cable size mm ²	AWG	Insulation diameter mm	
0.14 - 0.25	26 - 24	0.8 - 1.4	Stift - standard
			pin - long
			socket
0.34 - 0.5	22 - 20	1.1 - 1.8	Stift - standard
			pin - long
			socket
0.34 - 0.5	22 - 20	2.0 - 2.5	Stift - standard
			pin - long
			socket
0.75 - 1.5	18 - 16	2.0 - 2.5	Stift - standard
			pin - long
			socket
0.75 - 1.5	18 - 16	2.0 - 3.5	Stift - standard
			pin - long
			socket
2.5	14 - 12	2.8 - 3.5	Stift - standard
			pin - long
			socket
2.5	14 - 12	2.8 - 4.2	Stift - standard
			pin - long
			socket

Separate contacts		Cont. on a strip	
Order No.	Qty.	Order No.	Qty.
1420600000	250	1420500000	5000
1420700000	250	1565880000	5000
1420900000	250	1420800000	5000
1422600000	250	1422500000	5000
1422700000	250	1565850000	5000
1422900000	250	1422800000	5000
1424600000	250	1424500000	5000
1424700000	250	1565820000	5000
1424900000	250	1424800000	5000
1426600000	250	1426500000	5000
1426700000	250	1565790000	5000
1426900000	250	1426800000	5000
1582250000	250	1582260000	3000
1582330000	250	1582340000	3000
1582410000	250	1582420000	3000
1428600000	250	1428500000	3000
1428700000	250	1565760000	3000
1428900000	250	1428800000	3000
1582290000	250	1582300000	3000
1582370000	250	1582380000	3000
1582450000	250	1582460000	3000

- Safe centring of the contacts using the three-segment pin tips
- 4 defined contact points ensure high contact stability
- Lugs in the enclosing steel spring ensure the contact engages securely in the housing
- Pin contacts with two lengths to implement leading-pin contacts
- Up to 100 plugging cycles (tin version)
- Up to 500 plugging cycles (gold version)

OMNIMATE® Signal Accessories

OMNIMATE® Signal Accessories	Strain relief	N.2
	Snap-on foot	N.3
	Covers	N.4
	Lock / Fixing blocks	N.5
	Light guides	N.8
	Coding elements	N.10
	Dividing element	N.11
	Test plug	N.12
	Identification systems	N.13
	Crimping tools	N.14
	Disengaging tool / Removal tool	N.15
	Screwdrivers	N.16

Strain relief

BL 3.50 ZE
BLZF 3.50 ZE

Strain relief



- Supports and protects the cable connections when removing the plug-in connector and during normal operation.
- Helpful when inserting and removing plug-in connector.

BLZ 5.00 ZE
BLZ 5.08 ZE

Strain relief



- Supports and protects the cable connections when removing the plug-in connector and during normal operation.
- Helpful when inserting and removing plug-in connector.

BLT ZE

Strain relief



- Supports and protects the cable connections when removing the plug-in connector and during normal operation.
- Helpful when inserting and removing plug-in connector.

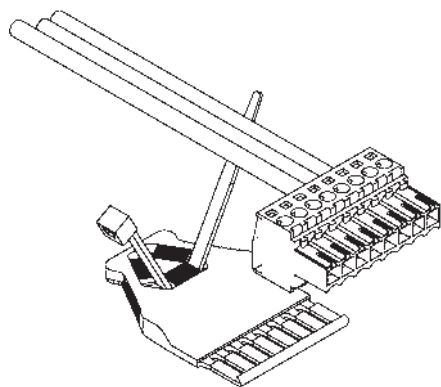

Ordering data

Colour		Orange	Black
No. of poles	Qty.	Order No.	Order No.
from 3	50	1629680000	1627820000
from 8	50	1629690000	1627830000

Ordering data

Colour		Orange	Black
No. of poles	Pitch (mm)	Qty.	Order No.
from 4	5,00	50	1652100000
from 8	5,00	50	1652040000
from 4	5,08	50	1652110000
from 8	5,08	50	1652050000

Ordering data

Colour		Orange
No. of poles	Qty.	Order No.
from 4	50	1577980000
from 9	50	1578010000

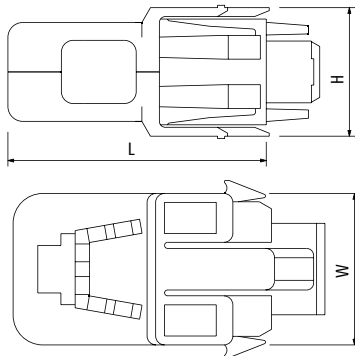
RSV ZE**Strain relief****Ordering data**

Pole	W (mm)	L (mm)	H (mm)	Qty.	Order No.
4	20,50	39,00	22,20	10	1563600000
6	25,50	44,00	22,40	10	1563500000
9	25,50	44,00	28,40	10	1563400000
12	33,00	51,50	28,60	10	1563300000
18	40,00	58,50	28,60	10	1563200000
24	40,00	58,50	28,60	10	1563100000
36	55,00	73,50	32,60	10	1563000000

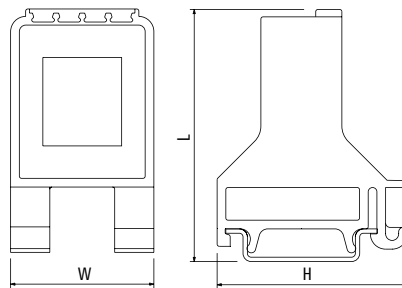
RSV RF**Snap-on foot for terminal rail****Ordering data**

Snap-on foot for TS 35 x 7.5					Black
Pole	W (mm)	L (mm)	H (mm)	Qty.	Order No.
4	32,90	58,90	43,70	10	1582910000
6	32,90	58,90	43,70	10	1582920000
9	32,90	58,90	43,70	10	1582930000
12	32,90	58,90	43,70	10	1582940000
18	37,30	83,40	43,70	10	1582950000
24	37,30	83,40	43,70	10	1582960000
36	37,30	83,40	43,70	10	1582970000

Snap-on foot for TS 35 x 15					
Pole	W (mm)	L (mm)	H (mm)	Qty.	Order No.
4	32,90	65,40	43,70	10	1690110000
6	32,90	65,40	43,70	10	1690120000
9	32,90	65,40	43,70	10	1690130000
12	32,90	65,40	43,70	10	1690140000
18	37,30	90,90	43,70	10	1690150000
24	37,30	90,90	43,70	10	1690160000
36	37,30	90,90	43,70	10	1690170000

B2L 3.50 AH

Cover

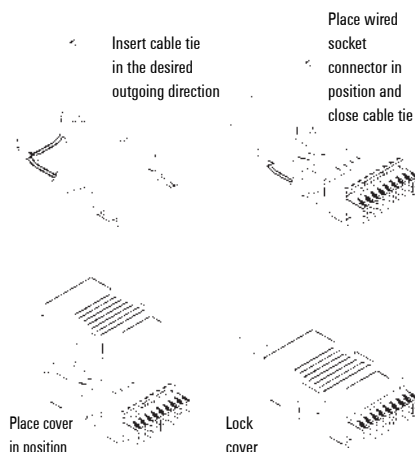
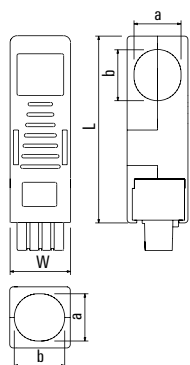

Ordering data

Pole	W (mm)	L (mm)	a (mm)	b (mm)	Qty.	Order No.
6	10,50	39,80	9,55	8,00	10	1781560000
8	14,00	39,80	9,55	8,00	10	1781570000
10	17,50	39,80	13,60	9,00	10	1781580000
12	21,00	39,80	13,60	9,00	10	1781590000
14	24,50	39,80	13,60	20,00	10	1781600000
16	28,00	39,80	13,60	20,00	10	1781610000
18	31,50	53,80	13,60	20,00	10	1781620000
20	35,00	53,80	13,60	20,00	10	1781630000
22	38,50	53,80	13,60	20,00	10	1781640000
24	42,00	53,80	13,60	20,00	10	1781650000
26	45,50	53,80	13,60	20,00	10	1781660000

BL 3.50 AH

Cover

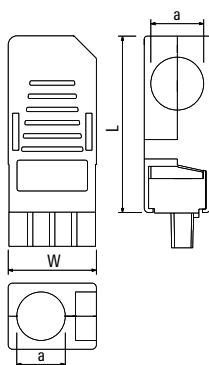

Ordering data

Pole	W (mm)	L (mm)	a (mm)	b (mm)	Qty.	Order No.
2	-	-	-	-	-	-
3	10,50	30,00	8,50	-	10	1745580000
4	14,00	30,00	8,50	-	10	1745590000
5	17,50	30,00	8,50	-	10	1745600000
6	21,00	30,00	8,50	-	10	1745610000
7	24,50	40,00	11,00	-	10	1745620000
8	28,00	40,00	11,00	-	10	1745630000
9	31,50	40,00	11,00	-	10	1745640000
10	35,00	40,00	11,00	-	10	1745650000
11	38,50	40,00	11,00	-	10	1745660000
12	42,00	40,00	11,00	-	10	1745670000

BCZ 3.81 AH

Cover

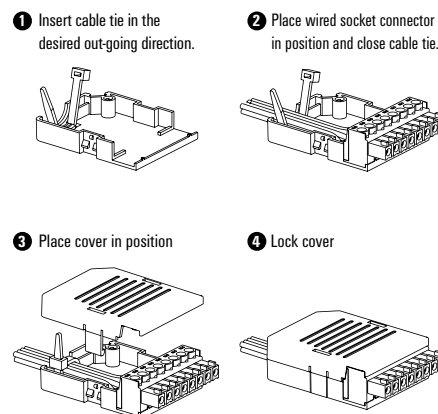
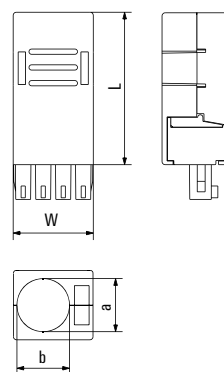

Ordering data

Pole	W (mm)	L (mm)	a (mm)	b (mm)	Qty.	Order No.
2	-	-	-	-	-	-
3	11,43	29	10	10	10	1005280000
4	15,24	29	10	10	10	1005290000
5	19,05	29	10	10	10	1005300000
6	22,86	29	10	10	10	1005310000
7	26,67	39	10	12,5	10	1005320000
8	30,48	39	10	12,5	10	1005330000
9	34,29	39	10	12,5	10	1005340000
10	38,1	39	10	13	10	1005350000
11	41,91	39	10	13,8	10	1005360000
12	45,72	39	10	14,6	10	1005370000

BL/SL 3.50 VR

Lock



- Simple, screw-less, vibration-proof mechanism for all single-row male connectors in conjunction with the standard 180° screw terminal socket connector BL 3.5.
- 2 VR locks are recommended for plug-in connectors with more than 8 poles.

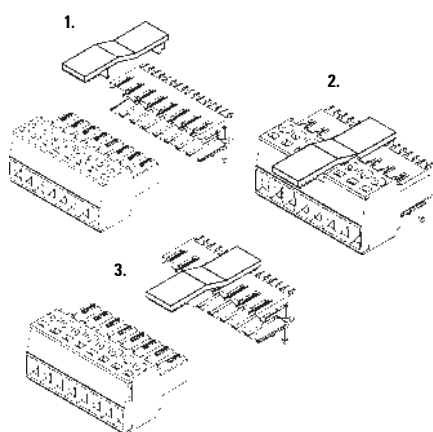

Ordering data

Colour		Orange	Black
No. of poles	Qty.	Order No.	Order No.
BL/SL 3.50 VR	100	1669310000	1669300000

SLDF VR

Lock



- For vibration-proof plug-in connections
- Socket must be B-Version with dovetail

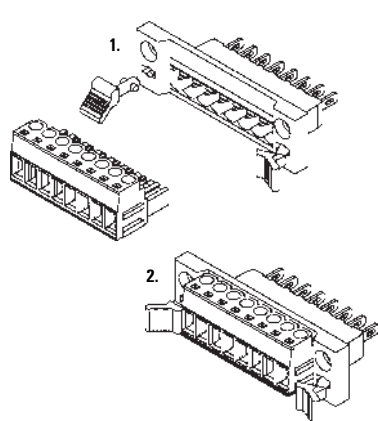

Ordering data

Colour		Black
Type	Qty.	Order No.
SLDF VR	100	1599120000

BBDF

for universal feed-through-connection



Assembly Instruction

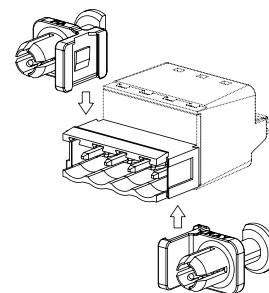

view of BBDF inside the panel

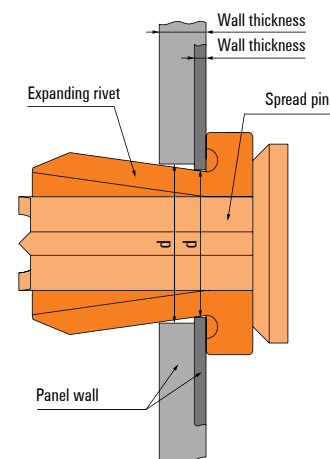

Ordering data

Colour		Orange	Black
Type	Width (mm)	Qty.	Order No.
BBDF	9,5	100	1307570000
			1307580000

Fixing blocks

SLA BB1R SLA BB11R

Mounting blocks for headers, in 5.0x-mm pitch

SLA BB11R



SLA BB1R

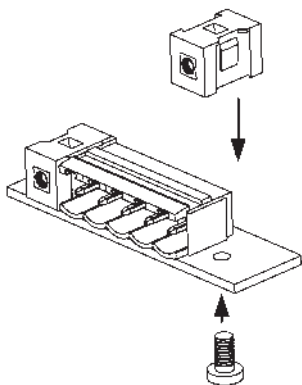
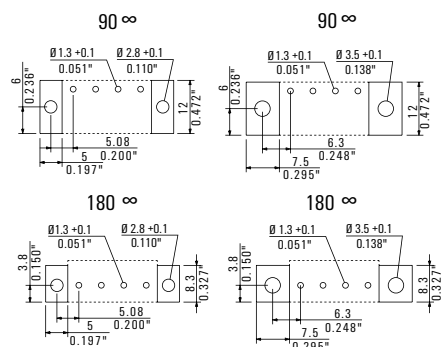

SLA BB2R SLA BB12R

Mounting blocks for plugs, in 5.0x-mm pitch

SLA BB12R



SLA BB2R

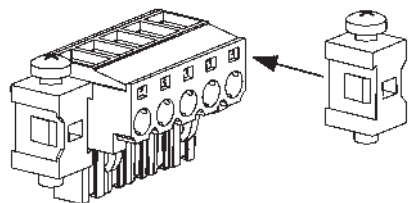

SL 135 BB15R

Mounting blocks for SL 135 male header

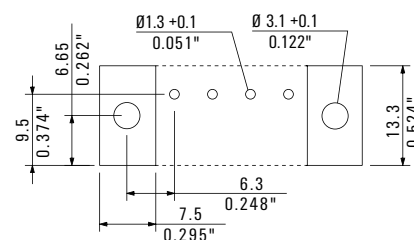

Ordering data

Colour	Orange	Black
Type	Order No.	Order No.
SLA BB1R	1723430000	1723480000
SLA BB11R	1604120000	1692340000

Ordering data

Colour	Orange	Black
Type	Order No.	Order No.
SLA BB2R	1723440000	1723490000
SLA BB12R	1593450000	1626880000

Ordering data

Colour	Orange	Black
Type	Order No.	Order No.
SL135 BB15R	1606450000	1636370000

SLA BB14

Mounting blocks for SLD 5.08 headers

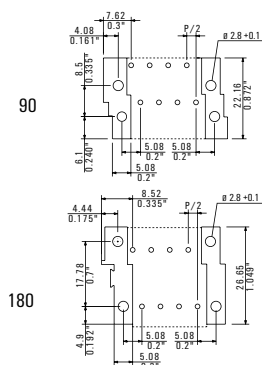

- Provides additional mechanical support for rows of male connectors on the PCB
- Also enables vibration-proof connections for the matching socket connectors.
- BB12 fixing blocks or an integral screw flange are required for the socket.
- Caution: Only to be used with SLD 5.08 90 / SLD 5.08 180.

Ordering data

Colour	Orange	Black
Type	Qty.	Order No.
SLA BB14	5,0	20
	Order No.	Order No.
	1594200000	1774460000

LPBB

PCB fixing block

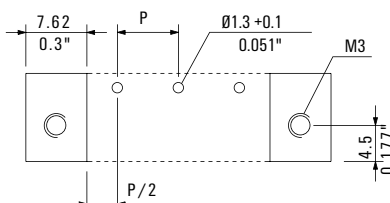

- Provides additional mechanical support for terminals LP, LP1N and LP 1H.
 - Can also be supplied with captive nut (LPBB MU).
- Ordering

Ordering data

Colour	Orange	Black
Type	Qty.	Order No.
LPBB	100	1747540000
LPBB MU	100	1747530000

TOP 1.5 BB

Fixing block for TOP 1.5 GS terminals

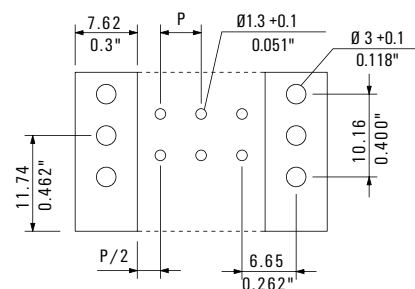

- Provides additional mechanical support for TOP 1.5 GS terminals.
- Supplied complete with 2.9 x 19 mm self-tapping screw.

Ordering data

Colour	Orange	Black
Type	Qty.	Order No.
TOP1.5 BB	20	1539860000

S2L FLA

Light guide

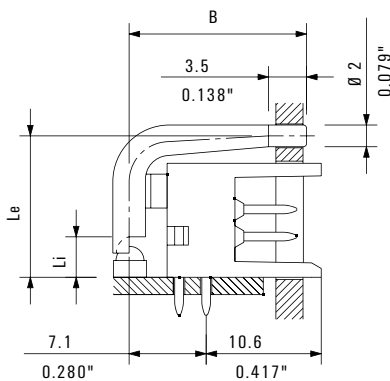
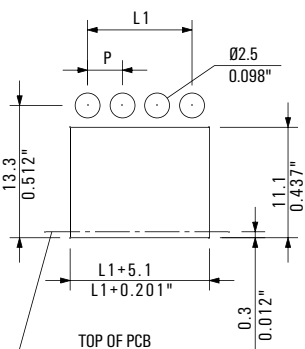

Ordering data

Pole	Li (mm)	Le (mm)	B (mm)	Qty.	Order No.
10	3,70	13,00	16,35	100	1699580000

S2L-SMT FLA

Light guide

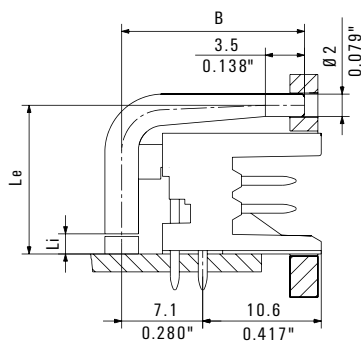
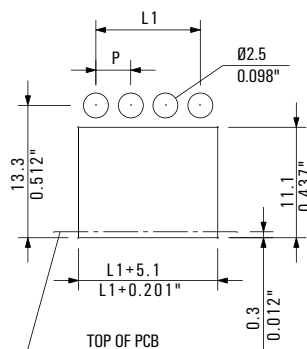

Ordering data

Pole	Li (mm)	Le (mm)	B (mm)	Qty.	Order No.
10	1,80	13,30	16,35	50	1814590000

SL 3.50 FLA

Light guide

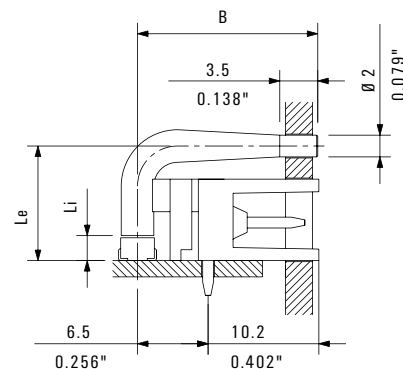
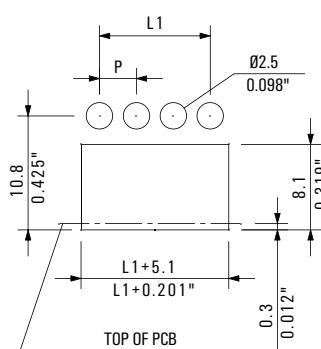

Ordering data

Pole	Li (mm)	Le (mm)	B (mm)	Qty.	Order No.
8	1,50	10,55	16,60	50	1597510000
8	2,30	10,55	16,60	50	1597520000
8	4,00	10,55	16,60	50	1597530000
8	1,50	10,55	14,85	50	1597630000
8	2,30	10,55	14,85	50	1597640000
8	4,00	10,55	14,85	50	1597650000

SC 3.81 FLA

Light guide

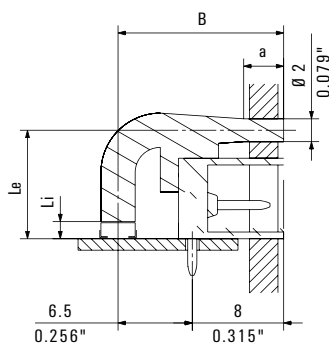
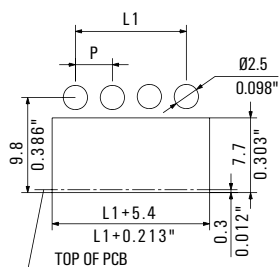

Ordering data

Pole	Li (mm)	Le (mm)	B (mm)	Qty.	Order No.
8	1,5	9,50	14,25	50	1979730000
8	2,3	9,50	14,25	50	1979750000
8	1,5	9,50	16,00	50	1979720000
8	2,3	9,50	16,00	50	1979740000

SL 5.08 FLA

Light guide

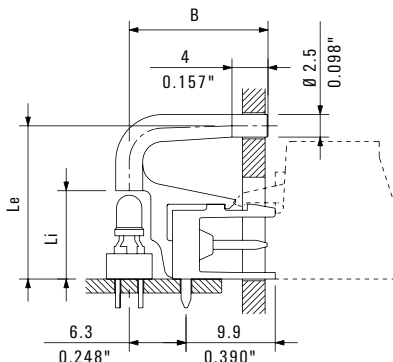
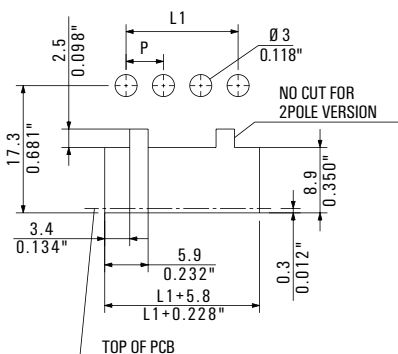

Ordering data

Pole	Li (mm)	Le (mm)	B (mm)	Qty.	Order No.
1	1,50	17,00	15,40	100	1580100000
1	2,30	17,00	15,40	100	1636670000
1	3,80	17,00	15,40	100	1580110000
1	9,00	17,00	15,40	100	1580120000
24	2,30	17,00	15,40	10	1636680000

B2L/S2L KO – B2CF/S2C KO

Coding element



- For coding plug-in connectors to prevent errors during installation.
- Suitable for plug and socket connectors.
- The coding does not block any poles.
- For reliable coding, we recommend at least 2 polarising pins per connector for 10-way and above

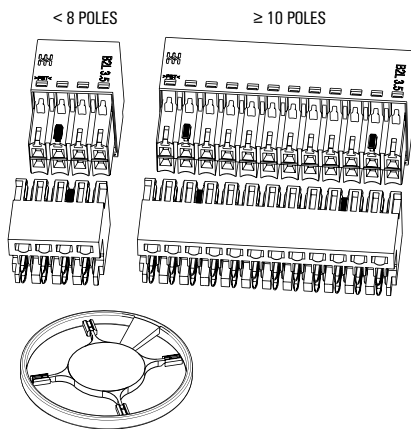

Ordering data

Colour		Orange	Black
Type	Qty.	Order No.	Order No.
B2L/S2L KO	100	1849730000	1849740000

BL/SL 3.50 KO

Coding element



- For coding plug-in connectors to prevent errors during installation.
- Suitable for plug and socket connectors.
- The coding does not block any poles.
- A coding star includes 2 coding elements of different sizes. The larger of the two is used on the male connector.

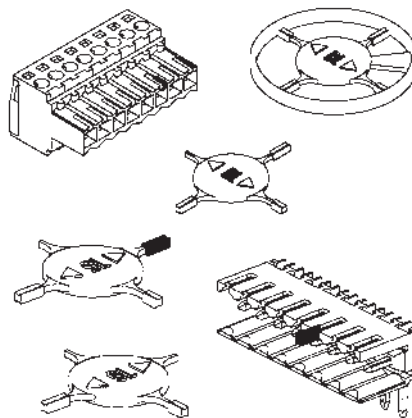

Ordering data

Colour		Orange	Black
Type	Qty.	Order No.	Order No.
BL/SL 3.5 KO	100	1693430000	1610100000

SC-SMT 3.81 KO

Coding element



- For coding connectors in order to prevent mistakes during installation
- Only for male headers (SC..3.81..).
- Female headers (BCZ 3.81, BCF 3.81 and BCL-SMT 3.81) are coded using diagonal-cutting pliers. The coding does not occupy a pole.

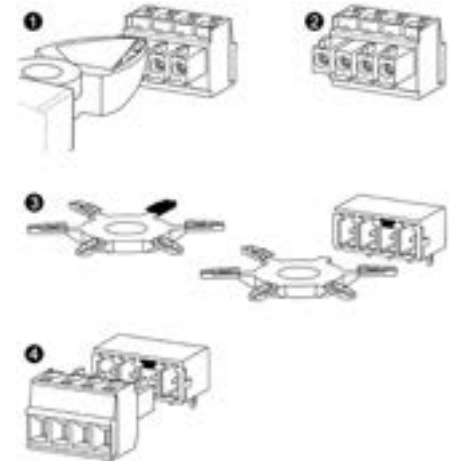

Ordering data

Colour		Grey
Type	Qty.	Order No.
SC-SMT 3.81 KO WT BX	100	2467670000

1 unit = 6 coding elements

BLZ/SL KO

Coding element



- For coding plug-in connectors to prevent errors during installation.
- Suitable for plug and socket connectors.
- The coding does not block any poles.
- Coding element for the BL/SL 5.00 and BL/SL 5.08 series

RSV 1.6 KO

Coding element



- For coding plug-in connectors to prevent errors during installation.
- Suitable for plug and socket connectors.
- The coding blocks individual poles.

SLAT

Dividing element



- Subdivides male connectors into distinct segments.
- Prevents errors during installation.



Ordering data

Colour	Orange		Black	
Type	Qty.	Order No.	Order No.	
BLZ/SL KO	100	1573010000	1545710000	

Ordering data

Colour	Black		
Type	Qty.	Order No.	
RSV 1.6 KO	50	1567430000	

Ordering data

Colour	Orange		Black	
Type	Qty.	Order No.	Order No.	
SLAT	100	1598300000	1770240000	

Test plug

PS 2.0 MC

Test plug



- For conductors up to 0.75 mm² (AWG 18).
- Gold-plated lantern-type contact.
- Conductor must be soldered to contact in test plug.

Ordering data

Type	Conductor size	Qty.	Order No.
PS 2.0 MC	≤ 0,75 mm ²	20	031000000

KSW 4 / KSW 2.5

Marking strips



KSW marking strips are suitable for labelling multi-pole PCB terminals and connectors. The white, self-adhesive strips are made from a non-PVC, environmentally friendly material. These marking strips provide individual printing, i.e. are suitable for every pitch. Available in two widths: 2.5 and 4.0 mm.

Technical data

Material data	
Material	polyester with white surface
Adhesive	acrylic base
Temperature range	-40 °C to +150 °C
Min. bonding temperature	+4 °C
Flammability	self-extinguishing after 15 s

No. of marking strips per sheet
up to 20 poles = 20 strips per sheet
* more than 20 poles = 15 strips per sheet

Ordering example
Order No. 1630060001

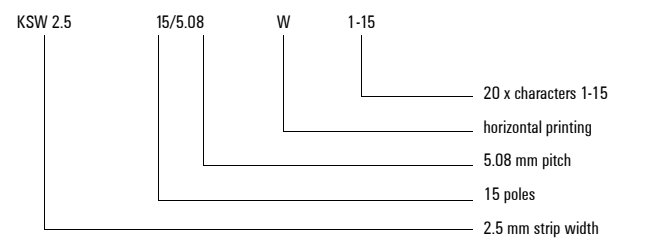

Printed strips

KSW 4	Pitch			
	3.50 mm	5.00 mm	5.08 mm	7.62 mm
Char.	1629910000	1629910000	1630200001	1629930000
1-8	-	-	-	1629930000
1-12	-	-	-	-
1-16	1630150001	1629930000	1630160001	-
1-24*	1629930000	1700710001	1630180001	-

KSW 2.5	Pitch			
	3.50 mm	5.00 mm	5.08 mm	7.62 mm
Char.	-	1629900000	1630100001	-
1-8	-	1629900000	1630100001	-
1-12	-	-	-	-
1-16	1629920000	1629920000	1713970001	-
1-24*	1652250001	1629940000	1629940000	-

Blank strips

	Length of strip		
	50 mm	100 mm	150 mm
KSW 4	1629910000	1629930000	1629950000
KSW 2.5	1629900000	1629920000	1629940000

Custom printing to specification

	Length of strip		
	50 mm	100 mm	150 mm
KSW 4	1629910000	1629930000	1629950000
KSW 2.5	1629900000	1629920000	1629940000

Direct printing



We can also print directly on your plug and socket connectors to your specification. Please ask for details.

Crimping tools

HTF 28 HTF 63

Crimping tools



- Precision crimping tool with ratchet for 2.80 and 6.30 mm spade connections with open or rolled terminals
- HTF 28 for flexible conductors 0.10-1.00 mm² (AWG 26-16)
- HTF 63 for flexible conductors 0.50-2.50 mm² (AWG 20-14)

Ordering data

Type	Crimp size mm/inch	Cross-section mm ² /AWG	Order No.
HTF 28	2,8/0,110	0,14-1,5/26-16	9013090000
HTF 63	6,3/0,250	0,50-2,5/20-14	9013400000

HTF DFF

Crimping tools



- Precision crimping tool with ratchet for the Weidmüller DFFC crimp contacts of BLC and BLAC socket connectors
- 0.22-0.35 mm² (AWG 24-22)
- 0.50-1.00 mm² (AWG 20-17)
- 1.50-2.50 mm² (AWG 16-12)

Ordering data

Type	Cross-section mm ² /AWG	Order No.
HTF DFF	0,22-2,5/24-12	9014140000

HTF RSV 12 HTF RSV 16

Crimping tools



- Precision crimping tool with ratchet for the Weidmüller CB and CS crimp contacts of RSV 1.6 plug-in connectors
- RSV 16 = 0.14 - 1.50 mm² (AWG 26-16)
- RSV 12 = 1.50 - 2.50 mm² (AWG 14-12)

Ordering data

Type	Cross-section mm ² /AWG	Order No.
HTF RSV 16	0,14-1,5/26-16	9013560000
HTF RSV 12	1,50-2,5/14-12	9013550000

DFFC EW2

Disengaging tool



DW RSV

Disengaging tool

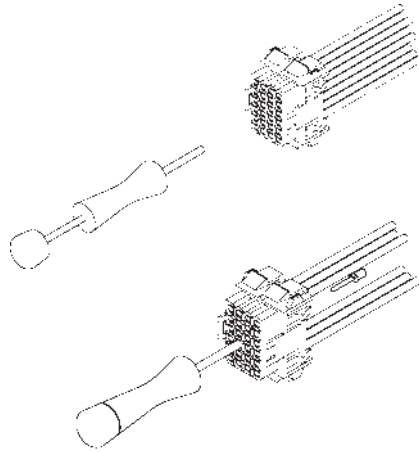

Ordering data

Type	Qty.	Order No.
DFFC EW2	1	1803790000

Ordering data

Type	Qty.	Order No.
DW RSV 1.6	1	9004530000

SDI

VDE-insulated slotted screwdriver

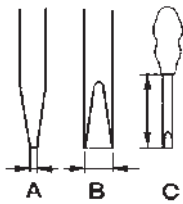

VDE-insulated slotted screwdriver, SDI

- SDI DIN 7437, ISO 2380/2
- Drive output acc. to DIN EN ISO/IEC 60900 and DIN ISO 2380



Ordering data

Type	Dims. (mm)	A	B	C	Order No.
SDI	0,4	2,5	75		2749790000
SDI	0,5	3,0	100		2749800000
SDI	0,6	3,5	100		2749810000
SDI	0,8	4,0	100		2749820000
SDI	1,0	4,5	125		2749830000
SDI	1,0	5,5	125		2749850000
SDI	1,2	6,5	150		2749860000
SDI	1,6	8,0	175		2749870000

SD

Slotted screwdriver with round blade

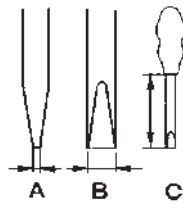

Slotted screwdriver with round blade, SD

- SD DIN 5265, DIN ISO 2380
- Drive output acc. to DIN 5264, DIN ISO 2380/1
- ChromTop tip



Ordering data

Type	Dims. (mm)	A	B	C	Order No.
SD	0,4	2,5	75		2749320000
SD	0,5	3,0	80		2749330000
SD	0,6	3,5	100		2749340000
SD	0,8	4,0	100		2749360000
SD	0,8	4,5	125		2749370000
SD	1,0	5,5	150		2749380000
SD	1,2	6,5	150		2749390000

SDK PH/PZ

Crosshead screwdriver



Crosshead screwdriver PH (Philips)

- SDK PH DIN 5262, DIN ISO 8764-PH
- Drive output acc. to DIN ISO 8764-PH
- ChromTop tip



Crosshead screwdriver PZ (Pozidrive)

- SDK PZ DIN 5262, DIN ISO 8764-PZ
- Drive output acc. to DIN ISO 8764-PZ
- Chrome top tip



Ordering data PH

Type	Dims. (mm)	A	B	C	Order No.
SDK PH0	0			60	2749400000
SDK PH1	1			80	2749410000
SDK PH2	2			100	2749420000
SDK PH3	3			150	2749430000

Ordering data PZ

Type	Dims. (mm)	A	B	C	Order No.
SDK PZ1	1			80	2749440000
SDK PZ2	2			100	2749450000
SDK PZ3	3			150	2749460000

Tension clamp terminal tool

Tool for PCB terminals with tension clamp connection



SD 0.6 x 3.5 x 100 (DIN 5264-A)

You do not need any special tool to connect or disconnect our tension clamp connection.

The opening is designed to accommodate a standard 0.6 x 3.5 x 100 screwdriver 9008330000 to DIN 5264-A (with flat blade).

OMNIMATE® Power PCB terminals

**OMNIMATE® Power
PCB terminals**

Clamping yoke screw connection

Explanation	0.2
Quick selection	0.12
Product selection	0.16

PUSH IN-spring connection

Explanation	0.6
Quick selection	0.14
Product selection	0.26

OMNIMATE® Power – LL 6.35 power terminal

Unrestricted use up to 600 V to UL 1059 approval in 6.35 mm pitch

Your device connections increasingly require international approval to UL 1059 to 600 V. We offer you the matching power terminal in 6.35 mm pitch.

International UL certification for 600 V is an important factor for many power electronics applications. The wiring must also be safe and maintenance-free and meet the high insulator requirements.

Our LL 6.35 power terminal meets all the certification criteria unrestricted. Not only is it especially safe, but it has an extremely compact 6.35 mm pitch design.

You will receive a maintenance-free solution with proven clamping yoke screw technology for conductors up to 6 mm². Ideal for device connections in drive technology, power supply, solar inverter and line filter applications.

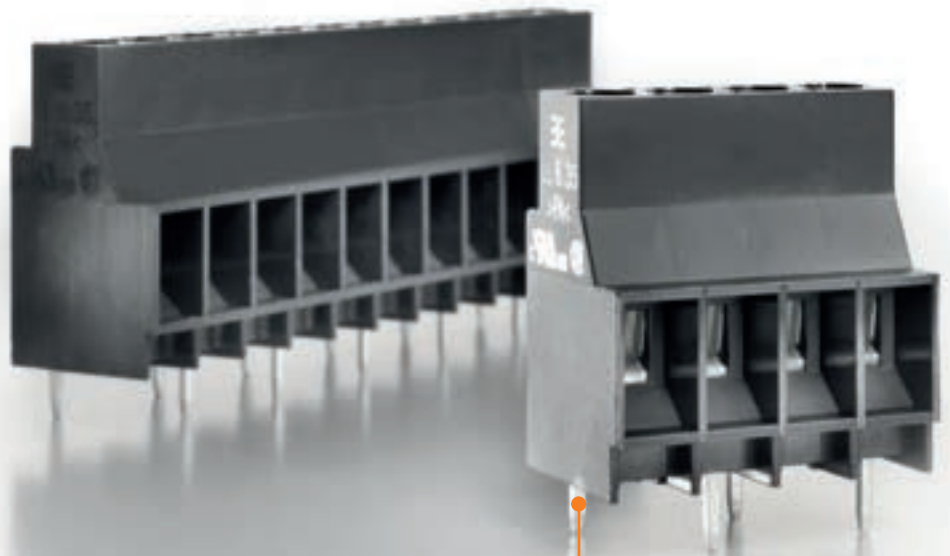

Clever design
The staggered solder pins are a speciality of the LL 6.35. These pins provide the required clearance and creepage distances for unrestricted 600 V certification to UL 1059.

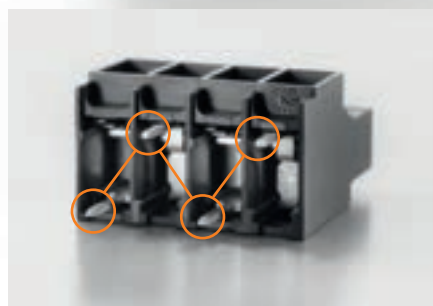

Clear marking

The design of the LL 6.35 allows individual direct labelling on three possible levels. This allows a direct assignment and avoids installation errors.

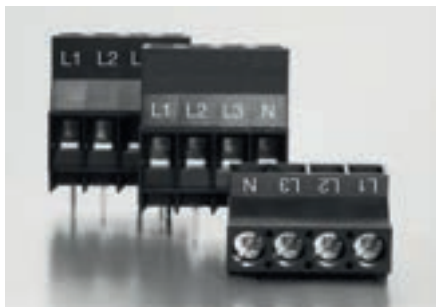

Safe operation

The world-wide compatible screw head allows an interference fit bolted joint that can be operated using all standard tools and power tools.



High-quality insulation

The insulating material WEMID satisfies the highest environmental standards, is creep-current resistant to CTI 600 and fire resistant to UL 94-V0. With a continuous operating temperature of 120 °C it exceeds the standard value of PA (100 °C) by 20 K.

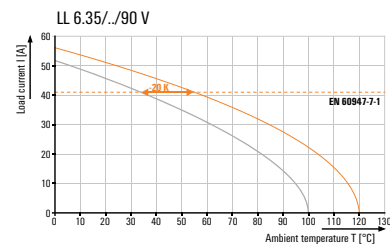

Safe fire resistance

The use of high-quality plastics allows compliance with the increased requirements for fire safety in accordance with the household appliance standard IEC 60335-1.



Can be ordered online

Order your sample world-wide directly from the OMNIMATE® online catalogue at www.sample-service.com



Maintenance-free terminal point

A vibration resistant and maintenance-free connection is made using our proven WIRE GUARD and WIRE READY clamping yoke screw connection.

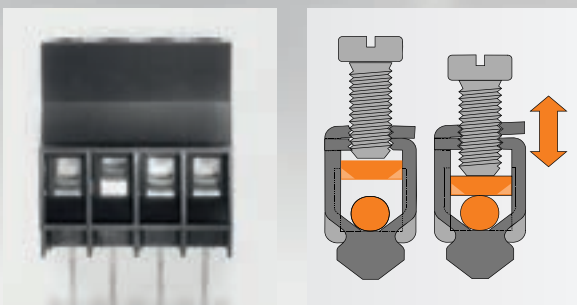

OMNIMATE® Power PCB terminals

High-power connections up to 150 A / 1,000 V

The OMNIMATE® Power PCB terminals – ranging from the LUP in 10.16-mm pitch to the LXXX in 15.00-mm pitch – is approved for unlimited international use in applications according to UL 1059 (600 V) and IEC (1,000 V). Weidmüller’s self-securing steel clamping yoke is 100 % maintenance free. It provides vibration-proof connections to the PCB for wires up to 50 mm².

Unrivalled clamping

With an unmatched clamping range, the LXXX 15.0 offers a safe and strong wire connection for cross-sections up to 50 mm² / AWG1 and 150 A to the circuit board.

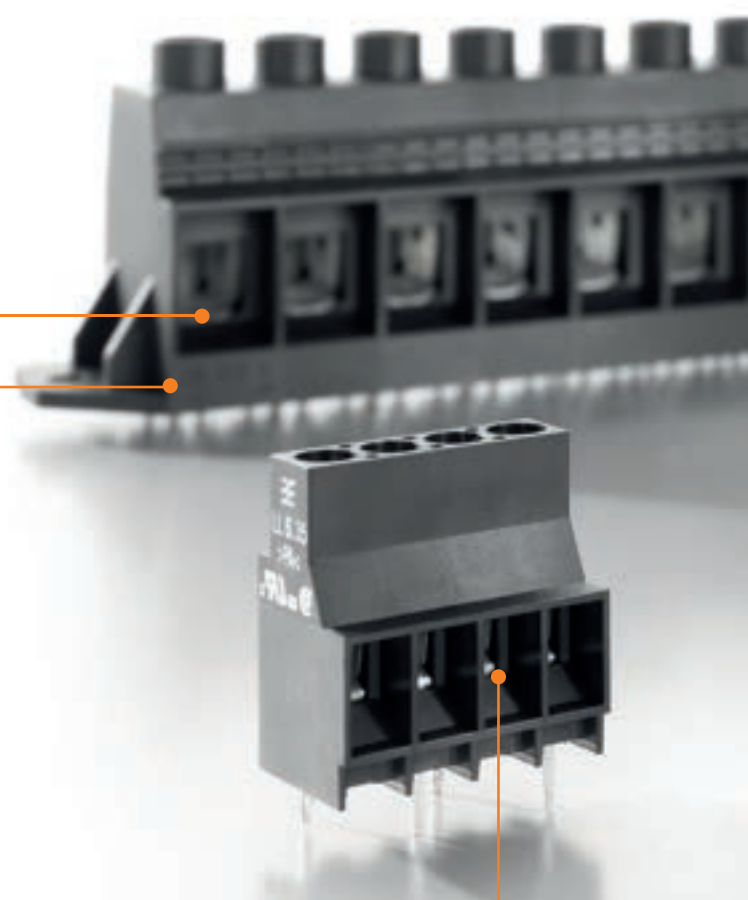

Power reserve for safety

The high-performance WEMID insulation material helps increase the availability of the system. With an RTI (relative temperature index) of 120 °C, the OMNIMATE® Power PCB terminals exceed the upper continuous-use temperature recommended by the Standard PA (100 °C) by 20 °C. Thus there are more power reserves and improved safety in event of temperature fluctuations or overloads.

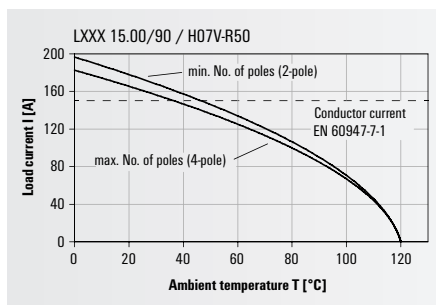

Screw connection system

The automatically counter-operating Weidmüller steel clamping yoke uses force generated by tightening the screw to open the upper thread. Settling of the connected wires and vibrations are compensated for and this guarantees a maintenance free operation. Subsequent tightening and maintenance of the screw is not needed.

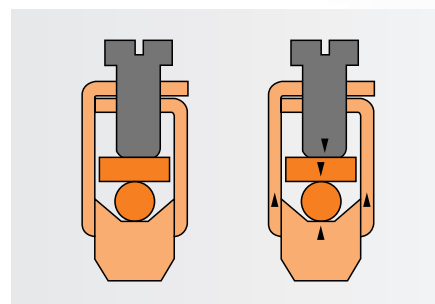

Standard-compliant integration

Weidmüller terminals meet the extended creepage and clearance distances according to UL and finger safety in accordance with the IEC 61800-5-1 device standard.



Wire protection

The integrated "Wire Guard" mechanism on the OMNIMATE® Power PCB terminals prevents wires from being inserted improperly and prevents a malfunctioning contact.



Integrated test point

The required maintenance and measurements can be carried out in a safe, reliable and convenient manner.



Labelling and assigning

Terminals are available with custom direct printing, versatile Dekafix labelling, affordable adhesive strips and colour coding.



Reliable and fast connection of power electronics devices

LUF and LUFS series PCB terminal with PUSH IN connection

Maximum performance with increased economic efficiency – these are the current trends in the field of power electronics. In order to achieve this goal, devices must combine excellent functionality with simple operation. This will have an impact on the device connectivity systems, which need to be fault-free, safe and quick in their usage.

The LUF PCB terminal from the OMNIMATE® Power product range features proven PUSH IN connection technology. This has allowed us to carry out tool-free wiring for wire cross-sections up to 16 mm² and to meet requirements in accordance with UL 1059 for 600 V in the 10.00 mm pitch and with 1,000 V in the 15.00 mm pitch.

LUF(S) provides high levels of contact reliability based on the Weidmüller Connection Safety Concept. The terminal contact shuts automatically to prevent malfunction. LUF has a tool-free wiring system, and LUFS can be actuated with a simple screwdriver to connect cross sections up to 16 mm². The PUSH IN connection system also allows a quick, convenient and therefore efficient wiring.



Compliant with UL 1059

As a result of the offset arrangement of the solder pins, the LUF 15.00 and also the LUFS 15.00 allows unrestricted international use in applications in accordance with UL 1059 up to 1,000 V.



Comfortable actuation

An ergonomic lever makes it easy to open the clamp and release the wire. The contact point for LUF can be opened comfortably by hand, and LUFS can be opened using a standard screwdriver.

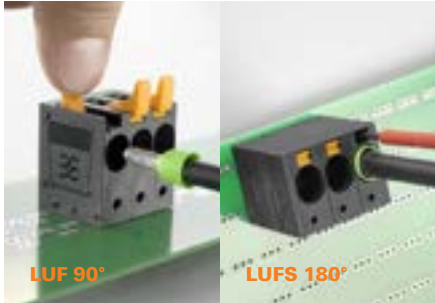

Convenient access to test points

In order to provide maximum flexibility, LUF 90° offers two test points – one beside the cable entry and another beside the actuating lever side. LUFS 180° features one test point located beside the cable entry.

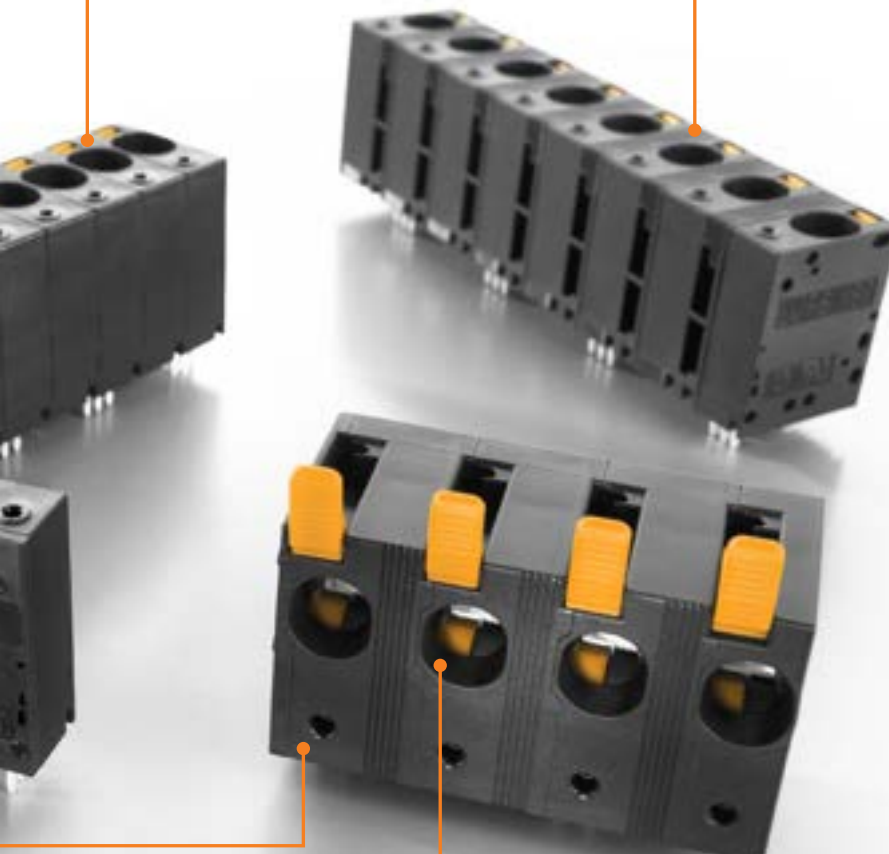

Your special advantages:

Perfect connection thanks to high levels of contact reliability

This contact system is automatically closed after being opened. This intelligent Connection Safety Concept helps to ensure that the wire is always connected safely.



PUSH IN connection up to 16 mm²

The PUSH IN connection system allows for wires to be connected to the PCB board without the need for tools. Solid wires or wires with ferrules can be directly connected. Done!



The LUF and LUFS are not only proving to be impressive thanks to their good performance and easy operability – ensured by the unusually high level of contact reliability – but also meets all the challenges that arise in power electronic applications.

Reliable and fast connection in power electronic applications LLF 7.50 PCB terminal with PUSH IN connection system

Modern systems and technology – for example, photovoltaic inverters – underlie continuous development and optimisation. Technological advances often depend on powerful, flexible and robust connectivity systems to ensure secure and reliable operation.

The LLF PCB terminal from the OMNIMATE® Power product range features proven PUSH IN connection technology. This has allowed us to carry out tool-free wiring for wire cross-sections up to 6 mm² and to meet requirements in accordance with UL 1059 for 600 V in pitch 7.5 mm.

Just like the PCB terminals LUF and LUFS, LLF uses the Weidmüller “Connection Safety Concept”, which has a PUSH IN connection for quick and safe mounting. The actuation lever allows for quick, simple, and safe wiring with excellent performance.



Compliant with UL 1059 up to 600 V

As a result of the offset arrangement of the solder pins, the LLF allows unrestricted international use in applications in accordance with UL 1059 up to 600 V.



High level of reliability

LLF provides high levels of contact reliability based on the "Connection Safety Concept". The terminal contact closes automatically to prevent malfunction.



Convenient access to test points

Two test points with LLF, one located beside the cable entry and another beside the actuating lever, provide a great flexibility during testing.

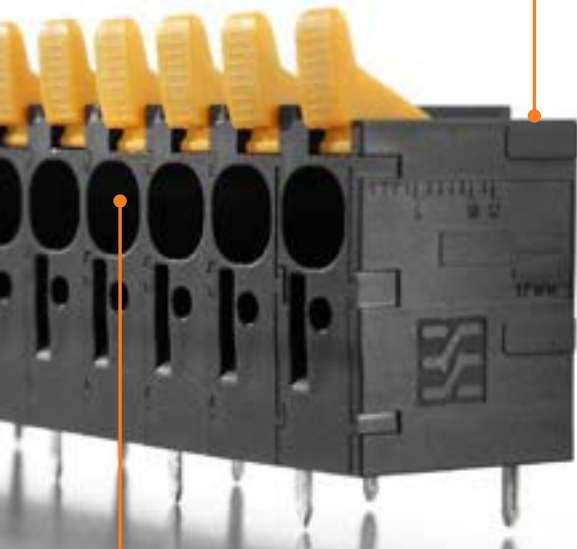
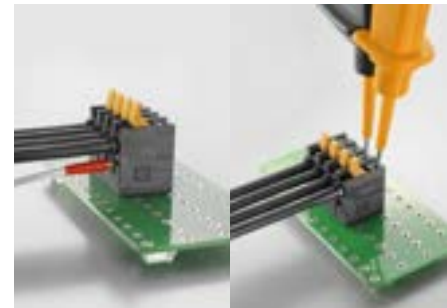

Tool-free wiring system

The PUSH IN connection and the simple and safe operation of the actuator lever ensure quick, convenient and efficient wiring of cross sections up to 6 mm².



Your special advantages:

Comfortable actuation

The ergonomically designed lever allows an operator to easily actuate and open clamp in order to release the cable. The contact point get readily opened by hand without the need for any physical exertion.

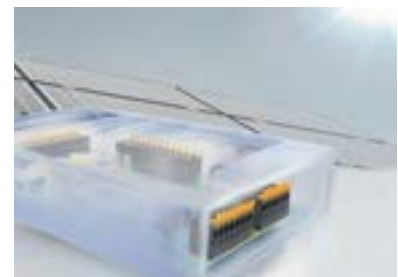

LLF is capable of handling challenging applications that not only require high current and voltage but also demand a secure connectivity. LLF maximises connection safety and reliability within a compact space.

Safe and efficient connection of power electronics devices LUF 10.00 with PUSH IN in accordance with UL 1059 for 600 V

Maximum performance with increased economic efficiency – these are the current trends in the field of power electronics. In order to achieve this goal, devices must combine excellent functionality with simple operation. This will have impact on the device connectivity systems, which needs to be fault-free, safe and quick in his usage.

The LUF PCB terminal from the OMNIMATE® Power product range features tried-and-tested PUSH IN connection technology. This has allowed us to realise tool-free wiring for wire cross-sections up to 16 mm² and to meet requirements in accordance with UL 1059 for 600 V in the 10.00 mm pitch.

In addition to the particularly simple handling of the actuator lever, the LUF also provides high levels of contact reliability that is based on the “Connection Safety Concept” from Weidmüller. The quick and safe wire connection with PUSH IN connection system as well as the simple and safety operation of the actuator lever for opening the contact allow a quick, convenient and therefore economical wiring.

According to UL 1059 up to 600 V

As a result of the offset arrangement of the solder pins, the LUF allows unrestricted international use in applications in accordance with UL 1059 up to 600 V.



Easy actuation

The contact point can be opened without any physical exertion and without the need of any special tools. It can be done by hand or using a simple screwdriver.

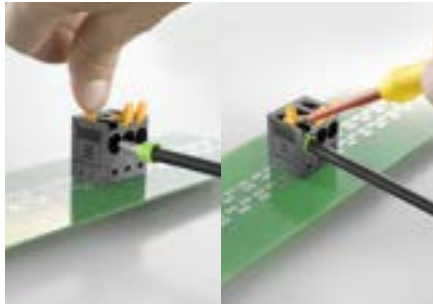

Available for testing at any time

Easily accessible diagnostic testing points in direction of cable entry or on the actuating lever side allows the using of tester or connector PS2.

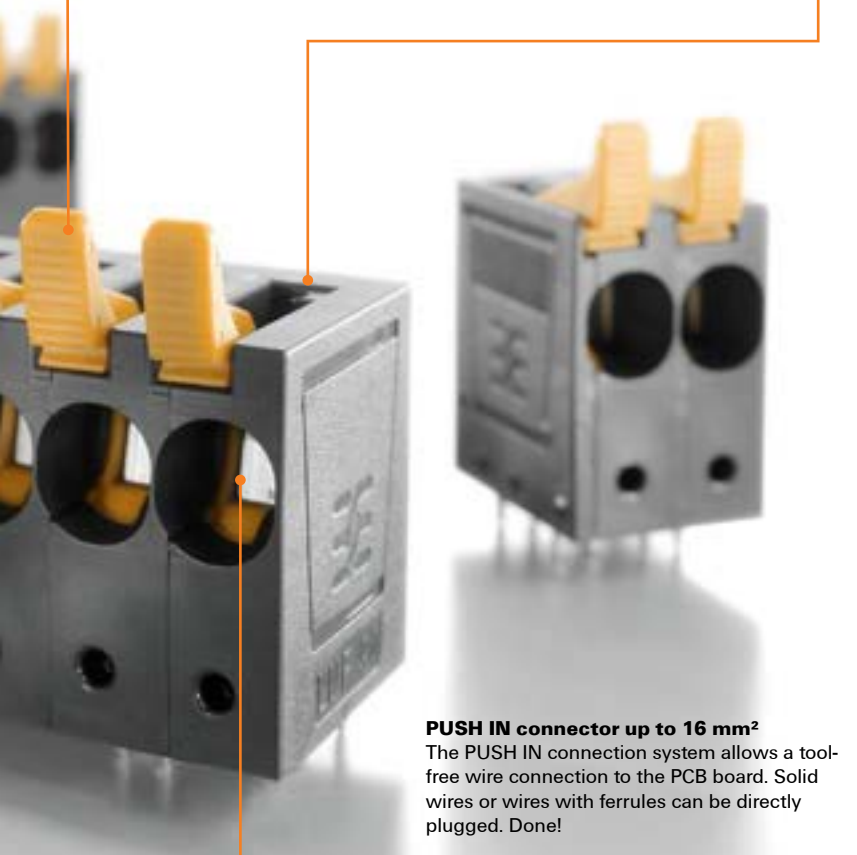

PUSH IN connector up to 16 mm²

The PUSH IN connection system allows a tool-free wire connection to the PCB board. Solid wires or wires with ferrules can be directly plugged. Done!



Your special advantages:

Perfect connection thanks to high levels of contact reliability

This contact system is getting automatically closed after it was opened. This intelligent "Connection Safety Concept" helps ensure that the wire is always safely connected.

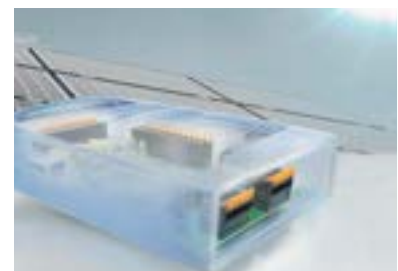

The LUF is not only impressive concerning performance and easy operability – due to the particularly high level of contact reliability, this PCB terminal meets all the challenges of power-electronics applications.

<http://www.OMNIMATE.net>

- = 300 V (UL) / 1,000 V (IEC)
- = 600 V (UL) / 1,000 V (IEC)

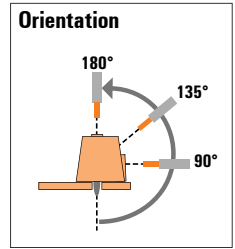

PCB terminals

Type of connection	Clamping range	Type	IEC / UL	90°	135°	180°	
Screw Clamping yoke	≤ 6 mm ²		LL 6.35/./90 V*	IEC: 1,000 V/32 A/0.18 - 6 mm ² UL: 600 V/30 A/AWG 26 - 10	●		
			LU 10.16	IEC: 1,000 V/76 A/0.5 - 16 mm ² UL: 300 V/65 A/AWG 26 - 6	●		
	≤ 16 mm ²		LUP 10.16	IEC: 1,000 V/76 A/0.5 - 16 mm ² UL: 300 V/58 A/AWG 26 - 6	●		
			LUP 10.16/./90 V*	IEC: 1,000 V/76 A/0.5 - 16 mm ² UL: 600 V/51 A/AWG 22 - 6	●		
			LUP 12.70	IEC: 1,000 V/76 A/0.5 - 16 mm ² UL: 600 V/58 A/AWG 26 - 6	●		
	≤ 25 mm ²		LX 15.00	IEC: 1,000 V/101 A/0.5 - 25 mm ² UL: 600 V/85 A/AWG 16 - 4	●		
			LXB 15.00	IEC: 1,000 V/101 A/1.5 - 25 mm ² UL: 600 V/85 A/AWG 16 - 4	●		
	≤ 50 mm ²		LXXX 15.00	IEC: 1,000 V/150 A/0.5 - 50 mm ² UL: 600 V/127 A/AWG 20 - 1	●		
			LXXX 15.00/./90F	IEC: 1,000 V/150 A/0.5 - 50 mm ² UL: 600 V/127 A/AWG 20 - 1	●		

* With offset solder pins

Pitch, in mm	6.35	10.16	12.70	15.00
Max. rated voltage, IEC	1,000 V			
UL nominal voltage UL	600 V	300 V	600 V	
	●			
		○		
		○		
			●	
				●
				●
				●
				●

<http://www.OMNIMATE.net>

○ 300 V
 ● 600 V
 ● 1.000 V

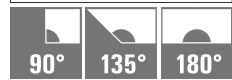
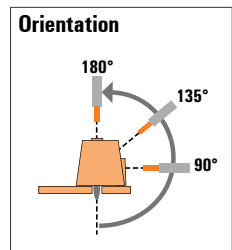

PCB terminals

Type of connection	Clamping range	Type	IEC / UL	90°	135°	180°
PUSH IN	≤ 6 mm ²	LLF 7.50/90	IEC: 600 V / 41 A / 0.5 - 6 mm ² UL: 300 V / 35 A / AWG 24 - AWG 8	●		
		LLF 7.50/90V*	IEC: 1000 V / 41 A / 0.5 - 6 mm ² UL: 600 V / 35 A / AWG 24 - AWG 8	●		
		LLFS 7.50/180	IEC: 1000 V / 41 A / 0.5 - 6 mm ² UL: 300 V / 37 A / AWG 24 - AWG 8			●
		LLFS 7.50/180V*	IEC: 1000 V / 41 A / 0.5 - 6 mm ² UL: 600 V / 37 A / AWG 24 - AWG 8			●
		LLFS 7.50/90	IEC: 1000 V / 41 A / 0.5 - 6 mm ² UL: 300 V / 37 A / AWG 24 - AWG 8	●		
		LLFS 7.50/90V*	IEC: 1000 V / 41 A / 0.5 - 6 mm ² UL: 600 V / 37 A / AWG 24 - AWG 8	●		
PUSH IN	≤ 16 mm ²	LUF 10.00/90	IEC: 1000 V / 76 A / 0.5 - 16 mm ² UL: 300 V / 61 A / AWG 18 - AWG 6	●		
		LUF 10.00/90V*	IEC: 1000 V / 76 A / 0.5 - 16 mm ² UL: 600 V / 58 A / AWG 18 - AWG 6	●		
		LUFS 10.00/180	IEC: 1000 V / 76 A / 0.5 - 16 mm ² UL: 600 V / 61 A / AWG 18 - AWG 6			●
		LUFS 10.00/180V*	IEC: 1000 V / 76 A / 0.5 - 16 mm ² UL: 600 V / 58 A / AWG 18 - AWG 6			●
		LUFS 10.00/90	IEC: 1000 V / 76 A / 0.5 - 16 mm ² UL: 600 V / 61 A / AWG 18 - AWG 6"	●		
		LUFS 10.00/90V*	IEC: 1000 V / 76 A / 0.5 - 16 mm ² UL: 600 V / 58 A / AWG 18 - AWG 6	●		
PUSH IN	≤ 16 mm ²	LUF 15.00/90	IEC: 1000 V / 76 A / 0.5 - 16 mm ² UL: 600 V / 66 A / AWG 20 - AWG 4	●		
		LUF 15.00/90V*	IEC: 1000 V / 76 A / 0.5 - 16 mm ² UL: 600 V / 66 A / AWG 20 - AWG 4	●		
		LUF 15.00/180	IEC: 1000 V / 76 A / 0.5 - 16 mm ² UL: 600 V / 66 A / AWG 20 - AWG 4			●
		LUFS 15.00/90V*	IEC: 1000 V / 76 A / 0.5 - 16 mm ² UL: 600 V / 66 A / AWG 20 - AWG 4			●

* mit versetzten Lötstiften

Pitch, in mm	7,50			10,00			15,00		
Rated voltage IEC	600 V	1000 V	1000 V	600 V	1000 V	1000 V	600 V	1000 V	1000 V
Rated voltage UL	300 V	300 V	600 V	300 V	300 V	600 V	300 V	300 V	600 V

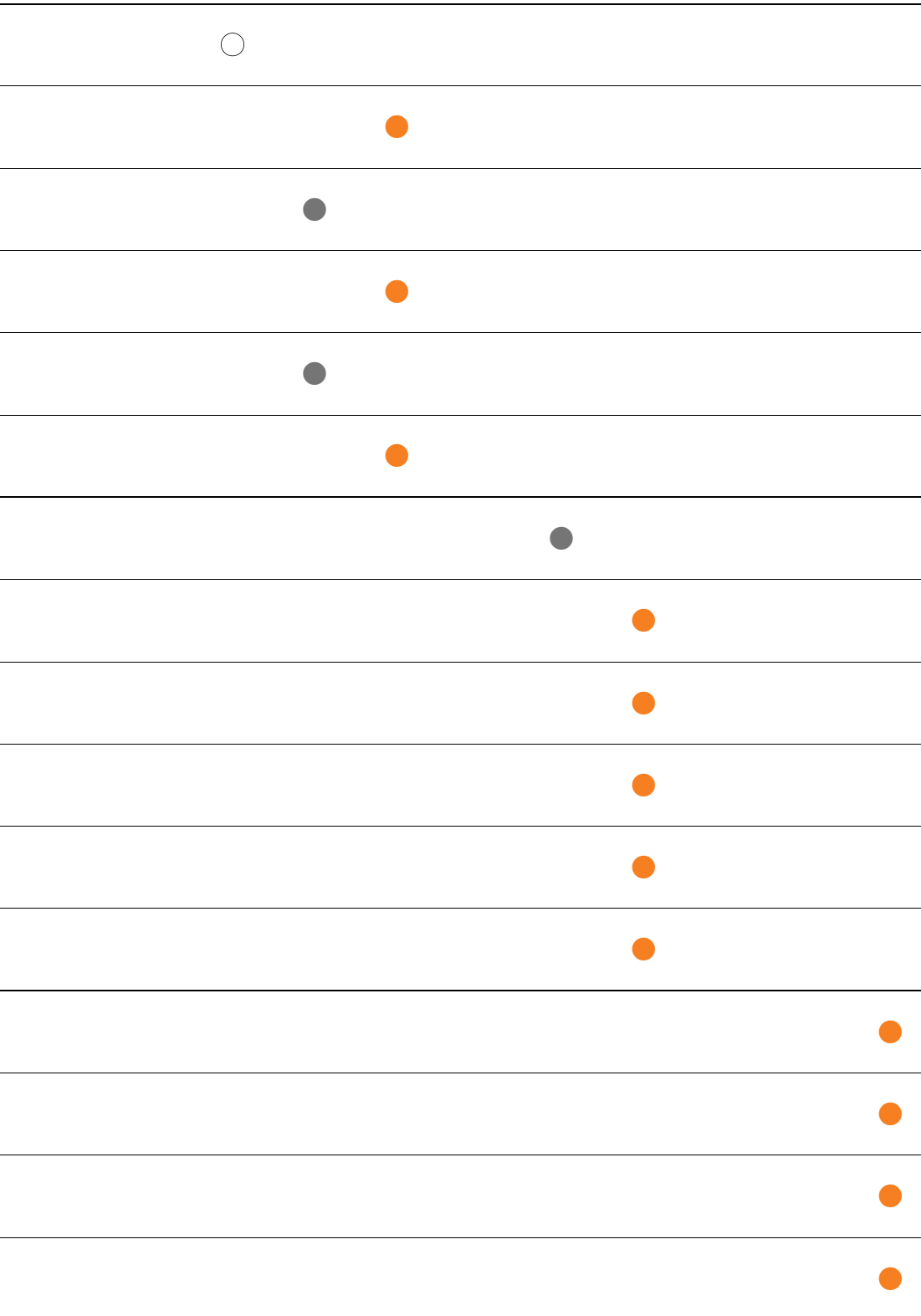

LL 6.35

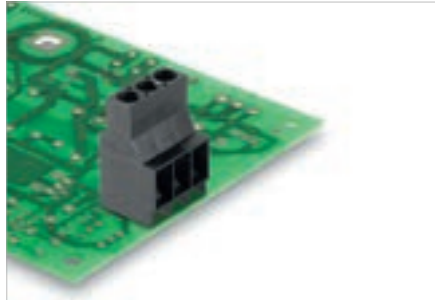

High-power PCB terminal with proven clamping yoke screw connection, 6.35 mm pitch, for conductor cross-sections up to 6 mm².

- UL 600 V approval for unlimited international use in devices.
- Increased derating reserves due to the use of WEMID insulating material.
- Conductor outlet direction of 90°
- Block construction for versions up to 12 poles

Technical data

In compliance with IEC 60664-1 / IEC 61984			
Clamping range, max.	mm ²	0.18...6	
Solid core H05(07) V-U	mm²	0.18...6	
Stranded H07 V-R			
Flexible H05(07) V-K	mm ²	0.22...4	
Flexible with ferrule	mm ²	0.5...4	
Ferrule with plastic collar	mm ²	0.5...2.5	
Stripping length	mm	8	
Screwdriver blade	mm	0.8 x 4.0, PZ 1	
According to norm		DIN 5264	
Tightening torque range	Nm	0.5...0.6	
Rated current, max.	A	32	32
At ambient temperature		20°C	40°C
For conductor cross-section			
Overvoltage category		III	III II
Pollution severity		3	2 2
Rated voltage	V	800	1000 1000
Rated impulse voltage	kV	8	8 8
UL / CUL (Use Group)		B	C D
Rated voltage	V	600	600 600
Rated current	A	30	30 5
AWG conductor	AWG	26-10	
CSA (Use Group)		B	C D
Rated voltage	V	600	600 600
Rated current	A	30	30 5
AWG conductor	AWG	26-10	
General data			
Type of insulation material		Wemid (PA)	
UL 94 flammability rating		V-0	
Contact base material		Copper alloy	
Material of contact surface		tinned	
Pin dimensions = d	mm	1.0 x 0.6	
Solder eyelet Ø = D	mm	1.3	
Solder eyelet Ø tolerance	mm	+ 0,1	

Product data

IEC: 1000 V / 32 A / 0.18 - 6 mm²
 UL: 600 V / 30 A / AWG 26 - 10



For additional articles and information, refer to catalog.weidmuller.com

Note:

- Additional colours on request
- Rated current related to rated cross-section & min. No. of poles.
- Wire end ferrule without plastic collar to DIN 46228/1
- Wire end ferrule with plastic collar to DIN 46228/4
- P on drawing = pitch
- Rated data refer only to the component itself. Clearance and creepage distances of the product with average temperature of 50 °C and average humidity 70%, 36 months
- It is necessary to hold the insulating body of the one or two pole terminal when tightening the screw
- Long term storage of the product with average temperature of 50 °C and average humidity 70%, 36 months

LL 6.35



Dimensioned drawing

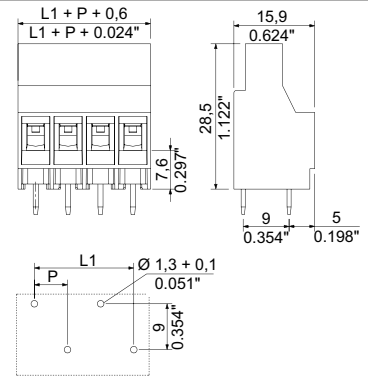

Accessories

Note: Refer to the Accessories chapter for additional accessories.

Screwdriver		Order No.
	SDIS 0.8X4.0X100	2749820000
	SDS 0.8X4.0X100	2749360000
	SDK PZ1 X 80	2749440000

Ordering data

Solder pin length		5 mm		
Colour		black		
Pitch		6.35 mm		
Pol.	L1	(inch)	Qty.	Order No.
2	6.35	0.250	138	1356830000
3	12.70	0.500	90	1356840000
4	19.05	0.750	66	1356850000
5	25.40	1.000	54	1356870000
6	31.75	1.250	48	1356880000
7	38.10	1.500	36	1356890000
8	44.45	1.750	36	1356900000
9	50.80	2.000	30	1356920000
10	57.15	2.250	24	1356930000
11	63.50	2.500	24	1356940000
12	69.85	2.750	24	1356950000

Representative deratings curve

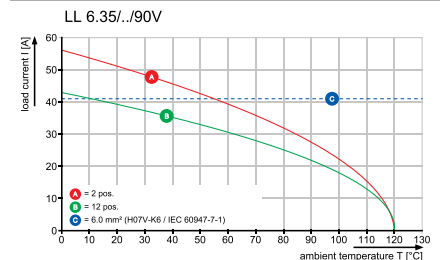

LU 10.16/./90



High-power PCB Terminal with clamping yoke screw connection, in 10.16 mm pitch for wire cross-sections up to 16 mm² (AWG 6).

- Increased derating reserves because WEMID insulating material is used.
- Wire outlet direction: 90° version.
- 2- and 3-pole block construction can be aligned together for higher pole counts.

Technical data

In compliance with IEC 60664-1 / IEC 61984			
Clamping range, max.	mm ²	0.14...16	
Solid core H05(07) V-U	mm²	0.5...16	
Stranded H07 V-R		...16	
Flexible H05(07) V-K	mm ²	0.5...16	
Flexible with ferrule	mm ²	2.5...10	
Ferrule with plastic collar	mm ²	2.5...10	
Stripping length	mm	12	
Screwdriver blade	mm	1.0 x 5.5	
		According to norm DIN 5264	
Tightening torque range	Nm	1.2...2.2	
Rated current, max.	A	76	76
At ambient temperature		20°C	40°C
For conductor cross-section			
Overvoltage category		III	III II
Pollution severity		3	2 2
Rated voltage	V	690	690 1000
Rated impulse voltage	kV	6	6 4
UL / CUL (Use Group)		B	C D
Rated voltage	V	300	150 600
Rated current	A	65	65 5
AWG conductor	AWG		26-6
CSA (Use Group)		B	C D
Rated voltage	V	300	150 300
Rated current	A	65	65 10
AWG conductor	AWG		22-6
General data			
Type of insulation material		Wemid (PA)	
UL 94 flammability rating		V-0	
Contact base material		E-Cu	
Material of contact surface		tinned	
Pin dimensions = d	mm	1.2 x 1.2	
Solder eyelet Ø = D	mm	1.6	
Solder eyelet Ø tolerance	mm	+ 0,1	

Product data

IEC: 1000 V / 76 A / 0.5 - 16 mm²
 UL: 300 V / 65 A / AWG 26 - 6



For additional articles and information, refer to catalog.weidmueller.com

Note:

- Additional colours on request
- Rated current related to rated cross-section & min. No. of poles.
- Wire end ferrule without plastic collar to DIN 46228/1
- Wire end ferrule with plastic collar to DIN 46228/4
- P on drawing = pitch
- Rated data refer only to the component itself. Clearance and creepage distances to other components are to be designed in accordance with the relevant application standards.
- Long term storage of the product with average temperature of 50 °C and average humidity 70%, 36 months

LU 10.16/./90



Dimensioned drawing

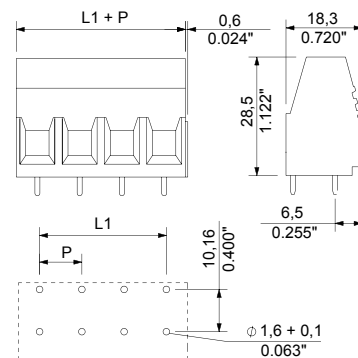

Accessories

Note: Refer to the Accessories chapter for additional accessories.

Screwdriver	Order No.
SDS 1.0X5.5X150	2749380000
SDIS 1.0X5.5X125	2749850000
Crosshead screwdriver	
SDK PZ2 X 100	2749450000
SDIK PZ2 X 100	2749930000
Identification systems	
DEK 5 NEUTRAL	0473360000
Marking tags	
DEK 5/5 MC NE WS	1609801044

Ordering data

Solder pin length		4.5 mm	
Colour		black	
Pitch 10.16 mm			
Pol.	L1	(inch)	Qty. Order No.
2	10.16	0.400	20 1934140000
3	20.32	0.800	20 1921450000
4	30.48	1.200	20 1226220000
5	40.64	1.600	20 1226230000
6	50.80	2.000	20 1226240000
7	60.96	2.400	20 1226250000
8	71.12	2.800	20 1226260000
9	81.28	3.200	20 1226270000
10	91.44	3.600	20 1226280000

Representative deratings curve

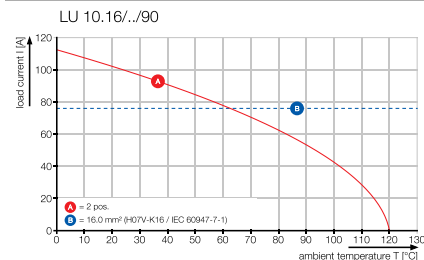

LUP 10.16/./90



High-power PCB terminal with clamping yoke screw connection, in 10.16 mm pitch for wire cross-sections up to 16 mm² (AWG 6).

- Increased derating reserves through the use of WEMID insulating material.
- Conductor outlet direction: 90°
- With integrated test point for test plug PS 2.0.

Product data

IEC: 1000 V / 76 A / 0.5 - 16 mm²
 UL: 300 V / 58 A / AWG 26 - 6



For additional articles and information, refer to catalog.weidmueller.com

Note:

- Additional colours on request
- Rated current related to rated cross-section & min. No. of poles.
- Wire end ferrule without plastic collar to DIN 46228/1
- Wire end ferrule with plastic collar to DIN 46228/4
- The data given under CSA relates to a cUL approval - E60693
- P on drawing = pitch
- Rated data refer only to the component itself. Clearance and creepage distances to other components are to be designed in accordance with the relevant application standards.
- The test point can only be used as potential-pickup point.
- Long term storage of the product with average temperature of 50 °C and average humidity 70%, 36 months

LUP 10.16/./90



Dimensioned drawing

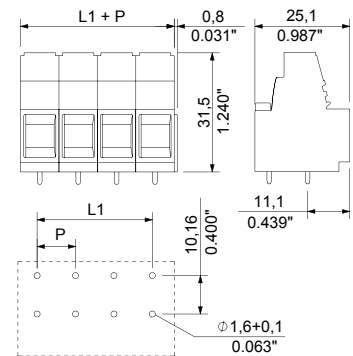

Technical data

In compliance with IEC 60664-1 / IEC 61984			
Clamping range, max.	mm ²	0.13...16	
Solid core H05(07) V-U	mm²	0.5...16	
Stranded H07 V-R		...16	
Flexible H05(07) V-K	mm ²	0.5...16	
Flexible with ferrule	mm ²	2.5...10	
Ferrule with plastic collar	mm ²	2.5...10	
Stripping length	mm	12	
Screwdriver blade	mm	1.0 x 5.5, PZ 2	
According to norm		DIN 5264	
Tightening torque range	Nm	1.2...1.5	
Rated current, max.	A	76	72
At ambient temperature		20°C	40°C
For conductor cross-section			
Overvoltage category		III	III II
Pollution severity		3	2 2
Rated voltage	V	800	1000 1000
Rated impulse voltage	kV	8	8 6
UL / CUL (Use Group)	B C D	B	C D
Rated voltage	V	300	300 600
Rated current	A	58	58 5
AWG conductor	AWG	26-6	
CSA (Use Group)	B C D	B	C D
Rated voltage	V	300	300 600
Rated current	A	58	58 5
AWG conductor	AWG	22-6	
General data			
Type of insulation material		Wemid (PA)	
UL 94 flammability rating		V-0	
Contact base material		E-Cu	
Material of contact surface		tinned	
Pin dimensions = d	mm	1.2 x 1.2	
Solder eyelet Ø = D	mm	1.6	
Solder eyelet Ø tolerance	mm	+ 0,1	

Accessories

Note: Refer to the Accessories chapter for additional accessories.

Screwdriver	Order No.
SDS 1.0X5.5X150	2749380000
SDIS 1.0X5.5X125	2749850000
Crosshead screwdriver	
SDK PZ2 X 100	2749450000
SDIK PZ2 X 100	2749930000
Test plug	
PS 2.0 MC	0310000000
Identification systems	
DEK 5 NEUTRAL	0473360000
Marking tags	
DEK 5/5 MC NE WS	1609801044

Ordering data

Solder pin length		5 mm		
Colour		black		
Pitch		10.16 mm		
Pol.	L1	(inch)	Qty.	Order No.
2	10.16	0.400	20	2014050000
3	20.32	0.800	20	2014060000
4	30.48	1.200	20	2014090000
5	40.64	1.600	20	2014140000
6	50.80	2.000	20	2014150000
7	60.96	2.400	20	2014160000
8	71.12	2.800	20	2014170000
9	81.28	3.200	20	2014180000

Representative deratings curve

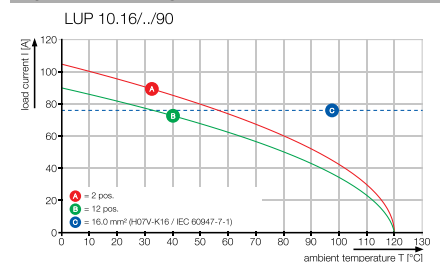

LUP 10.16/./90V

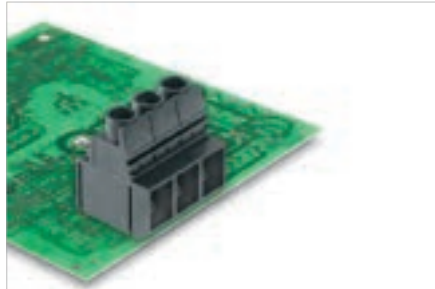

High-performance PCB terminal block with clamping yoke screw connection, in 10.16 mm pitch for wire cross-sections up to 16 mm² (AWG 6).

- UL approval 600 V
- Increased derating reserves through the use of WEMID insulating material.
- Wire outlet direction: 90°
- With integrated test point for test plug PS 2.0.

Technical data

In compliance with IEC 60664-1 / IEC 61984			
Clamping range, max.	mm ²	0.13...16	
Solid core H05(07) V-U	mm²	0.5...16	
Stranded H07 V-R		...16	
Flexible H05(07) V-K	mm ²	0.5...16	
Flexible with ferrule	mm ²	2.5...10	
Ferrule with plastic collar	mm ²	2.5...10	
Stripping length	mm	12	
Screwdriver blade	mm	1.0 x 5.5, PZ 2	
According to norm		DIN 5264	
Tightening torque range	Nm	1.2...1.5	
Rated current, max.	A	76	72
At ambient temperature		20°C	40°C
For conductor cross-section			
Overvoltage category		III	III II
Pollution severity		3	2 2
Rated voltage	V	800	1000 1000
Rated impulse voltage	kV	8	8 6
UL / CUL (Use Group)	B C D	B	C D
Rated voltage	V	600	600 600
Rated current	A	51	51 5
AWG conductor	AWG	22-6	
CSA (Use Group)	B C D	B	C D
Rated voltage	V	600	600 600
Rated current	A	51	51 5
AWG conductor	AWG	22-6	
General data			
Type of insulation material		Wemid (PA)	
UL 94 flammability rating		V-0	
Contact base material		E-Cu	
Material of contact surface		tinned	
Pin dimensions = d	mm	1.2 x 1.2	
Solder eyelet Ø = D	mm	1.6	
Solder eyelet Ø tolerance	mm	+ 0,1	

Product data

IEC: 1000 V / 76 A / 0.5 - 16 mm²
 UL: 600 V / 51 A / AWG 22 - 6



For additional articles and information, refer to catalog.weidmueller.com

Note:

- Additional colours on request
- Rated current related to rated cross-section & min. No. of poles.
- Wire end ferrule without plastic collar to DIN 46228/1
- Wire end ferrule with plastic collar to DIN 46228/4
- The data given under CSA relates to a cUL approval - E60693
- P on drawing = pitch
- Rated data refer only to the component itself. Clearance and creepage distances to other components are to be designed in accordance with the relevant application standards.
- Long term storage of the product with average temperature of 50 °C and average humidity 70%, 36 months

LUP 10.16/./90V



Dimensioned drawing

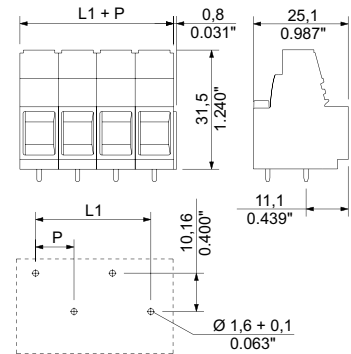

Accessories

Note: Refer to the Accessories chapter for additional accessories.

Screwdriver	Order No.
SDS 1.0X5.5X150	2749380000
SDIS 1.0X5.5X125	2749850000
Crosshead screwdriver	
SDK PZ2 X 100	2749450000
SDIK PZ2 X 100	2749930000
Test plug	
PS 2.0 MC	0310000000
Identification systems	
DEK 5 NEUTRAL	0473360000
Marking tags	
DEK 5/5 MC NE WS	1609801044

Ordering data

Solder pin length		5 mm		
Colour		black		
Pitch		10.16 mm		
Pol.	L1	(inch)	Qty.	Order No.
2	10.16	0.400	20	2012810000
3	20.32	0.800	20	2012890000
4	30.48	1.200	20	2013870000
5	40.64	1.600	20	2013880000
6	50.80	2.000	20	2013890000
7	60.96	2.400	20	2013900000
8	71.12	2.800	20	2013910000
9	81.28	3.200	20	2013920000

Representative deratings curve

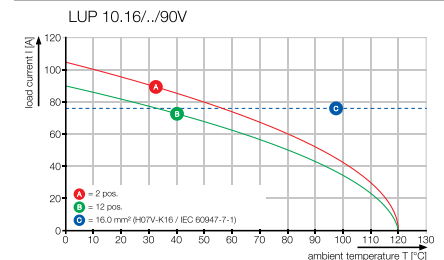

LUP 12.7../90

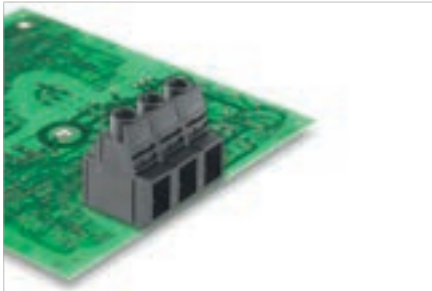

High-performance PCB terminal block with clamping yoke screw connection, in 12.70 mm pitch for wire cross-sections up to 16 mm².

- UL approval 600 V
- Increased derating reserves through the use of WEMID insulating material.
- Wire outlet direction: 90°
- With integrated test point for test plug PS 2.0.

Product data

IEC: 1000 V / 76 A / 0.5 - 16 mm²
 UL: 600 V / 65 A / AWG 22 - 6



For additional articles and information, refer to catalog.weidmuller.com

Note:

- Additional colours on request
- Rated current related to rated cross-section & min. No. of poles.
- Wire end ferrule without plastic collar to DIN 46228/1
- Wire end ferrule with plastic collar to DIN 46228/4
- The data given under CSA relates to a cUL approval - E60693
- P on drawing = pitch
- Rated data refer only to the component itself. Clearance and creepage distances to other components are to be designed in accordance with the relevant application standards.
- Long term storage of the product with average temperature of 50 °C and average humidity 70%, 36 months

LUP 12.7../90



Dimensioned drawing

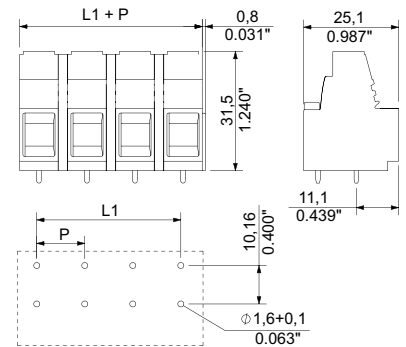

Technical data

In compliance with IEC 60664-1 / IEC 61984			
Clamping range, max.	mm ²	0.13...16	
Solid core H05(07) V-U	mm²	0.5...16	
Stranded H07 V-R		...16	
Flexible H05(07) V-K	mm ²	0.5...16	
Flexible with ferrule	mm ²	2.5...10	
Ferrule with plastic collar	mm ²	2.5...10	
Stripping length	mm	12	
Screwdriver blade	mm	1.0 x 5.5, PZ 2	
According to norm		DIN 5264	
Tightening torque range	Nm	1.2...1.5	
Rated current, max.	A	76	76
At ambient temperature		20°C	40°C
For conductor cross-section		III	III II
Overvoltage category		3	2 2
Pollution severity		3	2 2
Rated voltage	V	1000	1000 1000
Rated impulse voltage	kV	8	8 6
UL / CUL (Use Group)	B C D	B	C D
Rated voltage	V	600	600
Rated current	A	65	65
AWG conductor	AWG	22-6	
CSA (Use Group)	B C D	B	C D
Rated voltage	V	600	600
Rated current	A	65	65
AWG conductor	AWG	22-6	
General data			
Type of insulation material		Wemid (PA)	
UL 94 flammability rating		V-0	
Contact base material		E-Cu	
Material of contact surface		tinned	
Pin dimensions = d	mm	1.2 x 1.2	
Solder eyelet $\bar{\Phi}$ = D	mm	1.6	
Solder eyelet $\bar{\Phi}$ tolerance	mm	+ 0,1	

Accessories

Note: Refer to the Accessories chapter for additional accessories.

Screwdriver	Order No.
SDS 1.0X5.5X150	2749380000
SDIS 1.0X5.5X125	2749850000
Crosshead screwdriver	
SDK PZ2 X 100	2749450000
SDIK PZ2 X 100	2749930000
Test plug	
PS 2.0 MC	0310000000
Identification systems	
DEK 5 NEUTRAL	0473360000
Marking tags	
DEK 5/5 MC NE WS	1609801044

Ordering data

Solder pin length		5 mm		
Colour		black		
Pitch 12.70 mm				
Pol.	L1	(inch)	Qty.	Order No.
2	12.70	0.500	20	2014360000
3	25.40	1.000	20	2014380000
4	38.10	1.500	20	2014400000
5	50.80	2.000	20	2014420000
6	63.50	2.500	20	2014590000
7	76.20	3.000	20	2014610000
8	88.90	3.250	20	2014760000
9	101.60	4.000	20	2014900000

Representative deratings curve

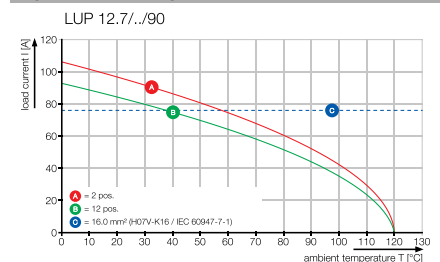

LX 15.00../90

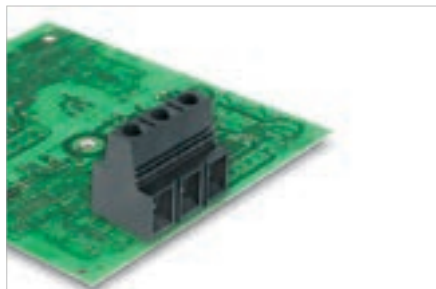

High-power PCB Terminal with clamping yoke screw connection, in 15.00 mm pitch for wire cross-sections up to 25 mm² (AWG 4).

- UL 600 V approval.
- Increased derating reserves because WEMID insulating material is used.
- Wire outlet direction: 90°.
- With integrated test point for PS 2.0 test plug.
- Versions up to 8 poles have block construction.
- Available with and without mounting flange.

Technical data

In compliance with IEC 60664-1 / IEC 61984			
Clamping range, max.	mm ²	1.31...25	
Solid core H05(07) V-U	mm²	1.5...16	
Stranded H07 V-R	mm ²	6...25	
Flexible H05(07) V-K	mm ²	1.5...25	
Flexible with ferrule	mm ²	1.5...16	
Ferrule with plastic collar	mm ²	1.5...16	
Stripping length	mm	16	
Screwdriver blade	mm	1.0 x 5.5	
		According to norm DIN 5264	
Tightening torque range	Nm	2.4...4	
Rated current, max.	A	101	101
At ambient temperature		20°C	40°C
For conductor cross-section		III	III II
Overvoltage category		III	III II
Pollution severity		3	2 2
Rated voltage	V	1000	1000 1000
Rated impulse voltage	kV	8	8 6
UL / CUL (Use Group)		B	C D
Rated voltage	V	600	600 600
Rated current	A	85	85 5
AWG conductor	AWG	16-4	
CSA (Use Group)		B	C D
Rated voltage	V	600	600 600
Rated current	A	85	85 5
AWG conductor	AWG	16-4	
General data			
Type of insulation material		Wemid (PA)	
UL 94 flammability rating		V-0	
Contact base material		E-Cu	
Material of contact surface		tinned	
Pin dimensions = d	mm	1.2 x 1.2	
Solder eyelet Ø = D	mm	1.6	
Solder eyelet Ø tolerance	mm	+ 0,1	

Product data

IEC: 1000 V / 101 A / 1.5 - 25 mm²
 UL: 600 V / 85 A / AWG 16 - 4



For additional articles and information, refer to catalog.weidmuller.com

Note:

- Additional colours on request
- Rated current related to rated cross-section & min. No. of poles.
- Wire end ferrule without plastic collar to DIN 46228/1
- Wire end ferrule with plastic collar to DIN 46228/4
- P on drawing = pitch
- Rated data refer only to the component itself. Clearance and creepage distances to other components are to be designed in accordance with the relevant application standards.
- The test point can only be used as potential-pickup point.
- Long term storage of the product with average temperature of 50 °C and average humidity 70%, 36 months

LX 15.00../90

with test point



Dimensioned drawing

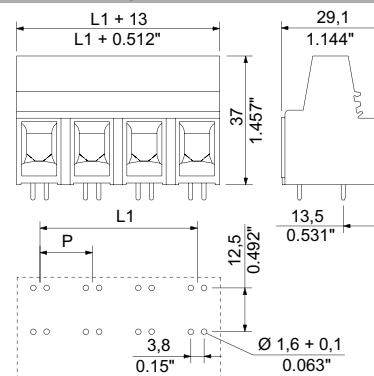

Ordering data

Solder pin length		4.5 mm		
Colour		black		
Pitch		15.00 mm		
Pol.	L1	(inch)	Qty.	Order No.
1	0.00	0.000	20	1226460000
2	15.00	0.591	20	1226470000
3	30.00	1.181	20	1174720000
4	45.00	1.772	20	1226480000
5	60.00	2.362	20	1226490000
6	75.00	2.953	10	1226500000
7	90.00	3.543	10	1226510000
8	105.00	4.134	10	1921480000

Accessories

Note: Refer to the Accessories chapter for additional accessories.

Screwdriver	Order No.
SDS 1.2X6.5X150	2749390000
SDIS 1.2X6.5X150	2749860000
Crosshead screwdriver	
SDK PZ2 X 100	2749450000
SDIK PZ2 X 100	2749930000
Test plug	
PS 2.0 MC	0310000000
Identification systems	
DEK 5 NEUTRAL	0473360000
Marking tags	
DEK 5/5 MC NE WS	1609801044

Representative deratings curve

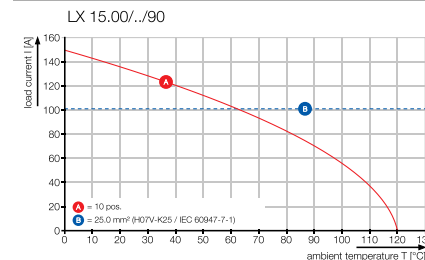

LXB 15.00/./90

with fixing flange and test point



Dimensioned drawing

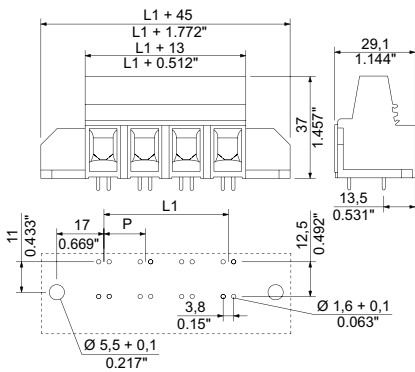

Ordering data

Solder pin length		4.5 mm		
Colour		black		
Pitch		15.00 mm		
Pol.	L1	(inch)	Qty.	Order No.
2	15.00	0.591	20	1226520000
3	30.00	1.181	20	1226530000
4	45.00	1.772	20	1226540000
5	60.00	2.362	20	1226550000
6	75.00	2.953	10	1226560000
7	90.00	3.543	10	1226570000
8	105.00	4.134	10	1226580000

LXBL 15.00/./90

with fixing flange left and test point



Dimensioned drawing

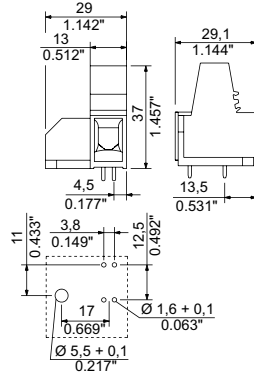

Ordering data

Solder pin length		4.5 mm		
Colour		black		
Pitch		15.00 mm		
Pol.	L1	(inch)	Qty.	Order No.
1	0.00	0.000	20	1226590000

Additional deratings curves

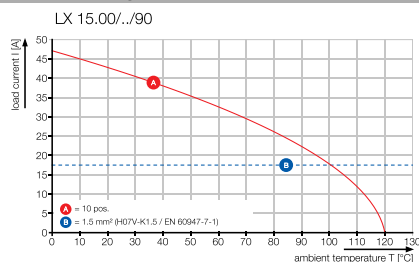

LXXX 15.00/./90

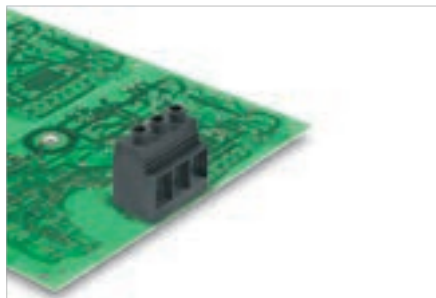

High-power PCB Terminal with clamping yoke screw connection, in 15.00 mm pitch for wire cross-sections up to 50 mm² (AWG 1).

- UL 600 V approval for unlimited international usage in devices.
- Increased derating reserves because WEMID insulating material is used.
- Wire outlet direction of 90°.
- With integrated test point for PS 2.0 test plug.
- Versions up to 8 poles have block construction.
- Available with and without mounting flange.

Technical data

In compliance with IEC 60664-1 / IEC 61984			
Clamping range, max.	mm ²	0.5...50	
Solid core H05(07) V-U	mm²	0.5...16	
Stranded H07 V-R	mm ²	6...50	
Flexible H05(07) V-K	mm ²	0.5...35	
Flexible with ferrule	mm ²	0.5...35	
Ferrule with plastic collar	mm ²	0.5...35	
Stripping length	mm	18	
Screwdriver blade	mm	1.2 x 6.5	
According to norm		DIN 5264	
Tightening torque range	Nm	2.5...4	
Rated current, max.		150	150
At ambient temperature	20°C		40°C
For conductor cross-section			
Overvoltage category		III	III II
Pollution severity		3	2 2
Rated voltage	V	1000	1000 1000
Rated impulse voltage	kV	8	8 8
UL / CUL (Use Group)		B	C D
Rated voltage	V	600	600
Rated current	A	126	126
AWG conductor	AWG	20-1	
CSA (Use Group)		B	C D
Rated voltage	V	600	600 600
Rated current	A	127	127 5
AWG conductor	AWG	20-1	
General data			
Type of insulation material		Wemid (PA)	
UL 94 flammability rating		V-0	
Contact base material		Copper alloy	
Material of contact surface		tinned	
Pin dimensions = d	mm	1.2 x 1.2	
Solder eyelet Ø = D	mm	1.6	
Solder eyelet Ø tolerance	mm	+ 0,1	

15.00

90°

50 mm²

Product data

IEC: 1000 V / 150 A / 0.5 - 50 mm²
 UL: 600 V / 126 A / AWG 20 - 1



For additional articles and information, refer to catalog.weidmueller.com

Note:

- Additional colours on request
- Rated current related to rated cross-section & min. No. of poles.
- Wire end ferrule without plastic collar to DIN 46228/1
- Wire end ferrule with plastic collar to DIN 46228/4
- P on drawing = pitch
- Rated data refer only to the component itself. Clearance and creepage distances to other components are to be designed in accordance with the relevant application standards.
- IP 20 from 16 mm² to 50 mm²
- The test point can only be used as potential-pickup point.
- Wire-end ferrules are mandatory for stranded wires with more than 19 strands.
- Long term storage of the product with average temperature of 50 °C and average humidity 70%, 36 months

Accessories

Note: Refer to the Accessories chapter for additional accessories.

Screwdriver	Order No.
SDS 1.2X6.5X150	2749390000
SDIS 1.2X6.5X150	2749860000
Crosshead screwdriver	
SDK PZ2 X 100	2749450000
SDIK PZ2 X 100	2749930000
Test plug	
PS 2.0 MC	0310000000
Identification systems	
DEK 5 NEUTRAL	0473360000
Marking tags	
DEK 5/5 MC NE WS	1609801044

LXXX 15.00/./90

with test point



Dimensioned drawing

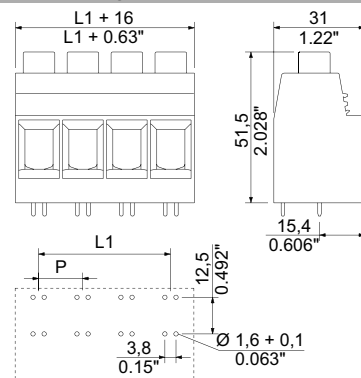

Ordering data

Solder pin length		4.5 mm		
Colour		black		
Pitch		15.00 mm		
Pol.	L1	(inch)	Qty.	Order No.
1	0.00	0.000	20	1047120000
2	15.00	0.591	20	1047130000
3	30.00	1.181	10	1047140000
4	45.00	1.772	10	1047150000
5	60.00	2.363	16	1386250000
6	75.00	2.954	12	1386400000
7	90.00	3.545	12	1386550000
8	105.00	4.136	10	1386700000
9	120.00	4.727	8	1386850000

Representative deratings curve

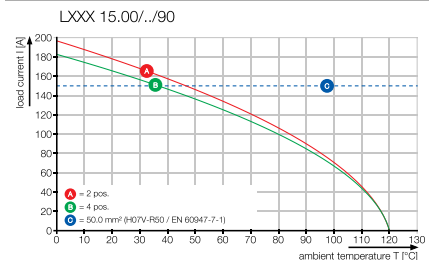

LXXX 15.00../90F

with fixing flange and test point



Dimensioned drawing

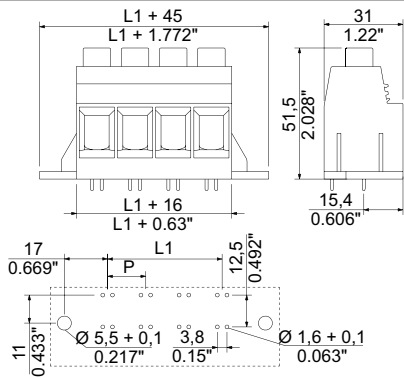

Ordering data

Solder pin length		4.5 mm	
Colour		black	
Pitch		15.00 mm	
Pol.	L1	(inch)	Qty. Order No.
1	0.00	0.000	20 1047280000
2	15.00	0.591	20 1047290000
3	30.00	1.181	10 1047300000
4	45.00	1.772	10 1047310000
5	60.00	2.363	12 1386290000
6	75.00	2.954	10 1386440000
7	90.00	3.545	8 1386590000
8	105.00	4.136	8 1386740000
9	120.00	4.727	8 1386890000

LXXX 15.00../90FL

with fixing flange left and test point



Dimensioned drawing

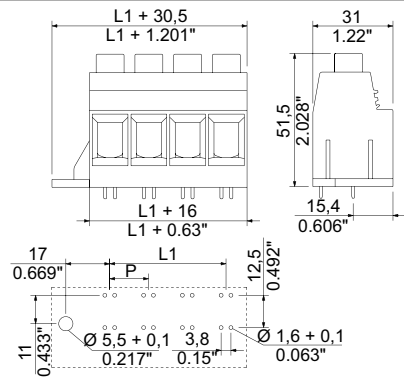

Ordering data

Solder pin length		4.5 mm	
Colour		black	
Pitch		15.00 mm	
Pol.	L1	(inch)	Qty. Order No.
1	0.00	0.000	20 1047440000
2	15.00	0.591	20 1047450000
3	30.00	1.181	10 1047460000
4	45.00	1.772	10 1047470000
5	60.00	2.363	12 1386330000
6	75.00	2.954	12 1386480000
7	90.00	3.545	10 1386630000
8	105.00	4.136	8 1386780000
9	120.00	4.727	8 1386930000

LXXX 15.00../90FR

with fixing flange right and test point



Dimensioned drawing

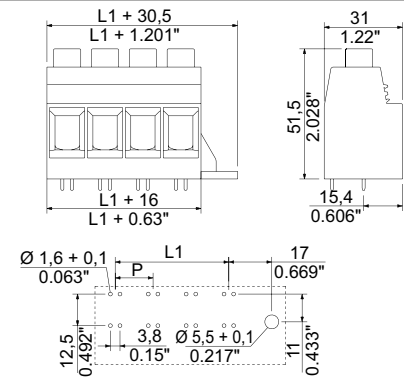

Ordering data

Solder pin length		4.5 mm	
Colour		black	
Pitch		15.00 mm	
Pol.	L1	(inch)	Qty. Order No.
1	0.00	0.000	20 1047600000
2	15.00	0.591	20 1047610000
3	30.00	1.181	10 1047620000
4	45.00	1.772	10 1047630000
5	60.00	2.363	12 1386370000
6	75.00	2.954	12 1386520000
7	90.00	3.545	10 1386670000
8	105.00	4.136	8 1386820000
9	120.00	4.727	8 1386970000

Additional deratings curves

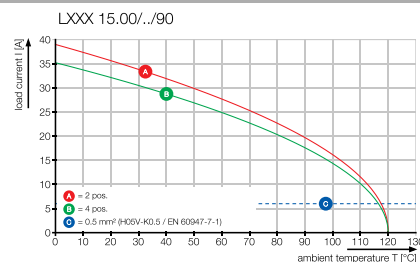
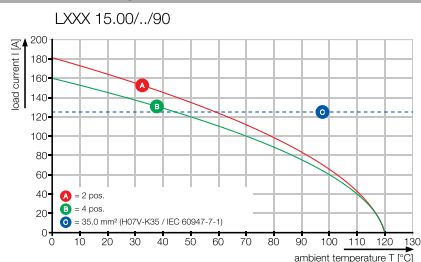

LLF 7.50/..90

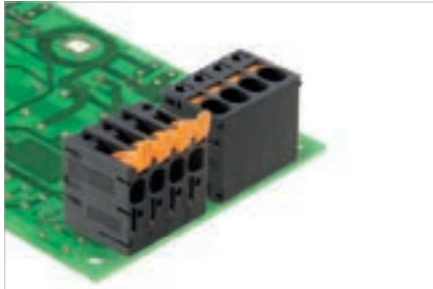

High-performance PCB terminal with PUSH IN connection system for wire cross-sections up to 6 mm².

- Fast connection without tools thanks to an operating lever for opening the contact point, or direct insertion
- Securely closed contact point: with the "Connection Safety Concept" the conductor is always clamped securely
- Integrated test point for test plug PS 2.0
- Central tip test point for test probes on the upper side of the terminal
- Increased derating reserves through the use of WEMID insulating material
- Wire outlet direction: 90° version

Technical data

In compliance with IEC 60664-1 / IEC 61984

Clamping range, max.	mm ²	0.25...6	
Solid core H05(07) V-U	mm²	0.5...6	
Stranded H07 V-R			
Flexible H05(07) V-K	mm ²	0.5...6	
Flexible with ferrule	mm ²	0.25...6	
Ferrule with plastic collar	mm ²	0.25...6	
Stripping length	mm	12	
Screwdriver blade	mm		
According to norm			
Tightening torque range			
Rated current, max.	A	41	41
At ambient temperature		20°C	40°C
For conductor cross-section			
Overtoltage category		III	III II
Pollution severity		3	2 2
Rated voltage	V	600	1000 1000
Rated impulse voltage	kV	6	6 6
UL / CUL (Use Group)		B	C D
Rated voltage	V	300	150 300
Rated current	A	35	35 10
AWG conductor	AWG		24-8
CSA (Use Group)		B	C D
Rated voltage	V	300	1000 300
Rated current	A	35	35 10
AWG conductor	AWG		24-8
General data			
Type of insulation material		Wemid (PA)	
UL 94 flammability rating		V-0	
Contact base material		E-Cu	
Material of contact surface		tinned	
Pin dimensions = d	mm	d = 1.5	
Solder eyelet Ø = D	mm	2	
Solder eyelet Ø tolerance	mm	+ 0,1	

Product data

IEC: 1000 V / 41 A / 0.5 - 6 mm²
 UL: 300 V / 35 A / AWG 24 - 8



For additional articles and information, refer to catalog.weidmueller.com

Note:

- Additional colours on request
- Rated current related to rated cross-section & min. No. of poles.
- Wire end ferrule without plastic collar to DIN 46228/1
- Wire end ferrule with plastic collar to DIN 46228/4
- P on drawing = pitch
- Rated data refer only to the component itself. Clearance and creepage distances to other components are to be designed in accordance with the relevant application standards.
- The test point can only be used as potential-pickup point.
- The single-position PCB terminal block can be used for voltages up to 1500 V (DC) and 1000 V (AC). The relevant device standard and the appropriate required clearances and creepage distances should be observed in the application
- Long term storage of the product with average temperature of 50 °C and average humidity 70%, 36 months

LLF 7.50/..90



Dimensioned drawing

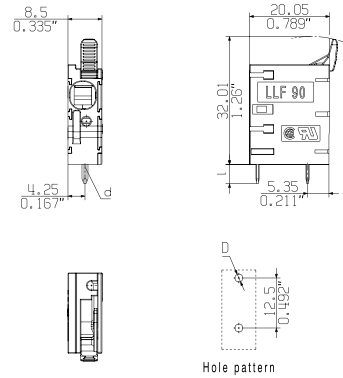

Accessories

Note: Refer to the Accessories chapter for additional accessories.

Screwdriver		Order No.
	SDIS 0.5X3.0X100	2749800000
	SDS 0.5X3.0X80	2749330000
Test plug		
	PS 2.0 MC	0310000000

Ordering data

Solder pin length	5 mm			
Colour	black			
Pitch	7.50 mm			
Pol.	L1	(inch)	Qty.	Order No.
1	0.00	0.000	200	2471520000

Representative deratings curve

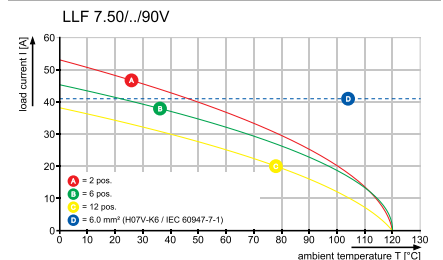

LLF 7.50/.. /90V



High-performance PCB terminal with PUSH IN connection system for wire cross-sections up to 6 mm².

- Fast connection without tools thanks to an operating lever for opening the contact point, or direct insertion
- Securely closed contact point: with the "Connection Safety Concept" the conductor is always clamped securely
- Integrated test point for test plug PS 2.0
- Central tip test point for test probes on the upper side of the terminal
- Increased derating reserves through the use of WEMID insulating material
- Wire outlet direction: 90° version

Technical data

In compliance with IEC 60664-1 / IEC 61984			
Clamping range, max.	mm ²	0.25...6	
Solid core H05(07) V-U	mm²	0.5...6	
Stranded H07 V-R			
Flexible H05(07) V-K	mm ²	0.5...6	
Flexible with ferrule	mm ²	0.25...6	
Ferrule with plastic collar	mm ²	0.25...6	
Stripping length	mm	12	
Screwdriver blade	mm		
According to norm			
Tightening torque range			
Rated current, max.	A	41	41
At ambient temperature	20°C		40°C
For conductor cross-section			
Overtoltage category		III	III II
Pollution severity		3	2 2
Rated voltage	V	1000	1000 1000
Rated impulse voltage	kV	8	8 8
UL / CUL (Use Group)		B	C D
Rated voltage	V	600	600 600
Rated current	A	35	35 5
AWG conductor	AWG	24-8	
CSA (Use Group)		B	C D
Rated voltage	V	600	600 600
Rated current	A	35	35 5
AWG conductor	AWG	24-8	
General data			
Type of insulation material		Wemid (PA)	
UL 94 flammability rating		V-0	
Contact base material		E-Cu	
Material of contact surface		tinned	
Pin dimensions = d	mm	d = 1.5	
Solder eyelet Ø = D	mm	2	
Solder eyelet Ø tolerance	mm	+ 0,1	

Product data

IEC: 1000 V / 41 A / 0.5 - 6 mm²
 UL: 600 V / 35 A / AWG 24 - 8



For additional articles and information, refer to catalog.weidmueller.com

Note:

- Additional colours on request
- Rated current related to rated cross-section & min. No. of poles.
- Wire end ferrule without plastic collar to DIN 46228/1
- Wire end ferrule with plastic collar to DIN 46228/4
- P on drawing = pitch
- Rated data refer only to the component itself. Clearance and creepage distances to other components are to be designed in accordance with the relevant application standards.
- The test point can only be used as potential-pickup point.
- The single-position PCB terminal block can be used for voltages up to 1500 V (DC) and 1000 V (AC). The relevant device standard and the appropriate required clearances and creepage distances should be observed in the application
- Long term storage of the product with average temperature of 50 °C and average humidity 70%, 36 months

LLF 7.50/.. /90V



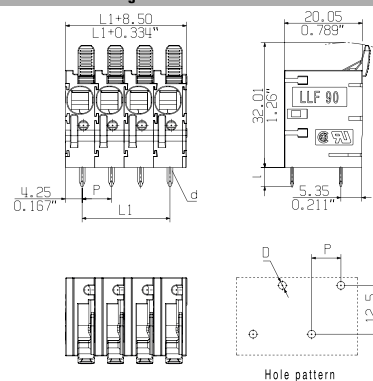

Dimensioned drawing



Accessories

Note: Refer to the Accessories chapter for additional accessories.

Screwdriver		Order No.
	SDIS 0.5X3.0X100	2749800000
	SDS 0.5X3.0X80	2749330000
Test plug		
	PS 2.0 MC	0310000000

Ordering data

Solder pin length		5 mm		
Colour		black		
Pitch		7.50 mm		
Pol.	L1	(inch)	Qty.	Order No.
2	7.50	0.295	100	2471530000
3	15.00	0.590	80	2472090000
4	22.50	0.885	80	2472100000
5	30.00	1.180	50	2472110000
6	37.50	1.475	50	2472120000
7	45.00	1.770	50	2472130000
8	52.50	2.065	30	2472140000
9	60.00	2.360	30	2472150000
10	67.50	2.655	20	2472160000
11	75.00	2.950	20	2472170000
12	82.50	3.245	20	2472180000

Representative deratings curve

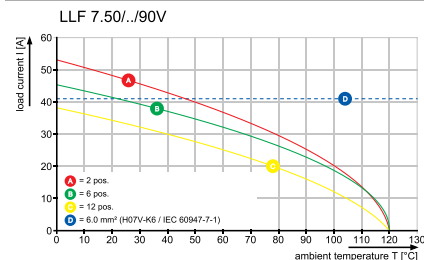

LLFS 7.50/./90



High-performance PCB terminal with PUSH IN connection system for wire cross-sections up to 6 mm².

- Fast connection without tools thanks to an operating lever for opening the contact point, or direct insertion
- Securely closed contact point: with the "Connection Safety Concept" the conductor is always clamped securely
- Integrated test point for test plug PS 2.0
- Central tip test point for test probes on the upper side of the terminal
- Increased derating reserves through the use of WEMID insulating material
- Wire outlet direction: 90° version

Technical data

In compliance with IEC 60664-1 / IEC 61984			
Clamping range, max.	mm ²	0.25...6	
Solid core H05(07) V-U	mm²	0.5...4	
Stranded H07 V-R			
Flexible H05(07) V-K	mm ²	0.5...6	
Flexible with ferrule	mm ²	0.25...6	
Ferrule with plastic collar	mm ²	0.25...6	
Stripping length	mm	12	
Screwdriver blade	mm		
According to norm			
Tightening torque range			
Rated current, max.	A	41	41
At ambient temperature		20°C	40°C
For conductor cross-section			
Overtoltage category		III	III II
Pollution severity		3	2 2
Rated voltage	V	600	1000 1000
Rated impulse voltage	kV	6	6 6
UL / CUL (Use Group)		B	C D
Rated voltage	V	300	150 300
Rated current	A	37	37 10
AWG conductor	AWG		24-8
CSA (Use Group)		B	C D
Rated voltage	V	300	1000 300
Rated current	A	37	37 10
AWG conductor	AWG		-
General data			
Type of insulation material		Wemid (PA)	
UL 94 flammability rating		V-0	
Contact base material		E-Cu	
Material of contact surface		tinned	
Pin dimensions = d	mm	d = 1.5	
Solder eyelet Ø = D	mm	2	
Solder eyelet Ø tolerance	mm	+ 0,1	

Product data

IEC: 1000 V / 41 A / 0.5 - 6 mm²
 UL: 300 V / 37 A / AWG 24 - 8



For additional articles and information, refer to catalog.weidmueller.com

Note:

- Additional colours on request
- Rated current related to rated cross-section & min. No. of poles.
- Wire end ferrule without plastic collar to DIN 46228/1
- Wire end ferrule with plastic collar to DIN 46228/4
- P on drawing = pitch
- Rated data refer only to the component itself. Clearance and creepage distances to other components are to be designed in accordance with the relevant application standards.
- The test point can only be used as potential-pickup point.
- The single-position PCB terminal block can be used for voltages up to 1500 V (DC) and 1000 V (AC). The relevant device standard and the appropriate required clearances and creepage distances should be observed in the application
- Long term storage of the product with average temperature of 50 °C and average humidity 70%, 36 months

LLFS 7.50/./90



Dimensioned drawing

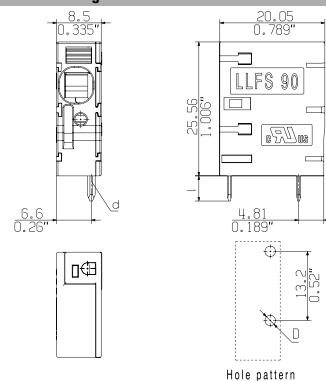

Accessories

Note: Refer to the Accessories chapter for additional accessories.

Screwdriver		Order No.
	SDIS 0.8X4.0X100	2749820000
	SDS 0.8X4.0X100	2749360000
Test plug		
	PS 2.0 MC	0310000000

Ordering data

Solder pin length		5 mm	
Colour		black	
Pitch		7.50 mm	
Pol.	L1	(inch)	Qty. Order No.
1	0.00	0.000	200 2473420000

Representative deratings curve

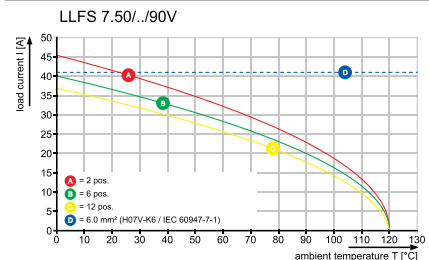

LLFS 7.50/./90V



High-performance PCB terminal with PUSH IN connection system for wire cross-sections up to 6 mm².

- Fast connection without tools thanks to an operating lever for opening the contact point, or direct insertion
- Securely closed contact point: with the "Connection Safety Concept" the conductor is always clamped securely
- Integrated test point for test plug PS 2.0
- Central tip test point for test probes on the upper side of the terminal
- Increased derating reserves through the use of WEMID insulating material
- Wire outlet direction: 90° version

Technical data

In compliance with IEC 60664-1 / IEC 61984			
Clamping range, max.	mm ²	0.25...6	
Solid core H05(07) V-U	mm²	0.5...6	
Stranded H07 V-R			
Flexible H05(07) V-K	mm ²	0.5...6	
Flexible with ferrule	mm ²	0.25...6	
Ferrule with plastic collar	mm ²	0.25...6	
Stripping length	mm	12	
Screwdriver blade	mm		
According to norm			
Tightening torque range			
Rated current, max.	A	41	37
At ambient temperature	20°C		40°C
For conductor cross-section			
Overtoltage category		III	III II
Pollution severity		3	2 2
Rated voltage	V	1000	1000 1000
Rated impulse voltage	kV	8	8 8
UL / CUL (Use Group)		B	C D
Rated voltage	V	600	600 600
Rated current	A	37	37 5
AWG conductor	AWG	24-8	
CSA (Use Group)		B	C D
Rated voltage	V	600	600 600
Rated current	A	37	37 5
AWG conductor	AWG	24-8	
General data			
Type of insulation material		Wemid (PA)	
UL 94 flammability rating		V-0	
Contact base material		E-Cu	
Material of contact surface		tinned	
Pin dimensions = d	mm	d = 1.5	
Solder eyelet Ø = D	mm	2	
Solder eyelet Ø tolerance	mm	+ 0,1	

Product data

IEC: 1000 V / 41 A / 0.5 - 6 mm²
 UL: 600 V / 37 A / AWG 24 - 8



For additional articles and information, refer to catalog.weidmueller.com

Note:

- Additional colours on request
- Rated current related to rated cross-section & min. No. of poles.
- Wire end ferrule without plastic collar to DIN 46228/1
- Wire end ferrule with plastic collar to DIN 46228/4
- P on drawing = pitch
- Rated data refer only to the component itself. Clearance and creepage distances to other components are to be designed in accordance with the relevant application standards.
- The test point can only be used as potential-pickup point.
- The single-position PCB terminal block can be used for voltages up to 1500 V (DC) and 1000 V (AC). The relevant device standard and the appropriate required clearances and creepage distances should be observed in the application
- Long term storage of the product with average temperature of 50 °C and average humidity 70%, 36 months

LLFS 7.50/./90V



Dimensioned drawing

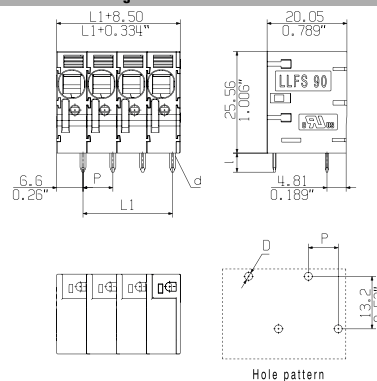

Accessories

Note: Refer to the Accessories chapter for additional accessories.

Screwdriver		Order No.
	SDIS 0.8X4.0X100	2749820000
	SDS 0.8X4.0X100	2749360000
Test plug		
	PS 2.0 MC	0310000000

Ordering data

Solder pin length		5 mm		
Colour		black		
Pitch		7.50 mm		
Pol.	L1	(inch)	Qty.	Order No.
2	7.50	0.295	100	2473000000
3	15.00	0.590	80	2473010000
4	22.50	0.885	80	2473020000
5	30.00	1.180	50	2473030000
6	37.50	1.475	50	2473040000
7	45.00	1.770	50	2473050000
8	52.50	2.065	30	2473060000
9	60.00	2.360	30	2473070000
10	67.50	2.655	20	2473080000
11	75.00	2.950	20	2473090000
12	82.50	3.245	20	2473100000

Representative deratings curve

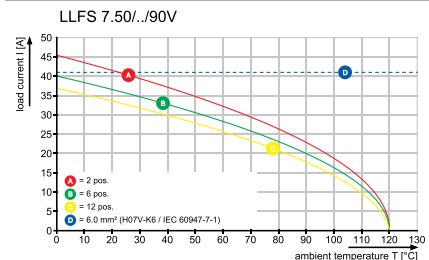

LLFS 7.50/./180



High-performance PCB terminal with PUSH IN connection system for wire cross-sections up to 6 mm².

- Fast connection without tools thanks to an operating lever for opening the contact point, or direct insertion
- Securely closed contact point: with the "Connection Safety Concept" the conductor is always clamped securely
- Integrated test point for test plug PS 2.0
- Central tip test point for test probes on the upper side of the terminal
- Increased derating reserves through the use of WEMID insulating material
- Wire outlet direction: 90° version

Technical data

In compliance with IEC 60664-1 / IEC 61984

Clamping range, max.	mm ²	0.25...6	
Solid core H05(07) V-U	mm²	0.5...6	
Stranded H07 V-R			
Flexible H05(07) V-K	mm ²	0.5...6	
Flexible with ferrule	mm ²	0.25...6	
Ferrule with plastic collar	mm ²	0.25...6	
Stripping length	mm	12	
Screwdriver blade	mm		
According to norm			
Tightening torque range			
Rated current, max.	A	41	41
At ambient temperature		20°C	40°C
For conductor cross-section			
Overtoltage category		III	III II
Pollution severity		3	2 2
Rated voltage	V	600	1000 1000
Rated impulse voltage	kV	6	6 6
UL / CUL (Use Group)		B	C D
Rated voltage	V	300	150 300
Rated current	A	37	37 10
AWG conductor	AWG		24-8
CSA (Use Group)		B	C D
Rated voltage	V	300	1000 300
Rated current	A	37	37 10
AWG conductor	AWG		24-8
General data			
Type of insulation material		Wemid (PA)	
UL 94 flammability rating		V-0	
Contact base material		E-Cu	
Material of contact surface		tinned	
Pin dimensions = d	mm	d = 1.5	
Solder eyelet Ø = D	mm	2	
Solder eyelet Ø tolerance	mm	+ 0,1	

Product data

IEC: 1000 V / 41 A / 0.5 - 6 mm²
 UL: 300 V / 37 A / AWG 24 - 8



For additional articles and information, refer to catalog.weidmueller.com

Note:

- Additional colours on request
- Rated current related to rated cross-section & min. No. of poles.
- Wire end ferrule without plastic collar to DIN 46228/1
- Wire end ferrule with plastic collar to DIN 46228/4
- P on drawing = pitch
- Rated data refer only to the component itself. Clearance and creepage distances to other components are to be designed in accordance with the relevant application standards.
- The test point can only be used as potential-pickup point.
- The single-position PCB terminal block can be used for voltages up to 1500 V (DC) and 1000 V (AC). The relevant device standard and the appropriate required clearances and creepage distances should be observed in the application
- Long term storage of the product with average temperature of 50 °C and average humidity 70%, 36 months

LLFS 7.50/./180



Dimensioned drawing

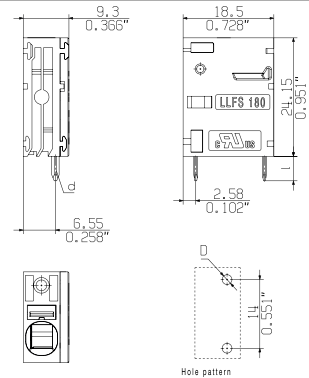

Accessories

Note: Refer to the Accessories chapter for additional accessories.

Screwdriver		Order No.
	SDIS 0.8X4.0X100	2749820000
	SDS 0.8X4.0X100	2749360000
Test plug		
	PS 2.0 MC	0310000000

Ordering data

Solder pin length	5 mm			
Colour	black			
Pitch	7.50 mm			
Pol.	L1	(inch)	Qty.	Order No.
1	0.00	0.000	200	2491110000

Representative deratings curve

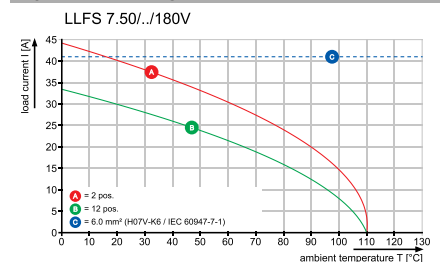

LLFS 7.50/./180V



High-performance PCB terminal with PUSH IN connection system for wire cross-sections up to 6 mm².

- Fast connection without tools thanks to an operating lever for opening the contact point, or direct insertion
- Securely closed contact point: with the "Connection Safety Concept" the conductor is always clamped securely
- Integrated test point for test plug PS 2.0
- Central tip test point for test probes on the upper side of the terminal
- Increased derating reserves through the use of WEMID insulating material
- Wire outlet direction: 90° version

Technical data

In compliance with IEC 60664-1 / IEC 61984			
Clamping range, max.	mm ²	0.25...6	
Solid core H05(07) V-U	mm²	0.5...6	
Stranded H07 V-R			
Flexible H05(07) V-K	mm ²	0.5...6	
Flexible with ferrule	mm ²	0.25...6	
Ferrule with plastic collar	mm ²	0.25...6	
Stripping length	mm	12	
Screwdriver blade	mm		
According to norm			
Tightening torque range			
Rated current, max.	A	41	38
At ambient temperature		20°C	40°C
For conductor cross-section			
Overtoltage category		III	III II
Pollution severity		3	2 2
Rated voltage	V	1000	1000 1000
Rated impulse voltage	kV	8	8 8
UL / CUL (Use Group)		B	C D
Rated voltage	V	600	600 600
Rated current	A	37	37 5
AWG conductor	AWG	24-8	
CSA (Use Group)		B	C D
Rated voltage	V	600	600 600
Rated current	A	37	37 5
AWG conductor	AWG	-	
General data			
Type of insulation material		Wemid (PA)	
UL 94 flammability rating		V-0	
Contact base material		E-Cu	
Material of contact surface		tinned	
Pin dimensions = d	mm	d = 1.5	
Solder eyelet Ø = D	mm	2	
Solder eyelet Ø tolerance	mm	+ 0,1	

Product data

IEC: 1000 V / 41 A / 0.5 - 6 mm²
 UL: 600 V / 37 A / AWG 24 - 8



For additional articles and information, refer to catalog.weidmueller.com

Note:

- Additional colours on request
- Rated current related to rated cross-section & min. No. of poles.
- Wire end ferrule without plastic collar to DIN 46228/1
- Wire end ferrule with plastic collar to DIN 46228/4
- P on drawing = pitch
- Rated data refer only to the component itself. Clearance and creepage distances to other components are to be designed in accordance with the relevant application standards.
- The test point can only be used as potential-pickup point.
- The single-position PCB terminal block can be used for voltages up to 1500 V (DC) and 1000 V (AC). The relevant device standard and the appropriate required clearances and creepage distances should be observed in the application
- Long term storage of the product with average temperature of 50 °C and average humidity 70%, 36 months

LLFS 7.50/./180V



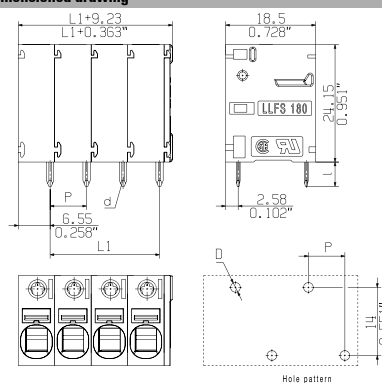

Dimensioned drawing



Accessories

Note: Refer to the Accessories chapter for additional accessories.

Screwdriver		Order No.
	SDIS 0.8X4.0X100	2749820000
	SDS 0.8X4.0X100	2749360000
Test plug		
	PS 2.0 MC	0310000000

Ordering data

Solder pin length		5 mm		
Colour		black		
Pitch		7.50 mm		
Pol.	L1	(inch)	Qty.	Order No.
2	7.50	0.295	100	2491620000
3	15.00	0.591	80	2491630000
4	22.50	0.886	80	2491640000
5	37.50	1.476	50	2491650000
6	30.00	1.181	50	2491660000
7	45.00	1.772	50	2491670000
8	52.50	2.067	30	2491680000
9	60.00	2.362	30	2491690000
10	67.50	2.657	20	2491700000
11	75.00	2.953	20	2491710000
12	82.50	3.248	20	2491720000

Representative deratings curve

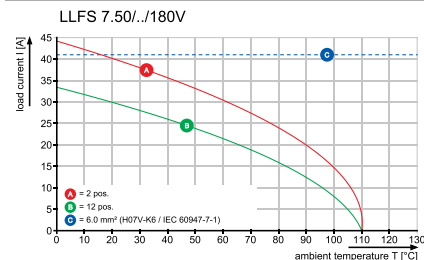

LUF 10.00/.. /90

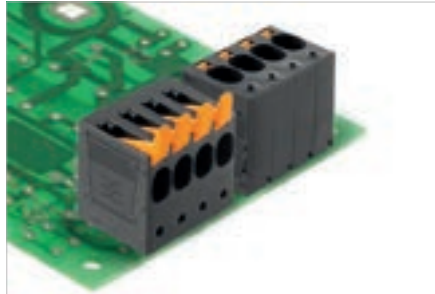

High-performance PCB terminal block with PUSH IN connection system for wire cross-sections up to 16 mm².

- Fast connection without tools thanks to an operating lever for opening the contact point, or direct insertion
- Securely closed contact point: with the Connection Safety Concept, the conductor is always clamped securely
- Integrated test point for PS 2.0 test plug
- Central tip test point for test probes on the upper side of the terminal
- Increased derating reserves thanks to WEMID insulating material
- Wire outlet direction of 90°

Technical data

In compliance with IEC 60664-1 / IEC 61984			
Clamping range, max.	mm ²	0.5...16	
Solid core H05(07) V-U	mm²	0.5...16	
Stranded H07 V-R	mm ²	6...25	
Flexible H05(07) V-K	mm ²	0.5...25	
Flexible with ferrule	mm ²	0.5...16	
Ferrule with plastic collar	mm ²	0.5...16	
Stripping length	mm	18	
Screwdriver blade	mm	0.8 x 4.0	
According to norm			
Tightening torque range			
Rated current, max.	A	101	101
At ambient temperature		20°C	40°C
For conductor cross-section			
Overtension category		III	III II
Pollution severity		3	2 2
Rated voltage	V	1000	1000 1000
Rated impulse voltage	kV	8	8 8
UL / CUL (Use Group)	B C D		
Rated voltage	V	600	600 600
Rated current	A	61	61 5
AWG conductor	AWG	18-6	
CSA (Use Group)	B C D		
Rated voltage	V	300	1000 600
Rated current	A	61	61 5
AWG conductor	AWG	18-6	
General data			
Type of insulation material		Wemid (PA)	
UL 94 flammability rating		V-0	
Contact base material			
Material of contact surface			
Pin dimensions = d	mm	1.2, Octagonal	
Solder eyelet Ø = D	mm	1.6	
Solder eyelet Ø tolerance	mm	+ 0,1	

Product data

IEC: 1000 V / 101 A / 0.5 - 25 mm²
 UL: 600 V / 61 A / AWG 18 - 6



For additional articles and information, refer to catalog.weidmuller.com

Note:

- Additional colours on request
- Rated current related to rated cross-section & min. No. of poles.
- Wire end ferrule without plastic collar to DIN 46228/1
- Wire end ferrule with plastic collar to DIN 46228/4
- P on drawing = pitch
- Rated data refer only to the component itself. Clearance and creepage distances to other components are to be designed in accordance with the relevant application standards.
- The test point can only be used as potential-pickup point.
- The single-position PCB terminal block can be used for voltages up to 1500 V (DC) and 1000 V (AC). The relevant device standard and the appropriate required clearances and creepage distances should be observed in the application
- Long term storage of the product with average temperature of 50 °C and average humidity 70%, 36 months

LUF 10.00/.. /90



Dimensioned drawing

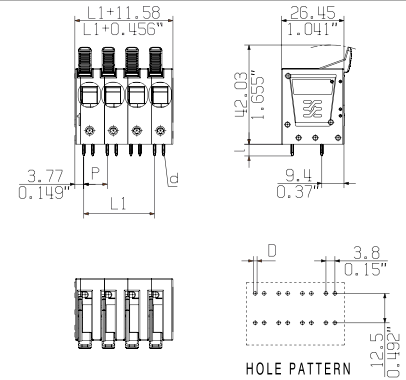

Ordering data

Solder pin length		5 mm		
Colour		black		
Pitch		10.00 mm		
Pol.	L1	(inch)	Qty.	Order No.
1	0.00	0.000	50	1988590000
2	10.00	0.394	40	1988600000
3	20.00	0.787	40	1988610000
4	30.00	1.181	30	1988620000
5	40.00	1.575	25	1988630000
6	50.00	1.969	20	1988640000
7	60.00	2.362	10	1988650000
8	70.00	2.756	10	1988660000
9	80.00	3.150	10	1988670000
10	90.00	3.543	10	1988680000
11	100.00	3.937	10	1988690000
12	110.00	4.331	10	1988700000

Representative deratings curve

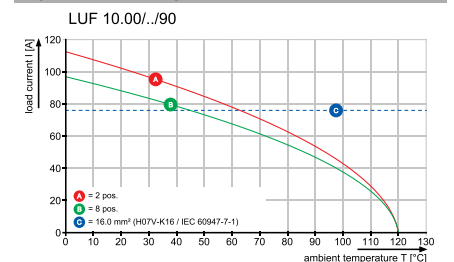

Accessories

Note: Refer to the Accessories chapter for additional accessories.

Screwdriver		Order No.
	SDS 0.8X4.0X100	2749360000
	SDIS 0.8X4.0X100	2749820000
Test plug		
	PS 2.0 MC	0310000000

LUF 10.00/./90V



High-performance PCB terminal with PUSH IN connection system for wire cross-sections up to 16 mm².

- Fast connection without tools thanks to an operating lever for opening the contact point, or direct insertion
- Securely closed contact point: with the "Connection Safety Concept" the conductor is always clamped securely
- Integrated test point for test plug PS 2.0
- Central tip test point for test probes on the upper side of the terminal
- Increased derating reserves through the use of WEMID insulating material
- Wire outlet direction: 90° version

Technical data

In compliance with IEC 60664-1 / IEC 61984			
Clamping range, max.	mm ²	0.5...16	
Solid core H05(07) V-U	mm²	0.5...16	
Stranded H07 V-R	mm ²	6...25	
Flexible H05(07) V-K	mm ²	0.5...25	
Flexible with ferrule	mm ²	0.5...16	
Ferrule with plastic collar	mm ²	0.5...16	
Stripping length	mm	18	
Screwdriver blade	mm	0.8 x 4.0	
According to norm			
Tightening torque range			
Rated current, max.	A	92	82
At ambient temperature		20°C	40°C
For conductor cross-section			
Overtoltage category		III	III II
Pollution severity		3	2 2
Rated voltage	V	1000	690 1000
Rated impulse voltage	kV	8	6 6
UL / CUL (Use Group)		B	C D
Rated voltage	V	600	600 600
Rated current	A	58	58 5
AWG conductor	AWG	18-6	
CSA (Use Group)		B	C D
Rated voltage	V	600	600 600
Rated current	A	58	58 5
AWG conductor	AWG	18-6	
General data			
Type of insulation material		Wemid (PA)	
UL 94 flammability rating		V-0	
Contact base material			
Material of contact surface			
Pin dimensions = d	mm	1.2, Octagonal	
Solder eyelet Ø = D	mm	1.6	
Solder eyelet Ø tolerance	mm	+ 0,1	

Product data

IEC: 1000 V / 92 A / 0.5 - 25 mm²
 UL: 600 V / 58 A / AWG 18 - 6



For additional articles and information, refer to catalog.weidmueller.com

Note:

- Additional colours on request
- Rated current related to rated cross-section & min. No. of poles.
- Wire end ferrule without plastic collar to DIN 46228/1
- Wire end ferrule with plastic collar to DIN 46228/4
- P on drawing = pitch
- Rated data refer only to the component itself. Clearance and creepage distances to other components are to be designed in accordance with the relevant application standards.
- The test point can only be used as potential-pickup point.
- The single-position PCB terminal block can be used for voltages up to 1500 V (DC) and 1000 V (AC). The relevant device standard and the appropriate required clearances and creepage distances should be observed in the application
- Long term storage of the product with average temperature of 50 °C and average humidity 70%, 36 months

LUF 10.00/./90V



Dimensioned drawing

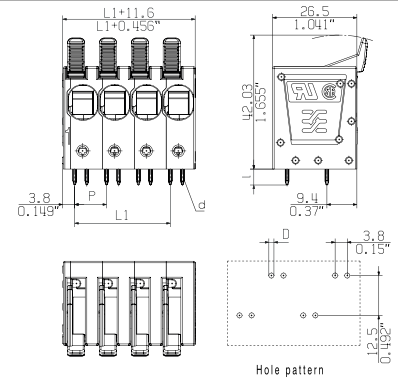

Accessories

Note: Refer to the Accessories chapter for additional accessories.

Screwdriver		Order No.
	SDIS 0.8X4.0X100	2749820000
	SDS 0.8X4.0X100	2749360000
Test plug		
	PS 2.0 MC	0310000000

Ordering data

Solder pin length		5 mm		
Colour		black		
Pitch 10.00 mm				
Pol.	L1	(inch)	Qty.	Order No.
2	10.00	0.394	40	2453690000
3	20.00	0.787	40	2453700000
4	30.00	1.181	30	2453710000
5	40.00	1.575	25	2453720000
6	50.00	1.969	20	2453730000
7	60.00	2.362	10	2453740000
8	70.00	2.756	10	2453750000
9	80.00	3.150	10	2453760000
10	90.00	3.543	10	2453770000
11	100.00	3.937	10	2453780000
12	110.00	4.331	10	2453790000

Representative deratings curve

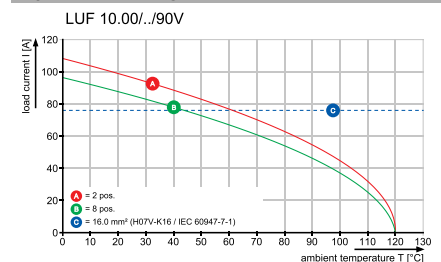

LUF5 10.00/./90

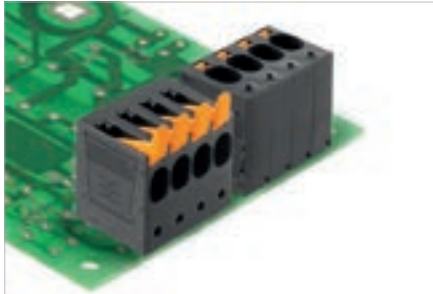

High-performance PCB terminal block with PUSH IN connection system for wire cross-sections up to 16 mm².

- Fast connection without tools thanks to an operating lever for opening the contact point, or direct insertion
- Securely closed contact point: with the Connection Safety Concept, the conductor is always clamped securely
- Integrated test point for PS 2.0 test plug
- Central tip test point for test probes on the upper side of the terminal
- Increased derating reserves thanks to WEMID insulating material
- Wire outlet direction of 90°

Technical data

In compliance with IEC 60664-1 / IEC 61984			
Clamping range, max.	mm ²	0.5...16	
Solid core H05(07) V-U	mm²	0.5...16	
Stranded H07 V-R	mm ²	6...25	
Flexible H05(07) V-K	mm ²	0.5...25	
Flexible with ferrule	mm ²	0.5...16	
Ferrule with plastic collar	mm ²	0.5...16	
Stripping length	mm	18	
Screwdriver blade	mm	0.8 x 4.0	
According to norm			
Tightening torque range			
Rated current, max.	A	76	76
At ambient temperature		20°C	40°C
For conductor cross-section			
Overtoltage category		III	III II
Pollution severity		3	2 2
Rated voltage	V	1000	1000 1000
Rated impulse voltage	kV	8	8 8
UL / CUL (Use Group)		B	C D
Rated voltage	V	600	600 600
Rated current	A	53	53 5
AWG conductor	AWG		18-4
CSA (Use Group)		B	C D
Rated voltage	V	600	600 600
Rated current	A	53	53 5
AWG conductor	AWG		18-4
General data			
Type of insulation material		Wemid (PA)	
UL 94 flammability rating		V-0	
Contact base material			
Material of contact surface			
Pin dimensions = d	mm	1.2, Octagonal	
Solder eyelet Ø = D	mm	1.6	
Solder eyelet Ø tolerance	mm	+ 0,1	

Product data

IEC: 1000 V / 76 A / 0.5 - 25 mm²
 UL: 600 V / 53 A / AWG 18 - 4



For additional articles and information, refer to catalog.weidmueller.com

Note:

- Additional colours on request
- Rated current related to rated cross-section & min. No. of poles.
- Wire end ferrule without plastic collar to DIN 46228/1
- Wire end ferrule with plastic collar to DIN 46228/4
- P on drawing = pitch
- Rated data refer only to the component itself. Clearance and creepage distances to other components are to be designed in accordance with the relevant application standards.
- The test point can only be used as potential-pickup point.
- The single-position PCB terminal block can be used for voltages up to 1500 V (DC) and 1000 V (AC). The relevant device standard and the appropriate required clearances and creepage distances should be observed in the application
- Long term storage of the product with average temperature of 50 °C and average humidity 70%, 36 months

LUF5 10.00/./90



Dimensioned drawing

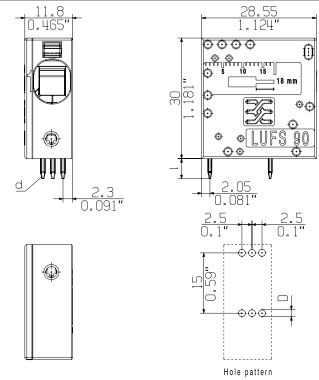

Accessories

Note: Refer to the Accessories chapter for additional accessories.

Screwdriver		Order No.
	SDIS 0.8X4.0X100	2749820000
	SDS 0.8X4.0X100	2749360000
Test plug		
	PS 2.0 MC	0310000000

Ordering data

Solder pin length		5 mm	
Colour		black	
Pitch		10.00 mm	
Pol.	L1	(inch)	Qty. Order No.
1	0.00	0.000	50 2500560000

Representative deratings curve

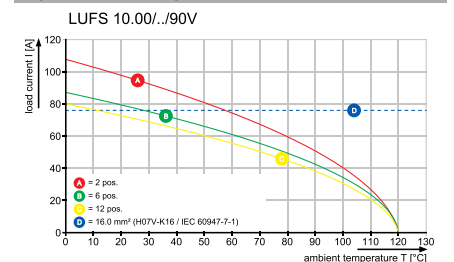

LUF5 10.00/./90V



High-performance PCB terminal block with PUSH IN connection system for wire cross-sections up to 16 mm².

- Fast connection without tools thanks to an operating lever for opening the contact point, or direct insertion
- Securely closed contact point: with the Connection Safety Concept, the conductor is always clamped securely
- Integrated test point for PS 2.0 test plug
- Central tip test point for test probes on the upper side of the terminal
- Increased derating reserves thanks to WEMID insulating material
- Wire outlet direction of 90°

Technical data

In compliance with IEC 60664-1 / IEC 61984			
Clamping range, max.	mm ²	0.5...16	
Solid core H05(07) V-U	mm²	0.5...16	
Stranded H07 V-R	mm ²	6...25	
Flexible H05(07) V-K	mm ²	0.5...25	
Flexible with ferrule	mm ²	0.5...16	
Ferrule with plastic collar	mm ²	0.5...16	
Stripping length	mm	18	
Screwdriver blade	mm	0.8 x 4.0	
According to norm			
Tightening torque range			
Rated current, max.	A	101	90.2
At ambient temperature		20°C	40°C
For conductor cross-section			
Overtoltage category		III	III II
Pollution severity		3	2 2
Rated voltage	V	1000	1000 1000
Rated impulse voltage	kV	8	8 8
UL / CUL (Use Group)	B C D		
Rated voltage	V	600	600 600
Rated current	A	53	53 5
AWG conductor	AWG		18-4
CSA (Use Group)	B C D		
Rated voltage	V	600	600 600
Rated current	A	53	53 5
AWG conductor	AWG		18-4
General data			
Type of insulation material		Wemid (PA)	
UL 94 flammability rating		V-0	
Contact base material			
Material of contact surface			
Pin dimensions = d	mm	1.2, Octagonal	
Solder eyelet Ø = D	mm	1.6	
Solder eyelet Ø tolerance	mm	+ 0,1	

Product data

IEC: 1000 V / 101 A / 0.5 - 25 mm²
 UL: 600 V / 53 A / AWG 18 - 4



For additional articles and information, refer to catalog.weidmueller.com

Note:

- Additional colours on request
- Rated current related to rated cross-section & min. No. of poles.
- Wire end ferrule without plastic collar to DIN 46228/1
- Wire end ferrule with plastic collar to DIN 46228/4
- P on drawing = pitch
- Rated data refer only to the component itself. Clearance and creepage distances to other components are to be designed in accordance with the relevant application standards.
- The test point can only be used as potential-pickup point.
- The single-position PCB terminal block can be used for voltages up to 1500 V (DC) and 1000 V (AC). The relevant device standard and the appropriate required clearances and creepage distances should be observed in the application
- Long term storage of the product with average temperature of 50 °C and average humidity 70%, 36 months

LUF5 10.00/./90V



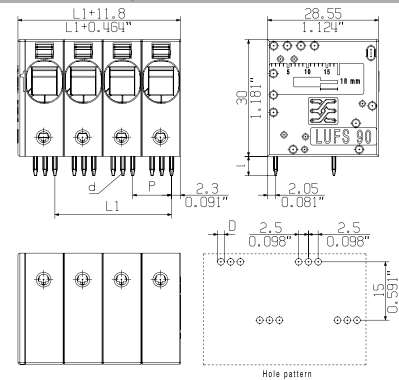

Dimensioned drawing



Accessories

Note: Refer to the Accessories chapter for additional accessories.

Screwdriver		Order No.
	SDIS 0.8X4.0X100	2749820000
	SDS 0.8X4.0X100	2749360000
Test plug		
	PS 2.0 MC	0310000000

Ordering data

Solder pin length		5 mm		
Colour		black		
Pitch		10.00 mm		
Pol.	L1	(inch)	Qty.	Order No.
2	10.00	0.394	40	2499430000
3	20.00	0.787	40	2500460000
4	30.00	1.181	30	2500470000
5	40.00	1.575	25	2500480000
6	50.00	1.969	20	2500490000
7	60.00	2.362	10	2500500000
8	70.00	2.756	10	2500510000
9	80.00	3.150	10	2500520000
10	90.00	3.543	10	2500530000
11	100.00	3.937	10	2500540000
12	110.00	4.331	10	2500550000

Representative deratings curve

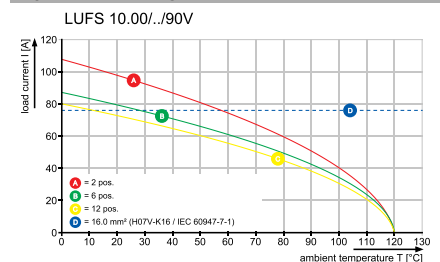

LUFS 10.00../180

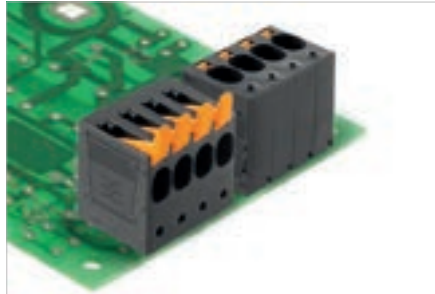

High-performance PCB terminal with PUSH IN connection system for wire cross-sections up to 16 mm².

- Fast connection thanks to a pusher for opening the contact point, or direct insertion
- Securely closed contact point: with the "Connection Safety Concept" the conductor is always clamped securely
- Integrated test point for test plug PS 2.0
- Increased derating reserves through the use of WEMID insulating material
- Wire outlet direction and activation in 180° version

Technical data

In compliance with IEC 60664-1 / IEC 61984

Clamping range, max.	mm ²	0.5...16
Solid core H05(07) V-U	mm²	0.5...16
Stranded H07 V-R	mm ²	6...16
Flexible H05(07) V-K	mm ²	0.5...16
Flexible with ferrule	mm ²	0.5...16
Ferrule with plastic collar	mm ²	0.5...16
Stripping length	mm	18
Screwdriver blade	mm	0.8 x 4.0

According to norm

Tightening torque range			
Rated current, max.	A	76	76
At ambient temperature		20°C	40°C

For conductor cross-section			
Overvoltage category		III	III
Pollution severity		3	2
		2	2

Rated voltage	V	1000	1000	1000
Rated impulse voltage	kV	8	8	8

UL / CUL (Use Group)

Rated voltage	V	600	600	600
Rated current	A	57	57	5
AWG conductor	AWG	18-4		

CSA (Use Group)

Rated voltage	V	600	600	600
Rated current	A	57	57	5
AWG conductor	AWG	18-4		

General data

Type of insulation material		Wemid (PA)
UL 94 flammability rating		V-0
Contact base material		
Material of contact surface		
Pin dimensions = d	mm	1.2, Octagonal
Solder eyelet Ø = D	mm	1.6
Solder eyelet Ø tolerance	mm	+ 0,1

Product data

IEC: 1000 V / 76 A / 0.5 - 16 mm²
 UL: 600 V / 57 A / AWG 18 - 4



For additional articles and information, refer to catalog.weidmueller.com

Note:

- Additional colours on request
- Rated current related to rated cross-section & min. No. of poles.
- Wire end ferrule without plastic collar to DIN 46228/1
- Wire end ferrule with plastic collar to DIN 46228/4
- P on drawing = pitch
- Rated data refer only to the component itself. Clearance and creepage distances to other components are to be designed in accordance with the relevant application standards.
- The test point can only be used as potential-pickup point.
- The single-position PCB terminal block can be used for voltages up to 1500 V (DC) and 1000 V (AC). The relevant device standard and the appropriate required clearances and creepage distances should be observed in the application
- Long term storage of the product with average temperature of 50 °C and average humidity 70%, 36 months

LUFS 10.00../180



Dimensioned drawing

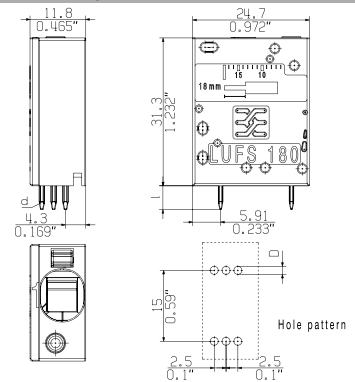

Accessories

Note: Refer to the Accessories chapter for additional accessories.

Screwdriver		Order No.
	SDIS 0.8X4.0X100	2749820000
	SDS 0.8X4.0X100	2749360000
Test plug		
	PS 2.0 MC	0310000000

Ordering data

Solder pin length	5 mm			
Colour	black			
Pitch	10.00 mm			
Pol.	L1	(inch)	Qty.	Order No.
1	0.00	0.000	50	2491810000

Representative deratings curve

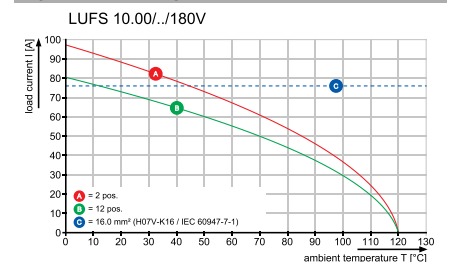

LUFS 10.00../180V



High-performance PCB terminal with PUSH IN connection system for wire cross-sections up to 16 mm².

- Fast connection thanks to a pusher for opening the contact point, or direct insertion
- Securely closed contact point: with the "Connection Safety Concept" the conductor is always clamped securely
- Integrated test point for test plug PS 2.0
- Increased derating reserves through the use of WEMID insulating material
- Wire outlet direction and activation in 180° version

Technical data

In compliance with IEC 60664-1 / IEC 61984			
Clamping range, max.	mm ²	0.5...16	
Solid core H05(07) V-U	mm²	0.5...16	
Stranded H07 V-R	mm ²	6...25	
Flexible H05(07) V-K	mm ²	0.5...25	
Flexible with ferrule	mm ²	0.5...16	
Ferrule with plastic collar	mm ²	0.5...16	
Stripping length	mm	18	
Screwdriver blade	mm	0.8 x 4.0	
According to norm			
Tightening torque range			
Rated current, max.	A	101	101
At ambient temperature		20°C	40°C
For conductor cross-section			
Overtoltage category		III	III II
Pollution severity		3	2 2
Rated voltage	V	1000	1000 1000
Rated impulse voltage	kV	8	8 6
UL / CUL (Use Group)	B C D		
Rated voltage	V	600	600 600
Rated current	A	57	57 5
AWG conductor	AWG	18-4	
CSA (Use Group)	B C D		
Rated voltage	V	600	600 600
Rated current	A	57	57 5
AWG conductor	AWG	18-4	
General data			
Type of insulation material		Wemid (PA)	
UL 94 flammability rating		V-0	
Contact base material		tinned	
Material of contact surface		tinned	
Pin dimensions = d	mm	1.2, Octagonal	
Solder eyelet Ø = D	mm	1.6	
Solder eyelet Ø tolerance	mm	+ 0,1	

Product data

IEC: 1000 V / 101 A / 0.5 - 25 mm²
 UL: 600 V / 57 A / AWG 18 - 4



For additional articles and information, refer to catalog.weidmueller.com

Note:

- Additional colours on request
- Rated current related to rated cross-section & min. No. of poles.
- Wire end ferrule without plastic collar to DIN 46228/1
- Wire end ferrule with plastic collar to DIN 46228/4
- P on drawing = pitch
- Rated data refer only to the component itself. Clearance and creepage distances to other components are to be designed in accordance with the relevant application standards.
- The test point can only be used as potential-pickup point.
- The single-position PCB terminal block can be used for voltages up to 1500 V (DC) and 1000 V (AC). The relevant device standard and the appropriate required clearances and creepage distances should be observed in the application
- Long term storage of the product with average temperature of 50 °C and average humidity 70%, 36 months

LUFS 10.00../180V



Dimensioned drawing

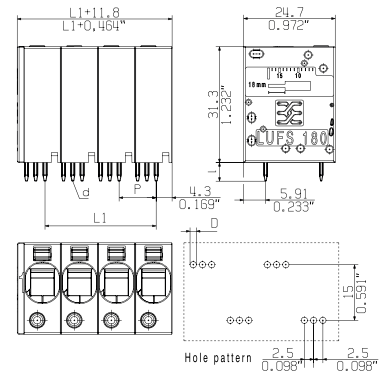

Accessories

Note: Refer to the Accessories chapter for additional accessories.

Screwdriver		Order No.
	SDIS 0.8X4.0X100	2749820000
	SDS 0.8X4.0X100	2749360000
Test plug		
	PS 2.0 MC	0310000000

Ordering data

Solder pin length		5 mm		
Colour		black		
Pitch		10.00 mm		
Pol.	L1	(inch)	Qty.	Order No.
2	10.00	0.394	40	2492110000
3	20.00	0.787	40	2492120000
4	30.00	1.181	30	2492130000
5	40.00	1.575	25	2492140000
6	50.00	1.969	20	2492150000
7	60.00	2.362	10	2492160000
8	70.00	2.756	10	2492170000
9	80.00	3.150	10	2492180000
10	90.00	3.543	10	2492190000
11	100.00	3.937	10	2492200000
12	110.00	4.331	10	2492210000

Representative deratings curve

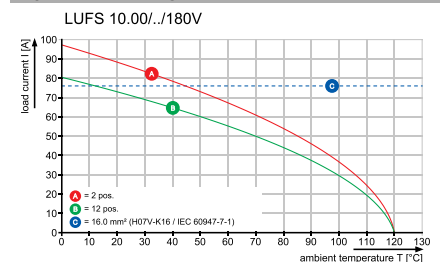

LUF 15.00/./../90

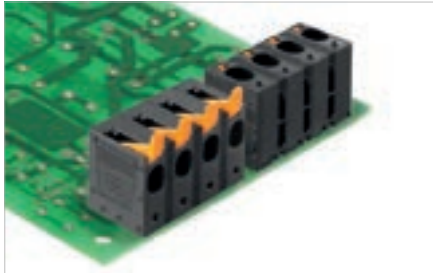

High-performance PCB terminal with PUSH IN connection system for wire cross-sections up to 16 mm² in 15.00 mm pitch

- Fast connection thanks to a pusher for opening the contact point, or direct insertion
- Securely closed contact point, with the "Connection Safety Concept" the conductor is always clamped securely
- Integrated test point for test plug PS 2.0
- Central tip test point for test probes on the upper side of the terminal
- Increased derating reserves through the use of WEMID insulating material
- Wire outlet direction and activation in 90° version

Technical data

In compliance with IEC 60664-1 / IEC 61984			
Clamping range, max.	mm ²	0.5...16	
Solid core H05(07) V-U	mm²	0.5...16	
Stranded H07 V-R	mm ²	10...25	
Flexible H05(07) V-K	mm ²	0.5...25	
Flexible with ferrule	mm ²	0.5...16	
Ferrule with plastic collar	mm ²	0.5...16	
Stripping length	mm	18	
Screwdriver blade	mm	0.8 x 4.0	
According to norm			
Tightening torque range			
Rated current, max.	A	101	101
At ambient temperature		20°C	40°C
For conductor cross-section			
Overtoltage category		III	III II
Pollution severity		3	2 2
Rated voltage	V	1000	1000 1000
Rated impulse voltage	kV	8	8 8
UL / CUL (Use Group)			
Rated voltage	V	600	600 600
Rated current	A	61	61 5
AWG conductor	AWG	18-6	
CSA (Use Group)			
Rated voltage	V	600	600 600
Rated current	A	61	61 5
AWG conductor	AWG	18-6	
General data			
Type of insulation material		Wemid (PA)	
UL 94 flammability rating		V-0	
Contact base material		E-Cu	
Material of contact surface			
Pin dimensions = d	mm	1.2, Octagonal	
Solder eyelet Ø = D	mm	1.7	
Solder eyelet Ø tolerance	mm	+ 0,1	

Product data

IEC: 1000 V / 101 A / 0.5 - 25 mm²
 UL: 600 V / 61 A / AWG 18 - 6



For additional articles and information, refer to catalog.weidmueller.com

Note:

- Additional colours on request
- Rated current related to rated cross-section & min. No. of poles.
- Wire end ferrule without plastic collar to DIN 46228/1
- Wire end ferrule with plastic collar to DIN 46228/4
- P on drawing = pitch
- Rated data refer only to the component itself. Clearance and creepage distances to other components are to be designed in accordance with the relevant application standards.
- The test point can only be used as potential-pickup point.
- The single-position PCB terminal block can be used for voltages up to 1500 V (DC) and 1000 V (AC). The relevant device standard and the appropriate required clearances and creepage distances should be observed in the application
- Long term storage of the product with average temperature of 50 °C and average humidity 70%, 36 months

LUF 15.00/./../90



Dimensioned drawing

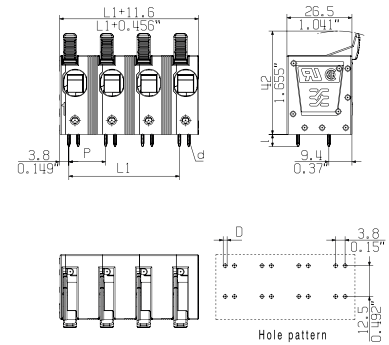

Ordering data

Solder pin length		5 mm		
Colour		black		
Pitch		15.00 mm		
Pol.	L1	(inch)	Qty.	Order No.
2	15.00	0.590	40	2491800000
3	30.00	1.181	30	2491900000
4	45.00	1.772	25	2491910000
5	60.00	2.362	20	2491920000
6	75.00	2.953	10	2491930000
7	90.00	3.543	10	2491940000
8	105.00	4.134	10	2491950000

Accessories

Note: Refer to the Accessories chapter for additional accessories.

Screwdriver		Order No.
	SDIS 0.8X4.0X100	2749820000
	SDS 0.8X4.0X100	2749360000
Test plug		
	PS 2.0 MC	0310000000

Representative deratings curve

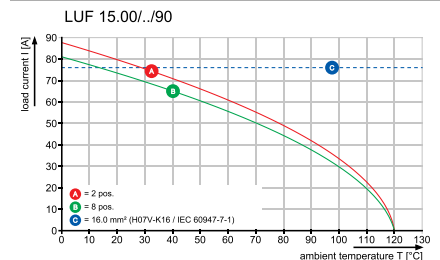

LUF 15.00/.. /90V

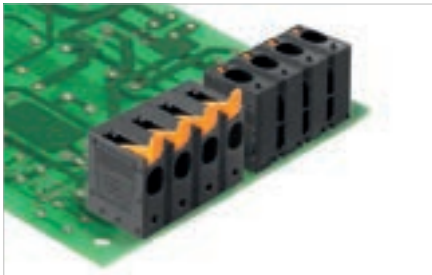

High-performance PCB terminal with PUSH IN connection system for wire cross-sections up to 16 mm² in 15.00 mm pitch

- Fast connection without tools thanks to an operating lever for opening the contact point, or direct insertion
- Securely closed contact point, with the "Connection Safety Concept" the conductor is always clamped securely
- Integrated test point for test plug PS 2.0
- Central tip test point for test probes on the upper side of the terminal
- Increased derating reserves through the use of WEMID insulating material
- Wire outlet direction: 90° version

Technical data

In compliance with IEC 60664-1 / IEC 61984			
Clamping range, max.	mm ²	0.5...16	
Solid core H05(07) V-U	mm²	0.5...16	
Stranded H07 V-R	mm ²	10...25	
Flexible H05(07) V-K	mm ²	0.5...25	
Flexible with ferrule	mm ²	0.5...16	
Ferrule with plastic collar	mm ²	0.5...16	
Stripping length	mm	18	
Screwdriver blade	mm	0.8 x 4.0	
According to norm			
Tightening torque range			
Rated current, max.	A	101	95.3
At ambient temperature		20°C	40°C
For conductor cross-section			
Overtoltage category		III	III II
Pollution severity		3	2 2
Rated voltage	V	1000	1000 1000
Rated impulse voltage	kV	8	8 8
UL / CUL (Use Group)		B	C D
Rated voltage	V	600	600 600
Rated current	A	58	58 5
AWG conductor	AWG	18-6	
CSA (Use Group)		B	C D
Rated voltage	V	600	600 600
Rated current	A	58	58 5
AWG conductor	AWG	18-6	
General data			
Type of insulation material		Wemid (PA)	
UL 94 flammability rating		V-0	
Contact base material		E-Cu	
Material of contact surface			
Pin dimensions = d	mm	1.2, Octagonal	
Solder eyelet Ø = D	mm	1.7	
Solder eyelet Ø tolerance	mm	+ 0,1	

Product data

IEC: 1000 V / 101 A / 0.5 - 25 mm²
 UL: 600 V / 58 A / AWG 18 - 6



For additional articles and information, refer to catalog.weidmuller.com

Note:

- Additional colours on request
- Rated current related to rated cross-section & min. No. of poles.
- Wire end ferrule without plastic collar to DIN 46228/1
- Wire end ferrule with plastic collar to DIN 46228/4
- P on drawing = pitch
- Rated data refer only to the component itself. Clearance and creepage distances to other components are to be designed in accordance with the relevant application standards.
- The test point can only be used as potential-pickup point.
- The single-position PCB terminal block can be used for voltages up to 1500 V (DC) and 1000 V (AC). The relevant device standard and the appropriate required clearances and creepage distances should be observed in the application
- Long term storage of the product with average temperature of 50 °C and average humidity 70%, 36 months

LUF 15.00/.. /90V



Dimensioned drawing

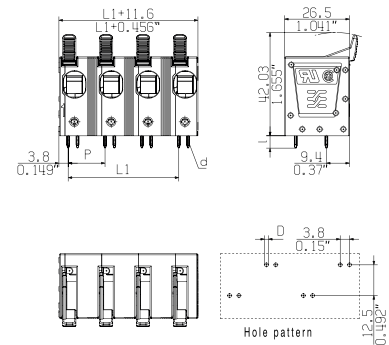

Accessories

Note: Refer to the Accessories chapter for additional accessories.

Screwdriver		Order No.
	SDIS 0.8X4.0X100	2749820000
	SDS 0.8X4.0X100	2749360000
Test plug		
	PS 2.0 MC	0310000000

Ordering data

Solder pin length		5 mm		
Colour		black		
Pitch		15.00 mm		
Pol.	L1	(inch)	Qty.	Order No.
2	15.00	0.590	40	2492000000
3	30.00	1.181	30	2492010000
4	45.00	1.772	25	2492020000
5	60.00	2.362	20	2492030000
6	75.00	2.953	10	2492040000
7	90.00	3.543	10	2492050000
8	105.00	4.134	10	2492060000

Representative deratings curve

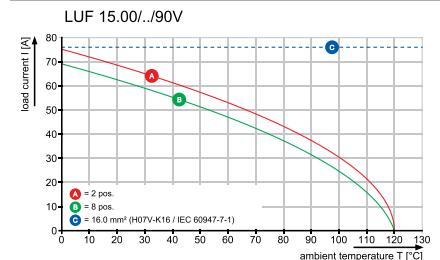

LUFS 15.00/./90V

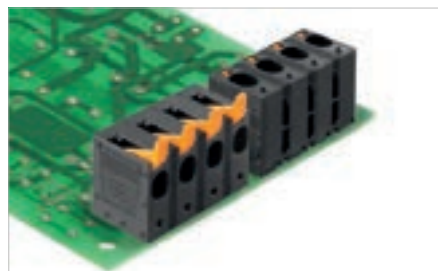

High-performance PCB terminal with PUSH IN connection system for wire cross-sections up to 16 mm² in 15.00 mm pitch

- Fast connection thanks to a pusher for opening the contact point, or direct insertion
- Securely closed contact point, with the "Connection Safety Concept" the conductor is always clamped securely
- Integrated test point for test plug PS 2.0
- Central tip test point for test probes on the upper side of the terminal
- Increased derating reserves through the use of WEMID insulating material
- Wire outlet direction and activation in 90° version

Technical data

In compliance with IEC 60664-1 / IEC 61984			
Clamping range, max.	mm ²	0.5...16	
Solid core H05(07) V-U	mm²	0.5...16	
Stranded H07 V-R	mm ²	10...25	
Flexible H05(07) V-K	mm ²	0.5...25	
Flexible with ferrule	mm ²	0.5...16	
Ferrule with plastic collar	mm ²	0.5...16	
Stripping length	mm	18	
Screwdriver blade	mm	0.8 x 4.0	
According to norm			
Tightening torque range			
Rated current, max.	A	101	76
At ambient temperature		20°C	40°C
For conductor cross-section			
Overtoltage category		III	III II
Pollution severity		3	2 2
Rated voltage	V	1000	1000 1000
Rated impulse voltage	kV	8	8 6
UL / CUL (Use Group)			
Rated voltage	V	600	600 600
Rated current	A	53	53 5
AWG conductor	AWG	18-4	
CSA (Use Group)			
Rated voltage	V	600	600 600
Rated current	A	53	53 5
AWG conductor	AWG	18-4	
General data			
Type of insulation material		Wemid (PA)	
UL 94 flammability rating		V-0	
Contact base material		E-Cu	
Material of contact surface			
Pin dimensions = d	mm	1.2, Octagonal	
Solder eyelet Ø = D	mm	1.7	
Solder eyelet Ø tolerance	mm	+ 0,1	

Product data

IEC: 1000 V / 101 A / 0.5 - 25 mm²
 UL: 600 V / 53 A / AWG 18 - 4



For additional articles and information, refer to catalog.weidmueller.com

Note:

- Additional colours on request
- Rated current related to rated cross-section & min. No. of poles.
- Wire end ferrule without plastic collar to DIN 46228/1
- Wire end ferrule with plastic collar to DIN 46228/4
- P on drawing = pitch
- Rated data refer only to the component itself. Clearance and creepage distances to other components are to be designed in accordance with the relevant application standards.
- The test point can only be used as potential-pickup point.
- The single-position PCB terminal block can be used for voltages up to 1500 V (DC) and 1000 V (AC). The relevant device standard and the appropriate required clearances and creepage distances should be observed in the application
- Long term storage of the product with average temperature of 50 °C and average humidity 70%, 36 months

LUFS 15.00/./90V



Dimensioned drawing

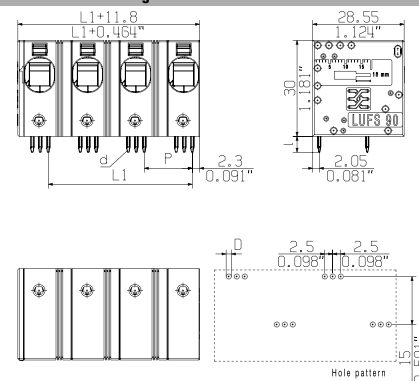

Ordering data

Solder pin length		5 mm		
Colour		black		
Pitch		15.00 mm		
Pol.	L1	(inch)	Qty.	Order No.
2	15.00	0.590	40	2499440000
3	30.00	1.181	30	2500570000
4	45.00	1.772	25	2500580000
5	60.00	2.362	20	2500590000
6	75.00	2.953	10	2500660000
7	90.00	3.543	10	2500600000
8	105.00	4.134	10	2500610000

Representative deratings curve

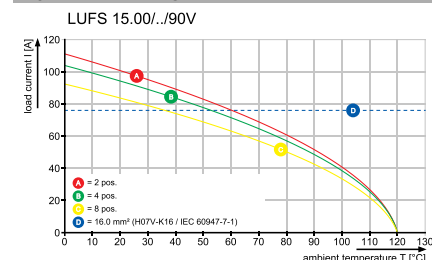

LUF5 15.00/./180V

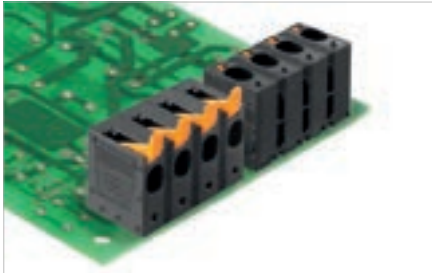

High-performance PCB terminal with PUSH IN connection system for wire cross-sections up to 16 mm² in 15.00 mm pitch

- Fast connection thanks to a pusher for opening the contact point, or direct insertion
- Securely closed contact point: with the "Connection Safety Concept" the conductor is always clamped securely
- Integrated test point for test plug PS 2.0
- Increased derating reserves through the use of WEMID insulating material
- Wire outlet direction and activation in 180° version

Technical data

In compliance with IEC 60664-1 / IEC 61984			
Clamping range, max.	mm ²	0.5...16	
Solid core H05(07) V-U	mm²	0.5...16	
Stranded H07 V-R	mm ²	10...25	
Flexible H05(07) V-K	mm ²	0.5...25	
Flexible with ferrule	mm ²	0.5...16	
Ferrule with plastic collar	mm ²	0.5...16	
Stripping length	mm	18	
Screwdriver blade	mm	0.8 x 4.0	
According to norm			
Tightening torque range			
Rated current, max.	A	101	94.5
At ambient temperature		20°C	40°C
For conductor cross-section			
Overtoltage category		III	III II
Pollution severity		3	2 2
Rated voltage	V	1000	1000 1000
Rated impulse voltage	kV	8	8 6
UL / CUL (Use Group)		B	C D
Rated voltage	V	600	600 600
Rated current	A	57	57 5
AWG conductor	AWG		18-4
CSA (Use Group)		B	C D
Rated voltage	V	600	600 600
Rated current	A	57	57 5
AWG conductor	AWG		18-4
General data			
Type of insulation material		Wemid (PA)	
UL 94 flammability rating		V-0	
Contact base material		E-Cu	
Material of contact surface			
Pin dimensions = d	mm	1.2, Octagonal	
Solder eyelet Ø = D	mm	1.7	
Solder eyelet Ø tolerance	mm	+ 0,1	

Product data

IEC: 1000 V / 101 A / 0.5 - 25 mm²
 UL: 600 V / 57 A / AWG 18 - 4



For additional articles and information, refer to catalog.weidmueller.com

Note:

- Additional colours on request
- Rated current related to rated cross-section & min. No. of poles.
- Wire end ferrule without plastic collar to DIN 46228/1
- Wire end ferrule with plastic collar to DIN 46228/4
- P on drawing = pitch
- Rated data refer only to the component itself. Clearance and creepage distances to other components are to be designed in accordance with the relevant application standards.
- The test point can only be used as potential-pickup point.
- The single-position PCB terminal block can be used for voltages up to 1500 V (DC) and 1000 V (AC). The relevant device standard and the appropriate required clearances and creepage distances should be observed in the application
- Long term storage of the product with average temperature of 50 °C and average humidity 70%, 36 months

LUF5 15.00/./180V



Dimensioned drawing

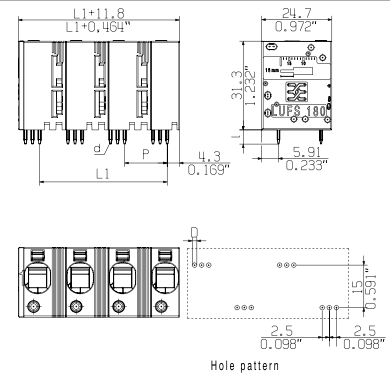

Accessories

Note: Refer to the Accessories chapter for additional accessories.

Screwdriver		Order No.
	SDIS 0.8X4.0X100	2749820000
	SDS 0.8X4.0X100	2749360000
Test plug		
	PS 2.0 MC	0310000000

Ordering data

Solder pin length		5 mm		
Colour		black		
Pitch		15.00 mm		
Pol.	L1	(inch)	Qty.	Order No.
2	15.00	0.590	40	2491820000
3	30.00	1.181	30	2492220000
4	45.00	1.772	25	2492230000
5	60.00	2.362	20	2492240000
6	75.00	2.953	10	2492250000
7	90.00	3.543	10	2492260000
8	105.00	4.134	10	2492270000

Representative deratings curve

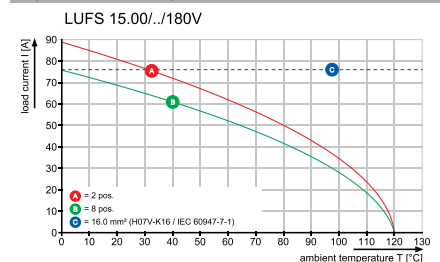

OMNIMATE® Power PCB connectors

**OMNIMATE® Power
PCB connectors**

OMNIMATE® Power	Explanation	P.2
<hr/>		
OMNIMATE® Power Hybrid	Explanation	P.4
	Quick selection	P.8
	Product selection	P.10
<hr/>		
OMNIMATE® Power IT	Explanation	P.54
	Quick selection	P.60
	Product selection	P.64
<hr/>		
OMNIMATE® Power HP to 2.5 mm ² / 24 A	Explanation	P.112
	Quick selection	P.116
	Product selection	P.118
<hr/>		
OMNIMATE® Power HP to 6 mm ² / 41 A	Explanation	P.138
	Quick selection	P.148
	Product selection	P.150
<hr/>		
OMNIMATE® Power HP 16 mm ² / 76 A	Explanation	P.212
	Quick selection	P.218
	Product selection	P.220
<hr/>		

OMNIMATE® Power on BOARD

Integrated connection systems delivering innovative drive applications

The OMNIMATE® Power system excels in power electronics and drive applications because it has implemented and incorporated customer and market requirements.

Custom-fit connection solutions for power electronics – resulting from the synergy between application-oriented components, individual services and competent design-in support.

The following pages show why OMNIMATE® Power is the ideal system for power electronics and drive applications. This system has benefited from our broader perspective of component directives and our consistent implementation of requests from the market and customers.

Performance + Innovation

Designed with future requirements in mind whether for cars or servo-drives: hybrid design concepts create an efficient solution from two distinct elements.

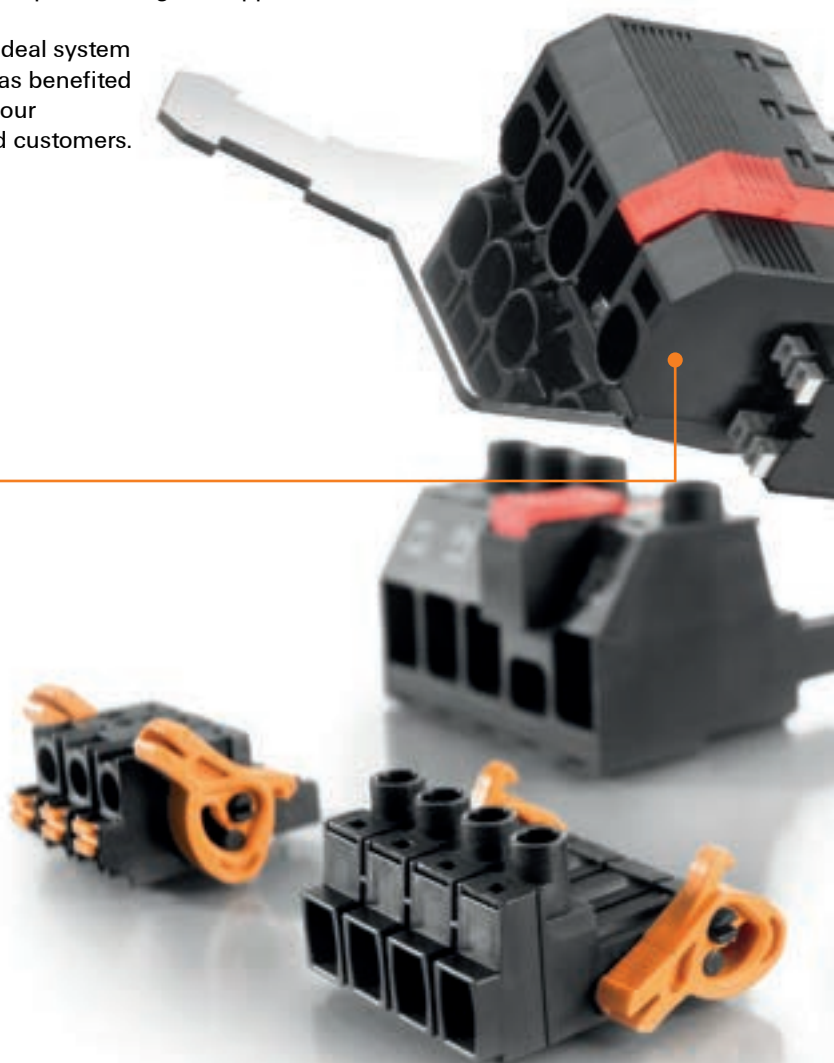

Performance + Support

Weidmüller delivers more than just components. Our design-in competence encompassing work from design and implementation to the market release phase delivers the top results.

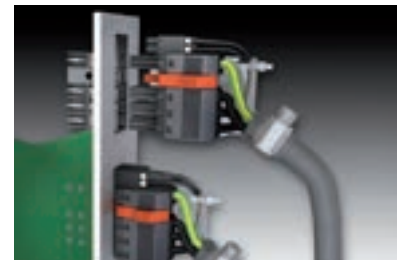
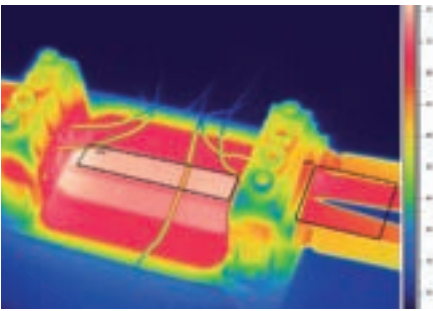

An overview of OMNIMATE® Power

The single-source solution that omits no necessary components a result of Weidmüller's technology and application expertise delivers the optimal designed-in results. The following pages describe the individual product lines in detail.



Performance + Services

Customised services supplement our comprehensive standard portfolio. The housing colour, printing, coding, contact surfaces, packaging and much more can be configured online with just a few mouse clicks.

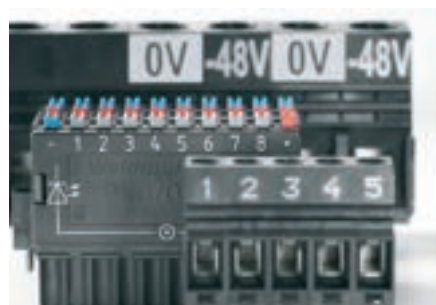

OMNIMATE® Power BV/SV 7.62HP Hybrid – for power, signals and EMC

Three functions in one!

The OMNIMATE® Power Hybrid connector provides developers and users with the perfect three-in-one solution.

The hybrid motor connector can simultaneously connect power, signals and a pluggable EMC shield. This allows you to save space on the circuit board, on the outside of the housing and in the electrical cabinet. The self-locking one-handed interlock mechanism requires only one plugging step and thus speeds up installation and maintenance procedures. It is easy to handle and interlocks automatically – even in difficult installation positions. The unique shielding shape with 30° cable entry enables a space savings of up to 10 cm between rows.

Unique safety

Safe, EMC-compliant shield connection for any application situation and with no risk of error.



Unique integration

Three-in-one solution: pluggable shield support, integrated signal contacts, and one-handed security flange.



Unique component density

Higher packaging density and more space in the housing wall and on the printed-circuit board due to as much as 38 % space savings in the construction width.

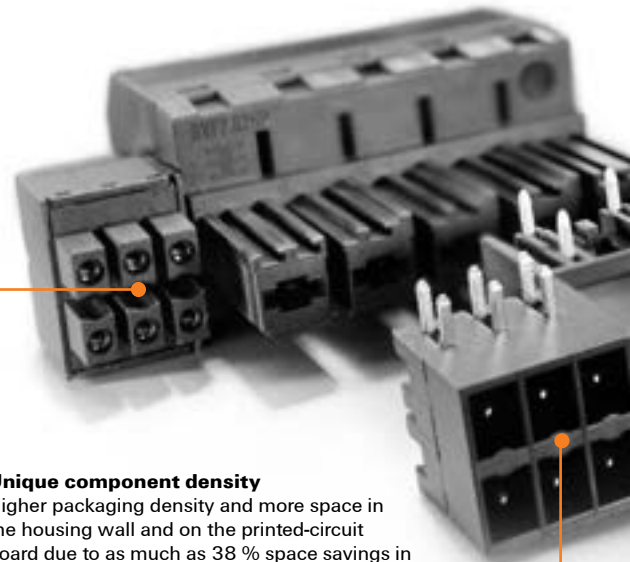
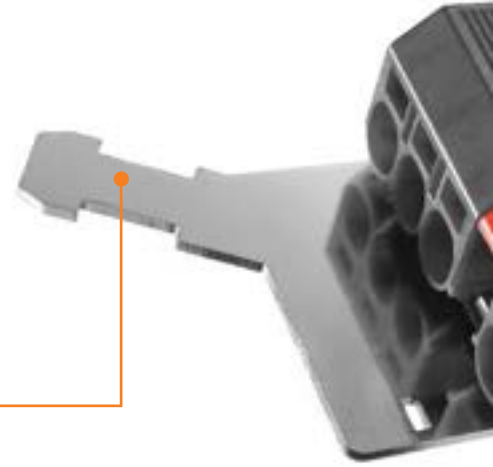

Unique interaction

Plug & Work with intuitive handling: featuring tool-free one-handed operation with automatic snap-in and also “blind” plugging of power, signals and shielding simultaneously.

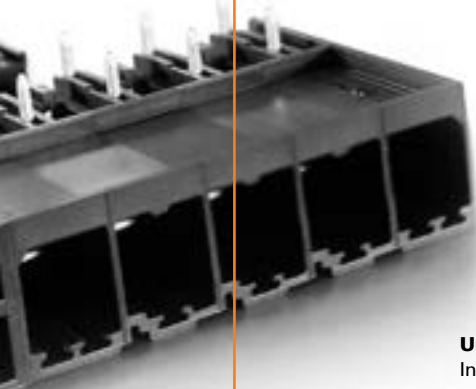
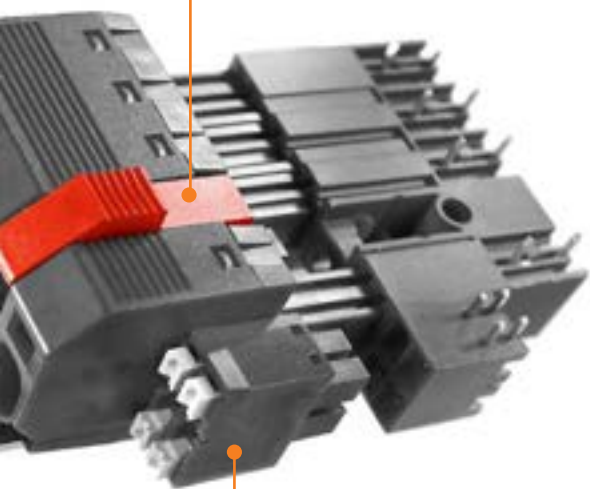

Unique innovation

Integrating functions, optimising processes, and reducing complexity: The conventional 2 outer flanges have simply been replaced by 1 middle flange, 4 signal contacts and 1 pluggable shield support.

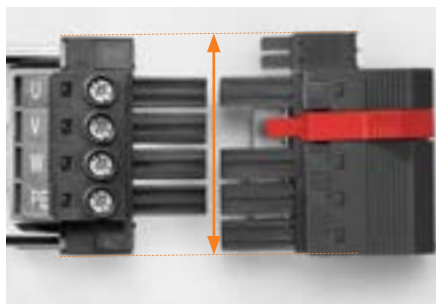

EMC in theory and in the real world

The motor feedback (signal feedback from temperature/encoder) in hybrid, shield-within-shield motor cables is usually made from over-sized power contacts or from disconnected I/O connectors. It also normally requires two separate shield connections. During installation and repairs (replacement), it is possible that the shield terminals could be incorrectly connected, left disconnected or lost. With conventional shielding, it can be quite difficult to tighten the flange screws when the connection is located at a difficult to reach location. So this step is often neglected in the real world.



Reliably avoiding interferences

As a result, malfunctions can then be caused by the coupling of electromagnetic fields within the sensitive electronics. The pluggable, hybrid shield support features a special EMC spring-contact strip which ensures that the shield connection to the housing is permanent, vibration-proof and covers a large surface area. It allows the shielding braid from the power and signal wires to be connected separately – and enables this to be done automatically in one step so that it is not dependent on the user.

Topology of parasitic currents

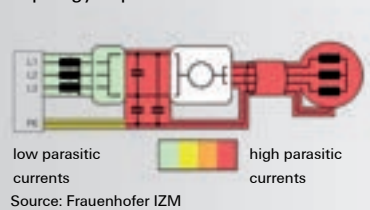

OMNIMATE® Power BVF SH

Contact EMC shielding plate for devices with plastic enclosures

P

For many drive technology devices, reliable contact with the EMC shielding is necessary to avoid EMC-related interference in the system. For devices with a plastic housing in the front area, the shield support is considerably more difficult to contact.

The new OMNIMATE connector BVF 7.62 Hybrid with PUSH IN connection has a pluggable shielding plate with a special EMC spring contact strip. It enables large-area, durable, and vibration-proof shield connection to the device. During the connection process, the connector attaches directly to a contact surface on the PCB. As a result, a reliable EMC cable shielding is implemented for devices with plastic enclosures.

Your special advantages:

- Hybrid connector with PUSH IN connection and pluggable shielding
- Current rating up to 38 A (IEC) / 35 A (UL)
- Pitch 7,62 mm / 3,81 mm
- Shielding contacts directly to a contact surface on the circuit board
- Secure fixing by central screw block

Avoid EMC problems

The integrated EMC shielding, when plugged in, attaches directly to a contact surface on the circuit board. Complex arrangements for cable screens on the device housing are unnecessary.



Easy device integration

Versions with straight or angled cable shield outlet at the connector allow variable integration. The screwable central flange lock ensures a secure and durable attachment to the device.





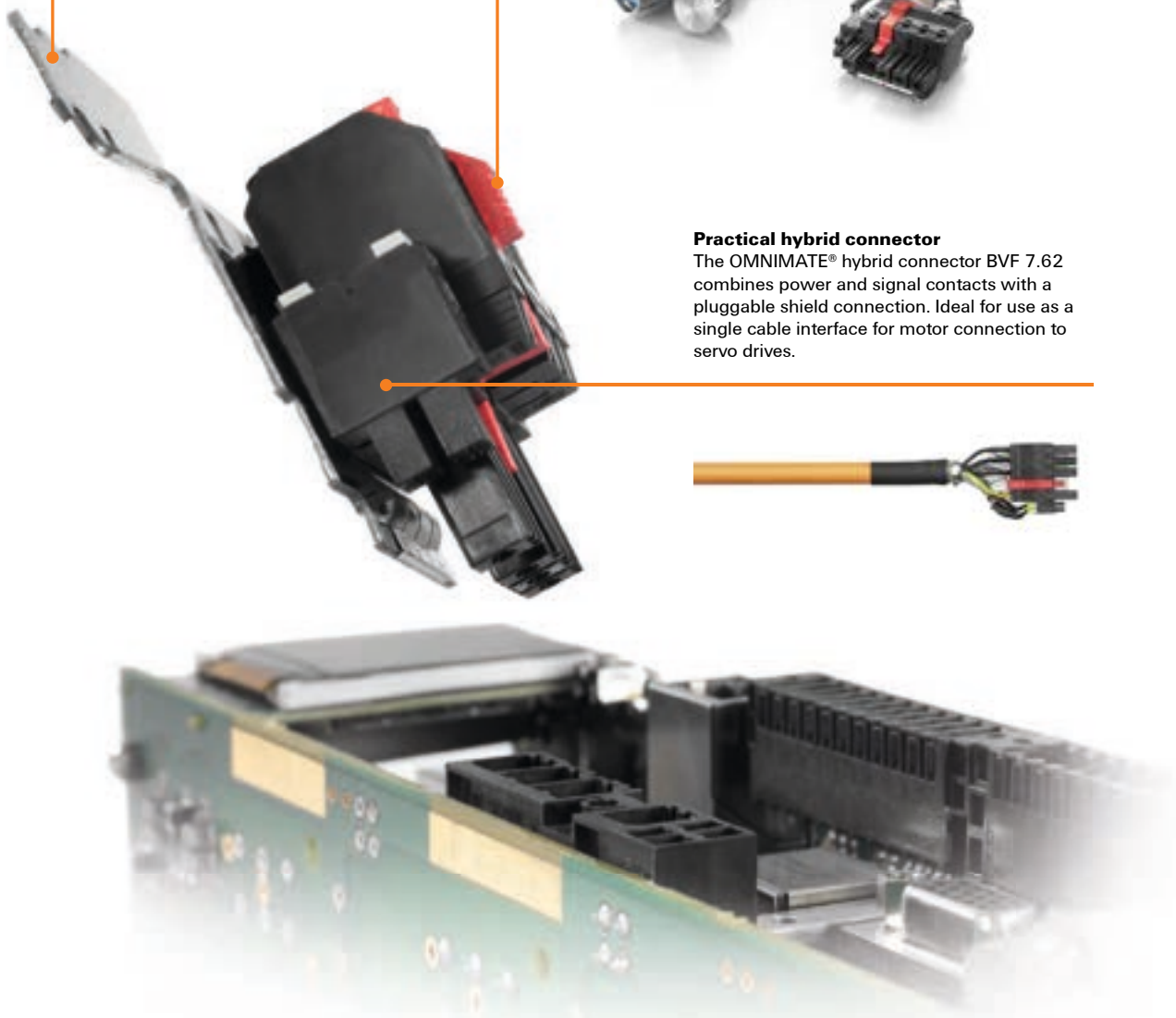

Practical hybrid connector

The OMNIMATE® hybrid connector BVF 7.62 combines power and signal contacts with a pluggable shield connection. Ideal for use as a single cable interface for motor connection to servo drives.



<http://www.OMNIMATE.net>

-  = Wire-to-Board
-  = Board-to-Board
-  = Wire-to-Wire
-  = Board-to-Wire

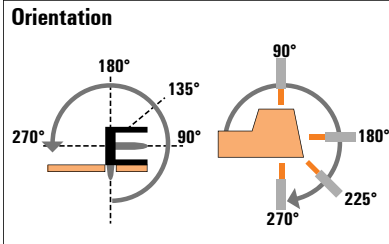
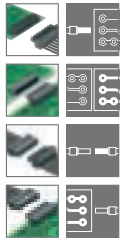

Hybrid pin header

Hybrid pin header

Solder connection



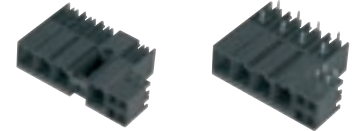

Solder connection



BV/SV 7.62 series



Type	SV-SMT & SC 3.81	SV & SC 3.81
Orientation	90° / 270°	90° / 270°
Flange options	G/MF/MSF	G/MF/MSF
Product code numbers	IEC: 1000V / 41A UL: 300V / 35A	IEC: 1000V / 41A UL: 200V / 35A

Hybrid female connector	PUSH IN	Type		SV-SMT & SC 3.81		SV & SC 3.81			
		Product code numbers	Flange options	Product code numbers	Flange options	Product code numbers	Flange options		
Hybrid female connector	PUSH IN		BVFL & BC 3.81	180° (G)/MF/MSF	IEC: 1000V / 41A / 0.2-10mm ² UL: 600V / 35A / AWG 24-8	<input type="radio"/>	<input type="radio"/>	<input type="radio"/>	<input type="radio"/>
			BVFL & BC 3.81	180° (G)/MF/MSF	IEC: 1000V / 41A / 0.2-6mm ² UL: 600V / 35A / AWG 24-8	<input type="radio"/>	<input type="radio"/>	<input type="radio"/>	<input type="radio"/>
Hybrid female connector	PUSH IN		BVFL & BC 3.81*	180° (G)/MF/MSF	IEC: 1000V / 41A / 0.2-10mm ² UL: 600V / 35A / AWG 24-8	<input type="radio"/>	<input type="radio"/>	<input type="radio"/>	<input type="radio"/>
			BVFL & BC 3.81*	180° (G)/MF/MSF	IEC: 1000V / 41A / 0.2-6mm ² UL: 600V / 35A / AWG 24-8	<input type="radio"/>	<input type="radio"/>	<input type="radio"/>	<input type="radio"/>

* pluggable shield support as an accessory or fitted in advance by us

- G** = Closed (without flange)
- MF** = Centre flange for clasp
- MSF** = middle flange with screw and latching hook

Connectors in 7.62 mm pitch
Series BV/SV 7.62 - connection up to 6 mm²

SV-SMT../90 & SC 3.81

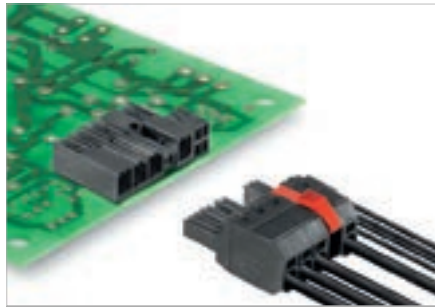

Hybrid male header with 90° outlet direction with power and signal contacts. Fulfills the enhanced requirements for 3 mm of finger safety on 400 V TNC(S) systems in accordance with IEC 61800-5-1 and allows UL approval for 600 V in accordance with UL61800-5-1/UL840. The self-locking middle flange reduces the space requirements by one pitch width in comparison with conventional solutions.

Variants: middle flange and middle screw flange fastening.

The high-temperature-resistant OMNIMATE® Power male header with THR (through-hole reflow) technology, suitable for the SMT process.

Product data

IEC: 1000 V / 41 A
 UL: 300 V / 33 A



For additional articles and information, refer to catalog.weidmuller.com

Note:

- Technical specifications refer to the power contacts
- Technical data of signal contacts: 50V / 5A, stripping length 8mm
- Rated current related to rated cross-section & min. No. of poles.
- Specifications of diagram: P1=7.62 mm; P2=3.81 mm
- Rated data refer only to the component itself. Clearance and creepage distances to other components are to be designed in accordance with the relevant application standards.
- Long term storage of the product with average temperature of 50 °C and average humidity 70%, 36 months

SV-SMT../90 & SC 3.81



Dimensioned drawing

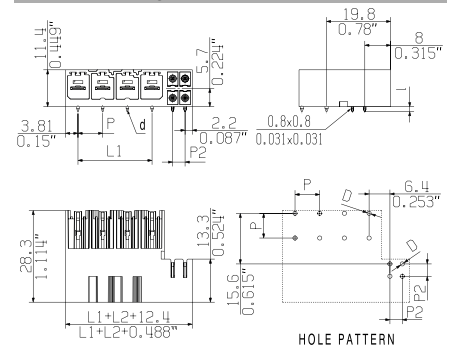

Technical data

In compliance with IEC 60664-1 / IEC 61984

Clamping range, max.			
Solid core H05(07) V-U			
Stranded H07 V-R			
Flexible H05(07) V-K			
Flexible with ferrule			
Ferrule with plastic collar			
Stripping length			
Screwdriver blade	mm		
According to norm			
Tightening torque range			
Rated current, max.	A	41	41
At ambient temperature		20°C	40°C
For conductor cross-section		III	III II
Overtoltage category		3	2 2
Pollution severity		3	2 2
Rated voltage	V	630	630 1000
Rated impulse voltage	kV	6	6 6
UL / CUL (Use Group)		B	C D
Rated voltage	V	300	300 600
Rated current	A	33	33 5
AWG conductor	AWG		-
CSA (Use Group)		B	C D
Rated voltage	V		
Rated current	A		
AWG conductor	AWG		
General data			
Type of insulation material		PA 9T	
UL 94 flammability rating		V-0	
Contact base material		Copper alloy	
Material of contact surface		tinned	
Pin dimensions = d	mm	0.8 x 1.0	
Solder eyelet Ø = D	mm	1.4	
Solder eyelet Ø tolerance	mm	+ 0,1	

Accessories

Note: Refer to the Accessories chapter for additional accessories.

Coding	Order No.
BV/SV 7.62HP K0	1937590000

Ordering data

Solder pin length		2.6 mm				
Colour		black				
Pitch		7.62 mm				
Poles	L1 (inch)	L2 (inch)	Qty.	Order No.		
2 / 4	7.62	0.300	3.81	0.150	78	2528950000
2 / 6	7.62	0.300	11.43	0.450	66	2529030000
2 / 8	7.62	0.300	11.43	0.450	60	2529040000
3 / 4	15.24	0.600	3.81	0.150	60	2529050000
3 / 6	15.24	0.600	11.43	0.450	54	2529060000
3 / 8	15.24	0.600	11.43	0.450	48	2529070000
4 / 4	22.86	0.900	3.81	0.150	48	2529080000
4 / 6	22.86	0.900	11.43	0.450	42	2529090000
4 / 8	22.86	0.900	11.43	0.450	36	2529100000
5 / 4	30.48	1.200	3.81	0.150	36	2529110000
5 / 6	30.48	1.200	11.43	0.450	36	2529120000
5 / 8	30.48	1.200	11.43	0.450	30	2529130000

Connectors in 7.62 mm pitch
Series BV/SV 7.62 - connection up to 6 mm²

SV-SMT../90 & SC 3.81 MF

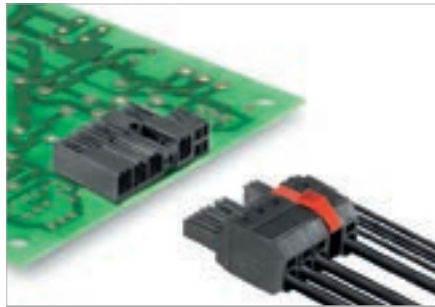

Hybrid male header with 90° outlet direction with power and signal contacts. Fulfills the enhanced requirements for 3 mm of finger safety on 400 V TNC(S) systems in accordance with IEC 61800-5-1 and allows UL approval for 600 V in accordance with UL61800-5-1/UL840. The self-locking middle flange reduces the space requirements by one pitch width in comparison with conventional solutions.

Variants: middle flange and middle screw flange fastening.

The high-temperature-resistant OMNIMATE® Power male header with THR (through-hole reflow) technology, suitable for the SMT process.

Product data

IEC: 1000 V / 41 A
 UL: 300 V / 33 A



For additional articles and information, refer to catalog.weidmueller.com

Note:

- Technical specifications refer to the power contacts
- Technical data of signal contacts: 50V / 5A, stripping length 8mm
- Rated current related to rated cross-section & min. No. of poles.
- Specifications of diagram: P1=7.62 mm; P2=3.81 mm
- Rated data refer only to the component itself. Clearance and creepage distances to other components are to be designed in accordance with the relevant application standards.
- MFX and MSFX: X= Position of the middle flange e.g. MF2, MSF3
- Long term storage of the product with average temperature of 50 °C and average humidity 70%, 36 months

SV-SMT../90 & SC 3.81 MF2



Dimensioned drawing

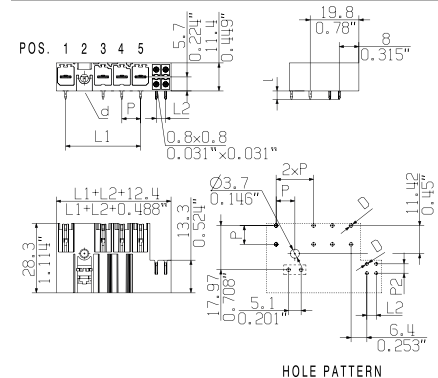

Technical data

In compliance with IEC 60664-1 / IEC 61984

Clamping range, max.			
Solid core H05(07) V-U			
Stranded H07 V-R			
Flexible H05(07) V-K			
Flexible with ferrule			
Ferrule with plastic collar			
Stripping length			
Screwdriver blade	mm		
According to norm			
Tightening torque range			
Rated current, max.	A	41	41
At ambient temperature		20°C	40°C
For conductor cross-section		III	III
Overtoltage category		III	II
Pollution severity		3	2
Rated voltage	V	630	630
Rated impulse voltage	kV	6	6
UL / CUL (Use Group)		B	C
Rated voltage	V	300	300
Rated current	A	33	33
AWG conductor	AWG	-	-
CSA (Use Group)		B	C
Rated voltage	V		
Rated current	A		
AWG conductor	AWG		
General data			
Type of insulation material		PA 9T	
UL 94 flammability rating		V-0	
Contact base material		Copper alloy	
Material of contact surface		tinned	
Pin dimensions = d	mm	0.8 x 1.0	
Solder eyelet Ø = D	mm	1.4	
Solder eyelet Ø tolerance	mm	+ 0,1	

Accessories

Note: Refer to the Accessories chapter for additional accessories.

Coding	Order No.
BV/SV 7.62HP K0	1937590000

Ordering data

Solder pin length		2.6 mm	
Colour		black	
Pitch		7.62 mm	
Poles	L1 (inch)	L2 (inch)	Qty. Order No.
2 / 4	15.24	0.600	3.81 0.150 60 2529000000
2 / 6	15.24	0.600	7.62 0.300 54 2529720000
2 / 8	15.24	0.600	11.43 0.450 48 2529730000
3 / 4	22.86	0.900	3.81 0.150 48 2529740000
3 / 6	22.86	0.900	7.62 0.300 42 2529750000
3 / 8	22.86	0.900	11.43 0.450 36 2529760000
4 / 4	30.48	1.200	3.81 0.150 36 2626800000
4 / 6	30.48	1.200	7.62 0.300 36 2626850000
4 / 8	30.48	1.200	11.43 0.450 30 2626860000
5 / 4	38.10	1.500	3.81 0.150 30 2626870000
5 / 6	38.10	1.500	7.62 0.300 30 2626880000
5 / 8	38.10	1.500	11.43 0.450 24 2626890000

SV-SMT../90 & SC 3.81 MF3



Dimensioned drawing

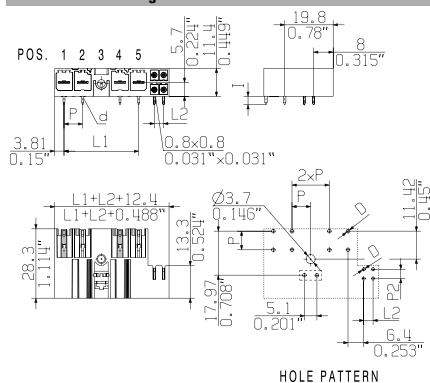

Ordering data

Solder pin length		2.6 mm					
Colour		black					
Pitch		7.62 mm					
Poles	L1 (inch)	L2 (inch)	Qty.	Order No.			
3/4	22.86	0.900	3.81 0.150	48	2529770000		
3/6	22.86	0.900	7.62 0.300	42	2529780000		
3/8	22.86	0.900	11.43 0.450	36	2529790000		
4/4	30.48	1.200	3.81 0.150	36	2626900000		
4/6	30.48	1.200	7.62 0.300	36	2626910000		
4/8	30.48	1.200	11.43 0.450	30	2626920000		
5/4	38.10	1.500	3.81 0.150	30	2529830000		
5/6	38.10	1.500	7.62 0.300	30	2529840000		
5/8	38.10	1.500	11.43 0.450	30	2529850000		

SV-SMT../90 & SC 3.81 MF4



Dimensioned drawing

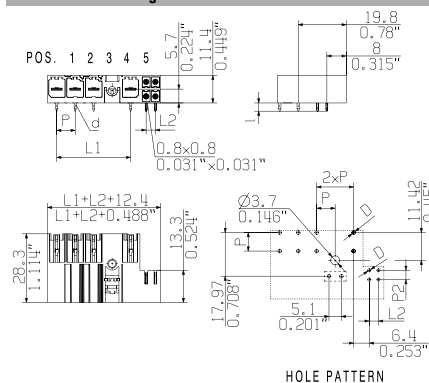

Ordering data

Solder pin length		2.6 mm					
Colour		black					
Pitch		7.62 mm					
Poles	L1 (inch)	L2 (inch)	Qty.	Order No.			
4/4	30.48	1.200	3.81 0.150	36	2529800000		
4/6	30.48	1.200	7.62 0.300	36	2529810000		
4/8	30.48	1.200	11.43 0.450	30	2529820000		
5/4	38.10	1.500	3.81 0.150	30	2529860000		
5/6	38.10	1.500	7.62 0.300	30	2529870000		
5/8	38.10	1.500	11.43 0.450	30	2529880000		

Connectors in 7.62 mm pitch
Series BV/SV 7.62 - connection up to 6 mm²

SV-SMT../90 & SC 3.81 MSF

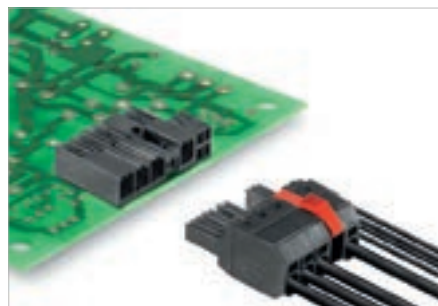

Hybrid male header with 90° outlet direction with power and signal contacts. Fulfills the enhanced requirements for 3 mm of finger safety on 400 V TNC(S) systems in accordance with IEC 61800-5-1 and allows UL approval for 600 V in accordance with UL61800-5-1/UL840. The self-locking middle flange reduces the space requirements by one pitch width in comparison with conventional solutions.

Variants: middle flange and middle screw flange fastening.

The high-temperature-resistant OMNIMATE® Power male header with THR (through-hole reflow) technology, suitable for the SMT process.

Product data

IEC: 1000 V / 41 A
 UL: 300 V / 33 A



For additional articles and information, refer to catalog.weidmuller.com

Note:

- Technical specifications refer to the power contacts
- Technical data of signal contacts: 50V / 5A, stripping length 8mm
- Rated current related to rated cross-section & min. No. of poles.
- Specifications of diagram: P1=7.62 mm; P2=3.81 mm
- Rated data refer only to the component itself. Clearance and creepage distances to other components are to be designed in accordance with the relevant application standards.
- MFX and MSFX: X= Position of the middle flange e.g. MF2, MSF3
- Long term storage of the product with average temperature of 50 °C and average humidity 70%, 36 months

SV-SMT../90 & SC 3.81 MSF2



Dimensioned drawing

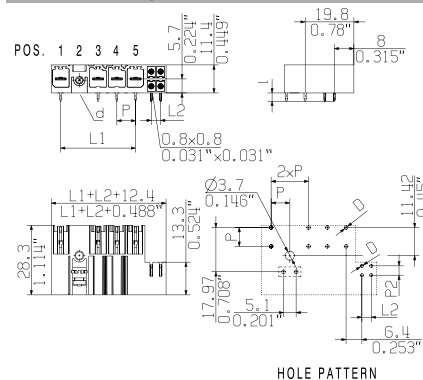

Technical data

In compliance with IEC 60664-1 / IEC 61984

Clamping range, max.			
Solid core H05(07) V-U			
Stranded H07 V-R			
Flexible H05(07) V-K			
Flexible with ferrule			
Ferrule with plastic collar			
Stripping length			
Screwdriver blade	mm		
According to norm			
Tightening torque range			
Rated current, max.	A	41	41
At ambient temperature		20°C	40°C
For conductor cross-section		III	III II
Overtoltage category		3	2 2
Pollution severity		3	2 2
Rated voltage	V	630	630 1000
Rated impulse voltage	kV	6	6 6
UL / CUL (Use Group)		B	C D
Rated voltage	V	300	300 600
Rated current	A	33	33 5
AWG conductor	AWG		-
CSA (Use Group)		B	C D
Rated voltage	V		
Rated current	A		
AWG conductor	AWG		
General data			
Type of insulation material		PA 9T	
UL 94 flammability rating		V-0	
Contact base material		Copper alloy	
Material of contact surface		tinned	
Pin dimensions = d	mm	0.8 x 1.0	
Solder eyelet Ø = D	mm	1.4	
Solder eyelet Ø tolerance	mm	+ 0,1	

Accessories

Note: Refer to the Accessories chapter for additional accessories.

Coding	Order No.
BV/SV 7.62HP K0	1937590000

Ordering data

Solder pin length		2.6 mm	
Colour		black	
Pitch		7.62 mm	
Poles	L1 (inch)	L2 (inch)	Qty. Order No.
2 / 4	15.24	0.600	3.81 0.150 60 2529890000
2 / 6	15.24	0.600	7.62 0.300 54 2529900000
2 / 8	15.24	0.600	11.43 0.450 48 2529910000
3 / 4	22.86	0.900	3.81 0.150 48 2529920000
3 / 6	22.86	0.900	7.62 0.300 42 2529930000
3 / 8	22.86	0.900	11.43 0.450 36 2529940000
4 / 4	30.48	1.200	3.81 0.150 36 2626930000
4 / 6	30.48	1.200	7.62 0.300 36 2626940000
4 / 8	30.48	1.200	11.43 0.450 30 2626950000
5 / 4	38.10	1.500	3.81 0.150 30 2626960000
5 / 6	38.10	1.500	7.62 0.300 30 2626970000
5 / 8	38.10	1.500	11.43 0.450 24 2626980000

SV-SMT../90 & SC 3.81 MSF3



Dimensioned drawing

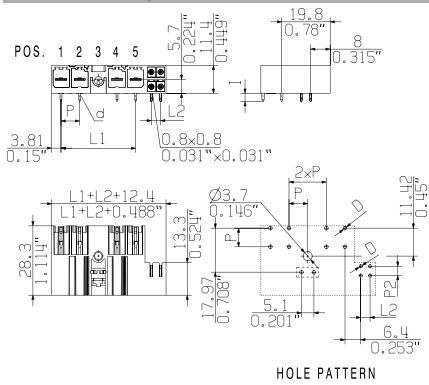

Ordering data

Solder pin length		2.6 mm				
Colour		black				
Pitch		7.62 mm				
Poles	L1 (inch)	L2 (inch)	Qty.	Order No.		
3/4	22.86	0.900	3.81	0.150	48	2529950000
3/6	22.86	0.900	7.62	0.300	42	2529960000
3/8	22.86	0.900	11.43	0.450	36	2529970000
4/4	30.48	1.200	3.81	0.150	36	2626990000
4/6	30.48	1.200	7.62	0.300	36	2627000000
4/8	30.48	1.200	11.43	0.450	30	2627050000
5/4	38.10	1.500	3.81	0.150	30	2530010000
5/6	38.10	1.500	7.62	0.300	30	2530020000
5/8	38.10	1.500	11.43	0.450	30	2530030000

SV-SMT../90 & SC 3.81 MSF4



Dimensioned drawing

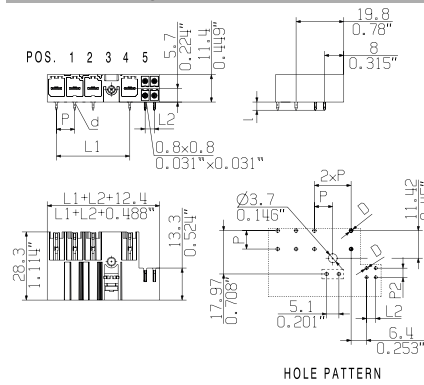

Ordering data

Solder pin length		2.6 mm				
Colour		black				
Pitch		7.62 mm				
Poles	L1 (inch)	L2 (inch)	Qty.	Order No.		
4/4	30.48	1.200	3.81	0.150	36	2529980000
4/6	30.48	1.200	7.62	0.300	36	2529990000
4/8	30.48	1.200	11.43	0.450	30	2530000000
5/4	38.10	1.500	3.81	0.150	30	2530040000
5/6	38.10	1.500	7.62	0.300	30	2530050000
5/8	38.10	1.500	11.43	0.450	30	2530060000

Connectors in 7.62 mm pitch
Series BV/SV 7.62 - connection up to 6 mm²

SV-SMT../270 & SC 3.81

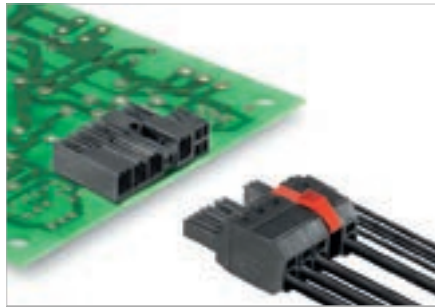

Hybrid male header with 270° outlet direction with power and signal contacts. Fulfills the enhanced requirements for 3 mm of finger safety on 400 V TNC(S) systems in accordance with IEC 61800-5-1 and allows UL approval for 600 V in accordance with UL61800-5-1/UL840. The self-locking middle flange reduces the space requirements by one pitch width in comparison with conventional solutions.

Variants: middle flange and middle screw flange fastening.

The high-temperature-resistant OMNIMATE® Power male header with THR (through-hole reflow) technology, suitable for the SMT process.

Product data

IEC: 1000 V / 41 A
 UL: 300 V / 33 A



For additional articles and information, refer to catalog.weidmuller.com

Note:

- Technical specifications refer to the power contacts
- Technical data of signal contacts: 50V / 5A, stripping length 8mm
- Rated current related to rated cross-section & min. No. of poles.
- Specifications of diagram: P1=7.62 mm; P2=3.81 mm
- Rated data refer only to the component itself. Clearance and creepage distances to other components are to be designed in accordance with the relevant application standards.
- Long term storage of the product with average temperature of 50 °C and average humidity 70%, 36 months

SV-SMT../270 & SC 3.81



Dimensioned drawing

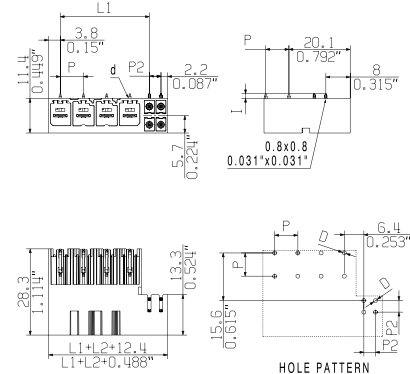

Technical data

In compliance with IEC 60664-1 / IEC 61984

Clamping range, max.			
Solid core H05(07) V-U			
Stranded H07 V-R			
Flexible H05(07) V-K			
Flexible with ferrule			
Ferrule with plastic collar			
Stripping length			
Screwdriver blade	mm		
According to norm			
Tightening torque range			
Rated current, max.	A	41	41
At ambient temperature		20°C	40°C
For conductor cross-section			
Overtoltage category		III	III II
Pollution severity		3	2 2
Rated voltage	V	630	630 1000
Rated impulse voltage	kV	6	6 6
UL / CUL (Use Group)		B	C D
Rated voltage	V	300	300 600
Rated current	A	33	33 5
AWG conductor	AWG		
CSA (Use Group)		B	C D
Rated voltage	V		
Rated current	A		
AWG conductor	AWG		
General data			
Type of insulation material		PA 9T	
UL 94 flammability rating		V-0	
Contact base material		Copper alloy	
Material of contact surface		tinned	
Pin dimensions = d	mm	0.8 x 1.0	
Solder eyelet Ø = D	mm	1.4	
Solder eyelet Ø tolerance	mm	+ 0,1	

Accessories

Note: Refer to the Accessories chapter for additional accessories.

Coding	Order No.
BV/SV 7.62HP K0	1937590000

Ordering data

Solder pin length		2.6 mm				
Colour		black				
Pitch		7.62 mm				
Poles	L1 (inch)	L2 (inch)	Qty.	Order No.		
2 / 4	7.62	0.300	3.81	0.150	66	2528970000
2 / 6	7.62	0.300	11.43	0.450	66	2529260000
2 / 8	7.62	0.300	11.43	0.450	60	2529270000
3 / 4	15.24	0.600	3.81	0.150	60	2529280000
3 / 6	15.24	0.600	11.43	0.450	54	2529290000
3 / 8	15.24	0.600	11.43	0.450	48	2529300000
4 / 4	22.86	0.900	3.81	0.150	48	2529310000
4 / 6	22.86	0.900	11.43	0.450	42	2529320000
4 / 8	22.86	0.900	11.43	0.450	42	2529330000
5 / 4	30.48	1.200	3.81	0.150	36	2529340000
5 / 6	30.48	1.200	11.43	0.450	36	2529350000
5 / 8	30.48	1.200	11.43	0.450	36	2529360000

Connectors in 7.62 mm pitch
Series BV/SV 7.62 - connection up to 6 mm²

SV-SMT../270 & SC 3.81 MF

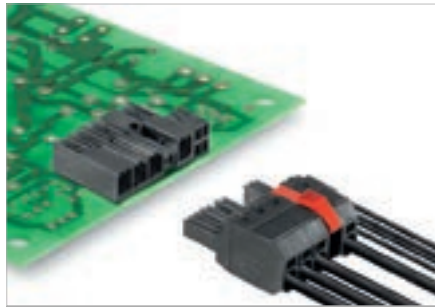

Hybrid male header with 270° outlet direction with power and signal contacts. Fulfils the enhanced requirements for 3 mm of finger safety on 400 V TNC(S) systems in accordance with IEC 61800-5-1 and allows UL approval for 600 V in accordance with UL61800-5-1/UL840. The self-locking middle flange reduces the space requirements by one pitch width in comparison with conventional solutions.

Variants: middle flange and middle screw flange fastening.

The high-temperature-resistant OMNIMATE® Power male header with THR (through-hole reflow) technology, suitable for the SMT process.

Product data

IEC: 1000 V / 41 A
 UL: 300 V / 33 A



For additional articles and information, refer to catalog.weidmueller.com

Note:

- Technical specifications refer to the power contacts
- Technical data of signal contacts: 50V / 5A, stripping length 8mm
- Rated current related to rated cross-section & min. No. of poles.
- Specifications of diagram: P1=7.62 mm; P2=3.81 mm
- Rated data refer only to the component itself. Clearance and creepage distances to other components are to be designed in accordance with the relevant application standards.
- MF2 and MSF2: X= Position of the middle flange e.g. MF2, MSF3
- Long term storage of the product with average temperature of 50 °C and average humidity 70%, 36 months

SV-SMT../270 & SC 3.81 MF2



Dimensioned drawing

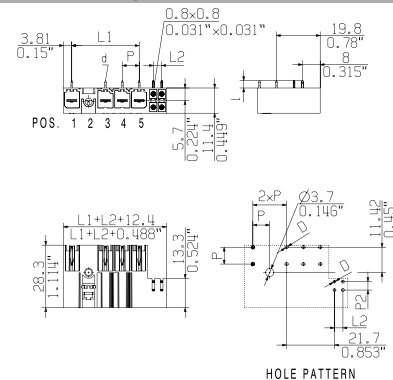

Technical data

In compliance with IEC 60664-1 / IEC 61984

Clamping range, max.			
Solid core H05(07) V-U			
Stranded H07 V-R			
Flexible H05(07) V-K			
Flexible with ferrule			
Ferrule with plastic collar			
Stripping length			
Screwdriver blade	mm		
According to norm			
Tightening torque range			
Rated current, max.	A	41	41
At ambient temperature		20°C	40°C
For conductor cross-section		III	III II
Overtoltage category		3	2 2
Pollution severity		3	2 2
Rated voltage	V	630	630 1000
Rated impulse voltage	kV	6	6 6
UL / CUL (Use Group)		B	C D
Rated voltage	V	300	300 600
Rated current	A	33	33 5
AWG conductor	AWG		
CSA (Use Group)		B	C D
Rated voltage	V		
Rated current	A		
AWG conductor	AWG		
General data			
Type of insulation material		PA 9T	
UL 94 flammability rating		V-0	
Contact base material		Copper alloy	
Material of contact surface		tinned	
Pin dimensions = d	mm	0.8 x 1.0	
Solder eyelet Ø = D	mm	1.4	
Solder eyelet Ø tolerance	mm	+ 0,1	

Accessories

Note: Refer to the Accessories chapter for additional accessories.

Coding	Order No.
BV/SV 7.62HP K0	1937590000

Ordering data

Solder pin length		2.6 mm	
Colour		black	
Pitch		7.62 mm	
Poles	L1 (inch)	L2 (inch)	Qty. Order No.
2 / 4	15.24	0.600 3.81	0.150 60 2529010000
2 / 6	15.24	0.600 7.62	0.300 54 2529370000
2 / 8	15.24	0.600 11.43	0.450 48 2529380000
3 / 4	22.86	0.900 3.81	0.150 48 2529390000
3 / 6	22.86	0.900 7.62	0.300 42 2529400000
3 / 8	22.86	0.900 11.43	0.450 36 2529410000
4 / 4	30.48	1.200 3.81	0.150 36 2627060000
4 / 6	30.48	1.200 7.62	0.300 36 2627090000
4 / 8	30.48	1.200 11.43	0.450 30 2627100000
5 / 4	38.10	1.500 3.81	0.150 30 2627110000
5 / 6	38.10	1.500 7.62	0.300 30 2627120000
5 / 8	38.10	1.500 11.43	0.450 24 2627130000

SV-SMT../270 & SC 3.81 MF3



Dimensioned drawing

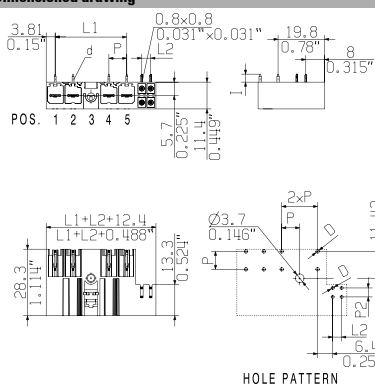

Ordering data

Solder pin length		2.6 mm		
Colour		black		
Pitch		7.62 mm		
Poles	L1 (inch)	L2 (inch)	Qty.	Order No.
3/4	22.86	0.900	3.81 0.150 48	2529420000
3/6	22.86	0.900	7.62 0.300 42	2529430000
3/8	22.86	0.900	11.43 0.450 36	2529440000
4/4	30.48	1.200	3.81 0.150 36	2627140000
4/6	30.48	1.200	7.62 0.300 36	2627150000
4/8	30.48	1.200	11.43 0.450 30	2627160000
5/4	38.10	1.500	3.81 0.150 30	2529480000
5/6	38.10	1.500	7.62 0.300 30	2529490000
5/8	38.10	1.500	11.43 0.450 30	2529500000

SV-SMT../270 & SC 3.81 MF4



Dimensioned drawing

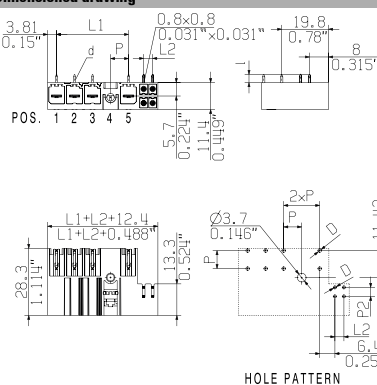

Ordering data

Solder pin length		2.6 mm		
Colour		black		
Pitch		7.62 mm		
Poles	L1 (inch)	L2 (inch)	Qty.	Order No.
4/4	30.48	1.200	3.81 0.150 36	2529450000
4/6	30.48	1.200	7.62 0.300 36	2529460000
4/8	30.48	1.200	11.43 0.450 30	2529470000
5/4	38.10	1.500	3.81 0.150 30	2529510000
5/6	38.10	1.500	7.62 0.300 30	2529520000
5/8	38.10	1.500	11.43 0.450 30	2529530000

Connectors in 7.62 mm pitch
Series BV/SV 7.62 - connection up to 6 mm²

SV-SMT../270 & SC 3.81 MSF

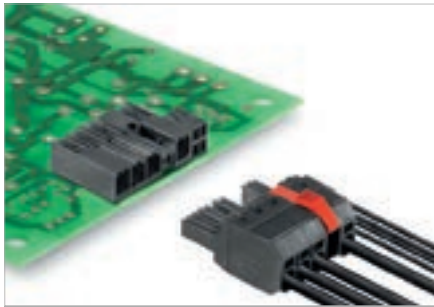

Hybrid male header with 270° outlet direction with power and signal contacts. Fulfils the enhanced requirements for 3 mm of finger safety on 400 V TNC(S) systems in accordance with IEC 61800-5-1 and allows UL approval for 600 V in accordance with UL61800-5-1/UL840. The self-locking middle flange reduces the space requirements by one pitch width in comparison with conventional solutions.

Variants: middle flange and middle screw flange fastening.

The high-temperature-resistant OMNIMATE® Power male header with THR (through-hole reflow) technology, suitable for the SMT process.

Technical data

In compliance with IEC 60664-1 / IEC 61984

Clamping range, max.			
Solid core H05(07) V-U			
Stranded H07 V-R			
Flexible H05(07) V-K			
Flexible with ferrule			
Ferrule with plastic collar			
Stripping length			
Screwdriver blade	mm		
According to norm			
Tightening torque range			
Rated current, max.	A	41	41
At ambient temperature		20°C	40°C
For conductor cross-section		III	III II
Overtoltage category		3	2 2
Pollution severity		3	2 2
Rated voltage	V	630	630 1000
Rated impulse voltage	kV	6	6 6
UL / CUL (Use Group)	B C D	B C D	B C D
Rated voltage	V	300	300 600
Rated current	A	33	33 5
AWG conductor	AWG	-	-
CSA (Use Group)	B C D	B C D	B C D
Rated voltage	V		
Rated current	A		
AWG conductor	AWG		
General data			
Type of insulation material		PA 9T	
UL 94 flammability rating		V-0	
Contact base material		Copper alloy	
Material of contact surface		tinned	
Pin dimensions = d	mm	0.8 x 1.0	
Solder eyelet Ø = D	mm	1.4	
Solder eyelet Ø tolerance	mm	+ 0,1	

Product data

IEC: 1000 V / 41 A
 UL: 300 V / 33 A



For additional articles and information, refer to catalog.weidmueller.com

Note:

- Technical specifications refer to the power contacts
- Technical data of signal contacts: 50V / 5A, stripping length 8mm
- Rated current related to rated cross-section & min. No. of poles.
- Specifications of diagram: P1=7.62 mm; P2=3.81 mm
- Rated data refer only to the component itself. Clearance and creepage distances to other components are to be designed in accordance with the relevant application standards.
- MFX and MSFX: X= Position of the middle flange e.g. MF2, MSF3
- Long term storage of the product with average temperature of 50 °C and average humidity 70%, 36 months

SV-SMT../270 & SC 3.81 MSF2



Dimensioned drawing

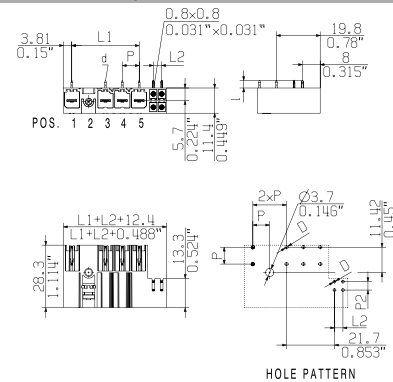

Accessories

Note: Refer to the Accessories chapter for additional accessories.

Coding	Order No.
BV/SV 7.62HP K0	1937590000

Ordering data

Solder pin length		2.6 mm	
Colour		black	
Pitch		7.62 mm	
Poles	L1 (inch)	L2 (inch)	Qty. Order No.
2 / 4	15.24	0.600 3.81	0.150 60 2529540000
2 / 6	15.24	0.600 7.62	0.300 54 2529550000
2 / 8	15.24	0.600 11.43	0.450 48 2529560000
3 / 4	22.86	0.900 3.81	0.150 48 2529570000
3 / 6	22.86	0.900 7.62	0.300 42 2529580000
3 / 8	22.86	0.900 11.43	0.450 36 2529590000
4 / 4	30.48	1.200 3.81	0.150 36 2627170000
4 / 6	30.48	1.200 7.62	0.300 36 2627180000
4 / 8	30.48	1.200 11.43	0.450 30 2627190000
5 / 4	38.10	1.500 3.81	0.150 30 2627200000
5 / 6	38.10	1.500 7.62	0.300 30 2627210000
5 / 8	38.10	1.500 11.43	0.450 24 2627220000

SV-SMT../270 & SC 3.81 MSF3



Dimensioned drawing

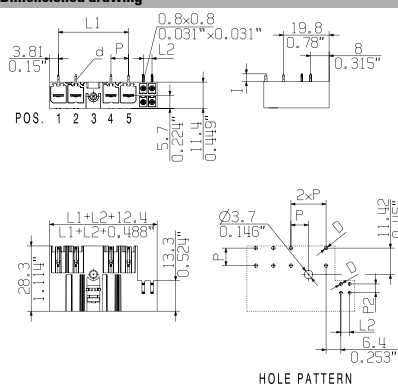

Ordering data

Solder pin length		2.6 mm					
Colour		black					
Pitch		7.62 mm					
Poles	L1 (inch)	L2 (inch)	Qty.	Order No.			
3/4	22.86	0.900	3.81 0.150	48	2529600000		
3/6	22.86	0.900	7.62 0.300	42	2529610000		
3/8	22.86	0.900	11.43 0.450	36	2529620000		
4/4	30.48	1.200	3.81 0.150	30	2627230000		
4/6	30.48	1.200	7.62 0.300	30	2627240000		
4/8	30.48	1.200	11.43 0.450	24	2627250000		
5/4	38.10	1.500	3.81 0.150	30	2529660000		
5/6	38.10	1.500	7.62 0.300	30	2529670000		
5/8	38.10	1.500	11.43 0.450	30	2529680000		

SV-SMT../270 & SC 3.81 MSF4



Dimensioned drawing

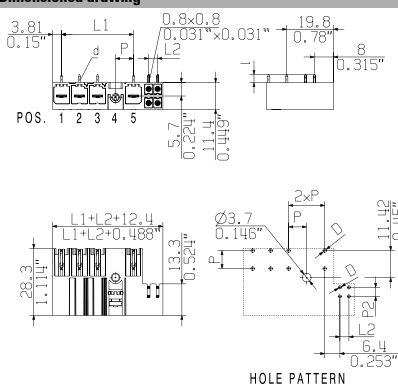

Ordering data

Solder pin length		2.6 mm					
Colour		black					
Pitch		7.62 mm					
Poles	L1 (inch)	L2 (inch)	Qty.	Order No.			
4/4	30.48	1.200	3.81 0.150	36	2529630000		
4/6	30.48	1.200	7.62 0.300	36	2529640000		
4/8	30.48	1.200	11.43 0.450	30	2529650000		
5/4	38.10	1.500	3.81 0.150	30	2529690000		
5/6	38.10	1.500	7.62 0.300	30	2529700000		
5/8	38.10	1.500	11.43 0.450	30	2529710000		

Connectors in 7.62 mm pitch
Series BV/SV 7.62 - connection up to 6 mm²

SV 7.62HP../90 & SC 3.81

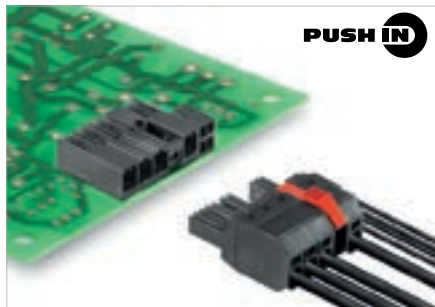

Hybrid male header with 90° outlet direction with power and signal contacts. Meets the enhanced requirements for 3 mm of touch safety for 400 V TNC(S) systems in acc. with IEC 61800-5-1 and comes with UL approval for 600 V in acc. with UL508-5-1 / UL840.

The self-locking middle flange reduces the space requirements by one pitch width compared to conventional solutions.

Variants: flange, screw flange, middle flange and middle screw flange fastening.

Product data

IEC: 1000 V / 41 A
 UL: 300 V / 35 A



For additional articles and information, refer to catalog.weidmuller.com

Note:

- Technical specifications refer to the power contacts
- Technical data of signal contacts: 50V / 5A, stripping length 8mm
- Rated current related to rated cross-section & min. No. of poles.
- Specifications of diagram: P1=7.62 mm; P2=3.81 mm
- Rated data refer only to the component itself. Clearance and creepage distances to other components are to be designed in accordance with the relevant application standards.
- Long term storage of the product with average temperature of 50 °C and average humidity 70%, 36 months

SV 7.62HP../90 SC../R



Dimensioned drawing

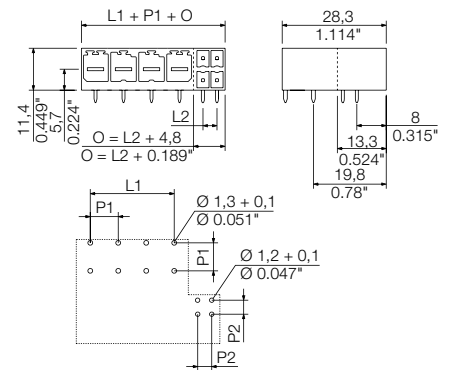

Technical data

In compliance with IEC 60664-1 / IEC 61984			
Clamping range, max.			
Solid core H05(07) V-U			
Stranded H07 V-R			
Flexible H05(07) V-K			
Flexible with ferrule			
Ferrule with plastic collar			
Stripping length			
Screwdriver blade	mm		
According to norm			
Tightening torque range			
Rated current, max.	A	41	41
At ambient temperature		20°C	40°C
For conductor cross-section			
Overtoltage category		III	III II
Pollution severity		3	2 2
Rated voltage	V	630	630 1000
Rated impulse voltage	kV	6	6 6
UL / CUL (Use Group)		B	C D
Rated voltage	V	300	300 600
Rated current	A	35	35 5
AWG conductor	AWG		
CSA (Use Group)		B	C D
Rated voltage	V	300	300 600
Rated current	A	33	33 5
AWG conductor	AWG		
General data			
Type of insulation material		PA GF	
UL 94 flammability rating		V-0	
Contact base material		Copper alloy	
Material of contact surface		tinned	
Pin dimensions = d	mm	0.8 x 1.0	
Solder eyelet Ø = D	mm	1.4	
Solder eyelet Ø tolerance	mm	+ 0,1	

Accessories

Note: Refer to the Accessories chapter for additional accessories.

Coding	Order No.
BV/SV 7.62HP KO	1937590000

Ordering data

Solder pin length		3.5 mm				
Colour		black				
Pitch		7.62 mm				
Poles	L1 (inch)	L2 (inch)	Qty.	Order No.		
2 / 4	7.62	0.300	3.81	0.150	78	1089840000
2 / 6	7.62	0.300	7.62	0.300	66	1089920000
2 / 8	7.62	0.300	11.43	0.450	60	1157040000
3 / 4	15.24	0.600	3.81	0.150	60	1090040000
3 / 6	15.24	0.600	7.62	0.300	48	1090120000
3 / 8	15.24	0.600	11.43	0.450	48	1157050000
4 / 4	22.86	0.900	3.81	0.150	48	1090280000
4 / 6	22.86	0.900	7.62	0.300	42	1090360000
4 / 8	22.86	0.900	11.43	0.450	36	1157380000
5 / 4	30.48	1.200	3.81	0.150	36	1090520000
5 / 6	30.48	1.200	7.62	0.300	36	1090590000
5 / 8	30.48	1.200	11.43	0.450	30	1157080000

Connectors in 7.62 mm pitch
Series BV/SV 7.62 - connection up to 6 mm²

SV 7.62HP../90 & SC 3.81MF

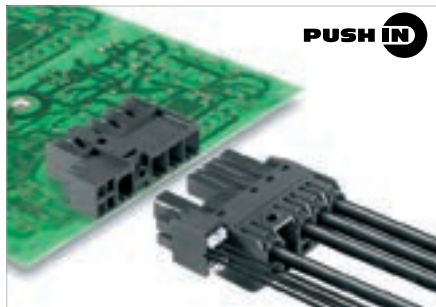

PUSH IN

Hybrid male header with 90° outlet direction with power and signal contacts. Meets the enhanced requirements for 3 mm of touch safety for 400 V TNC(S) systems in acc. with IEC 61800-5-1 and comes with UL approval for 600 V in acc. with UL508-5-1 / UL840.

The self-locking middle flange reduces the space requirements by one pitch width compared to conventional solutions.

Variants: flange, screw flange, middle flange and middle screw flange fastening.

Product data

IEC: 1000 V / 41 A
 UL: 300 V / 35 A



For additional articles and information, refer to catalog.weidmuller.com

Note:

- Technical specifications refer to the power contacts
- Technical data of signal contacts: 50V / 5A, stripping length 8mm
- Rated current related to rated cross-section & min. No. of poles.
- Specifications of diagram: P1=7.62 mm; P2=3.81 mm
- Rated data refer only to the component itself. Clearance and creepage distances to other components are to be designed in accordance with the relevant application standards.
- MFX and MSFX: X= Position of the middle flange e.g. MF2, MSF3
- Long term storage of the product with average temperature of 50 °C and average humidity 70%, 36 months

SV 7.62HP../90MF2. SC../R



Dimensioned drawing

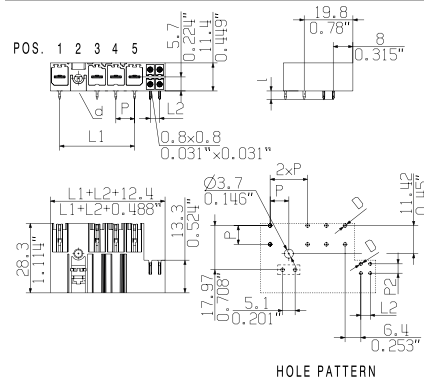

Technical data

In compliance with IEC 60664-1 / IEC 61984

Clamping range, max.			
Solid core H05(07) V-U			
Stranded H07 V-R			
Flexible H05(07) V-K			
Flexible with ferrule			
Ferrule with plastic collar			
Stripping length			
Screwdriver blade	mm		
According to norm			
Tightening torque range			
Rated current, max.	A	41	41
At ambient temperature		20°C	40°C
For conductor cross-section			
Overtoltage category		III	III II
Pollution severity		3	2 2
Rated voltage	V	630	630 1000
Rated impulse voltage	kV	6	6 6
UL / CUL (Use Group)		B	C D
Rated voltage	V	300	300 600
Rated current	A	35	35 5
AWG conductor	AWG		
CSA (Use Group)		B	C D
Rated voltage	V	300	300 600
Rated current	A	33	33 5
AWG conductor	AWG		
General data			
Type of insulation material		PA GF	
UL 94 flammability rating		V-0	
Contact base material		Copper alloy	
Material of contact surface		tinned	
Pin dimensions = d	mm	0.8 x 1.0	
Solder eyelet Ø = D	mm	1.4	
Solder eyelet Ø tolerance	mm	+ 0,1	

Accessories

Note: Refer to the Accessories chapter for additional accessories.

Coding	Order No.
BV/SV 7.62HP K0	1937590000

Ordering data

Solder pin length		3.5 mm	
Colour		black	
Pitch 7.62 mm			
Poles	L1 (inch)	L2 (inch)	Qty. Order No.
2 / 4	15.24	0.600	3.81 0.150 60 1089370000
2 / 6	15.24	0.600	7.62 0.300 48 1089410000
2 / 8	15.24	0.600	11.43 0.450 48 1156820000
3 / 4	22.86	0.900	3.81 0.150 48 1156230000
3 / 6	22.86	0.900	7.62 0.300 42 1156240000
3 / 8	22.86	0.900	11.43 0.450 36 1156840000
4 / 4	30.48	1.200	3.81 0.150 36 2627670000
4 / 6	30.48	1.200	7.62 0.300 36 2628150000
4 / 8	30.48	1.200	11.43 0.450 30 2628160000
5 / 4	38.10	1.500	3.81 0.150 30 2628170000
5 / 6	38.10	1.500	7.62 0.300 30 2628180000
5 / 8	38.10	1.500	11.43 0.450 24 2628190000

SV 7.62HP../90MF3. SC../R



Dimensioned drawing

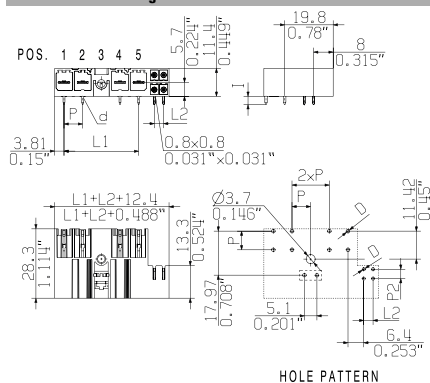

HOLE PATTERN

Ordering data

Solder pin length		3.5 mm					
Colour		black					
Pitch		7.62 mm					
Poles	L1 (inch)	L2 (inch)	Qty.	Order No.			
3/4	22.86	0.900	3.81 0.150	48	1089660000		
3/6	22.86	0.900	7.62 0.300	42	1089730000		
3/8	22.86	0.900	11.43 0.450	36	1156850000		
4/4	30.48	1.200	3.81 0.150	36	2628200000		
4/6	30.48	1.200	7.62 0.300	36	2628210000		
4/8	30.48	1.200	11.43 0.450	30	2628220000		
5/4	38.10	1.500	3.81 0.150	30	1156910000		
5/6	38.10	1.500	7.62 0.300	30	1156930000		
5/8	38.10	1.500	11.43 0.450	30	1156950000		

SV 7.62HP../90MF4. SC../R



Dimensioned drawing

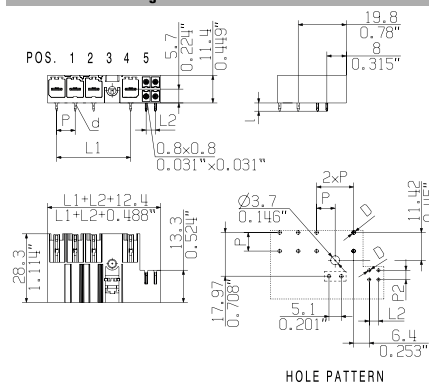

HOLE PATTERN

Ordering data

Solder pin length		3.5 mm					
Colour		black					
Pitch		7.62 mm					
Poles	L1 (inch)	L2 (inch)	Qty.	Order No.			
4/4	30.48	1.200	3.81 0.150	36	1090130000		
4/6	30.48	1.200	7.62 0.300	36	1090210000		
4/8	30.48	1.200	11.43 0.450	30	1156890000		
5/4	38.10	1.500	3.81 0.150	30	1090600000		
5/6	38.10	1.500	7.62 0.300	30	1090670000		
5/8	38.10	1.500	11.43 0.450	30	1156980000		

Connectors in 7.62 mm pitch
Series BV/SV 7.62 - connection up to 6 mm²

SV 7.62HP../90 & SC 3.81MSF

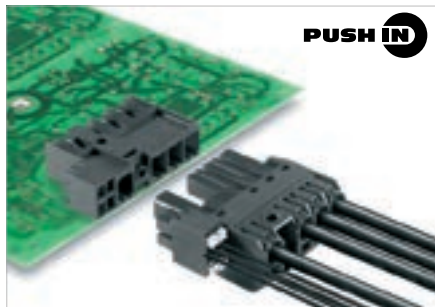

PUSH IN

Hybrid male header with 90° outlet direction with power and signal contacts. Meets the enhanced requirements for 3 mm of touch safety for 400 V TNC(S) systems in acc. with IEC 61800-5-1 and comes with UL approval for 600 V in acc. with UL508-5-1 / UL840.

The self-locking middle flange reduces the space requirements by one pitch width compared to conventional solutions.

Variants: flange, screw flange, middle flange and middle screw flange fastening.

Product data

IEC: 1000 V / 41 A
 UL: 300 V / 35 A



For additional articles and information, refer to catalog.weidmuller.com

Note:

- Technical specifications refer to the power contacts
- Technical data of signal contacts: 50V / 5A, stripping length 8mm
- Rated current related to rated cross-section & min. No. of poles.
- Specifications of diagram: P1=7.62 mm; P2=3.81 mm
- Rated data refer only to the component itself. Clearance and creepage distances to other components are to be designed in accordance with the relevant application standards.
- MFX and MSFX: X= Position of the middle flange e.g. MF2, MSF3
- Long term storage of the product with average temperature of 50 °C and average humidity 70%, 36 months

SV 7.62HP../90MSF2. SC../R



Dimensioned drawing

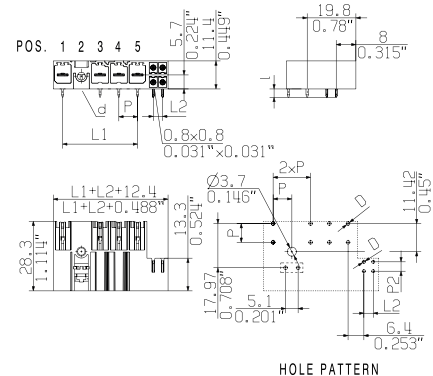

Technical data

In compliance with IEC 60664-1 / IEC 61984

Clamping range, max.			
Solid core H05(07) V-U			
Stranded H07 V-R			
Flexible H05(07) V-K			
Flexible with ferrule			
Ferrule with plastic collar			
Stripping length			
Screwdriver blade	mm		
According to norm			
Tightening torque range			
Rated current, max.	A	41	41
At ambient temperature		20°C	40°C
For conductor cross-section			
Overtoltage category		III	III II
Pollution severity		3	2 2
Rated voltage	V	630	630 1000
Rated impulse voltage	kV	6	6 6
UL / CUL (Use Group)		B	C D
Rated voltage	V	300	300 600
Rated current	A	35	35 5
AWG conductor	AWG		-
CSA (Use Group)		B	C D
Rated voltage	V	300	300 600
Rated current	A	33	33 5
AWG conductor	AWG		-
General data			
Type of insulation material	PA GF		
UL 94 flammability rating	V-0		
Contact base material	Copper alloy		
Material of contact surface	tinned		
Pin dimensions = d	mm	0.8 x 1.0	
Solder eyelet Ø = D	mm	1.4	
Solder eyelet Ø tolerance	mm	+ 0,1	

Accessories

Note: Refer to the Accessories chapter for additional accessories.

Coding	Order No.
BV/SV 7.62HP K0	1937590000

Ordering data

Solder pin length		3.5 mm	
Colour		black	
Pitch		7.62 mm	
Poles	L1 (inch)	L2 (inch)	Qty. Order No.
2 / 4	15.24	0.600	3.81 0.150 60 1089510000
2 / 6	15.24	0.600	7.62 0.300 48 1089570000
2 / 8	15.24	0.600	11.43 0.450 48 1156830000
3 / 4	22.86	0.900	3.81 0.150 48 1156250000
3 / 6	22.86	0.900	7.62 0.300 42 1156270000
3 / 8	22.86	0.900	11.43 0.450 36 1156870000
4 / 4	30.48	1.200	3.81 0.150 36 2628230000
4 / 6	30.48	1.200	7.62 0.300 36 2628240000
4 / 8	30.48	1.200	11.43 0.450 30 2628250000
5 / 4	38.10	1.500	3.81 0.150 30 2628260000
5 / 6	38.10	1.500	7.62 0.300 30 2628270000
5 / 8	38.10	1.500	11.43 0.450 24 2628280000

SV 7.62HP../90MSF3.SC../R



Dimensioned drawing

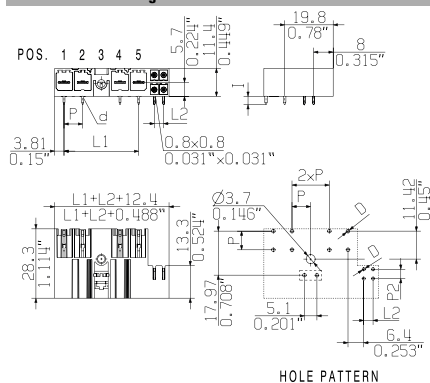

Ordering data

Solder pin length		3.5 mm					
Colour		black					
Pitch		7.62 mm					
Poles	L1 (inch)	L2 (inch)	Qty.	Order No.			
3/4	22.86	0.900	3.81 0.150	48	1089890000		
3/6	22.86	0.900	7.62 0.300	42	1089970000		
3/8	22.86	0.900	11.43 0.450	36	1156880000		
4/4	30.48	1.200	3.81 0.150	36	2628290000		
4/6	30.48	1.200	7.62 0.300	36	2628300000		
4/8	30.48	1.200	11.43 0.450	30	2628310000		
5/4	38.10	1.500	3.81 0.150	30	1157000000		
5/6	38.10	1.500	7.62 0.300	30	1157010000		
5/8	38.10	1.500	11.43 0.450	30	1157020000		

SV 7.62HP../90MSF4.SC../R



Dimensioned drawing

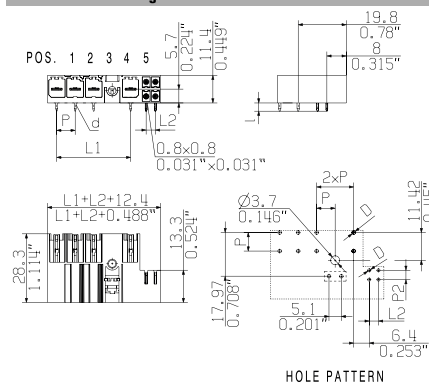

Ordering data

Solder pin length		3.5 mm					
Colour		black					
Pitch		7.62 mm					
Poles	L1 (inch)	L2 (inch)	Qty.	Order No.			
4/4	30.48	1.200	3.81 0.150	36	1090370000		
4/6	30.48	1.200	7.62 0.300	36	1090450000		
4/8	30.48	1.200	11.43 0.450	30	1156900000		
5/4	38.10	1.500	3.81 0.150	30	1090830000		
5/6	38.10	1.500	7.62 0.300	30	1090900000		
5/8	38.10	1.500	11.43 0.450	30	1157030000		

Connectors in 7.62 mm pitch
Series BV/SV 7.62 - connection up to 6 mm²

SV 7.62HP../270 & SC 3.81

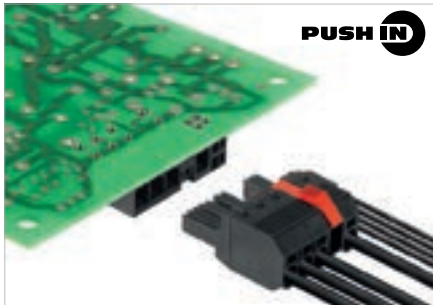

Hybrid male header with 270° outlet direction with power and signal contacts. Meets the enhanced requirements for 3 mm of touch safety for 400 V TNC(S) systems in acc. with IEC 61800-5-1 and comes with UL approval for 600 V in acc. with UL508-5-1 / UL840.

The self-locking middle flange reduces the space requirements by one pitch width compared to conventional solutions.

Variants: middle flange and middle screw flange fastening.

Product data

IEC: 1000 V / 41 A
 UL: 300 V / 35 A



For additional articles and information, refer to catalog.weidmuller.com

Note:

- Technical specifications refer to the power contacts
- Technical data of signal contacts: 50V / 5A, stripping length 8mm
- Rated current related to rated cross-section & min. No. of poles.
- Specifications of diagram: P1=7.62 mm; P2=3.81 mm
- Rated data refer only to the component itself. Clearance and creepage distances to other components are to be designed in accordance with the relevant application standards.
- Long term storage of the product with average temperature of 50 °C and average humidity 70%, 36 months

SV 7.62HP../270 SC../R



Dimensioned drawing

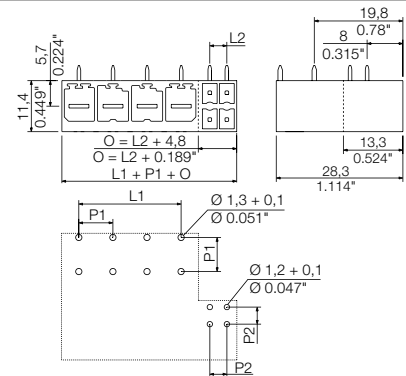

Technical data

In compliance with IEC 60664-1 / IEC 61984

Clamping range, max.			
Solid core H05(07) V-U			
Stranded H07 V-R			
Flexible H05(07) V-K			
Flexible with ferrule			
Ferrule with plastic collar			
Stripping length			
Screwdriver blade	mm		
According to norm			
Tightening torque range			
Rated current, max.	A	41	41
At ambient temperature		20°C	40°C
For conductor cross-section			
Overtoltage category		III	III
Pollution severity		3	2
Rated voltage	V	630	630
Rated impulse voltage	kV	6	6
UL / CUL (Use Group)	B	C	D
Rated voltage	V	300	300
Rated current	A	35	35
AWG conductor	AWG	-	-
CSA (Use Group)	B	C	D
Rated voltage	V	300	300
Rated current	A	33	33
AWG conductor	AWG	-	-
General data			
Type of insulation material	PA GF		
UL 94 flammability rating	V-0		
Contact base material	Copper alloy		
Material of contact surface	tinned		
Pin dimensions = d	mm	0.8 x 1.0	
Solder eyelet Ø = D	mm	1.4	
Solder eyelet Ø tolerance	mm	+ 0,1	

Accessories

Note: Refer to the Accessories chapter for additional accessories.

Coding	Order No.
BV/SV 7.62HP KO	1937590000

Ordering data

Solder pin length		3.5 mm				
Colour		black				
Pitch		7.62 mm				
Poles	L1 (inch)	L2 (inch)	Qty.	Order No.		
2 / 4	7.62	0.300	3.81	0.150	78	1090770000
2 / 6	7.62	0.300	7.62	0.300	66	1090850000
2 / 8	7.62	0.300	11.43	0.450	60	1156920000
3 / 4	15.24	0.600	3.81	0.150	60	1090950000
3 / 6	15.24	0.600	7.62	0.300	48	1091010000
3 / 8	15.24	0.600	11.43	0.450	48	1156940000
4 / 4	22.86	0.900	3.81	0.150	48	1091120000
4 / 6	22.86	0.900	7.62	0.300	42	1091160000
4 / 8	22.86	0.900	11.43	0.450	36	1156970000
5 / 4	30.48	1.200	3.81	0.150	36	1091240000
5 / 6	30.48	1.200	7.62	0.300	36	1091260000
5 / 8	30.48	1.200	11.43	0.450	30	1156990000

Connectors in 7.62 mm pitch
Series BV/SV 7.62 - connection up to 6 mm²

SV 7.62HP../270 & SC 3.81MF

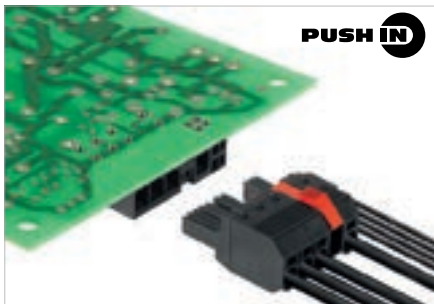

Hybrid male header with 270° outlet direction with power and signal contacts. Meets the enhanced requirements for 3 mm of touch safety for 400 V TNC(S) systems in acc. with IEC 61800-5-1 and comes with UL approval for 600 V in acc. with UL508-5-1 / UL840.

The self-locking middle flange reduces the space requirements by one pitch width compared to conventional solutions.

Variants: middle flange and middle screw flange fastening.

Product data

IEC: 1000 V / 41 A
 UL: 300 V / 35 A



For additional articles and information, refer to catalog.weidmueller.com

Note:

- Technical specifications refer to the power contacts
- Technical data of signal contacts: 50V / 5A, stripping length 8mm
- Rated current related to rated cross-section & min. No. of poles.
- Specifications of diagram: P1=7.62 mm; P2=3.81 mm
- Rated data refer only to the component itself. Clearance and creepage distances to other components are to be designed in accordance with the relevant application standards.
- MFX and MSFX: X= Position of the middle flange e.g. MF2, MSF3
- Long term storage of the product with average temperature of 50 °C and average humidity 70%, 36 months

SV 7.62HP../270MF2. SC../R



Dimensioned drawing

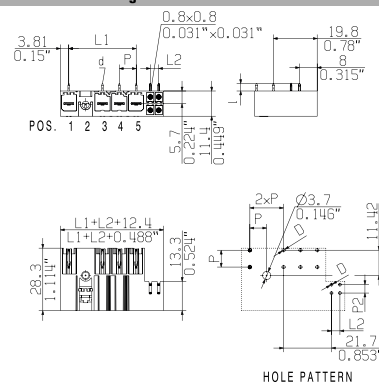

Technical data

In compliance with IEC 60664-1 / IEC 61984

Clamping range, max.			
Solid core H05(07) V-U			
Stranded H07 V-R			
Flexible H05(07) V-K			
Flexible with ferrule			
Ferrule with plastic collar			
Stripping length			
Screwdriver blade	mm		
According to norm			
Tightening torque range			
Rated current, max.	A	41	41
At ambient temperature		20°C	40°C
For conductor cross-section			
Overtoltage category		III	III II
Pollution severity		3	2 2
Rated voltage	V	630	630 1000
Rated impulse voltage	kV	6	6 6
UL / CUL (Use Group)		B	C D
Rated voltage	V	300	300 600
Rated current	A	35	35 5
AWG conductor	AWG		
CSA (Use Group)		B	C D
Rated voltage	V	300	300 600
Rated current	A	33	33 5
AWG conductor	AWG		
General data			
Type of insulation material		PA GF	
UL 94 flammability rating		V-0	
Contact base material		Copper alloy	
Material of contact surface		tinned	
Pin dimensions = d	mm	0.8 x 1.0	
Solder eyelet Ø = D	mm	1.4	
Solder eyelet Ø tolerance	mm	+ 0,1	

Accessories

Note: Refer to the Accessories chapter for additional accessories.

Coding	Order No.
BV/SV 7.62HP K0	1937590000

Ordering data

Solder pin length	3.5 mm					
Colour	black					
Pitch	7.62 mm					
Poles	L1 (inch)	L2 (inch)	Qty.	Order No.		
2 / 4	15.24	0.600	3.81	0.150	60	1089260000
2 / 6	15.24	0.600	7.62	0.300	48	1089280000
2 / 8	15.24	0.600	11.43	0.450	48	1156120000
3 / 4	22.86	0.900	3.81	0.150	48	1156140000
3 / 6	22.86	0.900	7.62	0.300	42	1156150000
3 / 8	22.86	0.900	11.43	0.450	36	1156170000
4 / 4	30.48	1.200	3.81	0.150	36	2627960000
4 / 6	30.48	1.200	7.62	0.300	36	2627970000
4 / 8	30.48	1.200	11.43	0.450	30	2627980000
5 / 4	38.10	1.500	3.81	0.150	30	2627990000
5 / 6	38.10	1.500	7.62	0.300	30	2628000000
5 / 8	38.10	1.500	11.43	0.450	24	2628010000

SV 7.62HP../270MF3. SC/..R



Dimensioned drawing

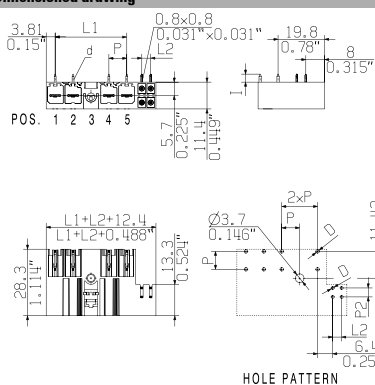

Ordering data

Solder pin length		3.5 mm					
Colour		black					
Pitch		7.62 mm					
Poles	L1 (inch)	L2 (inch)	Qty.	Order No.			
3/4	22.86	0.900	3.81 0.150	48	1089440000		
3/6	22.86	0.900	7.62 0.300	42	1089490000		
3/8	22.86	0.900	11.43 0.450	36	1156180000		
4/4	30.48	1.200	3.81 0.150	36	2628020000		
4/6	30.48	1.200	7.62 0.300	36	2628030000		
4/8	30.48	1.200	11.43 0.450	30	2628040000		
5/4	30.48	1.500	3.81 0.150	30	1156300000		
5/6	38.10	1.500	7.62 0.300	30	1156310000		
5/8	38.10	1.500	11.43 0.450	30	1156320000		

SV 7.62HP../270MF4. SC/..R



Dimensioned drawing

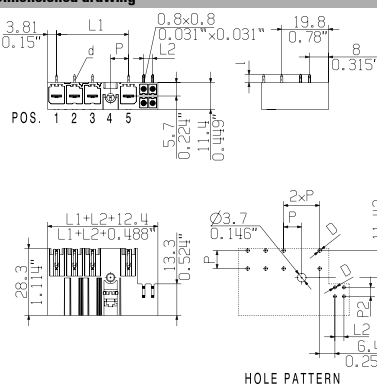

Ordering data

Solder pin length		3.5 mm					
Colour		black					
Pitch		7.62 mm					
Poles	L1 (inch)	L2 (inch)	Qty.	Order No.			
4/4	30.48	0.900	3.81 0.150	36	1089820000		
4/6	30.48	1.200	7.62 0.300	36	1089910000		
4/8	30.48	1.200	11.43 0.450	30	1156280000		
5/4	38.10	1.500	3.81 0.150	30	1090300000		
5/6	38.10	1.500	7.62 0.300	30	1090380000		
5/8	38.10	1.500	11.43 0.450	30	1156340000		

Connectors in 7.62 mm pitch
Series BV/SV 7.62 - connection up to 6 mm²

SV 7.62HP../270 & SC 3.81MSF

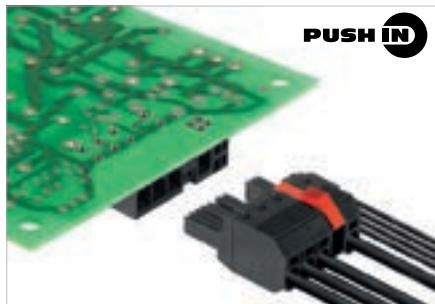

Hybrid male header with 270° outlet direction with power and signal contacts. Meets the enhanced requirements for 3 mm of touch safety for 400 V TNC(S) systems in acc. with IEC 61800-5-1 and comes with UL approval for 600 V in acc. with UL508-5-1 / UL840.

The self-locking middle flange reduces the space requirements by one pitch width compared to conventional solutions.

Variants: middle flange and middle screw flange fastening.

Product data

IEC: 1000 V / 41 A
 UL: 300 V / 35 A



For additional articles and information, refer to catalog.weidmueller.com

Note:

- Technical specifications refer to the power contacts
- Technical data of signal contacts: 50V / 5A, stripping length 8mm
- Rated current related to rated cross-section & min. No. of poles.
- Specifications of diagram: P1=7.62 mm; P2=3.81 mm
- Rated data refer only to the component itself. Clearance and creepage distances to other components are to be designed in accordance with the relevant application standards.
- MFX and MSFX: X= Position of the middle flange e.g. MF2, MSF3
- Long term storage of the product with average temperature of 50 °C and average humidity 70%, 36 months

SV 7.62HP../270MSF2, SC../R



Dimensioned drawing

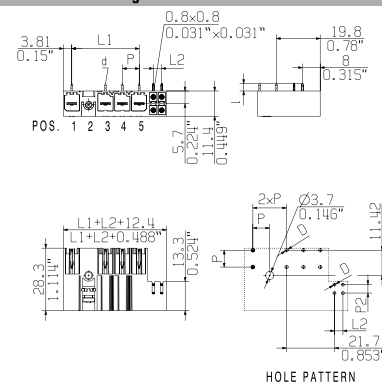

Technical data

In compliance with IEC 60664-1 / IEC 61984			
Clamping range, max.			
Solid core H05(07) V-U			
Stranded H07 V-R			
Flexible H05(07) V-K			
Flexible with ferrule			
Ferrule with plastic collar			
Stripping length			
Screwdriver blade	mm		
According to norm			
Tightening torque range			
Rated current, max.	A	41	41
At ambient temperature		20°C	40°C
For conductor cross-section			
Overtoltage category		III	III II
Pollution severity		3	2 2
Rated voltage	V	630	630 1000
Rated impulse voltage	kV	6	6 6
UL / CUL (Use Group)		B	C D
Rated voltage	V	300	300 600
Rated current	A	35	35 5
AWG conductor	AWG		
CSA (Use Group)		B	C D
Rated voltage	V	300	300 600
Rated current	A	33	33 5
AWG conductor	AWG		
General data			
Type of insulation material		PA GF	
UL 94 flammability rating		V-0	
Contact base material		Copper alloy	
Material of contact surface		tinned	
Pin dimensions = d	mm	0.8 x 1.0	
Solder eyelet Ø = D	mm	1.4	
Solder eyelet Ø tolerance	mm	+ 0,1	

Accessories

Note: Refer to the Accessories chapter for additional accessories.

Coding	Order No.
BV/SV 7.62HP K0	1937590000

Ordering data

Solder pin length		3.5 mm	
Colour		black	
Pitch		7.62 mm	
Poles	L1 (inch)	L2 (inch)	Qty. Order No.
2 / 4	15.24	0.600 3.81	0.150 60 1089340000
2 / 6	15.24	0.600 7.62	0.300 48 1089380000
2 / 8	15.24	0.600 11.43	0.450 48 1156130000
3 / 4	22.86	0.900 3.81	0.150 48 1156190000
3 / 6	22.86	0.900 7.62	0.300 42 1156200000
3 / 8	22.86	0.900 11.43	0.450 36 1156210000
4 / 4	30.48	1.200 3.81	0.150 36 2628050000
4 / 6	30.48	1.200 7.62	0.300 36 2628060000
4 / 8	30.48	1.200 11.43	0.450 30 2628070000
5 / 4	38.10	1.500 3.81	0.150 30 2628080000
5 / 6	38.10	1.500 7.62	0.300 30 2628090000
5 / 8	38.10	1.500 11.43	0.450 24 2628100000

SV 7.62HP../270MSF3. SC/..R



Dimensioned drawing

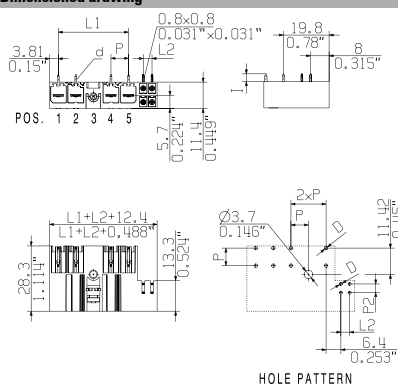

Ordering data

Solder pin length		3.5 mm					
Colour		black					
Pitch		7.62 mm					
Poles	L1 (inch)	L2 (inch)	Qty.	Order No.			
3/4	22.86	0.900	3.81 0.150	48	1089610000		
3/6	22.86	0.900	7.62 0.300	42	1089670000		
3/8	22.86	0.900	11.43 0.450	36	1156220000		
4/4	30.48	1.200	3.81 0.150	36	2628110000		
4/6	30.48	1.200	7.62 0.300	36	2628120000		
4/8	30.48	1.200	11.43 0.450	30	2628130000		
5/4	38.10	1.500	3.81 0.150	30	1156370000		
5/6	38.10	1.500	7.62 0.300	30	1156390000		
5/8	38.10	1.500	11.43 0.450	30	1156410000		

SV 7.62HP../270MSF4. SC/..R



Dimensioned drawing

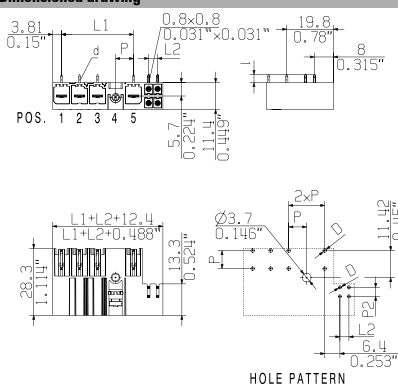

Ordering data

Solder pin length		3.5 mm					
Colour		black					
Pitch		7.62 mm					
Poles	L1 (inch)	L2 (inch)	Qty.	Order No.			
4/4	30.48	1.200	3.81 0.150	36	1090060000		
4/6	30.48	1.200	7.62 0.300	36	1090140000		
4/8	30.48	1.200	11.43 0.450	30	1156290000		
5/4	38.10	1.500	3.81 0.150	30	1090540000		
5/6	38.10	1.500	7.62 0.300	30	1090610000		
5/8	38.10	1.500	11.43 0.450	30	1156430000		

Connectors in 7.62 mm pitch
Series BV/SV 7.62 - connection up to 6 mm²

BVF 7.62HP../180 & BCF 3.81

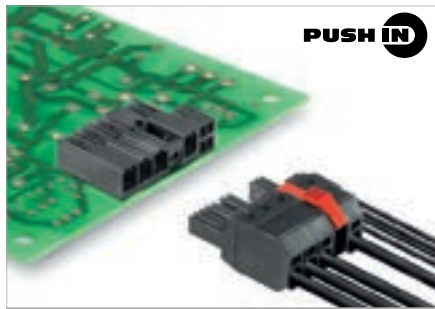

PUSH IN

Hybrid female plug with power and signal contacts with PUSH IN connection system. Allows power, signals and shield to be plugged in simultaneously. It is perfect for connecting servo-drives and asynchronous drives. Meets the requirements of UL1059 for 600 V Use Group C. The mating profile ensures touch-safety of > 3 mm in accordance with IEC 61800-5-1.

Product data

IEC: 1000 V / 38 A / 0.5 - 10 mm²
 UL: 600 V / 35 A / AWG 24 - 8



For additional articles and information, refer to catalog.weidmuller.com

Note:

- Technical specifications refer to the power contacts
- Technical data of signal contacts: 50V / 5A, stripping length 8mm
- Additional variants on request
- Rated current related to rated cross-section & min. No. of poles.
- Wire end ferrule with plastic collar to DIN 46228/4
- Wire end ferrule without plastic collar to DIN 46228/1
- Rated data refer only to the component itself. Clearance and creepage distances to other components are to be designed in accordance with the relevant application standards.
- Long term storage of the product with average temperature of 50 °C and average humidity 70%, 36 months

BVF 7.62HP../180 BCF../R



Dimensioned drawing

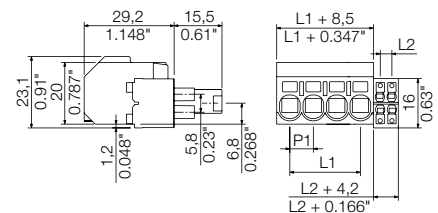

Technical data

In compliance with IEC 60664-1 / IEC 61984			
Clamping range, max.	mm ²	0.5...10	
Solid core H05(07) V-U	mm²	0.5...10	
Stranded H07 V-R		...10	
Flexible H05(07) V-K	mm ²	0.5...10	
Flexible with ferrule	mm ²	1.5...10	
Ferrule with plastic collar	mm ²	1.5...6	
Stripping length	mm	12	
Screwdriver blade	mm	0.6 x 3.5	
According to norm			
Tightening torque range			
Rated current, max.	A	38	34
At ambient temperature	20°C		40°C
For conductor cross-section	mm ²	6	
Overvoltage category		III	III II
Pollution severity		3	2 2
Rated voltage	V	800	1000 1000
Rated impulse voltage	kV	8	8 6
UL / CUL (Use Group)		B	C D
Rated voltage	V	600	600 600
Rated current	A	35	35 5
AWG conductor	AWG	24-8	
CSA (Use Group)		B	C D
Rated voltage	V	600	600 600
Rated current	A	33	33 5
AWG conductor	AWG	24-8	
General data			
Type of insulation material		PA GF	
UL 94 flammability rating		V-0	
Contact base material		Copper alloy	
Material of contact surface		tinned	
Pin dimensions = d	mm		
Solder eyelet Ø = D	mm		
Solder eyelet Ø tolerance	mm		

Accessories

Note: Refer to the Accessories chapter for additional accessories.

Coding	Order No.
BV/SV 7.62HP KO	1937590000
Screwdriver	
SDS 0.8X4.5X125	2749370000
Pressing tool	
PZ 6/5	9011460000

Ordering data

Solder pin length						
Colour						black
Pitch 7.62 mm						
Poles	L1 (inch)	L2 (inch)	Qty.	Order No.		
2 / 4	7.62	0.300	3.81	0.150	65	1080550000
2 / 6	7.62	0.300	7.62	0.300	55	1080320000
2 / 8	7.62	0.300	11.43	0.450	50	1156440000
3 / 4	15.24	0.600	3.81	0.150	50	1080490000
3 / 6	15.24	0.600	7.62	0.300	45	1080570000
3 / 8	15.24	0.600	11.43	0.450	40	1156450000
4 / 4	22.86	0.900	3.81	0.150	40	1080510000
4 / 6	22.86	0.900	7.62	0.300	35	1080440000
4 / 8	22.86	0.900	11.43	0.450	30	1156470000
5 / 8	30.48	1.200	11.43	0.450	25	1156480000

Representative deratings curve

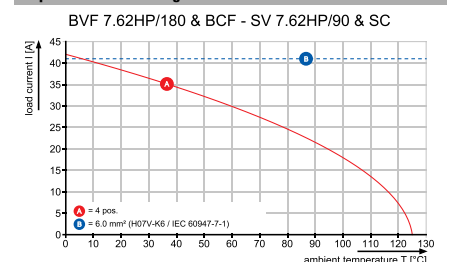

Connectors in 7.62 mm pitch
Series BV/SV 7.62 - connection up to 6 mm²

BVF 7.62HP../180MF & BCF 3.81

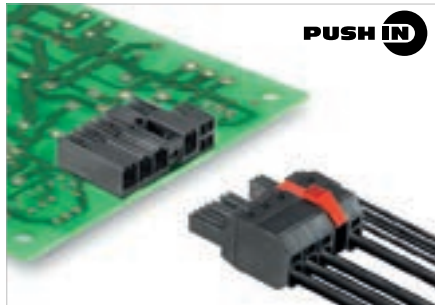

PUSH IN

Hybrid female plug with power and signal contacts with PUSH IN connection system. Allows power, signals and shield to be plugged in simultaneously. It is perfect for connecting servo-drives and asynchronous drives. Meets the requirements of UL1059 for 600 V Use Group C. The mating profile ensures touch-safety of > 3 mm in accordance with IEC 61800-5-1. The self-fastening middle flange reduces the space requirements by one pole.

The pluggable shield connection establishes a large contact area on the device housing and does not need to be screwed on separately.

Technical data

In compliance with IEC 60664-1 / IEC 61984			
Clamping range, max.	mm ²	0.5...10	
Solid core H05(07) V-U	mm²	0.5...10	
Stranded H07 V-R		...10	
Flexible H05(07) V-K	mm ²	0.5...10	
Flexible with ferrule	mm ²	1.5...10	
Ferrule with plastic collar	mm ²	1.5...6	
Stripping length	mm	12	
Screwdriver blade	mm	0.6 x 3.5	
According to norm			
Tightening torque range			
Rated current, max.	A	38	34
At ambient temperature		20°C	40°C
For conductor cross-section	mm ²	6	
Overvoltage category		III	III II
Pollution severity		3	2 2
Rated voltage	V	800	1000 1000
Rated impulse voltage	kV	8	8 6
UL / CUL (Use Group)		B	C D
Rated voltage	V	600	600 600
Rated current	A	35	35 5
AWG conductor	AWG	24-8	
CSA (Use Group)		B	C D
Rated voltage	V	600	600 600
Rated current	A	33	33 5
AWG conductor	AWG	24-8	
General data			
Type of insulation material		PA GF	
UL 94 flammability rating		V-0	
Contact base material		Copper alloy	
Material of contact surface		tinned	
Pin dimensions = d	mm		
Solder eyelet Ø = D	mm		
Solder eyelet Ø tolerance	mm		

Product data

IEC: 1000 V / 38 A / 0.5 - 10 mm²
 UL: 600 V / 35 A / AWG 24 - 8



For additional articles and information, refer to catalog.weidmuller.com

Note:

- Technical specifications refer to the power contacts
- Technical data of signal contacts: 50V / 5A, stripping length 8mm
- Additional variants on request
- Rated current related to rated cross-section & min. No. of poles.
- Wire end ferrule with plastic collar to DIN 46228/4
- Wire end ferrule without plastic collar to DIN 46228/1
- Rated data refer only to the component itself. Clearance and creepage distances to other components are to be designed in accordance with the relevant application standards.
- Long term storage of the product with average temperature of 50 °C and average humidity 70%, 36 months

BVF 7.62HP../180MF2, BCF../R



Dimensioned drawing

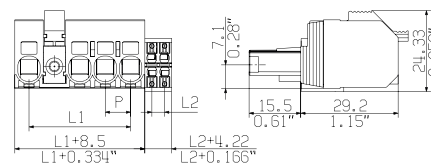

Accessories

Note: Refer to the Accessories chapter for additional accessories.

Coding	Order No.
BV/SV 7.62HP K0	1937590000
Shielding	
BVF 7.62HP SH150 4-6 KIT	1118480000
BVF 7.62HP SH180 4-6 KIT	1118470000
BVF 7.62HP SH210 4-6 KIT	1118490000
Screwdriver	
SDS 0.8X4.5X125	2749370000
Pressing tool	
PZ 6/5	9011460000

Ordering data

Solder pin length						
Colour					black	
Pitch 7.62 mm						
Poles	L1 (inch)	L2 (inch)	Qty.	Order No.		
2 / 4	15.24	0.600	3.81	0.150	50	1081610000
2 / 6	15.24	0.600	7.62	0.300	45	1081030000
2 / 8	15.24	0.600	11.43	0.450	40	1157090000
3 / 4	22.86	0.900	3.81	0.150	40	1157110000
3 / 6	22.86	0.900	7.62	0.300	35	1157120000
3 / 8	22.86	0.900	11.43	0.450	30	1157130000
4 / 4	30.48	1.200	3.81	0.150	30	2628320000
4 / 6	30.48	1.200	7.62	0.300	30	2628340000
4 / 8	30.48	1.200	11.43	0.450	25	2628350000
5 / 4	38.10	1.500	3.81	0.150	30	2628390000
5 / 6	38.10	1.500	7.62	0.300	30	2628400000
5 / 8	38.10	1.500	11.43	0.450	25	2628410000

Representative deratings curve

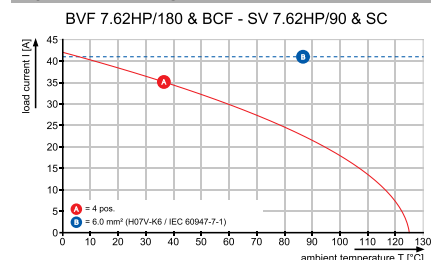

BVF 7.62HP../180MF3. BCF../R



Dimensioned drawing

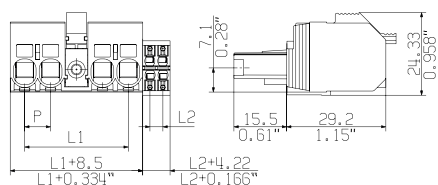

BVF 7.62HP../180MF4. BCF../R



Dimensioned drawing

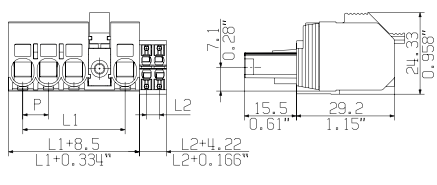

Ordering data

Solder pin length						
Colour						black
Pitch 7.62 mm						
Poles	L1 (inch)	L2 (inch)	Qty.	Order No.		
3/4	22.86	0.900	3.81	0.150	40	1081630000
3/6	22.86	0.900	7.62	0.300	35	1081720000
3/8	22.86	0.900	11.43	0.450	30	1157170000
4/4	30.48	1.200	3.81	0.150	36	2628450000
4/6	30.48	1.200	7.62	0.300	30	2628460000
4/8	30.48	1.200	11.43	0.450	25	2628470000
5/4	38.10	1.500	3.81	0.150	25	1157220000
5/6	38.10	1.500	7.62	0.300	25	1157230000
5/8	38.10	1.500	11.43	0.450	25	1157240000

Ordering data

Solder pin length						
Colour						black
Pitch 7.62 mm						
Poles	L1 (inch)	L2 (inch)	Qty.	Order No.		
4/4	30.48	1.200	3.81	0.150	30	1081150000
4/6	30.48	1.200	7.62	0.300	30	1082020000
4/8	30.48	1.200	11.43	0.450	25	1157200000
5/4	38.10	1.500	3.81	0.150	25	1082140000
5/6	38.10	1.500	7.62	0.300	25	1081760000
5/8	38.10	1.500	11.43	0.450	25	1157250000

Connectors in 7.62 mm pitch
Series BV/SV 7.62 - connection up to 6 mm²

BVF 7.62HP../180MSF & BCF 3.81

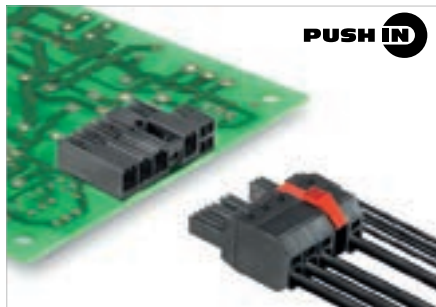

Hybrid female plug with power and signal contacts with PUSH IN connection system. Allows power, signals and shield to be plugged in simultaneously. It is perfect for connecting servo-drives and asynchronous drives. Meets the requirements of UL1059 for 600 V Use Group C. The mating profile ensures touch-safety of > 3 mm in accordance with IEC 61800-5-1. The self-fastening middle flange reduces the space requirements by one pole.

The pluggable shield connection establishes a large contact area on the device housing and does not need to be screwed on separately.

Technical data

In compliance with IEC 60664-1 / IEC 61984			
Clamping range, max.	mm ²	0.5...10	
Solid core H05(07) V-U	mm²	0.5...10	
Stranded H07 V-R		...10	
Flexible H05(07) V-K	mm ²	0.5...10	
Flexible with ferrule	mm ²	1.5...10	
Ferrule with plastic collar	mm ²	1.5...6	
Stripping length	mm	12	
Screwdriver blade	mm	0.6 x 3.5	
According to norm			
Tightening torque range			
Rated current, max.	A	38	34
At ambient temperature		20°C	40°C
For conductor cross-section	mm ²	6	
Overvoltage category		III	III II
Pollution severity		3	2 2
Rated voltage	V	800	1000 1000
Rated impulse voltage	kV	8	8 6
UL / CUL (Use Group)		B	C D
Rated voltage	V	600	600 600
Rated current	A	35	35 5
AWG conductor	AWG	24-8	
CSA (Use Group)		B	C D
Rated voltage	V	600	600 600
Rated current	A	33	33 5
AWG conductor	AWG	24-8	
General data			
Type of insulation material		PA GF	
UL 94 flammability rating		V-0	
Contact base material		Copper alloy	
Material of contact surface		tinned	
Pin dimensions = d	mm		
Solder eyelet Ø = D	mm		
Solder eyelet Ø tolerance	mm		

Product data

IEC: 1000 V / 38 A / 0.5 - 10 mm²
 UL: 600 V / 35 A / AWG 24 - 8



For additional articles and information, refer to catalog.weidmuller.com

Note:

- Technical specifications refer to the power contacts
- Technical data of signal contacts: 50V / 5A, stripping length 8mm
- Additional variants on request
- Rated current related to rated cross-section & min. No. of poles.
- Wire end ferrule with plastic collar to DIN 46228/4
- Wire end ferrule without plastic collar to DIN 46228/1
- Rated data refer only to the component itself. Clearance and creepage distances to other components are to be designed in accordance with the relevant application standards.
- Long term storage of the product with average temperature of 50 °C and average humidity 70%, 36 months

BVF 7.62HP../180MSF2. BCF../R



Dimensioned drawing

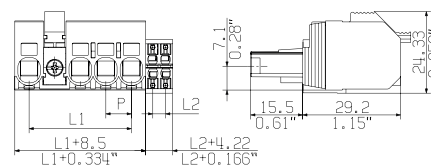

Accessories

Note: Refer to the Accessories chapter for additional accessories.

Coding	Order No.
BV/SV 7.62HP K0	1937590000
Shielding	
BVF 7.62HP SH150 4-6 KIT	1118480000
BVF 7.62HP SH180 4-6 KIT	1118470000
BVF 7.62HP SH210 4-6 KIT	1118490000
Screwdriver	
SDS 0.8X4.5X125	2749370000
Pressing tool	
PZ 6/5	9011460000

Ordering data

Solder pin length						
Colour					black	
Pitch 7.62 mm						
Poles	L1 (inch)	L2 (inch)	Qty.	Order No.		
2 / 4	15.24	0.600	3.81	0.150	50	1081930000
2 / 6	15.24	0.600	7.62	0.300	45	1082080000
2 / 8	15.24	0.600	11.43	0.450	40	1157100000
3 / 4	22.86	0.900	3.81	0.150	40	1157440000
3 / 6	22.86	0.900	7.62	0.300	35	1157450000
3 / 8	22.86	0.900	11.43	0.450	30	1157470000
4 / 4	30.48	1.200	3.81	0.150	36	2628510000
4 / 6	30.48	1.200	7.62	0.300	36	2628520000
4 / 8	30.48	1.200	11.43	0.450	25	2628530000
5 / 4	38.10	1.500	3.81	0.150	30	2628570000
5 / 6	38.10	1.500	7.62	0.300	30	2628580000
5 / 8	38.10	1.500	11.43	0.450	25	2628590000

Representative deratings curve

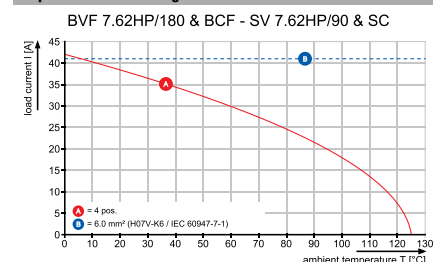

BVF 7.62HP../180MSF3. BCF../R



Dimensioned drawing

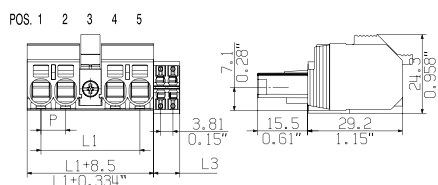

BVF 7.62HP../180MSF4. BCF../R



Dimensioned drawing

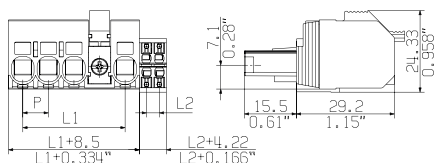

Ordering data

Solder pin length						
Colour						black
Pitch 7.62 mm						
Poles	L1	(inch)	L2	(inch)	Qty.	Order No.
3/4	22.86	0.900	3.81	0.150	40	1082110000
3/6	22.86	0.900	7.62	0.300	35	1081730000
3/8	22.86	0.900	11.43	0.450	30	1157190000
4/4	30.48	1.200	3.81	0.150	36	2628630000
4/6	30.48	1.200	7.62	0.300	30	2628640000
4/8	30.48	1.200	11.43	0.450	25	2628650000
5/4	38.10	1.500	3.81	0.150	25	1157270000
5/6	38.10	1.500	7.62	0.300	25	1157280000
5/8	38.10	1.500	11.43	0.450	25	1157290000

Ordering data

Solder pin length						
Colour						black
Pitch 7.62 mm						
Poles	L1	(inch)	L2	(inch)	Qty.	Order No.
4/4	30.48	1.200	3.81	0.150	30	1081660000
4/6	30.48	1.200	7.62	0.300	30	1081750000
4/8	30.48	1.200	11.43	0.450	25	1157210000
5/4	38.10	1.500	3.81	0.150	25	1080940000
5/6	38.10	1.500	7.62	0.300	25	1080720000
5/8	38.10	1.500	11.43	0.450	25	1157300000

Connectors in 7.62 mm pitch
Series BV/SV 7.62 - connection up to 6 mm²

BVF 7.62HP../180 BCF 3.81 SH



Hybrid female connector with power and signal contacts with PUSH IN spring connection technology. Enables simultaneous connection of power, signals and shielding. Ideal for connecting servo and asynchronous drives. Meets the requirements of UL1059 for 600 V Use Group C. The pin arrangement guarantees more than 3 mm of touch-safety in accordance with IEC 61800-5-1. The snap-on middle flange decreases the space required by one pitch width.

The pluggable shield connection has a wide contact area on the device housing and does not need to be bolted.

Technical data

In compliance with IEC 60664-1 / IEC 61984			
Clamping range, max.	mm ²	0.5...10	
Solid core H05(07) V-U	mm²	0.5...10	
Stranded H07 V-R		...10	
Flexible H05(07) V-K	mm ²	0.5...10	
Flexible with ferrule	mm ²	1.5...10	
Ferrule with plastic collar	mm ²	1.5...6	
Stripping length	mm	12	
Screwdriver blade	mm	0.6 x 3.5	
According to norm			
Tightening torque range			
Rated current, max.	A	38	34
At ambient temperature	20°C		40°C
For conductor cross-section	mm ²	6	
Overtolerance category		III	III II
Pollution severity		3	2 2
Rated voltage	V	630	630 800
Rated impulse voltage	kV	6	6 6
UL / CUL (Use Group)			
Rated voltage		B	C D
Rated current			
AWG conductor	AWG		
CSA (Use Group)			
Rated voltage		B	C D
Rated current			
AWG conductor	AWG		
General data			
Type of insulation material			
UL 94 flammability rating			
Contact base material			
Material of contact surface			
Pin dimensions = d	mm		
Solder eyelet Ø = D	mm		
Solder eyelet Ø tolerance	mm		

Product data

IEC: 800 V / 38 A / 0.5 - 10 mm²
 UL:



For additional articles and information, refer to catalog.weidmueller.com

Note:

- Technical specifications refer to the power contacts
- Technical data of signal contacts: 50V / 5A, stripping length 8mm
- Additional variants on request
- Rated current related to rated cross-section & min. No. of poles.
- Wire end ferrule with plastic collar to DIN 46228/4
- Wire end ferrule without plastic collar to DIN 46228/1
- Rated data refer only to the component itself. Clearance and creepage distances to other components are to be designed in accordance with the relevant application standards.
- Long term storage of the product with average temperature of 50 °C and average humidity 70%, 36 months

BVF 7.62HP../180MF BCF SH180



UL 600 V

Dimensioned drawing

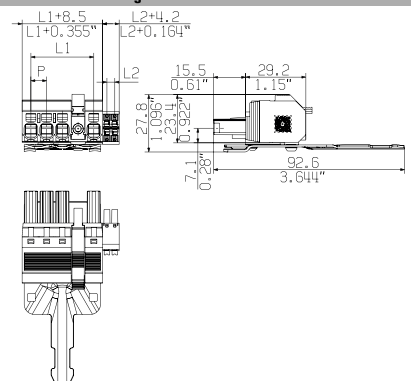

Ordering data

Solder pin length						
Colour						black
Pitch		7.62 mm				
Poles	L1 (inch)	L2 (inch)	Qty.	Order No.		
4 / 4	30.48	1.200	3.81	0.150	20	2681760000

Accessories

Note: Refer to the Accessories chapter for additional accessories.

Coding	Order No.
BV/SV 7.62HP K0	1937590000
Pressing tool	
PZ 6/5	9011460000
Screwdriver	
SDS 0.6X3.5X100	2749340000
Marking tags	
SCT 4.6/127 C	1699800000
WSM TOOL AUTOMATIK	1774470000

Representative dimensional drawing

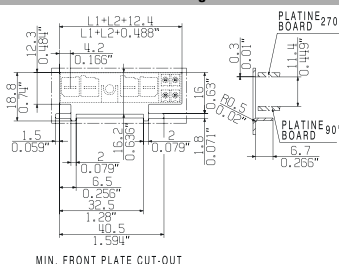

Representative deratings curve

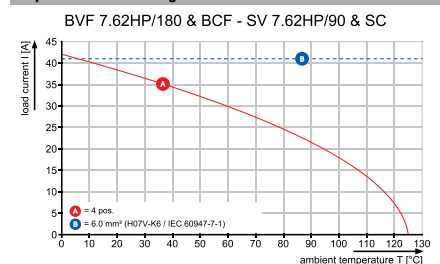

BVF 7.62HP/./180MSF BCF SH180



**UL
600V**

Dimensioned drawing

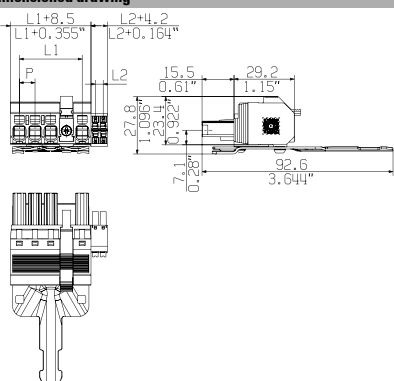

Ordering data

Solder pin length						
Colour						black
Pitch 7.62 mm						
Poles	L1	(inch)	L2	(inch)	Qty.	Order No.
4/4	30.48	1.200	3.81	0.150	20	2681780000

Connectors in 7.62 mm pitch
Series BV/SV 7.62 - connection up to 6 mm²

BVF 7.62HP../180 BCF 3.81 SP

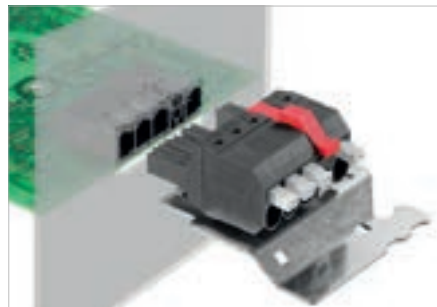

Hybrid female connector with power and signal contacts with PUSH IN spring connection technology. Enables simultaneous connection of power, signals and shielding. Ideal for connecting servo and asynchronous drives. Meets the requirements of UL1059 for 600 V Use Group C. The pin arrangement guarantees more than 3 mm of touch-safety in accordance with IEC 61800-5-1. The snap-on middle flange decreases the space required by one pitch width.

The pluggable shield connection has a wide contact area on the PCB and does not need to be bolted.

Technical data

In compliance with IEC 60664-1 / IEC 61984			
Clamping range, max.	mm ²	0.5...10	
Solid core H05(07) V-U	mm²	0.5...10	
Stranded H07 V-R		...10	
Flexible H05(07) V-K	mm ²	0.5...10	
Flexible with ferrule	mm ²	1.5...10	
Ferrule with plastic collar	mm ²	1.5...6	
Stripping length	mm	12	
Screwdriver blade	mm	0.6 x 3.5	
According to norm			
Tightening torque range			
Rated current, max.	A	38	34
At ambient temperature	20°C		40°C
For conductor cross-section	mm ²	6	
Overvoltage category		III	III II
Pollution severity		3	2 2
Rated voltage	V	630	630 800
Rated impulse voltage	kV	6	6 6
UL / CUL (Use Group)	B	C	D
Rated voltage			
Rated current			
AWG conductor	AWG		
CSA (Use Group)	B	C	D
Rated voltage			
Rated current			
AWG conductor	AWG		
General data			
Type of insulation material		PA GF	
UL 94 flammability rating		V-0	
Contact base material		Copper alloy	
Material of contact surface			
Pin dimensions = d	mm		
Solder eyelet Ø = D	mm		
Solder eyelet Ø tolerance	mm		

Product data

IEC: 800 V / 38 A / 0.5 - 10 mm²
 UL:



For additional articles and information, refer to catalog.weidmueller.com

Note:

- Technical specifications refer to the power contacts
- Technical data of signal contacts: 50V / 5A, stripping length 8mm
- Additional variants on request
- Rated current related to rated cross-section & min. No. of poles.
- Wire end ferrule with plastic collar to DIN 46228/4
- Wire end ferrule without plastic collar to DIN 46228/1
- Rated data refer only to the component itself. Clearance and creepage distances to other components are to be designed in accordance with the relevant application standards.
- Long term storage of the product with average temperature of 50 °C and average humidity 70%, 36 months

BVF 7.62HP../180MSF BCF SP90



UL 600 V

Dimensioned drawing

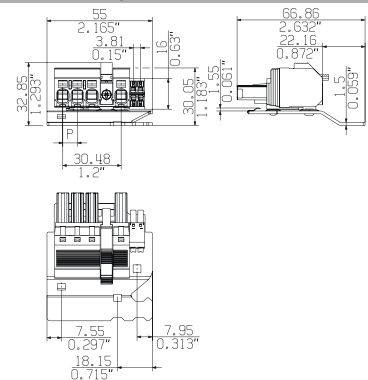

Ordering data

Solder pin length						
Colour	black					
Pitch	7.62 mm					
Poles	L1 (inch)	L2 (inch)	Qty.	Order No.		
4 / 4	30.48	1.200	3.81	0.150	24	2614040000

Accessories

Note: Refer to the Accessories chapter for additional accessories.		
Coding		Order No.
	BV/SV 7.62HP K0	1937590000
Pressing tool		
	PZ 6/5	9011460000
Screwdriver		
	SDS 0.6X3.5X100	2749340000
Marking tags		
	SCT 4.6/127 C	1699800000
	WSM TOOL AUTOMATIK	1774470000

Representative dimensional drawing

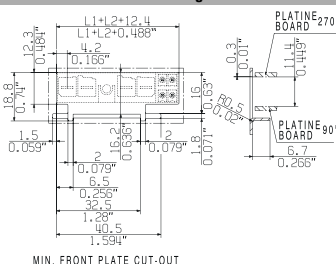

Representative deratings curve

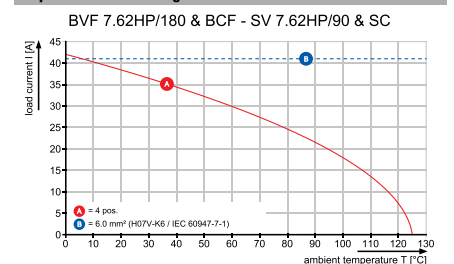

BVF 7.62HP/./180MSF BCF SP150



**UL
600V**

Dimensioned drawing

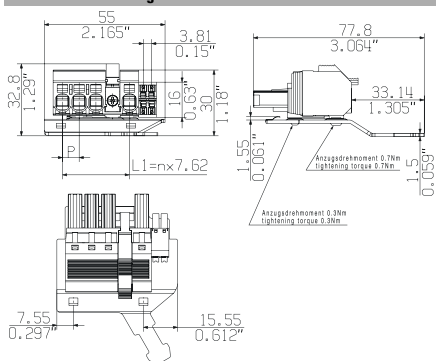

Ordering data

Solder pin length						
Colour						black
Pitch						7.62 mm
Poles	L1	(inch)	L2	(inch)	Qty.	Order No.
4/4	30.48	1.200	3.81	0.150	14	2669590000

BVF 7.62HP/./180MSF BCF SP180



**UL
600V**

Dimensioned drawing

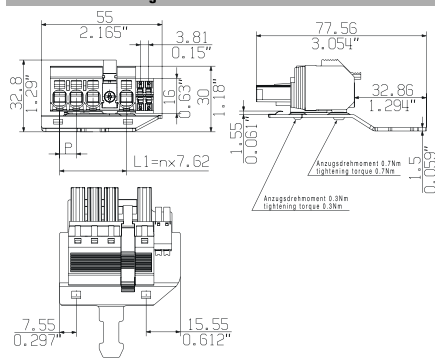

Ordering data

Solder pin length						
Colour						black
Pitch						7.62 mm
Poles	L1	(inch)	L2	(inch)	Qty.	Order No.
4/4	30.48	1.200	3.81	0.150	14	2633380000

BVF 7.62HP/./180MSF BCF SP210



**UL
600V**

Dimensioned drawing

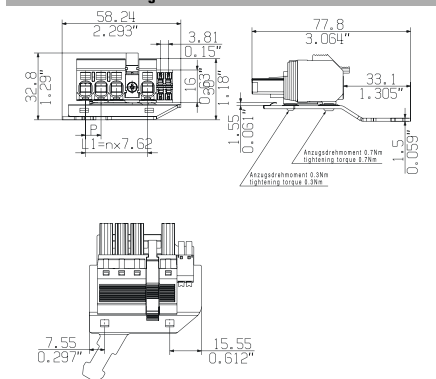

Ordering data

Solder pin length						
Colour						black
Pitch						7.62 mm
Poles	L1	(inch)	L2	(inch)	Qty.	Order No.
4/4	30.48	1.200	3.81	0.150	14	2669610000

Connectors in 7.62 mm pitch
Series BV/SV 7.62 - connection up to 6 mm²

BVFL 7.62HP../180 BCF 3.81

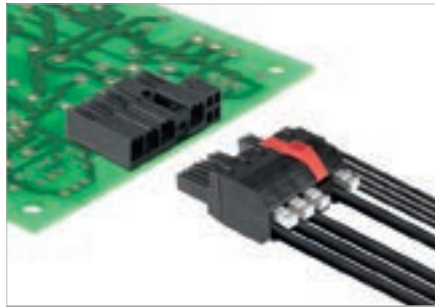

Hybrid female connector with power and signal contacts and adjustable actuator (pusher) featuring PUSH IN spring connection technology. Enables simultaneous connection of power, signals and shielding. Ideal for connecting servo and asynchronous drives. Meets the requirements of UL1059 for 600 V Use Group C. The pin arrangement guarantees more than 3 mm of touch-safety in accordance with IEC 61800-5-1.

Technical data

In compliance with IEC 60664-1 / IEC 61984			
Clamping range, max.	mm ²	0.5...6	
Solid core H05(07) V-U	mm ²	0.5...6	
Stranded H07 V-R			
Flexible H05(07) V-K	mm ²	0.5...6	
Flexible with ferrule	mm ²	0.5...6	
Ferrule with plastic collar	mm ²	0.5...6	
Stripping length	mm	12	
Screwdriver blade	mm	0.6 x 3.5	
According to norm			
Tightening torque range			
Rated current, max.	A	38	34
At ambient temperature		20°C	40°C
For conductor cross-section	mm ²	6	
Overvoltage category		III	III II
Pollution severity		3	2 2
Rated voltage	V	800	1000 1000
Rated impulse voltage	kV	8	8 6
UL / CUL (Use Group)		B	C D
Rated voltage	V	600	600 600
Rated current	A	35	35 5
AWG conductor	AWG	24-8	
CSA (Use Group)		B	C D
Rated voltage	V		
Rated current	A		
AWG conductor	AWG		
General data			
Type of insulation material		PA GF	
UL 94 flammability rating		V-0	
Contact base material		Copper alloy	
Material of contact surface		tinned	
Pin dimensions = d	mm		
Solder eyelet Ø = D	mm		
Solder eyelet Ø tolerance	mm		

Product data

IEC: 1000 V / 38 A / 0.5 - 6 mm²
 UL: 600 V / 35 A / AWG 24 - 8



For additional articles and information, refer to catalog.weidmuller.com

Note:

- Technical specifications refer to the power contacts
- Technical data of signal contacts: 50V / 5A, stripping length 8mm
- Additional variants on request
- Rated current related to rated cross-section & min. No. of poles.
- Wire end ferrule with plastic collar to DIN 46228/4
- Wire end ferrule without plastic collar to DIN 46228/1
- Rated data refer only to the component itself. Clearance and creepage distances to other components are to be designed in accordance with the relevant application standards.
- Additional pole combinations on request
- Long term storage of the product with average temperature of 50 °C and average humidity 70%, 36 months

BVFL 7.62HP../180 BCF 3.81



Dimensioned drawing

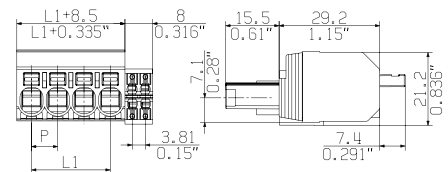

Accessories

Note: Refer to the Accessories chapter for additional accessories.

Coding		Order No.
	BV/SV 7.62HP K0	1937590000
Screwdriver		
	SDS 0.8X4.5X125	2749370000
Pressing tool		
	PZ 6/5	9011460000

Ordering data

Solder pin length						
Colour						black
Pitch 7.62 mm						
Poles	L1 (inch)	L2 (inch)	Qty.	Order No.		
2 / 4	7.62	0.300	3.81	0.150	72	2549310000
3 / 4	15.24	0.600	3.81	0.150	60	2549400000
3 / 6	15.24	0.600	7.62	0.300	54	2549410000
3 / 8	15.24	0.600	11.43	0.450	48	2549420000
4 / 4	22.86	0.900	3.81	0.150	48	1547560000
4 / 6	30.48	1.200	7.62	0.300	42	2549430000
4 / 8	30.48	1.200	11.43	0.450	42	2549440000
5 / 4	30.48	1.200	3.81	0.150	42	2549450000

Representative deratings curve

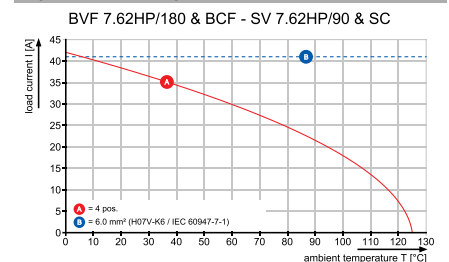

Connectors in 7.62 mm pitch
Series BV/SV 7.62 - connection up to 6 mm²

BVFL 7.62HP../180 BCF 3.81 SH



Hybrid female connector with power and signal contacts and adjustable actuator (pusher) featuring PUSH IN spring connection technology. Enables simultaneous connection of power, signals and shielding. Ideal for connecting servo and asynchronous drives. Meets the requirements of UL1059 for 600 V Use Group C. The pin arrangement guarantees more than 3 mm of touch-safety in accordance with IEC 61800-5-1. The snap-on middle flange decreases the space required by one pitch width.

The pluggable shield connection has a wide contact area on the device housing and does not need to be bolted.

Technical data

In compliance with IEC 60664-1 / IEC 61984

Clamping range, max.			
Solid core H05(07) V-U			
Stranded H07 V-R			
Flexible H05(07) V-K			
Flexible with ferrule			
Ferrule with plastic collar			
Stripping length	mm	12	
Screwdriver blade	mm	0.6 x 3.5	
According to norm			
Tightening torque range			
Rated current, max.	A	34	
At ambient temperature	20°C	40°C	
For conductor cross-section			
Overvoltage category	III	III	II
Pollution severity	3	2	2
Rated voltage	V	630	630 800
Rated impulse voltage	kV	6	6 6
UL / CUL (Use Group)	B	C	D

Rated voltage			
Rated current			
AWG conductor	AWG	-	
CSA (Use Group)	B	C	D
Rated voltage			
Rated current			
AWG conductor	AWG	-	

General data			
Type of insulation material			
UL 94 flammability rating			
Contact base material			
Material of contact surface			
Pin dimensions = d	mm		
Solder eyelet Ø = D	mm		
Solder eyelet Ø tolerance	mm		

Product data

IEC: 800 V
 UL:



For additional articles and information, refer to catalog.weidmuller.com

Note:

- Technical specifications refer to the power contacts
- Technical data of signal contacts: 50V / 5A, stripping length 8mm
- Additional variants on request
- Rated current related to rated cross-section & min. No. of poles.
- Wire end ferrule with plastic collar to DIN 46228/4
- Wire end ferrule without plastic collar to DIN 46228/1
- Rated data refer only to the component itself. Clearance and creepage distances to other components are to be designed in accordance with the relevant application standards.
- Additional pole combinations on request
- Long term storage of the product with average temperature of 50 °C and average humidity 70%, 36 months

BVFL 7.62HP../180 BCF 3.81 MF SH



Dimensioned drawing

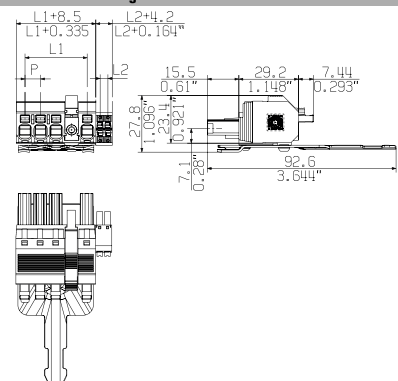

Ordering data

Solder pin length						
Colour						
Pitch	7.62 mm					
Poles	L1	(inch)	L2	(inch)	Qty.	Order No.
4 / 4	30.48	1.200	3.81	0.150	20	2427960000

Accessories

Note: Refer to the Accessories chapter for additional accessories.

Coding	Order No.
BV/SV 7.62HP K0	1937590000
Pressing tool	
PZ 6/5	9011460000
Screwdriver	
SDS 0.6X3.5X100	2749340000
Marking tags	
SCT 4.6/127 C	1699800000
WSM TOOL AUTOMATIK	1774470000

Representative dimensional drawing

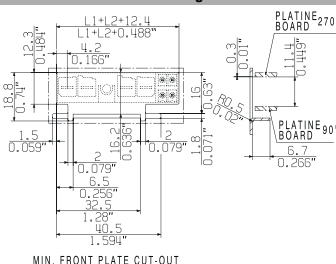

Representative deratings curve

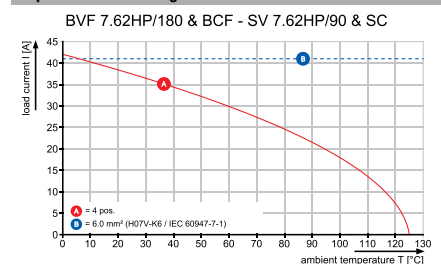

BVFL 7.62HP../180 BCF 3.81 MSF SH



**UL
600V**

Dimensioned drawing

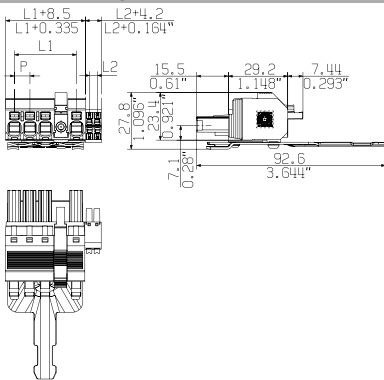

Ordering data

Solder pin length						
Colour						black
Pitch 7.62 mm						
Poles	L1	(inch)	L2	(inch)	Qty.	Order No.
4/4	30.48	1.200	3.81	0.150	20	2681770000

Connectors in 7.62 mm pitch
Series BV/SV 7.62 - connection up to 6 mm²

BVFL 7.62HP../180 BCF 3.81 SP

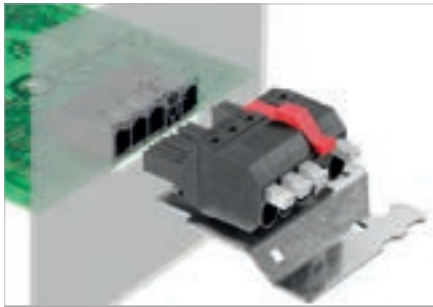

Hybrid female connector with power and signal contacts and adjustable actuator (pusher) featuring PUSH IN spring connection technology. Enables simultaneous connection of power, signals and shielding. Ideal for connecting servo and asynchronous drives. Meets the requirements of UL1059 for 600 V Use Group C. The pin arrangement guarantees more than 3 mm of touch-safety in accordance with IEC 61800-5-1. The snap-on middle flange decreases the space required by one pitch width.

The pluggable shield connection has a wide contact area on the device housing and does not need to be bolted.

Technical data

In compliance with IEC 60664-1 / IEC 61984			
Clamping range, max.	mm ²	0.5...6	
Solid core H05(07) V-U	mm²	0.5...6	
Stranded H07 V-R			
Flexible H05(07) V-K	mm ²	0.5...6	
Flexible with ferrule	mm ²	0.5...6	
Ferrule with plastic collar	mm ²	0.5...6	
Stripping length	mm	12	
Screwdriver blade	mm	0.6 x 3.5	
According to norm			
Tightening torque range			
Rated current, max.	A	38	34
At ambient temperature	20°C	40°C	
For conductor cross-section	mm ²	6	
Overvoltage category		III	III II
Pollution severity		3	2 2
Rated voltage	V	630	630 800
Rated impulse voltage	kV	6	6 6
UL / CUL (Use Group)			
Rated voltage		B	C D
Rated current			
AWG conductor	AWG		
CSA (Use Group)			
Rated voltage		B	C D
Rated current			
AWG conductor	AWG		
General data			
Type of insulation material		PA GF	
UL 94 flammability rating		V-0	
Contact base material		Copper alloy	
Material of contact surface		tinned	
Pin dimensions = d	mm		
Solder eyelet Ø = D	mm		
Solder eyelet Ø tolerance	mm		

Product data

IEC: 800 V / 38 A / 0.5 - 6 mm²
 UL:



For additional articles and information, refer to catalog.weidmuller.com

Note:

- Technical specifications refer to the power contacts
- Technical data of signal contacts: 50V / 5A, stripping length 8mm
- Additional variants on request
- Rated current related to rated cross-section & min. No. of poles.
- Wire end ferrule with plastic collar to DIN 46228/4
- Wire end ferrule without plastic collar to DIN 46228/1
- Rated data refer only to the component itself. Clearance and creepage distances to other components are to be designed in accordance with the relevant application standards.
- Additional pole combinations on request
- Long term storage of the product with average temperature of 50 °C and average humidity 70%, 36 months

BVFL 7.62HP../180MSF4 BCF SP 90



UL 600 V

Dimensioned drawing

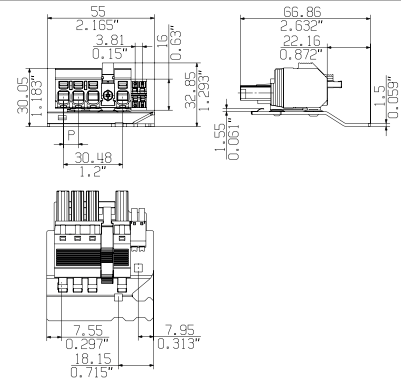

Ordering data

Solder pin length						
Colour	black					
Pitch	7.62 mm					
Poles	L1	(inch)	L2	(inch)	Qty.	Order No.
4 / 4	30.48	1.200	3.81	0.150	24	2633400000

Accessories

Note: Refer to the Accessories chapter for additional accessories.

Representative dimensional drawing

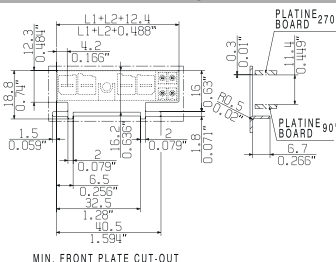

Representative deratings curve

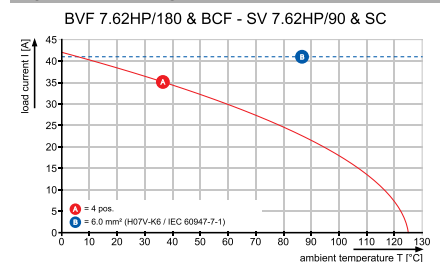

BVFL 7.62HP../180MSF4 BCF SP 150



**UL
600V**

Dimensioned drawing

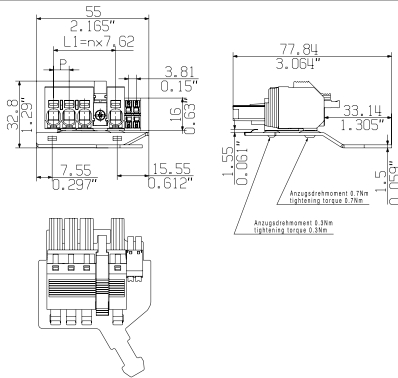

Ordering data

Solder pin length						
Colour						black
Pitch 7.62 mm						
Poles	L1	(inch)	L2	(inch)	Qty.	Order No.
4 / 4	30.48	1.200	3.81	0.150	24	2669600000

BVFL 7.62HP../180MSF4 BCF SP 180



**UL
600V**

Dimensioned drawing

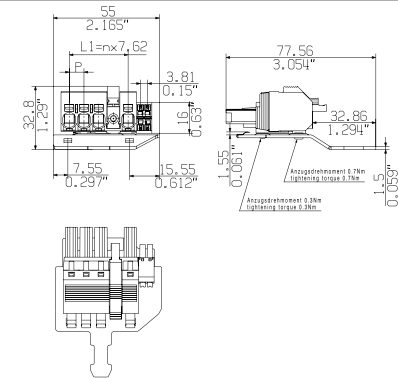

Ordering data

Solder pin length						
Colour						black
Pitch 7.62 mm						
Poles	L1	(inch)	L2	(inch)	Qty.	Order No.
4 / 4	30.48	1.200	3.81	0.150	24	2633390000

BVFL 7.62HP../180MSF4 BCF SP 210



**UL
600V**

Dimensioned drawing

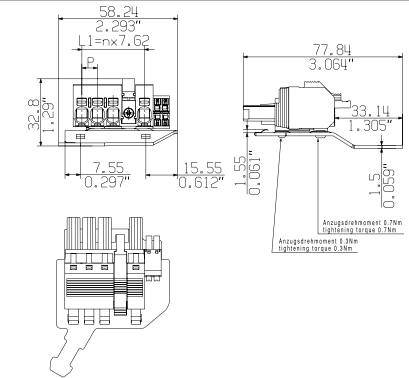

Ordering data

Solder pin length						
Colour						black
Pitch 7.62 mm						
Poles	L1	(inch)	L2	(inch)	Qty.	Order No.
4 / 4	30.48	1.200	3.81	0.150	14	2669620000

Connectors in 7.62 mm pitch
Series BV/SV 7.62 - connection up to 6 mm²

BVFL 7.62HP/./180 BCF 3.81 MF

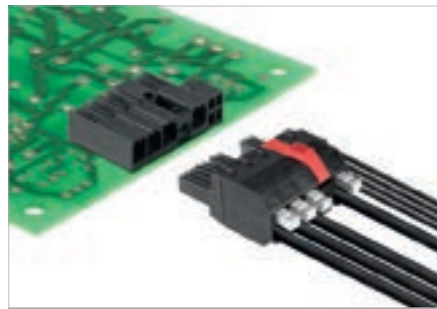

Hybrid female connector with power and signal contacts and adjustable actuator (pusher) featuring PUSH IN spring connection technology. Enables simultaneous connection of power, signals and shielding. Ideal for connecting servo and asynchronous drives. Meets the requirements of UL1059 for 600 V Use Group C. The pin arrangement guarantees more than 3 mm of touch-safety in accordance with IEC 61800-5-1. The snap-on middle flange decreases the space required by one pitch width.

Technical data

In compliance with IEC 60664-1 / IEC 61984			
Clamping range, max.	mm ²	0.5...6	
Solid core H05(07) V-U	mm²	0.5...6	
Stranded H07 V-R			
Flexible H05(07) V-K	mm ²	0.5...6	
Flexible with ferrule	mm ²	0.5...6	
Ferrule with plastic collar	mm ²	0.5...6	
Stripping length	mm	12	
Screwdriver blade	mm	0.6 x 3.5	
According to norm			
Tightening torque range			
Rated current, max.	A	38	34
At ambient temperature	20°C		40°C
For conductor cross-section	mm ²	6	
Overvoltage category		III	III II
Pollution severity		3	2 2
Rated voltage	V	800	1000 1000
Rated impulse voltage	kV	8	8 6
UL / CUL (Use Group)		B	C D
Rated voltage	V	600	600 600
Rated current	A	35	35 5
AWG conductor	AWG		24-8
CSA (Use Group)		B	C D
Rated voltage	V		
Rated current	A		
AWG conductor	AWG		
General data			
Type of insulation material		PA GF	
UL 94 flammability rating		V-0	
Contact base material		Copper alloy	
Material of contact surface		tinned	
Pin dimensions = d	mm		
Solder eyelet Ø = D	mm		
Solder eyelet Ø tolerance	mm		

Product data

IEC: 1000 V / 38 A / 0.5 - 6 mm²
 UL: 600 V / 35 A / AWG 24 - 8



For additional articles and information, refer to catalog.weidmuller.com

Note:

- Technical specifications refer to the power contacts
- Technical data of signal contacts: 50V / 5A, stripping length 8mm
- Additional variants on request
- Rated current related to rated cross-section & min. No. of poles.
- Wire end ferrule with plastic collar to DIN 46228/4
- Wire end ferrule without plastic collar to DIN 46228/1
- Rated data refer only to the component itself. Clearance and creepage distances to other components are to be designed in accordance with the relevant application standards.
- Additional pole combinations on request
- Long term storage of the product with average temperature of 50 °C and average humidity 70%, 36 months

BVFL 7.62HP/./180 BCF 3.81 MF2



Dimensioned drawing

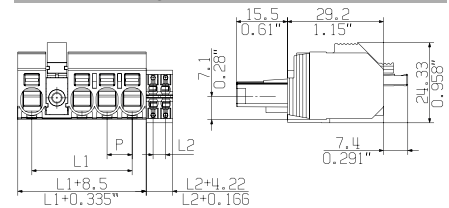

Accessories

Note: Refer to the Accessories chapter for additional accessories.

Coding	Order No.
BV/SV 7.62HP K0	1937590000
Shielding	
BVF 7.62HP SH150 4-6 KIT	1118480000
BVF 7.62HP SH180 4-6 KIT	1118470000
BVF 7.62HP SH210 4-6 KIT	1118490000
Pressing tool	
PZ 6/5	9011460000
Screwdriver	
SDS 0.6X3.5X100	2749340000
SDS 0.8X4.5X125	

Ordering data

Solder pin length						
Colour						black
Pitch 7.62 mm						
Poles	L1 (inch)	L2 (inch)	Qty.	Order No.		
2 / 4	15.24	0.600	3.81	0.150	60	2549320000
2 / 6	15.24	0.600	7.62	0.300	54	2628330000
2 / 8	15.24	0.600	11.43	0.450	48	2628690000
3 / 4	22.86	0.900	3.81	0.150	48	2628720000
3 / 6	22.86	0.900	7.62	0.300	42	2628730000
3 / 8	22.86	0.900	11.43	0.450	42	2628740000
4 / 4	30.48	1.200	3.81	0.150	42	2628780000
4 / 6	30.48	1.200	7.62	0.300	36	2628790000
4 / 8	30.48	1.200	11.43	0.450	36	2628800000
5 / 4	38.10	1.500	3.81	0.150	36	2628840000
5 / 6	38.10	1.500	7.62	0.300	30	2628850000
5 / 8	38.10	1.500	11.43	0.450	30	2628860000

Representative deratings curve

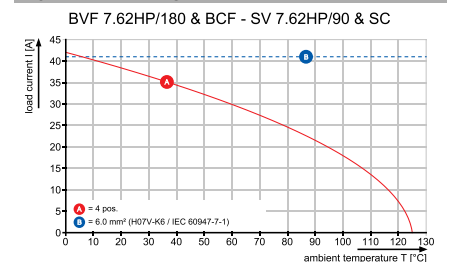

BVFL 7.62HP../180 BCF 3.81 MF3



Dimensioned drawing

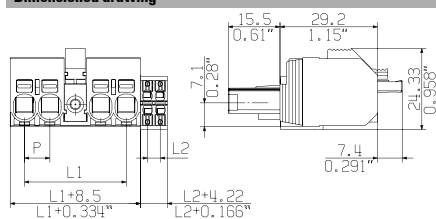

BVFL 7.62HP../180 BCF 3.81 MF4



Dimensioned drawing

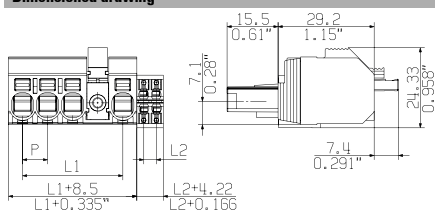

Ordering data

Solder pin length						
Colour						black
Pitch 7.62 mm						
Poles	L1	(inch)	L2	(inch)	Qty.	Order No.
3/4	22.86	0.900	3.81	0.150	48	2549460000
3/6	22.86	0.900	7.62	0.300	42	2549470000
3/8	22.86	0.900	11.43	0.450	42	2549480000
4/4	30.48	1.200	3.81	0.150	42	2628900000
4/6	30.48	1.200	7.62	0.300	36	2628910000
4/8	30.48	1.200	11.43	0.450	36	2628920000
5/4	38.10	1.500	3.81	0.150	36	2628960000
5/6	38.10	1.500	7.62	0.300	30	2628970000
5/8	38.10	1.500	11.43	0.450	30	2628980000

Ordering data

Solder pin length						
Colour						black
Pitch 7.62 mm						
Poles	L1	(inch)	L2	(inch)	Qty.	Order No.
4/4	30.48	1.200	3.81	0.150	24	1547590000
4/6	30.48	1.200	7.62	0.300	36	2549490000
4/8	30.48	1.200	11.43	0.450	36	2549500000
5/4	38.10	1.500	3.81	0.150	36	2549510000
5/6	38.10	1.500	7.62	0.300	30	2549520000
5/8	38.10	1.500	11.43	0.450	30	2549530000

Additional pole combinations on request

Connectors in 7.62 mm pitch
Series BV/SV 7.62 - connection up to 6 mm²

BVFL 7.62HP/./180 BCF 3.81 MSF

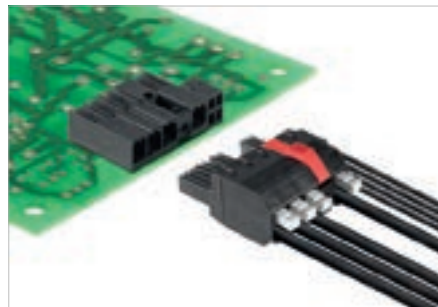

Hybrid female connector with power and signal contacts and adjustable actuator (pusher) featuring PUSH IN spring connection technology. Enables simultaneous connection of power, signals and shielding. Ideal for connecting servo and asynchronous drives. Meets the requirements of UL1059 for 600 V Use Group C. The pin arrangement guarantees more than 3 mm of touch-safety in accordance with IEC 61800-5-1. The snap-on middle flange decreases the space required by one pitch width.

Product data

IEC: 1000 V / 38 A / 0.5 - 6 mm²
 UL: 600 V / 35 A / AWG 24 - 8



For additional articles and information, refer to catalog.weidmuller.com

Note:

- Technical specifications refer to the power contacts
- Technical data of signal contacts: 50V / 5A, stripping length 8mm
- Additional variants on request
- Rated current related to rated cross-section & min. No. of poles.
- Wire end ferrule with plastic collar to DIN 46228/4
- Wire end ferrule without plastic collar to DIN 46228/1
- Rated data refer only to the component itself. Clearance and creepage distances to other components are to be designed in accordance with the relevant application standards.
- Additional pole combinations on request
- Long term storage of the product with average temperature of 50 °C and average humidity 70%, 36 months

BVFL 7.62HP/./180 BCF 3.81 MSF2



Dimensioned drawing

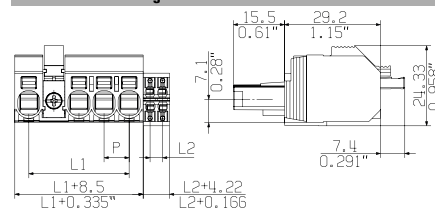

Technical data

In compliance with IEC 60664-1 / IEC 61984			
Clamping range, max.	mm ²	0.5...6	
Solid core H05(07) V-U	mm²	0.5...6	
Stranded H07 V-R			
Flexible H05(07) V-K	mm ²	0.5...6	
Flexible with ferrule	mm ²	0.5...6	
Ferrule with plastic collar	mm ²	0.5...6	
Stripping length	mm	12	
Screwdriver blade	mm	0.6 x 3.5	
According to norm			
Tightening torque range			
Rated current, max.	A	38	34
At ambient temperature		20°C	40°C
For conductor cross-section	mm ²	6	
Overvoltage category		III	III II
Pollution severity		3	2 2
Rated voltage	V	800	1000 1000
Rated impulse voltage	kV	8	8 6
UL / CUL (Use Group)		B	C D
Rated voltage	V	600	600 600
Rated current	A	35	35 5
AWG conductor	AWG		24-8
CSA (Use Group)		B	C D
Rated voltage	V		
Rated current	A		
AWG conductor	AWG		
General data			
Type of insulation material		PA GF	
UL 94 flammability rating		V-0	
Contact base material		Copper alloy	
Material of contact surface		tinned	
Pin dimensions = d	mm		
Solder eyelet Ø = D	mm		
Solder eyelet Ø tolerance	mm		

Accessories

Note: Refer to the Accessories chapter for additional accessories.

Coding		Order No.
	BV/SV 7.62HP K0	1937590000
Shielding		
	BVF 7.62HP SH150 4-6 KIT	1118480000
	BVF 7.62HP SH180 4-6 KIT	1118470000
	BVF 7.62HP SH210 4-6 KIT	1118490000
Pressing tool		
	PZ 6/5	9011460000
Screwdriver		
	SDS 0.6X3.5X100	2749340000
	SDS 0.8X4.5X125	

Ordering data

Solder pin length						
Colour						black
Pitch 7.62 mm						
Poles	L1 (inch)	L2 (inch)	Qty.	Order No.		
2 / 4	15.24	0.600	3.81	0.150	60	2549330000
2 / 6	15.24	0.600	7.62	0.300	54	2629020000
2 / 8	15.24	0.600	11.43	0.450	48	2629030000
3 / 4	22.86	0.900	3.81	0.150	48	2629060000
3 / 6	22.86	0.900	7.62	0.300	42	2629070000
3 / 8	22.86	0.900	11.43	0.450	42	2629080000
4 / 4	30.48	1.200	3.81	0.150	42	2629120000
4 / 6	30.48	1.200	7.62	0.300	36	2629130000
4 / 8	30.48	1.200	11.43	0.450	36	2629140000
5 / 4	38.10	1.500	3.81	0.150	36	2629180000
5 / 6	38.10	1.500	7.62	0.300	30	2629190000
5 / 8	38.10	1.500	11.43	0.450	30	2629200000

Representative deratings curve

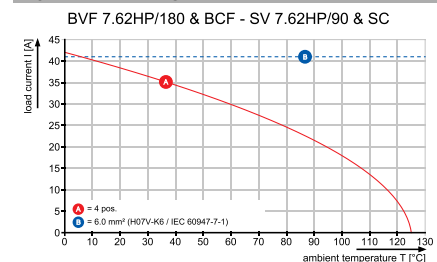

BVFL 7.62HP../180 BCF 3.81 MSF3



Dimensioned drawing

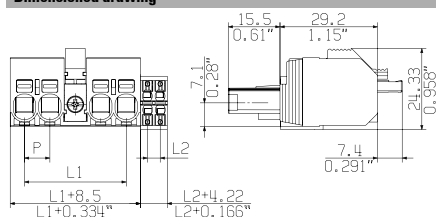

BVFL 7.62HP../180 BCF 3.81 MSF4



Dimensioned drawing

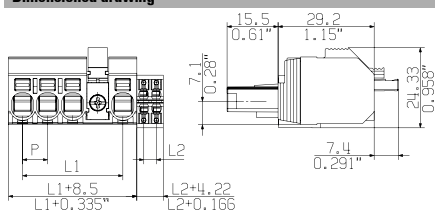

Ordering data

Solder pin length						
Colour						black
Pitch 7.62 mm						
Poles	L1	(inch)	L2	(inch)	Qty.	Order No.
3/4	22.86	0.900	3.81	0.150	48	2549540000
3/6	22.86	0.900	7.62	0.300	42	2549550000
3/8	22.86	0.900	11.43	0.450	42	2549560000
4/4	30.48	1.200	3.81	0.150	42	2629240000
4/6	30.48	1.200	7.62	0.300	36	2629250000
4/8	30.48	1.200	11.43	0.450	36	2629260000
5/4	38.10	1.500	3.81	0.150	36	2629300000
5/6	38.10	1.500	7.62	0.300	30	2629310000
5/8	38.10	1.500	11.43	0.450	30	2629320000

Ordering data

Solder pin length						
Colour						black
Pitch 7.62 mm						
Poles	L1	(inch)	L2	(inch)	Qty.	Order No.
4/4	30.48	1.200	3.81	0.150	42	1547600000
4/6	30.48	1.200	7.62	0.300	36	2549570000
4/8	30.48	1.200	11.43	0.450	36	2549580000
5/4	38.10	1.500	3.81	0.150	36	2549590000
5/6	38.10	1.500	7.62	0.300	30	2549600000
5/8	38.10	1.500	11.43	0.450	30	2549610000

Additional pole combinations on request

OMNIMATE® Power for IT systems - scalable from 25 A to 76 A

Custom-fit solutions for special requirements

Increased compliance with standards and fewer compromises: OMNIMATE® Power for IT systems establishes a new level of excellence with its standard integrated details. These attributes streamline the design-in and approval processes and result in safer operations.

Results for the application and advantages for the user: unlimited use in 400-V IT systems and touch safety according to IEC 61800-5-1 (+ 5 mm). The self-snapping one-handed safety flange enables intuitive and safe usage. Operational reliability is guaranteed by the automatic interlock feature during the plug-in process. The application-oriented design means that no compromises are necessary during the approval process.

Uncompromised scalability

As much power as required, as little cost as needed: a device series for every power level and power type: scalable from 25 A/2.5 mm² to 41 A/6 mm² to 76 A/16 mm².



IEC 61800-5-1 approval

No additional measures or compromises in the system suitable, touch-safe certification according to IEC 61800-5-1:
+ 3.0 mm for 400 V TN systems,
+ 5.5 mm for 400 V IT networks.

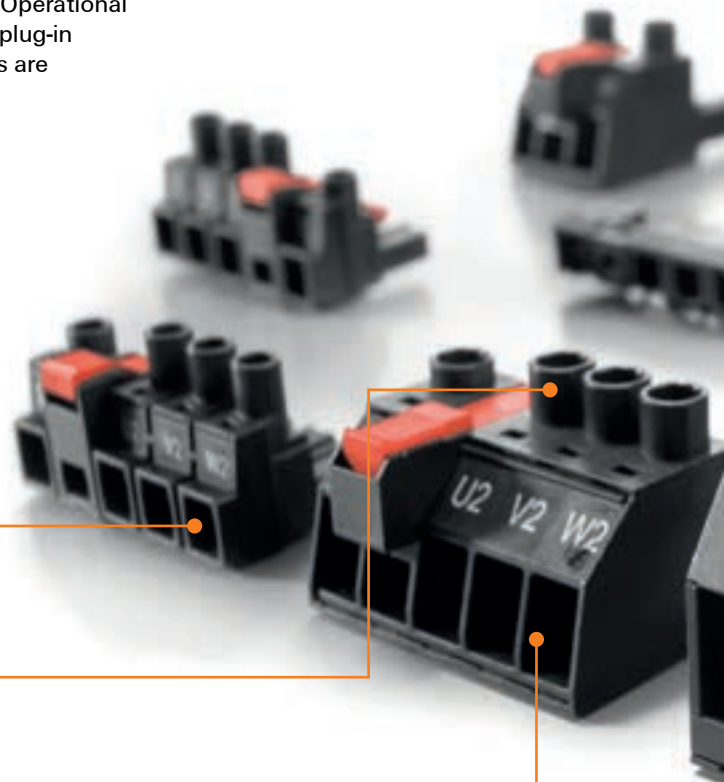

Uncompromised power capabilities

Uncompromised means high power reserves for superior overload capacity even under the high ambient temperatures of real-world applications.

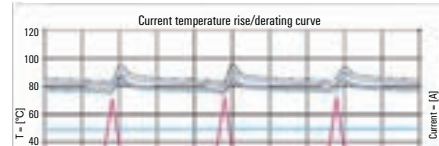
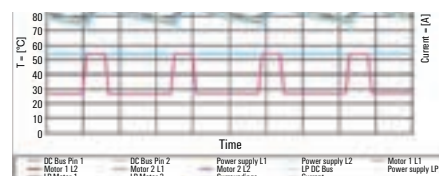

Uncompromised safety

Details such as insulated contact tips that ensure the pin header is touch-safe and automatic snap-in for a secure interlocking connection.

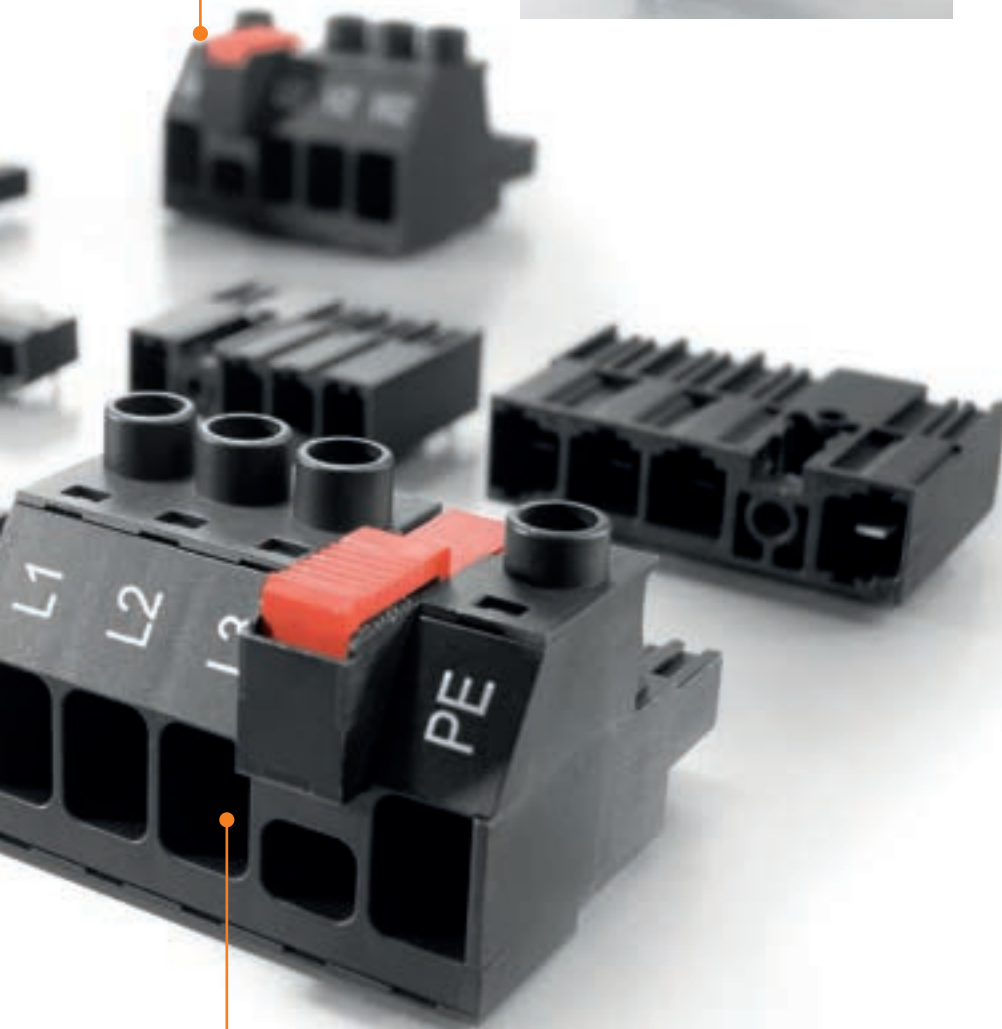
**UL approval without compromise**

No limitation for UL approval with 600-V applications: with optimised creepage and clearance distance even under difficult installation situations.

600 V
Finger safety according to DIN EN 61800-5-1

Since the end of 2007, device approval according to IEC Directive "Adjustable speed electrical power drive systems – Part 5-1: Safety requirements" requires that – regardless of the line-to-earth voltage – an additional finger safety interval exists (for example, + 3 mm for 400 V-TN systems (wire-to-earth voltage = 230 V), or + 5.5 mm for 400-V IT systems (wire-to-earth voltage up to 400 V in event of error)). An additional cover is required if the connection system, as a device section, does not fulfil these requirements. The OMNIMATE® Power HP product line already complies with the stricter IEC requirements for additional touch protection.

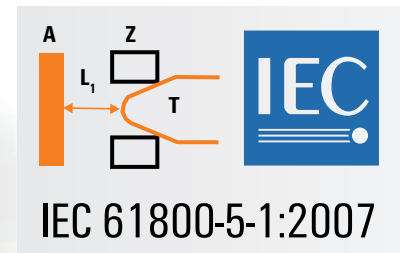
**Clearance and creepage distances, acc. to UL**

A 600-V connector must have the approval of the UL 1059 component directive – but the potential installation situations must first be taken into consideration. This allows you to avoid making approval compromises – such as UL 508C or incorporating complex additions such as coatings or protective hoods. The OMNIMATE® Power HP product line already complies with the UL requirements for 600-V creepage and clearance distances.

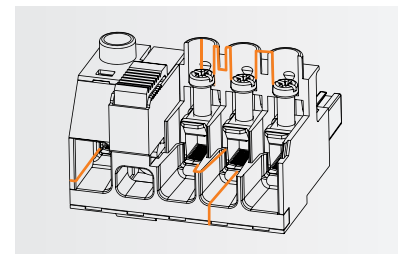

Secure and efficient connection of power electronics devices

PUSH IN connector with wire-ready function

High power applications necessitate connection by wires with huge cross sections, which are typically inflexible. Large PUSH IN connections are therefore difficult to plug in. Special tools are often needed for installation in narrow areas or for wiring with flexible wires without ferrules.

BUF 10.16 facilitates and accelerates this process and does not require additional tools. The operating lever which can be locked in the open position (pusher) makes it possible to insert conductors with short cladding or rigid insulation into the open terminal. This means that the proven PUSH IN function remains unrestricted while the terminal point, fixed in an open position, allows a comfortable and easy connection under difficult conditions. The result is a noticeable saving of time.

Easy installation

PUSH IN technology with open position fixed clamping point for easy wiring of flexible wires without ferrules and wires with rigid insulation.

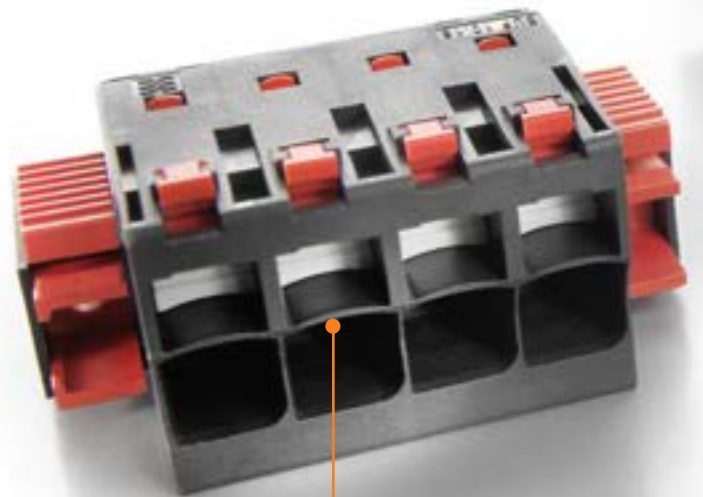

Easy one hand operation

Automatic locking by a centre flange with detent fixing and optional screw fixing.

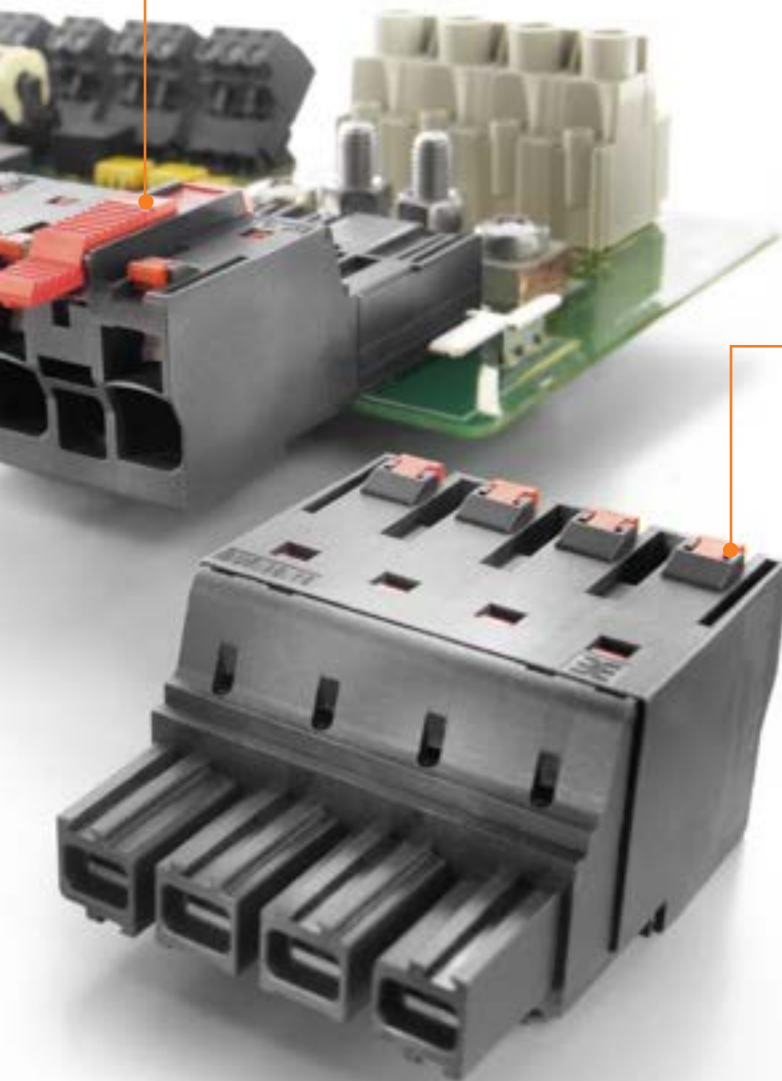
**Fast wiring**

The PUSH IN connection system allows tool-free connection of solid wires or wires with ferrules.

**Your special advantages**

- PUSH IN-technology with open position fixed clamping point
- Tool-free wiring of flexible wires without ferrules and wires with rigid insulation
- Easy one-hand operation of the connector
- Automatic locking by a centre flange with detent fixing and optional screw fixing



Webcode: # 11407

Contact protection and EMC shielding for power electronics

OMNIMATE® Power connectors with a pluggable shielding plate

P

For power electronics devices, and in particular for drive technology, the device outputs generally need touch protection. Thereby, the contacting of the EMC shield support must be ensured, e.g. on servo drives or frequency inverters. For devices with a plastic housing in the front area, the shield support is considerably more difficult to contact.

Our new OMNIMATE® power connectors and pin headers feature a pluggable shield support with special EMC spring contact strip. This enables the large-area, permanent and vibration-proof shield connection to the device housing. Thanks to finger safety on both sides of the male and female connectors, this solution is also suitable for applications with reverse voltage.

Your special advantages:

- Contact of the EMC shielding to the metal housing of the device directly when plugging in
- Reliable locking with screw flange or central flange locking
- Variable cable shielding outlet directions for easy device integration and adaptation to various housing formats

Easy device integration



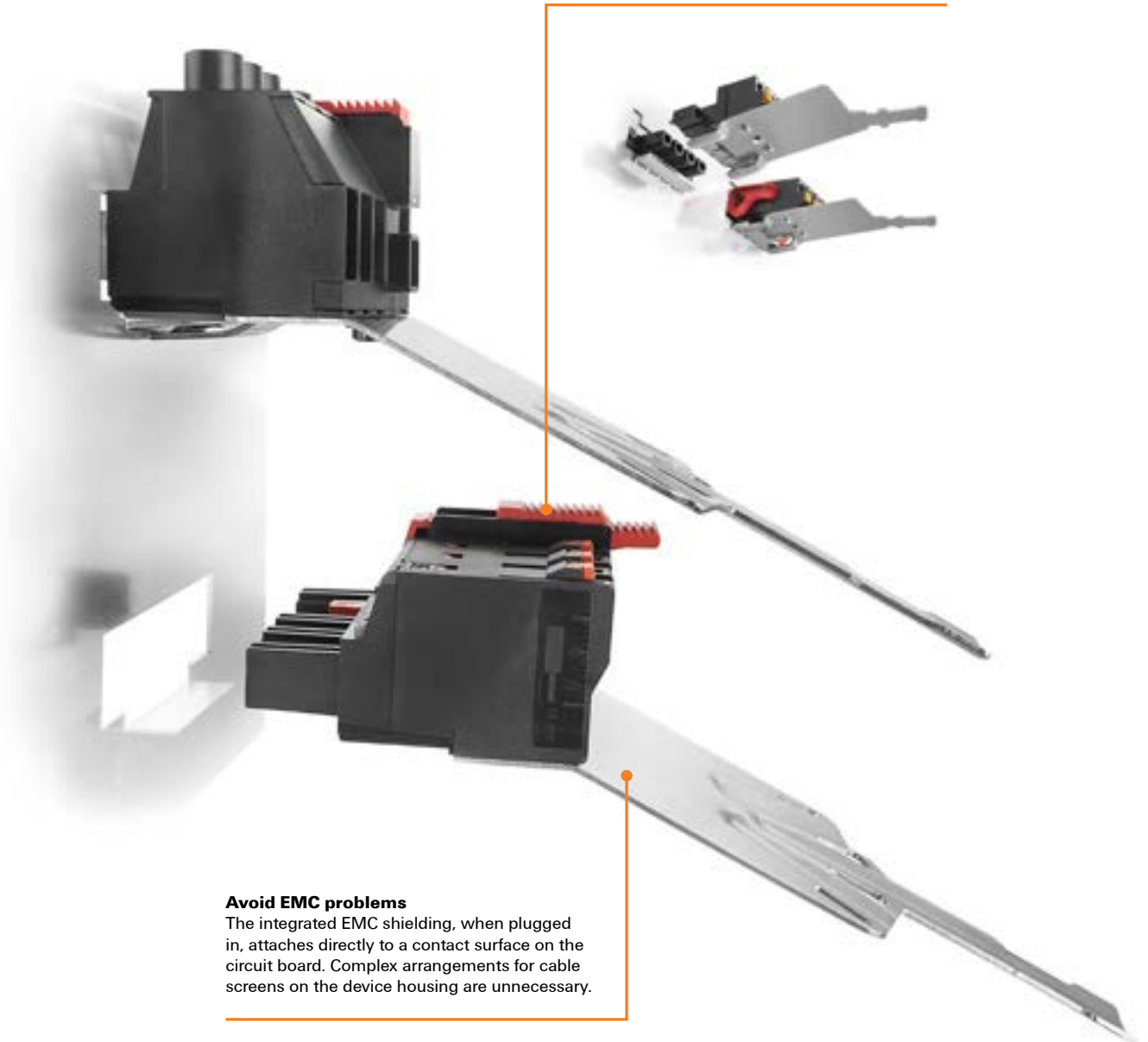

Versions with straight or angled cable shield outlet at the connector allow variable integration. The screwable central flange lock ensures a secure and durable attachment to the device.

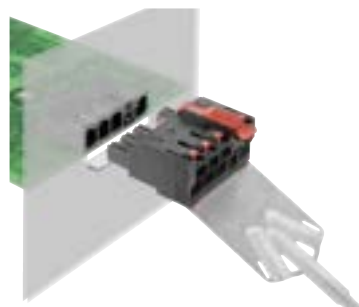
**Avoid EMC problems**

The integrated EMC shielding, when plugged in, attaches directly to a contact surface on the circuit board. Complex arrangements for cable screens on the device housing are unnecessary.



<http://www.OMNIMATE.net>

-  = Wire-to-Board
-  = Board-to-Board
-  = Wire-to-Wire
-  = Board-to-Wire

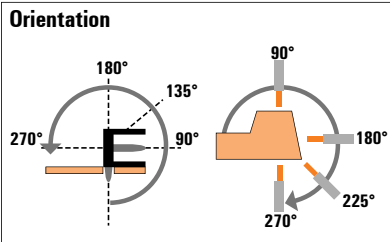
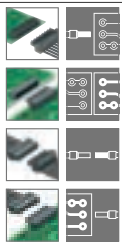



Pitch 7.62 mm



For IT networks



Type	SL	SL
Orientation	90°	90°
Flange options	MF2	MF3
Product code numbers	IEC: 630 V/24 A UL: 300 V/20 A	IEC: 630 V/24 A UL: 300 V/20 A

Type	Orientation	Flange options	Product code numbers	
			IEC: 630 V/24 A UL: 300 V/20 A	IEC: 630 V/24 A UL: 300 V/20 A
 BLZ	180°	MF2	IEC: 630 V/24 A/0.08 - 4 mm ² UL: 600 V/20 A/AWG 28 - 12	 
 BLZ	180°	MF3	IEC: 630 V/24 A/0.08 - 4 mm ² UL: 600 V/20 A/AWG 28 - 12	 
 BLZ	180°	MF4	IEC: 630 V/24 A/0.08 - 4 mm ² UL: 600 V/20 A/AWG 28 - 12	
 BVZ	180°	MF2	IEC: 1.000 V/41 A/0.2 - 6 mm ² UL: 600 V/40.5 A/AWG 24 - 8	
 BVZ	180°	MF3	IEC: 1.000 V/41 A/0.2 - 6 mm ² UL: 600 V/40.5 A/AWG 24 - 8	
 BVZ	180°	MF4	IEC: 1.000 V/41 A/0.2 - 6 mm ² UL: 600 V/40.5 A/AWG 24 - 8	
 BUZ	180°	MF2	IEC: 1.000 V/76 A/0.2 - 16 mm ² UL: 600 V/60 A/AWG 22 - 4	
 BUZ	180°	MF3	IEC: 1.000 V/76 A/0.2 - 16 mm ² UL: 600 V/60 A/AWG 22 - 4	
 BUZ	180°	MF4	IEC: 1.000 V/76 A/0.2 - 16 mm ² UL: 600 V/60 A/AWG 22 - 4	
 BUZ SH	180°	MF2	IEC: 1.000 V/76 A/0,2 - 16 mm ² UL: 600 V/60 A/AWG 22 - 4	
 BUZ SH	180°	MF3	IEC: 1.000 V/76 A/0,2 - 16 mm ² UL: 600 V/60 A/AWG 22 - 4	
 BUZ SH	180°	MF4	IEC: 1.000 V/76 A/0,2 - 16 mm ² UL: 600 V/60 A/AWG 22 - 4	

MF2 = Centre snap flange at position 2
MF3 = Centre snap flange at position 3
MF4 = Centre snap flange at position 4

Female plug

Screw Clamping yoke

Male header



Solder connection





Pitch 7.62 mm

Pitch 10.16 mm



	SL	SV	SV	SV	SU	SU	SU
	90°	90° / 270°	90° / 270°	90° / 270°	90° / 270°	90° / 270°	90° / 270°
	MF4	MF2	MF3	MF4	MF2	MF3	MF4
	IEC: 630 V/24 A UL: 300 V/20 A	IEC: 1.000 V/41 A UL: 300 V/35 A	IEC: 1.000 V/41 A UL: 300 V/35 A	IEC: 1.000 V/41 A UL: 300 V/35 A	IEC: 1.000 V/76 A UL: 300 V/54 A	IEC: 1.000 V/76 A UL: 300 V/54 A	IEC: 1.000 V/76 A UL: 300 V/54 A
	○ ●						
		○ ●					
			○ ●				
				○ ●			
					○ ●		
						○ ●	
					○ ●		○ ●
						○ ●	
							○ ●

<http://www.OMNIMATE.net>

-  = Wire-to-Board
-  = Board-to-Board
-  = Wire-to-Wire
-  = Board-to-Wire

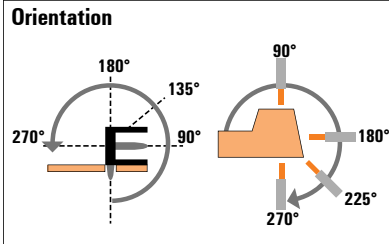
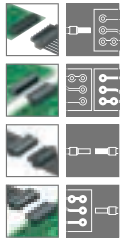







Pitch 7.62 mm



For IT networks



Type	Orientation		SL	SL
	Flange options		MF2	MF3
	Product code numbers		IEC: 630 V/24 A UL: 300 V/20 A	IEC: 630 V/24 A UL: 300 V/20 A
 Spring PUSH IN		BUF 180° MF2	IEC: 1.000 V/76 A/0,2 - 16 mm ² UL: 600 V/55 A/AWG 22 - 6	
		BUF 180° MF3	IEC: 1.000 V/76 A/0,2 - 16 mm ² UL: 600 V/55 A/AWG 22 - 6	
		BUF 180° MF4	IEC: 1.000 V/76 A/0,2 - 16 mm ² UL: 600 V/55 A/AWG 22 - 6	
		BUF SH 180° MF2	IEC: 1.000 V/76 A/0,2 - 16 mm ² UL: 600 V/55 A/AWG 22 - 6	
		BUF SH 180° MF3	IEC: 1.000 V/76 A/0,2 - 16 mm ² UL: 600 V/55 A/AWG 22 - 6	
		BUF SH 180° MF4	IEC: 1.000 V/76 A/0,2 - 16 mm ² UL: 600 V/55 A/AWG 22 - 6	

MF2 = Centre snap flange at position 2
MF3 = Centre snap flange at position 3
MF4 = Centre snap flange at position 4

Male header



Solder connection

Pitch 7.62 mm

Pitch 10.16 mm



	SL	SV	SV	SV	SU	SU	SU
	90°	90° / 270°	90° / 270°	90° / 270°	90° / 270°	90° / 270°	90° / 270°
	MF4	MF2	MF3	MF4	MF2	MF3	MF4
	IEC: 630 V/24 A UL: 300 V/20 A	IEC: 1.000 V/41 A UL: 300 V/35 A	IEC: 1.000 V/41 A UL: 300 V/35 A	IEC: 1.000 V/41 A UL: 300 V/35 A	IEC: 1.000 V/76 A UL: 300 V/54 A	IEC: 1.000 V/76 A UL: 300 V/54 A	IEC: 1.000 V/76 A UL: 300 V/54 A
					○ ●		
						○ ●	
							○ ●
					○ ●		
						○ ●	
							○ ●

Connectors for IT power networks, pitch 7.62 mm
BL/SL 7.62 IT series - connection up to 4 mm²

SL 7.62IT/./90MF

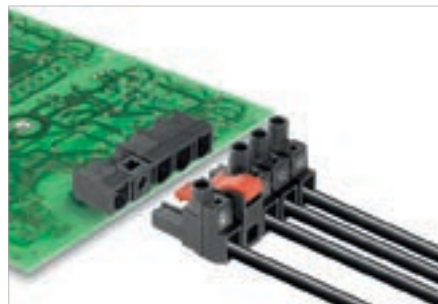

Male header available with 90° outlet direction and an optional solder flange attachment for IT power networks. UL approval in accordance with UL840 for 600 V with leading contact. In conjunction with the female plug BLZ 7.62 IT, meets the enhanced requirements for 5.5 mm touch-safety for IT power networks in acc. with IEC 61800-5-1 for 400 V relative to earth. When no female plug is present, the mating profile ensures that at least >1 mm of finger safety is present with a finger pressure of 20 N.

The middle-flange interlock feature decreases the space required by one pitch width compared to other standard solutions.

Available on request with screw flange mounting block or without flange.

Technical data

In compliance with IEC 60664-1 / IEC 61984			
Clamping range, max.			
Solid core H05(07) V-U			
Stranded H07 V-R			
Flexible H05(07) V-K			
Flexible with ferrule			
Ferrule with plastic collar			
Stripping length			
Screwdriver blade	mm		
According to norm			
Tightening torque range			
Rated current, max.	A	29	25
At ambient temperature		20°C	40°C
For conductor cross-section			
Overtoltage category		III	III II
Pollution severity		3	2 2
Rated voltage	V	400	500 630
Rated impulse voltage	kV	6	6 6
UL / CUL (Use Group)		B	C D
Rated voltage	V	300	300 600
Rated current	A	20	20 5
AWG conductor	AWG		-
CSA (Use Group)		B	C D
Rated voltage	V	300	300 600
Rated current	A	20	20 5
AWG conductor	AWG		-
General data			
Type of insulation material		PBT GF	
UL 94 flammability rating		V-0	
Contact base material		Copper alloy	
Material of contact surface		tinned	
Pin dimensions = d	mm	1.0 x 1.0	
Solder eyelet Ø = D	mm	1.3	
Solder eyelet Ø tolerance	mm	+ 0,1	

Product data

IEC: 630 V / 29 A
 UL: 300 V / 20 A



For additional articles and information, refer to catalog.weidmueller.com

Note:

- Additional variants on request
- Gold-plated contact surfaces on request
- Rated current related to rated cross-section & min. No. of poles.
- P on drawing = pitch
- Rated data refer only to the component itself. Clearance and creepage distances to other components are to be designed in accordance with the relevant application standards.
- MFX and MSFX: X= Position of the middle flange e.g. MF2, MSF3
- Long term storage of the product with average temperature of 50 °C and average humidity 70%, 36 months

SL 7.62IT/./90MF2



Dimensioned drawing

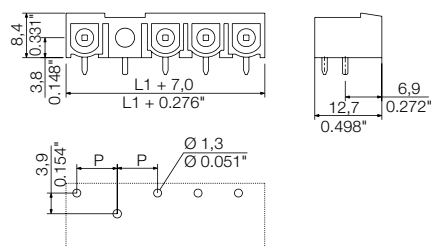

Accessories

Note: Refer to the Accessories chapter for additional accessories.

Coding	Order No.
BLZ/SL KO OR BX	1573010000
BLZ/SL KO BK BX	1545710000

Ordering data

Solder pin length		3.2 mm		
Colour		black		
Pitch		7.62 mm		
Pol.	L1	(inch)	Qty.	Order No.
2	15.24	0.600	84	1173610000
3	22.86	0.900	60	1173640000
4	30.48	1.200	48	1173730000
5	38.10	1.500	36	2629360000
6	45.72	1.800	30	2629480000

SL 7.62IT../90MF3



Dimensioned drawing

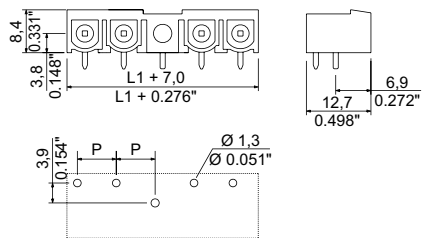

SL 7.62IT../90MF4



Dimensioned drawing

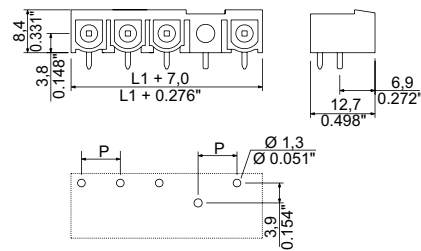

Ordering data

Solder pin length		3.2 mm			
Colour		black			
Pitch		7.62 mm			
Pol.	L1	(inch)	Qty.	Order No.	
3	22.86	0.900	60	1173690000	
4	30.48	1.200	48	2629490000	
5	38.10	1.500	36	1398820000	
6	45.72	1.800	30	1398840000	

Ordering data

Solder pin length		3.2 mm			
Colour		black			
Pitch		7.62 mm			
Pol.	L1	(inch)	Qty.	Order No.	
4	30.48	1.200	48	1173770000	
5	38.10	1.500	36	1398830000	
6	45.72	1.800	30	2629500000	

Connectors for IT power networks, pitch 7.62 mm
BL/SL 7.62 IT series - connection up to 4 mm²

BLZ 7.62IT../180MF

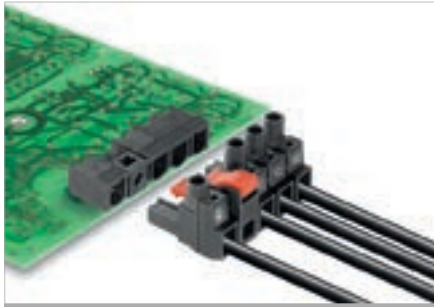

Female plug with 180° outlet direction for IT power networks. Meets the requirements of UL1059 for 600 V Use Group C. Leading contact in conjunction with the male header SL 7.62 IT. Meets the enhanced requirements for 5.5 mm touch-safety for IT power networks in acc. with IEC 61800-5-1 for 400 V relative to earth.

The self-snapping middle flange, which is optionally available with an additional fastening screw, decreases the space required by one pitch width compared to other standard solutions.

Optionally available without middle flange interlock

Technical data

In compliance with IEC 60664-1 / IEC 61984			
Clamping range, max.	mm ²	0.08...4	
Solid core H05(07) V-U	mm²	0.08...4	
Stranded H07 V-R			
Flexible H05(07) V-K	mm ²	0.08...4	
Flexible with ferrule	mm ²	0.2...2.5	
Ferrule with plastic collar	mm ²	0.2...2.5	
Stripping length	mm	7	
Screwdriver blade	mm	0.6 x 3.5	
According to norm		DIN 5264	
Tightening torque range	Nm	0.4...0.5	
Rated current, max.	A	29	25
At ambient temperature		20°C	40°C
For conductor cross-section	mm ²	2.5	
Overtoltage category		III	III II
Pollution severity		3	2 2
Rated voltage	V	400	500 630
Rated impulse voltage	kV	6	6 4
UL / CUL (Use Group)	B C D	B C D	
Rated voltage	V	600	600 600
Rated current	A	20	20 5
AWG conductor	AWG	20-12	
CSA (Use Group)	B C D	B C D	
Rated voltage	V	600	600 600
Rated current	A	20	20 5
AWG conductor	AWG	20-12	
General data			
Type of insulation material		PBT	
UL 94 flammability rating		V-0	
Contact base material		Copper alloy	
Material of contact surface		tinned	
Pin dimensions = d	mm		
Solder eyelet Ø = D	mm		
Solder eyelet Ø tolerance	mm		

Product data

IEC: 630 V / 29 A / 0.08 - 4 mm²
 UL: 600 V / 20 A / AWG 20 - 12



For additional articles and information, refer to catalog.weidmuller.com

Note:

- Additional variants on request
- Gold-plated contact surfaces on request
- Rated current related to rated cross-section & min. No. of poles.
- Wire end ferrule without plastic collar to DIN 46228/1
- Wire end ferrule with plastic collar to DIN 46228/4
- P on drawing = pitch
- Rated data refer only to the component itself. Clearance and creepage distances to other components are to be designed in accordance with the relevant application standards.
- Long term storage of the product with average temperature of 50 °C and average humidity 70%, 36 months

BLZ 7.62IT../180MF2



Dimensioned drawing

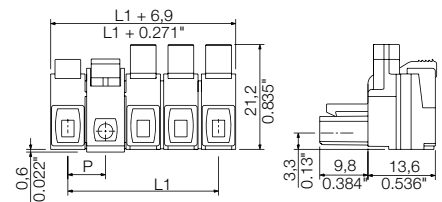

7.62

180°

4 mm²

Accessories

Note: Refer to the Accessories chapter for additional accessories.

Coding	Order No.
BLZ/SL KO OR BX	1573010000
BLZ/SL KO BK BX	1545710000
Screwdriver	
SDS 0.6X3.5X100	2749340000
SDIS 0.6X3.5X100	2749810000

Ordering data

Solder pin length				
Colour	black			
Pitch	7.62 mm			
Pol.	L1	(inch)	Qty.	Order No.
2	15.24	0.600	70	1173490000
3	22.86	0.900	50	1173500000
4	30.48	1.200	40	1173520000
5	38.10	1.500	50	2629690000
6	45.72	1.800	50	2629740000

Representative deratings curve

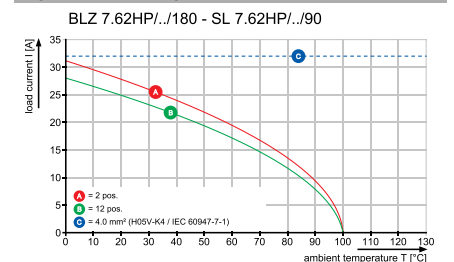

BLZ 7.62IT../180MF3



Dimensioned drawing

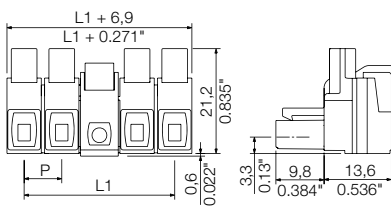

BLZ 7.62IT../180MF4



Dimensioned drawing

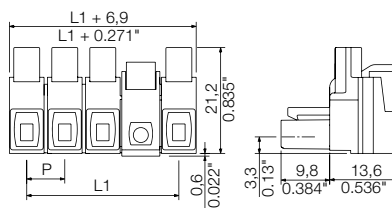

Ordering data

Solder pin length					
Colour					black
Pitch 7.62 mm					
Pol.	L1	(inch)	Qty.	Order No.	
3	22.86	0.900	50	1173510000	
4	30.48	1.200	40	2629750000	
5	38.10	1.500	30	1398880000	
6	45.72	1.800	25	1398900000	

Ordering data

Solder pin length					
Colour					black
Pitch 7.62 mm					
Pol.	L1	(inch)	Qty.	Order No.	
4	30.48	1.200	40	1173530000	
5	38.10	1.500	30	1398890000	
6	45.72	1.800	25	1398910000	

Additional deratings curves

BLZ 7.62HP../180 - SL 7.62HP../90

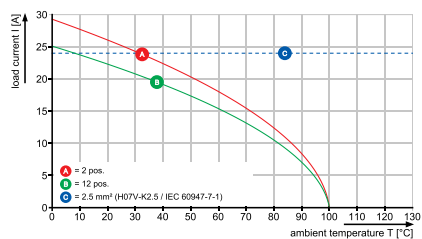

SV-SMT 7.62IT../90MF

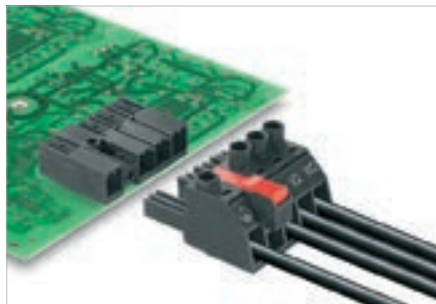

Male header with 90° outlet direction with optional solder flange attachment and leading PE contact for IT networks. UL approval in accordance with UL840 for 600 V. In combination with the female plug BVZ 7.62IT meets the enhanced requirements for 5.5 mm of touch safety for IT networks in acc. with IEC61800-5-1 for 400 V relative to earth. If no female plug is present, the mating profile still ensures that at least > 1 mm of finger safety is present with a finger pressure of 20 N.

Variants: flange, screw flange and middle flange fastening.

The high-temperature-resistant OMNIMATE® Power male header with THR (through-hole reflow) technology, suitable for the SMT process.

Technical data

In compliance with IEC 60664-1 / IEC 61984

Clamping range, max.			
Solid core H05(07) V-U			
Stranded H07 V-R			
Flexible H05(07) V-K			
Flexible with ferrule			
Ferrule with plastic collar			
Stripping length			
Screwdriver blade	mm		
According to norm			
Tightening torque range			
Rated current, max.	A	41	41
At ambient temperature		20°C	40°C
For conductor cross-section			
Overvoltage category		III	III II
Pollution severity		3	2 2
Rated voltage	V	630	630 1000
Rated impulse voltage	kV	6	6 6
UL / CUL (Use Group)		B	C D
Rated voltage	V	300	300 300
Rated current	A	40.5	40.5 10
AWG conductor	AWG		-
CSA (Use Group)		B	C D
Rated voltage	V		
Rated current	A		
AWG conductor	AWG		
General data			
Type of insulation material		PA 9T	
UL 94 flammability rating		V-0	
Contact base material		Copper alloy	
Material of contact surface		tinned	
Pin dimensions = d	mm	0.8 x 1.0	
Solder eyelet Ø = D	mm	1.4	
Solder eyelet Ø tolerance	mm	+ 0,1	

Product data

IEC: 1000 V / 41 A
UL: 300 V / 40.5 A



For additional articles and information, refer to catalog.weidmuller.com

Note:

- Additional variants on request
- Rated current related to rated cross-section & min. No. of poles.
- P on drawing = pitch
- Rated data refer only to the component itself. Clearance and creepage distances to other components are to be designed in accordance with the relevant application standards.
- Long term storage of the product with average temperature of 50 °C and average humidity 70%, 36 months

SV-SMT 7.62IT../90MF2 Box



Dimensioned drawing

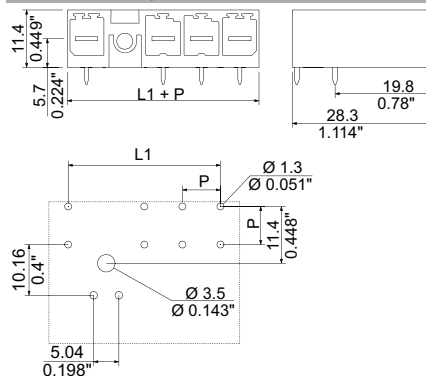

Accessories

Note: Refer to the Accessories chapter for additional accessories.

Coding	Order No.
 BV/SV 7.62HP KO	1937590000

Ordering data

Solder pin length		2.6 mm	
Colour		black	
Pitch		7.62 mm	
Pol.	L1	(inch)	Qty. Order No.
2	15.24	0.600	50 2499530000
3	22.86	0.900	50 2499720000
4	30.48	1.200	48 2499740000
5	38.10	1.800	50 2499760000

SV-SMT 7.62IT../90MF3 Box



Dimensioned drawing

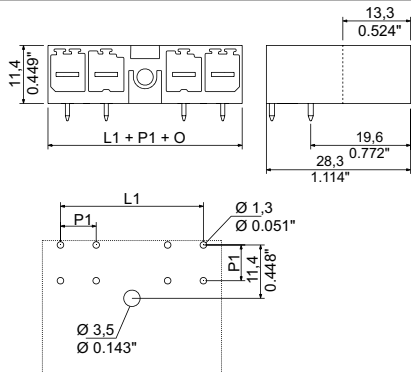

Ordering data

Solder pin length		2.6 mm	
Colour		black	
Pitch		7.62 mm	
Pol.	L1	(inch)	Qty. Order No.
3	22.86	0.900	50 2499730000
4	30.48	1.200	48 2499750000
5	38.10	1.800	50 2499770000

SV-SMT 7.62IT../90MF4 Box



Dimensioned drawing

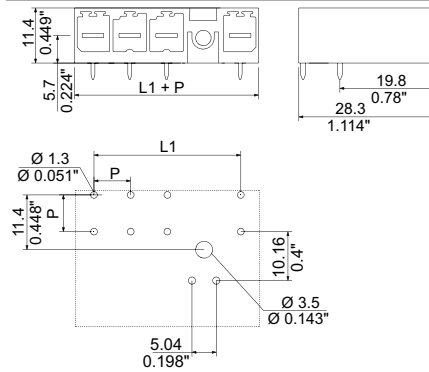

Ordering data

Solder pin length		2.6 mm	
Colour		black	
Pitch		7.62 mm	
Pol.	L1	(inch)	Qty. Order No.
4	30.48	1.200	48 2454110000
5	38.10	1.800	50 2499780000

Connectors for IT power networks, pitch 7.62 mm
BV/SV 7.62 IT series - connection up to 6 mm²

SV-SMT 7.62IT../270MF

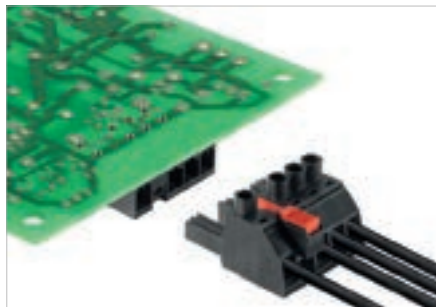

Male header with 270° outlet direction with optional solder flange attachment and leading PE contact for IT networks. UL approval in accordance with UL840 for 600 V. In combination with the female plug BVZ 7.62IT meets the enhanced requirements for 5.5 mm of touch safety for IT networks in acc. with IEC61800-5-1 for 400 V relative to earth. When no female plug is present, the mating profile ensures that at least > 1 mm of finger safety is present with a finger pressure of 20 N.

Variants: flange, screw flange and middle flange fastening.

The high-temperature-resistant OMNIMATE® Power male header with THR (through-hole reflow) technology, suitable for the SMT process.

Product data

IEC: 1000 V / 41 A
 UL: 300 V / 40.5 A



For additional articles and information, refer to catalog.weidmuller.com

Note:

- Additional variants on request
- Rated current related to rated cross-section & min. No. of poles.
- P on drawing = pitch
- Rated data refer only to the component itself. Clearance and creepage distances to other components are to be designed in accordance with the relevant application standards.
- Long term storage of the product with average temperature of 50 °C and average humidity 70%, 36 months

SV-SMT 7.62IT../270MF2 Box



Dimensioned drawing

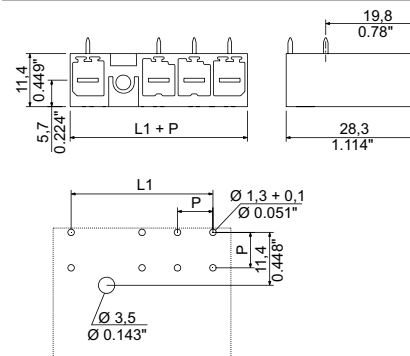

Technical data

In compliance with IEC 60664-1 / IEC 61984

Clamping range, max.			
Solid core H05(07) V-U			
Stranded H07 V-R			
Flexible H05(07) V-K			
Flexible with ferrule			
Ferrule with plastic collar			
Stripping length			
Screwdriver blade	mm		
According to norm			
Tightening torque range			
Rated current, max.	A	41	41
At ambient temperature		20°C	40°C
For conductor cross-section			
Overvoltage category		III	III II
Pollution severity		3	2 2
Rated voltage	V	630	630 1000
Rated impulse voltage	kV	6	6 6
UL / CUL (Use Group)		B	C D
Rated voltage	V	300	300 300
Rated current	A	40.5	40.5 10
AWG conductor	AWG		-
CSA (Use Group)		B	C D
Rated voltage	V		
Rated current	A		
AWG conductor	AWG		
General data			
Type of insulation material		PA 9T	
UL 94 flammability rating		V-0	
Contact base material		Copper alloy	
Material of contact surface		tinned	
Pin dimensions = d	mm	0.8 x 1.0	
Solder eyelet Ø = D	mm	1.4	
Solder eyelet Ø tolerance	mm	+ 0,1	

Accessories

Note: Refer to the Accessories chapter for additional accessories.

Coding	Order No.
BV/SV 7.62HP KO	1937590000

Ordering data

Solder pin length	3.5 mm			
Colour	black			
Pitch	7.62 mm			
Pol.	L1	(inch)	Qty.	Order No.
2	15.24	0.600	50	2498800000
3	22.86	0.900	50	2499010000
4	30.48	1.200	50	2499030000

SV-SMT 7.62IT../270MF3 Box



Dimensioned drawing

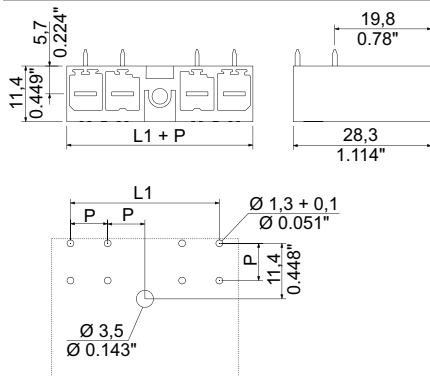

Ordering data

Solder pin length		3.5 mm		
Colour		black		
Pitch		7.62 mm		
Pol.	L1	(inch)	Qty.	Order No.
3	22.86	0.900	50	2499020000
4	30.48	1.200	50	2499040000

SV-SMT 7.62IT../270MF4 Box



Dimensioned drawing

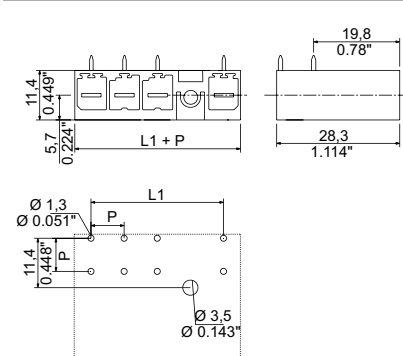

Ordering data

Solder pin length		3.5 mm		
Colour		black		
Pitch		7.62 mm		
Pol.	L1	(inch)	Qty.	Order No.
4	30.48	1.200	50	2499050000

Connectors for IT power networks, pitch 7.62 mm
BV/SV 7.62 IT series - connection up to 6 mm²

SV 7.62IT/./90MF

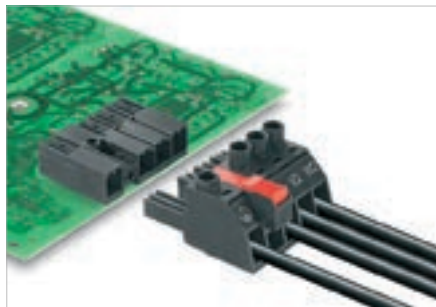

Male header with 90° outlet direction with optional solder flange attachment and leading PE contact for IT power networks. UL approval in accordance with UL840 for 600 V In combination with the female plug BVZ 7.62 IT meets the enhanced requirements for 5.5 mm of touch safety for IT power networks in acc. with IEC 61800-5-1 for 400 V relative to earth. Even when no female plug is present, the mating profile ensures that at least >1 mm of touch safety is present with a finger pressure of 20 N.

The middle-flange interlock feature decreases the space required by one pitch width compared to other standard solutions.

Available on request with screw flange mounting block or without flange.

Technical data

In compliance with IEC 60664-1 / IEC 61984			
Clamping range, max.			
Solid core H05(07) V-U			
Stranded H07 V-R			
Flexible H05(07) V-K			
Flexible with ferrule			
Ferrule with plastic collar			
Stripping length			
Screwdriver blade	mm		
According to norm			
Tightening torque range			
Rated current, max.	A	41	41
At ambient temperature		20°C	40°C
For conductor cross-section			
Overvoltage category		III	III II
Pollution severity		3	2 2
Rated voltage	V	630	630 1000
Rated impulse voltage	kV	6	6 6
UL / CUL (Use Group)		B	C D
Rated voltage	V	300	300 600
Rated current	A	40.5	40.5 5
AWG conductor	AWG		-
CSA (Use Group)		B	C D
Rated voltage	V	300	300 600
Rated current	A	35	35 5
AWG conductor	AWG		-
General data			
Type of insulation material		PA GF	
UL 94 flammability rating		V-0	
Contact base material		Copper alloy	
Material of contact surface		tinned	
Pin dimensions = d	mm	0.8 x 1.0	
Solder eyelet Ø = D	mm	1.3	
Solder eyelet Ø tolerance	mm	+ 0,1	

Product data

IEC: 1000 V / 41 A
 UL: 300 V / 40.5 A



For additional articles and information, refer to catalog.weidmuller.com

Note:

- Additional variants on request
- Rated current related to rated cross-section & min. No. of poles.
- P on drawing = pitch
- Rated data refer only to the component itself. Clearance and creepage distances to other components are to be designed in accordance with the relevant application standards.
- Long term storage of the product with average temperature of 50 °C and average humidity 70%, 36 months

SV 7.62IT/./90MF2



Dimensioned drawing

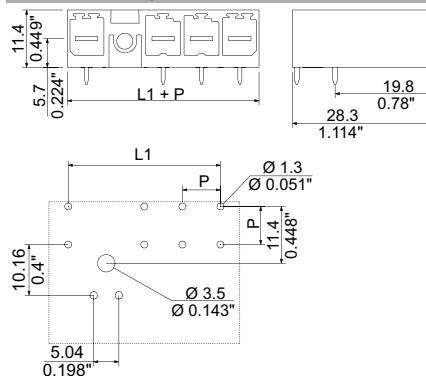

Accessories

Note: Refer to the Accessories chapter for additional accessories.

Coding	Order No.
BV/SV 7.62HP KO	1937590000

Ordering data

Solder pin length		3.5 mm	
Colour		black	
Pitch		7.62 mm	
Pol.	L1 (inch)	Qty.	Order No.
2	15.24	78	1156540000
3	22.86	60	1156550000
4	30.48	48	1156580000

SV 7.62IT/./90MF3



Dimensioned drawing

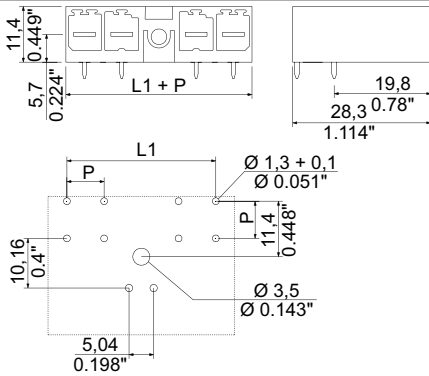

Ordering data

Solder pin length		3.5 mm	
Colour		black	
Pitch		7.62 mm	
Pol.	L1	(inch)	Qty. Order No.
3	22.86	0.900	60 1156570000
4	30.48	1.200	48 1519190000

SV 7.62IT/./90MF4



Dimensioned drawing

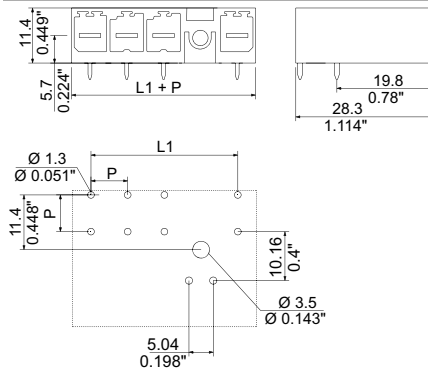

Ordering data

Solder pin length		3.5 mm	
Colour		black	
Pitch		7.62 mm	
Pol.	L1	(inch)	Qty. Order No.
4	30.48	1.200	48 1156590000

Connectors for IT power networks, pitch 7.62 mm
BV/SV 7.62 IT series - connection up to 6 mm²

SV 7.62IT../270MF

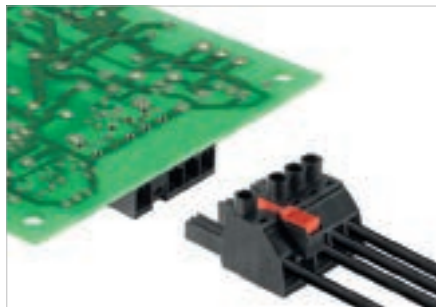

Male header with 270° outlet direction with a leading PE contact for IT power networks. UL approval in accordance with UL840 for 600 V In combination with the female plug BVZ 7.62 IT meets the enhanced requirements for 5.5 mm of touch safety for IT power networks in acc. with IEC 61800-5-1 for 400 V relative to earth. Even when no female plug is present, the mating profile ensures that at least >1 mm of touch safety is present with a finger pressure of 20 N.

The middle-flange interlock feature decreases the space required by one pitch width compared to other standard solutions.

Available on request with screw flange mounting block or without flange.

Product data

IEC: 1000 V / 41 A
 UL: 300 V / 40.5 A



For additional articles and information, refer to catalog.weidmuller.com

Note:

- Additional variants on request
- Rated current related to rated cross-section & min. No. of poles.
- P on drawing = pitch
- Rated data refer only to the component itself. Clearance and creepage distances to other components are to be designed in accordance with the relevant application standards.
- Long term storage of the product with average temperature of 50 °C and average humidity 70%, 36 months

SV 7.62IT../270MF2



Dimensioned drawing

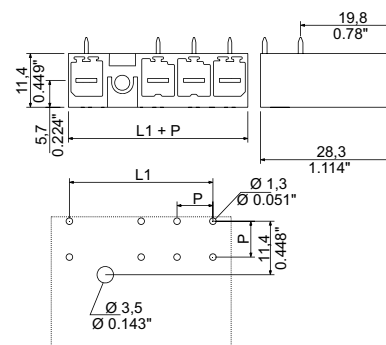

Technical data

In compliance with IEC 60664-1 / IEC 61984

Clamping range, max.			
Solid core H05(07) V-U			
Stranded H07 V-R			
Flexible H05(07) V-K			
Flexible with ferrule			
Ferrule with plastic collar			
Stripping length			
Screwdriver blade	mm		
According to norm			
Tightening torque range			
Rated current, max.	A	41	41
At ambient temperature		20°C	40°C
For conductor cross-section			
Overvoltage category		III	III II
Pollution severity		3	2 2
Rated voltage	V	630	630 1000
Rated impulse voltage	kV	6	6 6
UL / CUL (Use Group)		B	C D
Rated voltage	V	300	300 600
Rated current	A	40.5	40.5 5
AWG conductor	AWG		-
CSA (Use Group)		B	C D
Rated voltage	V	300	300 600
Rated current	A	35	35 5
AWG conductor	AWG		-
General data			
Type of insulation material		PA GF	
UL 94 flammability rating		V-0	
Contact base material		Copper alloy	
Material of contact surface		tinned	
Pin dimensions = d	mm	0.8 x 1.0	
Solder eyelet Ø = D	mm	1.3	
Solder eyelet Ø tolerance	mm	+ 0,1	

Accessories

Note: Refer to the Accessories chapter for additional accessories.

Coding	Order No.
BV/SV 7.62HP K0	1937590000

Ordering data

Solder pin length	3.5 mm			
Colour	black			
Pitch	7.62 mm			
Pol.	L1	(inch)	Qty.	Order No.
2	15.24	0.600	78	1156490000
3	22.86	0.900	60	1156500000
4	30.48	1.200	48	1156520000

SV 7.62IT../270MF3



Dimensioned drawing

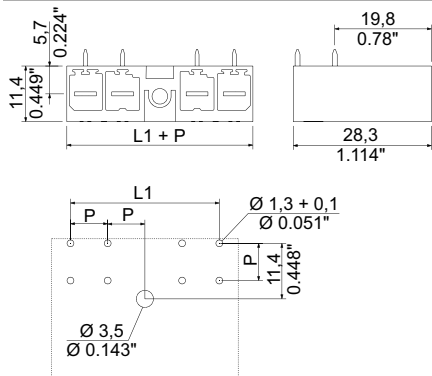

Ordering data

Solder pin length		3.5 mm		
Colour		black		
Pitch		7.62 mm		
Pol.	L1	(inch)	Qty.	Order No.
3	22.86	0.900	60	1156510000
4	30.48	1.200	48	1519200000

SV 7.62IT../270MF4



Dimensioned drawing

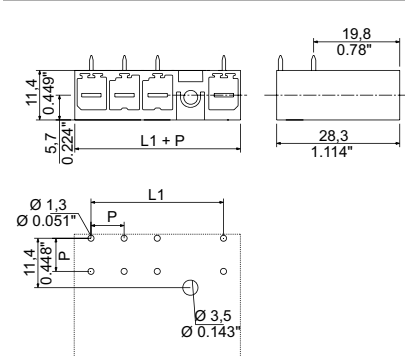

Ordering data

Solder pin length		3.5 mm		
Colour		black		
Pitch		7.62 mm		
Pol.	L1	(inch)	Qty.	Order No.
4	30.48	1.200	48	1156530000

Connectors for IT power networks, pitch 7.62 mm
BV/SV 7.62 IT series - connection up to 6 mm²

BVZ 7.62IT../180MF

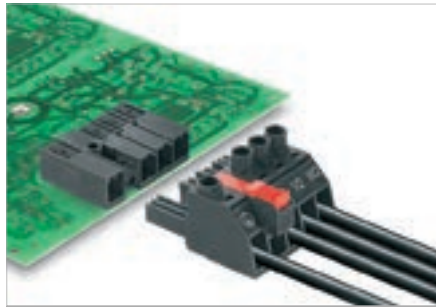

Female plug for IT power networks. Meets the requirements of UL1059 for 600 V Use Group C. Leading PE contact in combination with the male header SV 7.62 IT. Meets the enhanced requirements for 5.5 mm of touch safety for IT power networks in acc. with IEC 61800-5-1 for 400 V relative to earth.

The self-locking middle flange which can also be optionally screwed, reduces the space requirements by one pitch width compared to conventional solutions.

Optionally available without middle flange interlock.

Product data

IEC: 1000 V / 57 A / 0.2 - 10 mm²
 UL: 600 V / 40.5 A / AWG 24 - 8



For additional articles and information, refer to catalog.weidmueller.com

Note:

- Additional variants on request
- Rated current related to rated cross-section & min. No. of poles.
- Wire end ferrule with plastic collar to DIN 46228/4
- Wire end ferrule without plastic collar to DIN 46228/1
- P on drawing = pitch
- Rated data refer only to the component itself. Clearance and creepage distances to other components are to be designed in accordance with the relevant application standards.
- Long term storage of the product with average temperature of 50 °C and average humidity 70%, 36 months

BVZ 7.62IT../180MF2



Dimensioned drawing

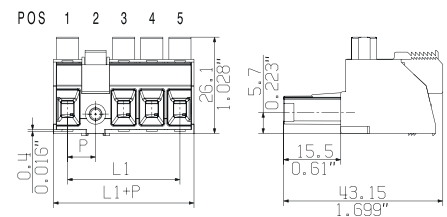

Technical data

In compliance with IEC 60664-1 / IEC 61984			
Clamping range, max.	mm ²	0.2...10	
Solid core H05(07) V-U	mm²	0.2...6	
Stranded H07 V-R			
Flexible H05(07) V-K	mm ²	0.5...10	
Flexible with ferrule	mm ²	0.25...6	
Ferrule with plastic collar	mm ²	0.25...6	
Stripping length	mm	12	
Screwdriver blade	mm	0.6 x 3.5	
According to norm			
Tightening torque range	Nm	0.5...0.6	
Rated current, max.		57	41
At ambient temperature		20°C	40°C
For conductor cross-section	mm ²	6	
Overvoltage category		III	III II
Pollution severity		3	2 2
Rated voltage	V	800	1000 1000
Rated impulse voltage	kV	8	8 6
UL / CUL (Use Group)		B	C D
Rated voltage	V	600	600 600
Rated current	A	40.5	40.5 5
AWG conductor	AWG	24-8	
CSA (Use Group)		B	C D
Rated voltage	V	600	600 600
Rated current	A	40.5	40.5 5
AWG conductor	AWG	24-8	
General data			
Type of insulation material		PA GF	
UL 94 flammability rating		V-0	
Contact base material		Copper alloy	
Material of contact surface		tinned	
Pin dimensions = d	mm		
Solder eyelet Ø = D	mm		
Solder eyelet Ø tolerance	mm		

Accessories

Note: Refer to the Accessories chapter for additional accessories.

Coding	Order No.
BV/SV 7.62HP K0	1937590000
Strain relief	
BV/SV 7.62HP/02 ZE GR	1937550000
BV/SV 7.62HP/04 ZE GR	1937560000
Screwdriver	
SDS 0.8X4.5X125	2749370000
SDK PH1 X 80	2749410000

Ordering data

Solder pin length				
Colour	black			
Pitch	7.62 mm			
Pol.	L1	(inch)	Qty.	Order No.
2	15.24	0.600	52	1156710000
3	22.86	0.900	40	1156720000
4	30.48	1.200	32	1156740000

Representative deratings curve

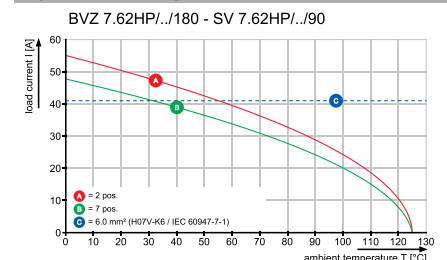

BVZ 7.62IT../180MF3



Dimensioned drawing

BVZ 7.62IT../180MF4



Dimensioned drawing

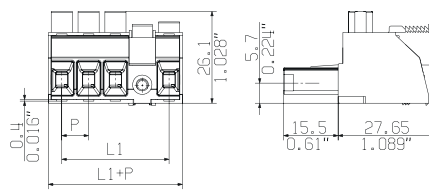
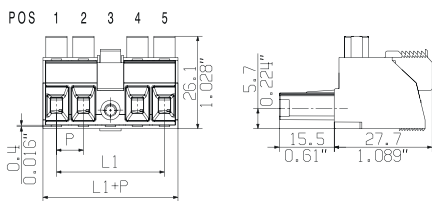

Ordering data

Solder pin length					
Colour					black
Pitch 7.62 mm					
Pol.	L1	(inch)	Qty.	Order No.	
3	22.86	0.900	40	1156730000	
4	30.48	1.200	32	1312730000	

Ordering data

Solder pin length					
Colour					black
Pitch 7.62 mm					
Pol.	L1	(inch)	Qty.	Order No.	
4	30.48	1.200	32	1156750000	

Additional deratings curves

BVZ 7.62HP../180 - SV 7.62HP../180

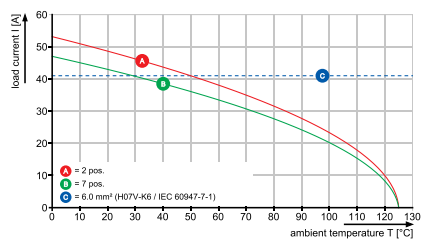

SU 10.16IT../90MF

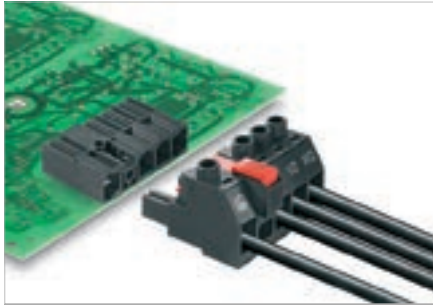

Male header with 90° outlet direction and optional solder flange with leading PE contact. UL approval in accordance with UL840 for 600 V. In combination with the female plug BUZ 10.16 IT meets the enhanced requirements for 5.5 mm of touch safety on IT power networks in acc. with IEC 61800-5-1 for 400 V relative to earth. Even when no female plug is present, the mating profile ensures that at least >1 mm of touch safety is present with a finger pressure of 20 N.

The middle-flange interlock feature decreases the space required by one pitch width compared to other standard solutions.

Available on request with screw flange mounting block or without flange.

Product data

IEC: 1000 V / 78.3 A
UL: 300 V / 60 A



For additional articles and information, refer to catalog.weidmueller.com

Note:

- Additional variants on request
- Rated current related to rated cross-section & min. No. of poles.
- P on drawing = pitch
- Rated data refer only to the component itself. Clearance and creepage distances to other components are to be designed in accordance with the relevant application standards.
- For all applications with flange we recommend to fix the pin header with the help of the soldering flange or a self-tapping screw on the board.
- Long term storage of the product with average temperature of 50 °C and average humidity 70%, 36 months

SU 10.16IT../90MF2



Dimensioned drawing

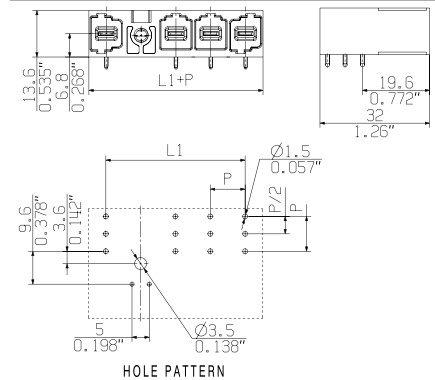

Technical data

In compliance with IEC 60664-1 / IEC 61984

Clamping range, max.			
Solid core H05(07) V-U			
Stranded H07 V-R			
Flexible H05(07) V-K			
Flexible with ferrule			
Ferrule with plastic collar			
Stripping length			
Screwdriver blade	mm		
According to norm			
Tightening torque range			
Rated current, max.	A	78.3	70.6
At ambient temperature		20°C	40°C
For conductor cross-section			
Overtoltage category		III	III II
Pollution severity		3	2 2
Rated voltage	V	690	1000 1000
Rated impulse voltage	kV	8	8 6
UL / CUL (Use Group)		B	C D
Rated voltage	V	300	300 600
Rated current	A	60	60 5
AWG conductor	AWG		-
CSA (Use Group)		B	C D
Rated voltage	V	300	300 600
Rated current	A	60	60 5
AWG conductor	AWG		-
General data			
Type of insulation material		PA GF	
UL 94 flammability rating		V-0	
Contact base material		Copper alloy	
Material of contact surface		silver-plated	
Pin dimensions = d	mm	1.2 x 1.1	
Solder eyelet Ø = D	mm	1.6	
Solder eyelet Ø tolerance	mm	+ 0,1	

Accessories

Note: Refer to the Accessories chapter for additional accessories.

Coding	Order No.
KO BU/SU10.16HP BK	1824410000
KO BU/SU10.16HP WT	2592600000
Mounting screw	
SU 10.16 BFSC P 35X 14	2812340000
SU 10.16 BFSC S 35X12	2812290000

Ordering data

Solder pin length	3.5 mm			
Colour	black			
Pitch	10.16 mm			
Pol.	L1	(inch)	Qty.	Order No.
2	20.32	0.800	60	1156650000
3	30.48	1.200	42	1156670000
4	40.64	1.600	36	1156690000

SU 10.16IT../90MF3



Dimensioned drawing

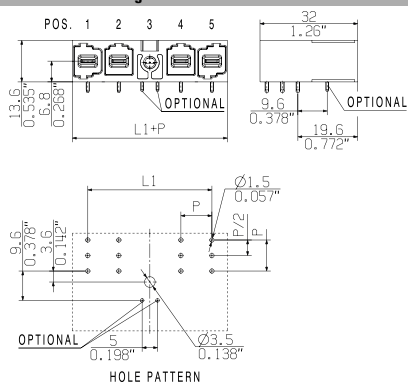

Ordering data

Solder pin length		3.5 mm	
Colour		black	
Pitch		10.16 mm	
Pol.	L1	(inch)	Qty. Order No.
3	30.48	1.200	42 1156680000
4	20.32	0.800	36 2629730000

SU 10.16IT../90MF4



Dimensioned drawing

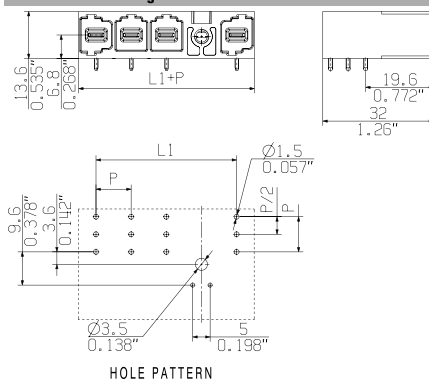

Ordering data

Solder pin length		3.5 mm	
Colour		black	
Pitch		10.16 mm	
Pol.	L1	(inch)	Qty. Order No.
4	40.64	1.600	36 1156700000

SU 10.16IT../270MF

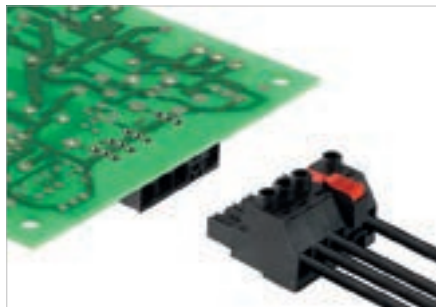

Male header with 270° outlet direction with leading PE contact. UL approval in accordance with UL840 for 600 V. In combination with the female plug BUZ 10.16 IT meets the enhanced requirements for 5.5 mm of touch safety on IT power networks in acc. with IEC 61800-5-1 for 400 V relative to earth. Even when no female plug is present, the mating profile ensures that at least >1 mm of touch safety is present with a finger pressure of 20 N.

The middle-flange interlock feature decreases the space required by one pitch width compared to other standard solutions.

Available on request with screw flange mounting block or without flange.

Product data

IEC: 1000 V / 78.3 A
UL: 300 V / 60 A



For additional articles and information, refer to catalog.weidmueller.com

Note:

- Additional variants on request
- Rated current related to rated cross-section & min. No. of poles.
- P on drawing = pitch
- Rated data refer only to the component itself. Clearance and creepage distances to other components are to be designed in accordance with the relevant application standards.
- For all applications with flange we recommend to fix the pin header with the help of the soldering flange or a self-tapping screw on the board.
- Long term storage of the product with average temperature of 50 °C and average humidity 70%, 36 months

SU 10.16IT../270MF2



Dimensioned drawing

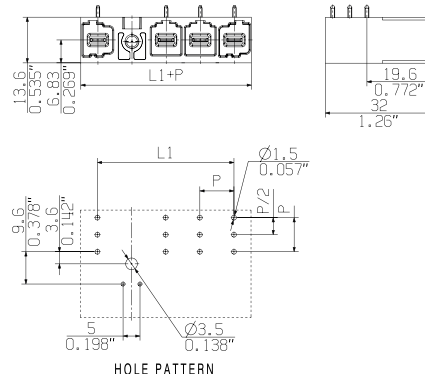

Technical data

In compliance with IEC 60664-1 / IEC 61984

Clamping range, max.			
Solid core H05(07) V-U			
Stranded H07 V-R			
Flexible H05(07) V-K			
Flexible with ferrule			
Ferrule with plastic collar			
Stripping length			
Screwdriver blade	mm		
According to norm			
Tightening torque range			
Rated current, max.	A	78.3	70.6
At ambient temperature		20°C	40°C
For conductor cross-section			
Overtoltage category		III	III
Pollution severity		3	2
Rated voltage	V	690	1000
Rated impulse voltage	kV	8	8
UL / CUL (Use Group)		B	C
Rated voltage	V	300	300
Rated current	A	60	60
AWG conductor	AWG	-	-
CSA (Use Group)		B	C
Rated voltage	V	300	300
Rated current	A	60	60
AWG conductor	AWG	-	-
General data			
Type of insulation material	PA GF		
UL 94 flammability rating	V-0		
Contact base material	Copper alloy		
Material of contact surface	silver-plated		
Pin dimensions = d	mm	1.2 x 1.1	
Solder eyelet Ø = D	mm	1.6	
Solder eyelet Ø tolerance	mm	+ 0,1	

Accessories

Note: Refer to the Accessories chapter for additional accessories.

Coding	Order No.
KO BU/SU10.16HP BK	1824410000
KO BU/SU10.16HP WT	2592600000
Mounting screw	
SU 10.16 BFSC P 35X 14	2812340000
SU 10.16 BFSC S 35X12	2812290000

Ordering data

Solder pin length	3.5 mm			
Colour	black			
Pitch	10.16 mm			
Pol.	L1	(inch)	Qty.	Order No.
2	20.32	0.800	60	1157310000
3	30.48	1.200	42	1157320000
4	40.64	1.600	36	1157340000

SU 10.16IT../270MF3

SU 10.16IT../270MF4



Dimensioned drawing

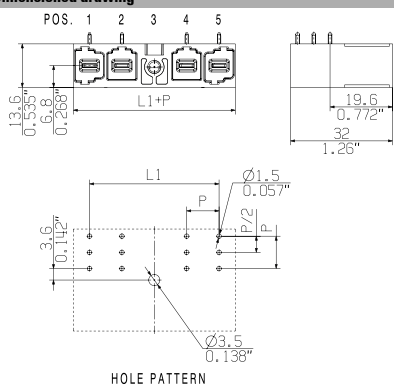

Dimensioned drawing

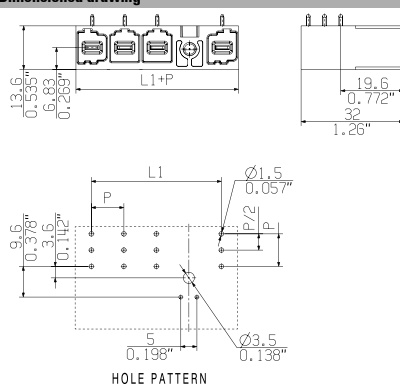

Ordering data

Solder pin length		3.5 mm	
Colour		black	
Pitch		10.16 mm	
Pol.	L1	(inch)	Qty. Order No.
3	30.48	1.200	42 1157330000
4	20.32	0.800	36 2630190000

Ordering data

Solder pin length		3.5 mm	
Colour		black	
Pitch		10.16 mm	
Pol.	L1	(inch)	Qty. Order No.
4	40.64	1.600	36 1157350000

BUZ 10.16IT../180MF SH

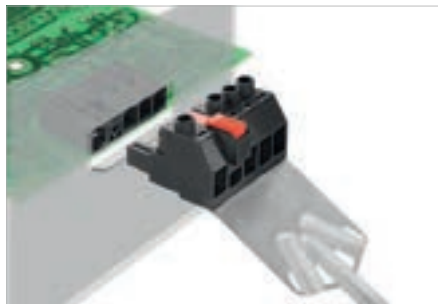

Female plug with 180° outlet direction for IT power networks. Meets the requirements of UL1059 for 600 V Use Group C. Leading PE contact in combination with the male header SU 7.62 IT. Meets the enhanced requirements for 5.5 mm of touch safety on IT power networks in acc. with IEC 61800-5-1 for 400 V relative to earth. The self-locking middle flange which can also be optionally screwed, reduces the space requirements by one pitch width compared to conventional solutions.

The pluggable shield connection has a wide contact area on the device housing and does not need to be bolted.

Technical data

In compliance with IEC 60664-1 / IEC 61984			
Clamping range, max.	mm ²	0.2...16	
Solid core H05(07) V-U	mm²	0.2...16	
Stranded H07 V-R		...16	
Flexible H05(07) V-K	mm ²	0.5...16	
Flexible with ferrule	mm ²	0.25...16	
Ferrule with plastic collar	mm ²	0.25...16	
Stripping length	mm	12	
Screwdriver blade	mm		
According to norm			
Tightening torque range	Nm	1.2...1.5	
Rated current, max.	A	78.3	70.6
At ambient temperature		20°C	40°C
For conductor cross-section	mm ²	16	
Overvoltage category		III	III II
Pollution severity		3	2 2
Rated voltage	V	1000	1000 1000
Rated impulse voltage	kV	8	8 6
UL / CUL (Use Group)			
Rated voltage	V	600	600 600
Rated current	A	60	60 5
AWG conductor	AWG	22-4	
CSA (Use Group)			
Rated voltage	V	600	600 600
Rated current	A	60	60 5
AWG conductor	AWG	22-4	
General data			
Type of insulation material		PA GF	
UL 94 flammability rating		V-0	
Contact base material		Copper alloy	
Material of contact surface		silver-plated	
Pin dimensions = d	mm		
Solder eyelet Ø = D	mm		
Solder eyelet Ø tolerance	mm		

Product data

IEC: 1000 V / 78.3 A / 0.2 - 16 mm²
UL: 600 V / 60 A / AWG 22 - 4



For additional articles and information, refer to catalog.weidmueller.com

Note:

- Additional variants on request
- Rated current related to rated cross-section & min. No. of poles.
- Wire end ferrule with plastic collar to DIN 46228/4
- Wire end ferrule without plastic collar to DIN 46228/1
- P on drawing = pitch
- Rated data refer only to the component itself. Clearance and creepage distances to other components are to be designed in accordance with the relevant application standards.
- For all applications with flange we recommend to fix the pin header with the help of the soldering flange or a self-tapping screw on the board.
- Long term storage of the product with average temperature of 50 °C and average humidity 70%, 36 months

BUZ 10.16IT../180MF2 SH160



UL 600 V

Dimensioned drawing

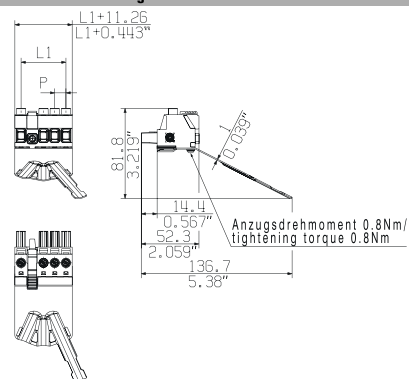

Accessories

Note: Refer to the Accessories chapter for additional accessories.

Coding	Order No.
KO BU/SU10.16HP BK	1824410000
KO BU/SU10.16HP WT	2592600000
Screwdriver	
SDIS 1.0X5.5X125	2749850000
Crosshead screwdriver	
SDIK PZ2 X 100	2749930000
SDK PZ2 X 100	2749450000

Ordering data

Solder pin length					
Colour	black				
Pitch 10.16 mm					
Pol.	L1	(inch)	Qty.	Order No.	
3	30.48	1.200	20	2627330000	
4	40.64	1.600	20	2627340000	

Representative dimensional drawing

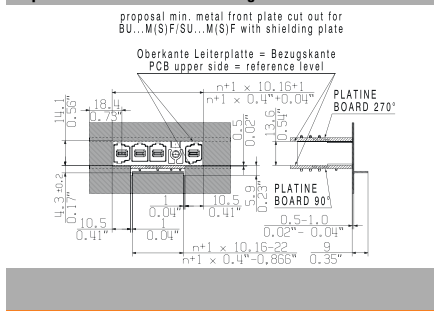

Representative deratings curve

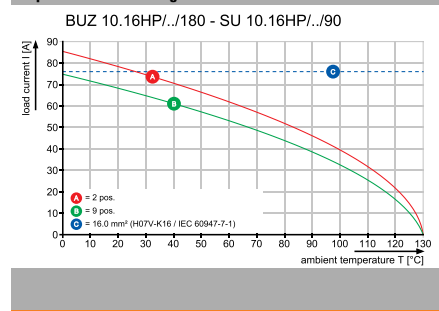

OMNIMATE® Power PCB connectors

P

10.16

180°

16 mm²

BUZ 10.16IT../180MF2 SH180



**UL
600V**

Dimensioned drawing

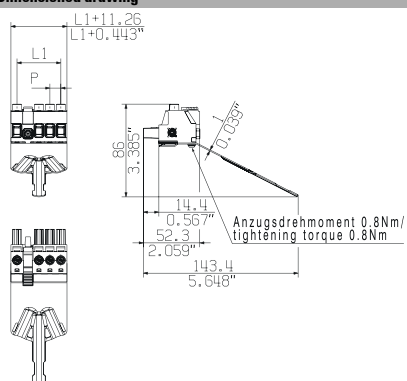

Ordering data

Solder pin length				
Colour	black			
Pitch	10.16 mm			
Pol.	L1	(inch)	Qty.	Order No.
3	30.48	1.200	20	2627380000
4	40.64	1.600	20	2627390000

BUZ 10.16IT../180MF2 SH200



**UL
600V**

Dimensioned drawing

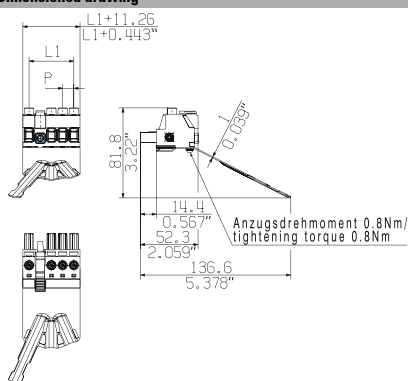

Ordering data

Solder pin length				
Colour	black			
Pitch	10.16 mm			
Pol.	L1	(inch)	Qty.	Order No.
3	30.48	1.200	20	2627430000
4	40.64	1.600	20	2627440000

Additional deratings curves

BUZ 10.16HP../180 - SU 10.16HP../180

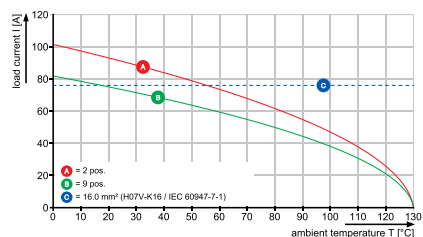

BUZ 10.16IT../180MF SH

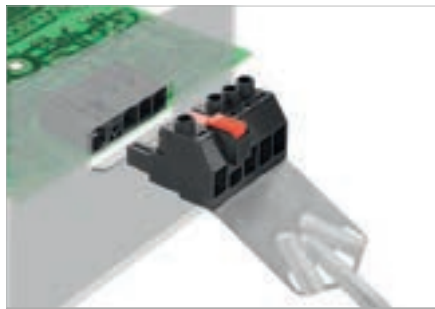

Female plug with 180° outlet direction for IT power networks. Meets the requirements of UL1059 for 600 V Use Group C. Leading PE contact in combination with the male header SU 7.62 IT. Meets the enhanced requirements for 5.5 mm of touch safety on IT power networks in acc. with IEC 61800-5-1 for 400 V relative to earth. The self-locking middle flange which can also be optionally screwed, reduces the space requirements by one pitch width compared to conventional solutions.

The pluggable shield connection has a wide contact area on the device housing and does not need to be bolted.

Technical data

In compliance with IEC 60664-1 / IEC 61984			
Clamping range, max.	mm ²	0.2...16	
Solid core H05(07) V-U	mm²	0.2...16	
Stranded H07 V-R		...16	
Flexible H05(07) V-K	mm ²	0.5...16	
Flexible with ferrule	mm ²	0.25...16	
Ferrule with plastic collar	mm ²	0.25...16	
Stripping length	mm	12	
Screwdriver blade	mm		
According to norm			
Tightening torque range	Nm	1.2...1.5	
Rated current, max.	A	78.3	70.6
At ambient temperature		20°C	40°C
For conductor cross-section	mm ²	16	
Overvoltage category		III	III II
Pollution severity		3	2 2
Rated voltage	V	1000	1000 1000
Rated impulse voltage	kV	8	8 6
UL / CUL (Use Group)		B	C D
Rated voltage	V	600	600 600
Rated current	A	60	60 5
AWG conductor	AWG	22-4	
CSA (Use Group)		B	C D
Rated voltage	V	600	600 600
Rated current	A	60	60 5
AWG conductor	AWG	22-4	
General data			
Type of insulation material		PA GF	
UL 94 flammability rating		V-0	
Contact base material		Copper alloy	
Material of contact surface		silver-plated	
Pin dimensions = d	mm		
Solder eyelet Ø = D	mm		
Solder eyelet Ø tolerance	mm		

Product data

IEC: 1000 V / 78.3 A / 0.2 - 16 mm²
UL: 600 V / 60 A / AWG 22 - 4



For additional articles and information, refer to catalog.weidmueller.com

Note:

- Additional variants on request
- Rated current related to rated cross-section & min. No. of poles.
- Wire end ferrule with plastic collar to DIN 46228/4
- Wire end ferrule without plastic collar to DIN 46228/1
- P on drawing = pitch
- Rated data refer only to the component itself. Clearance and creepage distances to other components are to be designed in accordance with the relevant application standards.
- For all applications with flange we recommend to fix the pin header with the help of the soldering flange or a self-tapping screw on the board.
- Long term storage of the product with average temperature of 50 °C and average humidity 70%, 36 months

BUZ 10.16IT../180MF3 SH160



UL 600 V

Dimensioned drawing

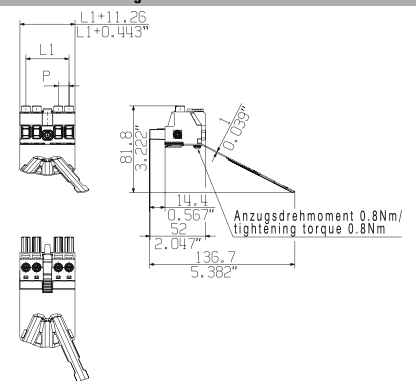

Accessories

Note: Refer to the Accessories chapter for additional accessories.

Coding	Order No.
KO BU/SU10.16HP BK	18244 10000
KO BU/SU10.16HP WT	259260000
Screwdriver	
SDIS 1.0X5.5X125	2749850000
Crosshead screwdriver	
SDIK PZ2 X 100	2749930000
SDK PZ2 X 100	2749450000

Ordering data

Solder pin length				
Colour	black			
Pitch	10.16 mm			
Pol.	L1	(inch)	Qty.	Order No.
3	30.48	1.200	20	2627350000
4	40.64	1.600	20	2627360000

Representative dimensional drawing

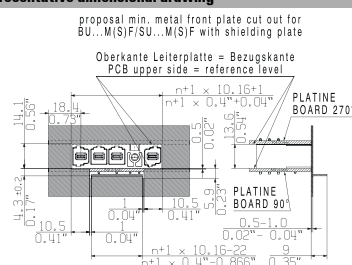

Representative deratings curve

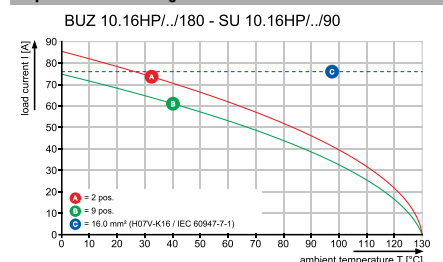

BUZ 10.16IT../180MF3 SH180



**UL
600V**

Dimensioned drawing

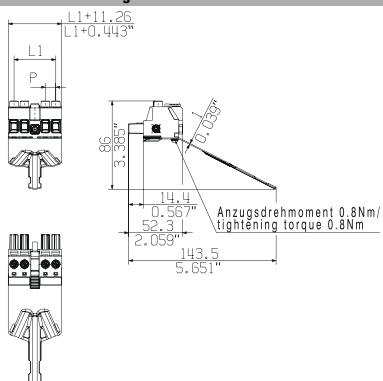

Ordering data

Solder pin length					
Colour					black
Pitch 10.16 mm					
Pol.	L1	(inch)	Qty.	Order No.	
3	30.48	1.200	20	2627400000	
4	40.64	1.600	20	2627410000	

BUZ 10.16IT../180MF3 SH200



**UL
600V**

Dimensioned drawing

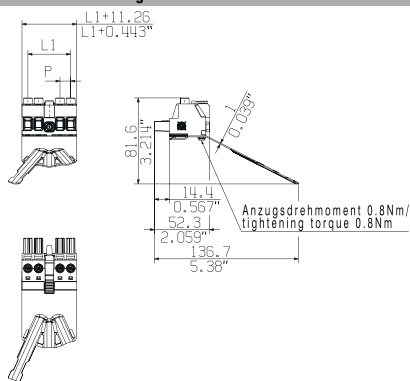

Ordering data

Solder pin length					
Colour					black
Pitch 10.16 mm					
Pol.	L1	(inch)	Qty.	Order No.	
3	30.48	1.200	20	2627450000	
4	40.64	1.600	20	2627460000	

Additional deratings curves

BUZ 10.16HP../180 - SU 10.16HP../180

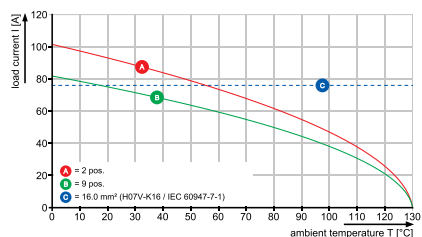

BUZ 10.16IT../180MF SH

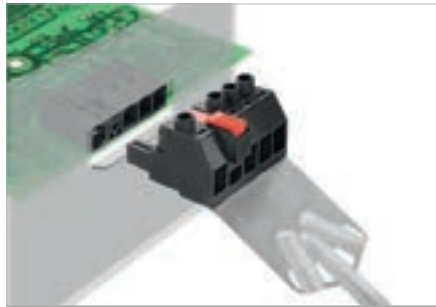

Female plug with 180° outlet direction for IT power networks. Meets the requirements of UL1059 for 600 V Use Group C. Leading PE contact in combination with the male header SU 7.62 IT. Meets the enhanced requirements for 5.5 mm of touch safety on IT power networks in acc. with IEC 61800-5-1 for 400 V relative to earth. The self-locking middle flange which can also be optionally screwed, reduces the space requirements by one pitch width compared to conventional solutions.

The pluggable shield connection has a wide contact area on the device housing and does not need to be bolted.

Technical data

In compliance with IEC 60664-1 / IEC 61984	
Clamping range, max.	mm² 0.2...16
Solid core H05(07) V-U	mm² 0.2...16
Stranded H07 V-R	...16
Flexible H05(07) V-K	mm² 0.5...16
Flexible with ferrule	mm² 0.25...16
Ferrule with plastic collar	mm² 0.25...16
Stripping length	mm 12
Screwdriver blade	mm
According to norm	
Tightening torque range	Nm 1.2...1.5
Rated current, max.	A 78.3 70.6
At ambient temperature	20°C 40°C
For conductor cross-section	mm² 16
Overvoltage category	III III II
Pollution severity	3 2 2
Rated voltage	V 1000 1000 1000
Rated impulse voltage	kV 8 8 6
UL / CUL (Use Group)	
Rated voltage	V 600 600 600
Rated current	A 60 60 5
AWG conductor	AWG 22-4
CSA (Use Group)	
Rated voltage	V 600 600 600
Rated current	A 60 60 5
AWG conductor	AWG 22-4
General data	
Type of insulation material	PA GF
UL 94 flammability rating	V-0
Contact base material	Copper alloy
Material of contact surface	silver-plated
Pin dimensions = d	mm
Solder eyelet Ø = D	mm
Solder eyelet Ø tolerance	mm

Product data

IEC: 1000 V / 78.3 A / 0.2 - 16 mm²
UL: 600 V / 60 A / AWG 22 - 4



For additional articles and information, refer to catalog.weidmuller.com

Note:

- Additional variants on request
- Rated current related to rated cross-section & min. No. of poles.
- Wire end ferrule with plastic collar to DIN 46228/4
- Wire end ferrule without plastic collar to DIN 46228/1
- P on drawing = pitch
- Rated data refer only to the component itself. Clearance and creepage distances to other components are to be designed in accordance with the relevant application standards.
- For all applications with flange we recommend to fix the pin header with the help of the soldering flange or a self-tapping screw on the board.
- Long term storage of the product with average temperature of 50 °C and average humidity 70%, 36 months

BUZ 10.16IT../180MF4 SH160



UL 600 V

Dimensioned drawing

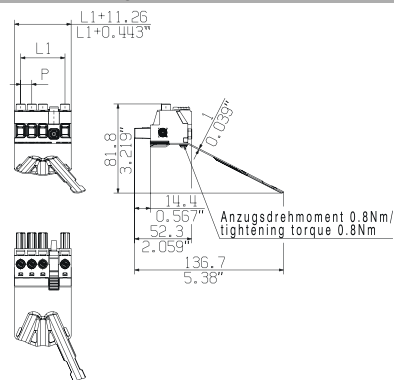

Accessories

Note: Refer to the Accessories chapter for additional accessories.

Coding	Order No.
KO BU/SU10.16HP BK	1824410000
KO BU/SU10.16HP WT	2592600000
Screwdriver	
SDIS 1.0X5.5X125	2749850000
Crosshead screwdriver	
SDIK PZ2 X 100	2749930000
SDK PZ2 X 100	2749450000

Ordering data

Solder pin length				
Colour	black			
Pitch 10.16 mm				
Pol.	L1	(inch)	Qty.	Order No.
4	40.64	1.600	20	2627370000

Representative dimensional drawing

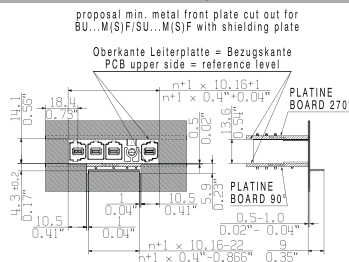

Representative deratings curve

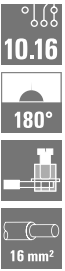
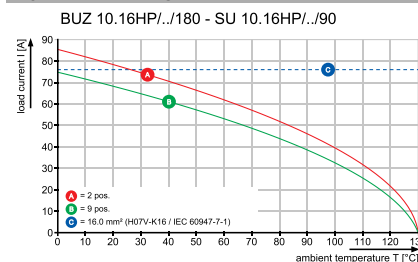

BUZ 10.16IT../180MF4 SH180

BUZ 10.16IT../180MF4 SH200



**UL
600V**

Dimensioned drawing

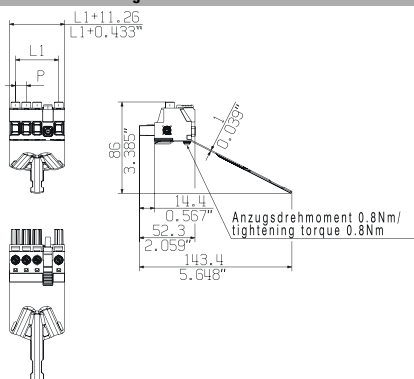

Ordering data

Solder pin length				
Colour	black			
Pitch	10.16 mm			
Pol.	L1	(inch)	Qty.	Order No.
4	40.64	1.600	20	2627420000

**UL
600V**

Dimensioned drawing

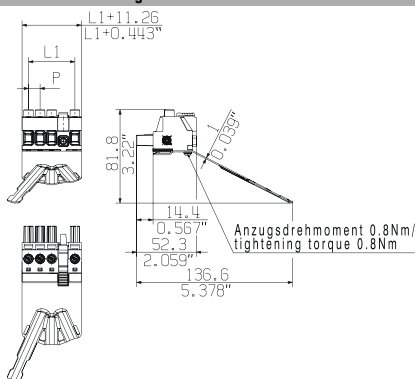

Ordering data

Solder pin length				
Colour	black			
Pitch	10.16 mm			
Pol.	L1	(inch)	Qty.	Order No.
4	40.64	1.600	20	2627470000

Additional deratings curves

BUZ 10.16HP../180 - SU 10.16HP../180

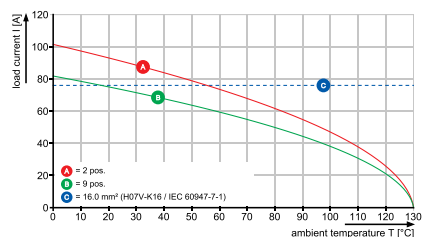

BUZ 10.16IT../180MSF2 SH180

BUZ 10.16IT../180MSF2 SH200



**UL
600V**

Dimensioned drawing

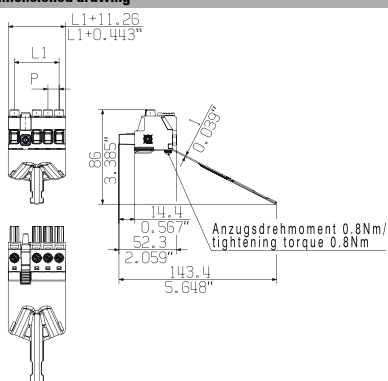

**UL
600V**

Dimensioned drawing

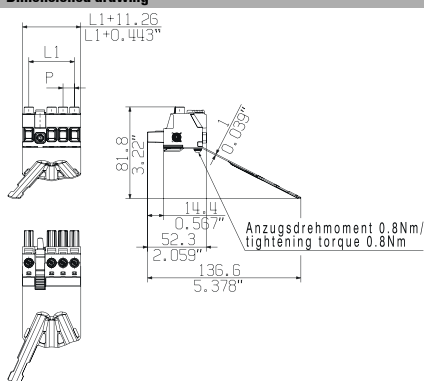

Ordering data

Solder pin length					
Colour					black
Pitch 10.16 mm					
Pol.	L1	(inch)	Qty.	Order No.	
3	30.48	1.200	20	2627530000	
4	40.64	1.600	20	2627540000	

Ordering data

Solder pin length					
Colour					black
Pitch 10.16 mm					
Pol.	L1	(inch)	Qty.	Order No.	
3	30.48	1.200	20	2627580000	
4	40.64	1.600	20	2627590000	

Additional deratings curves

BUZ 10.16HP../180 - SU 10.16HP../180

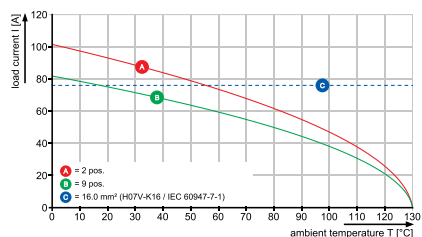

BUZ 10.16IT../180MSF SH

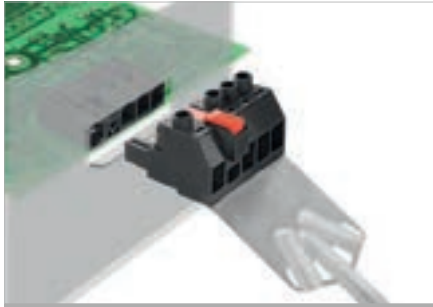

Female plug with 180° outlet direction for IT power networks. Meets the requirements of UL1059 for 600 V Use Group C. Leading PE contact in combination with the male header SU 7.62 IT. Meets the enhanced requirements for 5.5 mm of touch safety on IT power networks in acc. with IEC 61800-5-1 for 400 V relative to earth. The self-locking middle flange which can also be optionally screwed, reduces the space requirements by one pitch width compared to conventional solutions.

The pluggable shield connection has a wide contact area on the device housing and does not need to be bolted.

Technical data

In compliance with IEC 60664-1 / IEC 61984			
Clamping range, max.	mm ²	0.2...16	
Solid core H05(07) V-U	mm²	0.2...16	
Stranded H07 V-R		...16	
Flexible H05(07) V-K	mm ²	0.5...16	
Flexible with ferrule	mm ²	0.25...16	
Ferrule with plastic collar	mm ²	0.25...16	
Stripping length	mm	12	
Screwdriver blade	mm		
According to norm			
Tightening torque range	Nm	1.2...1.5	
Rated current, max.	A	78.3	70.6
At ambient temperature		20°C	40°C
For conductor cross-section	mm ²	16	
Overvoltage category		III	III II
Pollution severity		3	2 2
Rated voltage	V	1000	1000 1000
Rated impulse voltage	kV	8	8 6
UL / CUL (Use Group)			
Rated voltage	V	600	600 600
Rated current	A	60	60 5
AWG conductor	AWG	22-4	
CSA (Use Group)			
Rated voltage	V	600	600 600
Rated current	A	60	60 5
AWG conductor	AWG	22-4	
General data			
Type of insulation material		PA GF	
UL 94 flammability rating		V-0	
Contact base material		Copper alloy	
Material of contact surface		silver-plated	
Pin dimensions = d	mm		
Solder eyelet Ø = D	mm		
Solder eyelet Ø tolerance	mm		

Product data

IEC: 1000 V / 78.3 A / 0.2 - 16 mm²
UL: 600 V / 60 A / AWG 22 - 4



For additional articles and information, refer to catalog.weidmueller.com

Note:

- Additional variants on request
- Rated current related to rated cross-section & min. No. of poles.
- Wire end ferrule with plastic collar to DIN 46228/4
- Wire end ferrule without plastic collar to DIN 46228/1
- P on drawing = pitch
- Rated data refer only to the component itself. Clearance and creepage distances to other components are to be designed in accordance with the relevant application standards.
- For all applications with flange we recommend to fix the pin header with the help of the soldering flange or a self-tapping screw on the board.
- Long term storage of the product with average temperature of 50 °C and average humidity 70%, 36 months

BUZ 10.16IT../180MSF3 SH160



UL 600 V

Dimensioned drawing

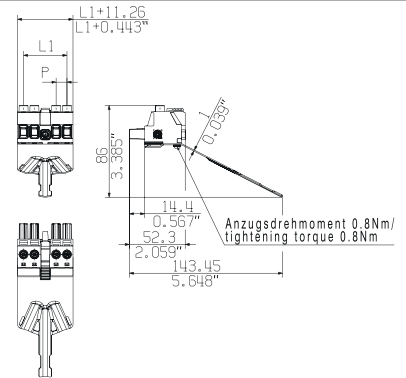

Accessories

Note: Refer to the Accessories chapter for additional accessories.

Coding		Order No.
	KO BU/SU10.16HP BK	18244 10000
	KO BU/SU10.16HP WT	259260000
Screwdriver		
	SDIS 1.0X5.5X125	2749850000
Crosshead screwdriver		
	SDIK PZ2 X 100	2749930000
	SDK PZ2 X 100	2749450000

Ordering data

Solder pin length					
Colour	black				
Pitch	10.16 mm				
Pol.	L1	(inch)	Qty.	Order No.	
3	30.48	1.200	20	2627500000	
4	40.64	1.600	20	26275 10000	

Representative dimensional drawing

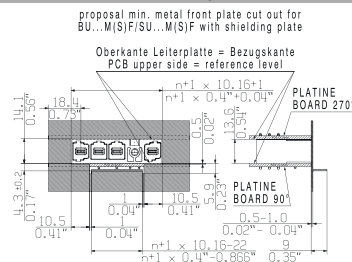

Representative deratings curve

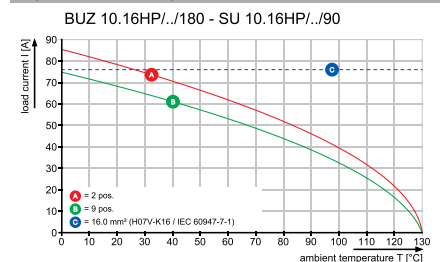

BUZ 10.16IT../180MSF3 SH180

BUZ 10.16IT../180MSF3 SH200



**UL
600V**

Dimensioned drawing

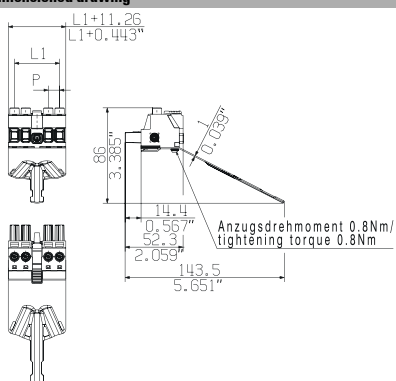

**UL
600V**

Dimensioned drawing

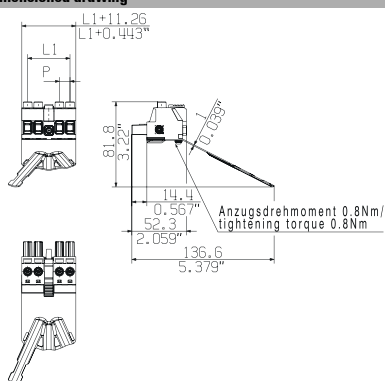

Ordering data

Solder pin length					
Colour					black
Pitch 10.16 mm					
Pol.	L1	(inch)	Qty.	Order No.	
3	30.48	1.200	20	2627550000	
4	40.64	1.600	20	2627560000	

Ordering data

Solder pin length					
Colour					black
Pitch 10.16 mm					
Pol.	L1	(inch)	Qty.	Order No.	
3	30.48	1.200	20	2627600000	
4	40.64	1.600	20	2627610000	

Additional deratings curves

BUZ 10.16HP../180 - SU 10.16HP../180

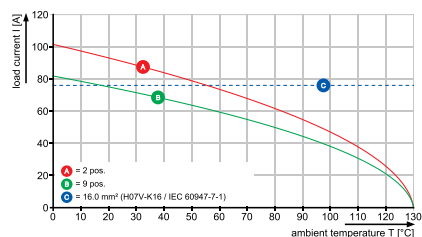

BUZ 10.16IT../180MSF4 SH180

BUZ 10.16IT../180MSF4 SH200



**UL
600V**

Dimensioned drawing

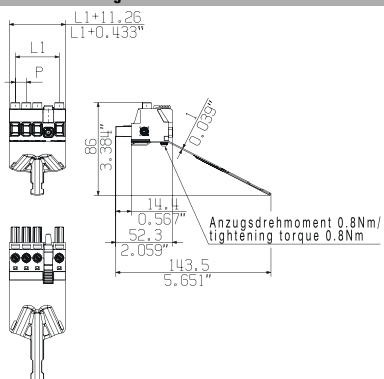

Ordering data

Solder pin length				
Colour	black			
Pitch	10.16 mm			
Pol.	L1	(inch)	Qty.	Order No.
4	40.64	1.600	20	2627570000

**UL
600V**

Dimensioned drawing

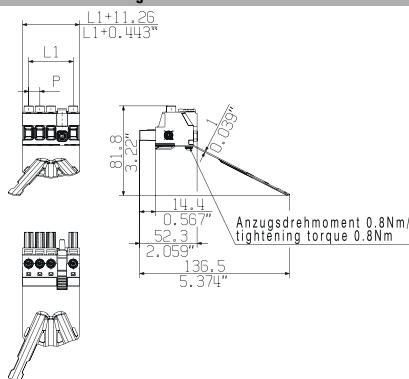

Ordering data

Solder pin length				
Colour	black			
Pitch	10.16 mm			
Pol.	L1	(inch)	Qty.	Order No.
4	40.64	1.600	20	2627620000

Additional deratings curves

BUZ 10.16HP../180 - SU 10.16HP../180

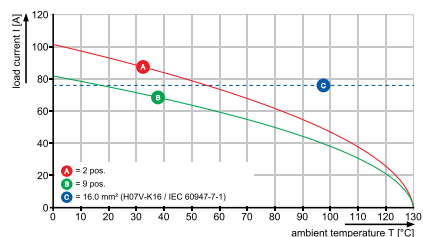

BUZ 10.16IT../180MF

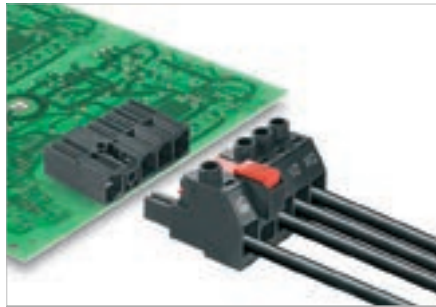

Female plug with 180° outlet direction for IT power networks. Meets the requirements of UL1059 for 600 V Use Group C. Leading PE contact in combination with the male header SU 7.62 IT. Meets the enhanced requirements for 5.5 mm of touch safety on IT power networks in acc. with IEC 61800-5-1 for 400 V relative to earth.

The self-locking middle flange which can also be optionally screwed, reduces the space requirements by one pitch width compared to conventional solutions.

Optionally available without middle flange interlock.

Product data

IEC: 1000 V / 78.3 A / 0.2 - 16 mm²
UL: 600 V / 60 A / AWG 22 - 4



For additional articles and information, refer to catalog.weidmueller.com

Note:

- Additional variants on request
- Rated current related to rated cross-section & min. No. of poles.
- Wire end ferrule with plastic collar to DIN 46228/4
- Wire end ferrule without plastic collar to DIN 46228/1
- P on drawing = pitch
- Rated data refer only to the component itself. Clearance and creepage distances to other components are to be designed in accordance with the relevant application standards.
- For all applications with flange we recommend to fix the pin header with the help of the soldering flange or a self-tapping screw on the board.
- Long term storage of the product with average temperature of 50 °C and average humidity 70%, 36 months

BUZ 10.16IT../180MF2



Dimensioned drawing

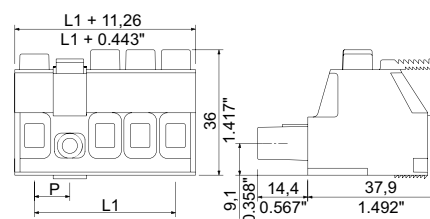

Technical data

In compliance with IEC 60664-1 / IEC 61984

Clamping range, max.	mm ²	0.2...16
Solid core H05(07) V-U	mm²	0.2...16
Stranded H07 V-R		...16
Flexible H05(07) V-K	mm ²	0.5...16
Flexible with ferrule	mm ²	0.25...16
Ferrule with plastic collar	mm ²	0.25...16
Stripping length	mm	12
Screwdriver blade	mm	1.0 x 5.5

According to norm

Tightening torque range	Nm	1.2...1.5
Rated current, max.	A	78.3 70.6
At ambient temperature		20°C 40°C

For conductor cross-section	mm ²	16
Overvoltage category		III III II
Pollution severity		3 2 2

Rated voltage	V	1000 1000 1000
Rated impulse voltage	kV	8 8 6

UL / CUL (Use Group)

Rated voltage	V	600 600 600
Rated current	A	60 60 5
AWG conductor	AWG	22-4

CSA (Use Group)

Rated voltage	V	600 600 600
Rated current	A	60 60 5
AWG conductor	AWG	22-4

General data

Type of insulation material	PA GF
UL 94 flammability rating	V-0
Contact base material	Copper alloy
Material of contact surface	silver-plated
Pin dimensions = d	mm
Solder eyelet Ø = D	mm
Solder eyelet Ø tolerance	mm

Accessories

Note: Refer to the Accessories chapter for additional accessories.

Coding	Order No.
KO BU/SU10.16HP BK	1824410000
KO BU/SU10.16HP WT	2592600000
Screwdriver	
SDIS 1.0X5.5X125	2749850000
Crosshead screwdriver	
SDIK PZ2 X 100	2749930000
SDK PZ2 X 100	2749450000

Ordering data

Solder pin length				
Colour	black			
Pitch	10.16 mm			
Pol.	L1	(inch)	Qty.	Order No.
2	20.32	0.800	30	1156600000
3	30.48	1.200	21	1156610000
4	40.64	1.600	18	1156630000

Representative deratings curve

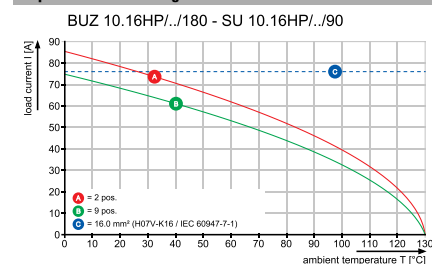

BUZ 10.16IT../180MF3



Dimensioned drawing

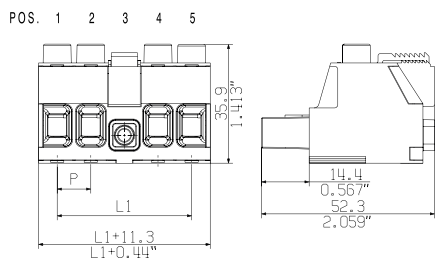

BUZ 10.16IT../180MF4



Dimensioned drawing

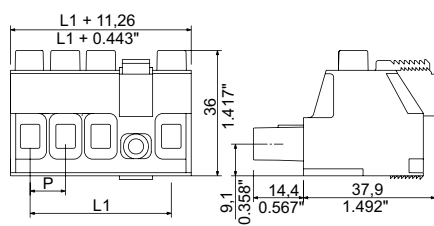

Ordering data

Solder pin length				
Colour	black			
Pitch	10.16 mm			
Pol.	L1	(inch)	Qty.	Order No.
3	30.48	1.200	21	1156620000
4	40.64	1.600	18	2000430000

Ordering data

Solder pin length				
Colour	black			
Pitch	10.16 mm			
Pol.	L1	(inch)	Qty.	Order No.
4	40.64	1.600	18	1156640000

Additional deratings curves

BUZ 10.16HP../180 - SU 10.16HP../180

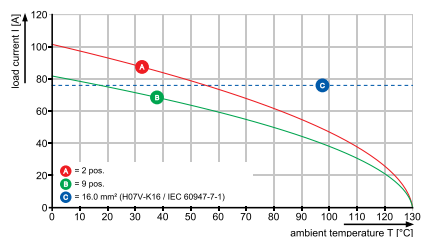

BUF 10.16IT../180MF SH

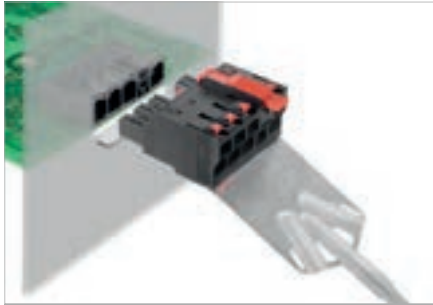

PUSH IN female plug with 180° outlet direction for IT power networks. Meets the requirements of UL1059 for 600 V Use Group C. Leading PE contact in combination with the male header SU 7.62 IT. Meets the enhanced requirements for 5.5 mm of touch safety on IT power networks in acc. with IEC 61800-5-1 for 400 V relative to earth. The self-locking middle flange which can also be optionally screwed, reduces the space requirements by one pitch width compared to conventional solutions.

The pluggable shield connection has a wide contact area on the device housing and does not need to be bolted.

Technical data

In compliance with IEC 60664-1 / IEC 61984			
Clamping range, max.	mm ²	2.5...16	
Solid core H05(07) V-U	mm²	2.5...10	
Stranded H07 V-R			
Flexible H05(07) V-K	mm ²	2.5...16	
Flexible with ferrule	mm ²	2.5...16	
Ferrule with plastic collar	mm ²	2.5...16	
Stripping length	mm	18	
Screwdriver blade	mm	0.8 x 4.0	
According to norm		DIN 5264	
Tightening torque range			
Rated current, max.	A	76	70
At ambient temperature		20°C	40°C
For conductor cross-section	mm ²	16	
Overvoltage category		III	III II
Pollution severity		3	2 2
Rated voltage	V	1000	1000 1000
Rated impulse voltage	kV	8	8 8
UL / CUL (Use Group)	B C D	B	C D
Rated voltage	V	600	600
Rated current	A	34	34
AWG conductor	AWG	12-6	
CSA (Use Group)	B C D	B	C D
Rated voltage	V		
Rated current	A		
AWG conductor	AWG		
General data			
Type of insulation material		PA GF	
UL 94 flammability rating		V-0	
Contact base material		Copper alloy	
Material of contact surface			
Pin dimensions = d	mm		
Solder eyelet Ø = D	mm		
Solder eyelet Ø tolerance	mm		

Product data

IEC: 1000 V / 76 A / 2.5 - 16 mm²
UL: 600 V / 34 A / AWG 12 - 6



For additional articles and information, refer to catalog.weidmueller.com

Note:

- Additional variants on request
- Rated current related to rated cross-section & min. No. of poles.
- Wire end ferrule with plastic collar to DIN 46228/4
- Wire end ferrule without plastic collar to DIN 46228/1
- P on drawing = pitch
- Rated data refer only to the component itself. Clearance and creepage distances to other components are to be designed in accordance with the relevant application standards.
- For all applications with flange we recommend to fix the pin header with the help of the soldering flange or a self-tapping screw on the board.
- Long term storage of the product with average temperature of 50 °C and average humidity 70%, 36 months

BUF 10.16IT../180MF2 SH160



Dimensioned drawing

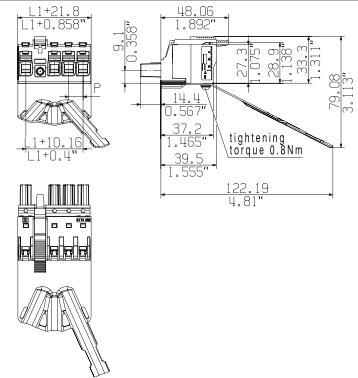

Accessories

Note: Refer to the Accessories chapter for additional accessories.

Coding	Order No.
KO BU/SU10.16HP BK	1824410000
KO BU/SU10.16HP WT	2592600000
Screwdriver	
SDS 0.8X4.5X125	2749370000

Ordering data

Solder pin length				
Colour	black			
Pitch	10.16 mm			
Pol.	L1	(inch)	Qty.	Order No.
3	30.48	1.200	20	2627260000
4	40.64	1.600	20	2627680000

Representative dimensional drawing

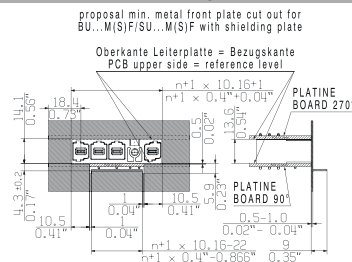

Representative deratings curve

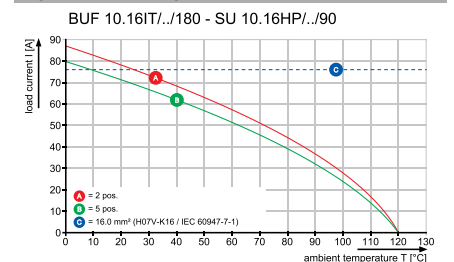

BUF 10.16IT../180MF2 SH180



Dimensioned drawing

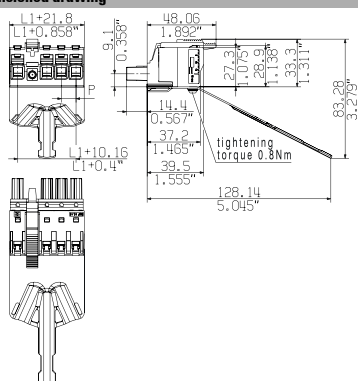

Ordering data

Solder pin length				
Colour	black			
Pitch	10.16 mm			
Pol.	L1	(inch)	Qty.	Order No.
3	30.48	1.200	20	2627710000
4	40.64	1.600	20	2627720000

BUF 10.16IT../180MF2 SH200



Dimensioned drawing

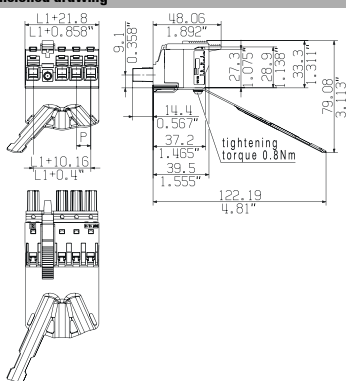

Ordering data

Solder pin length				
Colour	black			
Pitch	10.16 mm			
Pol.	L1	(inch)	Qty.	Order No.
3	30.48	1.200	20	2627760000
4	40.64	1.600	20	2627770000

Additional deratings curves

BUF 10.16IT../180 - SU 10.16HP../90

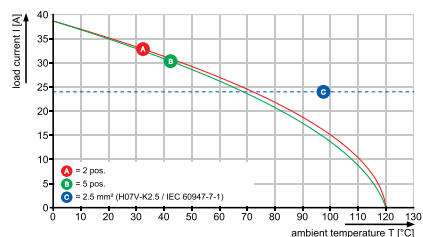

BUF 10.16IT../180MF SH

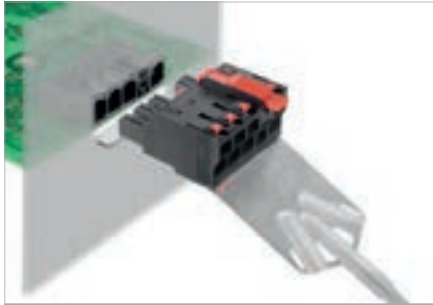

PUSH IN female plug with 180° outlet direction for IT power networks. Meets the requirements of UL1059 for 600 V Use Group C. Leading PE contact in combination with the male header SU 7.62 IT. Meets the enhanced requirements for 5.5 mm of touch safety on IT power networks in acc. with IEC 61800-5-1 for 400 V relative to earth. The self-locking middle flange which can also be optionally screwed, reduces the space requirements by one pitch width compared to conventional solutions.

The pluggable shield connection has a wide contact area on the device housing and does not need to be bolted.

Technical data

In compliance with IEC 60664-1 / IEC 61984			
Clamping range, max.	mm ²	2.5...16	
Solid core H05(07) V-U	mm²	2.5...10	
Stranded H07 V-R			
Flexible H05(07) V-K	mm ²	2.5...16	
Flexible with ferrule	mm ²	2.5...16	
Ferrule with plastic collar	mm ²	2.5...16	
Stripping length	mm	18	
Screwdriver blade	mm	0.8 x 4.0	
According to norm		DIN 5264	
Tightening torque range			
Rated current, max.	A	76	70
At ambient temperature		20°C	40°C
For conductor cross-section	mm ²	16	
Overvoltage category		III	III II
Pollution severity		3	2 2
Rated voltage	V	1000	1000 1000
Rated impulse voltage	kV	8	8 8
UL / CUL (Use Group)	B C D	B	C D
Rated voltage	V	600	600
Rated current	A	34	34
AWG conductor	AWG	12-6	
CSA (Use Group)	B C D	B	C D
Rated voltage	V		
Rated current	A		
AWG conductor	AWG		
General data			
Type of insulation material		PA GF	
UL 94 flammability rating		V-0	
Contact base material		Copper alloy	
Material of contact surface			
Pin dimensions = d	mm		
Solder eyelet Ø = D	mm		
Solder eyelet Ø tolerance	mm		

Product data

IEC: 1000 V / 76 A / 2.5 - 16 mm²
UL: 600 V / 34 A / AWG 12 - 6



For additional articles and information, refer to catalog.weidmueller.com

Note:

- Additional variants on request
- Rated current related to rated cross-section & min. No. of poles.
- Wire end ferrule with plastic collar to DIN 46228/4
- Wire end ferrule without plastic collar to DIN 46228/1
- P on drawing = pitch
- Rated data refer only to the component itself. Clearance and creepage distances to other components are to be designed in accordance with the relevant application standards.
- For all applications with flange we recommend to fix the pin header with the help of the soldering flange or a self-tapping screw on the board.
- Long term storage of the product with average temperature of 50 °C and average humidity 70%, 36 months

BUF 10.16IT../180MF3 SH160



Dimensioned drawing

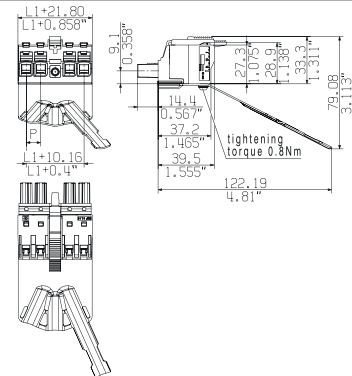

Accessories

Note: Refer to the Accessories chapter for additional accessories.

Coding	Order No.
KO BU/SU10.16HP BK	1824410000
KO BU/SU10.16HP WT	2592600000
Screwdriver	
SDS 0.8X4.5X125	2749370000

Ordering data

Solder pin length				
Colour	black			
Pitch	10.16 mm			
Pol.	L1	(inch)	Qty.	Order No.
3	30.48	1.200	20	2627690000
4	40.64	1.600	20	2627700000

Representative dimensional drawing

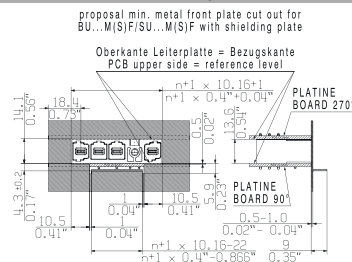

Representative deratings curve

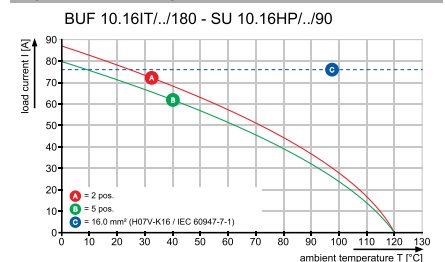

BUF 10.16IT../180MF3 SH180

BUF 10.16IT../180MF3 SH200



Dimensioned drawing

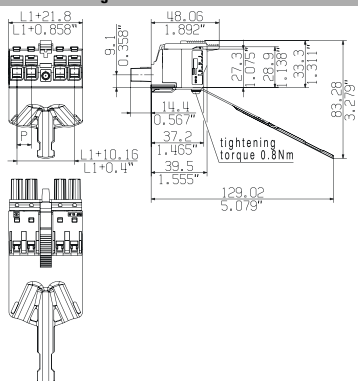

Ordering data

Solder pin length					
Colour					black
Pitch 10.16 mm					
Pol.	L1	(inch)	Qty.	Order No.	
3	30.48	1.200	20	2627730000	
4	40.64	1.600	20	2627740000	



Dimensioned drawing

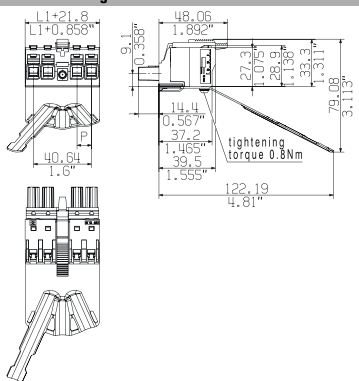

Ordering data

Solder pin length					
Colour					black
Pitch 10.16 mm					
Pol.	L1	(inch)	Qty.	Order No.	
3	30.48	1.200	20	2627780000	
4	40.64	1.600	20	2627790000	

Additional deratings curves

BUF 10.16IT../180 - SU 10.16HP../90

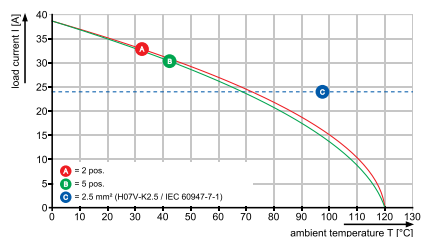

Connectors for IT power networks, pitch 10.16 mm
BU/SU 10.16 IT series - connection up to 16 mm²

BUF 10.16IT../180MF SH

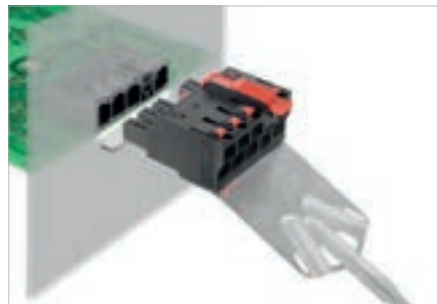

PUSH IN female plug with 180° outlet direction for IT power networks. Meets the requirements of UL1059 for 600 V Use Group C. Leading PE contact in combination with the male header SU 7.62 IT. Meets the enhanced requirements for 5.5 mm of touch safety on IT power networks in acc. with IEC 61800-5-1 for 400 V relative to earth. The self-locking middle flange which can also be optionally screwed, reduces the space requirements by one pitch width compared to conventional solutions.

The pluggable shield connection has a wide contact area on the device housing and does not need to be bolted.

Technical data

In compliance with IEC 60664-1 / IEC 61984			
Clamping range, max.	mm ²	2.5...16	
Solid core H05(07) V-U	mm ²	2.5...10	
Stranded H07 V-R			
Flexible H05(07) V-K	mm ²	2.5...16	
Flexible with ferrule	mm ²	2.5...16	
Ferrule with plastic collar	mm ²	2.5...16	
Stripping length	mm	18	
Screwdriver blade	mm	0.8 x 4.0	
According to norm		DIN 5264	
Tightening torque range			
Rated current, max.	A	76	70
At ambient temperature		20°C	40°C
For conductor cross-section	mm ²	16	
Overvoltage category		III	III II
Pollution severity		3	2 2
Rated voltage	V	1000	1000 1000
Rated impulse voltage	kV	8	8 8
UL / CUL (Use Group)	B C D	B	C D
Rated voltage	V	600	600
Rated current	A	34	34
AWG conductor	AWG	12-6	
CSA (Use Group)	B C D	B	C D
Rated voltage	V		
Rated current	A		
AWG conductor	AWG		
General data			
Type of insulation material		PA GF	
UL 94 flammability rating		V-0	
Contact base material		Copper alloy	
Material of contact surface			
Pin dimensions = d	mm		
Solder eyelet Ø = D	mm		
Solder eyelet Ø tolerance	mm		

Product data

IEC: 1000 V / 76 A / 2.5 - 16 mm²
 UL: 600 V / 34 A / AWG 12 - 6



For additional articles and information, refer to catalog.weidmuller.com

Note:

- Additional variants on request
- Rated current related to rated cross-section & min. No. of poles.
- Wire end ferrule with plastic collar to DIN 46228/4
- Wire end ferrule without plastic collar to DIN 46228/1
- P on drawing = pitch
- Rated data refer only to the component itself. Clearance and creepage distances to other components are to be designed in accordance with the relevant application standards.
- For all applications with flange we recommend to fix the pin header with the help of the soldering flange or a self-tapping screw on the board.
- Long term storage of the product with average temperature of 50 °C and average humidity 70%, 36 months

BUF 10.16IT../180MF4 SH160



Dimensioned drawing

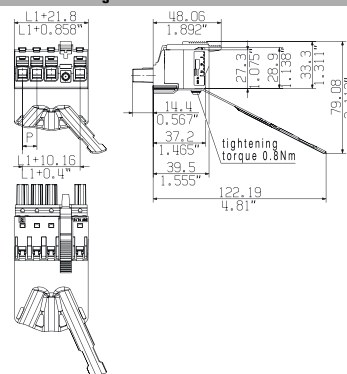

Accessories

Note: Refer to the Accessories chapter for additional accessories.

Coding	Order No.
KO BU/SU10.16HP BK	1824410000
KO BU/SU10.16HP WT	2592600000
Screwdriver	
SDS 0.8X4.5X125	2749370000

Ordering data

Solder pin length				
Colour				
Pitch	10.16 mm			
Pol.	L1	(inch)	Qty.	Order No.
4			20	2638870000

Representative dimensional drawing

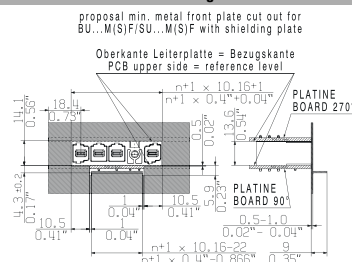

Representative deratings curve

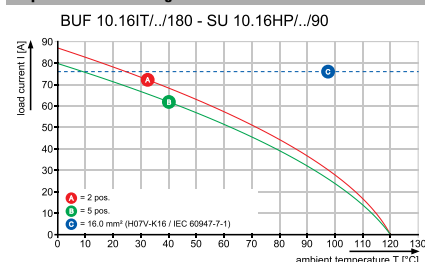

BUF 10.16IT../180MF4 SH180



Dimensioned drawing

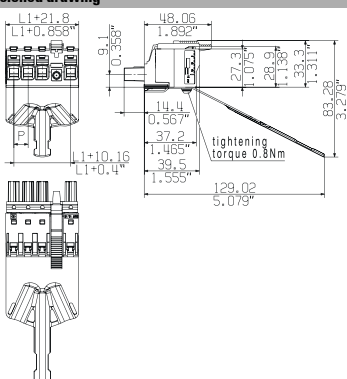

Ordering data

Solder pin length				
Colour	black			
Pitch	10.16 mm			
Pol.	L1	(inch)	Qty.	Order No.
4	40.64	1.600	20	2627750000

BUF 10.16IT../180MF4 SH200



Dimensioned drawing

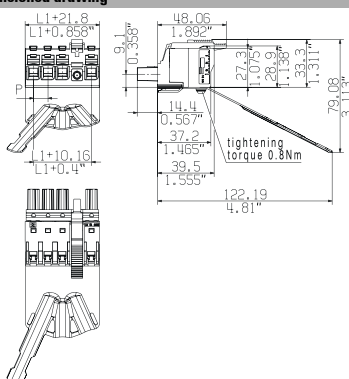

Ordering data

Solder pin length				
Colour	black			
Pitch	10.16 mm			
Pol.	L1	(inch)	Qty.	Order No.
4	40.64	1.600	20	2627800000

Additional deratings curves

BUF 10.16IT../180 - SU 10.16HP../90

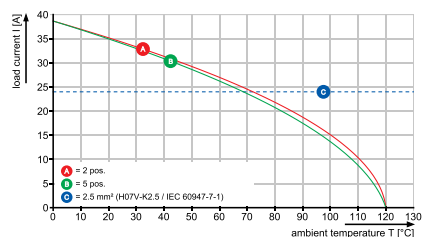

BUF 10.16IT../180MSF SH

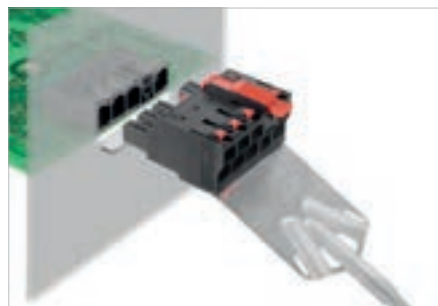

PUSH IN female plug with 180° outlet direction for IT power networks. Meets the requirements of UL1059 for 600 V Use Group C. Leading PE contact in combination with the male header SU 7.62 IT. Meets the enhanced requirements for 5.5 mm of touch safety on IT power networks in acc. with IEC 61800-5-1 for 400 V relative to earth. The self-locking middle flange which can also be optionally screwed, reduces the space requirements by one pitch width compared to conventional solutions.

The pluggable shield connection has a wide contact area on the device housing and does not need to be bolted.

Technical data

In compliance with IEC 60664-1 / IEC 61984			
Clamping range, max.	mm ²	2.5...16	
Solid core H05(07) V-U	mm²	2.5...10	
Stranded H07 V-R		...16	
Flexible H05(07) V-K	mm ²	2.5...16	
Flexible with ferrule	mm ²	2.5...16	
Ferrule with plastic collar	mm ²	2.5...16	
Stripping length	mm	18	
Screwdriver blade	mm	0.8 x 4.0	
According to norm		DIN 5264	
Tightening torque range			
Rated current, max.	A	76	70
At ambient temperature		20°C	40°C
For conductor cross-section	mm ²	16	
Overvoltage category		III	III II
Pollution severity		3	2 2
Rated voltage	V	1000	1000 1000
Rated impulse voltage	kV	8	8 8
UL / CUL (Use Group)	B C D	B	C D
Rated voltage	V	600	600
Rated current	A	34	34
AWG conductor	AWG	12-6	
CSA (Use Group)	B C D	B	C D
Rated voltage	V		
Rated current	A		
AWG conductor	AWG		
General data			
Type of insulation material		PA GF	
UL 94 flammability rating		V-0	
Contact base material		Copper alloy	
Material of contact surface			
Pin dimensions = d	mm		
Solder eyelet Ø = D	mm		
Solder eyelet Ø tolerance	mm		

Product data

IEC: 1000 V / 76 A / 2.5 - 16 mm²
UL: 600 V / 34 A / AWG 12 - 6



For additional articles and information, refer to catalog.weidmueller.com

Note:

- Additional variants on request
- Rated current related to rated cross-section & min. No. of poles.
- Wire end ferrule with plastic collar to DIN 46228/4
- Wire end ferrule without plastic collar to DIN 46228/1
- P on drawing = pitch
- Rated data refer only to the component itself. Clearance and creepage distances to other components are to be designed in accordance with the relevant application standards.
- For all applications with flange we recommend to fix the pin header with the help of the soldering flange or a self-tapping screw on the board.
- Long term storage of the product with average temperature of 50 °C and average humidity 70%, 36 months

BUF 10.16IT../180MSF2 SH160



Dimensioned drawing

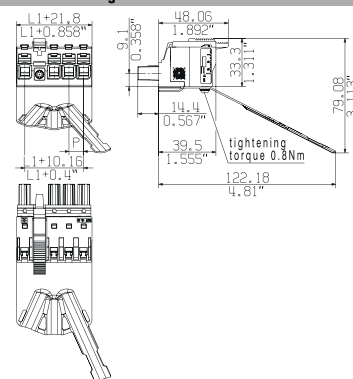

Accessories

Note: Refer to the Accessories chapter for additional accessories.

Coding	Order No.
KO BU/SU10.16HP BK	1824410000
KO BU/SU10.16HP WT	2592600000
Screwdriver	
SDS 0.8X4.5X125	2749370000

Ordering data

Solder pin length				
Colour	black			
Pitch	10.16 mm			
Pol.	L1	(inch)	Qty.	Order No.
3	30.48	1.200	20	2627810000
4	40.64	1.600	20	2627820000

Representative dimensional drawing

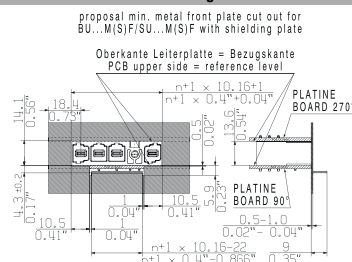

Representative deratings curve

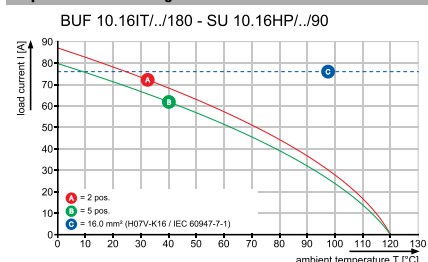

BUF 10.16IT../180MSF2 SH180



Dimensioned drawing

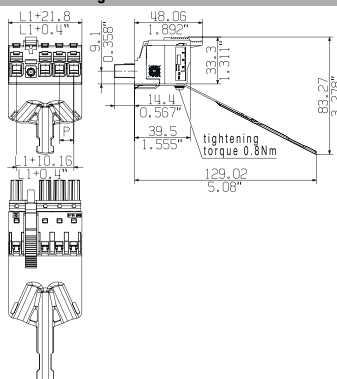

Ordering data

Solder pin length					
Colour					black
Pitch 10.16 mm					
Pol.	L1	(inch)	Qty.	Order No.	
3	30.48	1.200	20	2627860000	
4	40.64	1.600	20	2627870000	

BUF 10.16IT../180MSF2 SH200



Dimensioned drawing

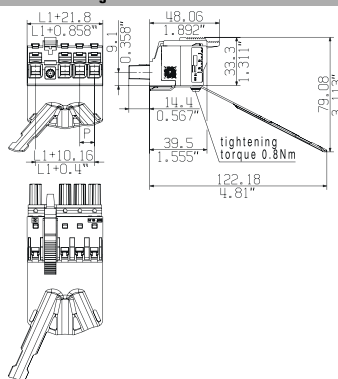

Ordering data

Solder pin length					
Colour					black
Pitch 10.16 mm					
Pol.	L1	(inch)	Qty.	Order No.	
3	30.48	1.200	20	2627910000	
4	40.64	1.600	20	2627920000	

Additional deratings curves

BUF 10.16IT../180 - SU 10.16HP../90

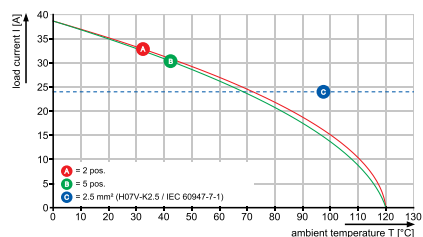

BUF 10.16IT../180MSF SH

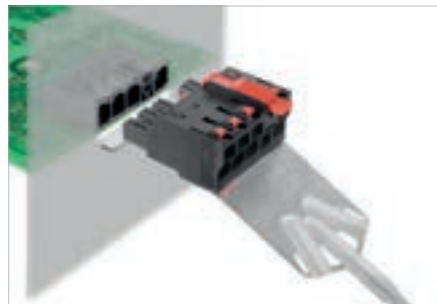

PUSH IN female plug with 180° outlet direction for IT power networks. Meets the requirements of UL1059 for 600 V Use Group C. Leading PE contact in combination with the male header SU 7.62 IT. Meets the enhanced requirements for 5.5 mm of touch safety on IT power networks in acc. with IEC 61800-5-1 for 400 V relative to earth. The self-locking middle flange which can also be optionally screwed, reduces the space requirements by one pitch width compared to conventional solutions.

The pluggable shield connection has a wide contact area on the device housing and does not need to be bolted.

Technical data

In compliance with IEC 60664-1 / IEC 61984			
Clamping range, max.	mm ²	2.5...16	
Solid core H05(07) V-U	mm²	2.5...10	
Stranded H07 V-R		...16	
Flexible H05(07) V-K	mm ²	2.5...16	
Flexible with ferrule	mm ²	2.5...16	
Ferrule with plastic collar	mm ²	2.5...16	
Stripping length	mm	18	
Screwdriver blade	mm	0.8 x 4.0	
According to norm		DIN 5264	
Tightening torque range			
Rated current, max.	A	76	70
At ambient temperature		20°C	40°C
For conductor cross-section	mm ²	16	
Overvoltage category		III	III II
Pollution severity		3	2 2
Rated voltage	V	1000	1000 1000
Rated impulse voltage	kV	8	8 8
UL / CUL (Use Group)	B C D	B	C D
Rated voltage	V	600	600
Rated current	A	34	34
AWG conductor	AWG	12-6	
CSA (Use Group)	B C D	B	C D
Rated voltage	V		
Rated current	A		
AWG conductor	AWG		
General data			
Type of insulation material		PA GF	
UL 94 flammability rating		V-0	
Contact base material		Copper alloy	
Material of contact surface			
Pin dimensions = d	mm		
Solder eyelet Ø = D	mm		
Solder eyelet Ø tolerance	mm		

Product data

IEC: 1000 V / 76 A / 2.5 - 16 mm²
UL: 600 V / 34 A / AWG 12 - 6



For additional articles and information, refer to catalog.weidmueller.com

Note:

- Additional variants on request
- Rated current related to rated cross-section & min. No. of poles.
- Wire end ferrule with plastic collar to DIN 46228/4
- Wire end ferrule without plastic collar to DIN 46228/1
- P on drawing = pitch
- Rated data refer only to the component itself. Clearance and creepage distances to other components are to be designed in accordance with the relevant application standards.
- For all applications with flange we recommend to fix the pin header with the help of the soldering flange or a self-tapping screw on the board.
- Long term storage of the product with average temperature of 50 °C and average humidity 70%, 36 months

BUF 10.16IT../180MSF3 SH160



Dimensioned drawing

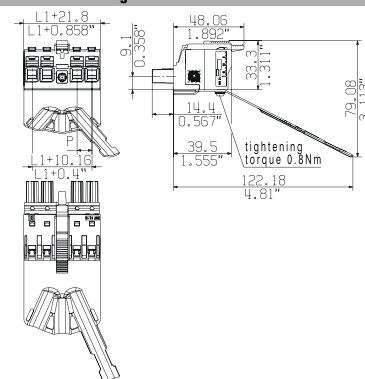

Accessories

Note: Refer to the Accessories chapter for additional accessories.

Coding	Order No.
KO BU/SU10.16HP BK	1824410000
KO BU/SU10.16HP WT	2592600000
Screwdriver	
SDS 0.8X4.5X125	2749370000

Ordering data

Solder pin length				
Colour	black			
Pitch	10.16 mm			
Pol.	L1	(inch)	Qty.	Order No.
3	30.48	1.200	20	2627830000
4	40.64	1.600	20	2627840000

Representative dimensional drawing

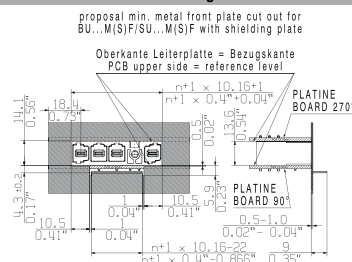

Representative deratings curve

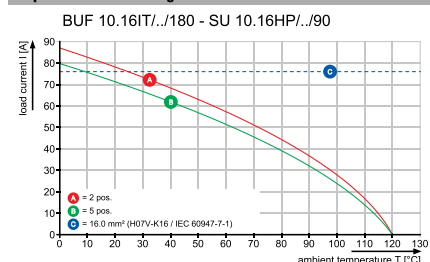

BUF 10.16IT../180MSF3 SH180



BUF 10.16IT../180MSF3 SH200



Dimensioned drawing

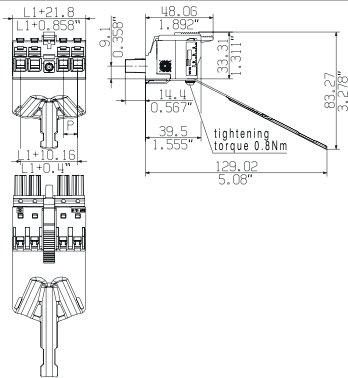

Ordering data

Solder pin length				
Colour	black			
Pitch	10.16 mm			
Pol.	L1	(inch)	Qty.	Order No.
3	30.48	1.200	20	2627880000
4	40.64	1.600	20	2627890000



Dimensioned drawing

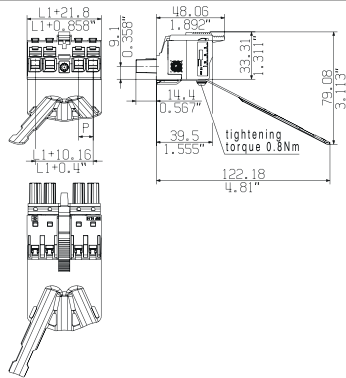

Ordering data

Solder pin length				
Colour	black			
Pitch	10.16 mm			
Pol.	L1	(inch)	Qty.	Order No.
3	30.48	1.200	20	2627930000
4	40.64	1.600	20	2627940000

Additional deratings curves

BUF 10.16IT../180 - SU 10.16HP../90

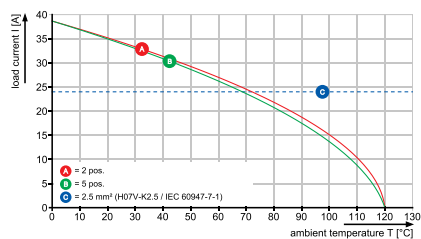

BUF 10.16IT../180MSF SH

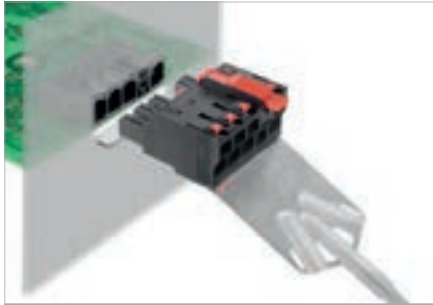

PUSH IN female plug with 180° outlet direction for IT power networks. Meets the requirements of UL1059 for 600 V Use Group C. Leading PE contact in combination with the male header SU 7.62 IT. Meets the enhanced requirements for 5.5 mm of touch safety on IT power networks in acc. with IEC 61800-5-1 for 400 V relative to earth. The self-locking middle flange which can also be optionally screwed, reduces the space requirements by one pitch width compared to conventional solutions.

The pluggable shield connection has a wide contact area on the device housing and does not need to be bolted.

Technical data

In compliance with IEC 60664-1 / IEC 61984			
Clamping range, max.	mm ²	2.5...16	
Solid core H05(07) V-U	mm²	2.5...10	
Stranded H07 V-R		...16	
Flexible H05(07) V-K	mm ²	2.5...16	
Flexible with ferrule	mm ²	2.5...16	
Ferrule with plastic collar	mm ²	2.5...16	
Stripping length	mm	18	
Screwdriver blade	mm	0.8 x 4.0	
According to norm		DIN 5264	
Tightening torque range			
Rated current, max.	A	76	70
At ambient temperature		20°C	40°C
For conductor cross-section	mm ²	16	
Overvoltage category		III	III II
Pollution severity		3	2 2
Rated voltage	V	1000	1000 1000
Rated impulse voltage	kV	8	8 8
UL / CUL (Use Group)	B C D		
Rated voltage	V	600	600
Rated current	A	34	34
AWG conductor	AWG	12-6	
CSA (Use Group)	B C D		
Rated voltage	V		
Rated current	A		
AWG conductor	AWG		
General data			
Type of insulation material		PA GF	
UL 94 flammability rating		V-0	
Contact base material		Copper alloy	
Material of contact surface			
Pin dimensions = d	mm		
Solder eyelet Ø = D	mm		
Solder eyelet Ø tolerance	mm		

Product data

IEC: 1000 V / 76 A / 2.5 - 16 mm²
UL: 600 V / 34 A / AWG 12 - 6



For additional articles and information, refer to catalog.weidmueller.com

Note:

- Additional variants on request
- Rated current related to rated cross-section & min. No. of poles.
- Wire end ferrule with plastic collar to DIN 46228/4
- Wire end ferrule without plastic collar to DIN 46228/1
- P on drawing = pitch
- Rated data refer only to the component itself. Clearance and creepage distances to other components are to be designed in accordance with the relevant application standards.
- For all applications with flange we recommend to fix the pin header with the help of the soldering flange or a self-tapping screw on the board.
- Long term storage of the product with average temperature of 50 °C and average humidity 70%, 36 months

BUF 10.16IT../180MSF4 SH160



Dimensioned drawing

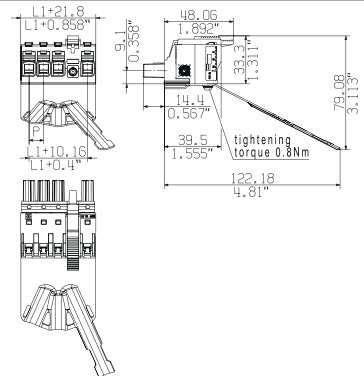

Accessories

Note: Refer to the Accessories chapter for additional accessories.

Coding	Order No.
KO BU/SU10.16HP BK	1824410000
KO BU/SU10.16HP WT	2592600000
Screwdriver	
SDS 0.8X4.5X125	2749370000

Ordering data

Solder pin length				
Colour	black			
Pitch	10.16 mm			
Pol.	L1	(inch)	Qty.	Order No.
4	40.64	1.600	20	2627850000

Representative dimensional drawing

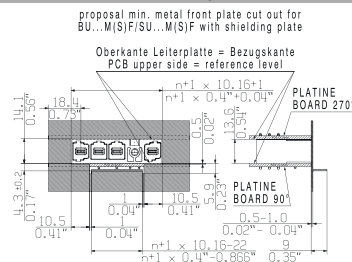

Representative deratings curve

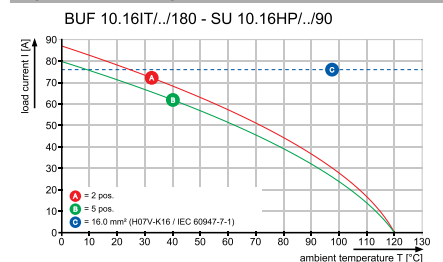

BUF 10.16IT../180MSF4 SH180



Dimensioned drawing

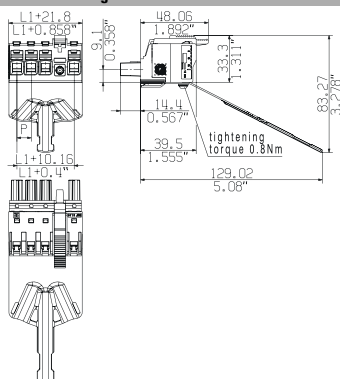

Ordering data

Solder pin length				
Colour	black			
Pitch	10.16 mm			
Pol.	L1	(inch)	Qty.	Order No.
4	40.64	1.600	20	2627900000

BUF 10.16IT../180MSF4 SH200



Dimensioned drawing

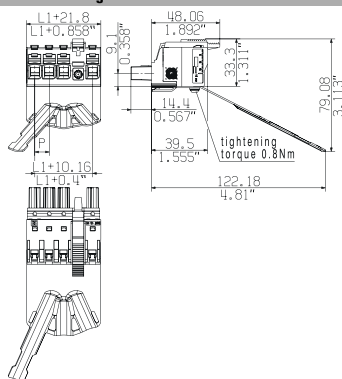

Ordering data

Solder pin length				
Colour	black			
Pitch	10.16 mm			
Pol.	L1	(inch)	Qty.	Order No.
4	40.64	1.600	20	2627950000

Additional deratings curves

BUF 10.16IT../180 - SU 10.16HP../90

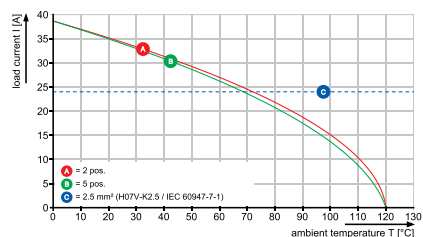

BUF 10.16IT../180MF

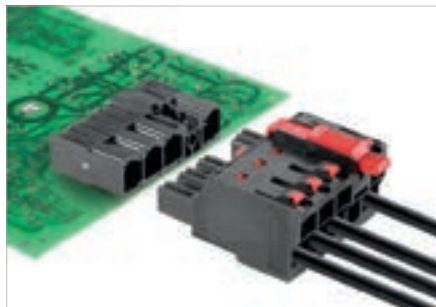

PUSH IN female plug in 180° outlet direction for IT networks. Fulfills the requirements of UL1059 for 600 V Use Group C with leading PE contact when used with SU 10.16IT male header. Fulfills the expanded requirements for 5.5 mm of touch protection (400 V relative to earth), according to IEC 61800-5-1.

The middle flange interlocks automatically and is optionally available with screw connection. It decreases the space required by one pole when compared to other solutions.

Available optionally without middle flange interlock.

Technical data

In compliance with IEC 60664-1 / IEC 61984

Clamping range, max.	mm ²	2.5...16
Solid core H05(07) V-U	mm²	2.5...10
Stranded H07 V-R		
Flexible H05(07) V-K	mm ²	2.5...16
Flexible with ferrule	mm ²	2.5...16
Ferrule with plastic collar	mm ²	2.5...16
Stripping length	mm	18
Screwdriver blade	mm	0.8 x 4.0
According to norm		DIN 5264
Tightening torque range		
Rated current, max.	A	76 70
At ambient temperature		20°C 40°C
For conductor cross-section	mm ²	16
Overvoltage category		III III II
Pollution severity		3 2 2
Rated voltage	V	1000 1000 1000
Rated impulse voltage	kV	8 8 8
UL / CUL (Use Group)	B C D	B C D
Rated voltage	V	600 600
Rated current	A	34 34
AWG conductor	AWG	12-6
CSA (Use Group)	B C D	B C D
Rated voltage	V	
Rated current	A	
AWG conductor	AWG	-

General data

Type of insulation material	PA GF
UL 94 flammability rating	V-0
Contact base material	Copper alloy
Material of contact surface	silver-plated
Pin dimensions = d	mm
Solder eyelet Ø = D	mm
Solder eyelet Ø tolerance	mm

Product data

IEC: 1000 V / 76 A / 2.5 - 16 mm²
UL: 600 V / 34 A / AWG 12 - 6



For additional articles and information, refer to catalog.weidmuller.com

Note:

- Additional variants on request
- Rated current related to rated cross-section & min. No. of poles.
- Wire end ferrule with plastic collar to DIN 46228/4
- Wire end ferrule without plastic collar to DIN 46228/1
- P on drawing = pitch
- Rated data refer only to the component itself. Clearance and creepage distances to other components are to be designed in accordance with the relevant application standards.
- For all applications with flange we recommend to fix the pin header with the help of the soldering flange or a self-tapping screw on the board.
- Long term storage of the product with average temperature of 50 °C and average humidity 70%, 36 months

BUF 10.16IT../180MF2



Dimensioned drawing

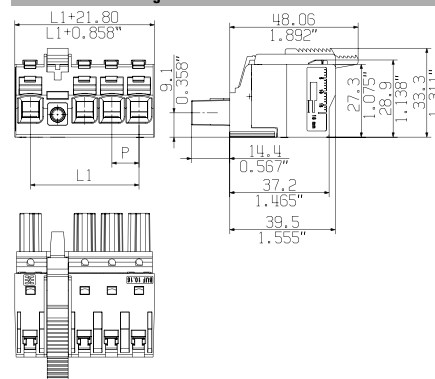

Ordering data

Solder pin length			
Colour	black		
Pitch	10.16 mm		
Pol.	L1	(inch)	Qty. Order No.
2	20.32	0.800	36 2493160000
3	30.48	1.200	28 2493180000
4	40.64	1.600	24 2493200000
5	50.80	2.000	36 2586660000
6	60.96	2.400	50 2586770000

Accessories

Note: Refer to the Accessories chapter for additional accessories.

Coding	Order No.
KO BU/SU10.16HP BK	1824410000
KO BU/SU10.16HP WT	2592600000
Screwdriver	
SDS 0.8X4.5X125	2749370000

Representative deratings curve

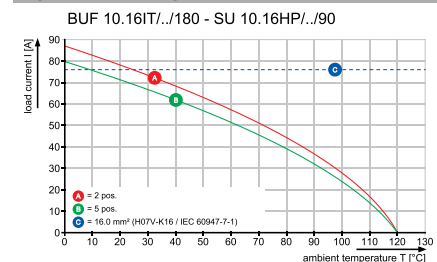

BUF 10.16IT../180MF3



Dimensioned drawing

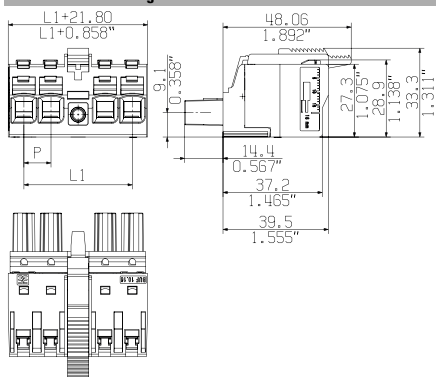

Ordering data

Solder pin length					
Colour					black
Pitch 10.16 mm					
Pol.	L1	(inch)	Qty.	Order No.	
3	30.48	1.200	28	2493190000	
4	40.64	1.600	24	2493210000	
5	50.80	2.000	50	2586700000	
6	60.96	2.400	50	2586780000	

BUF 10.16IT../180MF4



Dimensioned drawing

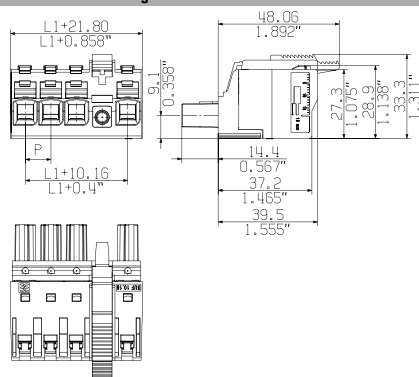

Ordering data

Solder pin length					
Colour					black
Pitch 10.16 mm					
Pol.	L1	(inch)	Qty.	Order No.	
4	40.64	1.600	24	2544950000	
5	50.80	2.000	50	2586710000	
6	60.96	2.400	50	2586790000	

Additional deratings curves

BUF 10.16IT../180 - SU 10.16HP../90

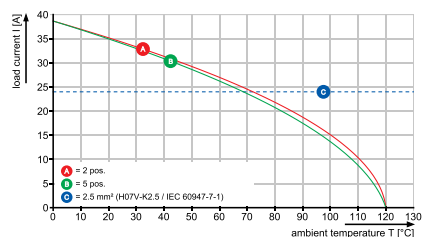

BUF 10.16IT../180MSF



PUSH IN female plug in 180° outlet direction for IT networks. Fulfills the requirements of UL1059 for 600 V Use Group C with leading PE contact when used with SU 10.16IT male header. Fulfills the expanded requirements for 5.5 mm of touch protection (400 V relative to earth), according to IEC 61800-5-1.

The middle flange interlocks automatically and is optionally available with screw connection. It decreases the space required by one pole when compared to other solutions.

Available optionally without middle flange interlock.

Technical data

In compliance with IEC 60664-1 / IEC 61984

Clamping range, max.	mm ²	2.5...16
Solid core H05(07) V-U	mm²	2.5...10
Stranded H07 V-R		
Flexible H05(07) V-K	mm ²	2.5...16
Flexible with ferrule	mm ²	2.5...16
Ferrule with plastic collar	mm ²	2.5...16
Stripping length	mm	18
Screwdriver blade	mm	0.8 x 4.0
According to norm		DIN 5264
Tightening torque range		
Rated current, max.	A	76 70
At ambient temperature		20°C 40°C
For conductor cross-section	mm ²	16
Overvoltage category		III III II
Pollution severity		3 2 2
Rated voltage	V	1000 1000 1000
Rated impulse voltage	kV	8 8 8
UL / CUL (Use Group)	B C D	B C D
Rated voltage	V	600 600
Rated current	A	34 34
AWG conductor	AWG	12-6
CSA (Use Group)	B C D	B C D
Rated voltage	V	
Rated current	A	
AWG conductor	AWG	-

General data

Type of insulation material	PA GF
UL 94 flammability rating	V-0
Contact base material	Copper alloy
Material of contact surface	silver-plated
Pin dimensions = d	mm
Solder eyelet Ø = D	mm
Solder eyelet Ø tolerance	mm

Product data

IEC: 1000 V / 76 A / 2.5 - 16 mm²
UL: 600 V / 34 A / AWG 12 - 6



For additional articles and information, refer to catalog.weidmueller.com

Note:

- Additional variants on request
- Rated current related to rated cross-section & min. No. of poles.
- Wire end ferrule with plastic collar to DIN 46228/4
- Wire end ferrule without plastic collar to DIN 46228/1
- P on drawing = pitch
- Rated data refer only to the component itself. Clearance and creepage distances to other components are to be designed in accordance with the relevant application standards.
- For all applications with flange we recommend to fix the pin header with the help of the soldering flange or a self-tapping screw on the board.
- Long term storage of the product with average temperature of 50 °C and average humidity 70%, 36 months

BUF 10.16IT../180MSF2



Dimensioned drawing

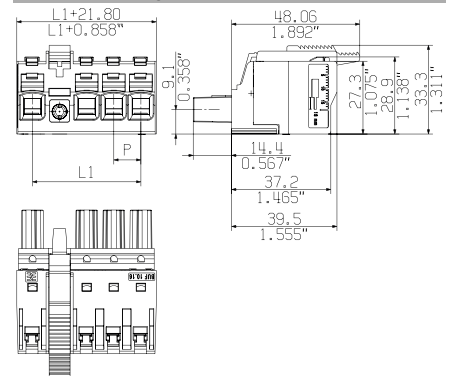

Accessories

Note: Refer to the Accessories chapter for additional accessories.

Coding	Order No.
KO BU/SU10.16HP BK	1824410000
KO BU/SU10.16HP WT	2592600000
Screwdriver	
SDS 0.8X4.5X125	2749370000

Ordering data

Solder pin length		black	
Colour			
Pitch	10.16 mm		
Pol.	L1 (inch)	Qty.	Order No.
2	20.32 0.800	36	2493230000
3	30.48 1.200	28	2493240000
4	40.64 1.600	24	2493260000
5	50.80 2.000	50	2586730000
6	60.96 2.400	50	2586820000

Representative deratings curve

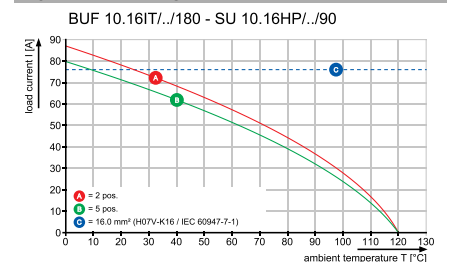

BUF 10.16IT../180MSF3



Dimensioned drawing

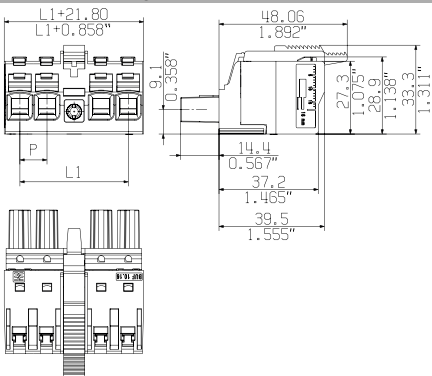

Ordering data

Solder pin length					
Colour					black
Pitch 10.16 mm					
Pol.	L1	(inch)	Qty.	Order No.	
3	30.48	1.200	28	2493250000	
4	40.64	1.600	24	2493270000	
5	50.80	2.000	50	2586740000	
6	60.96	2.400	50	2586830000	

BUF 10.16IT../180MSF4



Dimensioned drawing

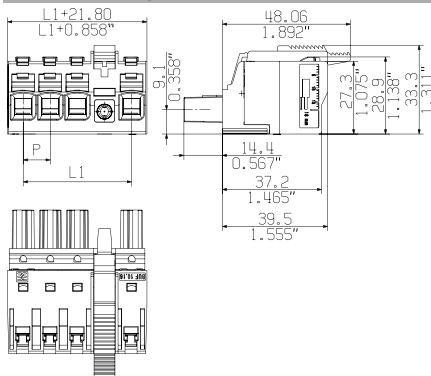

Ordering data

Solder pin length					
Colour					black
Pitch 10.16 mm					
Pol.	L1	(inch)	Qty.	Order No.	
4	40.64	1.600	24	2493280000	
5	50.80	2.000	50	2586750000	
6	60.96	2.400	50	2586840000	

Additional deratings curves

BUF 10.16IT../180 - SU 10.16HP../90

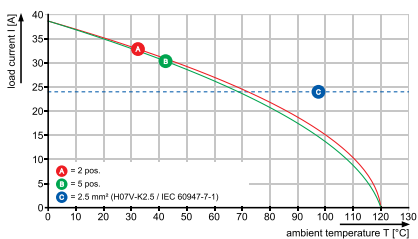

OMNIMATE® Power BL/SL 7.62HP – power class up to 2.55 mm² and 24 A

Custom-fit solutions for compact devices

Compact power for more safety and efficiency: The compact class in the OMNIMATE® Power BL/SL 7.62HP power connector series integrates previously-conflicting market requirements to provide a custom-fit solution for drive applications.

This closes the gap between increasing miniaturisation and unlimited 600 V UL approval. The system extension to the 12 kVA power class enables a touch-safe, inverted motor connection with one-handed safety interlock. The PUSH INconnection system also provides a quick and reliable wire connection. Doublesided touch protection guarantees full protection even with inverse voltages. Thus even OMNIMATE® Power's compact class is qualified for use with the DC link bus.

Compact safety

No additional measures required for DC links or inverse voltage: the inverted versions have finger-safe male header and female header even when not plugged in.



Compact reliability

Maintenance-free and vibration-proof connections: quick and simple PUSH IN connections, or the self-fastening Weidmüller steel clamp with plus/minus screw and "Wire Guard".

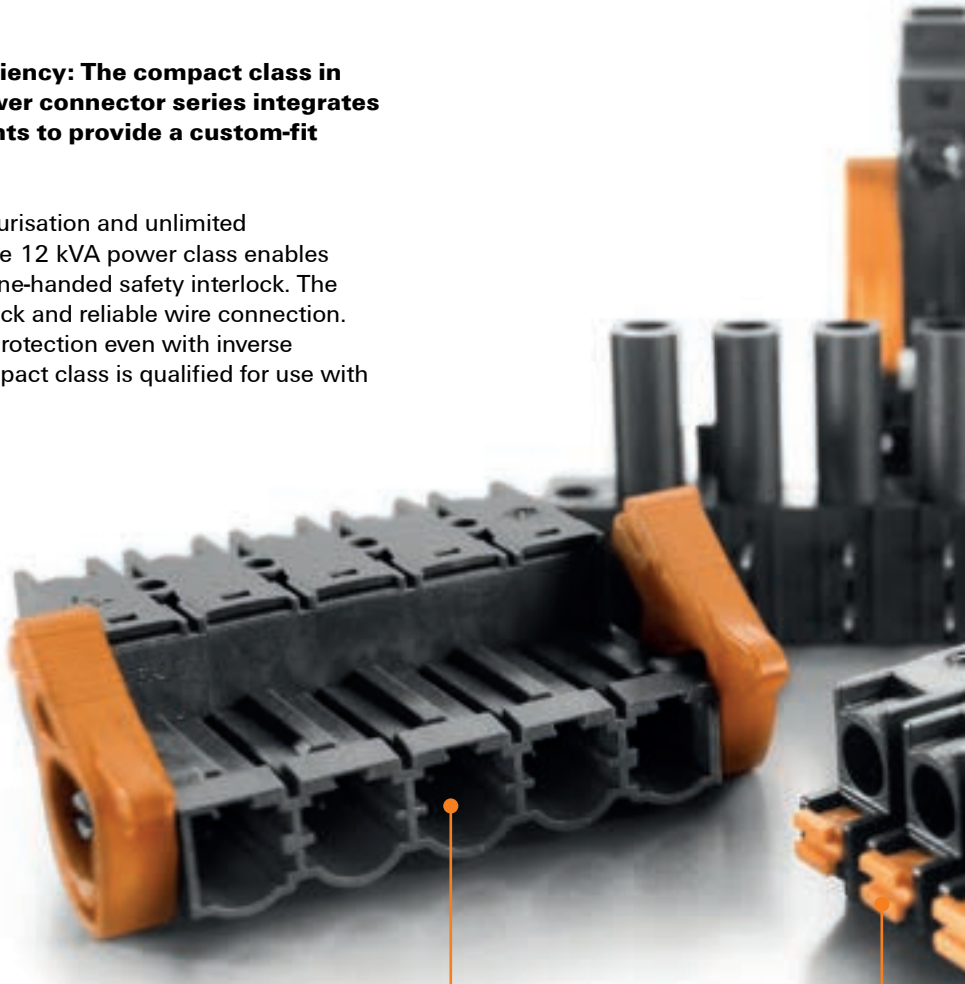

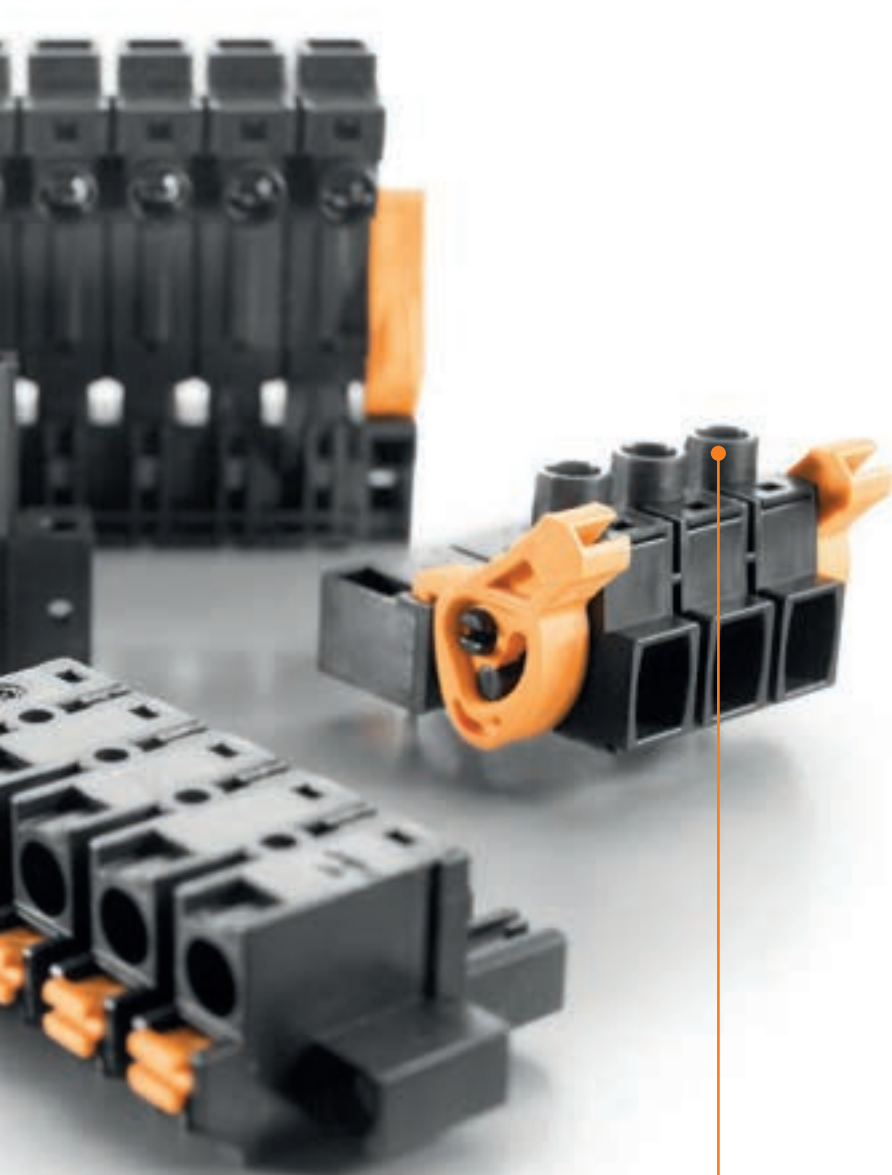

Compact integration

No compromises during design and approval: compact and standard-compliant with additional + 3.0 mm finger safety, according to IEC 61800-5-1, and increased creepage and clearance distances according to UL.

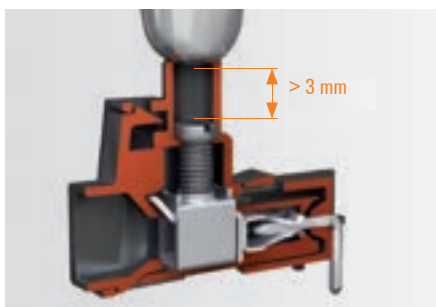

Compact system power

An overview of OMNIMATE® Power's 12 kVA class: The compact system with either standard or inverted mating profile, with screw or PUSH IN wire connection; optionally with lock & release lever, screw flange or one-handed safety interlock.

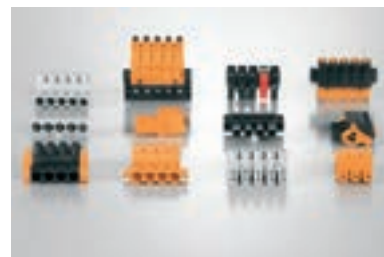

Unrivalled current-carrying capacity

The highest load capacity in the 12 kVA compact class: with up to 29 A current-carrying capacity at 1.000 V (IEC) with a 4 mm² wire cross-section or 18.5 A at 600 V according to UL.



Individualised configuration

Standard + Services = custom design with simple configuration across the entire range of services: features include colour coding, application-oriented labelling and custom modifications or design. More information can be found at <http://galaxy.weidmueller.com>



Ergonomic operation and simple front design

OMNIMATE® Power opens up new 270° perspectives

With modular devices, the PCBs are often perpendicular, i.e. located on the right and left, close to the housing wall. Hence the need to arrange the male header in the device so that it points to the middle.

P

To avoid the need to change the direction of access during installation, we have developed a 270° male header. The combination of two opposing PCBs inside the housing, one with a 90° and the other with a 270° pin header. This allows you to keep the screwdriver comfortably in your right hand when wiring.

In addition to the ergonomic operation without the need to change hands, the consistent alignment of the connections also means that the layout of the front panel is particularly simple and clear.

Your special advantages:

Compact and powerful

We offer you the smallest plug-in PUSH IN connection solution for field wiring up to 600 V UL with a connection cross-section of AWG 12 (2.5 mm²).



The solder flange solution for the pin connector on the PCB and the possible flange fixing of the plug section simplify the use of complex device applications with high mechanical demands

Simple design, standard operation

All PUSH IN connection components on the front panel are aligned in the same direction thanks to the 270° male header. This allows a continuous operation with the right hand.



A strong team

Especially in industrial applications in a vibration environment, the combination of female header BLF7.62HP for 600 V UL and male header SL7.62HP are convincing as a strong "PUSH IN" solution.



<http://www.OMNIMATE.net>

○ = Wire-to-Board
 ● = Board-to-Board
 ○ = Wire-to-Wire
 ● = Board-to-Wire

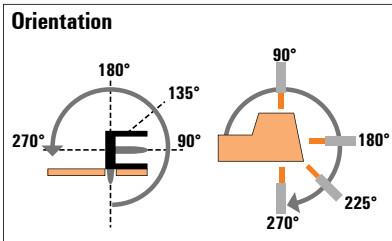

Male header

Solder connection



BL/SL 7.62 series



Type	SL	SL
Orientation	90°/270°	180°
Flange options	G/F/LF	G/F/LF
Product code numbers	IEC: 800 V/24 A UL: 300 V/20 A	IEC: 800 V/24 A UL: 300 V/20 A

Category	Icon	Model	Orientation	Flange options	IEC Rating	UL Rating	SL	SL
Female plug		BLZ	180°	(G)/LR	IEC: 630 V/24 A/0.08 - 2.5 mm ²	UL: 600 V/20 A/AWG 20 - 12	○	○
		BLF	180°	(G)/F/LR	IEC: 1.000 V/24 A/0.08 - 2.5 mm ²	UL: 300 V/20 A/AWG 20	○	○
Female header		BLL	90°	(G)/F/LF	IEC: 630 V/24 A	UL: 300 V/20 A		
		BLL	180°	(G)/F/LF	IEC: 630 V/24 A	UL: 300 V/20 A		
Stiftstecker		SLF SH	180°	(G)/F/LR	IEC: 1.000 V/24 A/0,08 - 2,5 mm ²	UL: 300 V/20 A/AWG 20	○	○

Female plug and header:
 (G) = Closed (without flange)
 F = Screw flange with screw
 LR = Lock & Release lever

Male header and plug:
 G = Closed (without flange)
 F = Screw flange with nut
 LF = Solder flange with nut
 LR = Lock & Release lever

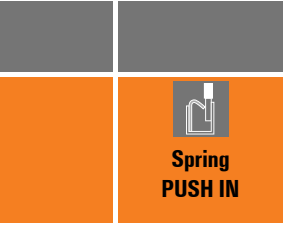

SLF
180°
G/F/LR
IEC: 1.000 V/24 A/ 0.08 - 2.5 mm ² UL: 600 V/20 A/ AWG 20 - 12
●
●

Connectors, pitch 7.62 mm
BL/SL 7.62 series - connection up to 2.5 mm²

SL 7.62HP/./90

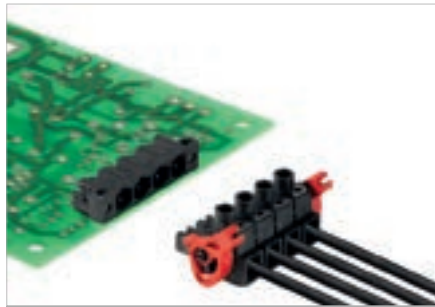

Male header with 90° outlet direction. The compact and efficient solution for UL-600 V applications in the lower power range in combination with a female plug fulfils the requirements for 600 V acc. to UL508 / UL840 and the enhanced electric shock protection requirements acc. to IEC 68100-5-1.

Variants: flange and solder flanges versions.

Product data

IEC: 630 V / 29 A
 UL: 300 V / 20 A



For additional articles and information, refer to catalog.weidmuller.com

Note:

- Additional variants on request
- Gold-plated contact surfaces on request
- Rated current related to rated cross-section & min. No. of poles.
- P on drawing = pitch
- Rated data refer only to the component itself. Clearance and creepage distances to other components are to be designed in accordance with the relevant application standards.
- Long term storage of the product with average temperature of 50 °C and average humidity 70%, 36 months

SL 7.62HP/./90G



Dimensioned drawing

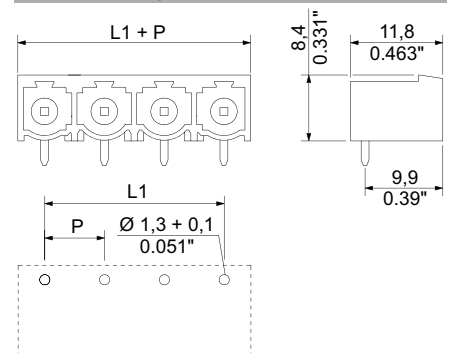

Technical data

In compliance with IEC 60664-1 / IEC 61984

Clamping range, max.			
Solid core H05(07) V-U			
Stranded H07 V-R			
Flexible H05(07) V-K			
Flexible with ferrule			
Ferrule with plastic collar			
Stripping length			
Screwdriver blade	mm		
According to norm			
Tightening torque range			
Rated current, max.	A	29	25
At ambient temperature		20°C	40°C
For conductor cross-section			
Overtoltage category		III	III II
Pollution severity		3	2 2
Rated voltage	V	400	500 630
Rated impulse voltage	kV	6	6 6
UL / CUL (Use Group)		B	C D
Rated voltage	V	300	300 600
Rated current	A	20	20 5
AWG conductor	AWG		-
CSA (Use Group)		B	C D
Rated voltage	V	300	300 600
Rated current	A	20	20 5
AWG conductor	AWG		-
General data			
Type of insulation material		PBT	
UL 94 flammability rating		V-0	
Contact base material		Copper alloy	
Material of contact surface		tinned	
Pin dimensions = d	mm	1.0 x 1.0	
Solder eyelet Ø = D	mm	1.3	
Solder eyelet Ø tolerance	mm	+ 0,1	

Accessories

Note: Refer to the Accessories chapter for additional accessories.

Coding	Order No.
BLZ/SL KO OR BX	1573010000
BLZ/SL KO BK BX	1545710000

Ordering data

Solder pin length		3.2 mm		
Colour		black		
Pitch		7.62 mm		
Pol.	L1	(inch)	Qty.	Order No.
2	7.62	0.300	100	1026760000
3	15.24	0.600	100	1026770000
4	22.86	0.900	100	1026780000
5	30.48	1.200	50	1026790000
6	38.10	1.500	50	1059490000
7	45.72	1.800	50	1059500000
8	53.34	2.100	50	1059510000
9	60.96	2.400	50	1059520000
10	68.58	2.700	50	1059530000
11	76.20	3.000	50	1059550000
12	83.82	3.300	50	1059570000

SL 7.62HP/./90F



Dimensioned drawing

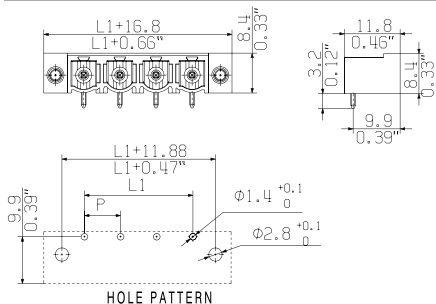

SL 7.62HP/./90LF



Dimensioned drawing

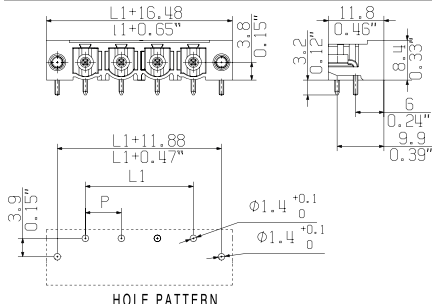

Ordering data

Solder pin length		3.2 mm			
Colour		black			
Pitch		7.62 mm			
Pol.	L1	(inch)	Qty.	Order No.	
2	7.62	0.300	72	1026850000	
3	15.24	0.600	54	1026860000	
4	22.86	0.900	42	1026870000	
5	30.48	1.200	36	1026880000	
6	38.10	1.500	30	1124250000	
7	45.72	1.800	24	1124270000	
8	53.34	2.100	24	1124280000	
9	60.96	2.400	24	1124290000	
10	68.58	2.700	18	1124300000	
11	76.20	3.000	18	1124310000	
12	83.82	3.300	18	1124320000	

Ordering data

Solder pin length		3.2 mm			
Colour		black			
Pitch		7.62 mm			
Pol.	L1	(inch)	Qty.	Order No.	
2	7.62	0.300	72	1095920000	
3	15.24	0.600	54	1095930000	
4	22.86	0.900	42	1095940000	
5	30.48	1.200	36	1095950000	
6	38.10	1.500	30	1095960000	
7	45.72	1.800	30	1095970000	
8	53.34	2.100	24	1095980000	
9	60.96	2.400	24	1095990000	
10	68.58	2.700	18	1096000000	
11	76.20	3.000	18	1096010000	
12	83.82	3.300	18	1096020000	

Connectors, pitch 7.62 mm
BL/SL 7.62 series - connection up to 2.5 mm²

SL 7.62HP/./180

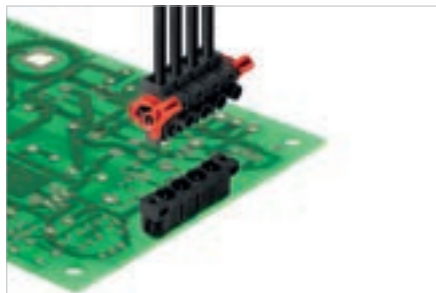

Male header with 180° outlet direction. The compact and efficient solution for UL-600 V applications in the lower power range fulfils, in combination with a female plug, the requirements for 600 V in acc. with UL508-5-1 / UL840 and the enhanced electric shock protection requirements in acc. with IEC 68100-5-1.

Variants: flanges and solder flange versions.

Product data

IEC: 630 V / 29 A
 UL: 300 V / 20 A



For additional articles and information, refer to catalog.weidmuller.com

Note:

- Additional variants on request
- Gold-plated contact surfaces on request
- Rated current related to rated cross-section & min. No. of poles.
- P on drawing = pitch
- Rated data refer only to the component itself. Clearance and creepage distances to other components are to be designed in accordance with the relevant application standards.
- Long term storage of the product with average temperature of 50 °C and average humidity 70%, 36 months

SL 7.62HP/./180G



Dimensioned drawing

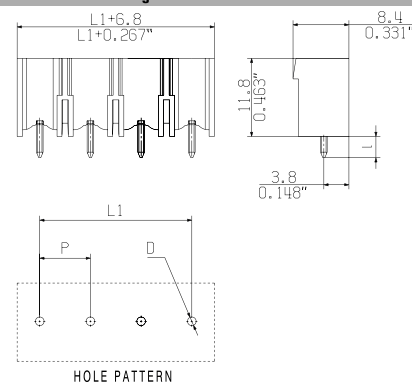

Technical data

In compliance with IEC 60664-1 / IEC 61984			
Clamping range, max.			
Solid core H05(07) V-U			
Stranded H07 V-R			
Flexible H05(07) V-K			
Flexible with ferrule			
Ferrule with plastic collar			
Stripping length			
Screwdriver blade	mm		
According to norm			
Tightening torque range			
Rated current, max.	A	29	25
At ambient temperature		20°C	40°C
For conductor cross-section			
Overvoltage category		III	III II
Pollution severity		3	2 2
Rated voltage	V	400	500 630
Rated impulse voltage	kV	6	6 6
UL / CUL (Use Group)		B	C D
Rated voltage	V	300	300 600
Rated current	A	20	20 5
AWG conductor	AWG		-
CSA (Use Group)		B	C D
Rated voltage	V	300	300 600
Rated current	A	20	20 5
AWG conductor	AWG		-
General data			
Type of insulation material		PBT	
UL 94 flammability rating		V-0	
Contact base material		Copper alloy	
Material of contact surface		tinned	
Pin dimensions = d	mm	1.0 x 1.0	
Solder eyelet Ø = D	mm	1.3	
Solder eyelet Ø tolerance	mm	+ 0,1	

Accessories

Note: Refer to the Accessories chapter for additional accessories.

Coding	Order No.
BLZ/SL KO OR BX	1573010000
BLZ/SL KO BK BX	1545710000

Ordering data

Solder pin length		3.2 mm		
Colour		black		
Pitch		7.62 mm		
Pol.	L1	(inch)	Qty.	Order No.
2	7.62	0.300	100	1122550000
3	15.24	0.600	100	1122570000
4	22.86	0.900	100	1122580000
5	30.48	1.200	50	1048980000
6	38.10	1.500	50	1048990000
7	45.72	1.800	50	1122590000
8	53.34	2.100	50	1049000000
9	60.96	2.400	50	1122600000
10	68.58	2.700	50	1122610000
11	76.20	3.000	50	1122640000
12	83.82	3.300	50	1122650000

SL 7.62HP../180F



Dimensioned drawing

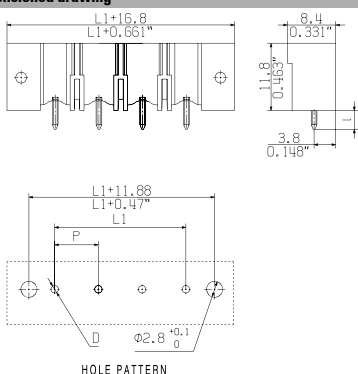

Ordering data

Solder pin length		3.2 mm			
Colour		black			
Pitch		7.62 mm			
Pol.	L1	(inch)	Qty.	Order No.	
2	7.62	0.300	72	1140870000	
3	15.24	0.600	54	1140880000	
4	22.86	0.900	42	1140890000	
5	30.48	1.200	36	1140900000	
6	38.10	1.500	30	1140910000	
7	45.72	1.800	24	1140920000	
8	53.34	2.100	24	1140930000	
9	60.96	2.400	24	1140940000	
10	68.58	2.700	18	1140950000	
11	76.20	3.000	18	1140960000	
12	83.82	3.300	18	1140970000	

SL 7.62HP../180LF



Dimensioned drawing

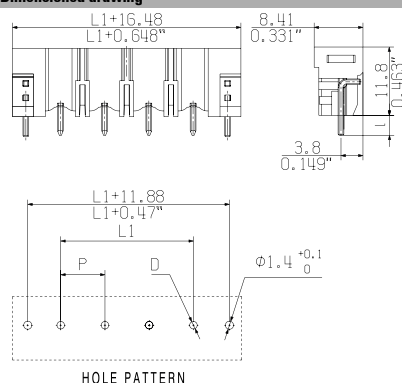

Ordering data

Solder pin length		3.2 mm			
Colour		black			
Pitch		7.62 mm			
Pol.	L1	(inch)	Qty.	Order No.	
2	7.62	0.300	72	1141090000	
3	15.24	0.600	54	1141100000	
4	22.86	0.900	42	1141110000	
5	30.48	1.200	36	1141120000	
6	38.10	1.500	30	1141130000	
7	45.72	1.800	30	1141140000	
8	53.34	2.100	24	1141150000	
9	60.96	2.400	24	1141160000	
10	68.58	2.700	18	1141170000	
11	76.20	3.000	18	1141180000	
12	83.82	3.300	18	1141190000	

Connectors, pitch 7.62 mm
BL/SL 7.62 series - connection up to 2.5 mm²

SL 7.62HP/././270



Pin header with 270° outlet direction. This compact solution for UL-600 V applications in the lower performance range meets the requirements for 600 V in accordance with UL 508 / UL 840 as well as the more stringent touch-safety requirements of IEC 68100-5-1 for electrical drive systems when combined with a female plug.

Variants: solder flange versions.

Product data

IEC: 630 V / 27.5 A
 UL: 300 V / 20 A



For additional articles and information, refer to catalog.weidmueller.com

Note:

- Additional variants on request
- Gold-plated contact surfaces on request
- Rated current related to rated cross-section & min. No. of poles.
- P on drawing = pitch
- Rated data refer only to the component itself. Clearance and creepage distances to other components are to be designed in accordance with the relevant application standards.
- Long term storage of the product with average temperature of 50 °C and average humidity 70%, 36 months

SL 7.62HP/270G



Dimensioned drawing

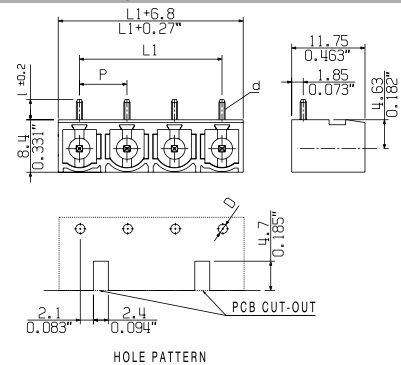

Technical data

In compliance with IEC 60664-1 / IEC 61984

Clamping range, max.			
Solid core H05(07) V-U			
Stranded H07 V-R			
Flexible H05(07) V-K			
Flexible with ferrule			
Ferrule with plastic collar			
Stripping length			
Screwdriver blade	mm		
According to norm			
Tightening torque range			
Rated current, max.	A	27.5	25
At ambient temperature		20°C	40°C
For conductor cross-section			
Overtoltage category		III	III II
Pollution severity		3	2 2
Rated voltage	V	400	500 630
Rated impulse voltage	kV	4	6 6
UL / CUL (Use Group)		B	C D
Rated voltage	V	300	300 600
Rated current	A	20	20 5
AWG conductor	AWG		-
CSA (Use Group)		B	C D
Rated voltage	V	300	300 600
Rated current	A	20	20 5
AWG conductor	AWG		-
General data			
Type of insulation material		PA GF	
UL 94 flammability rating		V-0	
Contact base material		Copper alloy	
Material of contact surface			
Pin dimensions = d	mm	1.0 x 1.0	
Solder eyelet Ø = D	mm	1.3	
Solder eyelet Ø tolerance	mm	+ 0,1	

Accessories

Note: Refer to the Accessories chapter for additional accessories.

Coding	Order No.
BLZ/SL KO OR BX	1573010000
BLZ/SL KO BK BX	1545710000

Ordering data

Solder pin length		3.2 mm		
Colour		black		
Pitch		7.62 mm		
Pol.	L1	(inch)	Qty.	Order No.
2	7.62	0.300	100	1472240000
3	15.24	0.600	100	1472250000
4	22.86	0.900	100	1472260000
5	30.48	1.200	50	1472270000
6	38.10	1.500	50	1472280000
7	45.72	1.800	50	1472290000
8	53.34	2.100	50	1472310000
9	60.96	2.400	50	1472320000
10	68.58	2.700	50	1472330000
11	76.20	3.000	50	1472340000
12	83.82	3.300	50	1472350000

SL 7.62HP/270LF



Dimensioned drawing

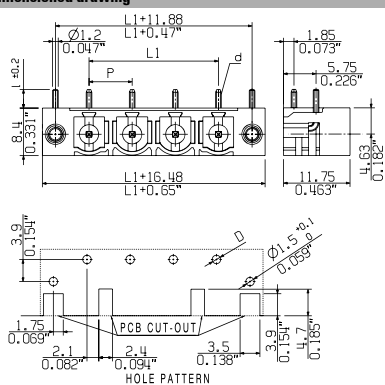

Ordering data

Solder pin length		3.2 mm		
Colour		black		
Pitch		7.62 mm		
Pol.	L1	(inch)	Qty.	Order No.
2	7.62	0.300	100	1472360000
3	15.24	0.600	100	1472370000
4	22.86	0.900	100	1472380000
5	30.48	1.200	50	1472390000
6	38.10	1.500	50	1472410000
7	45.72	1.800	50	1472420000
8	53.34	2.100	50	1472430000
9	60.96	2.400	50	1472440000
10	68.58	2.700	50	1472450000
11	76.20	3.000	50	1472460000
12	83.82	3.300	50	1472470000

SLF 7.62HP../180 SH



180° inverted male header with PUSH IN connection technology for field wiring in 2.5 mm² with a 7.62 pitch. Also ideal as a touch-safe solution for inverse voltages. Meets the requirements of UL1059 600 V class C and IEC 61800-5-1.

Variants: available without flange, with external flange, with release latch.

Including pre-assembled pluggable shield connection for large area shielding in your application.

Technical data

In compliance with IEC 60664-1 / IEC 61984			
Clamping range, max.	mm ²	0.08...2.5	
Solid core H05(07) V-U	mm²	0.5...2.5	
Stranded H07 V-R			
Flexible H05(07) V-K	mm ²	0.5...2.5	
Flexible with ferrule	mm ²	0.5...1.5	
Ferrule with plastic collar	mm ²	0.5...1.5	
Stripping length	mm	10	
Screwdriver blade	mm		
According to norm		DIN 5264-A	
Tightening torque range			
Rated current, max.	A	24	23.8
At ambient temperature		20°C	40°C
For conductor cross-section	mm ²	2.5	
Overvoltage category		III	III II
Pollution severity		3	2 2
Rated voltage	V	630	1000 1000
Rated impulse voltage	kV	6	8 6
UL / CUL (Use Group)		B	C D
Rated voltage	V	600	600 600
Rated current	A	20	20 5
AWG conductor	AWG	20-12	
CSA (Use Group)		B	C D
Rated voltage	V	600	600 600
Rated current	A	20	20 5
AWG conductor	AWG	20-12	
General data			
Type of insulation material		PBT	
UL 94 flammability rating		V-0	
Contact base material		Copper alloy	
Material of contact surface			
Pin dimensions = d	mm		
Solder eyelet Ø = D	mm		
Solder eyelet Ø tolerance	mm		

Product data

IEC: 1000 V / 24 A / 0.5 - 2.5 mm²
UL: 600 V / 20 A / AWG 20 - 12



For additional articles and information, refer to catalog.weidmueller.com

Note:

- Additional variants on request
- Gold-plated contact surfaces on request
- Rated current related to rated cross-section & min. No. of poles.
- Wire end ferrule without plastic collar to DIN 46228/1
- Wire end ferrule with plastic collar to DIN 46228/4
- P on drawing = pitch
- Rated data refer only to the component itself. Clearance and creepage distances to other components are to be designed in accordance with the relevant application standards.
- Long term storage of the product with average temperature of 50 °C and average humidity 70%, 36 months

SLF 7.62HP../180FSH160



UL 600 V

Dimensioned drawing

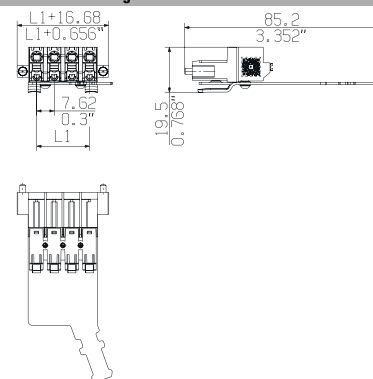

Accessories

Note: Refer to the Accessories chapter for additional accessories.

Coding		Order No.
	BV/SV 7.62HP KO	1937590000
Screwdriver		
	SDS 0.6X3.5X100	2749340000
	SDIS 0.6X3.5X100	2749810000

Ordering data

Solder pin length				
Colour	black			
Pitch	7.62 mm			
Pol.	L1	(inch)	Qty.	Order No.
4	22.86	0.900	40	2632730000

Representative dimensional drawing

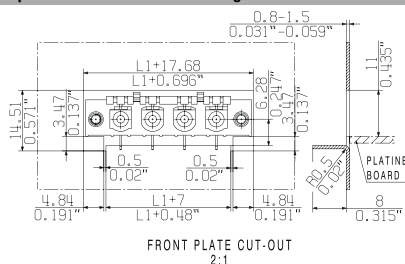

Representative deratings curve

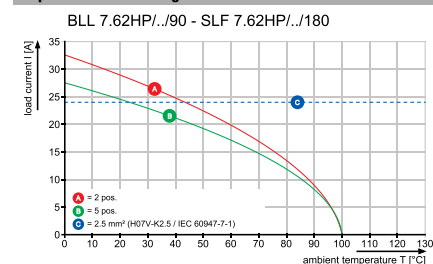

SLF 7.62HP../180FSH180



UL
600V

Dimensioned drawing

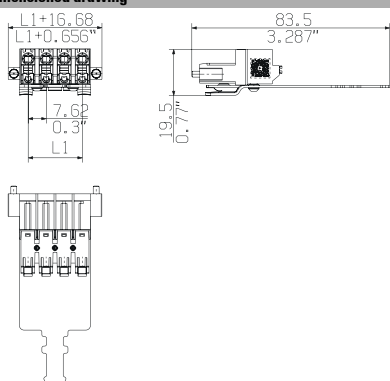

Ordering data

Solder pin length				
Colour				black
Pitch		7.62 mm		
Pol.	L1	(inch)	Qty.	Order No.
4	22.86	0.900	40	2614140000

SLF 7.62HP../180FSH200



UL
600V

Dimensioned drawing

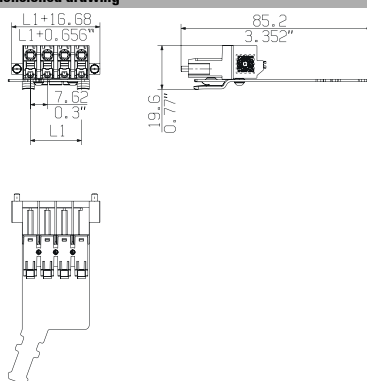

Ordering data

Solder pin length				
Colour				black
Pitch		7.62 mm		
Pol.	L1	(inch)	Qty.	Order No.
4	22.86	0.900	40	2632770000

Additional deratings curves

BLL 7.62HP../190 - SLF 7.62HP../180

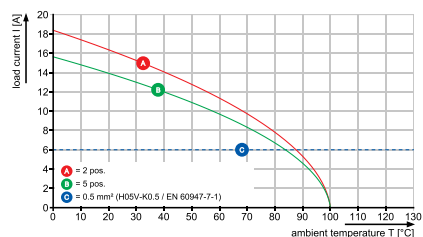

SLF 7.62HP../180 SH



180° inverted male header with PUSH IN connection technology for field wiring in 2.5 mm² with a 7.62 pitch. Also ideal as a touch-safe solution for inverse voltages. Meets the requirements of UL1059 600 V class C and IEC 61800-5-1.

Variants: available without flange, with external flange, with release latch.

Including pre-assembled pluggable shield connection for large area shielding in your application.

Technical data

In compliance with IEC 60664-1 / IEC 61984			
Clamping range, max.	mm ²	0.08...2.5	
Solid core H05(07) V-U	mm²	0.5...2.5	
Stranded H07 V-R			
Flexible H05(07) V-K	mm ²	0.5...2.5	
Flexible with ferrule	mm ²	0.5...1.5	
Ferrule with plastic collar	mm ²	0.5...1.5	
Stripping length	mm	10	
Screwdriver blade	mm		
According to norm		DIN 5264-A	
Tightening torque range			
Rated current, max.	A	24	23.8
At ambient temperature		20°C	40°C
For conductor cross-section	mm ²	2.5	
Overvoltage category		III	III II
Pollution severity		3	2 2
Rated voltage	V	630	1000 1000
Rated impulse voltage	kV	6	8 6
UL / CUL (Use Group)		B	C D
Rated voltage	V	600	600 600
Rated current	A	20	20 5
AWG conductor	AWG	20-12	
CSA (Use Group)		B	C D
Rated voltage	V	600	600 600
Rated current	A	20	20 5
AWG conductor	AWG	20-12	
General data			
Type of insulation material		PBT	
UL 94 flammability rating		V-0	
Contact base material		Copper alloy	
Material of contact surface			
Pin dimensions = d	mm		
Solder eyelet Ø = D	mm		
Solder eyelet Ø tolerance	mm		

Product data

IEC: 1000 V / 24 A / 0.5 - 2.5 mm²
UL: 600 V / 20 A / AWG 20 - 12



For additional articles and information, refer to catalog.weidmueller.com

Note:

- Additional variants on request
- Gold-plated contact surfaces on request
- Rated current related to rated cross-section & min. No. of poles.
- Wire end ferrule without plastic collar to DIN 46228/1
- Wire end ferrule with plastic collar to DIN 46228/4
- P on drawing = pitch
- Rated data refer only to the component itself. Clearance and creepage distances to other components are to be designed in accordance with the relevant application standards.
- Long term storage of the product with average temperature of 50 °C and average humidity 70%, 36 months

SLF 7.62HP../180LRSH160



Dimensioned drawing

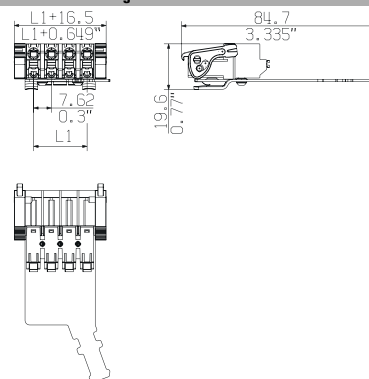

Accessories

Note: Refer to the Accessories chapter for additional accessories.

Coding		Order No.
	BV/SV 7.62HP KO	1937590000
Screwdriver		
	SDS 0.6X3.5X100	2749340000
	SDIS 0.6X3.5X100	2749810000

Ordering data

Solder pin length				
Colour	black			
Pitch	7.62 mm			
Pol.	L1	(inch)	Qty.	Order No.
4	22.86	0.900	40	2632780000

Representative dimensional drawing

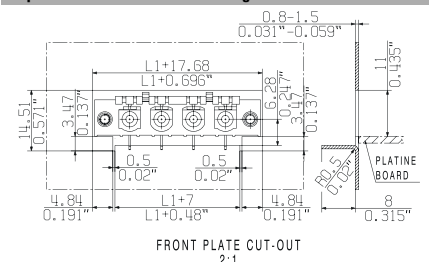

Representative deratings curve

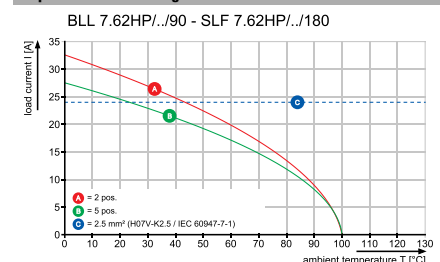

SLF 7.62HP../180LRSH180



SLF 7.62HP../180LRSH200



Dimensioned drawing

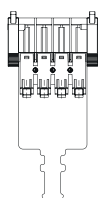
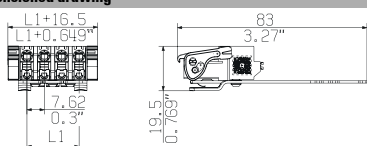

Dimensioned drawing

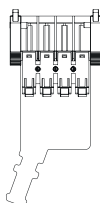
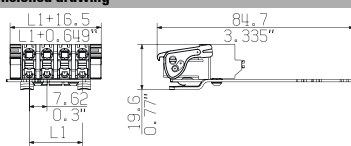

Ordering data

Solder pin length				
Colour				black
Pitch		7.62 mm		
Pol.	L1	(inch)	Qty.	Order No.
4	22.86	0.900	40	2614190000

Ordering data

Solder pin length				
Colour				black
Pitch		7.62 mm		
Pol.	L1	(inch)	Qty.	Order No.
4	22.86	0.900	40	2632790000

Additional deratings curves

BLL 7.62HP../190 - SLF 7.62HP../180

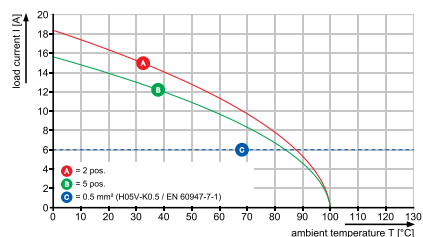

Connectors, pitch 7.62 mm
BL/SL 7.62 series - connection up to 2.5 mm²

SLF 7.62HP../180

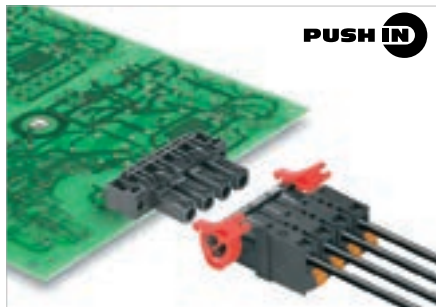

Male plug with PUSH IN spring connection in 180° outlet direction. Also perfect for finger-safe solutions involving inverse voltages. Complies with UL1059 600 V Use Group C and IEC 61800-5-1 requirements for 3 mm of finger safety on 400 V TNC systems.

- Available with screw flange (F) and lock and release-levers (LR).

Technical data

In compliance with IEC 60664-1 / IEC 61984			
Clamping range, max.	mm ²	0.08...2.5	
Solid core H05(07) V-U	mm ²	0.5...2.5	
Stranded H07 V-R			
Flexible H05(07) V-K	mm ²	0.5...2.5	
Flexible with ferrule	mm ²	0.5...1.5	
Ferrule with plastic collar	mm ²	0.5...1.5	
Stripping length	mm	10	
Screwdriver blade	mm	0.6 x 3.5	
		According to norm	
Tightening torque range			
Rated current, max.	A	24	23.8
At ambient temperature		20°C	40°C
For conductor cross-section	mm ²	2.5	
Overtoltage category		III	III II
Pollution severity		3	2 2
Rated voltage	V	630	1000 1000
Rated impulse voltage	kV	6	8 6
UL / CUL (Use Group)	B C D		
Rated voltage	V	600	600 600
Rated current	A	20	20 5
AWG conductor	AWG	20-12	
CSA (Use Group)	B C D		
Rated voltage	V	600	600 600
Rated current	A	20	20 5
AWG conductor	AWG	20-12	
General data			
Type of insulation material		PBT	
UL 94 flammability rating		V-0	
Contact base material		Copper alloy	
Material of contact surface		tinned	
Pin dimensions = d	mm		
Solder eyelet Ø = D			
Solder eyelet Ø tolerance	mm		

Product data

IEC: 1000 V / 24 A / 0.5 - 2.5 mm²
 UL: 600 V / 20 A / AWG 20 - 12



For additional articles and information, refer to catalog.weidmuller.com

Note:

- Additional variants on request
- Gold-plated contact surfaces on request
- Rated current related to rated cross-section & min. No. of poles.
- Wire end ferrule without plastic collar to DIN 46228/1
- Wire end ferrule with plastic collar to DIN 46228/4
- P on drawing = pitch
- Rated data refer only to the component itself. Clearance and creepage distances to other components are to be designed in accordance with the relevant application standards.
- Long term storage of the product with average temperature of 50 °C and average humidity 70%, 36 months

SLF 7.62HP../180G



Dimensioned drawing

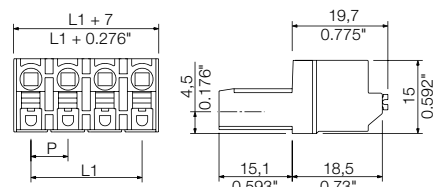

Accessories

Note: Refer to the Accessories chapter for additional accessories.

Coding		Order No.
	BV/SV 7.62HP KO	1937590000
Screwdriver		
	SDS 0.6X3.5X100	2749340000
	SDIS 0.6X3.5X100	2749810000

Ordering data

Solder pin length					
Colour	black				
Pitch	7.62 mm				
Pol.	L1	(inch)	Qty.	Order No.	
2	7.62	0.300	126	1043590000	
3	15.24	0.600	84	1043600000	
4	22.86	0.900	60	1043610000	
5	30.48	1.200	48	1043620000	

Representative deratings curve

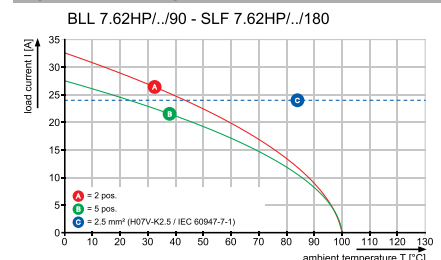

SLF 7.62HP../180F



Dimensioned drawing

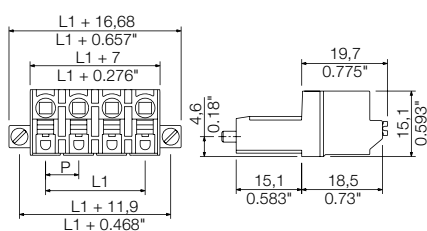

SLF 7.62HP../180LR



Dimensioned drawing

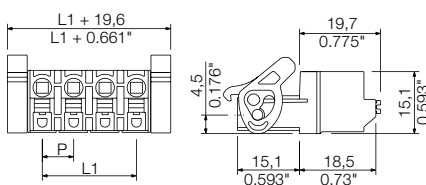

Ordering data

Solder pin length					
Colour					black
Pitch 7.62 mm					
Pol.	L1	(inch)	Qty.	Order No.	
2	7.62	0.300	72	1043670000	
3	15.24	0.600	54	1043680000	
4	22.86	0.900	42	1043690000	
5	30.48	1.200	36	1043700000	

Ordering data

Solder pin length					
Colour					black
Pitch 7.62 mm					
Pol.	L1	(inch)	Qty.	Order No.	
2	7.62	0.300	72	1043750000	
3	15.24	0.600	54	1043760000	
4	22.86	0.900	42	1043770000	
5	30.48	1.200	36	1043780000	

Additional deratings curves

BLL 7.62HP../190 - SLF 7.62HP../180

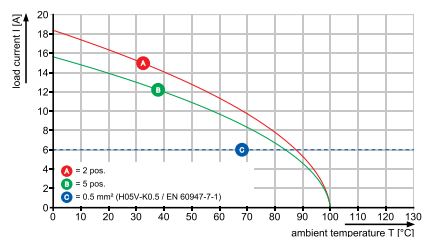

Connectors, pitch 7.62 mm
BL/SL 7.62 series - connection up to 2.5 mm²

BLZ 7.62HP../180

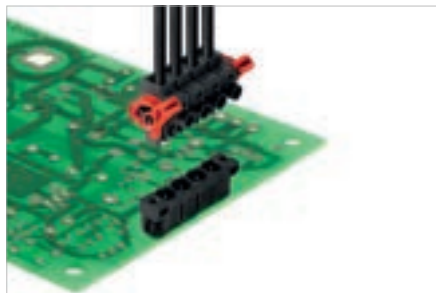

Female plug with clamping yoke screw connection in 180° outlet direction. Complies with UL1059 600 V Use Group C and IEC 61800-5-1 requirements for 3 mm of finger safety on 400 V TNC(S) systems.

- Available with lock and release-levers (LR) and screw flange on request.

Technical data

In compliance with IEC 60664-1 / IEC 61984			
Clamping range, max.	mm ²	0.08...4	
Solid core H05(07) V-U	mm²	0.2...4	
Stranded H07 V-R			
Flexible H05(07) V-K	mm ²	0.2...4	
Flexible with ferrule	mm ²	0.2...2.5	
Ferrule with plastic collar	mm ²	0.2...2.5	
Stripping length	mm	7	
Screwdriver blade	mm	0.6 x 3.5	
According to norm		DIN 5264	
Tightening torque range	Nm	0.4...0.5	
Rated current, max.	A	29	25
At ambient temperature		20°C	40°C
For conductor cross-section	mm ²	2.5	
Overtoltage category		III	III II
Pollution severity		3	2 2
Rated voltage	V	400	500 630
Rated impulse voltage	kV	6	6 4
UL / CUL (Use Group)	B C D	B	C D
Rated voltage	V	600	600 600
Rated current	A	20	20 5
AWG conductor	AWG	20-12	
CSA (Use Group)	B C D	B	C D
Rated voltage	V	600	600 600
Rated current	A	20	20 5
AWG conductor	AWG	20-12	
General data			
Type of insulation material		PBT	
UL 94 flammability rating		V-0	
Contact base material		Copper alloy	
Material of contact surface		tinned	
Pin dimensions = d	mm		
Solder eyelet Ø = D			
Solder eyelet Ø tolerance	mm		

Product data

IEC: 630 V / 29 A / 0.2 - 4 mm²
 UL: 600 V / 20 A / AWG 20 - 12



For additional articles and information, refer to catalog.weidmueller.com

Note:

- Additional variants on request
- Gold-plated contact surfaces on request
- Rated current related to rated cross-section & min. No. of poles.
- Wire end ferrule without plastic collar to DIN 46228/1
- Wire end ferrule with plastic collar to DIN 46228/4
- P on drawing = pitch
- Rated data refer only to the component itself. Clearance and creepage distances to other components are to be designed in accordance with the relevant application standards.
- Long term storage of the product with average temperature of 50 °C and average humidity 70%, 36 months

BLZ 7.62HP../180



Dimensioned drawing

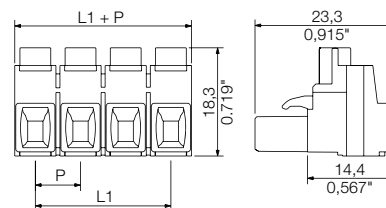

Accessories

Note: Refer to the Accessories chapter for additional accessories.

Coding	Order No.
BLZ/SL KO OR BX	1573010000
BLZ/SL KO BK BX	1545710000
Screwdriver	
SDS 0.6X3.5X100	2749340000
SDIS 0.6X3.5X100	2749810000

Ordering data

Solder pin length				
Colour	black			
Pitch	7.62 mm			
Pol.	L1	(inch)	Qty.	Order No.
2	7.62	0.300	100	1059580000
3	15.24	0.600	100	1059590000
4	22.86	0.900	100	1059600000
5	30.48	1.200	50	1049010000
6	38.10	1.500	50	1049020000
7	45.72	1.800	50	1059610000
8	53.34	2.100	50	1049030000
9	60.96	2.400	50	1059620000
10	68.58	2.700	50	1059630000
11	76.20	3.000	50	1059640000
12	83.82	3.300	50	1059670000

Representative deratings curve

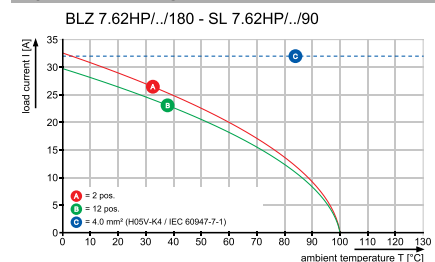

BLZ 7.62HP/./180LR



Dimensioned drawing

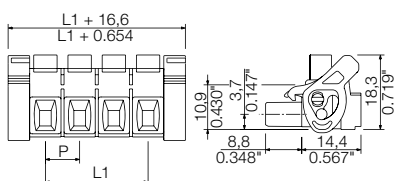

Ordering data

Solder pin length					
Colour					black
Pitch 7.62 mm					
Pol.	L1	(inch)	Qty.	Order No.	
2	7.62	0.300	60	1093430000	
3	15.24	0.600	45	1093440000	
4	22.86	0.900	35	1093450000	
5	30.48	1.200	30	1093460000	
6	38.10	1.500	25	1164960000	
7	45.72	1.800	20	1164970000	
8	53.34	2.100	20	1164980000	
9	60.96	2.400	15	1164990000	
10	68.58	2.700	15	1165000000	
11	76.20	3.000	15	1165010000	
12	83.82	3.300	15	1165020000	

Additional deratings curves

BLZ 7.62HP/./180 - SL 7.62HP/./90

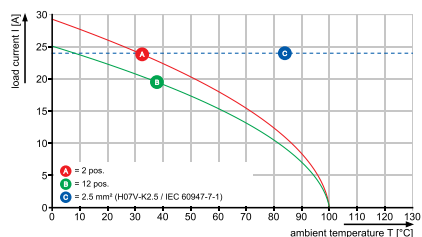

Connectors, pitch 7.62 mm
BL/SL 7.62 series - connection up to 2.5 mm²

BLF 7.62HP../180

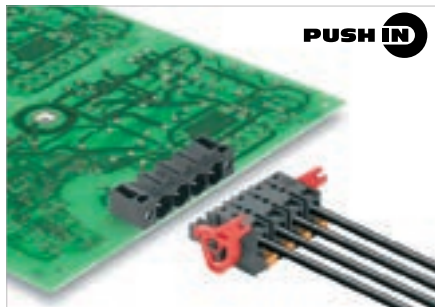

Female plug with PUSH IN spring connection in 180 ° outlet direction. Complies with UL1059 600 V Use Group C and IEC 61800-5-1 requirements for 3 mm of finger safety on 400 V TNC(S) systems.

- Available with screw flange (F) and lock and release-levers (LR).

Technical data

In compliance with IEC 60664-1 / IEC 61984			
Clamping range, max.	mm ²	0.08...2.5	
Solid core H05(07) V-U	mm ²	0.5...1.5	
Stranded H07 V-R			
Flexible H05(07) V-K	mm ²	0.5...2.5	
Flexible with ferrule	mm ²	0.5...2.5	
Ferrule with plastic collar	mm ²	0.5...2.5	
Stripping length	mm	10	
Screwdriver blade	mm	0.6 x 3.5	
According to norm			
Tightening torque range			
Rated current, max.	A	24	23.8
At ambient temperature		20°C	40°C
For conductor cross-section	mm ²	2.5	
Overtension category		III	III II
Pollution severity		3	2 2
Rated voltage	V	630	1000 1000
Rated impulse voltage	kV	6	8 6
UL / CUL (Use Group)		B	C D
Rated voltage	V	600	600 600
Rated current	A	20	20 5
AWG conductor	AWG	20-12	
CSA (Use Group)		B	C D
Rated voltage	V	600	600 600
Rated current	A	21	21 5
AWG conductor	AWG	20-12	
General data			
Type of insulation material		PBT	
UL 94 flammability rating		V-0	
Contact base material		Copper alloy	
Material of contact surface		tinned	
Pin dimensions = d	mm		
Solder eyelet Ø = D	mm		
Solder eyelet Ø tolerance	mm		

Product data

IEC: 1000 V / 24 A / 0.5 - 2.5 mm²
 UL: 600 V / 20 A / AWG 20 - 12



For additional articles and information, refer to catalog.weidmueller.com

Note:

- Additional variants on request
- Gold-plated contact surfaces on request
- Rated current related to rated cross-section & min. No. of poles.
- Wire end ferrule without plastic collar to DIN 46228/1
- Wire end ferrule with plastic collar to DIN 46228/4
- P on drawing = pitch
- Rated data refer only to the component itself. Clearance and creepage distances to other components are to be designed in accordance with the relevant application standards.
- Crimping shape "A" for wire end ferrules with PZ 6/5 crimping tool recommended.
- Long term storage of the product with average temperature of 50 °C and average humidity 70%, 36 months

BLF 7.62HP../180

with test point



Dimensioned drawing

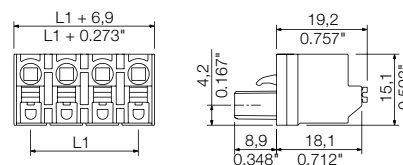

Accessories

Note: Refer to the Accessories chapter for additional accessories.

Screwdriver		Order No.
	SDS 0.5X3.0X80	2749330000
	SDIS 0.5X3.0X100	2749800000
Pressing tool		
	PZ 6/5	9011460000

Ordering data

Solder pin length				
Colour	black			
Pitch	7.62 mm			
Pol.	L1	(inch)	Qty.	Order No.
2	7.62	0.300	120	1043830000
3	15.24	0.600	78	1043840000
4	22.86	0.900	60	1043850000
5	30.48	1.200	48	1043860000
6	38.10	1.500	36	1227340000
7	45.72	1.800	30	1227350000
8	53.34	2.100	30	1227360000
9	60.96	2.400	24	1227370000
10	68.58	2.700	24	1227380000
11	76.20	3.000	18	1227390000
12	83.82	3.300	18	1227410000

Representative deratings curve

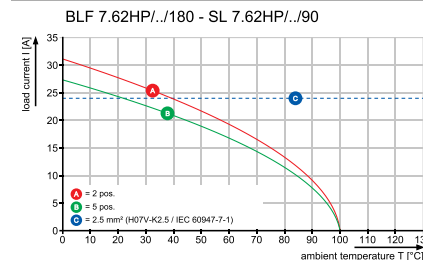

BLF 7.62HP../180F

with test point



Dimensioned drawing

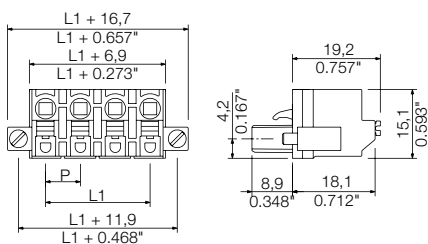

BLF 7.62HP../180LR

with test point



Dimensioned drawing

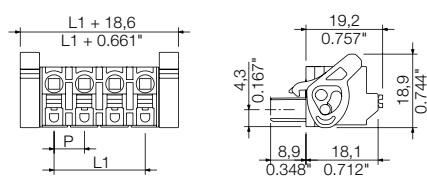

Ordering data

Solder pin length					
Colour					black
Pitch 7.62 mm					
Pol.	L1	(inch)	Qty.	Order No.	
2	7.62	0.300	72	1043910000	
3	15.24	0.600	54	1043920000	
4	22.86	0.900	42	1043930000	
5	30.48	1.200	36	1043940000	
6	38.10	1.500	30	1227490000	
7	45.72	1.800	24	1227510000	
8	53.34	2.100	24	1227520000	
9	60.96	2.400	18	1227530000	
10	68.58	2.700	18	1227540000	

Ordering data

Solder pin length					
Colour					black
Pitch 7.62 mm					
Pol.	L1	(inch)	Qty.	Order No.	
2	7.62	0.300	72	1043990000	
3	15.24	0.600	54	1044000000	
4	22.86	0.900	42	1044010000	
5	30.48	1.200	36	1044020000	
6	38.10	1.500	30	1227420000	
7	45.72	1.800	24	1227430000	
8	53.34	2.100	24	1227440000	
9	60.96	2.400	18	1227450000	
10	68.58	2.700	18	1227460000	

Additional deratings curves

BLF 7.62HP../180 - SL 7.62HP../90

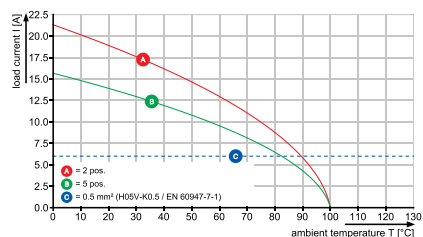

Connectors, pitch 7.62 mm
BL/SL 7.62 series - connection up to 2.5 mm²

BLL 7.62HP../90

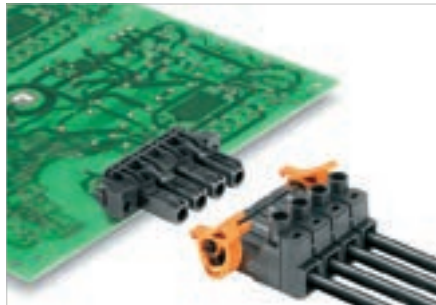

Touch-safe female header with 90° outlet direction for PCBs. Meets the requirements of IEC 61800-5-1 and comes with UL approval in accordance with UL508-5-1 / UL840 for 600 V. An ideal touch-safe solution for power output and DC-link applications. The pin arrangement ensures more than 3 mm of touch-safety in accordance with IEC 61800-5-1.

Variants: flange and solder flange fastening.

Product data

IEC: 630 V / 24 A
 UL: 300 V / 20 A



For additional articles and information, refer to catalog.weidmuller.com

Note:

- Additional variants on request
- Gold-plated contact surfaces on request
- Spacing between rows: see hole layout
- Rated current related to rated cross-section & min. No. of poles.
- P on drawing = pitch
- Rated data refer only to the component itself. Clearance and creepage distances to other components are to be designed in accordance with the relevant application standards.
- Long term storage of the product with average temperature of 50 °C and average humidity 70%, 36 months

BLL 7.62HP../90G



Dimensioned drawing

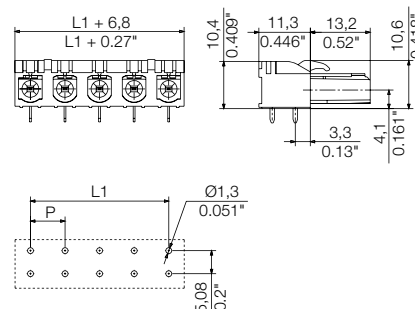

Technical data

In compliance with IEC 60664-1 / IEC 61984

Clamping range, max.			
Solid core H05(07) V-U			
Stranded H07 V-R			
Flexible H05(07) V-K			
Flexible with ferrule			
Ferrule with ferrule collar			
Stripping length			
Screwdriver blade	mm		
According to norm			
Tightening torque range			
Rated current, max.	A	24	24
At ambient temperature		20°C	40°C
For conductor cross-section			
Overvoltage category		III	III II
Pollution severity		3	2 2
Rated voltage	V	400	630 630
Rated impulse voltage	kV	6	6 4
UL / CUL (Use Group)	B C D		
Rated voltage	V	300	150 300
Rated current	A	20	20 10
AWG conductor	AWG	-	
CSA (Use Group)	B C D		
Rated voltage	V	300	150 300
Rated current	A	20	20 10
AWG conductor	AWG	-	
General data			
Type of insulation material	PA GF		
UL 94 flammability rating	V-0		
Contact base material	Copper alloy		
Material of contact surface	tinned		
Pin dimensions = d	mm	0.4 x 1.00	
Solder eyelet Ø = D	mm	1.3	
Solder eyelet Ø tolerance	mm	+ 0,1	

Accessories

Note: Refer to the Accessories chapter for additional accessories.

Ordering data

Solder pin length	3.2 mm			
Colour	black			
Pitch	7.62 mm			
Pol.	L1	(inch)	Qty.	Order No.
2	7.62	0.300	126	1043230000
3	15.24	0.600	84	1043240000
4	22.86	0.900	60	1043250000
5	30.48	1.200	48	1043260000

Representative deratings curve

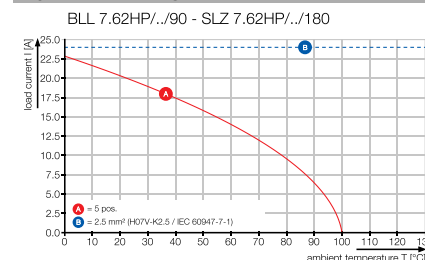

BLL 7.62HP../90F



Dimensioned drawing

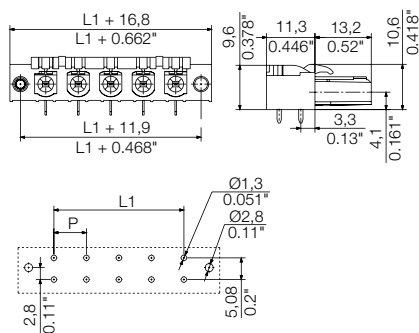

Ordering data

Solder pin length		3.2 mm			
Colour		black			
Pitch		7.62 mm			
Pol.	L1	(inch)	Qty.	Order No.	
2	7.62	0.300	72	1043270000	
3	15.24	0.600	54	1043280000	
4	22.86	0.900	42	1043290000	
5	30.48	1.200	36	1043300000	

BLL 7.62HP../90LF



Dimensioned drawing

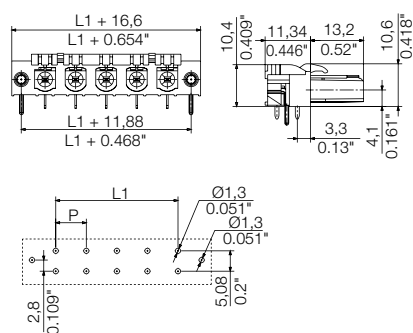

Ordering data

Solder pin length		3.2 mm			
Colour		black			
Pitch		7.62 mm			
Pol.	L1	(inch)	Qty.	Order No.	
2	7.62	0.300	72	1095640000	
3	15.24	0.600	54	1095650000	
4	22.86	0.900	42	1095660000	
5	30.48	1.200	36	1095670000	

Additional deratings curves

BLL 7.62HP../90 - SLF 7.62HP../180

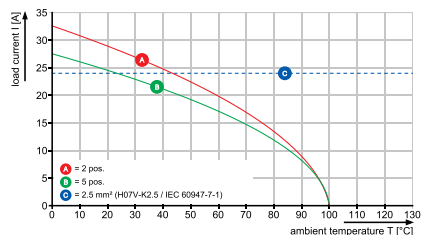

BLL 7.62HP../90 - SLZ 7.62HP../180

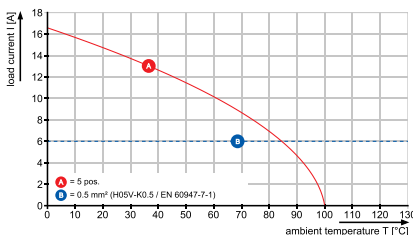

Connectors, pitch 7.62 mm
BL/SL 7.62 series - connection up to 2.5 mm²

BLL 7.62HP../180

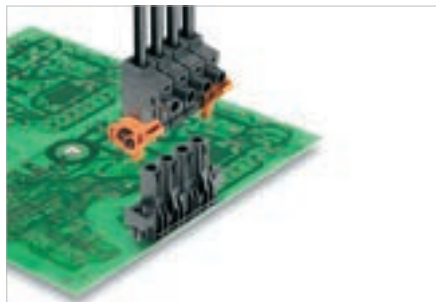

Touch-safe female header with 180° outlet direction for PCBs. Meets the requirements of IEC 61800-5-1 and comes with UL approval in accordance with UL508-5-1 / UL840 for 600 V. An ideal touch-safe solution for power output and DC-link applications. The pin arrangement ensures more than 3 mm of touch-safety in accordance with IEC 61800-5-1.

Variants: flange and solder flange fastening.

Product data

IEC: 630 V / 24 A
 UL: 300 V / 20 A



For additional articles and information, refer to catalog.weidmueller.com

Note:

- Additional variants on request
- Gold-plated contact surfaces on request
- Spacing between rows: see hole layout
- Rated current related to rated cross-section & min. No. of poles.
- P on drawing = pitch
- Rated data refer only to the component itself. Clearance and creepage distances to other components are to be designed in accordance with the relevant application standards.
- Long term storage of the product with average temperature of 50 °C and average humidity 70%, 36 months

BLL 7.62HP../180G



Dimensioned drawing

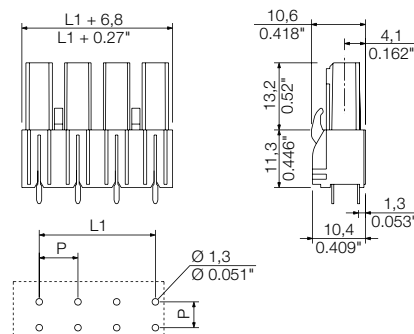

Technical data

In compliance with IEC 60664-1 / IEC 61984

Clamping range, max.			
Solid core H05(07) V-U			
Stranded H07 V-R			
Flexible H05(07) V-K			
Flexible with ferrule			
Ferrule with ferrule collar			
Stripping length			
Screwdriver blade			mm
According to norm			
Tightening torque range			
Rated current, max.	A	24	24
At ambient temperature		20°C	40°C
For conductor cross-section			
Overtoltage category		III	III II
Pollution severity		3	2 2
Rated voltage	V	400	630 630
Rated impulse voltage	kV	6	6 4
UL / CUL (Use Group)		B	C D
Rated voltage	V	300	150 300
Rated current	A	20	20 10
AWG conductor	AWG		-
CSA (Use Group)		B	C D
Rated voltage	V	300	150 300
Rated current	A	20	20 10
AWG conductor	AWG		-
General data			
Type of insulation material		PA GF	
UL 94 flammability rating		V-0	
Contact base material		Copper alloy	
Material of contact surface		tinned	
Pin dimensions = d	mm	0.4 x 1.00	
Solder eyelet Ø = D	mm	1.3	
Solder eyelet Ø tolerance	mm	+ 0,1	

Accessories

Note: Refer to the Accessories chapter for additional accessories.

Ordering data

Solder pin length	3.2 mm		
Colour	black		
Pitch	7.62 mm		
Pol.	L1	(inch)	Qty. Order No.
2	7.62	0.300	126 1122070000
3	15.24	0.600	84 1122080000
4	22.86	0.900	60 1122090000
5	30.48	1.200	48 1122100000

Representative deratings curve

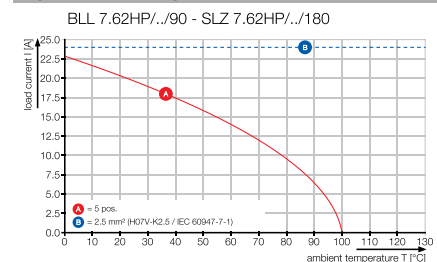

BLL 7.62HP../180F



Dimensioned drawing

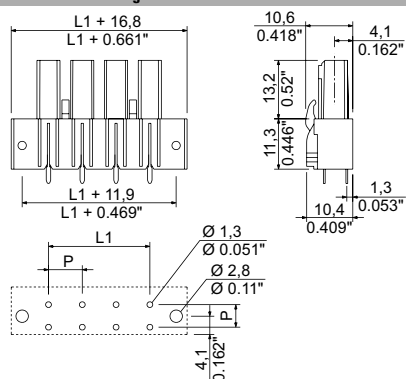

Ordering data

Solder pin length		3.2 mm		
Colour		black		
Pitch		7.62 mm		
Pol.	L1	(inch)	Qty.	Order No.
2	7.62	0.300	72	1122110000
3	15.24	0.600	54	1122120000
4	22.86	0.900	42	1122130000
5	30.48	1.200	36	1122140000

BLL 7.62HP../180LF



Dimensioned drawing

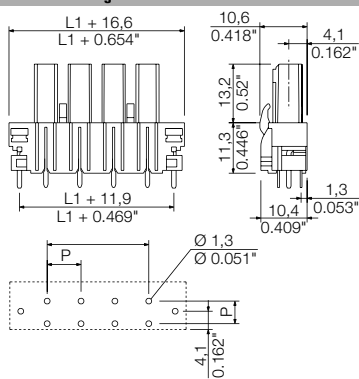

Ordering data

Solder pin length		3.2 mm		
Colour		black		
Pitch		7.62 mm		
Pol.	L1	(inch)	Qty.	Order No.
2	7.62	0.300	72	1134080000
3	15.24	0.600	54	1134090000
4	22.86	0.900	42	1134110000
5	30.48	1.200	36	1134120000

Additional deratings curves

BLL 7.62HP../90 - SLF 7.62HP../180

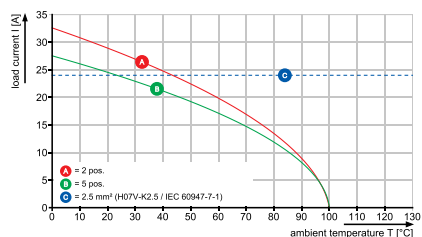

BLL 7.62HP../90 - SLZ 7.62HP../180

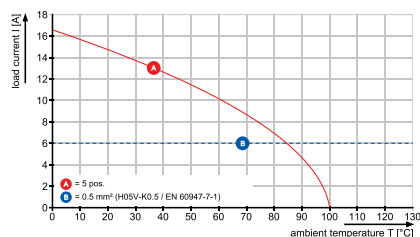

OMNIMATE® Power BV/SV 7.62HP – power class from 6 mm² and 41 A

Custom-fit high-powered solutions

More power reserves for more load capacity: The OMNIMATE® Power SV / BV 7.62HP mid-level class of power connection systems is the top performer of the HP series. It features a large clamping range, increased overload capacity and the widest selection of variants and accessories.

HP means High Performance – this performance covers a great deal: the full rated current up to 50 °C without derating, unlimited 600 V approval according to UL, and the additional finger safety for 400 V-TN systems (+ 3.0 mm) in compliance with the application directive IEC 61800-5-1.

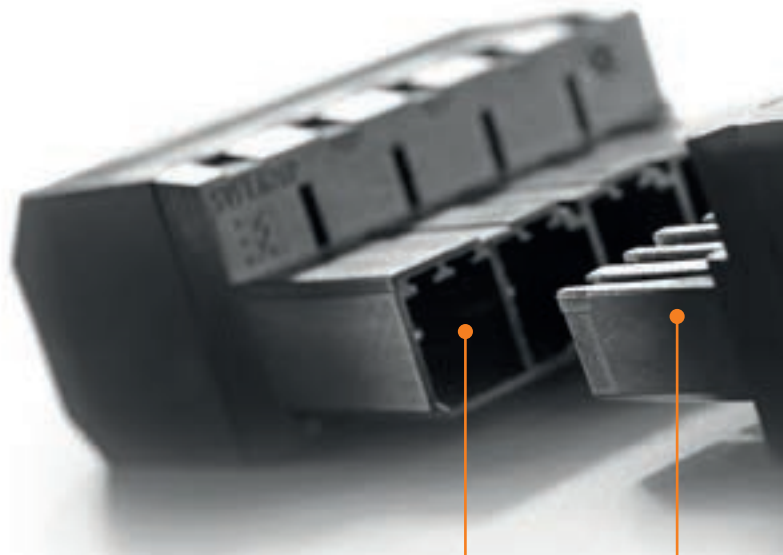

Maximum safety

Safe for both man and machine with bi-directional finger safety: also when not plugged in and covering inverse voltages from power electronics.



Maximum performance

Full current rating at 40 °C ambient temperature is a mandatory requirement in drive applications. What really makes the difference here is real-world, application-based overload and overheating capacities.

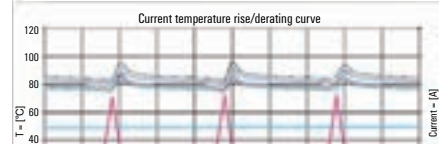
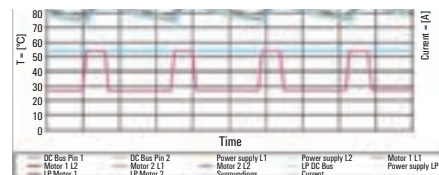

Maximum user-friendliness

Quick, simple plug and release: with the one-handed safety flange – convenient for the user and safe for the application.

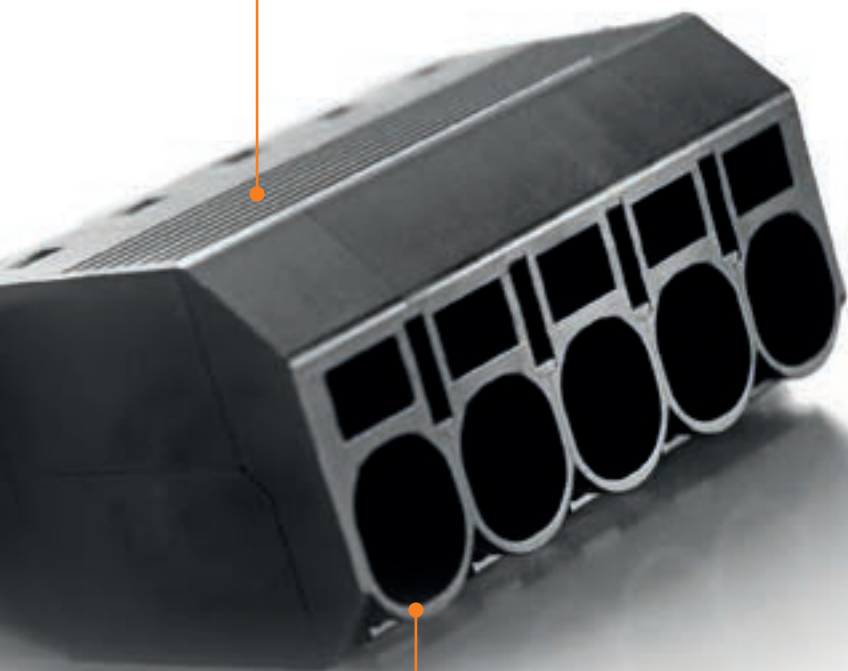

Maximum efficiency

Tool-free simplicity: quick PUSH IN connection mechanism and automatic, convenient snap-in with one-handed safety interlock.

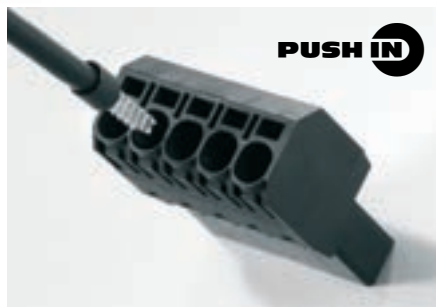

High system performance

An overview of the 28-kVA class of OMNIMATE® Power: The HP system has been leading the way with its tool-free rapid interlock, installation-safe creepage and clearance distances, and application-based versioning scheme. This integrated strategy of system expansion includes a one-handed safety flange and wide range of innovative extras.



Individualised configuration

Standard + Services = custom design with simple configuration across the entire range of services: features include colour coding, application-oriented labelling and custom modifications or design.



Convenient connection of stripped short wires OMNIMATE® Power with openable PUSH IN connection

Shielded cables for power electronics are stripped as short as possible for reasons of electromagnetic compatibility (EMC). Connection with large PUSH IN connectors is correspondingly complex. The same applies to cables with small cross-sections where often a “third hand” is missing or the use of special tools gets necessary.

Our BVFL 7.62HP simplifies and accelerates this process without the need of special tools. The combination of PUSH IN connection technology and a Pusher which can be locked in the open position allows an easy insertion of short stripped cables or of thin wires into the open terminal point. Subsequently, by pushing the pusher sideways with the hand, you can simply unlock the pusher.

The proven PUSH IN function remains unrestricted, while the in open position fixed terminal point allows a comfortable and easy connection under difficult conditions. Make use of the significant time savings to reduce your installation costs.

Large PUSH IN connector, small wire cross-section

Even with ferrules, because of the high flexibility it is difficult to insert conductors with a low cross section into these connector. Our simple solution in three steps:

- 1) Open the terminal point
- 2) Insert conductors
- 3) Close the terminal point using sideways pressure



Short-stripped wires

The PUSH IN connector with a pusher in an open fixed position allows a quick and easy wiring without special tools. It also avoids the risk of a not fully inserted conductor.

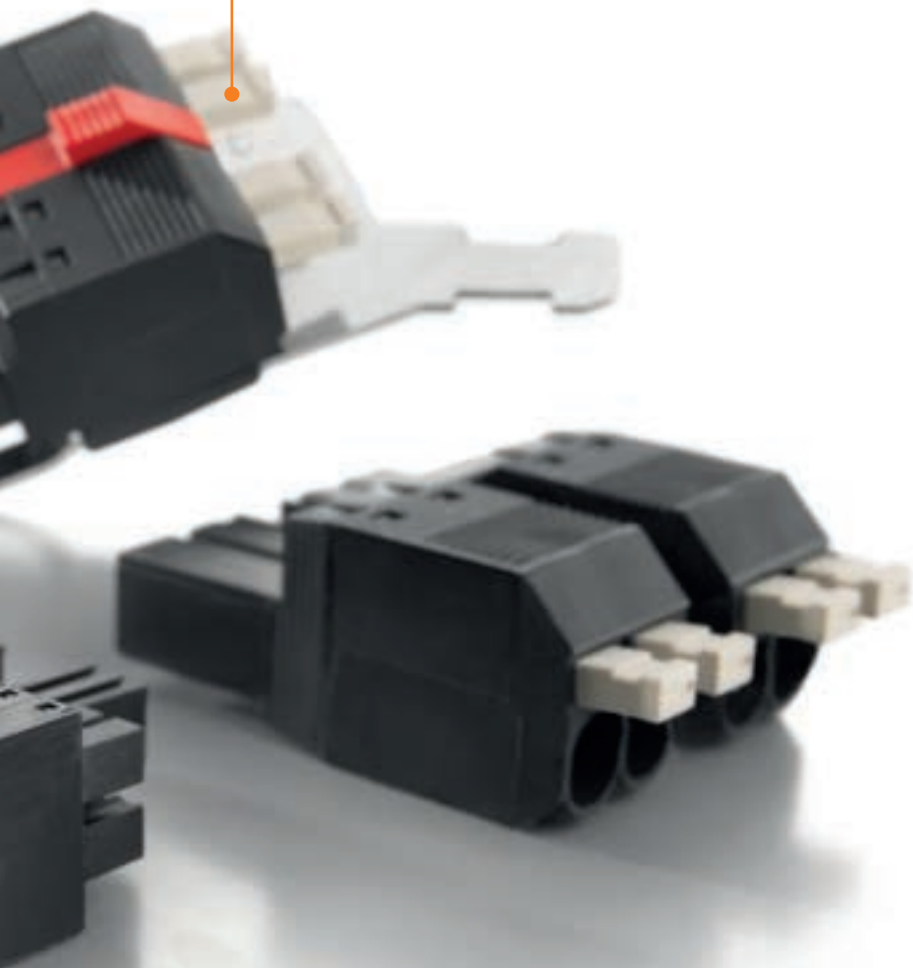
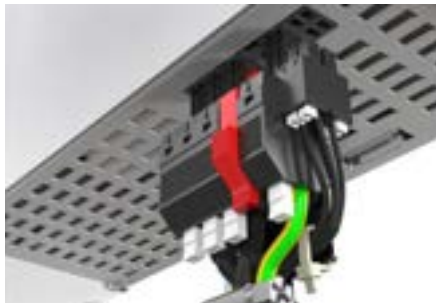

Your special advantages:

More advantages in handling, reduced installation costs

As the only PUSH IN connector so far available on the market, our BVFL 7.62HP has a special clamping point that can be locked in the open position.



Work quickly while avoiding errors - convenient connectivity solutions with latchable open terminal point reduces the installation time in the field significantly for example in frequency inverters

Implement complex supply solutions in the smallest of spaces OMNIMATE® Power – the compact, two-row connection solution

The demand for ever-smaller drive regulators with increasingly high performance ratings requires complex solutions in terms of the connection systems. The major challenge here is ensuring compliance with the existing standards.

P

The new double-level OMNIMATE® Power SVD 7.62HP male header minimises the amount of space required on the PCB, thereby creating space for other components. This extra space can be used for the integration of additional functions on the front of the device.

The two connection levels mean that the SVD 7.62HP can be used to implement complex solutions in extremely small spaces. Device widths of just 50 mm are sufficient to supply 2 motors, while still meeting the approval criteria in accordance with UL 600 V.

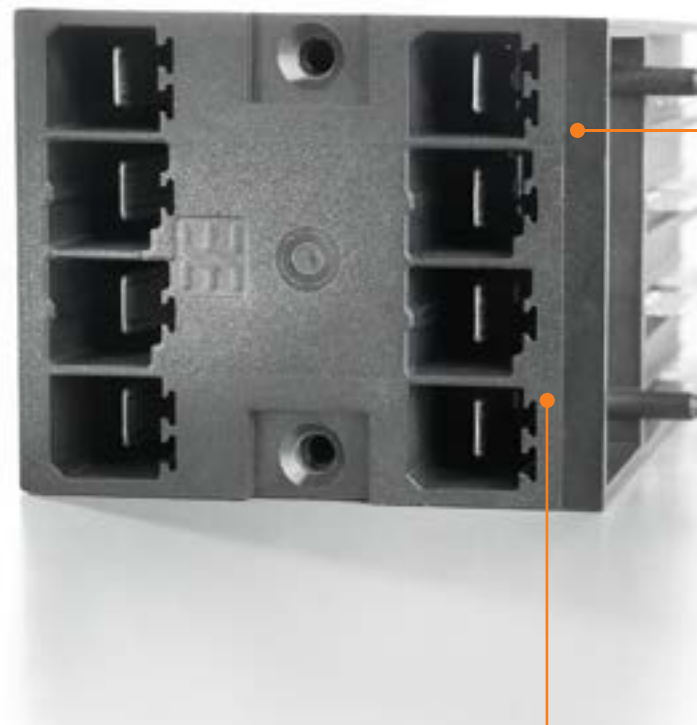

Optional cable shielding

The combination with the BVF 7.62HP ensures a reliable connection between the cable shielding and the device housing, thereby guaranteeing high EMC safety. The screw mount is easy to operate, and meets all requirements in the field.



The OMNIMATE® Power series for versatile combination options

The new SVD 7.62HP can be combined with all BVZ 7.62HP and BVF 7.62HP female plugs in the OMNIMATE® Power series.



Solutions with PUSH IN connection

Can be implemented in combination with female plug BVF (BVFL) 7.62HP. For especially quick and easy installation without the need for tools. Available with or without flange fastening – optional with screw flange.

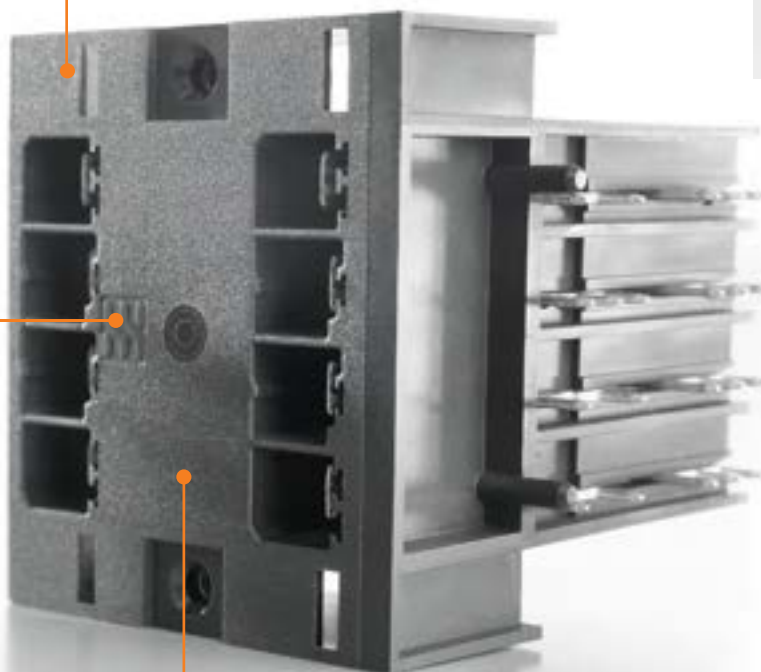

Solutions with screw connections

Can be implemented in combination with female plug BVZ 7.62HP. Available without extra fastening or, optionally, as a flange design – e. g. for applications in medium-voltage systems.



Your special advantages:

More design flexibility for the front of the device and the PCB

The superior solution for when multiple axes need to be plugged into the device in a very small space. Despite the very compact dimensions, the cable shielding can be connected to the front of the device.



With servo regulators in particular, the SVD 7.62HP allows for more complexity than ever before, thanks to the two connection levels for female plugs with conventional screw connection or PUSH IN connection technology. With additional flange fastening on request, and with the option of connecting the cable shielding to the device housing.

Safe-to-touch, solid and pluggable

Our feed-through terminals also support thick housing walls

A cable feed-through connection for housing or cabinet walls should be robust and easy to handle. This claim gets fast to a challenge when we talk about the thickness of die-cast aluminium housings.

Our pluggable panel feed-through connection SVF 7.62HP SFMF (SFBMF) in IP 20 copes this job perfectly. Thanks to the two-sided finger safety clearance of 3 mm, this solution can be used safely even in applications with backwards voltages and is therefore suitable for use in an industrial environment without an inverted mating profile. One hand is enough to plug the counterpart BVF 7.62HP 180 MF and to latch them.

Feel free to use this universal plug device at control cabinets. Or use it for the power-input and power-output connection of electronic housings.



Pin number extension to > 4 pins

Use our SVF/BVF 7.62HP COUPLE SET for extensions. Each of the two mating partners can thus be connected back-to-back to a 2-row connector with a maximum of 2 x 4 poles.



One-handed operation with locking

The mating partner BVF 7.62HP impresses with its one-hand operation and automatic snap-in. If required by a directive, it can be optionally secured with an additional screw.



Panel feed-through up to 16 mm as per UL

Without additional measures for maintaining the clearance and creepage distances as per UL, two versions for walls up to 2 mm or up to 16 mm are available. The maximum wire cross section is AWG 8 or 10 mm².



Your special advantages:

Back-to-back

Our plug-in panel feed-through is particularly impressive with automatic locking and the ability to couple two plug-in mating partners.



Our flexible, plug-in supply connections reduce installation and service costs in the signal range up to 41 A. They thus address the much increased demands in the field of signal processing devices, such as photovoltaic inverters.

Flexible power distribution to multiple devices

OMNIMATE® Power connectors with cross-connection for devices

P

Power electronic devices should be easy and economical to install. It is often needed to connect several devices to the power supply. This is the case, for example, with energy recovery using DC-Link in the intermediate circuit for drives, where several drives are connected.

OMNIMATE® Power BVDF bus connectors have two connections per pole and a time-saving 6 mm² PUSH IN connection. This innovative feature allows easy connection of multiple devices during installation. The connector is available in different versions: laterally closed, with flange, or screw/locking flange. Each of them are available in two to eight pole versions

Your special advantages:

- Safe transmission of bus currents due to integrated cross-connection
- Time-saving connection of solid conductors and conductors with wire end ferrules due to PUSH IN connection
- One pole width less compared to conventional solutions due to self-locking centre flange



Simple device integration

BVDF bus connectors are plug-in compatible with pin headers of the SV series. This allows a flexible selection of connectors for the use of devices: BVF standard connectors for single devices, BVDF connectors for multiple connected devices.



Quick and easy installation

Components with PUSH IN technology reduce the connection time by up to 50%. The conductor is simply inserted into the clamping point up to the stop and a safe and gas-tight connection is established - without any tools.

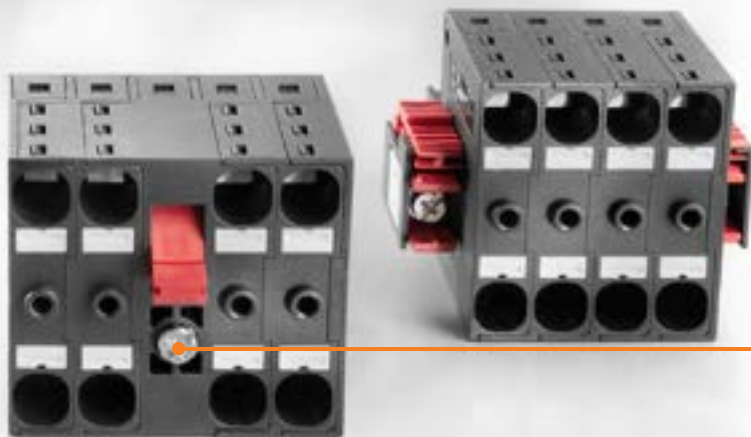
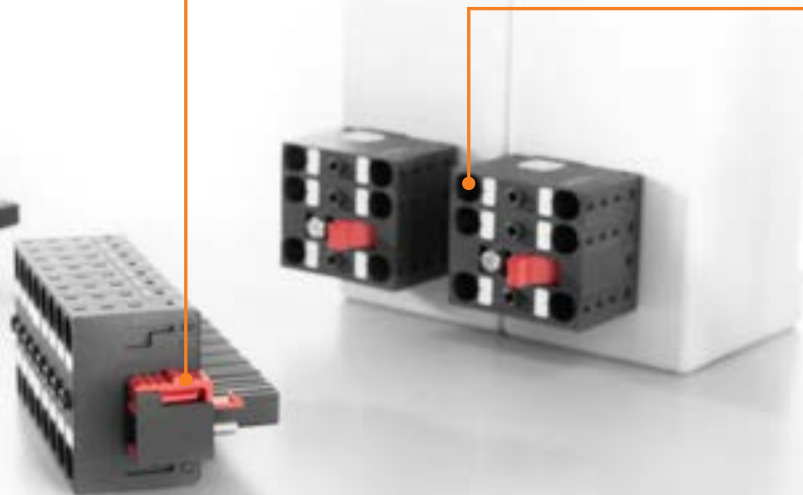

High safety level

The self-locking central flange and the lateral locking flange of the BVDF connectors have an additional screw fastening. It ensures reliable grip – even with tight bending radii of the connected conductors.



<http://www.OMNIMATE.net>

○ = Wire-to-Board
 ● = Board-to-Board
 ○ = Wire-to-Wire
 ● = Board-to-Wire

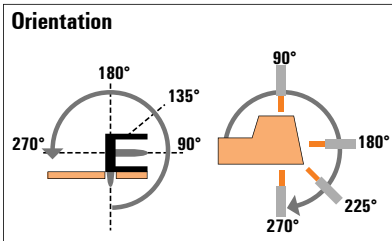

Male header

Solder connection

BV/SV 7.62 series



Type	SV- SMT	SV	SVD
Orientation	90° /180°/270°	90° /180°/270°	270°
Flange options	G/F/SF/MF/MSF	G/F/SF/MF/MSF	G/F
Product code numbers	IEC: 1.000 V/41 A UL: 300 V/40.5 A	IEC: 1.000 V/41 A UL: 300 V/40.5 A	IEC: 1.000 V/47 A UL: 300 V/30 A

Female plug	Screw Clamping yoke	BVZ 180°		IEC: 1.000 V/57 A/0.2 - 10 mm ² UL: 600 V/40.5 A/AWG 24 - 8	●	○	○
		(G)/F/SF	FC/SFC				
Female plug	Spring PUSH IN	BVZ 180°		IEC: 1.000 V/57 A/0.2 - 10 mm ² UL: 600 V/40.5 A/AWG 24 - 8	○	○	
		BVZ 180°		IEC: 1.000 V/57 A/0.2 - 10 mm ² UL: 600 V/40.5 A/AWG 24 - 8			
		BVZ 180°		IEC: 1.000 V/57 A/0.2 - 10 mm ² UL: 600 V/40.5 A/AWG 24 - 8	○	○	
		BVZ 180°		IEC: 1.000 V/57 A/0.2 - 10 mm ² UL: 600 V/40.5 A/AWG 24 - 8			
		BVZ 180°		IEC: 1.000 V/57 A/0.2 - 10 mm ² UL: 600 V/40.5 A/AWG 24 - 8			
		BVZ 180°		IEC: 1.000 V/57 A/0.2 - 10 mm ² UL: 600 V/40.5 A/AWG 24 - 8			
Female header	Solder connection	BVF 180°		IEC: 1.000 V/57 A/0.2 - 10 mm ² UL: 600 V/39 A/AWG 24 - 8	○	○	○
		BVFL 180°		IEC: 1.000 V/57 A/0.2 - 10 mm ² UL: 600 V/39 A/AWG 24 - 8	○	○	○
		BVFL 180°		IEC: 600 V/46 A/0,5 - 10 mm ² UL: 600 V/35 A/AWG 24 - AWG 8	○	○	
Female header	Solder connection	BVL 90°		IEC: 1.000 V/41 A UL: 300 V/35 A	●	●	
		BVL 180°		IEC: 1.000 V/41 A UL: 300 V/35 A	●	●	
		BVL 270°		IEC: 1.000 V/41 A UL: 300 V/35 A			

Female plug and header:

(G) = Closed (without flange)

F = Flange with clasp

SF = Flange with clasp and additional screw

SFC = Flange with clasp and additional screw

FI = Inverted flange with clasp

SFI = Inverted flange with clasp and additional screw

FC = Flange with clasp

SH... = Shielded flange with additional nut

SH... C = Shielded flange with additional screw

MF = Centre flange for clasp

MSF = Centre flange for clasp with additional nut

Male plug



**Spring
PUSH IN**



SVF	SVF	SVF	SVFL
180°	180°	180°	180°
G/F/SF	G/FI/SFI	MF/MSF/SFMF/SFBMF	G/F/MF
IEC: 1.000 V/41 A/ 0.5 - 10 mm ² UL: 600 V/36 A/ AWG 24 - 10	IEC: 1.000 V/41 A/ 0.5 - 10 mm ² UL: 600 V/36 A/ AWG 24 - 10	IEC: 1.000 V/41 A/ 0.5 - 10 mm ² UL: 600 V/36 A/ AWG 24 - 10	IEC: 1.000 V/41 A/ 0.5 - 10 mm ² UL: 600 V/36 A/ AWG 24 - 10
●			●
●			●
●		●	●
●		●	●
●		●	●
	●		
	●		
	●		

Male header and plug:

- G = Closed (without flange)
- F = Flange with clasp
- SF = Flange with clasp and additional screw
- FI = Inverted flange with clasp

- SFI = Inverted flange with clasp and additional screw
- FC = Flange with clasp
- SFC = Flange with clasp and additional screw
- SH... = Shielded flange with additional nut

- MF = Centre flange for clasp
- MSF = Centre flange for clasp with additional nut

Connectors, pitch 7.62 mm
BV/SV 7.62 series - connection up to 6 mm²

SV-SMT 7.62HP../90



Male header with 90° outlet direction for 400 V TNC(S) systems. UL approval for 600 V in accordance with UL61800-5-1/UL840. The pin arrangement ensures more than 3 mm of finger safety in accordance with IEC 61800-5-1.

Maximum operational reliability thanks to derating up to 125°C, a 100% failsafe pin arrangement, unique coding diversity and additional fastening.

Variants: flange, screw flange and middle flange fastening.

The high-temperature-resistant OMNIMATE® Power male header with THR (through-hole reflow) technology, suitable for the SMT process.

Technical data

In compliance with IEC 60664-1 / IEC 61984

Clamping range, max.			
Solid core H05(07) V-U			
Stranded H07 V-R			
Flexible H05(07) V-K			
Flexible with ferrule			
Ferrule with plastic collar			
Stripping length			
Screwdriver blade	mm		
According to norm			
Tightening torque range			
Rated current, max.	A	41	41
At ambient temperature		20°C	40°C
For conductor cross-section			
Overtoltage category		III	III II
Pollution severity		3	2 2
Rated voltage	V	630	630 1000
Rated impulse voltage	kV	6	6 6
UL / CUL (Use Group)		B	C D
Rated voltage	V	300	300 300
Rated current	A	40.5	40.5 10
AWG conductor	AWG		-
CSA (Use Group)		B	C D
Rated voltage	V		
Rated current	A		
AWG conductor	AWG		
General data			
Type of insulation material		PA 9T	
UL 94 flammability rating		V-0	
Contact base material		Copper alloy	
Material of contact surface		tinned	
Pin dimensions = d	mm	0.8 x 1.0	
Solder eyelet Ø = D	mm	1.4	
Solder eyelet Ø tolerance	mm	+ 0,1	

Product data

IEC: 1000 V / 41 A
 UL: 300 V / 40.5 A



For additional articles and information, refer to catalog.weidmuller.com

Note:

- Additional variants on request
- Rated current related to rated cross-section & min. No. of poles.
- P on drawing = pitch
- Rated data refer only to the component itself. Clearance and creepage distances to other components are to be designed in accordance with the relevant application standards.
- Long term storage of the product with average temperature of 50 °C and average humidity 70%, 36 months

SV-SMT 7.62HP../90G Box



Dimensioned drawing

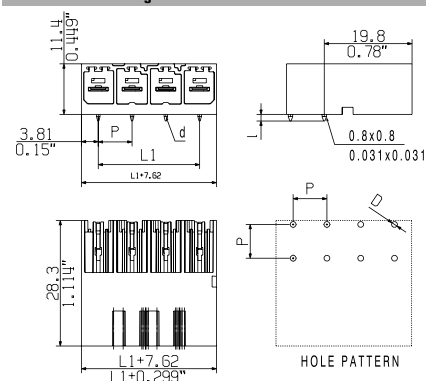

Accessories

Note: Refer to the Accessories chapter for additional accessories.

Coding	Order No.
BV/SV 7.62HP KO	1937590000

Ordering data

Solder pin length	2.6 mm			
Colour	black			
Pitch	7.62 mm			
Pol.	L1	(inch)	Qty.	Order No.
2	7.62	0.300	120	2499320000
3	15.24	0.600	78	2499500000
4	22.86	0.900	60	2499550000
5	30.48	1.200	48	2499560000

SV-SMT 7.62HP../90G Tape



Dimensioned drawing

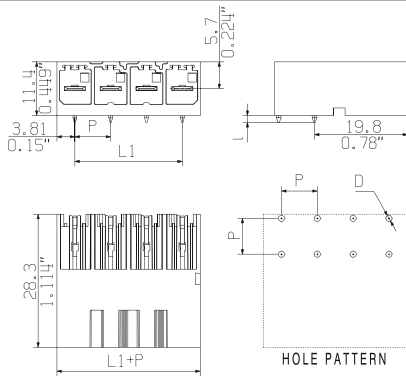

Ordering data

Solder pin length		2.6 mm			
Colour		black			
Pitch		7.62 mm			
Pol.	L1	(inch)	Qty.	Order No.	
2	7.62	0.300	110	2545800000	
3	15.24	0.600	110	2546110000	
4	22.86	0.900	110	2546120000	
5	30.48	1.200	110	2546130000	

SV-SMT 7.62HP../90F Box



Dimensioned drawing

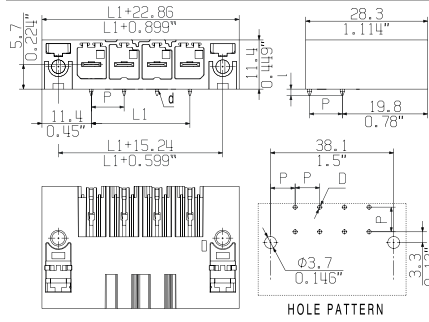

Ordering data

Solder pin length		2.6 mm			
Colour		black			
Pitch		7.62 mm			
Pol.	L1	(inch)	Qty.	Order No.	
2	7.62	0.300	60	2499520000	
3	15.24	0.600	48	2499570000	
4	22.86	0.900	50	2499580000	
5	30.48	1.200	50	2499590000	

SV-SMT 7.62HP../90SF Box



Dimensioned drawing

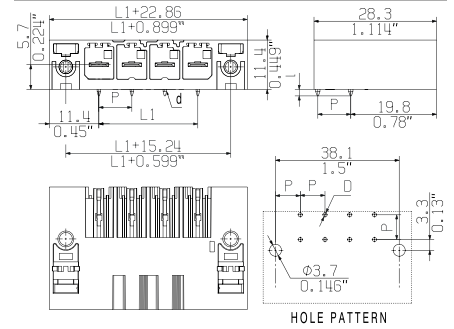

Ordering data

Solder pin length		2.6 mm			
Colour		black			
Pitch		7.62 mm			
Pol.	L1	(inch)	Qty.	Order No.	
2	22.86	0.900	60	2499600000	
3	15.24	0.600	48	2499610000	
4	22.86	0.900	36	2499620000	
5	30.48	1.200	30	2499630000	

Connectors, pitch 7.62 mm
BV/SV 7.62 series - connection up to 6 mm²

SV-SMT 7.62HP../90



Male header with 90° outlet direction for 400 V TNC(S) systems. UL approval for 600 V in accordance with UL61800-5-1/UL840. The pin arrangement ensures more than 3 mm of finger safety in accordance with IEC 61800-5-1.

Maximum operational reliability thanks to derating up to 125°C, a 100% failsafe pin arrangement, unique coding diversity and additional fastening.

Variants: flange, screw flange and middle flange fastening.

The high-temperature-resistant OMNIMATE® Power male header with THR (through-hole reflow) technology, suitable for the SMT process.

Technical data

In compliance with IEC 60664-1 / IEC 61984

Clamping range, max.			
Solid core H05(07) V-U			
Stranded H07 V-R			
Flexible H05(07) V-K			
Flexible with ferrule			
Ferrule with plastic collar			
Stripping length			
Screwdriver blade	mm		
According to norm			
Tightening torque range			
Rated current, max.	A	41	41
At ambient temperature		20°C	40°C
For conductor cross-section			
Overvoltage category		III	III II
Pollution severity		3	2 2
Rated voltage	V	630	630 1000
Rated impulse voltage	kV	6	6 6
UL / CUL (Use Group)		B	C D
Rated voltage	V	300	300 300
Rated current	A	40.5	40.5 10
AWG conductor	AWG		-
CSA (Use Group)		B	C D
Rated voltage	V		
Rated current	A		
AWG conductor	AWG		
General data			
Type of insulation material		PA 9T	
UL 94 flammability rating		V-0	
Contact base material		Copper alloy	
Material of contact surface		tinned	
Pin dimensions = d	mm	0.8 x 1.0	
Solder eyelet Ø = D	mm	1.4	
Solder eyelet Ø tolerance	mm	+ 0,1	

Product data

IEC: 1000 V / 41 A
 UL: 300 V / 40.5 A



For additional articles and information, refer to catalog.weidmuller.com

Note:

- Additional variants on request
- Rated current related to rated cross-section & min. No. of poles.
- P on drawing = pitch
- Rated data refer only to the component itself. Clearance and creepage distances to other components are to be designed in accordance with the relevant application standards.
- Long term storage of the product with average temperature of 50 °C and average humidity 70%, 36 months

SV-SMT 7.62HP../90SF Tape



Dimensioned drawing

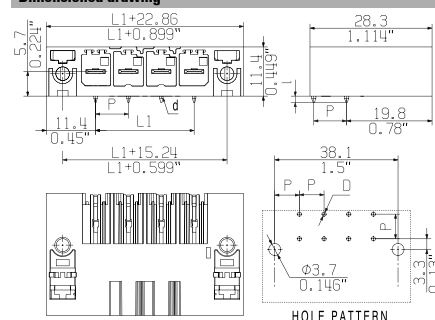

Accessories

Note: Refer to the Accessories chapter for additional accessories.

Coding	Order No.
BV/SV 7.62HP KO	1937590000

Ordering data

Solder pin length		2.6 mm	
Colour		black	
Pitch		7.62 mm	
Pol.	L1	(inch)	Qty. Order No.
2	7.62	0.300	110 2545810000
3	15.24	0.600	110 2545950000
4	22.86	0.900	95 2545960000
5	15.24	0.600	95 2545970000

SV-SMT 7.62HP/./90LF Box



Dimensioned drawing

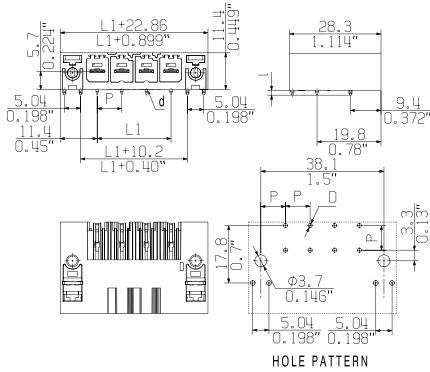

Ordering data

Solder pin length		2.6 mm		
Colour		black		
Pitch		7.62 mm		
Pol.	L1	(inch)	Qty.	Order No.
2	7.62	0.300	50	2499640000
3	15.24	0.600	50	2499650000
4	22.86	0.900	50	2499660000
5	30.48	1.200	30	2499670000

SV-SMT 7.62HP/./90LSF Box



Dimensioned drawing

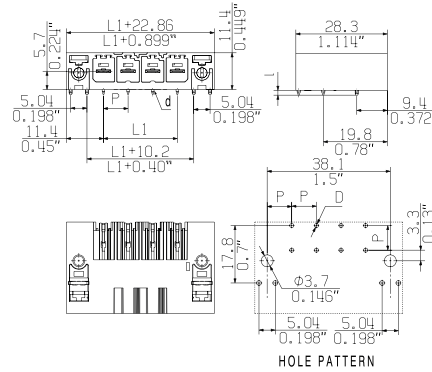

Ordering data

Solder pin length		2.6 mm		
Colour		black		
Pitch		7.62 mm		
Pol.	L1	(inch)	Qty.	Order No.
2	7.62	0.300	60	2499680000
3	15.24	0.600	48	2499690000
4	22.86	0.900	36	2499700000
5	30.48	1.200	30	2499710000

Connectors, pitch 7.62 mm
BV/SV 7.62 series - connection up to 6 mm²

SV-SMT 7.62HP../270

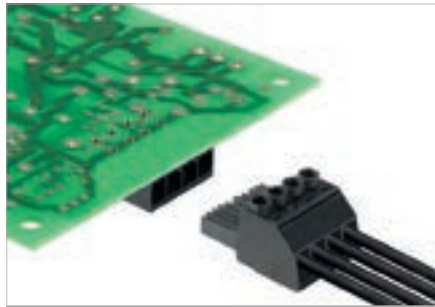

Male header with 270° outlet direction for 400 V TNC(S) systems. UL approval for 600 V in accordance with UL61800-5-1/UL840. The pin arrangement ensures finger safety of >3 mm in accordance with IEC 61800-5-1. Maximum operational reliability thanks to derating up to 125°C, a 100% failsafe pin arrangement, unique coding diversity and additional fastening.

Variants: flange, screw flange and middle flange fastening.

The high-temperature-resistant OMNIMATE® Power male header with THR (through-hole reflow) technology, suitable for the SMT process.

Technical data

In compliance with IEC 60664-1 / IEC 61984

Clamping range, max.			
Solid core H05(07) V-U			
Stranded H07 V-R			
Flexible H05(07) V-K			
Flexible with ferrule			
Ferrule with plastic collar			
Stripping length			
Screwdriver blade	mm		
According to norm			
Tightening torque range			
Rated current, max.	A	41	41
At ambient temperature		20°C	40°C
For conductor cross-section			
Overvoltage category		III	III II
Pollution severity		3	2 2
Rated voltage	V	630	630 1000
Rated impulse voltage	kV	6	6 6
UL / CUL (Use Group)		B	C D
Rated voltage	V	300	300 300
Rated current	A	40.5	40.5 10
AWG conductor	AWG		-
CSA (Use Group)		B	C D
Rated voltage	V		
Rated current	A		
AWG conductor	AWG		
General data			
Type of insulation material		PA 9T	
UL 94 flammability rating		V-0	
Contact base material		Copper alloy	
Material of contact surface		tinned	
Pin dimensions = d	mm	0.8 x 1.0	
Solder eyelet Ø = D	mm	1.4	
Solder eyelet Ø tolerance	mm	+ 0,1	

Product data

IEC: 1000 V / 41 A
 UL: 300 V / 40.5 A



For additional articles and information, refer to catalog.weidmuller.com

Note:

- Additional variants on request
- Rated current related to rated cross-section & min. No. of poles.
- P on drawing = pitch
- Rated data refer only to the component itself. Clearance and creepage distances to other components are to be designed in accordance with the relevant application standards.
- Long term storage of the product with average temperature of 50 °C and average humidity 70%, 36 months

SV-SMT 7.62HP../270G Box



Dimensioned drawing

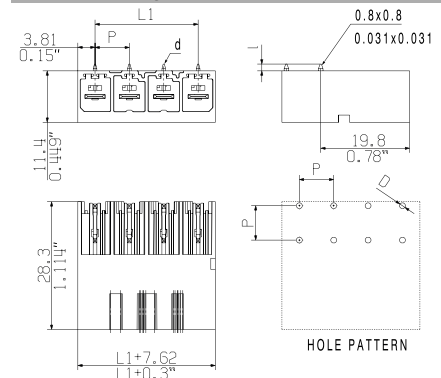

Accessories

Note: Refer to the Accessories chapter for additional accessories.

Coding	Order No.
BV/SV 7.62HP KO	1937590000

Ordering data

Solder pin length	2.6 mm			
Colour	black			
Pitch	7.62 mm			
Pol.	L1	(inch)	Qty.	Order No.
2	7.62	0.300	120	2499330000
3	15.24	0.600	78	2499340000
4	22.86	0.900	60	2499350000
5	30.48	1.200	48	2499360000

SV-SMT 7.62HP/./270G Tape



Dimensioned drawing

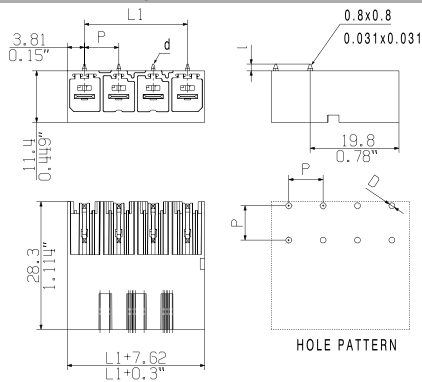

Ordering data

Solder pin length		2.6 mm	
Colour		black	
Pitch		7.62 mm	
Pol.	L1	(inch)	Order No.
2	7.62	0.300	2546140000
3	15.24	0.600	2546150000
4	22.86	0.900	2546160000
5	30.48	1.200	2546170000

SV-SMT 7.62HP/./270F Box



Dimensioned drawing

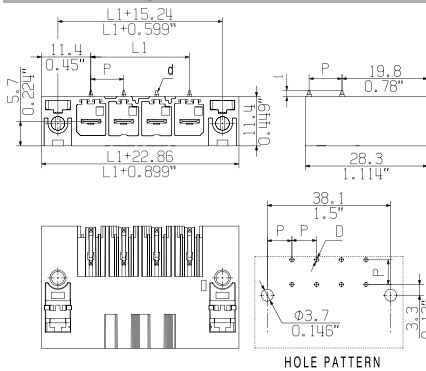

Ordering data

Solder pin length		2.6 mm	
Colour		black	
Pitch		7.62 mm	
Pol.	L1	(inch)	Order No.
2	7.62	0.300	2499540000
3	15.24	0.600	2499910000
4	22.86	0.900	2499920000
5	30.48	1.200	2499930000

SV-SMT 7.62HP/./270SF Box



Dimensioned drawing

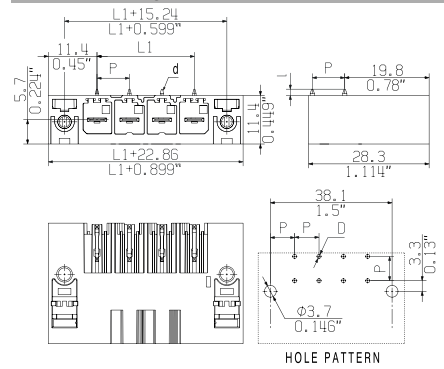

Ordering data

Solder pin length		2.6 mm	
Colour		black	
Pitch		7.62 mm	
Pol.	L1	(inch)	Order No.
2	7.62	0.300	2499940000
3	15.24	0.600	2499950000
4	22.86	0.900	2499960000
5	38.10	1.800	2499970000

Connectors, pitch 7.62 mm
BV/SV 7.62 series - connection up to 6 mm²

SV-SMT 7.62HP../270

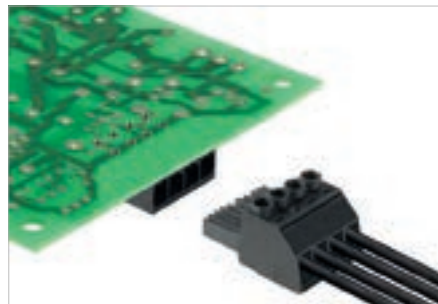

Male header with 270° outlet direction for 400 V TNC(S) systems. UL approval for 600 V in accordance with UL61800-5-1/UL840. The pin arrangement ensures finger safety of >3 mm in accordance with IEC 61800-5-1. Maximum operational reliability thanks to derating up to 125°C, a 100% failsafe pin arrangement, unique coding diversity and additional fastening.

Variants: flange, screw flange and middle flange fastening.

The high-temperature-resistant OMNIMATE® Power male header with THR (through-hole reflow) technology, suitable for the SMT process.

Product data

IEC: 1000 V / 41 A
 UL: 300 V / 40.5 A



For additional articles and information, refer to catalog.weidmuller.com

Note:

- Additional variants on request
- Rated current related to rated cross-section & min. No. of poles.
- P on drawing = pitch
- Rated data refer only to the component itself. Clearance and creepage distances to other components are to be designed in accordance with the relevant application standards.
- Long term storage of the product with average temperature of 50 °C and average humidity 70%, 36 months

SV-SMT 7.62HP../270SF Tape



Dimensioned drawing

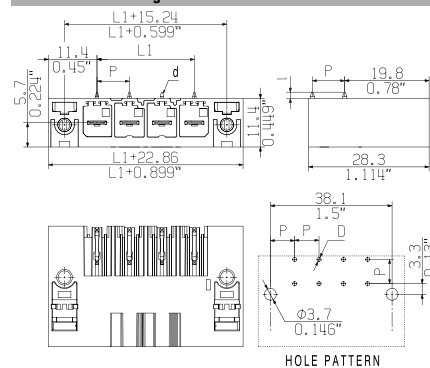

Technical data

In compliance with IEC 60664-1 / IEC 61984

Clamping range, max.			
Solid core H05(07) V-U			
Stranded H07 V-R			
Flexible H05(07) V-K			
Flexible with ferrule			
Ferrule with plastic collar			
Stripping length			
Screwdriver blade	mm		
According to norm			
Tightening torque range			
Rated current, max.	A	41	41
At ambient temperature		20°C	40°C
For conductor cross-section			
Overtoltage category		III	III II
Pollution severity		3	2 2
Rated voltage	V	630	630 1000
Rated impulse voltage	kV	6	6 6
UL / CUL (Use Group)		B	C D
Rated voltage	V	300	300 300
Rated current	A	40.5	40.5 10
AWG conductor	AWG		-
CSA (Use Group)		B	C D
Rated voltage	V		
Rated current	A		
AWG conductor	AWG		-
General data			
Type of insulation material		PA 9T	
UL 94 flammability rating		V-0	
Contact base material		Copper alloy	
Material of contact surface		tinned	
Pin dimensions = d	mm	0.8 x 1.0	
Solder eyelet Ø = D	mm	1.4	
Solder eyelet Ø tolerance	mm	+ 0,1	

Accessories

Note: Refer to the Accessories chapter for additional accessories.

Coding	Order No.
BV/SV 7.62HP KO	1937590000

Ordering data

Solder pin length	2.6 mm			
Colour	black			
Pitch	7.62 mm			
Pol.	L1	(inch)	Qty.	Order No.
2	7.62	0.300	110	2546020000
3	15.24	0.600	110	2546030000
4	22.86	0.900	95	2546040000
5	30.48	1.200	95	2546050000

Connectors, pitch 7.62 mm
BV/SV 7.62 series - connection up to 6 mm²

SV 7.62HP/./90



Male header with 90° outlet direction for 400 V TNC(S) systems. UL approval for 600 V in acc. with UL61800-5-1 / UL840. The pin arrangement ensures more than 3 mm of touch-safety in acc. with IEC 61800-5-1.

Maximum connection and operating reliability thanks to: derating up to 125°C, pin arrangement that prevents wrong connections or incorrect wiring, unique coding diversity, additional fastening.

Variants: flange, screw flange and middle flange fastening.

Product data

IEC: 1000 V / 57 A
 UL: 300 V / 40.5 A



For additional articles and information, refer to catalog.weidmuller.com

Note:

- Additional variants on request
- Rated current related to rated cross-section & min. No. of poles.
- P on drawing = pitch
- Rated data refer only to the component itself. Clearance and creepage distances to other components are to be designed in accordance with the relevant application standards.
- Diameter of solder eyelet D = 1.4+0.1 mm starting with 8-pole
- Long term storage of the product with average temperature of 50 °C and average humidity 70%, 36 months

SV 7.62HP/./90G



Dimensioned drawing

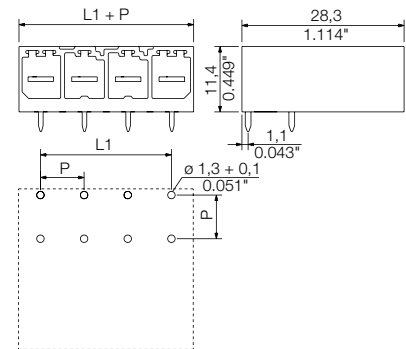

Technical data

In compliance with IEC 60664-1 / IEC 61984			
Clamping range, max.			
Solid core H05(07) V-U			
Stranded H07 V-R			
Flexible H05(07) V-K			
Flexible with ferrule			
Ferrule with plastic collar			
Stripping length			
Screwdriver blade	mm		
According to norm			
Tightening torque range			
Rated current, max.	A	57	41
At ambient temperature		20°C	40°C
For conductor cross-section			
Overtolerance category		III	III II
Pollution severity		3	2 2
Rated voltage	V	630	630 1000
Rated impulse voltage	kV	6	6 6
UL / CUL (Use Group)		B	C D
Rated voltage	V	300	300 600
Rated current	A	40.5	40.5 5
AWG conductor	AWG		-
CSA (Use Group)		B	C D
Rated voltage	V	300	300 600
Rated current	A	35	35 5
AWG conductor	AWG		-
General data			
Type of insulation material		PA GF	
UL 94 flammability rating		V-0	
Contact base material		Copper alloy	
Material of contact surface		tinned	
Pin dimensions = d	mm	0.8 x 1.0	
Solder eyelet Ø = D	mm	1.3	
Solder eyelet Ø tolerance	mm	+ 0,1	

Accessories

Note: Refer to the Accessories chapter for additional accessories.

Coding	Order No.
BV/SV 7.62HP KO	1937590000

Ordering data

Solder pin length		3.5 mm		
Colour		black		
Pitch		7.62 mm		
Pol.	L1	(inch)	Qty.	Order No.
2	7.62	0.300	120	1930270000
3	15.24	0.600	78	1930280000
4	22.86	0.900	60	1930290000
5	30.48	1.200	48	1930300000
6	38.10	1.500	36	1930310000
7	45.72	1.800	30	1930320000
8	53.34	2.100	30	1930330000
9	60.96	2.400	24	1930340000
10	68.58	2.700	24	1930350000
11	76.20	3.000	18	1930360000
12	83.82	3.300	18	1930370000

SV 7.62HP../90F



SV 7.62HP../90SF



Dimensioned drawing

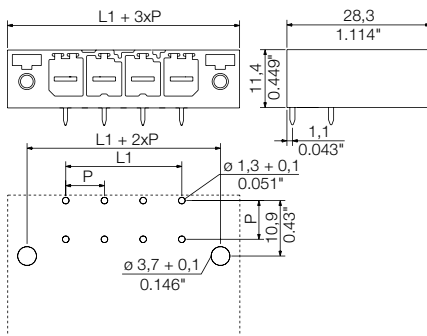

Dimensioned drawing

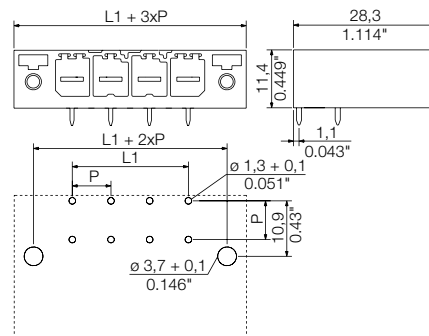

Ordering data

Solder pin length		3.5 mm	
Colour		black	
Pitch		7.62 mm	
Pol.	L1	(inch)	Qty. Order No.
2	7.62	0.300	60 1930380000
3	15.24	0.600	48 1930390000
4	22.86	0.900	36 1930400000
5	30.48	1.200	30 1930410000
6	38.10	1.500	30 1930420000
7	45.72	1.800	24 1930430000
8	53.34	2.100	24 1930440000
9	60.96	2.400	18 1930450000
10	68.58	2.700	18 1930460000
11	76.20	3.000	18 1930470000
12	83.82	3.300	12 1930480000

Ordering data

Solder pin length		3.5 mm	
Colour		black	
Pitch		7.62 mm	
Pol.	L1	(inch)	Qty. Order No.
2	7.62	0.300	60 1930490000
3	15.24	0.600	48 1930500000
4	22.86	0.900	36 1930510000
5	30.48	1.200	30 1930520000
6	38.10	1.500	30 1930530000
7	45.72	1.800	24 1930540000
8	53.34	2.100	24 1930550000
9	60.96	2.400	18 1930560000
10	68.58	2.700	18 1930570000
11	76.20	3.000	18 1930580000
12	83.82	3.300	12 1930590000

Connectors, pitch 7.62 mm
BV/SV 7.62 series - connection up to 6 mm²

SV 7.62HP/./90MF



Male header with 90° outlet direction for 400 V TNC(S) systems. UL approval for 600 V in acc. with UL61800-5-1 / UL840. The pin arrangement ensures more than 3 mm of touch-safety in acc. with IEC 61800-5-1.

Maximum connection and operating reliability thanks to: derating up to 125°C, pin arrangement that prevents wrong connections or incorrect wiring, unique coding diversity, additional fastening.

Variants: flange, screw flange and middle flange fastening.

Product data

IEC: 1000 V / 57 A
 UL: 300 V / 40.5 A



For additional articles and information, refer to catalog.weidmuller.com

Note:

- Additional variants on request
- Rated current related to rated cross-section & min. No. of poles.
- P on drawing = pitch
- Rated data refer only to the component itself. Clearance and creepage distances to other components are to be designed in accordance with the relevant application standards.
- Long term storage of the product with average temperature of 50 °C and average humidity 70%, 36 months

SV 7.62HP/./90MF2



Dimensioned drawing

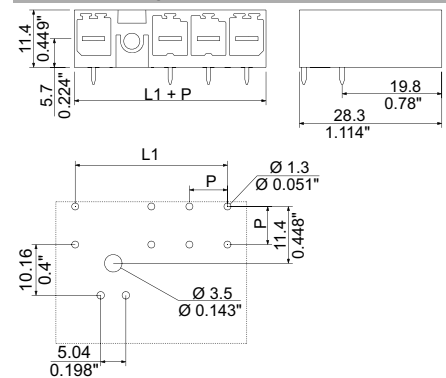

Technical data

In compliance with IEC 60664-1 / IEC 61984			
Clamping range, max.			
Solid core H05(07) V-U			
Stranded H07 V-R			
Flexible H05(07) V-K			
Flexible with ferrule			
Ferrule with plastic collar			
Stripping length			
Screwdriver blade	mm		
According to norm			
Tightening torque range			
Rated current, max.	A	57	41
At ambient temperature		20°C	40°C
For conductor cross-section			
Overvoltage category		III	III II
Pollution severity		3	2 2
Rated voltage	V	630	630 1000
Rated impulse voltage	kV	6	6 6
UL / CUL (Use Group)		B	C D
Rated voltage	V	300	300 600
Rated current	A	40.5	40.5 5
AWG conductor	AWG		-
CSA (Use Group)		B	C D
Rated voltage	V	300	300 600
Rated current	A	35	35 5
AWG conductor	AWG		-
General data			
Type of insulation material		PA GF	
UL 94 flammability rating		V-0	
Contact base material		Copper alloy	
Material of contact surface		tinned	
Pin dimensions = d	mm	0.8 x 1.0	
Solder eyelet Ø = D	mm	1.3	
Solder eyelet Ø tolerance	mm	+ 0,1	

Accessories

Note: Refer to the Accessories chapter for additional accessories.

Coding	Order No.
BV/SV 7.62HP KO	1937590000

Ordering data

Solder pin length		3.5 mm		
Colour		black		
Pitch		7.62 mm		
Pol.	L1	(inch)	Qty.	Order No.
2	15.24	0.600	78	1048390000
3	22.86	0.900	60	1048500000
4	30.48	1.200	48	1464270000
5	38.10	1.500	36	1464280000
6	45.72	1.800	30	1543090000

SV 7.62HP../90MF3



Dimensioned drawing

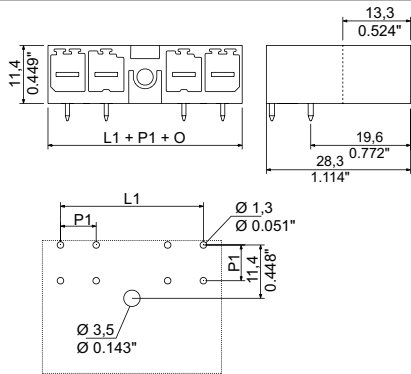

Ordering data

Solder pin length		3.5 mm		
Colour		black		
Pitch		7.62 mm		
Pol.	L1	(inch)	Qty.	Order No.
3	22.86	0.900	60	1048490000
4	30.48	1.200	48	1048570000
5	38.10	1.500	36	1048690000
6	45.72	1.800	30	1543120000

SV 7.62HP../90MF4



Dimensioned drawing

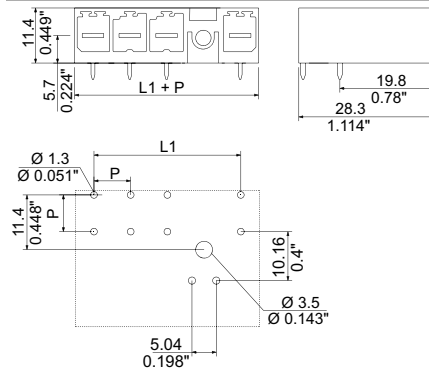

Ordering data

Solder pin length		3.5 mm		
Colour		black		
Pitch		7.62 mm		
Pol.	L1	(inch)	Qty.	Order No.
4	30.48	1.200	48	1464290000
5	38.10	1.500	36	1048680000
6	45.72	1.800	30	1048760000

Connectors, pitch 7.62 mm
BV/SV 7.62 series - connection up to 6 mm²

SV 7.62HP../180



Male header with 180° outlet direction for 400 V TNC(S) systems. UL approval for 600 V in acc. with UL61800-5-1 / UL840. The pin arrangement ensures more than 3 mm of touch-safety in acc. with IEC 61800-5-1.

Maximum connection and operating reliability thanks to: derating up to 125°C, pin arrangement that prevents wrong connections or incorrect wiring, unique coding diversity, additional fastening and integrated positioning aid.

Variants: flange, screw flange and middle flange fastening.

Product data

IEC: 1000 V / 57 A
 UL: 300 V / 40.5 A



For additional articles and information, refer to catalog.weidmueller.com

Note:

- Additional variants on request
- Rated current related to rated cross-section & min. No. of poles.
- P on drawing = pitch
- Rated data refer only to the component itself. Clearance and creepage distances to other components are to be designed in accordance with the relevant application standards.
- Diameter of solder eyelet D = 1.4+0.1 mm starting with 8-pole
- Long term storage of the product with average temperature of 50 °C and average humidity 70%, 36 months

SV 7.62HP../180G



Dimensioned drawing

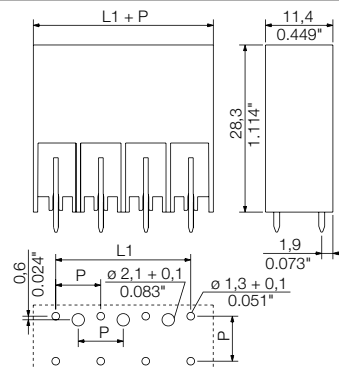

Technical data

In compliance with IEC 60664-1 / IEC 61984

Clamping range, max.			
Solid core H05(07) V-U			
Stranded H07 V-R			
Flexible H05(07) V-K			
Flexible with ferrule			
Ferrule with plastic collar			
Stripping length			
Screwdriver blade	mm		
According to norm			
Tightening torque range			
Rated current, max.	A	57	41
At ambient temperature		20°C	40°C
For conductor cross-section			
Overvoltage category		III	III II
Pollution severity		3	2 2
Rated voltage	V	630	630 1000
Rated impulse voltage	kV	6	6 6
UL / CUL (Use Group)		B	C D
Rated voltage	V	300	300 600
Rated current	A	40.5	40.5 5
AWG conductor	AWG		-
CSA (Use Group)		B	C D
Rated voltage	V	300	300 600
Rated current	A	35	35 5
AWG conductor	AWG		-
General data			
Type of insulation material		PA GF	
UL 94 flammability rating		V-0	
Contact base material		Copper alloy	
Material of contact surface		tinned	
Pin dimensions = d	mm	0.8 x 1.0	
Solder eyelet Ø = D	mm	1.3	
Solder eyelet Ø tolerance	mm	+ 0,1	

Accessories

Note: Refer to the Accessories chapter for additional accessories.

Coding		Order No.
	BV/SV 7.62HP K0	1937590000
Protection against twisting		
	VDS180 SV7.62	1853940000

Ordering data

Solder pin length		3.5 mm		
Colour		black		
Pitch		7.62 mm		
Pol.	L1	(inch)	Qty.	Order No.
2	7.62	0.300	120	1930600000
3	15.24	0.600	78	1930610000
4	22.86	0.900	60	1930620000
5	30.48	1.200	48	1930630000
6	38.10	1.500	36	1930640000
7	45.72	1.800	30	1930650000
8	53.34	2.100	30	1930660000
9	60.96	2.400	24	1930670000
10	68.58	2.700	24	1930680000
11	76.20	3.000	18	1930690000
12	83.82	3.300	18	1930700000

SV 7.62HP../180F



Dimensioned drawing

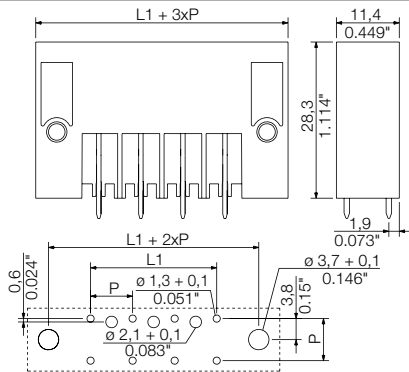

Ordering data

Solder pin length		3.5 mm			
Colour		black			
Pitch		7.62 mm			
Pol.	L1	(inch)	Qty.	Order No.	
2	7.62	0.300	60	1930710000	
3	15.24	0.600	48	1930720000	
4	22.86	0.900	36	1930730000	
5	30.48	1.200	30	1930740000	
6	38.10	1.500	30	1930750000	
7	45.72	1.800	24	1930760000	
8	53.34	2.100	24	1930770000	
9	60.96	2.400	18	1930780000	
10	68.58	2.700	18	1930790000	
11	76.20	3.000	18	1930800000	
12	83.82	3.300	12	1930810000	

SV 7.62HP../180SF



Dimensioned drawing

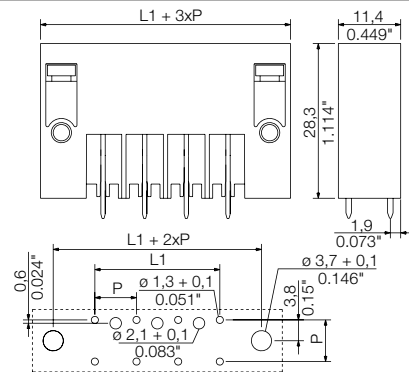

Ordering data

Solder pin length		3.5 mm			
Colour		black			
Pitch		7.62 mm			
Pol.	L1	(inch)	Qty.	Order No.	
2	7.62	0.300	60	1930820000	
3	15.24	0.600	48	1930830000	
4	22.86	0.900	36	1930840000	
5	30.48	1.200	30	1930850000	
6	38.10	1.500	30	1930860000	
7	45.72	1.800	24	1930870000	
8	53.34	2.100	24	1930880000	
9	60.96	2.400	18	1930890000	
10	68.58	2.700	18	1930900000	
11	76.20	3.000	18	1930910000	
12	83.82	3.300	12	1930920000	

Connectors, pitch 7.62 mm
BV/SV 7.62 series - connection up to 6 mm²

SV 7.62HP../180MF

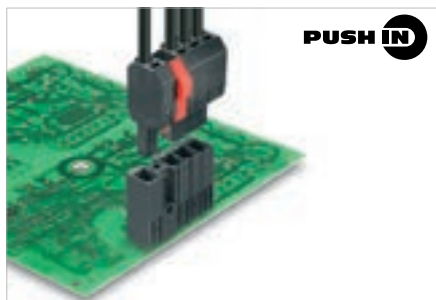

Male header with 180° outlet direction for 400 V TNC(S) systems. UL approval for 600 V in acc. with UL61800-5-1 / UL840. The pin arrangement ensures more than 3 mm of touch-safety in acc. with IEC 61800-5-1.

Maximum connection and operating reliability thanks to: derating up to 125°C, pin arrangement that prevents wrong connections or incorrect wiring, unique coding diversity, additional fastening and integrated positioning aid.

Variants: flange, screw flange and middle flange fastening.

Product data

IEC: 1000 V / 57 A
 UL: 300 V / 40.5 A



For additional articles and information, refer to catalog.weidmuller.com

Note:

- Additional variants on request
- Rated current related to rated cross-section & min. No. of poles.
- P on drawing = pitch
- Rated data refer only to the component itself. Clearance and creepage distances to other components are to be designed in accordance with the relevant application standards.
- Long term storage of the product with average temperature of 50 °C and average humidity 70%, 36 months

SV 7.62HP../180MF2



Dimensioned drawing

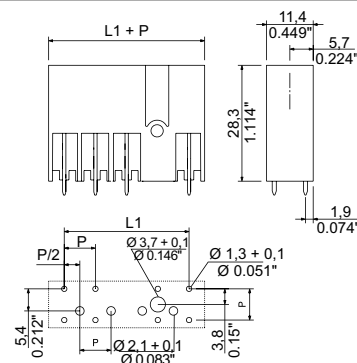

Technical data

In compliance with IEC 60664-1 / IEC 61984			
Clamping range, max.			
Solid core H05(07) V-U			
Stranded H07 V-R			
Flexible H05(07) V-K			
Flexible with ferrule			
Ferrule with plastic collar			
Stripping length			
Screwdriver blade	mm		
According to norm			
Tightening torque range			
Rated current, max.	A	57	41
At ambient temperature		20°C	40°C
For conductor cross-section			
Overvoltage category		III	III II
Pollution severity		3	2 2
Rated voltage	V	630	630 1000
Rated impulse voltage	kV	6	6 6
UL / CUL (Use Group)		B	C D
Rated voltage	V	300	300 600
Rated current	A	40.5	40.5 5
AWG conductor	AWG		-
CSA (Use Group)		B	C D
Rated voltage	V	300	300 600
Rated current	A	35	35 5
AWG conductor	AWG		-
General data			
Type of insulation material		PA GF	
UL 94 flammability rating		V-0	
Contact base material		Copper alloy	
Material of contact surface		tinned	
Pin dimensions = d	mm	0.8 x 1.0	
Solder eyelet Ø = D	mm	1.3	
Solder eyelet Ø tolerance	mm	+ 0,1	

Accessories

Note: Refer to the Accessories chapter for additional accessories.

Coding		Order No.
	BV/SV 7.62HP K0	1937590000
Protection against twisting		
	VDS180 SV7.62	1853940000

Ordering data

Solder pin length		3.5 mm	
Colour		black	
Pitch 7.62 mm			
Pol.	L1	(inch)	Qty. Order No.
2	15.24	0.600	78 1048350000
3	22.86	0.900	60 1048410000
4	30.48	1.200	48 1464310000
5	38.10	1.500	36 1464320000
6	45.72	1.800	30 1543190000

SV 7.62HP../180MF3



Dimensioned drawing

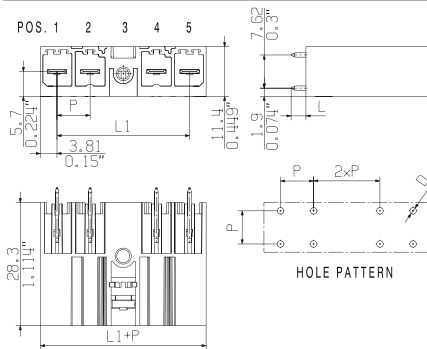

Ordering data

Solder pin length		3.5 mm		
Colour		black		
Pitch		7.62 mm		
Pol.	L1	(inch)	Qty.	Order No.
3	22.86	0.900	60	1048420000
4	30.48	1.200	48	1048530000
5	38.10	1.500	36	1048590000
6	45.72	1.800	30	1543210000

SV 7.62HP../180MF4



Dimensioned drawing

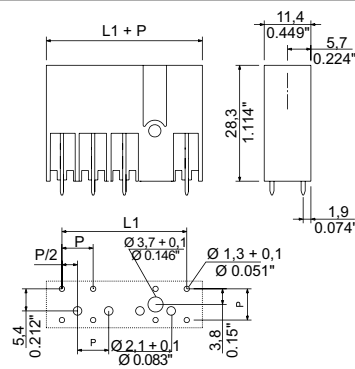

Ordering data

Solder pin length		3.5 mm		
Colour		black		
Pitch		7.62 mm		
Pol.	L1	(inch)	Qty.	Order No.
4	30.48	1.200	48	1464330000
5	38.10	1.500	36	1048600000
6	45.72	1.800	30	1048720000

Connectors, pitch 7.62 mm
BV/SV 7.62 series - connection up to 6 mm²

SV 7.62HP/./270

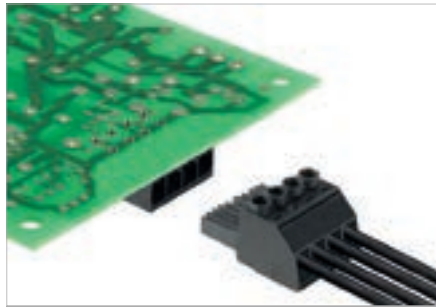

Male header with 270° outlet direction for 400 V TNC(S) systems. UL approval for 600 V in acc. with UL61800-5-1 / UL840. The pin arrangement ensures more than 3 mm of touch-safety in acc. with IEC 61800-5-1.

Maximum connection and operating reliability thanks to: derating up to 125°C, pin arrangement that prevents wrong connections or incorrect wiring, unique coding diversity, additional fastening.

Variants: flange, screw flange and middle flange fastening.

Product data

IEC: 1000 V / 57 A
 UL: 300 V / 40.5 A



For additional articles and information, refer to catalog.weidmueller.com

Note:

- Additional variants on request
- Rated current related to rated cross-section & min. No. of poles.
- P on drawing = pitch
- Rated data refer only to the component itself. Clearance and creepage distances to other components are to be designed in accordance with the relevant application standards.
- Diameter of solder eyelet D = 1.4+0.1 mm starting with 8-pole
- Long term storage of the product with average temperature of 50 °C and average humidity 70%, 36 months

SV 7.62HP/./270G



Dimensioned drawing

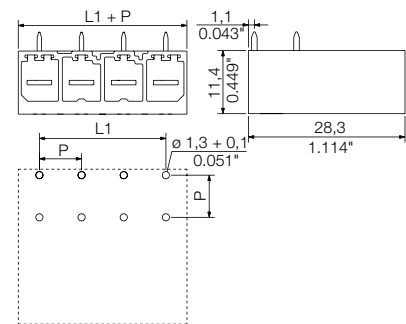

Technical data

In compliance with IEC 60664-1 / IEC 61984

Clamping range, max.			
Solid core H05(07) V-U			
Stranded H07 V-R			
Flexible H05(07) V-K			
Flexible with ferrule			
Ferrule with plastic collar			
Stripping length			
Screwdriver blade	mm		
According to norm			
Tightening torque range			
Rated current, max.	A	57	41
At ambient temperature		20°C	40°C
For conductor cross-section			
Overtoltage category		III	III II
Pollution severity		3	2 2
Rated voltage	V	630	630 1000
Rated impulse voltage	kV	6	6 6
UL / CUL (Use Group)		B	C D
Rated voltage	V	300	300 600
Rated current	A	40.5	40.5 5
AWG conductor	AWG		-
CSA (Use Group)		B	C D
Rated voltage	V	300	300 600
Rated current	A	35	35 5
AWG conductor	AWG		-
General data			
Type of insulation material		PA GF	
UL 94 flammability rating		V-0	
Contact base material		Copper alloy	
Material of contact surface		tinned	
Pin dimensions = d	mm	0.8 x 1.0	
Solder eyelet Ø = D	mm	1.3	
Solder eyelet Ø tolerance	mm	+ 0,1	

Accessories

Note: Refer to the Accessories chapter for additional accessories.

Coding	Order No.
BV/SV 7.62HP KO	1937590000

Ordering data

Solder pin length		3.5 mm		
Colour		black		
Pitch		7.62 mm		
Pol.	L1	(inch)	Qty.	Order No.
2	7.62	0.300	120	1931260000
3	15.24	0.600	78	1931270000
4	22.86	0.900	60	1931280000
5	30.48	1.200	48	1931290000
6	38.10	1.500	36	1931300000
7	45.72	1.800	30	1931310000
8	53.34	2.100	30	1931320000
9	60.96	2.400	24	1931330000
10	68.58	2.700	24	1931340000
11	76.20	3.000	18	1931350000
12	83.82	3.300	18	1931360000

SV 7.62HP../270F



Dimensioned drawing

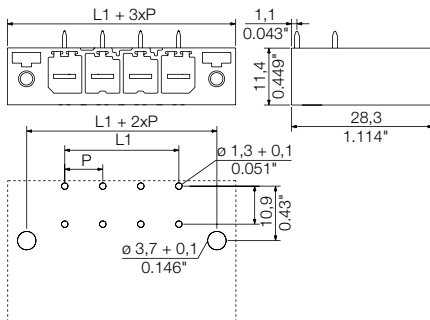

SV 7.62HP../270SF



Dimensioned drawing

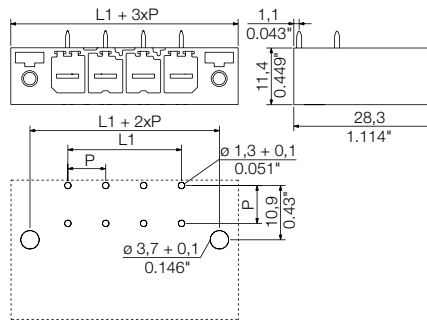

Ordering data

Solder pin length		3.5 mm	
Colour		black	
Pitch		7.62 mm	
Pol.	L1	(inch)	Qty. Order No.
2	7.62	0.300	60 1931370000
3	15.24	0.600	48 1931380000
4	22.86	0.900	36 1931390000
5	30.48	1.200	30 1931400000
6	38.10	1.500	30 1931410000
7	45.72	1.800	24 1931420000
8	53.34	2.100	24 1931430000
9	60.96	2.400	18 1931440000
10	68.58	2.700	18 1931450000
11	76.20	3.000	18 1931460000
12	83.82	3.300	12 1931470000

Ordering data

Solder pin length		3.5 mm	
Colour		black	
Pitch		7.62 mm	
Pol.	L1	(inch)	Qty. Order No.
2	7.62	0.300	60 1931480000
3	15.24	0.600	48 1931490000
4	22.86	0.900	36 1931500000
5	30.48	1.200	30 1931510000
6	38.10	1.500	30 1931520000
7	45.72	1.800	24 1931530000
8	53.34	2.100	24 1931540000
9	60.96	2.400	18 1931550000
10	68.58	2.700	18 1931570000
11	76.20	3.000	18 1931580000
12	83.82	3.300	12 1931590000

Connectors, pitch 7.62 mm
BV/SV 7.62 series - connection up to 6 mm²

SV 7.62HP/./270MF

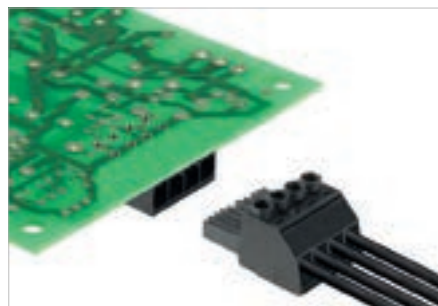

Male header with 180° outlet direction for 400 V TNC(S) systems. UL approval for 600 V in acc. with UL61800-5-1 / UL840. The pin arrangement ensures more than 3 mm of touch-safety in acc. with IEC 61800-5-1.

Maximum connection and operating reliability thanks to: derating up to 125°C, pin arrangement that prevents wrong connections or incorrect wiring, unique coding diversity, additional fastening.

Variants: flange, screw flange and middle flange fastening.

Product data

IEC: 1000 V / 57 A
 UL: 300 V / 40.5 A



For additional articles and information, refer to catalog.weidmuller.com

Note:

- Additional variants on request
- Rated current related to rated cross-section & min. No. of poles.
- P on drawing = pitch
- Rated data refer only to the component itself. Clearance and creepage distances to other components are to be designed in accordance with the relevant application standards.
- Long term storage of the product with average temperature of 50 °C and average humidity 70%, 36 months

SV 7.62HP/./270MF2



Dimensioned drawing

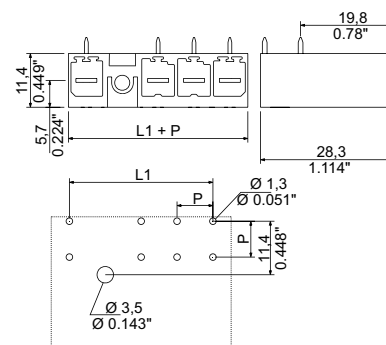

Technical data

In compliance with IEC 60664-1 / IEC 61984

Clamping range, max.			
Solid core H05(07) V-U			
Stranded H07 V-R			
Flexible H05(07) V-K			
Flexible with ferrule			
Ferrule with plastic collar			
Stripping length			
Screwdriver blade	mm		
According to norm			
Tightening torque range			
Rated current, max.	A	57	41
At ambient temperature		20°C	40°C
For conductor cross-section			
Overvoltage category		III	III II
Pollution severity		3	2 2
Rated voltage	V	630	630 1000
Rated impulse voltage	kV	6	6 6
UL / CUL (Use Group)		B	C D
Rated voltage	V	300	300 600
Rated current	A	40.5	40.5 5
AWG conductor	AWG		-
CSA (Use Group)		B	C D
Rated voltage	V	300	300 600
Rated current	A	35	35 5
AWG conductor	AWG		-
General data			
Type of insulation material		PA GF	
UL 94 flammability rating		V-0	
Contact base material		Copper alloy	
Material of contact surface		tinned	
Pin dimensions = d	mm	0.8 x 1.0	
Solder eyelet Ø = D	mm	1.3	
Solder eyelet Ø tolerance	mm	+ 0,1	

Accessories

Note: Refer to the Accessories chapter for additional accessories.

Coding	Order No.
BV/SV 7.62HP KO	1937590000

Ordering data

Solder pin length	3.5 mm			
Colour	black			
Pitch	7.62 mm			
Pol.	L1	(inch)	Qty.	Order No.
2	15.24	0.600	78	1048370000
3	22.86	0.900	60	1048450000
4	30.48	1.200	48	1464340000
5	38.10	1.500	36	1464350000
6	45.72	1.800	30	1543250000

SV 7.62HP/./270MF3



Dimensioned drawing

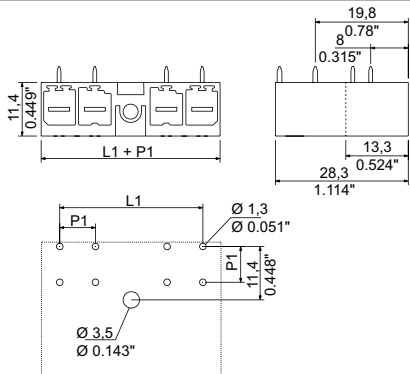

Ordering data

Solder pin length		3.5 mm		
Colour		black		
Pitch		7.62 mm		
Pol.	L1	(inch)	Qty.	Order No.
3	22.86	0.900	60	1048460000
4	30.48	1.200	48	1048550000
5	38.10	1.500	36	1048640000
6	45.72	1.800	30	1543260000

SV 7.62HP/./270MF4



Dimensioned drawing

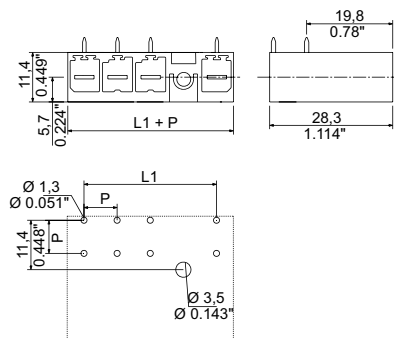

Ordering data

Solder pin length		3.5 mm		
Colour		black		
Pitch		7.62 mm		
Pol.	L1	(inch)	Qty.	Order No.
4	30.48	1.200	48	1464360000
5	38.10	1.500	36	1048650000
6	45.72	1.800	30	1048740000

Connectors, pitch 7.62 mm
BV/SV 7.62 series - connection up to 6 mm²

SVD 7.62HP../270

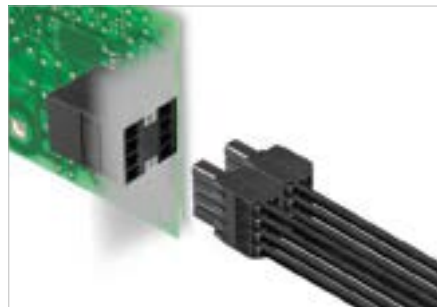

Double-row high-current, high-performance pin headers, with or without flange, for fast, tool-free locking. Optimised for "book-size modules" measuring 50 mm wide and above. With integrated mounting option for mounting to the housing wall. Exceptional reliability and operational safety thanks to 100% failsafe mating profile, unique coding and optional additional screw mounting in the flange.

Technical data

In compliance with IEC 60664-1 / IEC 61984

Clamping range, max.			
Solid core H05(07) V-U			
Stranded H07 V-R			
Flexible H05(07) V-K			
Flexible with ferrule			
Ferrule with plastic collar			
Stripping length			
Screwdriver blade	mm		
According to norm			
Tightening torque range			
Rated current, max.	A	47	42
At ambient temperature		20°C	40°C
For conductor cross-section			
Overvoltage category		III	III II
Pollution severity		3	2 2
Rated voltage	V	630	630 1000
Rated impulse voltage	kV	6	6 6
UL / CUL (Use Group)	B C D		
Rated voltage	V	300	300 600
Rated current	A	30	30 5
AWG conductor	AWG	-	
CSA (Use Group)	B C D		
Rated voltage	V	300	300 300
Rated current	A		5
AWG conductor	AWG	-	
General data			
Type of insulation material	PA GF		
UL 94 flammability rating	V-0		
Contact base material	Copper alloy		
Material of contact surface	tinned		
Pin dimensions = d	mm	0.8 x 1.0	
Solder eyelet Ø = D	mm	1.4	
Solder eyelet Ø tolerance	mm	+ 0,1	

Product data

IEC: 1000 V / 47 A
 UL: 300 V / 30 A



For additional articles and information, refer to catalog.weidmuller.com

Note:

- Additional variants on request
- Rated current related to rated cross-section & min. No. of poles.
- P on drawing = pitch
- Rated data refer only to the component itself. Clearance and creepage distances to other components are to be designed in accordance with the relevant application standards.
- Long term storage of the product with average temperature of 50 °C and average humidity 70%, 36 months

SVD 7.62HP../270G



Dimensioned drawing

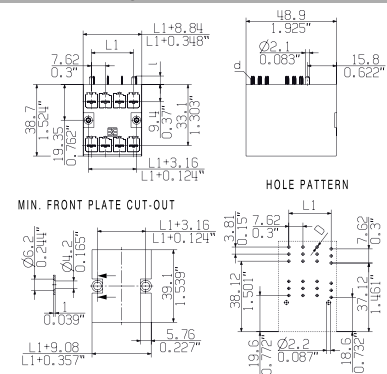

Accessories

Note: Refer to the Accessories chapter for additional accessories.

Coding	Order No.
BV/SV 7.62HP KO	1937590000

Ordering data

Solder pin length	3.2 mm			
Colour	black			
Pitch	7.62 mm			
Pol.	L1	(inch)	Qty.	Order No.
4	7.62	0.300	60	1543290000
6	15.24	0.600	42	1543310000
8	22.86	0.900	30	1543320000
10	30.48	1.200	24	1543330000
12	38.10	1.500	21	1543340000

SVD 7.62HP/./270F



Dimensioned drawing

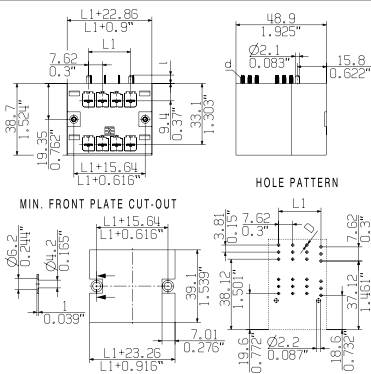

Ordering data

Solder pin length		3.2 mm		
Colour		black		
Pitch		7.62 mm		
Pol.	L1	(inch)	Qty.	Order No.
4	7.62	0.300	33	1523940000
6	15.24	0.600	24	1523950000
8	22.86	0.900	21	1523970000
10	30.48	1.200	18	1523980000
12	38.10	1.500	15	1523990000



Connectors, pitch 7.62 mm
BV/SV 7.62 series - connection up to 6 mm²

SVF 7.62HP../180

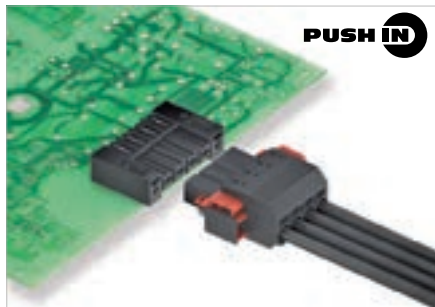

Male plug in 180° outlet direction and PUSH IN spring connection for TNC(S) networks. Also perfect for finger-safe solutions involving inverse voltages. Meets the requirements of UL1059 for 600 V Use Group C. The mating profile ensures touch-safety of > 3 mm in accordance with IEC 61800-5-1.

Maximum operational reliability: with a derating up to 125°C, a mating profile that can only be plugged in correct, and unique coding capability.

- Available with a flange (F) and a screw flange (SF).

Product data

IEC: 1000 V / 57 A / 0.5 - 10 mm²
 UL: 600 V / 39 A / AWG 24 - 10



For additional articles and information, refer to catalog.weidmueller.com

Note:

- Additional variants on request
- Rated current related to rated cross-section & min. No. of poles.
- Wire end ferrule without plastic collar to DIN 46228/1
- Wire end ferrule with plastic collar to DIN 46228/4
- P on drawing = pitch
- Rated data refer only to the component itself. Clearance and creepage distances to other components are to be designed in accordance with the relevant application standards.
- Long term storage of the product with average temperature of 50 °C and average humidity 70%, 36 months

SVF 7.62HP../180G



Dimensioned drawing

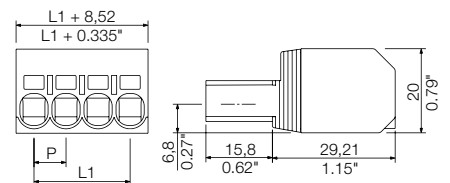

Technical data

In compliance with IEC 60664-1 / IEC 61984			
Clamping range, max.	mm ²	0.5...10	
Solid core H05(07) V-U	mm²	0.5...6	
Stranded H07 V-R		...10	
Flexible H05(07) V-K	mm ²	0.5...10	
Flexible with ferrule	mm ²	1.5...6	
Ferrule with plastic collar	mm ²	1.5...6	
Stripping length	mm	12	
Screwdriver blade	mm	0.6 x 3.5	
According to norm			
Tightening torque range			
Rated current, max.	A	57	57
At ambient temperature		20°C	40°C
For conductor cross-section	mm ²	6	
Overvoltage category		III	III II
Pollution severity		3	2 2
Rated voltage	V	800	800 1000
Rated impulse voltage	kV	8	8 6
UL / CUL (Use Group)	B C D		
Rated voltage	V	600	600 600
Rated current	A	39	39 5
AWG conductor	AWG	24-10	
CSA (Use Group)	B C D		
Rated voltage	V	600	600 600
Rated current	A	36	36 5
AWG conductor	AWG	24-10	
General data			
Type of insulation material		PA GF	
UL 94 flammability rating		V-0	
Contact base material		Copper alloy	
Material of contact surface		tinned	
Pin dimensions = d	mm		
Solder eyelet Ø = D	mm		
Solder eyelet Ø tolerance	mm		

Accessories

Note: Refer to the Accessories chapter for additional accessories.

Coding		Order No.
	BV/SV 7.62HP K0	1937590000
Screwdriver		
	SDS 0.8X4.5X125	2749370000
Pressing tool		
	PZ 6/5	9011460000

Ordering data

Solder pin length				
Colour	black			
Pitch	7.62 mm			
Pol.	L1	(inch)	Qty.	Order No.
2	7.62	0.300	95	1060830000
3	15.24	0.600	65	1060840000
4	22.86	0.900	45	1060850000
5	30.48	1.200	40	1060870000
6	38.10	1.500	30	1060880000

Representative deratings curve

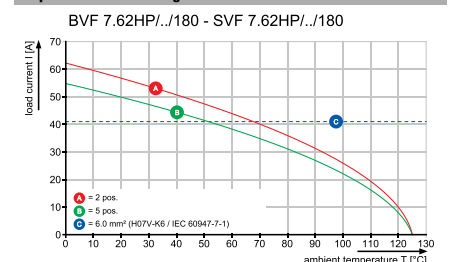

SVF 7.62HP../180F



Dimensioned drawing

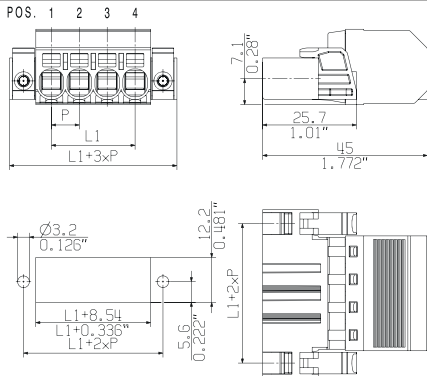

Ordering data

Solder pin length					
Colour					black
Pitch 7.62 mm					
Pol.	L1	(inch)	Qty.	Order No.	
2	7.62	0.300	50	1060900000	
3	15.24	0.600	40	1060910000	
4	22.86	0.900	30	1060920000	
5	30.48	1.200	25	1060930000	

SVF 7.62HP../180SF



Dimensioned drawing

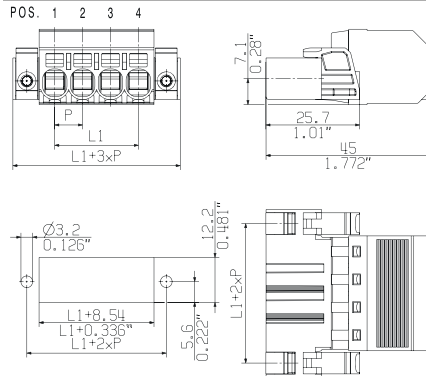

Ordering data

Solder pin length					
Colour					black
Pitch 7.62 mm					
Pol.	L1	(inch)	Qty.	Order No.	
2	7.62	0.300	50	1060950000	
3	15.24	0.600	40	1060970000	
4	22.86	0.900	30	1060980000	
5	30.48	1.200	25	1061000000	

Connectors, pitch 7.62 mm
BV/SV 7.62 series - connection up to 6 mm²

SVF 7.62HP../180 I

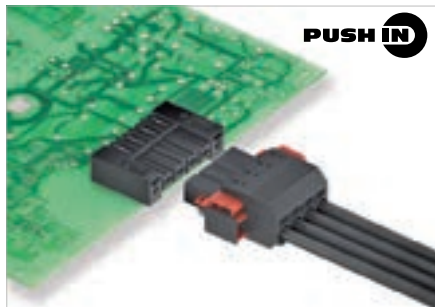

Male plug in 180° outlet direction and PUSH IN spring connection for TNC(S) networks. Also perfect for finger-safe solutions involving inverse voltages for board-to-wire connections. Meets the requirements of UL1059 for 600 V Use Group C. The mating profile ensures touch-safety of > 3 mm in accordance with IEC 61800-5-1.

Maximum operational reliability with a derating up to 125°C, a mating profile that can only be plugged in correct, and unique coding capability.

- Available with a flange (FI) and a screw flange (SFI).

Technical data

In compliance with IEC 60664-1 / IEC 61984			
Clamping range, max.	mm ²	0.5...10	
Solid core H05(07) V-U	mm²	0.5...6	
Stranded H07 V-R		...10	
Flexible H05(07) V-K	mm ²	0.5...10	
Flexible with ferrule	mm ²	1.5...6	
Ferrule with plastic collar	mm ²	1.5...6	
Stripping length	mm	12	
Screwdriver blade	mm	0.6 x 3.5	
According to norm			
Tightening torque range			
Rated current, max.	A	57	57
At ambient temperature		20°C	40°C
For conductor cross-section	mm ²	6	
Overvoltage category		III	III II
Pollution severity		3	2 2
Rated voltage	V	800	800 1000
Rated impulse voltage	kV	8	8 6
UL / CUL (Use Group)		B	C D
Rated voltage	V	600	600 600
Rated current	A	39	39 5
AWG conductor	AWG	24-10	
CSA (Use Group)		B	C D
Rated voltage	V	600	600 600
Rated current	A	36	36 5
AWG conductor	AWG	24-10	
General data			
Type of insulation material		PA GF	
UL 94 flammability rating		V-0	
Contact base material		Copper alloy	
Material of contact surface		tinned	
Pin dimensions = d	mm		
Solder eyelet Ø = D	mm		
Solder eyelet Ø tolerance	mm		

Product data

IEC: 1000 V / 57 A / 0.5 - 10 mm²
 UL: 600 V / 39 A / AWG 24 - 10



For additional articles and information, refer to catalog.weidmueller.com

Note:

- Additional variants on request
- Rated current related to rated cross-section & min. No. of poles.
- Wire end ferrule without plastic collar to DIN 46228/1
- Wire end ferrule with plastic collar to DIN 46228/4
- P on drawing = pitch
- Rated data refer only to the component itself. Clearance and creepage distances to other components are to be designed in accordance with the relevant application standards.
- Long term storage of the product with average temperature of 50 °C and average humidity 70%, 36 months

SVF 7.62HP../180FI



Dimensioned drawing

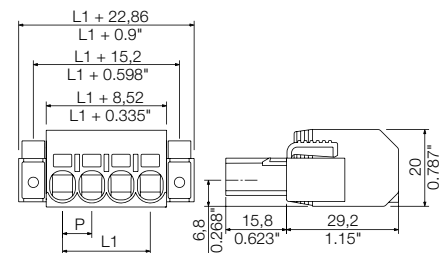

Accessories

Note: Refer to the Accessories chapter for additional accessories.

Coding		Order No.
	BV/SV 7.62HP K0	1937590000
Screwdriver		
	SDS 0.8X4.5X125	2749370000
Pressing tool		
	PZ 6/5	9011460000

Ordering data

Solder pin length				
Colour	black			
Pitch	7.62 mm			
Pol.	L1	(inch)	Qty.	Order No.
2	7.62	0.300	50	1124750000
3	15.24	0.600	40	1124760000
4	22.86	0.900	30	1124770000
5	30.48	1.200	25	1124780000

Representative deratings curve

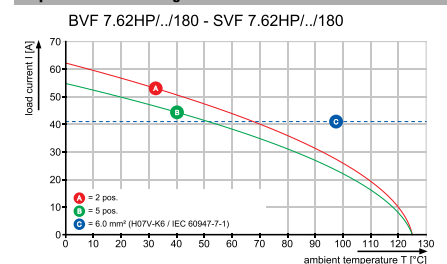

SVF 7.62HP../180SFI



Dimensioned drawing

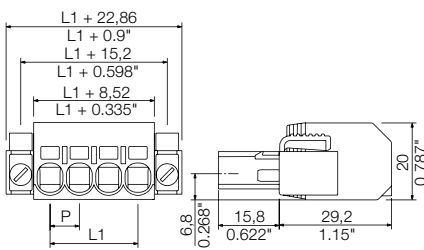

Ordering data

Solder pin length					
Colour					black
Pitch		7.62 mm			
Pol.	L1	(inch)	Qty.	Order No.	
2	7.62	0.300	50	1124810000	
3	15.24	0.600	40	1124820000	
4	22.86	0.900	30	1124830000	
5	30.48	1.200	25	1124840000	

Connectors, pitch 7.62 mm
BV/SV 7.62 series - connection up to 6 mm²

SVF 7.62HP/./180MF



PUSH IN

Male plug in 180° outlet direction with PUSH IN spring connection for TNC(S) networks. Also perfect for finger-safe solutions involving inverse voltages. Meets the requirements of UL1059 for 600 V Use Group C. The mating profile ensures touch-safety of > 3 mm in accordance with IEC 61800-5-1.

Maximum operational reliability with a derating up to 125°C, a mating profile that can only be plugged in correct, and unique coding capability.

- Middle flange is available in positions 2, 3 and 4.

Technical data

In compliance with IEC 60664-1 / IEC 61984			
Clamping range, max.	mm ²	0.5...10	
Solid core H05(07) V-U	mm²	0.5...6	
Stranded H07 V-R		...10	
Flexible H05(07) V-K	mm ²	0.5...10	
Flexible with ferrule	mm ²	1.5...6	
Ferrule with plastic collar	mm ²	1.5...6	
Stripping length	mm	12	
Screwdriver blade	mm	0.6 x 3.5	
According to norm			
Tightening torque range			
Rated current, max.	A	57	57
At ambient temperature		20°C	40°C
For conductor cross-section	mm ²	6	
Overvoltage category		III	III II
Pollution severity		3	2 2
Rated voltage	V	800	800 1000
Rated impulse voltage	kV	8	8 6
UL / CUL (Use Group)		B	C D
Rated voltage	V	600	600 600
Rated current	A	39	39 5
AWG conductor	AWG	24-10	
CSA (Use Group)		B	C D
Rated voltage	V	600	600 600
Rated current	A	36	36 5
AWG conductor	AWG	24-10	
General data			
Type of insulation material		PA GF	
UL 94 flammability rating		V-0	
Contact base material		Copper alloy	
Material of contact surface		tinned	
Pin dimensions = d	mm		
Solder eyelet Ø = D	mm		
Solder eyelet Ø tolerance	mm		

Product data

IEC: 1000 V / 57 A / 0.5 - 10 mm²
 UL: 600 V / 39 A / AWG 24 - 10



For additional articles and information, refer to catalog.weidmueller.com

Note:

- Additional variants on request
- Rated current related to rated cross-section & min. No. of poles.
- Wire end ferrule without plastic collar to DIN 46228/1
- Wire end ferrule with plastic collar to DIN 46228/4
- P on drawing = pitch
- Rated data refer only to the component itself. Clearance and creepage distances to other components are to be designed in accordance with the relevant application standards.
- Long term storage of the product with average temperature of 50 °C and average humidity 70%, 36 months

SVF 7.62HP/./180MF2



Dimensioned drawing

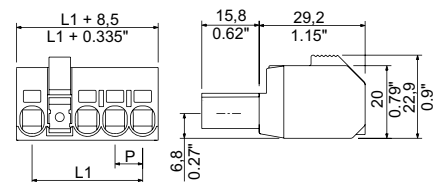

Accessories

Note: Refer to the Accessories chapter for additional accessories.

Coding		Order No.
	BV/SV 7.62HP K0	1937590000
Screwdriver		
	SDS 0.8X4.5X125	2749370000
Pressing tool		
	PZ 6/5	9011460000

Ordering data

Solder pin length				
Colour	black			
Pitch 7.62 mm				
Pol.	L1	(inch)	Qty.	Order No.
2	15.24	0.600	65	1061020000
3	22.86	0.900	50	1061030000
4	30.48	1.200	40	1430010000
5	38.10	1.500	30	1430020000

Representative deratings curve

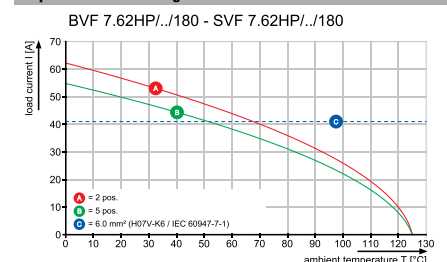

SVF 7.62HP../180MF3



Dimensioned drawing

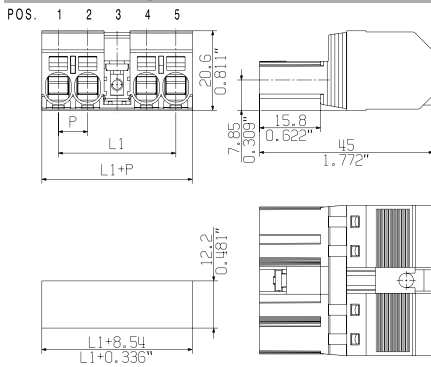

Ordering data

Solder pin length					
Colour					black
Pitch 7.62 mm					
Pol.	L1	(inch)	Qty.	Order No.	
3	22.86	0.900	50	1061040000	
4	30.48	1.200	40	1061050000	
5	38.10	1.500	30	1061070000	

SVF 7.62HP../180MF4



Dimensioned drawing

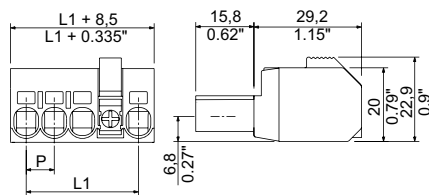

Ordering data

Solder pin length					
Colour					black
Pitch 7.62 mm					
Pol.	L1	(inch)	Qty.	Order No.	
4	30.48	1.200	40	1430030000	
5	38.10	1.500	30	1061080000	
6	45.72	1.800	25	1061100000	

Connectors, pitch 7.62 mm
BV/SV 7.62 series - connection up to 6 mm²

SVF 7.62HP/./180MSF



PUSH IN

Male plug in 180° outlet direction with PUSH IN spring connection for TNC(S) networks. Also perfect for finger-safe solutions involving inverse voltages. Meets the requirements of UL1059 for 600 V Use Group C. The mating profile ensures touch-safety of > 3 mm in accordance with IEC 61800-5-1.

Maximum operational reliability: with a derating up to 125°C, a mating profile that can only be plugged in correct, and unique coding capability.

- Middle flange is available in positions 2, 3 and 4.

Technical data

In compliance with IEC 60664-1 / IEC 61984			
Clamping range, max.	mm ²	0.5...10	
Solid core H05(07) V-U	mm²	0.5...6	
Stranded H07 V-R		...10	
Flexible H05(07) V-K	mm ²	0.5...10	
Flexible with ferrule	mm ²	1.5...6	
Ferrule with plastic collar	mm ²	1.5...6	
Stripping length	mm	12	
Screwdriver blade	mm	0.6 x 3.5	
According to norm			
Tightening torque range			
Rated current, max.	A	57	57
At ambient temperature		20°C	40°C
For conductor cross-section	mm ²	6	
Overvoltage category		III	III II
Pollution severity		3	2 2
Rated voltage	V	800	800 1000
Rated impulse voltage	kV	8	8 6
UL / CUL (Use Group)	B C D		
Rated voltage	V	600	600 600
Rated current	A	39	39 5
AWG conductor	AWG	24-10	
CSA (Use Group)	B C D		
Rated voltage	V	600	600 600
Rated current	A	36	36 5
AWG conductor	AWG	24-10	
General data			
Type of insulation material		PA GF	
UL 94 flammability rating		V-0	
Contact base material		Copper alloy	
Material of contact surface		tinned	
Pin dimensions = d	mm		
Solder eyelet Ø = D	mm		
Solder eyelet Ø tolerance	mm		

Product data

IEC: 1000 V / 57 A / 0.5 - 10 mm²
 UL: 600 V / 39 A / AWG 24 - 10



For additional articles and information, refer to catalog.weidmueller.com

Note:

- Additional variants on request
- Rated current related to rated cross-section & min. No. of poles.
- Wire end ferrule without plastic collar to DIN 46228/1
- Wire end ferrule with plastic collar to DIN 46228/4
- P on drawing = pitch
- Rated data refer only to the component itself. Clearance and creepage distances to other components are to be designed in accordance with the relevant application standards.
- Long term storage of the product with average temperature of 50 °C and average humidity 70%, 36 months

SVF 7.62HP/./180MSF2



Dimensioned drawing

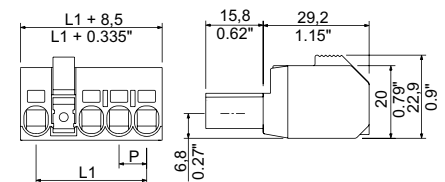

Accessories

Note: Refer to the Accessories chapter for additional accessories.

Coding		Order No.
	BV/SV 7.62HP K0	1937590000
Screwdriver		
	SDS 0.6X3.5X100	2749340000
	SDIS 0.6X3.5X100	2749810000
Pressing tool		
	PZ 6/5	9011460000

Ordering data

Solder pin length				
Colour	black			
Pitch	7.62 mm			
Pol.	L1	(inch)	Qty.	Order No.
2	15.24	0.600	65	1061110000
3	22.86	0.900	50	1061120000
4	30.48	1.200	40	1430060000
5	38.10	1.500	30	1430070000

Representative deratings curve

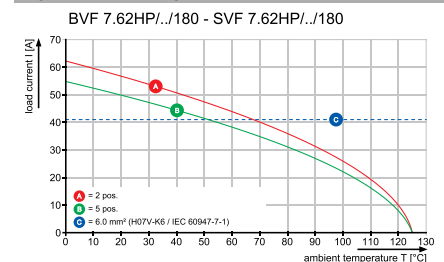

SVF 7.62HP../180MSF3



Dimensioned drawing

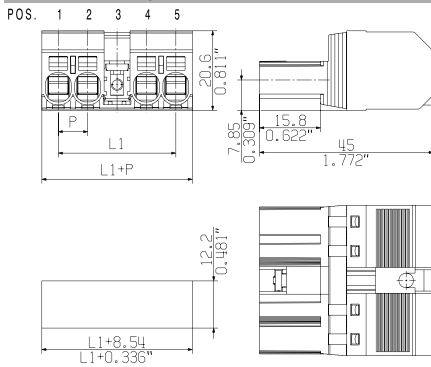

Ordering data

Solder pin length					
Colour					black
Pitch 7.62 mm					
Pol.	L1	(inch)	Qty.	Order No.	
3	22.86	0.900	50	1061130000	
4	30.48	1.200	40	1061140000	
5	38.10	1.500	30	1061150000	

SVF 7.62HP../180MSF4



Dimensioned drawing

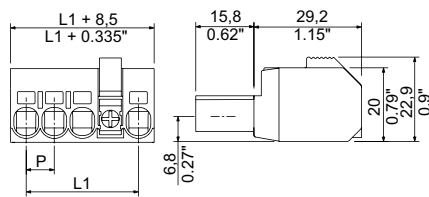

Ordering data

Solder pin length					
Colour					black
Pitch 7.62 mm					
Pol.	L1	(inch)	Qty.	Order No.	
4	30.48	1.200	40	1430080000	
5	38.10	1.500	30	1061170000	
6	45.72	1.800	25	1061180000	

Connectors, pitch 7.62 mm
BV/SV 7.62 series - connection up to 6 mm²

SVF 7.62HP../180

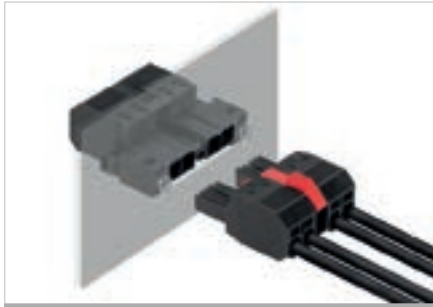

180° inverted male header featuring PUSH IN connection technology for field wiring in 6 mm² with a 7.62 pitch as a "three-flange variant" for enclosure feed-throughs. Suitable for enclosures with a max. wall thickness of 2 mm. Also a perfect finger-safe solution for reverse voltages. Meets the requirements of UL1059 600 V Class C and IEC 61800-5-1.

Technical data

In compliance with IEC 60664-1 / IEC 61984			
Clamping range, max.	mm ²	0.5...10	
Solid core H05(07) V-U	mm²	0.5...6	
Stranded H07 V-R		...10	
Flexible H05(07) V-K	mm ²	0.5...10	
Flexible with ferrule	mm ²	1.5...6	
Ferrule with plastic collar	mm ²	1.5...6	
Stripping length	mm	12	
Screwdriver blade	mm	0.6 x 3.5	
According to norm			
Tightening torque range			
Rated current, max.	A	57	57
At ambient temperature	20°C	40°C	
For conductor cross-section			
Overvoltage category		III	III II
Pollution severity		3	2 2
Rated voltage	V	800	800 1000
Rated impulse voltage	kV	8	8 6
UL / CUL (Use Group)		B	C D
Rated voltage	V	600	600 600
Rated current	A	39	39 5
AWG conductor	AWG	24-10	
CSA (Use Group)		B	C D
Rated voltage	V	600	600 600
Rated current	A	36	36 5
AWG conductor	AWG	24-10	
General data			
Type of insulation material		PA GF	
UL 94 flammability rating		V-0	
Contact base material		Copper alloy	
Material of contact surface		tinned	
Pin dimensions = d	mm		
Solder eyelet Ø = D	mm		
Solder eyelet Ø tolerance	mm		

Product data

IEC: 1000 V / 57 A / 0.5 - 10 mm²
 UL: 600 V / 39 A / AWG 24 - 10



For additional articles and information, refer to catalog.weidmueller.com

Note:

- Additional variants on request
- Rated current related to rated cross-section & min. No. of poles.
- Wire end ferrule without plastic collar to DIN 46228/1
- Wire end ferrule with plastic collar to DIN 46228/4
- P on drawing = pitch
- Rated data refer only to the component itself. Clearance and creepage distances to other components are to be designed in accordance with the relevant application standards.
- Long term storage of the product with average temperature of 50 °C and average humidity 70%, 36 months

SVF 7.62HP../180SFMF2



Dimensioned drawing

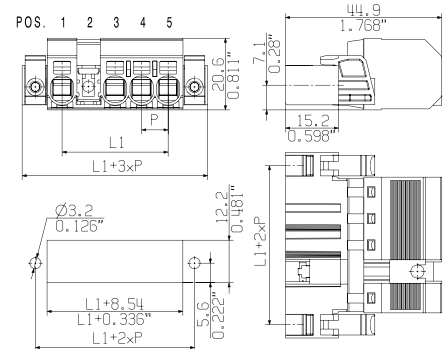

Accessories

Note: Refer to the Accessories chapter for additional accessories.

Coding		Order No.
	BV/SV 7.62HP K0	1937590000
Screwdriver		
	SDS 0.8X4.5X125	2749370000
Pressing tool		
	PZ 6/5	9011460000
Coupling set		
	SVF/BVF 7.62HP COUPLE SET	1440850000

Ordering data

Solder pin length					
Colour					black
Pitch 7.62 mm					
Pol.	L1	(inch)	Qty.	Order No.	
2	15.24	0.600	40	1427220000	
3	22.86	0.900	30	1427230000	
4	30.48	1.200	25	1427250000	

Representative dimensional drawing

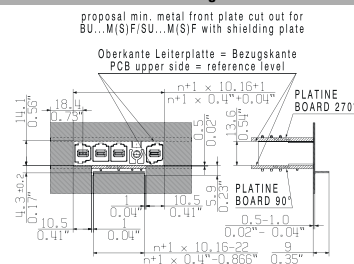

Representative deratings curve

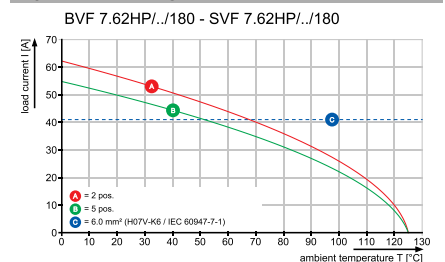

SVF 7.62HP../180SFMF3



Dimensioned drawing

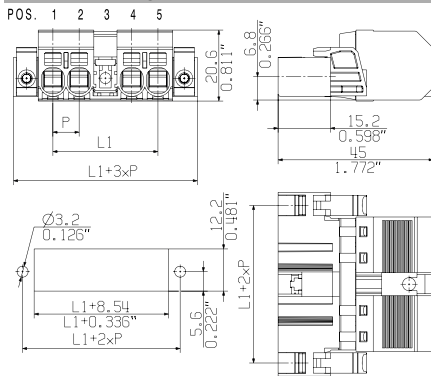

Ordering data

Solder pin length					
Colour					black
Pitch 7.62 mm					
Pol.	L1	(inch)	Qty.	Order No.	
3	22.86	0.900	30	1427240000	
4	30.48	1.200	25	1427260000	

SVF 7.62HP../180SFMF4



Dimensioned drawing

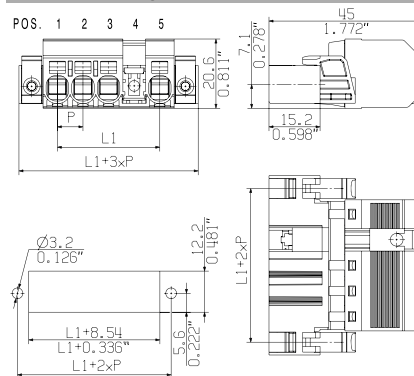

Ordering data

Solder pin length					
Colour					black
Pitch 7.62 mm					
Pol.	L1	(inch)	Qty.	Order No.	
4	30.48	1.200	25	1427270000	

SVF/BCF 7.62HP COUPLE SET

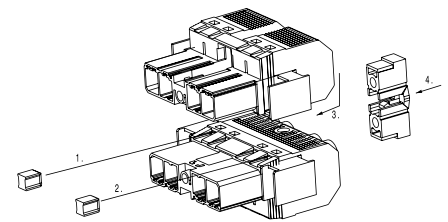

With the aid of the SVF/BVF 7.62HP COUPLE SET the two plug-in elements can be connected back-to-back to form a 2-row connector with a maximum of 2 x 4 poles.

Connectors, pitch 7.62 mm
BV/SV 7.62 series - connection up to 6 mm²

SVF 7.62HP../180

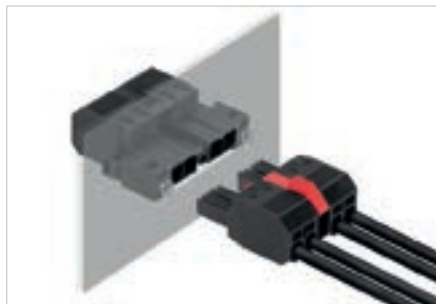

180° inverted male header featuring PUSH IN connection technology for field wiring in 6 mm² with a 7.62 pitch as a "three-flange variant" for enclosure feed-throughs. Suitable for enclosures with a max. wall thickness of 16 mm. Also a perfect finger-safe solution for reverse voltages. Meets the requirements of UL1059 600 V Class C and IEC 61800-5-1.

Technical data

In compliance with IEC 60664-1 / IEC 61984			
Clamping range, max.	mm ²	0.5...10	
Solid core H05(07) V-U	mm²	0.5...6	
Stranded H07 V-R		...10	
Flexible H05(07) V-K	mm ²	0.5...10	
Flexible with ferrule	mm ²	1.5...6	
Ferrule with plastic collar	mm ²	1.5...6	
Stripping length	mm	12	
Screwdriver blade	mm	0.6 x 3.5	
According to norm			
Tightening torque range			
Rated current, max.	A	57	57
At ambient temperature		20°C	40°C
For conductor cross-section			
Overvoltage category		III	III II
Pollution severity		3	2 2
Rated voltage	V	800	800 1000
Rated impulse voltage	kV	8	8 6
UL / CUL (Use Group)		B	C D
Rated voltage	V	600	600 600
Rated current	A	39	39 5
AWG conductor	AWG	24-10	
CSA (Use Group)		B	C D
Rated voltage	V	600	600 600
Rated current	A	36	36 5
AWG conductor	AWG	24-10	
General data			
Type of insulation material		PA GF	
UL 94 flammability rating		V-0	
Contact base material		Copper alloy	
Material of contact surface		tinned	
Pin dimensions = d	mm		
Solder eyelet Ø = D	mm		
Solder eyelet Ø tolerance	mm		

Product data

IEC: 1000 V / 57 A / 0.5 - 10 mm²
 UL: 600 V / 39 A / AWG 24 - 10



For additional articles and information, refer to catalog.weidmueller.com

Note:

- Additional variants on request
- Rated current related to rated cross-section & min. No. of poles.
- Wire end ferrule without plastic collar to DIN 46228/1
- Wire end ferrule with plastic collar to DIN 46228/4
- P on drawing = pitch
- Rated data refer only to the component itself. Clearance and creepage distances to other components are to be designed in accordance with the relevant application standards.
- Long term storage of the product with average temperature of 50 °C and average humidity 70%, 36 months

SVF 7.62HP../180SFBMF2



Dimensioned drawing

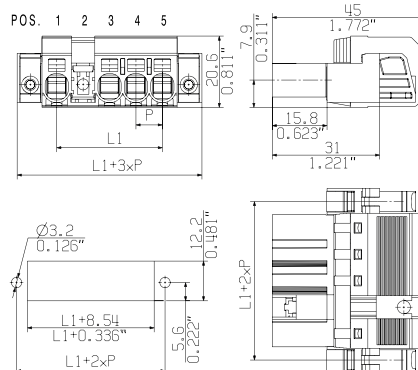

Ordering data

Solder pin length				
Colour	black			
Pitch	7.62 mm			
Pol.	L1	(inch)	Qty.	Order No.
2	15.24	0.600	40	1429920000
3	22.86	0.900	30	1429930000
4	30.48	1.200	25	1429950000

Accessories

Note: Refer to the Accessories chapter for additional accessories.		
Coding		Order No.
	BV/SV 7.62HP K0	1937590000
Screwdriver		
	SDS 0.8X4.5X125	2749370000
Pressing tool		
	PZ 6/5	9011460000
Coupling set		
	SVF/BVF 7.62HP COUPLE SET	1440850000

Representative deratings curve

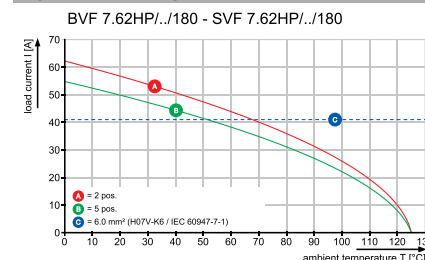

SVF 7.62HP../180SFBMF3



Dimensioned drawing

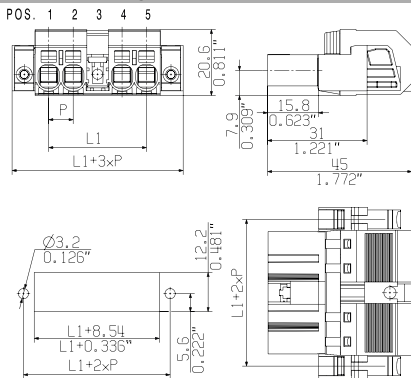

Ordering data

Solder pin length					
Colour					black
Pitch 7.62 mm					
Pol.	L1	(inch)	Qty.	Order No.	
3	22.86	0.900	30	1429940000	
4	30.48	1.200	25	1429960000	

SVF 7.62HP../180SFBMF4



Dimensioned drawing

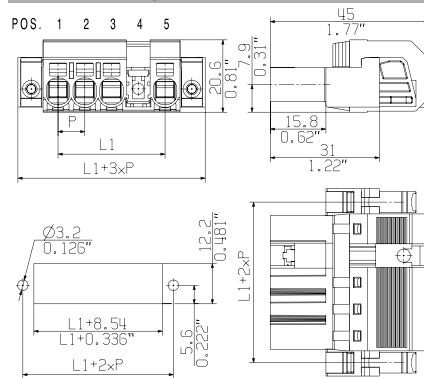

Ordering data

Solder pin length					
Colour					black
Pitch 7.62 mm					
Pol.	L1	(inch)	Qty.	Order No.	
4	30.48	1.200	25	1429970000	

SVF/BCF 7.62HP COUPLE SET

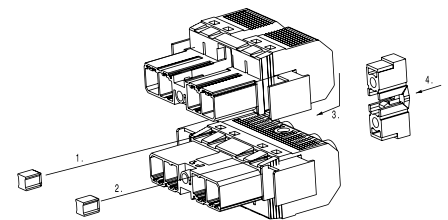

With the aid of the SVF/BVF 7.62HP COUPLE SET the two plug-in elements can be connected back-to-back to form a 2-row connector with a maximum of 2 x 4 poles.

Connectors, pitch 7.62 mm
BV/SV 7.62 series - connection up to 6 mm²

SVFL 7.62HP../180

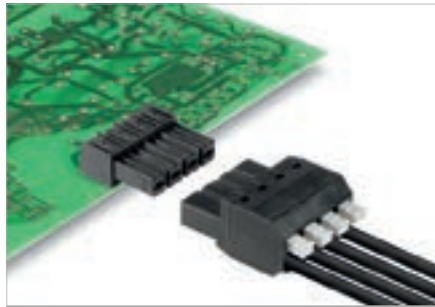

Male plug with 180° outlet direction and adjustable actuator (PUSHER) featuring PUSH IN spring connection technology for TNC(S) networks. Also perfect as a touch-safe solution for reverse voltages. Meets the requirements of UL1059 for 600 V Use Group C. The pin arrangement ensures finger-safety of >3 mm in accordance with IEC 61800-5-1.

Maximum connection and operating reliability due to: derating up to 125°C, a 100 % pin arrangement that prevents wrong connections or wrong wiring, and unique coding diversity.

Variants: middle flange and middle screw flange mountings.

Product data

IEC: 1000 V / 41 A / 0.5 - 6 mm²
 UL: 600 V / 36 A / AWG 24 - 10



For additional articles and information, refer to catalog.weidmueller.com

Note:

- Additional variants on request
- Rated current related to rated cross-section & min. No. of poles.
- Wire end ferrule with plastic collar to DIN 46228/4
- Wire end ferrule without plastic collar to DIN 46228/1
- P on drawing = pitch
- Rated data refer only to the component itself. Clearance and creepage distances to other components are to be designed in accordance with the relevant application standards.
- Additional pole combinations on request
- Long term storage of the product with average temperature of 50 °C and average humidity 70%, 36 months

SVFL 7.62HP../180G



Dimensioned drawing

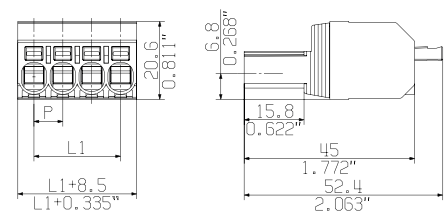

Technical data

In compliance with IEC 60664-1 / IEC 61984

Clamping range, max.	mm ²	0.5...6
Solid core H05(07) V-U	mm²	0.5...6
Stranded H07 V-R		
Flexible H05(07) V-K	mm ²	0.5...6
Flexible with ferrule	mm ²	1.5...6
Ferrule with plastic collar	mm ²	1.5...6
Stripping length	mm	12
Screwdriver blade	mm	0.6 x 3.5

According to norm

Tightening torque range			
Rated current, max.	A	41	41
At ambient temperature		20°C	40°C
For conductor cross-section			
Overvoltage category		III	III II
Pollution severity		3	2 2
Rated voltage	V	800	800 1000
Rated impulse voltage	kV	8	8 6

UL / CUL (Use Group)

Rated voltage	V	600	600	600
Rated current	A	36	36	5
AWG conductor	AWG	24-10		
CSA (Use Group)		B	C	D
Rated voltage	V	600	600	600
Rated current	A	35	35	5
AWG conductor	AWG	24-10		

General data

Type of insulation material		PA GF
UL 94 flammability rating		V-0
Contact base material		Copper alloy
Material of contact surface		tinned
Pin dimensions = d	mm	
Solder eyelet Ø = D	mm	
Solder eyelet Ø tolerance	mm	

Accessories

Note: Refer to the Accessories chapter for additional accessories.

Coding		Order No.
	BV/SV 7.62HP K0	1937590000
Screwdriver		
	SDS 0.8X4.5X125	2749370000
Pressing tool		
	PZ 6/5	9011460000

Ordering data

Solder pin length				
Colour	black			
Pitch	7.62 mm			
Pol.	L1	(inch)	Qty.	Order No.
4	22.86	0.900	36	1547550000

Additional pole combinations on request

Representative deratings curve

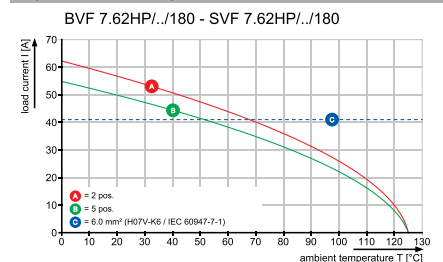

Additional pole combinations on request

SVFL 7.62HP/./180F



Dimensioned drawing

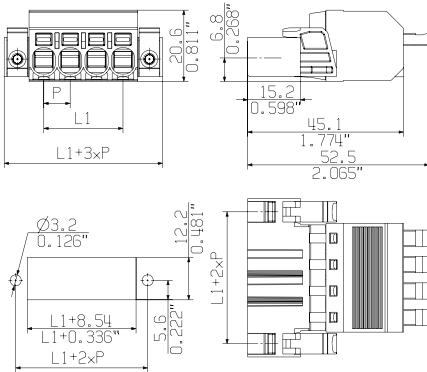

Ordering data

Solder pin length			
Colour		black	
Pitch		7.62 mm	
Pol.	L1	(inch)	Qty. Order No.
4	22.86	0.900	42 1547570000

Additional pole combinations on request

Connectors, pitch 7.62 mm
BV/SV 7.62 series - connection up to 6 mm²

SVFL 7.62HP../180MF

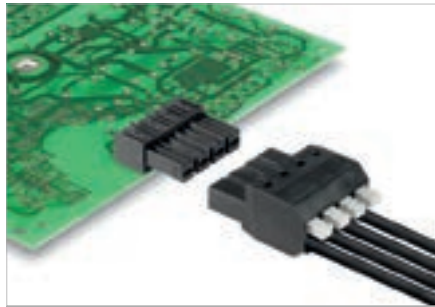

Male plug with 180° outlet direction and adjustable actuator (PUSHER) featuring PUSH IN spring connection technology for TNC(S) networks. Also perfect as a touch-safe solution for reverse voltages. Meets the requirements of UL1059 for 600 V Use Group C. The pin arrangement ensures finger-safety of >3 mm in accordance with IEC 61800-5-1.

Maximum connection and operating reliability due to: derating up to 125°C, a 100 % pin arrangement that prevents wrong connections or wrong wiring, and unique coding diversity.

Variants: middle flange and middle screw flange mountings.

Product data

IEC: 1000 V / 41 A / 0.5 - 6 mm²
 UL: 600 V / 36 A / AWG 24 - 10



For additional articles and information, refer to catalog.weidmueller.com

Note:

- Additional variants on request
- Rated current related to rated cross-section & min. No. of poles.
- Wire end ferrule with plastic collar to DIN 46228/4
- Wire end ferrule without plastic collar to DIN 46228/1
- P on drawing = pitch
- Rated data refer only to the component itself. Clearance and creepage distances to other components are to be designed in accordance with the relevant application standards.
- Additional pole combinations on request
- Long term storage of the product with average temperature of 50 °C and average humidity 70%, 36 months

SVFL 7.62HP../180MF2



Dimensioned drawing

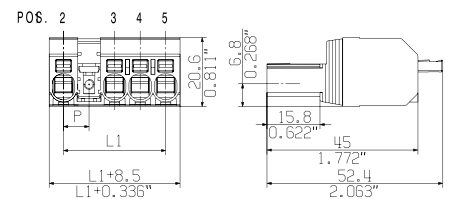

Technical data

In compliance with IEC 60664-1 / IEC 61984

Clamping range, max.	mm ²	0.5...6
Solid core H05(07) V-U	mm²	0.5...6
Stranded H07 V-R		
Flexible H05(07) V-K	mm ²	0.5...6
Flexible with ferrule	mm ²	1.5...6
Ferrule with plastic collar	mm ²	1.5...6
Stripping length	mm	12
Screwdriver blade	mm	0.6 x 3.5

According to norm

Tightening torque range			
Rated current, max.	A	41	41
At ambient temperature	20°C		40°C

For conductor cross-section			
Overvoltage category		III	III
Pollution severity		3	2
		2	2

Rated voltage	V	800	800	1000
Rated impulse voltage	kV	8	8	6

UL / CUL (Use Group)

Rated voltage	V	600	600	600
Rated current	A	36	36	5
AWG conductor	AWG	24-10		

CSA (Use Group)



Rated voltage	V	600	600	600
Rated current	A	35	35	5
AWG conductor	AWG	24-10		

General data

Type of insulation material		PA GF
UL 94 flammability rating		V-0
Contact base material		Copper alloy
Material of contact surface		tinned
Pin dimensions = d	mm	
Solder eyelet Ø = D	mm	
Solder eyelet Ø tolerance	mm	

Accessories

Note: Refer to the Accessories chapter for additional accessories.

Coding		Order No.
	BV/SV 7.62HP K0	1937590000
Screwdriver		
	SDS 0.8X4.5X125	2749370000
Pressing tool		
	PZ 6/5	9011460000

Ordering data

Solder pin length				
Colour	black			
Pitch	7.62 mm			
Pol.	L1	(inch)	Qty.	Order No.
2	15.24	0.600	84	2630260000
3	22.86	0.900	60	2630420000
4	30.48	1.200	48	2630430000
5	38.10	1.500	42	2630440000

Representative deratings curve

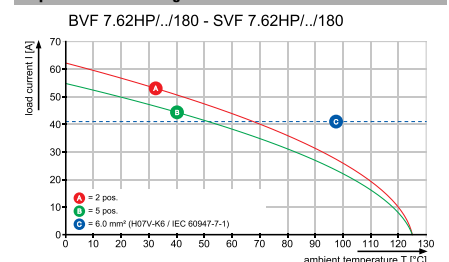

SVFL 7.62HP../180MF3



Dimensioned drawing

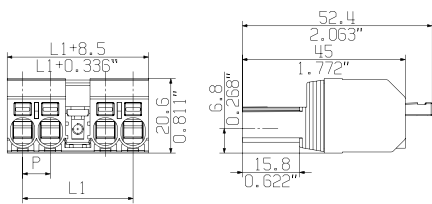

SVFL 7.62HP../180MF4



Dimensioned drawing

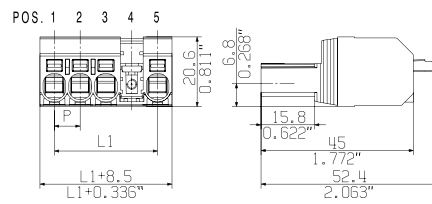

Ordering data

Solder pin length					
Colour					black
Pitch 7.62 mm					
Pol.	L1	(inch)	Qty.	Order No.	
3	22.86	0.900	60	2630450000	
4	30.48	1.200	48	1547580000	
5	38.10	1.500	42	2630460000	

Ordering data

Solder pin length					
Colour					black
Pitch 7.62 mm					
Pol.	L1	(inch)	Qty.	Order No.	
4	30.48	1.200	48	2630470000	
5	38.10	1.500	42	2630480000	

Connectors, pitch 7.62 mm
BV/SV 7.62 series - connection up to 6 mm²

BVZ 7.62HP/./180



Female plug in 180° outlet direction with clamping yoke screw connection for TNC (S) systems. Meets the requirements of UL1059 for 600 V Use Group C. The mating profile ensures touch-safety of > 3 mm in accordance with IEC 61800-5-1.

Maximum operational reliability: with a derating up to 125°C, a mating profile that can only be plugged in correct, and unique coding capability.

- Available with a flange (F), screw flange (SF) and clip on screw flange (SFC)

Product data

IEC: 1000 V / 57 A / 0.2 - 10 mm²
 UL: 600 V / 40.5 A / AWG 24 - 8



For additional articles and information, refer to catalog.weidmueller.com

Note:

- Additional variants on request
- Rated current related to rated cross-section & min. No. of poles.
- Wire end ferrule with plastic collar to DIN 46228/4
- Wire end ferrule without plastic collar to DIN 46228/1
- P on drawing = pitch
- Rated data refer only to the component itself. Clearance and creepage distances to other components are to be designed in accordance with the relevant application standards.
- Long term storage of the product with average temperature of 50 °C and average humidity 70%, 36 months

BVZ 7.62HP/./180



Dimensioned drawing

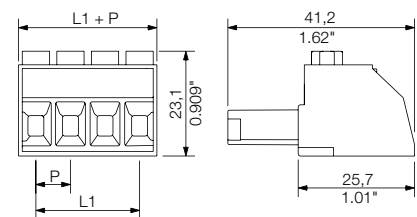

Technical data

In compliance with IEC 60664-1 / IEC 61984			
Clamping range, max.	mm ²	0.2...10	
Solid core H05(07) V-U	mm²	0.2...6	
Stranded H07 V-R			
Flexible H05(07) V-K	mm ²	0.2...10	
Flexible with ferrule	mm ²	0.5...6	
Ferrule with plastic collar	mm ²	0.2...6	
Stripping length	mm	12	
Screwdriver blade	mm	0.6 x 3.5	
According to norm			
Tightening torque range	Nm	0.5...0.6	
Rated current, max.	A	57	51
At ambient temperature		20°C	40°C
For conductor cross-section	mm ²	6	
Overvoltage category		III	III II
Pollution severity		3	2 2
Rated voltage	V	800	1000 1000
Rated impulse voltage	V	8	1000 1000
UL / CUL (Use Group)	B C D		
Rated voltage	V	600	600 600
Rated current	A	40.5	40.5 5
AWG conductor	AWG	24-8	
CSA (Use Group)	B C D		
Rated voltage	V	600	600 600
Rated current	A	40.5	40.5 5
AWG conductor	AWG	24-8	
General data			
Type of insulation material		PA GF	
UL 94 flammability rating		V-0	
Contact base material		Copper alloy	
Material of contact surface		tinned	
Pin dimensions = d	mm		
Solder eyelet Ø = D	mm		
Solder eyelet Ø tolerance	mm		

Accessories

Note: Refer to the Accessories chapter for additional accessories.

Coding		Order No.
	BV/SV 7.62HP K0	1937590000
Strain relief		
	BV/SV 7.62HP/02 ZE GR	1937550000
	BV/SV 7.62HP/04 ZE GR	1937560000
Screwdriver		
	SDS 0.8X4.5X125	2749370000
	SDK PH1 X 80	2749410000

Ordering data

Solder pin length				
Colour	black			
Pitch	7.62 mm			
Pol.	L1	(inch)	Qty.	Order No.
2	7.62	0.300	100	1929930000
3	15.24	0.600	100	1929940000
4	22.86	0.900	100	1929950000
5	30.48	1.200	50	1929960000
6	38.10	1.500	50	1929970000
7	45.72	1.800	50	1929980000
8	53.34	2.100	50	1929990000
9	60.96	2.400	50	1930000000
10	68.58	2.700	50	1930020000
11	76.20	3.000	50	1930030000
12	83.82	3.300	50	1930040000

Representative deratings curve

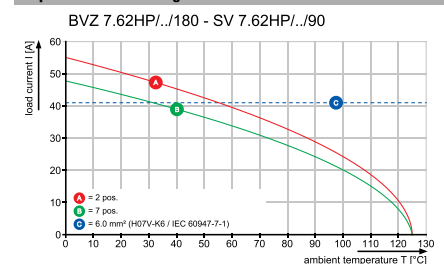

BVZ 7.62HP../180F



Dimensioned drawing

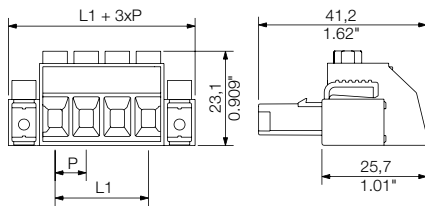

Ordering data

Solder pin length					
Colour					black
Pitch 7.62 mm					
Pol.	L1	(inch)	Qty.	Order No.	
2	7.62	0.300	100	1930050000	
3	15.24	0.600	100	1930060000	
4	22.86	0.900	100	1930070000	
5	30.48	1.200	50	1930080000	
6	38.10	1.500	50	1930090000	
7	45.72	1.800	50	1930100000	
8	53.34	2.100	50	1930110000	
9	60.96	2.400	50	1930120000	
10	68.58	2.700	50	1930130000	
11	76.20	3.000	50	1930140000	
12	83.82	3.300	50	1930150000	

BVZ 7.62HP../180SF



Dimensioned drawing

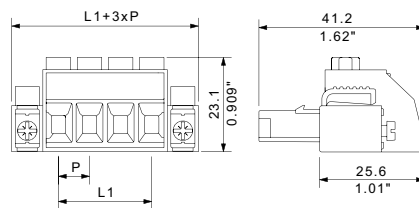

Ordering data

Solder pin length					
Colour					black
Pitch 7.62 mm					
Pol.	L1	(inch)	Qty.	Order No.	
2	7.62	0.300	100	1930160000	
3	15.24	0.600	100	1930170000	
4	22.86	0.900	100	1930180000	
5	30.48	1.200	50	1930190000	
6	38.10	1.500	50	1930200000	
7	45.72	1.800	50	1930210000	
8	53.34	2.100	50	1930220000	
9	60.96	2.400	50	1930230000	
10	68.58	2.700	50	1930240000	
11	76.20	3.000	50	1930250000	
12	83.82	3.300	50	1930260000	

BVZ 7.62HP../180SFC



Dimensioned drawing

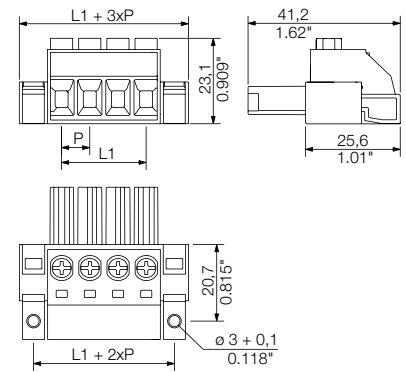

Ordering data

Solder pin length					
Colour					black
Pitch 7.62 mm					
Pol.	L1	(inch)	Qty.	Order No.	
2	7.62	0.300	100	1929740000	
3	15.24	0.600	100	1929750000	
4	22.86	0.900	100	1929760000	
5	30.48	1.200	50	1929770000	
6	38.10	1.500	50	1929780000	
7	45.72	1.800	50	1929790000	

Also available with a clip-on flange (-180FC).

Additional deratings curves

BVZ 7.62HP../180 - SV 7.62HP../180

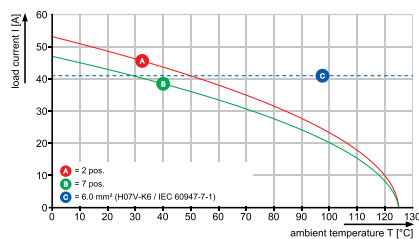

BVZ 7.62HP../180 - SVZ 7.62HP../180

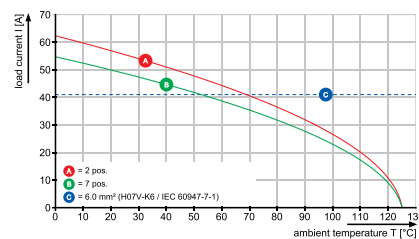

Connectors, pitch 7.62 mm
BV/SV 7.62 series - connection up to 6 mm²

BVZ 7.62HP../180RSH



Female plug in 180° outlet direction with clamping yoke screw connection and additional shield connection for TNC (S) systems. Meets the requirements of UL1059 for 600 V Use Group C. The mating profile ensures touch-safety of > 3 mm in accordance with IEC 61800-5-1.

Maximum operational reliability with a derating up to 125°C, a mating profile that can only be plugged in correct, and unique coding capability.

- Available with shield in three different orientations.

Technical data

In compliance with IEC 60664-1 / IEC 61984			
Clamping range, max.	mm ²	0.2...10	
Solid core H05(07) V-U	mm²	0.2...6	
Stranded H07 V-R			
Flexible H05(07) V-K	mm ²	0.2...10	
Flexible with ferrule	mm ²	0.5...6	
Ferrule with plastic collar	mm ²	0.2...6	
Stripping length	mm	12	
Screwdriver blade	mm	0.6 x 3.5	
According to norm			
Tightening torque range	Nm	0.5...0.6	
Rated current, max.	A	57 51	
At ambient temperature		20°C 40°C	
For conductor cross-section	mm ²	6	
Overtoltage category		III III II	
Pollution severity		3 2 2	
Rated voltage	V	800 1000 1000	
Rated impulse voltage	V	8 1000 1000	
UL / CUL (Use Group)	B C D		
Rated voltage	V	600 600 600	
Rated current	A	40.5 40.5 5	
AWG conductor	AWG	24-8	
CSA (Use Group)	B C D		
Rated voltage	V	600 600 600	
Rated current	A	40.5 40.5 5	
AWG conductor	AWG	24-8	
General data			
Type of insulation material		PA GF	
UL 94 flammability rating		V-0	
Contact base material		Copper alloy	
Material of contact surface		tinned	
Pin dimensions = d	mm		
Solder eyelet Ø = D			
Solder eyelet Ø tolerance	mm		

Product data

IEC: 1000 V / 57 A / 0.2 - 10 mm²
 UL: 600 V / 40.5 A / AWG 24 - 8



For additional articles and information, refer to catalog.weidmuller.com

Note:

- Additional variants on request
- Rated current related to rated cross-section & min. No. of poles.
- Wire end ferrule with plastic collar to DIN 46228/4
- Wire end ferrule without plastic collar to DIN 46228/1
- P on drawing = pitch
- Rated data refer only to the component itself. Clearance and creepage distances to other components are to be designed in accordance with the relevant application standards.
- Long term storage of the product with average temperature of 50 °C and average humidity 70%, 36 months

BVZ 7.62HP../180RSH150



Dimensioned drawing

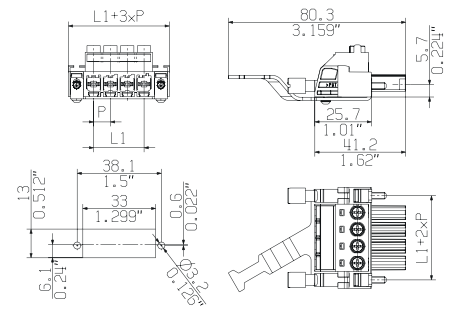

FRONT PLATE CUT-OUT

Accessories

Note: Refer to the Accessories chapter for additional accessories.

Coding		Order No.
	BV/SV 7.62HP K0	1937590000
Screwdriver		
	SDS 0.8X4.5X125	2749370000
	SDK PH1 X 80	2749410000

Ordering data

Solder pin length					
Colour	black				
Pitch	7.62 mm				
Pol.	L1	(inch)	Qty.	Order No.	
3	15.24	0.600	50	1929850000	
4	22.86	0.900	25	1929860000	
5	30.48	1.200	25	1929870000	
6	38.10	1.500	25	1929880000	

Representative deratings curve

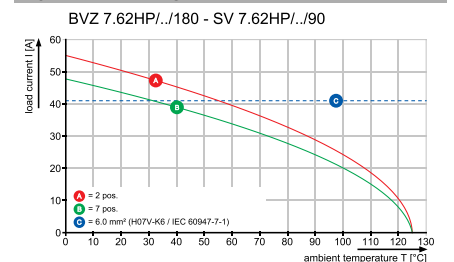

BVZ 7.62HP../180RSH180



Dimensioned drawing

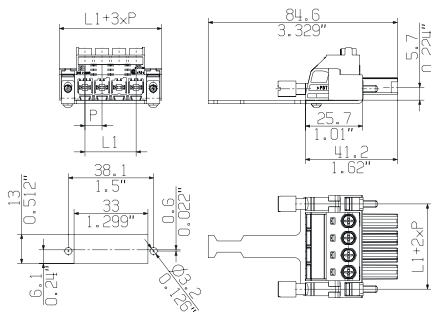

Ordering data

Solder pin length					
Colour					black
Pitch 7.62 mm					
Pol.	L1	(inch)	Qty.	Order No.	
3	15.24	0.600	50	1933340000	
4	22.86	0.900	25	1933350000	
5	30.48	1.200	25	1933360000	
6	38.10	1.500	25	1933370000	

BVZ 7.62HP../180RSH210



Dimensioned drawing

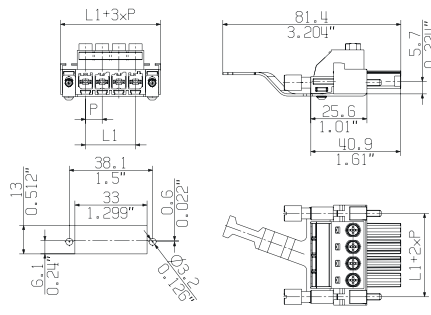

Ordering data

Solder pin length					
Colour					black
Pitch 7.62 mm					
Pol.	L1	(inch)	Qty.	Order No.	
3	15.24	0.600	50	1933430000	
4	22.86	0.900	25	1933440000	
5	30.48	1.200	25	1933450000	
6	38.10	1.500	25	1933460000	

Additional deratings curves

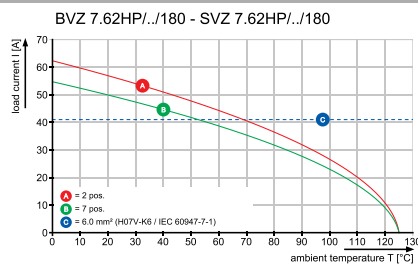
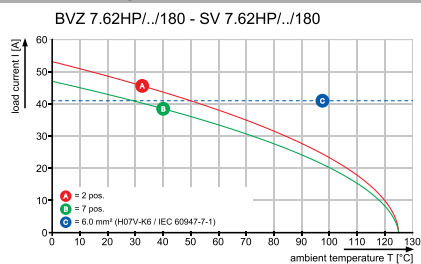

Connectors, pitch 7.62 mm
BV/SV 7.62 series - connection up to 6 mm²

BVZ 7.62HP../180SH C



Female plug in 180° outlet direction with clamping yoke screw connection and additional shield connection for TNC (S) systems. Meets the requirements of UL1059 for 600 V Use Group C. The mating profile ensures touch-safety of > 3 mm in accordance with IEC 61800-5-1.

Maximum operational reliability with a derating up to 125°C, a mating profile that can only be plugged in correct, and unique coding capability.

- Available with shield in three different orientations.

Technical data

In compliance with IEC 60664-1 / IEC 61984			
Clamping range, max.	mm ²	0.2...10	
Solid core H05(07) V-U	mm²	0.2...6	
Stranded H07 V-R			
Flexible H05(07) V-K	mm ²	0.2...10	
Flexible with ferrule	mm ²	0.5...6	
Ferrule with plastic collar	mm ²	0.2...6	
Stripping length	mm	12	
Screwdriver blade	mm	0.6 x 3.5	
According to norm			
Tightening torque range	Nm	0.5...0.6	
Rated current, max.	A	57	51
At ambient temperature		20°C	40°C
For conductor cross-section	mm ²	6	
Overtoltage category		III	III II
Pollution severity		3	2 2
Rated voltage	V	800	1000 1000
Rated impulse voltage	V	8	1000 1000
UL / CUL (Use Group)	B C D		
Rated voltage	V	600	600 600
Rated current	A	40.5	40.5 5
AWG conductor	AWG	24-8	
CSA (Use Group)	B C D		
Rated voltage	V	600	600 600
Rated current	A	40.5	40.5 5
AWG conductor	AWG	24-8	
General data			
Type of insulation material		PA GF	
UL 94 flammability rating		V-0	
Contact base material		Copper alloy	
Material of contact surface		tinned	
Pin dimensions = d	mm		
Solder eyelet Ø = D	mm		
Solder eyelet Ø tolerance	mm		

Product data

IEC: 1000 V / 57 A / 0.2 - 10 mm²
 UL: 600 V / 40.5 A / AWG 24 - 8



For additional articles and information, refer to catalog.weidmuller.com

Note:

- Additional variants on request
- Rated current related to rated cross-section & min. No. of poles.
- Wire end ferrule with plastic collar to DIN 46228/4
- Wire end ferrule without plastic collar to DIN 46228/1
- P on drawing = pitch
- Rated data refer only to the component itself. Clearance and creepage distances to other components are to be designed in accordance with the relevant application standards.
- Long term storage of the product with average temperature of 50 °C and average humidity 70%, 36 months

BVZ 7.62HP../180SH150C



Dimensioned drawing

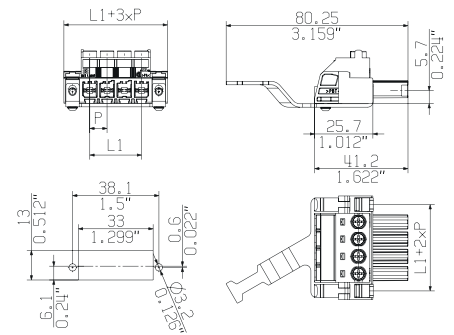

FRONT PLATE CUT-OUT

Accessories

Note: Refer to the Accessories chapter for additional accessories.

Coding		Order No.
	BV/SV 7.62HP KO	1937590000
Screwdriver		
	SDS 0.8X4.5X125	2749370000
	SDK PH1 X 80	2749410000

Ordering data

Solder pin length					
Colour	black				
Pitch	7.62 mm				
Pol.	L1	(inch)	Qty.	Order No.	
3	15.24	0.600	50	1929890000	
4	22.86	0.900	25	1929900000	
5	30.48	1.200	25	1929910000	
6	38.10	1.500	25	1929920000	

Representative deratings curve

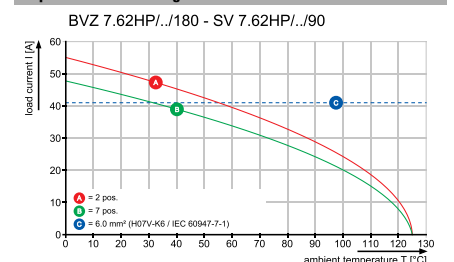

Connectors, pitch 7.62 mm
BV/SV 7.62 series - connection up to 6 mm²

BVF 7.62HP../180

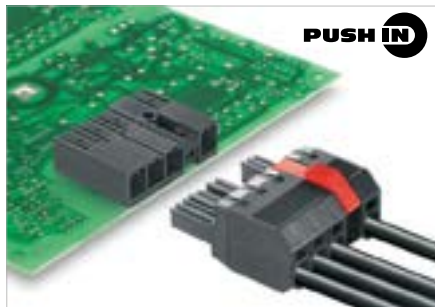

PUSH IN

Female plug in 180° outlet direction with PUSH IN spring connection for TNC (S) systems. Meets the requirements of UL1059 for 600 V Use Group C. The mating profile ensures touch-safety of > 3 mm in accordance with IEC 61800-5-1.

Maximum operational reliability with a derating up to 125°C, a mating profile that can only be plugged in correct, and unique coding capability.

- Available with a flange (F), screw flange (SF) and middle flange (MF).

Technical data

In compliance with IEC 60664-1 / IEC 61984			
Clamping range, max.	mm ²	0.5...10	
Solid core H05(07) V-U	mm²	0.5...10	
Stranded H07 V-R		...10	
Flexible H05(07) V-K	mm ²	0.5...10	
Flexible with ferrule	mm ²	0.5...10	
Ferrule with plastic collar	mm ²	0.5...6	
Stripping length	mm	12	
Screwdriver blade	mm	0.6 x 3.5	
According to norm			
Tightening torque range			
Rated current, max.	A	57	57
At ambient temperature		20°C	40°C
For conductor cross-section	mm ²	6	
Overvoltage category		III	III II
Pollution severity		3	2 2
Rated voltage	V	800	1000 1000
Rated impulse voltage	kV	8	8 6
UL / CUL (Use Group)		B	C D
Rated voltage	V	600	600 600
Rated current	A	39	39 5
AWG conductor	AWG	24-8	
CSA (Use Group)		B	C D
Rated voltage	V	600	600 600
Rated current	A	33	33 5
AWG conductor	AWG	24-8	
General data			
Type of insulation material		PA GF	
UL 94 flammability rating		V-0	
Contact base material		Copper alloy	
Material of contact surface		tinned	
Pin dimensions = d	mm		
Solder eyelet Ø = D	mm		
Solder eyelet Ø tolerance	mm		

Product data

IEC: 1000 V / 57 A / 0.5 - 10 mm²
 UL: 600 V / 39 A / AWG 24 - 8



For additional articles and information, refer to catalog.weidmueller.com

Note:

- Additional variants on request
- Wire end ferrule with plastic collar to DIN 46228/4
- Wire end ferrule without plastic collar to DIN 46228/1
- P on drawing = pitch
- Rated data refer only to the component itself. Clearance and creepage distances to other components are to be designed in accordance with the relevant application standards.
- Long term storage of the product with average temperature of 50 °C and average humidity 70%, 36 months

BVF 7.62HP../180



Dimensioned drawing

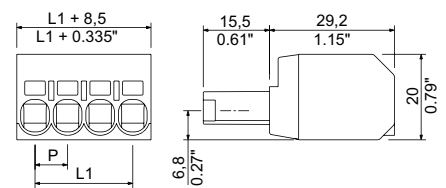

Accessories

Note: Refer to the Accessories chapter for additional accessories.

Coding		Order No.
	BV/SV 7.62HP K0	1937590000
Screwdriver		
	SDS 0.8X4.5X125	2749370000
Pressing tool		
	PZ 6/5	9011460000

Ordering data

Solder pin length				
Colour	black			
Pitch	7.62 mm			
Pol.	L1	(inch)	Qty.	Order No.
2	7.62	0.300	95	1060390000
3	15.24	0.600	65	1060400000
4	22.86	0.900	45	1060410000
5	30.48	1.200	40	1060420000

Representative deratings curve

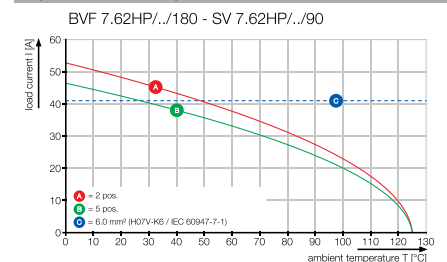

BVF 7.62HP../180F



Dimensioned drawing

BVF 7.62HP../180SF



Dimensioned drawing

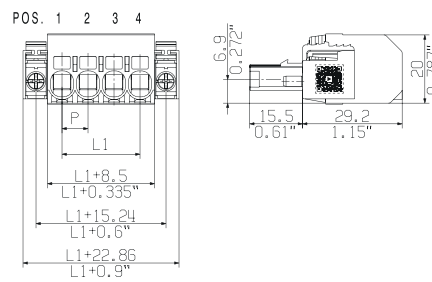
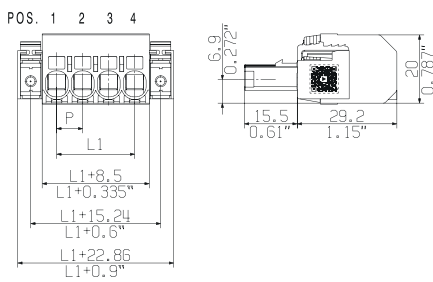

Ordering data

Solder pin length					
Colour					black
Pitch 7.62 mm					
Pol.	L1	(inch)	Qty.	Order No.	
2	7.62	0.300	50	1060440000	
3	15.24	0.600	40	1060450000	
4	22.86	0.900	30	1060470000	
5	30.48	1.200	25	1060480000	
6	38.10	1.500	25	1060490000	

Ordering data

Solder pin length					
Colour					black
Pitch 7.62 mm					
Pol.	L1	(inch)	Qty.	Order No.	
2	7.62	0.300	50	1060500000	
3	15.24	0.600	40	1060510000	
4	22.86	0.900	30	1060520000	
5	30.48	1.200	25	1060530000	
6	38.10	1.500	25	1060540000	

Additional deratings curves

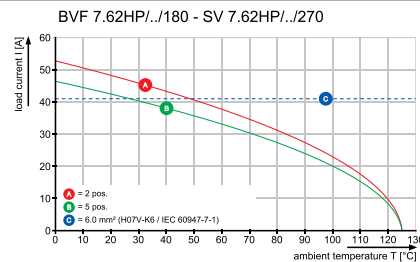
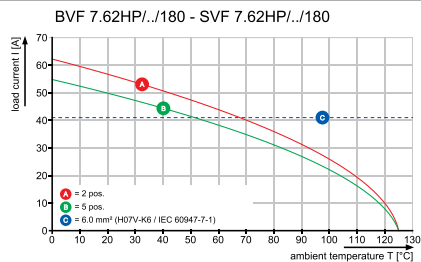

Connectors, pitch 7.62 mm
BV/SV 7.62 series - connection up to 6 mm²

BVF 7.62HP../180MF



PUSH IN

Female plug in 180° outlet direction with PUSH IN spring connection for TNC (S) systems. Meets the requirements of UL1059 for 600 V Use Group C. The mating profile ensures touch-safety of > 3 mm in accordance with IEC 61800-5-1.

Maximum operational reliability with a derating up to 125°C, a mating profile that can only be plugged in correct, and unique coding capability.

- Middle flange available in positions 2, 3 and 4.

Technical data

In compliance with IEC 60664-1 / IEC 61984			
Clamping range, max.	mm ²	0.5...10	
Solid core H05(07) V-U	mm²	0.5...10	
Stranded H07 V-R		...10	
Flexible H05(07) V-K	mm ²	0.5...10	
Flexible with ferrule	mm ²	0.5...10	
Ferrule with plastic collar	mm ²	0.5...6	
Stripping length	mm	12	
Screwdriver blade	mm	0.6 x 3.5	
According to norm			
Tightening torque range			
Rated current, max.	A	57	57
At ambient temperature		20°C	40°C
For conductor cross-section	mm ²	6	
Overvoltage category		III	III II
Pollution severity		3	2 2
Rated voltage	V	800	1000 1000
Rated impulse voltage	kV	8	8 6
UL / CUL (Use Group)		B	C D
Rated voltage	V	600	600 600
Rated current	A	39	39 5
AWG conductor	AWG	24-8	
CSA (Use Group)		B	C D
Rated voltage	V	600	600 600
Rated current	A	33	33 5
AWG conductor	AWG	24-8	
General data			
Type of insulation material		PA GF	
UL 94 flammability rating		V-0	
Contact base material		Copper alloy	
Material of contact surface		tinned	
Pin dimensions = d	mm		
Solder eyelet Ø = D	mm		
Solder eyelet Ø tolerance	mm		

Product data

IEC: 1000 V / 57 A / 0.5 - 10 mm²
 UL: 600 V / 39 A / AWG 24 - 8



For additional articles and information, refer to catalog.weidmuller.com

Note:

- Additional variants on request
- Wire end ferrule with plastic collar to DIN 46228/4
- Wire end ferrule without plastic collar to DIN 46228/1
- P on drawing = pitch
- Rated data refer only to the component itself. Clearance and creepage distances to other components are to be designed in accordance with the relevant application standards.
- Long term storage of the product with average temperature of 50 °C and average humidity 70%, 36 months

BVF 7.62HP../180MF2



Dimensioned drawing

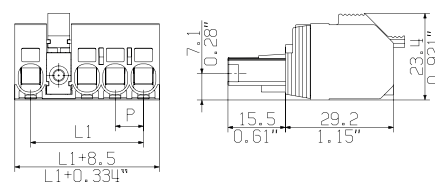

7.62

180°

6 mm²

Accessories

Note: Refer to the Accessories chapter for additional accessories.

Coding		Order No.
	BV/SV 7.62HP K0	1937590000
Screwdriver		
	SDS 0.8X4.5X125	2749370000
Pressing tool		
	PZ 6/5	9011460000
Coupling set		
	SVF/BVF 7.62HP COUPLE SET	1440850000

Ordering data

Solder pin length				
Colour	black			
Pitch	7.62 mm			
Pol.	L1	(inch)	Qty.	Order No.
2	15.24	0.600	65	1060550000
3	22.86	0.900	50	1060570000
4	30.48	1.200	40	1430120000
5	38.10	1.500	30	1430130000
6	45.72	1.800	25	2629920000

Representative deratings curve

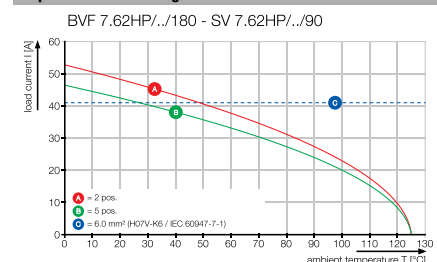

BVF 7.62HP../180MF3



Dimensioned drawing

BVF 7.62HP../180MF4



Dimensioned drawing

POS. 1 2 3 4 5

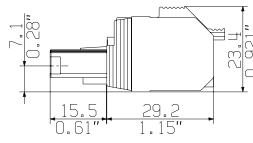
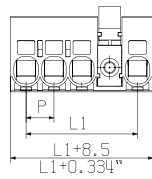
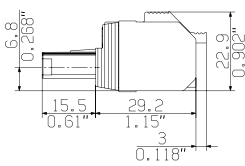
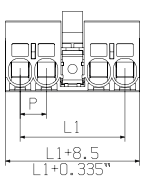

Ordering data

Solder pin length					
Colour					black
Pitch 7.62 mm					
Pol.	L1	(inch)	Qty.	Order No.	
3	22.86	0.900	50	1060580000	
4	30.48	1.200	40	1060590000	
5	38.10	1.500	30	1060600000	
6	45.72	1.800	25	2630270000	

Ordering data

Solder pin length					
Colour					black
Pitch 7.62 mm					
Pol.	L1	(inch)	Qty.	Order No.	
4	30.48	1.200	40	1430140000	
5	38.10	1.500	30	1060610000	
6	45.72	1.800	25	1060620000	

Additional deratings curves

BVF 7.62HP../180 - SVF 7.62HP../180

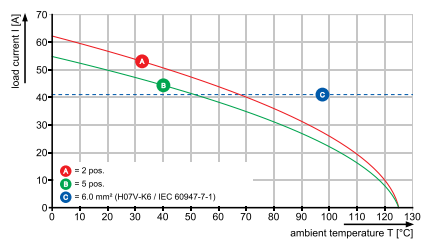

BVF 7.62HP../180 - SV 7.62HP../270

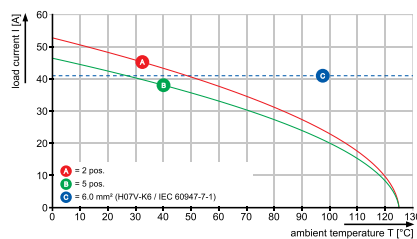

Connectors, pitch 7.62 mm
BV/SV 7.62 series - connection up to 6 mm²

BVF 7.62HP../180MSF



PUSH IN

Female plug in 180° outlet direction with PUSH IN spring connection for TNC (S) systems. Meets the requirements of UL1059 for 600 V Use Group C. The mating profile ensures touch-safety of > 3 mm in accordance with IEC 61800-5-1.

Maximum operational reliability with a derating up to 125°C, a mating profile that can only be plugged in correct, and unique coding capability.

- Middle flange available in positions 2, 3 and 4.

Technical data

In compliance with IEC 60664-1 / IEC 61984			
Clamping range, max.	mm ²	0.5...10	
Solid core H05(07) V-U	mm²	0.5...10	
Stranded H07 V-R		...10	
Flexible H05(07) V-K	mm ²	0.5...10	
Flexible with ferrule	mm ²	0.5...10	
Ferrule with plastic collar	mm ²	0.5...6	
Stripping length	mm	12	
Screwdriver blade	mm	0.6 x 3.5	
According to norm			
Tightening torque range			
Rated current, max.	A	57	57
At ambient temperature		20°C	40°C
For conductor cross-section	mm ²	6	
Overvoltage category		III	III II
Pollution severity		3	2 2
Rated voltage	V	800	1000 1000
Rated impulse voltage	kV	8	8 6
UL / CUL (Use Group)		B	C D
Rated voltage	V	600	600 600
Rated current	A	39	39 5
AWG conductor	AWG	24-8	
CSA (Use Group)		B	C D
Rated voltage	V	600	600 600
Rated current	A	33	33 5
AWG conductor	AWG	24-8	
General data			
Type of insulation material		PA GF	
UL 94 flammability rating		V-0	
Contact base material		Copper alloy	
Material of contact surface		tinned	
Pin dimensions = d	mm		
Solder eyelet Ø = D			
Solder eyelet Ø tolerance	mm		

Product data

IEC: 1000 V / 57 A / 0.5 - 10 mm²
 UL: 600 V / 39 A / AWG 24 - 8



For additional articles and information, refer to catalog.weidmuller.com

Note:

- Additional variants on request
- Wire end ferrule with plastic collar to DIN 46228/4
- Wire end ferrule without plastic collar to DIN 46228/1
- P on drawing = pitch
- Rated data refer only to the component itself. Clearance and creepage distances to other components are to be designed in accordance with the relevant application standards.
- Long term storage of the product with average temperature of 50 °C and average humidity 70%, 36 months

BVF 7.62HP../180MSF2

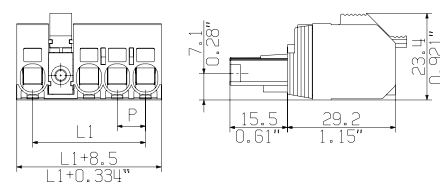

Accessories

Note: Refer to the Accessories chapter for additional accessories.		
Coding		Order No.
	BV/SV 7.62HP K0	1937590000
Screwdriver		
	SDS 0.8X4.5X125	2749370000
Pressing tool		
	PZ 6/5	9011460000
Coupling set		
	SVF/BVF 7.62HP COUPLE SET	1440850000

Ordering data

Solder pin length					
Colour					black
Pitch 7.62 mm					
Pol.	L1	(inch)	Qty.	Order No.	
2	15.24	0.600	65	1060630000	
3	22.86	0.900	50	1060640000	
4	30.48	1.200	40	1430090000	
5	38.10	1.500	30	1430100000	

Representative deratings curve

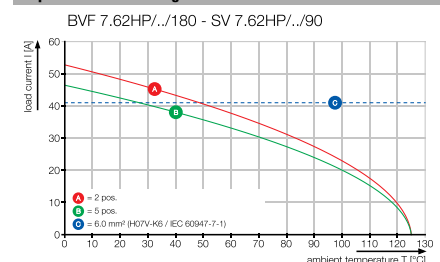

OMNIMATE® Power PCB connectors

P

7.62

180°

6 mm²

BVF 7.62HP../180MSF3



Dimensioned drawing

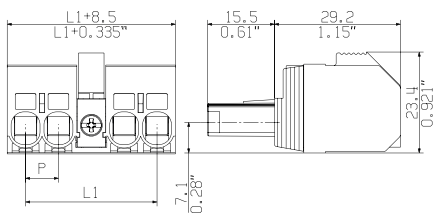

BVF 7.62HP../180MSF4



Dimensioned drawing

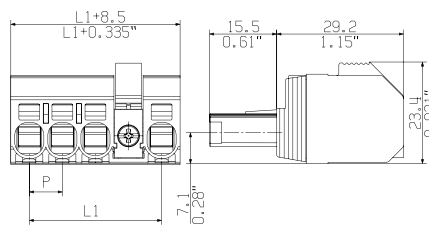

Ordering data

Solder pin length					
Colour					black
Pitch 7.62 mm					
Pol.	L1	(inch)	Qty.	Order No.	
3	22.86	0.900	50	1060650000	
4	30.48	1.200	40	1060670000	
5	38.10	1.500	30	1060680000	
6	45.72	1.800	25	2630320000	

Ordering data

Solder pin length					
Colour					black
Pitch 7.62 mm					
Pol.	L1	(inch)	Qty.	Order No.	
4	30.48	1.200	40	1430110000	
5	38.10	1.500	30	1060690000	
6	45.72	1.800	25	1060700000	

Additional deratings curves

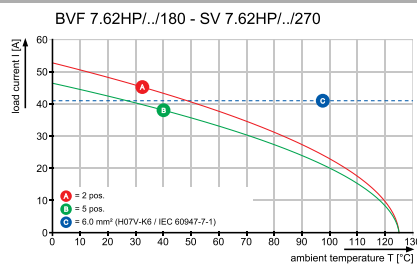
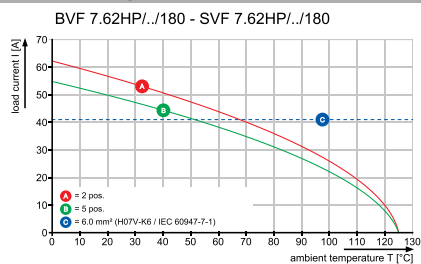

Connectors, pitch 7.62 mm
BV/SV 7.62 series - connection up to 6 mm²

BVFL 7.62HP/./180

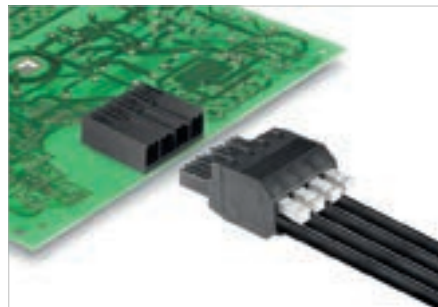

Female plug with 180° outlet direction, adjustable actuator (pusher) and PUSH IN spring connection technology for TNC(S) networks. Meets the requirements of UL1059 for 600 V Use Group C. The pin arrangement ensures finger-safety of >3 mm in accordance with IEC 61800-5-1.

Maximum connection and operating reliability thanks to derating up to 125°C, unique coding diversity and a pin arrangement that ensures failsafe insertion.

Variants: flange, screw flange, middle flange and middle screw flange mounting.

Product data

IEC: 1000 V / 41 A / 0.5 - 6 mm²
 UL: 600 V / 39 A / AWG 24 - 8



For additional articles and information, refer to catalog.weidmueller.com

Note:

- Additional variants on request
- Wire end ferrule with plastic collar to DIN 46228/4
- Wire end ferrule without plastic collar to DIN 46228/1
- P on drawing = pitch
- Rated data refer only to the component itself. Clearance and creepage distances to other components are to be designed in accordance with the relevant application standards.
- Additional pole combinations on request
- Long term storage of the product with average temperature of 50 °C and average humidity 70%, 36 months

BVFL 7.62HP/./180



Dimensioned drawing

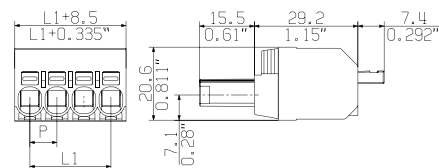

Technical data

In compliance with IEC 60664-1 / IEC 61984			
Clamping range, max.	mm ²	0.5...6	
Solid core H05(07) V-U	mm ²	0.5...6	
Stranded H07 V-R			
Flexible H05(07) V-K	mm ²	0.5...6	
Flexible with ferrule	mm ²	0.5...6	
Ferrule with plastic collar	mm ²	0.5...6	
Stripping length	mm	12	
Screwdriver blade	mm	0.6 x 3.5	
According to norm			
Tightening torque range			
Rated current, max.	A	41	41
At ambient temperature		20°C	40°C
For conductor cross-section	mm ²	6	
Overvoltage category		III	III II
Pollution severity		3	2 2
Rated voltage	V	800	1000 1000
Rated impulse voltage	kV	8	8 6
UL / CUL (Use Group)		B	C D
Rated voltage	V	600	600 600
Rated current	A	39	39 5
AWG conductor	AWG	24-8	
CSA (Use Group)		B	C D
Rated voltage	V	600	600 600
Rated current	A	33	33 5
AWG conductor	AWG	24-8	
General data			
Type of insulation material		PA GF	
UL 94 flammability rating		V-0	
Contact base material		Copper alloy	
Material of contact surface		tinned	
Pin dimensions = d	mm		
Solder eyelet Ø = D	mm		
Solder eyelet Ø tolerance	mm		

Accessories

Note: Refer to the Accessories chapter for additional accessories.

Coding		Order No.
	BV/SV 7.62HP K0	1937590000
Screwdriver		
	SDS 0.8X4.5X125	2749370000
Pressing tool		
	PZ 6/5	9011460000

Ordering data

Solder pin length				
Colour	black			
Pitch	7.62 mm			
Pol.	L1	(inch)	Qty.	Order No.
2	7.62	0.300	120	2548870000
3	15.24	0.600	84	2548880000
4	22.86	0.900	60	1547520000
5	30.48	1.200	42	2548890000

Representative deratings curve

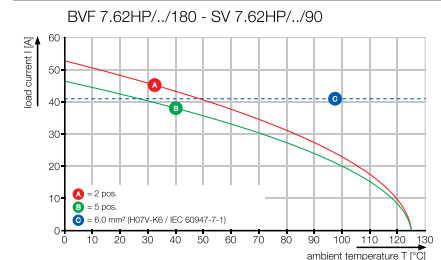

BVFL 7.62HP../180F



Dimensioned drawing

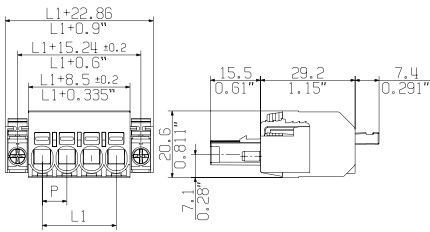

Ordering data

Solder pin length				
Colour				black
Pitch		7.62 mm		
Pol.	L1	(inch)	Qty.	Order No.
2	7.62	0.300	66	2549280000
3	15.24	0.600	48	2549340000
4	22.86	0.900	42	1547530000
5	30.48	1.200	36	2549350000

Additional deratings curves

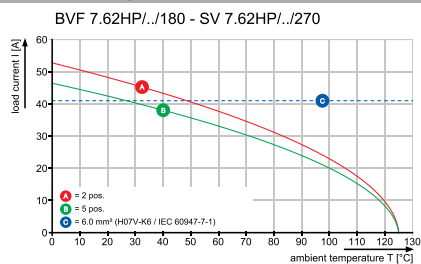

Connectors, pitch 7.62 mm
BV/SV 7.62 series - connection up to 6 mm²

BVFL 7.62HP../180MF

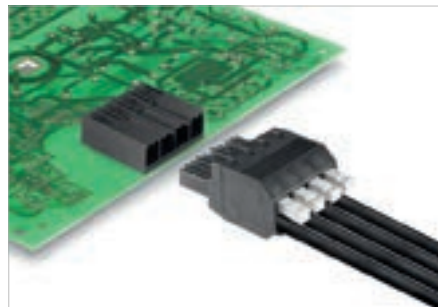

Female plug with 180° outlet direction, adjustable actuator (pusher) and PUSH IN spring connection technology for TNC(S) networks. Meets the requirements of UL1059 for 600 V Use Group C. The pin arrangement ensures finger-safety of >3 mm in accordance with IEC 61800-5-1.

Maximum connection and operating reliability thanks to derating up to 125°C, unique coding diversity and a pin arrangement that ensures failsafe insertion.

Variants: flange, screw flange, middle flange and middle screw flange mounting.

Product data

IEC: 1000 V / 41 A / 0.5 - 6 mm²
 UL: 600 V / 39 A / AWG 24 - 8



For additional articles and information, refer to catalog.weidmuller.com

Note:

- Additional variants on request
- Wire end ferrule with plastic collar to DIN 46228/4
- Wire end ferrule without plastic collar to DIN 46228/1
- P on drawing = pitch
- Rated data refer only to the component itself. Clearance and creepage distances to other components are to be designed in accordance with the relevant application standards.
- Additional pole combinations on request
- Long term storage of the product with average temperature of 50 °C and average humidity 70%, 36 months

BVFL 7.62HP../180MF2



Dimensioned drawing

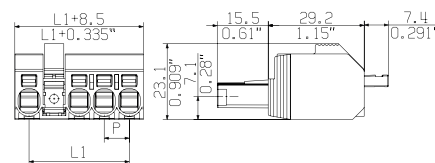

Technical data

In compliance with IEC 60664-1 / IEC 61984			
Clamping range, max.	mm ²	0.5...6	
Solid core H05(07) V-U	mm²	0.5...6	
Stranded H07 V-R			
Flexible H05(07) V-K	mm ²	0.5...6	
Flexible with ferrule	mm ²	0.5...6	
Ferrule with plastic collar	mm ²	0.5...6	
Stripping length	mm	12	
Screwdriver blade	mm	0.6 x 3.5	
According to norm			
Tightening torque range			
Rated current, max.	A	41	41
At ambient temperature		20°C	40°C
For conductor cross-section	mm ²	6	
Overvoltage category		III	III II
Pollution severity		3	2 2
Rated voltage	V	800	1000 1000
Rated impulse voltage	kV	8	8 6
UL / CUL (Use Group)		B	C D
Rated voltage	V	600	600 600
Rated current	A	39	39 5
AWG conductor	AWG	24-8	
CSA (Use Group)		B	C D
Rated voltage	V	600	600 600
Rated current	A	33	33 5
AWG conductor	AWG	24-8	
General data			
Type of insulation material		PA GF	
UL 94 flammability rating		V-0	
Contact base material		Copper alloy	
Material of contact surface		tinned	
Pin dimensions = d	mm		
Solder eyelet Ø = D	mm		
Solder eyelet Ø tolerance	mm		

Accessories

Note: Refer to the Accessories chapter for additional accessories.		
Coding		Order No.
	BV/SV 7.62HP K0	1937590000
Screwdriver		
	SDS 0.8X4.5X125	2749370000
Pressing tool		
	PZ 6/5	9011460000
Coupling set		
	SVF/BVF 7.62HP COUPLE SET	1440850000

Ordering data

Solder pin length					
Colour					black
Pitch 7.62 mm					
Pol.	L1	(inch)	Qty.	Order No.	
2	15.24	0.600	84	2549300000	
3	22.86	0.900	60	2549360000	
4	30.48	1.200	48	2630700000	
5	38.10	1.500	42	2630710000	
6	45.72	1.800	36	2630720000	

Representative deratings curve

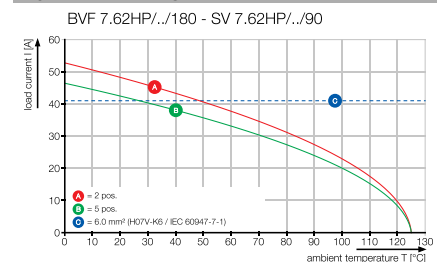

BVFL 7.62HP../180MF3



Dimensioned drawing

BVFL 7.62HP../180MF4



Dimensioned drawing

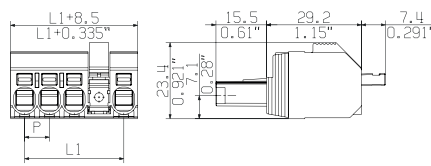
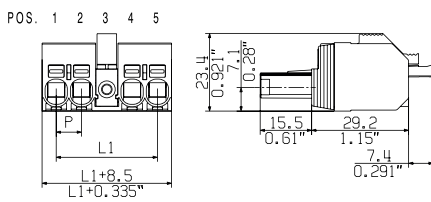

Ordering data

Solder pin length					
Colour					black
Pitch 7.62 mm					
Pol.	L1	(inch)	Qty.	Order No.	
3	22.86	0.900	60	2549370000	
4	30.48	1.200	48	1547540000	
5	38.10	1.500	42	2549380000	
6	45.72	1.800	36	2630730000	

Ordering data

Solder pin length					
Colour					black
Pitch 7.62 mm					
Pol.	L1	(inch)	Qty.	Order No.	
4	30.48	1.200	48	2630740000	
5	38.10	1.500	42	2549390000	

Additional deratings curves

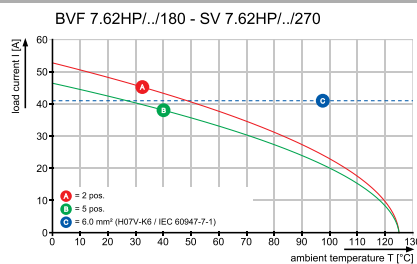
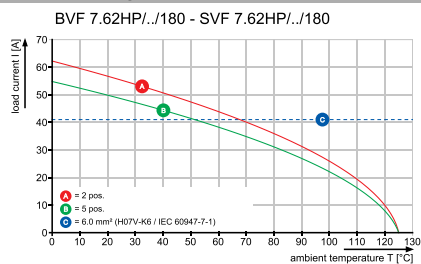

Connectors, pitch 7.62 mm
BV/SV 7.62 series - connection up to 6 mm²

BVDF 7.62HP 180

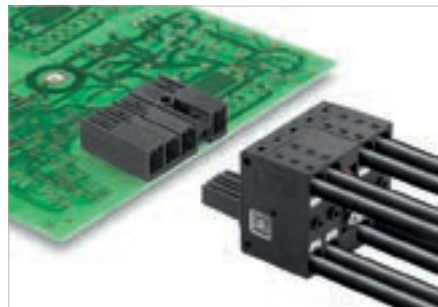

Bus connector with two connections per pole with the time-saving 6mm² PUSH IN connection system.

- The extremely short cross-connection allows you to safely loop through bus currents.
- PUSH IN connection: Solid wires and stranded wires with ferrules need only to be inserted and they are ready.
- The self-locking middle flange reduces the space requirements by one pitch width in comparison with conventional solutions.

Technical data

In compliance with IEC 60664-1 / IEC 61984			
Clamping range, max.	mm ²	0.5...10	
Solid core H05(07) V-U	mm²	0.5...10	
Stranded H07 V-R		...6	
Flexible H05(07) V-K	mm ²	0.5...10	
Flexible with ferrule	mm ²	0.5...6	
Ferrule with plastic collar	mm ²	0.5...	
Stripping length	mm	12	
Screwdriver blade	mm	0.6 x 3.5	
According to norm			
Tightening torque range			
Rated current, max.	A	46	41
At ambient temperature		20°C	40°C
For conductor cross-section			
Overvoltage category		III	III II
Pollution severity		3	2 2
Rated voltage	V	600	600 600
Rated impulse voltage	kV	6	6 4
UL / CUL (Use Group)	B C D		
Rated voltage	V	600	600 600
Rated current	A	35	35 35
AWG conductor	AWG	24-8	
CSA (Use Group)	B C D		
Rated voltage	V		
Rated current	A		
AWG conductor	AWG		
General data			
Type of insulation material		PA GF	
UL 94 flammability rating		V-0	
Contact base material		Copper alloy	
Material of contact surface		tinned	
Pin dimensions = d	mm		
Solder eyelet Ø = D	mm		
Solder eyelet Ø tolerance	mm		

Product data

IEC: 600 V / 46 A / 0.5 - 10 mm²
 UL: 600 V / 35 A / AWG 24 - 8



For additional articles and information, refer to catalog.weidmuller.com

Note:

- Additional variants on request
- Wire end ferrule with plastic collar to DIN 46228/4
- Wire end ferrule without plastic collar to DIN 46228/1
- P on drawing = pitch
- Rated data refer only to the component itself. Clearance and creepage distances to other components are to be designed in accordance with the relevant application standards.
- Long term storage of the product with average temperature of 50 °C and average humidity 70%, 36 months

BVDF 7.62HP/.../180



Dimensioned drawing

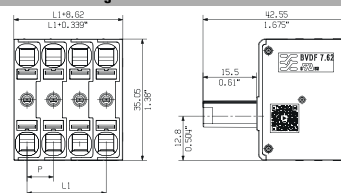

Accessories

Note: Refer to the Accessories chapter for additional accessories.

Coding	Order No.
BV/SV 7.62HP K0	1937590000
Screwdriver	
SDS 0.6X3.5X100	2749340000
Pressing tool	
PZ 6/5	9011460000

Ordering data

Solder pin length				
Colour	black			
Pitch	7.62 mm			
Pol.	L1	(inch)	Qty.	Order No.
2	7.62	0.300	57	2719370000
3	15.24	0.600	39	2720430000
4	22.86	0.900	30	2720440000
5	30.48	1.200	24	2720450000
6	38.10	1.500	18	2720460000
7	45.62	1.800	15	2720470000
8	53.34	2.100	15	2720480000

Representative deratings curve

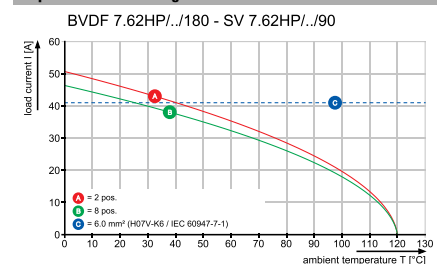

BVDF 7.62HP/.../180SF



Dimensioned drawing

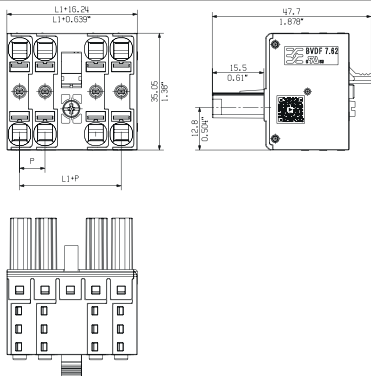

Ordering data

Solder pin length					
Colour					black
Pitch 7.62 mm					
Pol.	L1	(inch)	Qty.	Order No.	
2	7.62	0.300	30	2719380000	
3	15.24	0.600	24	2720490000	
4	22.86	0.900	21	2720500000	
5	30.48	1.200	18	2720510000	
6	38.10	1.500	15	2720520000	
7	45.72	1.800	12	2720530000	
8	53.34	2.100	12	2720540000	

BVDF 7.62HP/.../180MSF



Dimensioned drawing

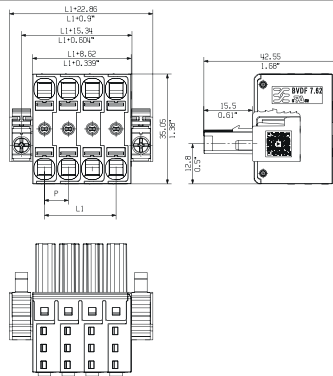

Ordering data

Solder pin length					
Colour					black
Pitch 7.62 mm					
Pol.	L1	(inch)	Qty.	Order No.	
2	7.62	0.300	39	2720560000	
3	15.24	0.600	30	2720570000	
4	22.86	0.900	24	2720580000	
5	30.48	1.200	18	2720590000	
6	38.10	1.500	15	2720600000	
7	45.72	1.800	15	2720610000	
8	53.34	2.100	12	2720620000	

Additional deratings curves

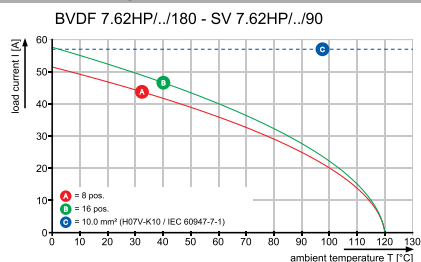

Connectors, pitch 7.62 mm
BV/SV 7.62 series - connection up to 6 mm²

BVL 7.62HP../90

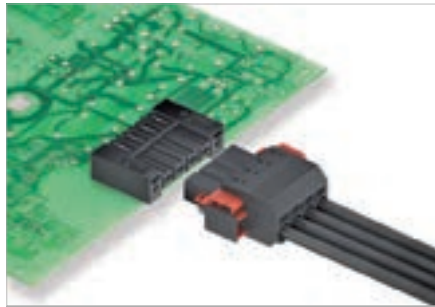

Touch-safe female header with 90° outlet direction for PCBs. Meets the requirements of IEC 61800-5-1 and comes with UL approval in accordance with UL508-5-1 / UL840 for 600 V. An ideal touch-safe solution for power output and DC-link applications. The pin arrangement ensures more than 3 mm of touch-safety in accordance with IEC 61800-5-1.

Maximum connection and operating reliability thanks to: derating up to 125°C, pin arrangement that prevents wrong connections or incorrect wiring, and unique coding diversity.

Variants: flange and screw flange fastening.

Technical data

In compliance with IEC 60664-1 / IEC 61984

Clamping range, max.			
Solid core H05(07) V-U			
Stranded H07 V-R			
Flexible H05(07) V-K			
Flexible with ferrule			
Ferrule with plastic collar			
Stripping length			
Screwdriver blade	mm		
According to norm			
Tightening torque range			
Rated current, max.	A	56.8	41
At ambient temperature		20°C	40°C
For conductor cross-section			
Overtoltage category		III	III II
Pollution severity		3	2 2
Rated voltage	V	630	630 1000
Rated impulse voltage	kV	6	6 6
UL / CUL (Use Group)		B	C D
Rated voltage	V	300	300 600
Rated current	A	35	35 5
AWG conductor	AWG		-
CSA (Use Group)		B	C D
Rated voltage	V	300	300 600
Rated current	A	35	35 5
AWG conductor	AWG		-
General data			
Type of insulation material		PA GF	
UL 94 flammability rating		V-0	
Contact base material		Copper alloy	
Material of contact surface		tinned	
Pin dimensions = d	mm	0.8 x 1.0	
Solder eyelet Ø = D	mm	1.3	
Solder eyelet Ø tolerance	mm	+ 0,1	

Product data

IEC: 1000 V / 56.8 A
 UL: 300 V / 35 A



For additional articles and information, refer to catalog.weidmuller.com

Note:

- Additional variants on request
- Rated current related to rated cross-section & min. No. of poles.
- P on drawing = pitch
- Rated data refer only to the component itself. Clearance and creepage distances to other components are to be designed in accordance with the relevant application standards.
- Long term storage of the product with average temperature of 50 °C and average humidity 70%, 36 months

BVL 7.62HP../90



Dimensioned drawing

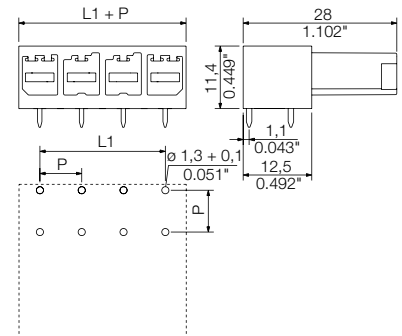

Accessories

Note: Refer to the Accessories chapter for additional accessories.

Coding	Order No.
BV/SV 7.62HP K0	1937590000

Ordering data

Solder pin length	3.5 mm			
Colour	black			
Pitch	7.62 mm			
Pol.	L1	(inch)	Qty.	Order No.
2	7.62	0.300	100	1928280000
3	15.24	0.600	100	1928290000
4	22.86	0.900	100	1928300000
5	30.48	1.200	50	1928310000
6	38.10	1.500	50	1928320000
7	45.72	1.800	50	1928330000

Representative deratings curve

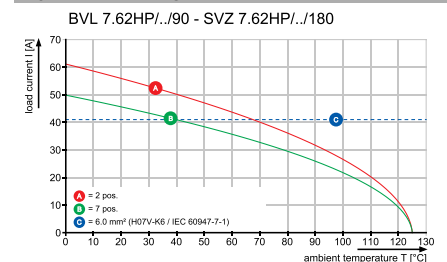

BVL 7.62HP../90FI



Dimensioned drawing

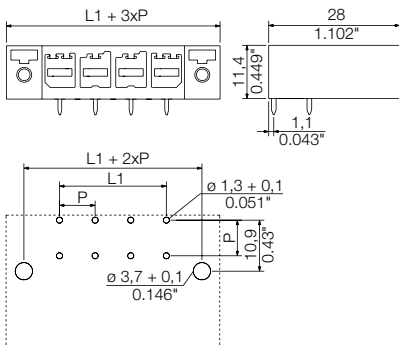

Ordering data

Solder pin length		3.5 mm		
Colour		black		
Pitch		7.62 mm		
Pol.	L1	(inch)	Qty.	Order No.
2	7.62	0.300	100	1928390000
3	15.24	0.600	100	1928400000
4	22.86	0.900	100	1928410000
5	30.48	1.200	50	1928420000
6	38.10	1.500	50	1928430000
7	45.72	1.800	50	1928440000

BVL 7.62HP../90SFI



Dimensioned drawing

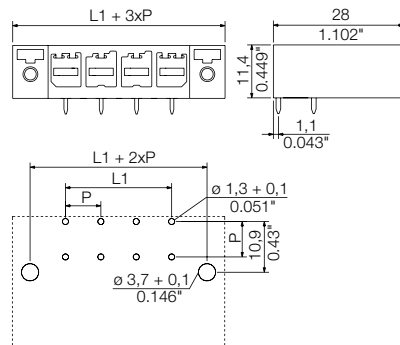

Ordering data

Solder pin length		3.5 mm		
Colour		black		
Pitch		7.62 mm		
Pol.	L1	(inch)	Qty.	Order No.
2	7.62	0.300	100	1928500000
3	15.24	0.600	100	1928510000
4	22.86	0.900	100	1928520000
5	30.48	1.200	50	1928530000
6	38.10	1.500	50	1928540000
7	45.72	1.800	50	1928550000

Additional deratings curves

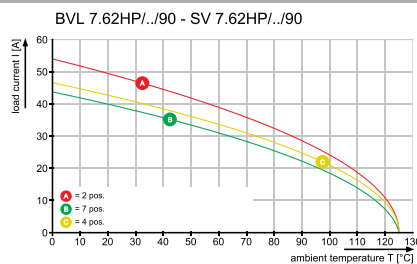
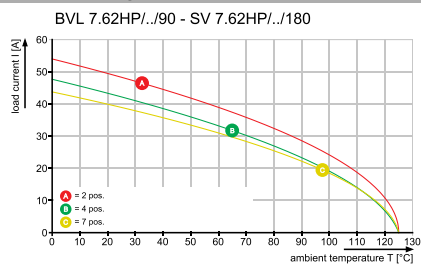

Connectors, pitch 7.62 mm
BV/SV 7.62 series - connection up to 6 mm²

BVL 7.62HP../180

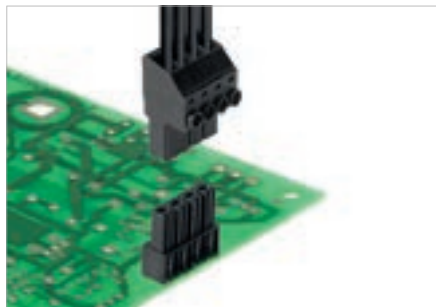

Touch-safe female header with 180° outlet direction for PCBs. Meets the requirements of IEC 61800-5-1 and comes with UL approval in accordance with UL508-5-1 / UL840 for 600 V. An ideal touch-safe solution for power output and DC-link applications. The pin arrangement ensures more than 3 mm of touch-safety in accordance with IEC 61800-5-1.

Characteristics: derating up to 125°C, pin arrangement that prevents wrong connections or incorrect wiring, unique coding diversity, additional fixing and integral positioning aid.

Variants: flange and screw flange fastening.

Product data

IEC: 1000 V / 56.8 A
 UL: 300 V / 42 A



For additional articles and information, refer to catalog.weidmueller.com

Note:

- Additional variants on request
- Rated current related to rated cross-section & min. No. of poles.
- P on drawing = pitch
- Rated data refer only to the component itself. Clearance and creepage distances to other components are to be designed in accordance with the relevant application standards.
- Long term storage of the product with average temperature of 50 °C and average humidity 70%, 36 months

BVL 7.62HP../180



Dimensioned drawing

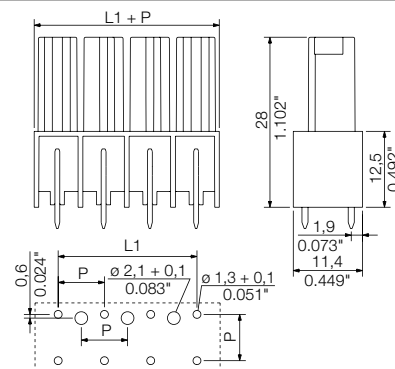

Technical data

In compliance with IEC 60664-1 / IEC 61984			
Clamping range, max.			
Solid core H05(07) V-U			
Stranded H07 V-R			
Flexible H05(07) V-K			
Flexible with ferrule			
Ferrule with plastic collar			
Stripping length			
Screwdriver blade	mm		
According to norm			
Tightening torque range			
Rated current, max.	A	56.8	41
At ambient temperature		20°C	40°C
For conductor cross-section			
Overtoltage category		III	III II
Pollution severity		3	2 2
Rated voltage	V	630	630 1000
Rated impulse voltage	kV	6	6 6
UL / CUL (Use Group)		B	C D
Rated voltage	V	300	300 600
Rated current	A	42	42 5
AWG conductor	AWG	-	
CSA (Use Group)		B	C D
Rated voltage	V	300	300 600
Rated current	A	35	35 5
AWG conductor	AWG	-	
General data			
Type of insulation material		PA GF	
UL 94 flammability rating		V-0	
Contact base material		Copper alloy	
Material of contact surface		tinned	
Pin dimensions = d	mm	0.8 x 1.0	
Solder eyelet Ø = D	mm	1.3	
Solder eyelet Ø tolerance	mm	+ 0,1	

Accessories

Note: Refer to the Accessories chapter for additional accessories.

Coding		Order No.
	BV/SV 7.62HP K0	1937590000
Protection against twisting		
	VDS180 SV7.62	1853940000

Ordering data

Solder pin length		3.5 mm		
Colour		black		
Pitch		7.62 mm		
Pol.	L1	(inch)	Qty.	Order No.
2	7.62	0.300	100	1928610000
3	15.24	0.600	100	1928620000
4	22.86	0.900	100	1928630000
5	30.48	1.200	50	1928650000
6	38.10	1.500	50	1928660000
7	45.72	1.800	50	1928670000

Representative deratings curve

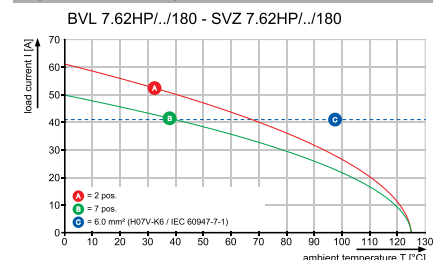

BVL 7.62HP../180FI



Dimensioned drawing

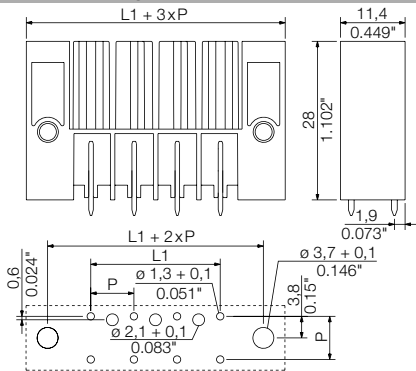

Ordering data

Solder pin length		3.5 mm		
Colour		black		
Pitch		7.62 mm		
Pol.	L1	(inch)	Qty.	Order No.
2	7.62	0.300	100	1928730000
3	15.24	0.600	100	1928740000
4	22.86	0.900	100	1928750000
5	30.48	1.200	50	1928760000
6	38.10	1.500	50	1928770000
7	45.72	1.800	50	1928780000

BVL 7.62HP../180SFI



Dimensioned drawing

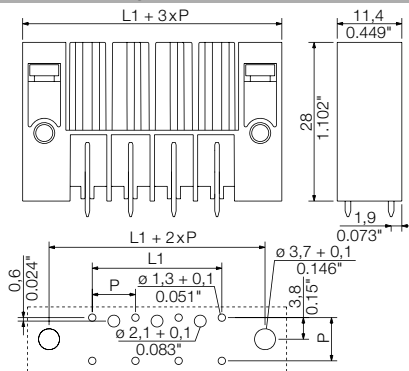

Ordering data

Solder pin length		3.5 mm		
Colour		black		
Pitch		7.62 mm		
Pol.	L1	(inch)	Qty.	Order No.
2	7.62	0.300	100	1928840000
3	15.24	0.600	100	1928850000
4	22.86	0.900	100	1928860000
5	30.48	1.200	50	1928870000
6	38.10	1.500	50	1928900000
7	45.72	1.800	50	1928910000

Additional deratings curves

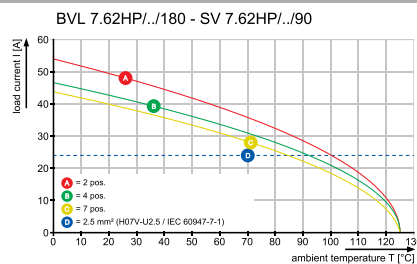
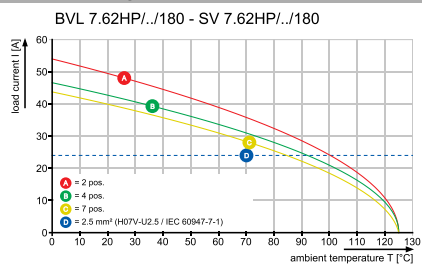

Connectors, pitch 7.62 mm
BV/SV 7.62 series - connection up to 6 mm²

BVL 7.62HP../270

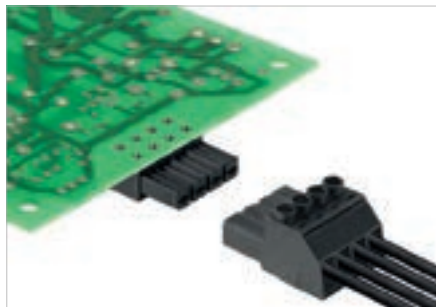

Finger-safe female header with 270° outlet direction for PCBs. Meets the requirements of IEC 61800-5-1 and comes with UL approval in accordance with UL508-5-1 / UL840 for 600 V. An ideal touch-safe solution for power output and DC-link applications. The pin arrangement ensures more than 3 mm of touch-safety in accordance with IEC 61800-5-1.

Maximum connection and operating reliability thanks to: derating up to 125°C, pin arrangement that prevents wrong connections or incorrect wiring, and unique coding diversity.

Variants: flange and screw flange fastening.

Technical data

In compliance with IEC 60664-1 / IEC 61984

Clamping range, max.			
Solid core H05(07) V-U			
Stranded H07 V-R			
Flexible H05(07) V-K			
Flexible with ferrule			
Ferrule with plastic collar			
Stripping length			
Screwdriver blade	mm		
According to norm			
Tightening torque range			
Rated current, max.	A	56.8	41
At ambient temperature		20°C	40°C
For conductor cross-section			
Overtoltage category		III	III II
Pollution severity		3	2 2
Rated voltage	V	630	630 1000
Rated impulse voltage	kV	6	6 6
UL / CUL (Use Group)		B	C D
Rated voltage	V	300	300 600
Rated current	A	35	35 5
AWG conductor	AWG		-
CSA (Use Group)		B	C D
Rated voltage	V	300	300 600
Rated current	A	35	35 5
AWG conductor	AWG		-
General data			
Type of insulation material		PA GF	
UL 94 flammability rating		V-0	
Contact base material		Copper alloy	
Material of contact surface		tinned	
Pin dimensions = d	mm	0.8 x 1.0	
Solder eyelet Ø = D	mm	1.3	
Solder eyelet Ø tolerance	mm	+ 0,1	

Product data

IEC: 1000 V / 56.8 A
 UL: 300 V / 35 A



For additional articles and information, refer to catalog.weidmuller.com

Note:

- Additional variants on request
- Rated current related to rated cross-section & min. No. of poles.
- P on drawing = pitch
- Rated data refer only to the component itself. Clearance and creepage distances to other components are to be designed in accordance with the relevant application standards.
- Long term storage of the product with average temperature of 50 °C and average humidity 70%, 36 months

BVL 7.62HP../270

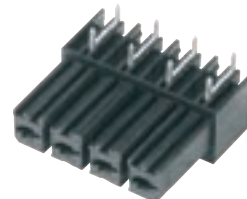

Dimensioned drawing

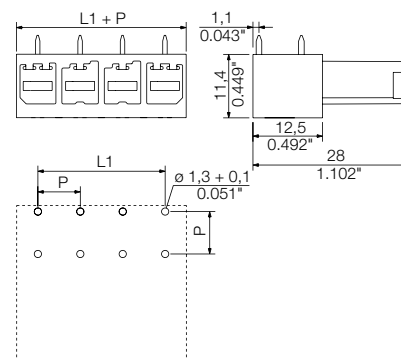

Ordering data

Solder pin length	3.5 mm			
Colour	black			
Pitch	7.62 mm			
Pol.	L1	(inch)	Qty.	Order No.
2	7.62	0.300	100	1929300000
3	15.24	0.600	100	1929310000
4	22.86	0.900	100	1929320000
5	30.48	1.200	50	1929330000
6	38.10	1.500	50	1929340000
7	45.72	1.800	50	1929350000

Accessories

Note: Refer to the Accessories chapter for additional accessories.

Coding	Order No.
BV/SV 7.62HP K0	1937590000

Representative deratings curve

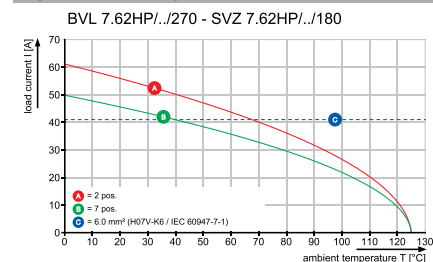

BVL 7.62HP../270FI

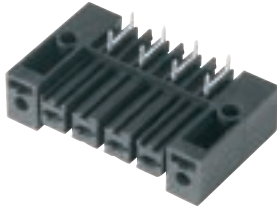

Dimensioned drawing

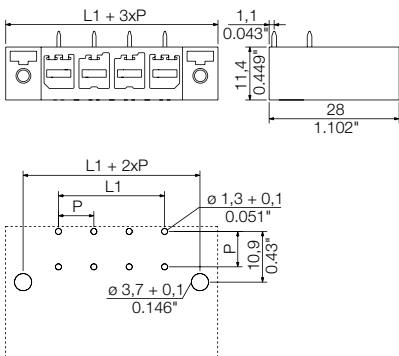

Ordering data

Solder pin length		3.5 mm		
Colour		black		
Pitch		7.62 mm		
Pol.	L1	(inch)	Qty.	Order No.
2	7.62	0.300	100	1929410000
3	15.24	0.600	100	1929420000
4	22.86	0.900	100	1929430000
5	30.48	1.200	50	1929440000
6	38.10	1.500	50	1929450000
7	45.72	1.800	50	1929460000

BVL 7.62HP../270SFI

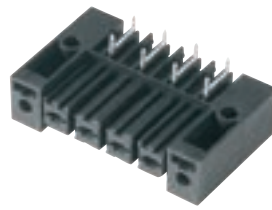

Dimensioned drawing

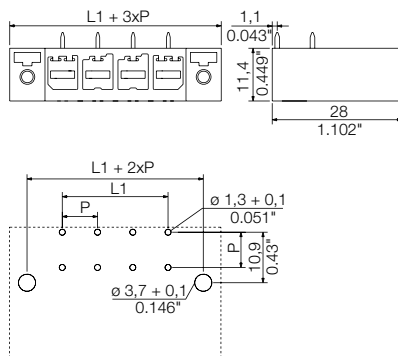

Ordering data

Solder pin length		3.5 mm		
Colour		black		
Pitch		7.62 mm		
Pol.	L1	(inch)	Qty.	Order No.
2	7.62	0.300	100	1929520000
3	15.24	0.600	100	1929530000
4	22.86	0.900	100	1929540000
5	30.48	1.200	50	1929550000
6	38.10	1.500	50	1929560000
7	45.72	1.800	50	1929570000

Additional deratings curves

BVL 7.62HP../270 - SV 7.62HP../180

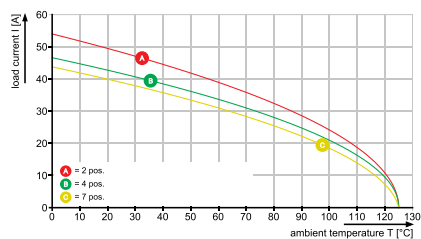

BVL 7.62HP../270 - SV 7.62HP../90

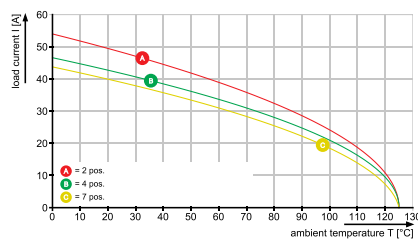

Increased current for better performance

The top class in the OMNIMATE® Power SU / BUZ 10.16HP connector system features a very durable contact system which makes it a pluggable power transmission solution with maximum load reserves.

P

HP stands for High Performance – performance exemplified by a long-term usage temperature of 120 °C. This custom, pluggable solution is suitable for all applications that must meet 600 V UL or 1,000 V (IEC) with up to 76 A (IEC) and 54 A (UL).

Compact reliability

Silver-plated contacts with stainless-steel top springs can tolerate short-circuit currents of 1,000 A for one second. Weidmüller's classic clamping yoke features a plus-minus screw and is protected against under insertion. It ensures a long-term, reliable connection.

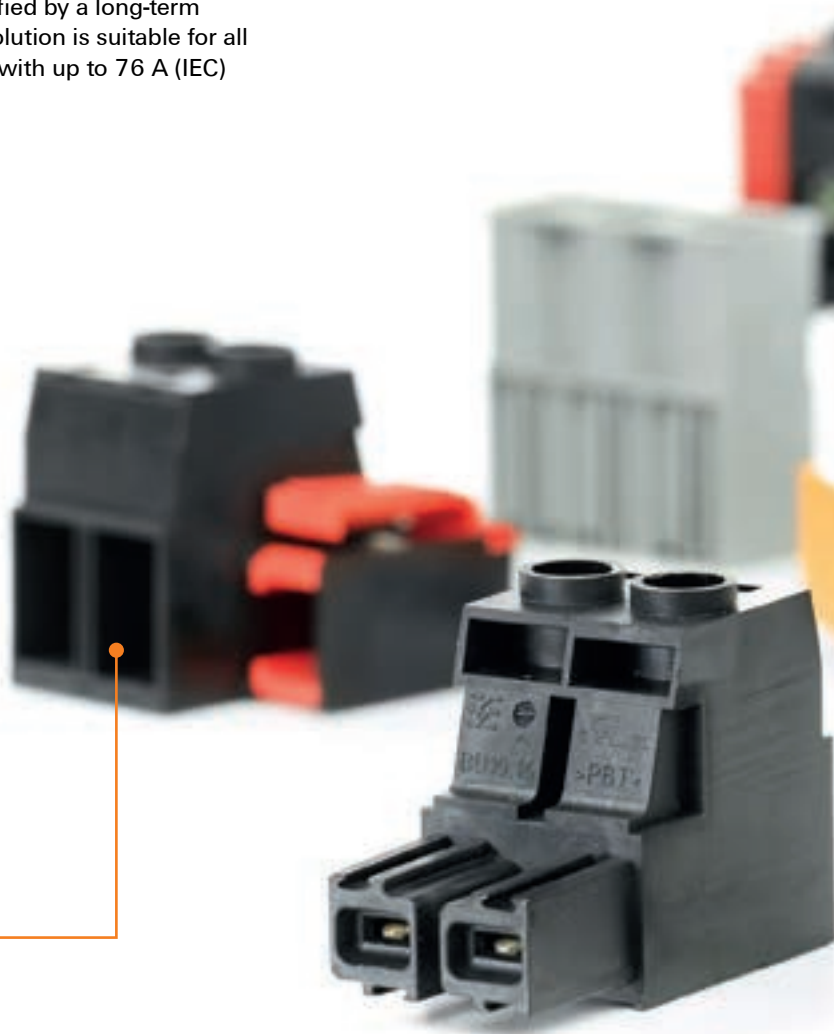



High system performance

The OMNIMATE® Power System up to 16 mm² can be individually combined with plugging mates that have an interlocking flange. It is also possible for the plugging mate to be screwed on.

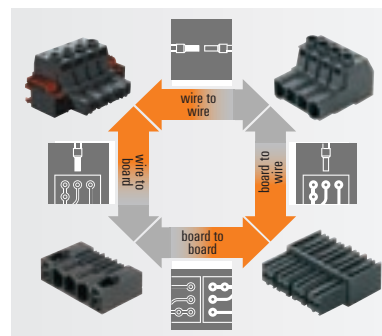

Individualised configuration

Clear printed labelling and customised coding are used to prevent damage that could be caused by installation mistakes.

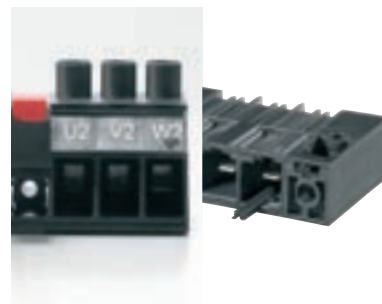

Compact integration

No compromises during design and approval: compact and standard-compliant with additional + 3.0 mm finger safety, according to IEC 61800-5-1, and increased creepage and clearance distances according to UL.

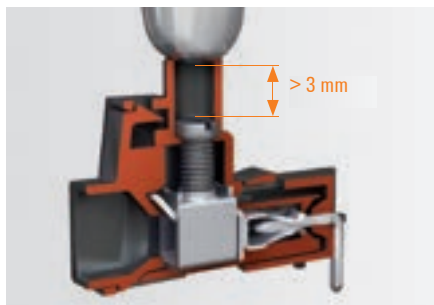

Touch-safe female header for power electronics

OMNIMATE® Power – plug-in connections for high power up to 76 A

P

Touch-safe protection for the contact blade is an important factor when considering high-power connectors. However such protection is currently quite difficult to design into standard products because of the size of the plug contacts.

We meet this challenge with our new BUL 10.16 female header in 10.16 mm pitch. The inverted plug ensures reliable touch protection for the unplugged, live side. This makes the BUL 10.16 a perfect-fit solution for board-to-wire connection in high-power electronics. You can also establish board-to-board connections when combined with the SU 10.16 HP standard male header.

Cannot be wrongly inserted

Only mated plugs with the same pole count fit together. The plugs' mating profiles make it impossible to connect plugs with different pole counts together.

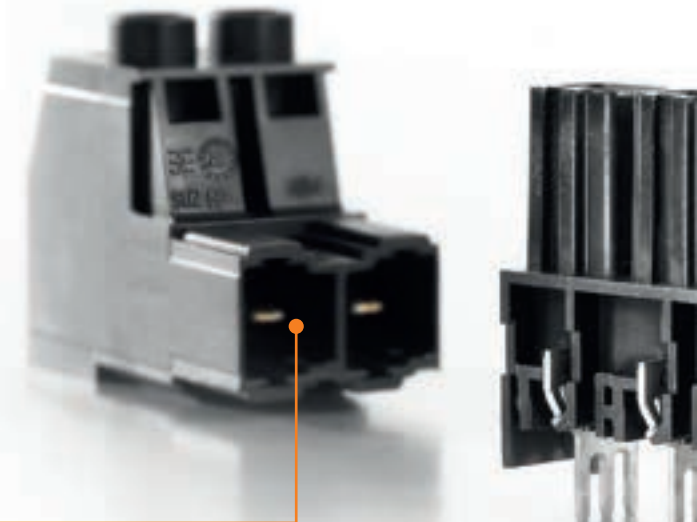

Plugging errors are not possible

With inserted coding elements, the male plug can only be connected with its corresponding female header.



Non-rotating assembly

Improved reliability while assembling the circuit board: An integrated coding pin serves as an assembly guide so that the plug cannot be accidentally turned 180°.

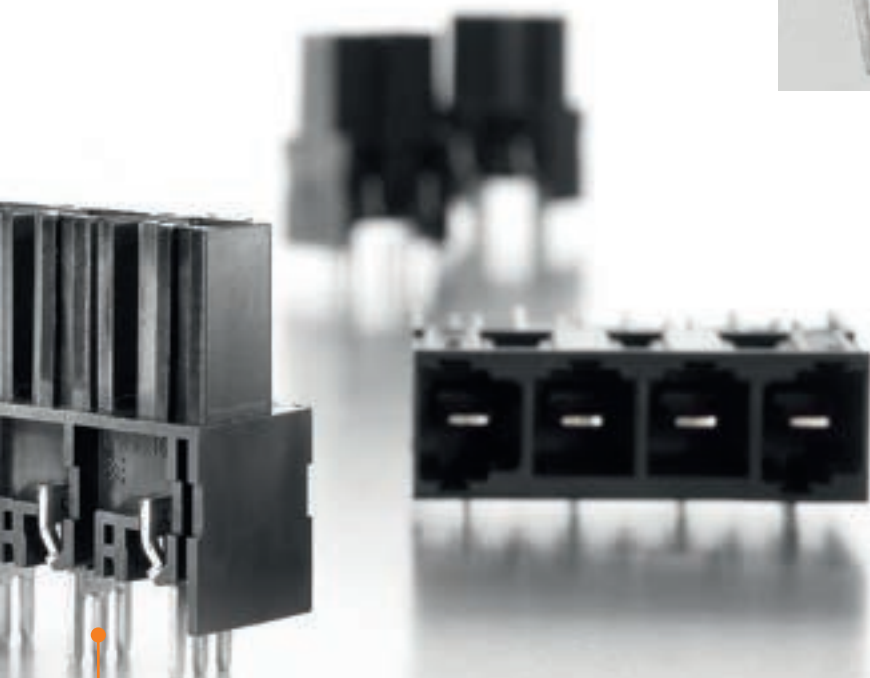

High performance

Three solder pins per pole provide the necessary mechanical strength while ensuring maximum current specifications.



Derating curve for the BUL 10.16 HP female header together with the SUZ 10.16 HP male plug

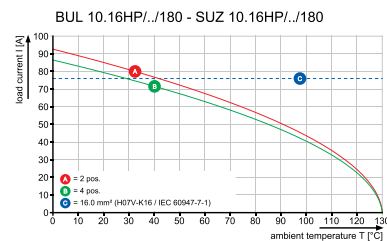

Derating curve for the BUL 10.16 HP female header together with the SU 10.16 HP male header

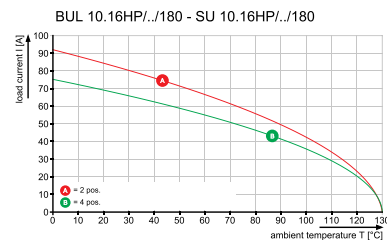

Secure and efficient connection of power electronics devices

PUSH IN-connector with wire-ready function

P

High power applications need connection by wires with huge cross sections, which typically are inflexible. Large PUSH IN connections are therefore difficult to plug in. Special tools are often needed for installation in narrow areas or for wiring with flexible wires without ferrules.

BUF 10.16 facilitates and accelerates this process and does not require additional tools. The operating lever which can be locked in open position (pusher) makes it yet possible to insert conductors with short cladding or rigid insulation into the open terminal. This means that the proven PUSH IN function remains unrestricted while the terminal point, fixed in an open position, allows a comfortable and easy connection under difficult conditions. The result is a noticeable saving of time.

Your special advantages:

- PUSH IN-technology with open position fixed clamping point
- Tool-free wiring of flexible wires without ferrules and wires with rigid isolation
- Easy one-hand operation of the connector
- Automatic locking by a centre flange with detent fixing and optional screw fixing

Easy one hand operation

Automatic locking by a centre flange with detent fixing and optional screw fixing.

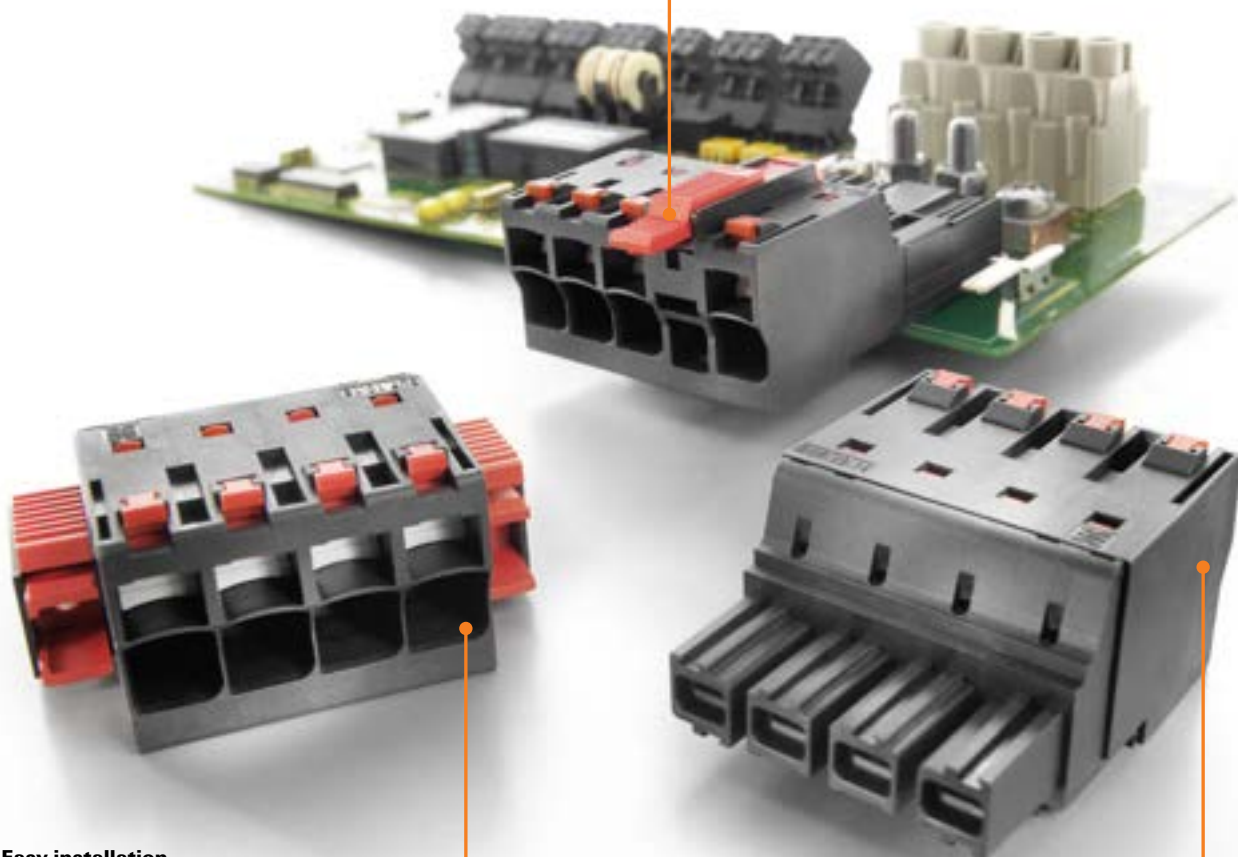
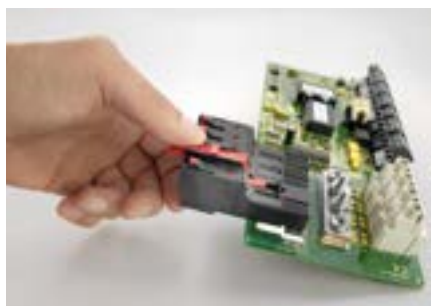

Easy installation

PUSH IN technology with open position fixed clamping point for easy wiring of flexible wires without ferrules and wires with rigid isolaton.







Fast wiring

The PUSH IN connection system allows a tool-free connection of solid wires or wires with ferrules.



<http://www.OMNIMATE.net>

-  = Wire-to-Board
-  = Board-to-Board
-  = Wire-to-Wire
-  = Board-to-Wire

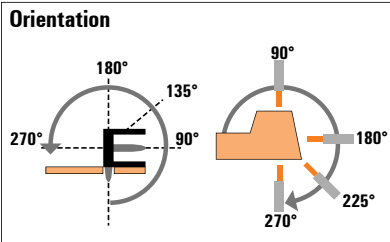
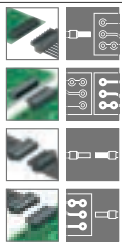

OMNIMATE® Power PCB connectors

P

BU/SU 10.16 series









Type

Orientation



Flange options

Product code numbers

		Type	Orientation	Flange options	Product code numbers
Female plug	 Screw Clamping yoke	 BUZ	180°	(G)/F/SF	IEC: 1.000 V/78 A/0.2 - 16 mm ² UL: 600 V/60 A/AWG 22 - 4
	 Spring PUSH IN	 BUF IT	180°	(G)/F/SF	IEC: 1.000 V/78 A/0.2 - 16 mm ² UL: 600 V/55 A/AWG 22 - 4
		 BUF IT SH	180°	(G)/F/SF	IEC: 1.000 V/78 A/0,2 - 16 mm ² UL: 600 V/55 A/AWG 22 - 4
Female header	 Solder connection	 BUL	180°	on request	"IEC: 1.000 V/76 A UL: 300 V/57 A"

Female:
(G) = without flange
F = Interlock flange
SF = Interlock flange with screw

Pin:
G = Closed (without flange)
F = Interlock flange
SF = Interlock flange with nut

Male header	Male plug
 Solder connection	 Screw Clamping yoke



SU	SU	SU	SUZ
90°	180°	270°	180°
G/F	G/F/SF	G/F/SF	G
IEC: 1.000 V/76 A UL: 300 V/54 A"	IEC: 1.000 V/76 A UL: 300 V/54 A"	EC: 1.000 V/76 A UL: 300 V/54 A"	IEC: 1.000 V/78 A/0.2 - 16 mm ² UL: 600 V/57 A/AWG 24 - 4
○	○	○	●
○	○	○	●
○	○	○	●
●	●	●	●

Connectors, pitch 10.16 mm
BU/SU 10.16 series - connection up to 16 mm²

SU 10.16HP/./90



Male header with 90° outlet direction for TNC(S) systems. UL approval for 600 V in acc. with UL508-5-1 / UL840. The pin arrangement ensures more than 3 mm of touch-safety in acc. with IEC 61800-5-1.

Maximum connection and operating reliability thanks to: derating up to 125°C, pin arrangement that prevents wrong connections or incorrect wiring, and unique coding diversity.

Variants: flange and screw flange fastening.

Product data

IEC: 1000 V / 78.3 A
 UL: 300 V / 60 A



For additional articles and information, refer to catalog.weidmuller.com

Note:

- Additional variants on request
- Rated current related to rated cross-section & min. No. of poles.
- P on drawing = pitch
- Rated data refer only to the component itself. Clearance and creepage distances to other components are to be designed in accordance with the relevant application standards.
- Long term storage of the product with average temperature of 50 °C and average humidity 70%, 36 months

SU 10.16HP/./90G

without flanges

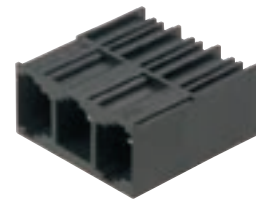

Dimensioned drawing

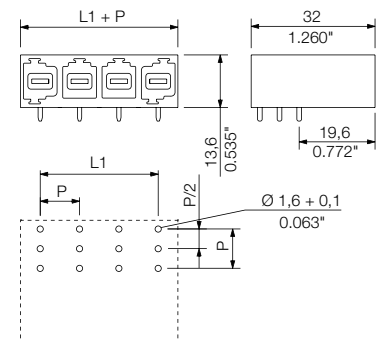

Technical data

In compliance with IEC 60664-1 / IEC 61984

Clamping range, max.			
Solid core H05(07) V-U			
Stranded H07 V-R			
Flexible H05(07) V-K			
Flexible with ferrule			
Ferrule with plastic collar			
Stripping length			
Screwdriver blade	mm		
According to norm			
Tightening torque range			
Rated current, max.	A	78.3	70.6
At ambient temperature		20°C	40°C
For conductor cross-section			
Overtoltage category		III	III II
Pollution severity		3	2 2
Rated voltage	V	690	1000 1000
Rated impulse voltage	kV	8	8 6
UL / CUL (Use Group)		B	C D
Rated voltage	V	300	300 600
Rated current	A	60	60 5
AWG conductor	AWG		-
CSA (Use Group)		B	C D
Rated voltage	V	300	300 600
Rated current	A	60	60 5
AWG conductor	AWG		-
General data			
Type of insulation material		PBT GF	
UL 94 flammability rating		V-0	
Contact base material		Copper alloy	
Material of contact surface		silver-plated	
Pin dimensions = d	mm	1.2 x 1.1	
Solder eyelet Ø = D	mm	1.6	
Solder eyelet Ø tolerance	mm	+ 0,1	

Accessories

Note: Refer to the Accessories chapter for additional accessories.

Coding	Order No.
KO BU/SU10.16HP BK	1824410000
KO BU/SU10.16HP WT	2592600000
Mounting screw	
SU 10.16 BFSC P 35X 14	2812340000
SU 10.16 BFSC S 35X12	2812290000

Ordering data

Solder pin length		3.5 mm		
Colour		black		
Pitch		10.16 mm		
Pol.	L1	(inch)	Qty.	Order No.
2	10.16	0.400	90	1813330000
3	20.32	0.800	1	1813340000
4	30.48	1.200	42	1813350000
5	40.64	1.600	36	1813360000
6	50.80	2.000	30	1813370000
7	60.96	2.400	24	1813380000
8	71.12	2.800	18	1813390000
9	81.28	3.200	18	1813400000

SU 10.16HP../90F

Interlock flanges



Dimensioned drawing

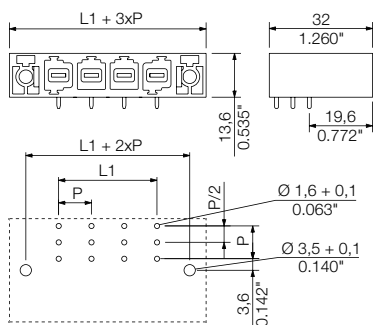

Ordering data

Solder pin length		3.5 mm		
Colour		black		
Pitch		10.16 mm		
Pol.	L1	(inch)	Qty.	Order No.
2	10.16	0.400	42	1813570000
3	20.32	0.800	36	1813580000
4	30.48	1.200	30	1813590000
5	40.64	1.600	24	1813600000
6	50.80	2.000	18	1813610000
7	60.96	2.400	18	1813620000
8	71.12	2.800	18	1813630000
9	81.28	3.200	12	1813640000

SU 10.16HP../90SF

Interlock flanges with nuts



Dimensioned drawing

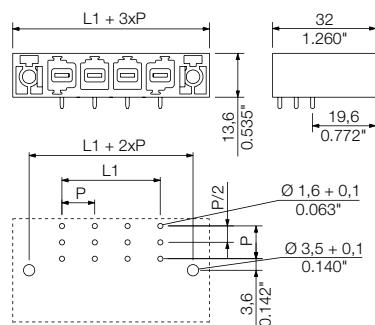

Ordering data

Solder pin length		3.5 mm		
Colour		black		
Pitch		10.16 mm		
Pol.	L1	(inch)	Qty.	Order No.
2	10.16	0.400	42	1851040000
3	20.32	0.800	36	1851050000
4	30.48	1.200	30	1851060000
5	40.64	1.600	24	1851070000
6	50.80	2.000	18	1851080000
7	60.96	2.400	18	1851090000
8	71.12	2.800	18	1851100000
9	81.28	3.200	12	1851110000

Connectors, pitch 10.16 mm
BU/SU 10.16 series - connection up to 16 mm²

SU 10.16HP../90MF

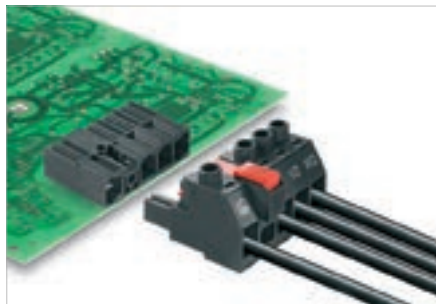

Male header in 90° outlet direction for TNC (S) systems. UL approved for 600 V in accordance with UL508 / UL840. The mating profile ensures touch-safety of more than 3 mm according to IEC 61800-5-1. Maximum operational reliability with a derating up to 125°C, a mating profile that can only be plugged in correct and unique coding capability.

- Available with a flange (F) and screw flange (SF).

Product data

IEC: 1000 V / 78.3 A
 UL: 300 V / 60 A



For additional articles and information, refer to catalog.weidmueller.com

Note:

- Additional variants on request
- Rated current related to rated cross-section & min. No. of poles.
- P on drawing = pitch
- Rated data refer only to the component itself. Clearance and creepage distances to other components are to be designed in accordance with the relevant application standards.
- For all applications with flange we recommend to fix the pin header with the help of the soldering flange or a self-tapping screw on the board.
- Long term storage of the product with average temperature of 50 °C and average humidity 70%, 36 months

SU 10.16HP../90MF2



Dimensioned drawing

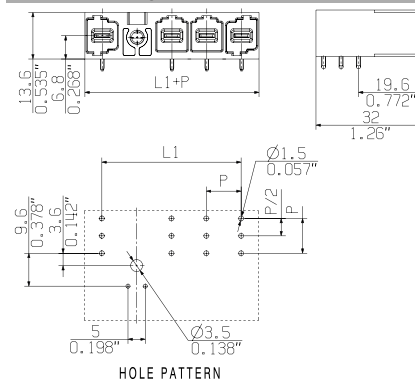

Ordering data

Solder pin length		3.5 mm		
Colour		black		
Pitch		10.16 mm		
Pol.	L1	(inch)	Qty.	Order No.
2	20.32	0.800	60	2580340000
3	30.48	1.200	42	2580390000
4	40.64	1.600	36	2580410000
5	50.80	2.000	30	2597200000
6	60.96	2.400	24	2597210000

Technical data

In compliance with IEC 60664-1 / IEC 61984			
Clamping range, max.			
Solid core H05(07) V-U			
Stranded H07 V-R			
Flexible H05(07) V-K			
Flexible with ferrule			
Ferrule with plastic collar			
Stripping length			
Screwdriver blade	mm		
According to norm			
Tightening torque range			
Rated current, max.	A	78.3	70.6
At ambient temperature		20°C	40°C
For conductor cross-section			
Overtoltage category		III	III II
Pollution severity		3	2 2
Rated voltage	V	690	1000 1000
Rated impulse voltage	kV	8	8 6
UL / CUL (Use Group)		B	C D
Rated voltage	V	300	300 600
Rated current	A	60	60 5
AWG conductor	AWG		-
CSA (Use Group)		B	C D
Rated voltage	V	300	300 600
Rated current	A	60	60 5
AWG conductor	AWG		-
General data			
Type of insulation material		PBT GF	
UL 94 flammability rating		V-0	
Contact base material		Copper alloy	
Material of contact surface			
Pin dimensions = d	mm	1.2 x 1.1	
Solder eyelet Ø = D	mm	1.6	
Solder eyelet Ø tolerance	mm	+ 0,1	

Accessories

Note: Refer to the Accessories chapter for additional accessories.

Coding	Order No.
KO BU/SU10.16HP BK	1824410000
KO BU/SU10.16HP WT	2592600000
Mounting screw	
SU 10.16 BFSC P 35X 14	2812340000
SU 10.16 BFSC S 35X12	2812290000

SU 10.16HP../90MF3



Dimensioned drawing

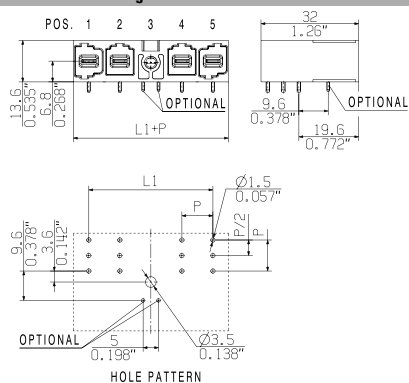

Ordering data

Solder pin length		3.5 mm	
Colour		black	
Pitch		10.16 mm	
Pol.	L1	(inch)	Qty. Order No.
3	30.48	1.200	42 2580400000
4	40.64	1.600	36 2580420000
5	50.80	2.000	30 2597220000
6	60.96	2.400	24 2597230000

SU 10.16HP../90MF4



Dimensioned drawing

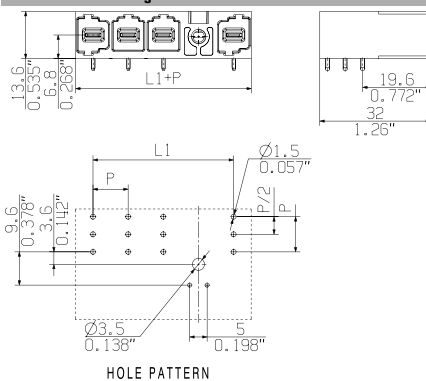

Ordering data

Solder pin length		3.5 mm	
Colour		black	
Pitch		10.16 mm	
Pol.	L1	(inch)	Qty. Order No.
4	40.64	1.600	36 2580430000
5	50.80	2.000	30 2597240000
6	60.96	2.400	24 2597250000

Connectors, pitch 10.16 mm
BU/SU 10.16 series - connection up to 16 mm²

SU 10.16HP../180



Male header with 180° outlet direction for TNC(S) systems. UL approval for 600 V in acc. with UL508-5-1 / UL840. The pin arrangement ensures more than 3 mm of touch-safety in acc. with IEC 61800-5-1.

Maximum connection and operating reliability thanks to: derating up to 125°C, pin arrangement that prevents wrong connections or incorrect wiring, unique coding diversity and integral positioning aid.

Variants: flange and screw flange fastening.

Product data

IEC: 1000 V / 78.3 A
 UL: 300 V / 60 A



For additional articles and information, refer to catalog.weidmuller.com

Note:

- Additional variants on request
- Rated current related to rated cross-section & min. No. of poles.
- P on drawing = pitch
- Rated data refer only to the component itself. Clearance and creepage distances to other components are to be designed in accordance with the relevant application standards.
- Long term storage of the product with average temperature of 50 °C and average humidity 70%, 36 months

SU 10.16HP../180G

without flanges



Dimensioned drawing

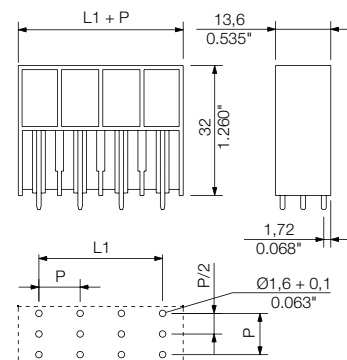

Technical data

In compliance with IEC 60664-1 / IEC 61984			
Clamping range, max.			
Solid core H05(07) V-U			
Stranded H07 V-R			
Flexible H05(07) V-K			
Flexible with ferrule			
Ferrule with plastic collar			
Stripping length			
Screwdriver blade	mm		
According to norm			
Tightening torque range			
Rated current, max.	A	78.3	70.6
At ambient temperature		20°C	40°C
For conductor cross-section			
Overtoltage category		III	III II
Pollution severity		3	2 2
Rated voltage	V	690	1000 1000
Rated impulse voltage	kV	8	8 6
UL / CUL (Use Group)		B	C D
Rated voltage	V	300	300 600
Rated current	A	60	60 5
AWG conductor	AWG		-
CSA (Use Group)		B	C D
Rated voltage	V	300	300 600
Rated current	A	60	60 5
AWG conductor	AWG		-
General data			
Type of insulation material		PBT GF	
UL 94 flammability rating		V-0	
Contact base material		Copper alloy	
Material of contact surface		silver-plated	
Pin dimensions = d	mm	1.2 x 1.1	
Solder eyelet Ø = D	mm	1.6	
Solder eyelet Ø tolerance	mm	+ 0,1	

Accessories

Note: Refer to the Accessories chapter for additional accessories.

Protection against twisting		Order No.
	VDS180 SV7.62	1853940000
Coding		
	KO BU/SU10.16HP BK	1824410000
	KO BU/SU10.16HP WT	2592600000
Mounting screw		
	SU 10.16 BFSC P 35X 14	2812340000
	SU 10.16 BFSC S 35X12	2812290000

Ordering data

Solder pin length		3.5 mm		
Colour		black		
Pitch		10.16 mm		
Pol.	L1	(inch)	Qty.	Order No.
2	10.16	0.400	90	1813410000
3	20.32	0.800	60	1813420000
4	30.48	1.200	42	1813430000
5	40.64	1.600	36	1813440000
6	50.80	2.000	30	1813450000
7	60.96	2.400	24	1813460000
8	71.12	2.800	18	1813470000
9	81.28	3.200	18	1813480000

SU 10.16HP../180F

Interlock flanges



Dimensioned drawing

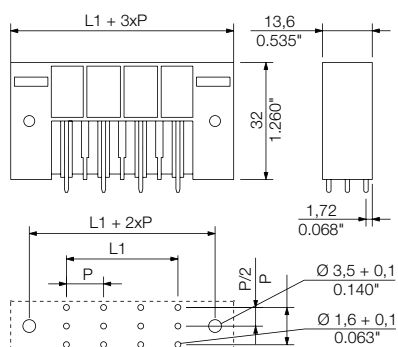

Ordering data

Solder pin length		3.5 mm		
Colour		black		
Pitch		10.16 mm		
Pol.	L1	(inch)	Qty.	Order No.
2	10.16	0.400	42	1813650000
3	20.32	0.800	36	1813660000
4	30.48	1.200	30	1813670000
5	40.64	1.600	24	1813680000
6	50.80	2.000	18	1813690000
7	60.96	2.400	18	1813700000
8	71.12	2.800	18	1813710000
9	81.28	3.200	12	1813720000

SU 10.16HP../180SF

Interlock flanges with nuts



Dimensioned drawing

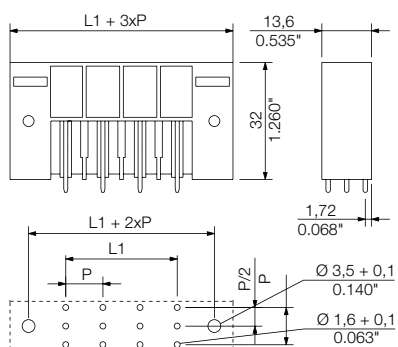

Ordering data

Solder pin length		3.5 mm		
Colour		black		
Pitch		10.16 mm		
Pol.	L1	(inch)	Qty.	Order No.
2	10.16	0.400	42	1850880000
3	20.32	0.800	36	1850890000
4	30.48	1.200	30	1850900000
5	40.64	1.600	24	1850910000
6	50.80	2.000	18	1850920000
7	60.96	2.400	18	1850930000
8	71.12	2.800	18	1850940000
9	81.28	3.200	12	1850950000

Connectors, pitch 10.16 mm
BU/SU 10.16 series - connection up to 16 mm²

SU 10.16HP../270

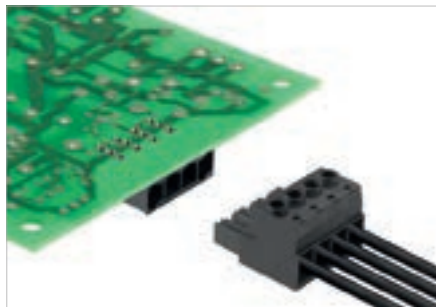

Male header with 270° outlet direction for TNC(S) systems. UL approval for 600 V in acc. with UL508-5-1 / UL840. The pin arrangement ensures more than 3 mm of touch-safety in acc. with IEC 61800-5-1.

Maximum connection and operating reliability thanks to: derating up to 125°C, pin arrangement that prevents wrong connections or incorrect wiring, and unique coding diversity.

Variants: flange and screw flange fastening.

Product data

IEC: 1000 V / 78.3 A
 UL: 300 V / 60 A



For additional articles and information, refer to catalog.weidmuller.com

Note:

- Additional variants on request
- Rated current related to rated cross-section & min. No. of poles.
- P on drawing = pitch
- Rated data refer only to the component itself. Clearance and creepage distances to other components are to be designed in accordance with the relevant application standards.
- Long term storage of the product with average temperature of 50 °C and average humidity 70%, 36 months

SU 10.16HP../270G

without flanges



Dimensioned drawing

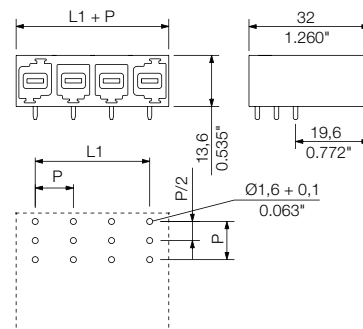

Technical data

In compliance with IEC 60664-1 / IEC 61984			
Clamping range, max.			
Solid core H05(07) V-U			
Stranded H07 V-R			
Flexible H05(07) V-K			
Flexible with ferrule			
Ferrule with plastic collar			
Stripping length			
Screwdriver blade	mm		
According to norm			
Tightening torque range			
Rated current, max.	A	78.3	70.6
At ambient temperature		20°C	40°C
For conductor cross-section			
Overtoltage category		III	III II
Pollution severity		3	2 2
Rated voltage	V	690	1000 1000
Rated impulse voltage	kV	8	8 6
UL / CUL (Use Group)		B	C D
Rated voltage	V	300	300 600
Rated current	A	60	60 5
AWG conductor	AWG		-
CSA (Use Group)		B	C D
Rated voltage	V	300	300 600
Rated current	A	60	60 5
AWG conductor	AWG		-
General data			
Type of insulation material		PBT GF	
UL 94 flammability rating		V-0	
Contact base material		Copper alloy	
Material of contact surface		silver-plated	
Pin dimensions = d	mm	1.2 x 1.1	
Solder eyelet Ø = D	mm	1.6	
Solder eyelet Ø tolerance	mm	+ 0,1	

Accessories

Note: Refer to the Accessories chapter for additional accessories.

Coding	Order No.
KO BU/SU10.16HP BK	1824410000
KO BU/SU10.16HP WT	2592600000
Mounting screw	
SU 10.16 BFSC P 35X 14	2812340000
SU 10.16 BFSC S 35X12	2812290000

Ordering data

Solder pin length		3.5 mm		
Colour		black		
Pitch		10.16 mm		
Pol.	L1	(inch)	Qty.	Order No.
2	10.16	0.400	90	1813490000
3	20.32	0.800	60	1813500000
4	30.48	1.200	42	1813510000
5	40.64	1.600	36	1813520000
6	50.80	2.000	30	1813530000
7	60.96	2.400	24	1813540000
8	71.12	2.800	18	1813550000
9	81.28	3.200	18	1813560000

SU 10.16HP/./270F

Interlock flanges

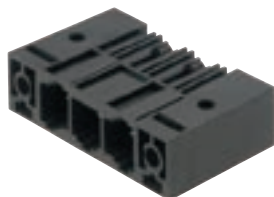

Dimensioned drawing

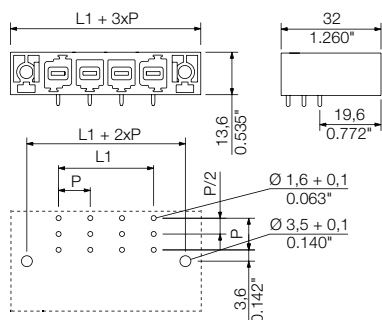

Ordering data

Solder pin length		3.5 mm		
Colour		black		
Pitch		10.16 mm		
Pol.	L1	(inch)	Qty.	Order No.
2	10.16	0.400	42	1813730000
3	20.32	0.800	36	1813740000
4	30.48	1.200	30	1813750000
5	40.64	1.600	24	1813760000
6	50.80	2.000	18	1813770000
7	60.96	2.400	18	1813780000
8	71.12	2.800	18	1813790000
9	81.28	3.200	12	1813800000

SU 10.16HP/./270SF

Interlock flanges with nuts

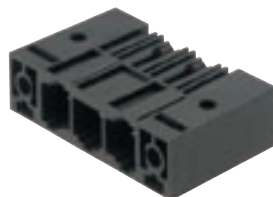

Dimensioned drawing

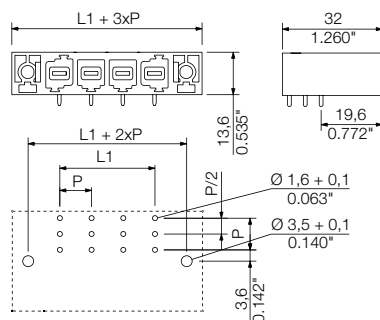

Ordering data

Solder pin length		3.5 mm		
Colour		black		
Pitch		10.16 mm		
Pol.	L1	(inch)	Qty.	Order No.
2	10.16	0.400	42	1851120000
3	20.32	0.800	36	1851130000
4	30.48	1.200	30	1851140000
5	40.64	1.600	24	1851150000
6	50.80	2.000	18	1851160000
7	60.96	2.400	18	1851170000
8	71.12	2.800	18	1851180000
9	81.28	3.200	12	1851190000

Connectors, pitch 10.16 mm
BU/SU 10.16 series - connection up to 16 mm²

SU 10.16HP../270MF

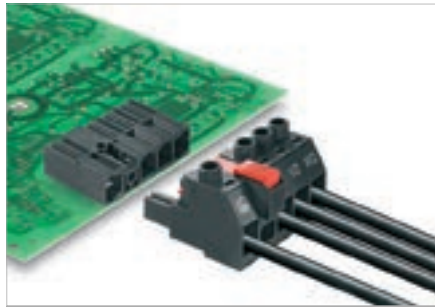

Male header with 270° outlet direction for TNC(S) systems. UL approval for 600 V in acc. with UL508-5-1 / UL840. The pin arrangement ensures more than 3 mm of touch-safety in acc. with IEC 61800-5-1.

Maximum connection and operating reliability thanks to: derating up to 125°C, pin arrangement that prevents wrong connections or incorrect wiring, and unique coding diversity.

Variants: flange and screw flange fastening.

Product data

IEC: 1000 V / 78.3 A
 UL: 300 V / 60 A



For additional articles and information, refer to catalog.weidmueller.com

Note:

- Additional variants on request
- Rated current related to rated cross-section & min. No. of poles.
- P on drawing = pitch
- Rated data refer only to the component itself. Clearance and creepage distances to other components are to be designed in accordance with the relevant application standards.
- For all applications with flange we recommend to fix the pin header with the help of the soldering flange or a self-tapping screw on the board.
- Long term storage of the product with average temperature of 50 °C and average humidity 70%, 36 months

SU 10.16HP../270MF2



Dimensioned drawing

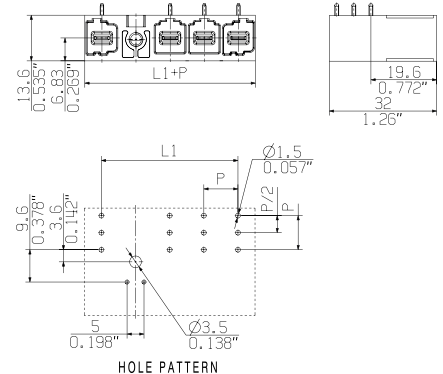

Technical data

In compliance with IEC 60664-1 / IEC 61984

Clamping range, max.			
Solid core H05(07) V-U			
Stranded H07 V-R			
Flexible H05(07) V-K			
Flexible with ferrule			
Ferrule with plastic collar			
Stripping length			
Screwdriver blade	mm		
According to norm			
Tightening torque range			
Rated current, max.	A	78.3	70.6
At ambient temperature		20°C	40°C
For conductor cross-section			
Overvoltage category		III	III II
Pollution severity		3	2 2
Rated voltage	V	690	1000 1000
Rated impulse voltage	kV	8	8 6
UL / CUL (Use Group)		B	C D
Rated voltage	V	300	300 600
Rated current	A	60	60 5
AWG conductor	AWG		-
CSA (Use Group)		B	C D
Rated voltage	V	300	300 600
Rated current	A	60	60 5
AWG conductor	AWG		-
General data			
Type of insulation material			
UL 94 flammability rating			
Contact base material			
Material of contact surface			
Pin dimensions = d	mm	1.2	1.1
Solder eyelet Ø = D			
Solder eyelet Ø tolerance	mm		

Accessories

Note: Refer to the Accessories chapter for additional accessories.

Coding	Order No.
KO BU/SU10.16HP BK	1824410000
KO BU/SU10.16HP WT	2592600000
Mounting screw	
SU 10.16 BFSC P 35X 14	2812340000
SU 10.16 BFSC S 35X12	2812290000

Ordering data

Solder pin length	3.5 mm			
Colour	black			
Pitch	10.16 mm			
Pol.	L1	(inch)	Qty.	Order No.
2	10.16	0.400	60	2580350000
3	20.32	0.800	42	2580830000
4	30.48	1.200	36	2580860000
5	40.64	1.600	30	2597290000
6	50.80	2.000	24	2597300000

SU 10.16HP../270MF3



Dimensioned drawing

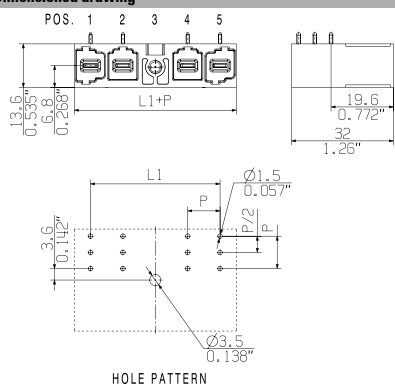

Ordering data

Solder pin length		3.5 mm	
Colour		black	
Pitch		10.16 mm	
Pol.	L1	(inch)	Qty. Order No.
3	20.32	0.800	42 2580850000
4	30.48	1.200	36 2580870000
5	40.64	1.600	30 2597310000
6	50.80	2.000	24 2597320000

SU 10.16HP../270MF4



Dimensioned drawing

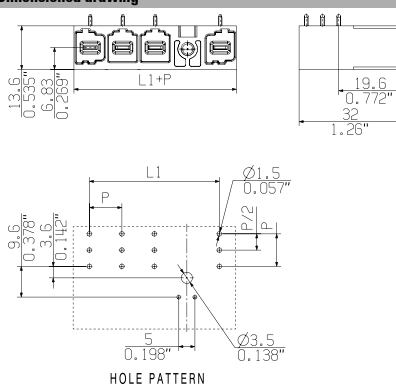

Ordering data

Solder pin length		3.5 mm	
Colour		black	
Pitch		10.16 mm	
Pol.	L1	(inch)	Qty. Order No.
4	30.48	1.200	36 2580880000
5	40.64	1.600	30 2597330000
6	50.80	2.000	24 2597340000

Connectors, pitch 10.16 mm
BU/SU 10.16 series - connection up to 16 mm²

SUZ 10.16HP../180



Male plug in 180° outlet direction with clamping yoke screw connection for TNC (S) systems. Meets the requirements of UL1059 for 600 V Use Group C. The mating profile ensures touch safety of more than 3 mm according to IEC 61800-5-1 when connected.

Maximum operational reliability with a derating up to 125°C, a mating profile that can only be plugged in correct and unique coding capability.

- Available with a flange (F) and screw flange on request.

Technical data

In compliance with IEC 60664-1 / IEC 61984			
Clamping range, max.	mm ²	0.2...16	
Solid core H05(07) V-U	mm²	0.2...16	
Stranded H07 V-R		...16	
Flexible H05(07) V-K	mm ²	0.5...16	
Flexible with ferrule	mm ²	0.25...16	
Ferrule with plastic collar	mm ²	0.25...10	
Stripping length	mm	12	
Screwdriver blade	mm	1.0 x 5.5	
According to norm		DIN 5264	
Tightening torque range	Nm	1.2...1.5	
Rated current, max.	A	78	72
At ambient temperature		20°C	40°C
For conductor cross-section	mm ²	16	
Overvoltage category		III	III II
Pollution severity		3	2 2
Rated voltage	V	1000	1000 1000
Rated impulse voltage	kV	8	8 6
UL / CUL (Use Group)	B C D	B	C D
Rated voltage	V	600	600 600
Rated current	A	57	57 5
AWG conductor	AWG	24-6	
CSA (Use Group)	B C D	B	C D
Rated voltage	V	600	600 600
Rated current	A	57	57 5
AWG conductor	AWG	24-6	
General data			
Type of insulation material		PA GF	
UL 94 flammability rating		V-0	
Contact base material		Copper alloy	
Material of contact surface		silver-plated	
Pin dimensions = d	mm		
Solder eyelet Ø = D	mm		
Solder eyelet Ø tolerance	mm		

Product data

IEC: 1000 V / 78 A / 0.2 - 16 mm²
 UL: 600 V / 57 A / AWG 24 - 6



For additional articles and information, refer to catalog.weidmueller.com

Note:

- Additional variants on request
- Rated current related to rated cross-section & min. No. of poles.
- Wire end ferrule without plastic collar to DIN 46228/1
- Wire end ferrule with plastic collar to DIN 46228/4
- P on drawing = pitch
- Rated data refer only to the component itself. Clearance and creepage distances to other components are to be designed in accordance with the relevant application standards.
- Long term storage of the product with average temperature of 50 °C and average humidity 70%, 36 months

SUZ 10.16HP../180G



Dimensioned drawing

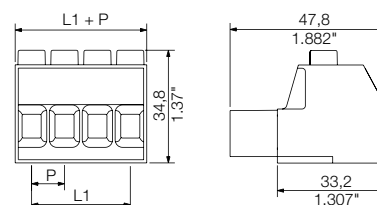

Accessories

Note: Refer to the Accessories chapter for additional accessories.

Coding	Order No.
KO BU/SU10.16HP BK	1824410000
KO BU/SU10.16HP WT	2592600000
Screwdriver	
SDIS 1.0X5.5X125	2749850000
Crosshead screwdriver	
SDIK PZ2 X 100	2749930000
SDK PZ2 X 100	2749450000

Ordering data

Solder pin length				
Colour	black			
Pitch	10.16 mm			
Pol.	L1	(inch)	Qty.	Order No.
2	10.16	0.400	64	1947480000
3	20.32	0.800	44	1947490000
4	30.48	1.200	32	1947500000
5	40.64	1.600	26	1947510000
6	50.80	2.000	22	1966920000
7	60.96	2.400	18	1966930000
8	71.12	2.800	16	1962400000
9	81.28	3.200	14	1966910000

Representative deratings curve

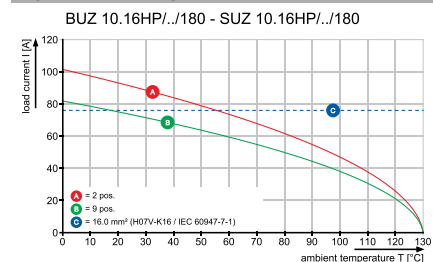

Connectors, pitch 10.16 mm
BU/SU 10.16 series - connection up to 16 mm²

BUZ 10.16HP/./180



Female plug in 180° outlet direction with clamping yoke screw connection for TNC (S) systems. Meets the requirements of UL1059 for 600 V Use Group C. Ensures touch-safety of

> 3 mm in accordance with IEC 61800-5-1.

Maximum operational reliability with a derating up to 125°C, a mating profile that can only be plugged in correct and unique coding capability.

- Available with a flange (F) and screw flange (SF).

Product data

IEC: 1000 V / 78.3 A / 0.2 - 16 mm²
 UL: 600 V / 60 A / AWG 22 - 4



For additional articles and information, refer to catalog.weidmueller.com

Note:

- Additional variants on request
- Rated current related to rated cross-section & min. No. of poles.
- Wire end ferrule with plastic collar to DIN 46228/4
- Wire end ferrule without plastic collar to DIN 46228/1
- P on drawing = pitch
- Rated data refer only to the component itself. Clearance and creepage distances to other components are to be designed in accordance with the relevant application standards.
- Long term storage of the product with average temperature of 50 °C and average humidity 70%, 36 months

BUZ 10.16HP/./180



Dimensioned drawing

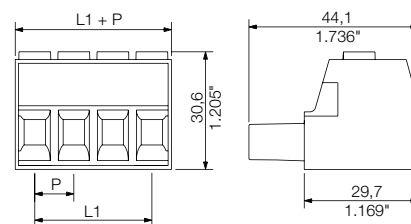

Technical data

In compliance with IEC 60664-1 / IEC 61984			
Clamping range, max.	mm ²	0.2...16	
Solid core H05(07) V-U	mm²	0.2...16	
Stranded H07 V-R		...16	
Flexible H05(07) V-K	mm ²	0.5...16	
Flexible with ferrule	mm ²	0.25...16	
Ferrule with plastic collar	mm ²	0.25...16	
Stripping length	mm	12	
Screwdriver blade	mm	1.0 x 5.5	
According to norm		DIN 5264	
Tightening torque range	Nm	1.2...1.5	
Rated current, max.	A	78.3	70.6
At ambient temperature		20°C	40°C
For conductor cross-section	mm ²	16	
Overvoltage category		III	III II
Pollution severity		3	2 2
Rated voltage	V	1000	1000 1000
Rated impulse voltage	kV	8	8 6
UL / CUL (Use Group)	B C D	B C D	B C D
Rated voltage	V	600	600 600
Rated current	A	60	60 5
AWG conductor	AWG	22-4	
CSA (Use Group)	B C D	B C D	B C D
Rated voltage	V	600	600 600
Rated current	A	60	60 5
AWG conductor	AWG	22-4	
General data			
Type of insulation material		PA GF	
UL 94 flammability rating		V-0	
Contact base material		Copper alloy	
Material of contact surface		silver-plated	
Pin dimensions = d	mm		
Solder eyelet Ø = D	mm		
Solder eyelet Ø tolerance	mm		

Accessories

Note: Refer to the Accessories chapter for additional accessories.

Coding	Order No.
KO BU/SU10.16HP BK	1824410000
KO BU/SU10.16HP WT	2592600000
Screwdriver	
SDIS 1.0X5.5X125	2749850000
Crosshead screwdriver	
SDIK PZ2 X 100	2749930000
SDK PZ2 X 100	2749450000

Ordering data

Solder pin length				
Colour	black			
Pitch	10.16 mm			
Pol.	L1	(inch)	Qty.	Order No.
2	10.16	0.400	60	1924540000
3	20.32	0.800	40	1924550000
4	30.48	1.200	28	1924560000
5	40.64	1.600	24	1924570000
6	50.80	2.000	20	1924580000
7	60.96	2.400	16	1924590000
8	71.12	2.800	12	1924600000
9	81.28	3.200	12	1924610000

Representative deratings curve

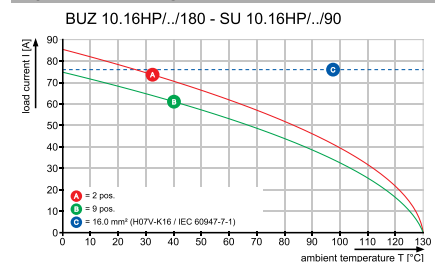

BUZ 10.16HP../180F



Dimensioned drawing

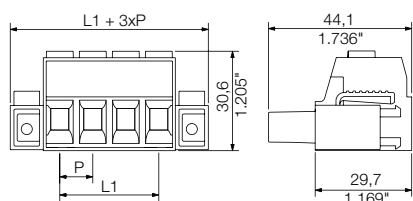

BUZ 10.16HP../180SF



Dimensioned drawing

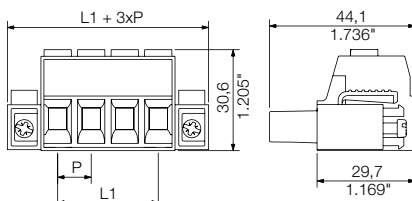

Ordering data

Solder pin length					
Colour					black
Pitch 10.16 mm					
Pol.	L1	(inch)	Qty.	Order No.	
2	10.16	0.400	28	1924620000	
3	20.32	0.800	24	1924630000	
4	30.48	1.200	20	1924640000	
5	40.64	1.600	16	1924650000	
6	50.80	2.000	12	1924660000	
7	60.96	2.400	12	1924670000	
8	71.12	2.800	12	1924680000	
9	81.28	3.200	8	1924690000	

Ordering data

Solder pin length					
Colour					black
Pitch 10.16 mm					
Pol.	L1	(inch)	Qty.	Order No.	
2	10.16	0.400	28	1924700000	
3	20.32	0.800	24	1924710000	
4	30.48	1.200	20	1924720000	
5	40.64	1.600	16	1924740000	
6	50.80	2.000	12	1924750000	
7	60.96	2.400	12	1924760000	
8	71.12	2.800	12	1924770000	
9	81.28	3.200	8	1924780000	

Additional deratings curves

BUZ 10.16HP../180 - SU 10.16HP../180

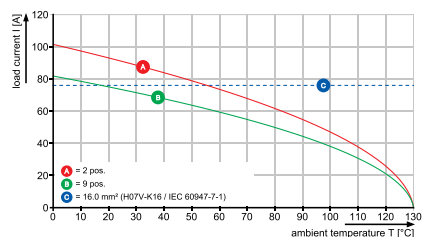

BUZ 10.16HP../180 - SUZ 10.16HP../180

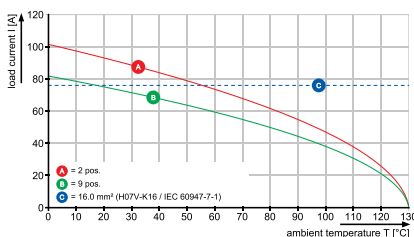

Connectors, pitch 10.16 mm
BU/SU 10.16 series - connection up to 16 mm²

BUF 10.16IT../180MF SH

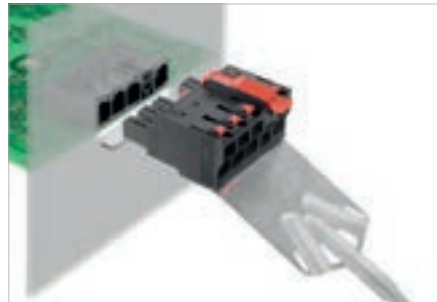

PUSH IN female plug with 180° outlet direction for IT power networks. Meets the requirements of UL1059 for 600 V Use Group C. Leading PE contact in combination with the male header SU 7.62 IT. Meets the enhanced requirements for 5.5 mm of touch safety on IT power networks in acc. with IEC 61800-5-1 for 400 V relative to earth. The self-locking middle flange which can also be optionally screwed, reduces the space requirements by one pitch width compared to conventional solutions.

The pluggable shield connection has a wide contact area on the device housing and does not need to be bolted.

Technical data

In compliance with IEC 60664-1 / IEC 61984

Clamping range, max.	mm ²	2.5...16
Solid core H05(07) V-U	mm²	2.5...10
Stranded H07 V-R		
Flexible H05(07) V-K	mm ²	2.5...16
Flexible with ferrule	mm ²	2.5...16
Ferrule with plastic collar	mm ²	2.5...16
Stripping length	mm	18
Screwdriver blade	mm	0.8 x 4.0
According to norm		DIN 5264

Tightening torque range

Rated current, max.	A	76	70
At ambient temperature		20°C	40°C
For conductor cross-section	mm ²	16	
Overvoltage category		III	III
Pollution severity		3	2

Rated voltage	V	1000	1000	1000
Rated impulse voltage	kV	8	8	8

UL / CUL (Use Group)	B	C	D
-----------------------------	----------	----------	----------

Rated voltage	V	600	600
----------------------	----------	------------	------------

Rated current	A	34	34
----------------------	----------	-----------	-----------

AWG conductor	AWG	12-6
----------------------	------------	-------------

CSA (Use Group)	B	C	D
------------------------	----------	----------	----------

Rated voltage	V	
---------------	---	--

Rated current	A	
---------------	---	--

AWG conductor	AWG	-
---------------	-----	---

General data

Type of insulation material	PA GF
-----------------------------	-------

UL 94 flammability rating	V-0
---------------------------	-----

Contact base material	Copper alloy
-----------------------	--------------

Material of contact surface	
-----------------------------	--

Pin dimensions = d	mm
--------------------	----

Solder eyelet Ø = D	mm
---------------------	----

Solder eyelet Ø tolerance	mm
---------------------------	----

Product data

IEC: 1000 V / 76 A / 2.5 - 16 mm²
 UL: 600 V / 34 A / AWG 12 - 6



For additional articles and information, refer to catalog.weidmueller.com

Note:

- Additional variants on request
- Rated current related to rated cross-section & min. No. of poles.
- Wire end ferrule with plastic collar to DIN 46228/4
- Wire end ferrule without plastic collar to DIN 46228/1
- P on drawing = pitch
- Rated data refer only to the component itself. Clearance and creepage distances to other components are to be designed in accordance with the relevant application standards.
- For all applications with flange we recommend to fix the pin header with the help of the soldering flange or a self-tapping screw on the board.
- Long term storage of the product with average temperature of 50 °C and average humidity 70%, 36 months

BUF 10.16IT../180MF2 SH160



Dimensioned drawing

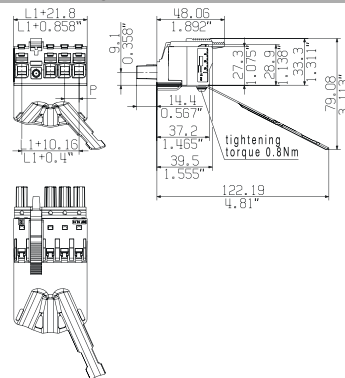

BUF 10.16IT../180MF2 SH180



BUF 10.16IT../180MF2 SH200



Dimensioned drawing

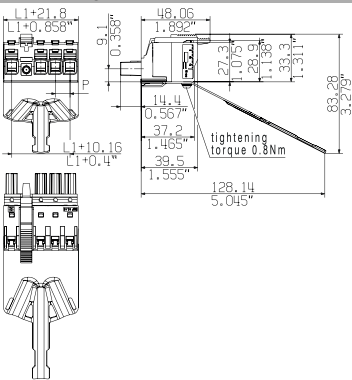

Ordering data

Solder pin length					
Colour					black
Pitch 10.16 mm					
Pol.	L1	(inch)	Qty.	Order No.	
3	30.48	1.200	20	2627710000	
4	40.64	1.600	20	2627720000	



Dimensioned drawing

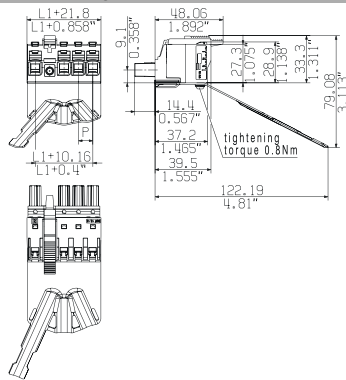

Ordering data

Solder pin length					
Colour					black
Pitch 10.16 mm					
Pol.	L1	(inch)	Qty.	Order No.	
3	30.48	1.200	20	2627760000	
4	40.64	1.600	20	2627770000	

Additional deratings curves

BUF 10.16IT../180 - SU 10.16HP../90

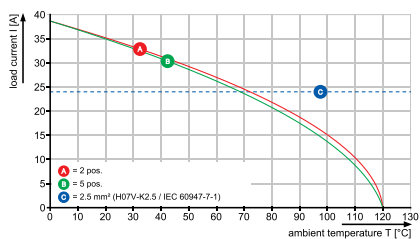

Connectors, pitch 10.16 mm
BU/SU 10.16 series - connection up to 16 mm²

BUF 10.16IT../180MF SH

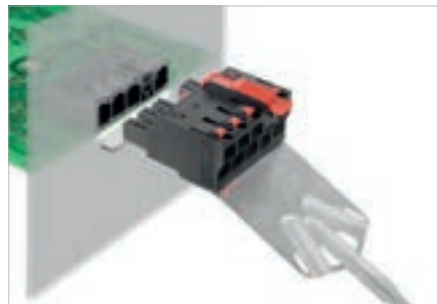

PUSH IN female plug with 180° outlet direction for IT power networks. Meets the requirements of UL1059 for 600 V Use Group C. Leading PE contact in combination with the male header SU 7.62 IT. Meets the enhanced requirements for 5.5 mm of touch safety on IT power networks in acc. with IEC 61800-5-1 for 400 V relative to earth. The self-locking middle flange which can also be optionally screwed, reduces the space requirements by one pitch width compared to conventional solutions.

The pluggable shield connection has a wide contact area on the device housing and does not need to be bolted.

Technical data

In compliance with IEC 60664-1 / IEC 61984			
Clamping range, max.	mm ²	2.5...16	
Solid core H05(07) V-U	mm²	2.5...10	
Stranded H07 V-R			
Flexible H05(07) V-K	mm ²	2.5...16	
Flexible with ferrule	mm ²	2.5...16	
Ferrule with plastic collar	mm ²	2.5...16	
Stripping length	mm	18	
Screwdriver blade	mm	0.8 x 4.0	
According to norm			DIN 5264
Tightening torque range			
Rated current, max.	A	76	70
At ambient temperature		20°C	40°C
For conductor cross-section	mm ²	16	
Overvoltage category		III	III II
Pollution severity		3	2 2
Rated voltage	V	1000	1000 1000
Rated impulse voltage	kV	8	8 8
UL / CUL (Use Group)	B C D	B C D	B C D
Rated voltage	V	600	600
Rated current	A	34	34
AWG conductor	AWG	12-6	
CSA (Use Group)	B C D	B C D	B C D
Rated voltage	V		
Rated current	A		
AWG conductor	AWG		
General data			
Type of insulation material		PA GF	
UL 94 flammability rating		V-0	
Contact base material		Copper alloy	
Material of contact surface			
Pin dimensions = d	mm		
Solder eyelet Ø = D	mm		
Solder eyelet Ø tolerance	mm		

Product data

IEC: 1000 V / 76 A / 2.5 - 16 mm²
 UL: 600 V / 34 A / AWG 12 - 6



For additional articles and information, refer to catalog.weidmueller.com

Note:

- Additional variants on request
- Rated current related to rated cross-section & min. No. of poles.
- Wire end ferrule with plastic collar to DIN 46228/4
- Wire end ferrule without plastic collar to DIN 46228/1
- P on drawing = pitch
- Rated data refer only to the component itself. Clearance and creepage distances to other components are to be designed in accordance with the relevant application standards.
- For all applications with flange we recommend to fix the pin header with the help of the soldering flange or a self-tapping screw on the board.
- Long term storage of the product with average temperature of 50 °C and average humidity 70%, 36 months

BUF 10.16IT../180MF3 SH160



Dimensioned drawing

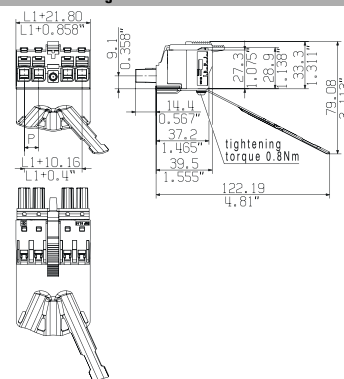

Accessories

Note: Refer to the Accessories chapter for additional accessories.

Coding	Order No.
KO BU/SU10.16HP BK	1824410000
KO BU/SU10.16HP WT	2592600000
Screwdriver	
SDS 0.8X4.5X125	2749370000

Ordering data

Solder pin length				
Colour	black			
Pitch	10.16 mm			
Pol.	L1	(inch)	Qty.	Order No.
3	30.48	1.200	20	2627690000
4	40.64	1.600	20	2627700000

Representative dimensional drawing

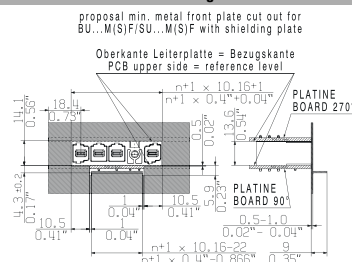

Representative deratings curve

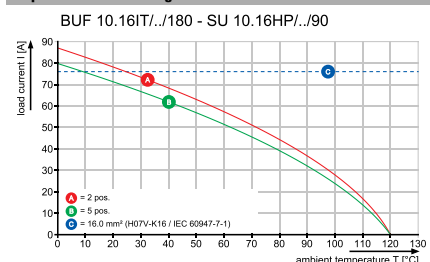

BUF 10.16IT../180MF3 SH180



Dimensioned drawing

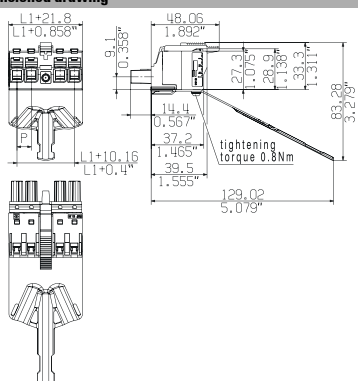

Ordering data

Solder pin length					
Colour					black
Pitch 10.16 mm					
Pol.	L1	(inch)	Qty.	Order No.	
3	30.48	1.200	20	2627730000	
4	40.64	1.600	20	2627740000	

BUF 10.16IT../180MF3 SH200



Dimensioned drawing

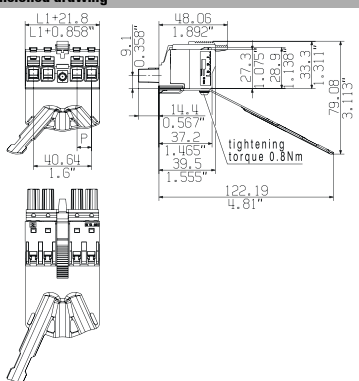

Ordering data

Solder pin length					
Colour					black
Pitch 10.16 mm					
Pol.	L1	(inch)	Qty.	Order No.	
3	30.48	1.200	20	2627780000	
4	40.64	1.600	20	2627790000	

Additional deratings curves

BUF 10.16IT../180 - SU 10.16HP../90

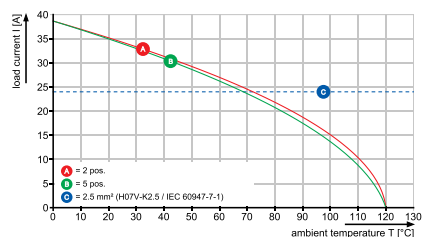

Connectors, pitch 10.16 mm
BU/SU 10.16 series - connection up to 16 mm²

BUF 10.16IT../180MF SH

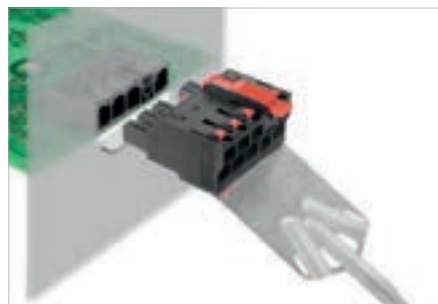

PUSH IN female plug with 180° outlet direction for IT power networks. Meets the requirements of UL1059 for 600 V Use Group C. Leading PE contact in combination with the male header SU 7.62 IT. Meets the enhanced requirements for 5.5 mm of touch safety on IT power networks in acc. with IEC 61800-5-1 for 400 V relative to earth. The self-locking middle flange which can also be optionally screwed, reduces the space requirements by one pitch width compared to conventional solutions.

The pluggable shield connection has a wide contact area on the device housing and does not need to be bolted.

Technical data

In compliance with IEC 60664-1 / IEC 61984			
Clamping range, max.	mm ²	2.5...16	
Solid core H05(07) V-U	mm²	2.5...10	
Stranded H07 V-R			
Flexible H05(07) V-K	mm ²	2.5...16	
Flexible with ferrule	mm ²	2.5...16	
Ferrule with plastic collar	mm ²	2.5...16	
Stripping length	mm	18	
Screwdriver blade	mm	0.8 x 4.0	
According to norm		DIN 5264	
Tightening torque range			
Rated current, max.	A	76	70
At ambient temperature		20°C	40°C
For conductor cross-section	mm ²	16	
Overvoltage category		III	III II
Pollution severity		3	2 2
Rated voltage	V	1000	1000 1000
Rated impulse voltage	kV	8	8 8
UL / CUL (Use Group)	B C D	B	C D
Rated voltage	V	600	600
Rated current	A	34	34
AWG conductor	AWG	12-6	
CSA (Use Group)	B C D	B	C D
Rated voltage	V		
Rated current	A		
AWG conductor	AWG		
General data			
Type of insulation material		PA GF	
UL 94 flammability rating		V-0	
Contact base material		Copper alloy	
Material of contact surface			
Pin dimensions = d	mm		
Solder eyelet Ø = D	mm		
Solder eyelet Ø tolerance	mm		

Product data

IEC: 1000 V / 76 A / 2.5 - 16 mm²
 UL: 600 V / 34 A / AWG 12 - 6



For additional articles and information, refer to catalog.weidmueller.com

Note:

- Additional variants on request
- Rated current related to rated cross-section & min. No. of poles.
- Wire end ferrule with plastic collar to DIN 46228/4
- Wire end ferrule without plastic collar to DIN 46228/1
- P on drawing = pitch
- Rated data refer only to the component itself. Clearance and creepage distances to other components are to be designed in accordance with the relevant application standards.
- For all applications with flange we recommend to fix the pin header with the help of the soldering flange or a self-tapping screw on the board.
- Long term storage of the product with average temperature of 50 °C and average humidity 70%, 36 months

BUF 10.16IT../180MF4 SH160



Dimensioned drawing

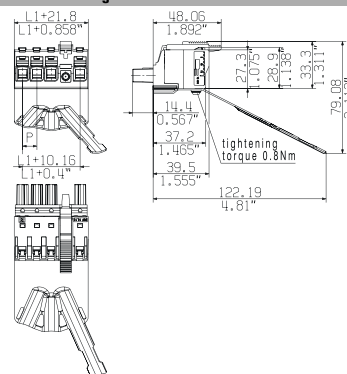

Accessories

Note: Refer to the Accessories chapter for additional accessories.

Coding	Order No.
KO BU/SU10.16HP BK	1824410000
KO BU/SU10.16HP WT	2592600000
Screwdriver	
SDS 0.8X4.5X125	2749370000

Ordering data

Solder pin length				
Colour				
Pitch 10.16 mm				
Pol.	L1	(inch)	Qty.	Order No.
4			20	2638870000

Representative dimensional drawing

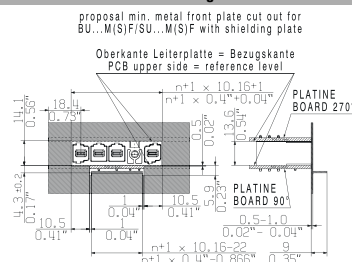

Representative deratings curve

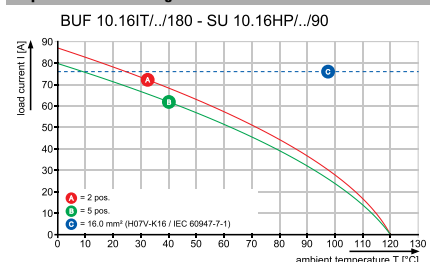

BUF 10.16IT../180MF4 SH180



Dimensioned drawing

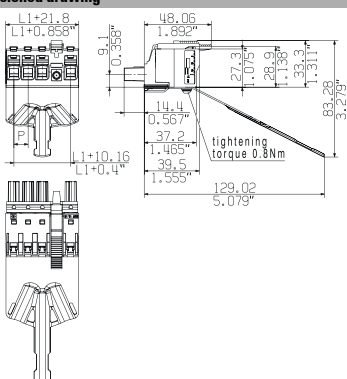

Ordering data

Solder pin length				
Colour	black			
Pitch	10.16 mm			
Pol.	L1	(inch)	Qty.	Order No.
4	40.64	1.600	20	2627750000

BUF 10.16IT../180MF4 SH200



Dimensioned drawing

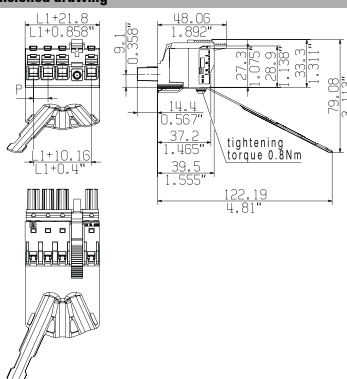

Ordering data

Solder pin length				
Colour	black			
Pitch	10.16 mm			
Pol.	L1	(inch)	Qty.	Order No.
4	40.64	1.600	20	2627800000

Additional deratings curves

BUF 10.16IT../180 - SU 10.16HP../90

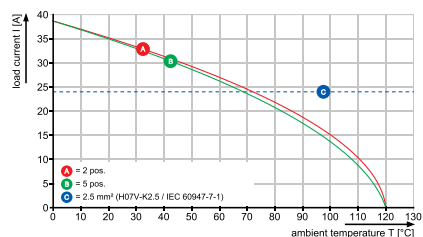

Connectors, pitch 10.16 mm
BU/SU 10.16 series - connection up to 16 mm²

BUF 10.16IT../180MSF SH

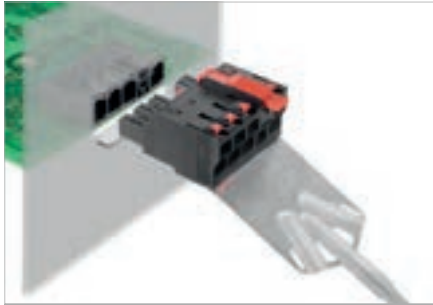

PUSH IN female plug with 180° outlet direction for IT power networks. Meets the requirements of UL1059 for 600 V Use Group C. Leading PE contact in combination with the male header SU 7.62 IT. Meets the enhanced requirements for 5.5 mm of touch safety on IT power networks in acc. with IEC 61800-5-1 for 400 V relative to earth. The self-locking middle flange which can also be optionally screwed, reduces the space requirements by one pitch width compared to conventional solutions.

The pluggable shield connection has a wide contact area on the device housing and does not need to be bolted.

Technical data

In compliance with IEC 60664-1 / IEC 61984			
Clamping range, max.	mm ²	2.5...16	
Solid core H05(07) V-U	mm²	2.5...10	
Stranded H07 V-R		...16	
Flexible H05(07) V-K	mm ²	2.5...16	
Flexible with ferrule	mm ²	2.5...16	
Ferrule with plastic collar	mm ²	2.5...16	
Stripping length	mm	18	
Screwdriver blade	mm	0.8 x 4.0	
According to norm		DIN 5264	
Tightening torque range			
Rated current, max.	A	76	70
At ambient temperature		20°C	40°C
For conductor cross-section	mm ²	16	
Overvoltage category		III	III II
Pollution severity		3	2 2
Rated voltage	V	1000	1000 1000
Rated impulse voltage	kV	8	8 8
UL / CUL (Use Group)	B C D	B C D	B C D
Rated voltage	V	600	600
Rated current	A	34	34
AWG conductor	AWG	12-6	
CSA (Use Group)	B C D	B C D	B C D
Rated voltage	V		
Rated current	A		
AWG conductor	AWG		
General data			
Type of insulation material		PA GF	
UL 94 flammability rating		V-0	
Contact base material		Copper alloy	
Material of contact surface			
Pin dimensions = d	mm		
Solder eyelet Ø = D	mm		
Solder eyelet Ø tolerance	mm		

Product data

IEC: 1000 V / 76 A / 2.5 - 16 mm²
 UL: 600 V / 34 A / AWG 12 - 6



For additional articles and information, refer to catalog.weidmueller.com

Note:

- Additional variants on request
- Rated current related to rated cross-section & min. No. of poles.
- Wire end ferrule with plastic collar to DIN 46228/4
- Wire end ferrule without plastic collar to DIN 46228/1
- P on drawing = pitch
- Rated data refer only to the component itself. Clearance and creepage distances to other components are to be designed in accordance with the relevant application standards.
- For all applications with flange we recommend to fix the pin header with the help of the soldering flange or a self-tapping screw on the board.
- Long term storage of the product with average temperature of 50 °C and average humidity 70%, 36 months

BUF 10.16IT../180MSF2 SH160



Dimensioned drawing

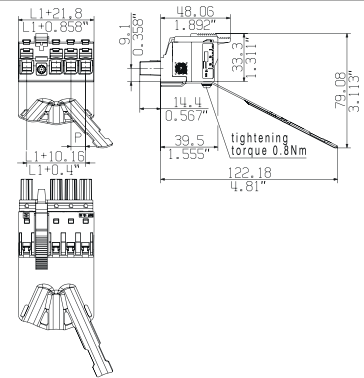

Accessories

Note: Refer to the Accessories chapter for additional accessories.

Coding	Order No.
KO BU/SU10.16HP BK	1824410000
KO BU/SU10.16HP WT	2592600000
Screwdriver	
SDS 0.8X4.5X125	2749370000

Ordering data

Solder pin length				
Colour	black			
Pitch	10.16 mm			
Pol.	L1	(inch)	Qty.	Order No.
3	30.48	1.200	20	2627810000
4	40.64	1.600	20	2627820000

Representative dimensional drawing

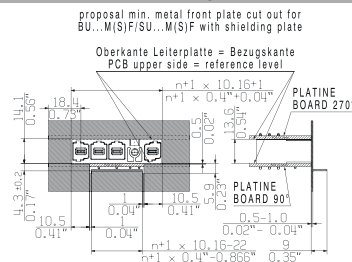

Representative deratings curve

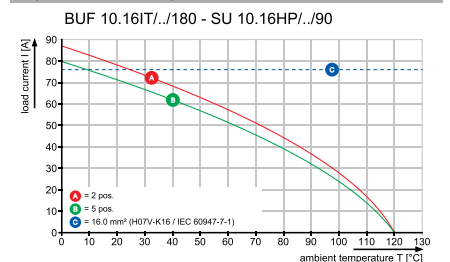

OMNIMATE® Power PCB connectors

P

10.16
180°

16 mm²

BUF 10.16IT../180MSF2 SH180



Dimensioned drawing

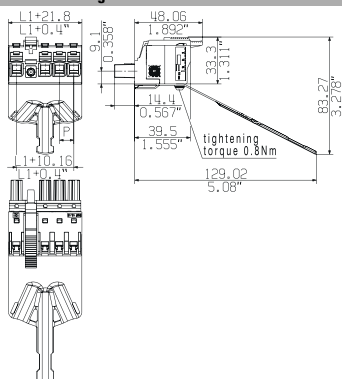

Ordering data

Solder pin length					
Colour					black
Pitch 10.16 mm					
Pol.	L1	(inch)	Qty.	Order No.	
3	30.48	1.200	20	2627860000	
4	40.64	1.600	20	2627870000	

BUF 10.16IT../180MSF2 SH200



Dimensioned drawing

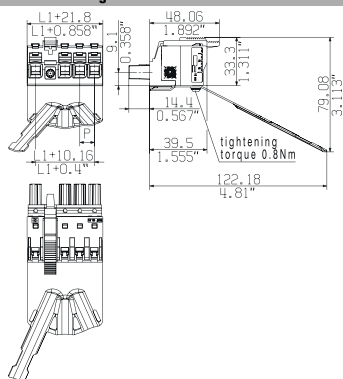

Ordering data

Solder pin length					
Colour					black
Pitch 10.16 mm					
Pol.	L1	(inch)	Qty.	Order No.	
3	30.48	1.200	20	2627910000	
4	40.64	1.600	20	2627920000	

Additional deratings curves

BUF 10.16IT../180 - SU 10.16HP../90

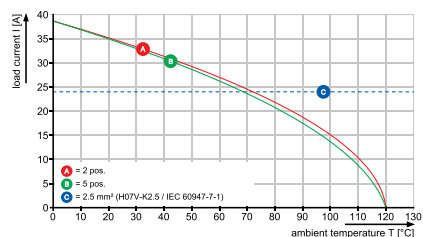

Connectors, pitch 10.16 mm
BU/SU 10.16 series - connection up to 16 mm²

BUF 10.16IT../180MSF SH

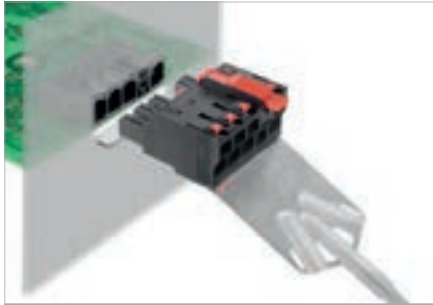

PUSH IN female plug with 180° outlet direction for IT power networks. Meets the requirements of UL1059 for 600 V Use Group C. Leading PE contact in combination with the male header SU 7.62 IT. Meets the enhanced requirements for 5.5 mm of touch safety on IT power networks in acc. with IEC 61800-5-1 for 400 V relative to earth. The self-locking middle flange which can also be optionally screwed, reduces the space requirements by one pitch width compared to conventional solutions.

The pluggable shield connection has a wide contact area on the device housing and does not need to be bolted.

Technical data

In compliance with IEC 60664-1 / IEC 61984			
Clamping range, max.	mm ²	2.5...16	
Solid core H05(07) V-U	mm²	2.5...10	
Stranded H07 V-R		...16	
Flexible H05(07) V-K	mm ²	2.5...16	
Flexible with ferrule	mm ²	2.5...16	
Ferrule with plastic collar	mm ²	2.5...16	
Stripping length	mm	18	
Screwdriver blade	mm	0.8 x 4.0	
According to norm		DIN 5264	
Tightening torque range			
Rated current, max.	A	76	70
At ambient temperature		20°C	40°C
For conductor cross-section	mm ²	16	
Overvoltage category		III	III II
Pollution severity		3	2 2
Rated voltage	V	1000	1000 1000
Rated impulse voltage	kV	8	8 8
UL / CUL (Use Group)	B C D	B	C D
Rated voltage	V	600	600
Rated current	A	34	34
AWG conductor	AWG	12-6	
CSA (Use Group)	B C D	B	C D
Rated voltage	V		
Rated current	A		
AWG conductor	AWG		
General data			
Type of insulation material		PA GF	
UL 94 flammability rating		V-0	
Contact base material		Copper alloy	
Material of contact surface			
Pin dimensions = d	mm		
Solder eyelet Ø = D	mm		
Solder eyelet Ø tolerance	mm		

Product data

IEC: 1000 V / 76 A / 2.5 - 16 mm²
 UL: 600 V / 34 A / AWG 12 - 6



For additional articles and information, refer to catalog.weidmueller.com

Note:

- Additional variants on request
- Rated current related to rated cross-section & min. No. of poles.
- Wire end ferrule with plastic collar to DIN 46228/4
- Wire end ferrule without plastic collar to DIN 46228/1
- P on drawing = pitch
- Rated data refer only to the component itself. Clearance and creepage distances to other components are to be designed in accordance with the relevant application standards.
- For all applications with flange we recommend to fix the pin header with the help of the soldering flange or a self-tapping screw on the board.
- Long term storage of the product with average temperature of 50 °C and average humidity 70%, 36 months

BUF 10.16IT../180MSF3 SH160



Dimensioned drawing

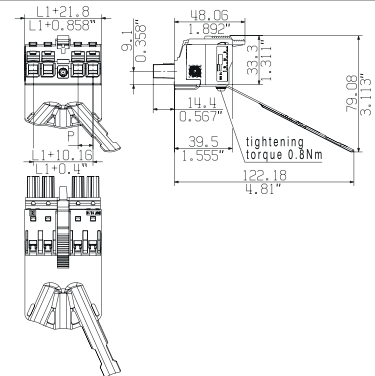

Accessories

Note: Refer to the Accessories chapter for additional accessories.

Coding	Order No.
KO BU/SU10.16HP BK	1824410000
KO BU/SU10.16HP WT	2592600000
Screwdriver	
SDS 0.8X4.5X125	2749370000

Ordering data

Solder pin length				
Colour	black			
Pitch	10.16 mm			
Pol.	L1	(inch)	Qty.	Order No.
3	30.48	1.200	20	2627830000
4	40.64	1.600	20	2627840000

Representative dimensional drawing

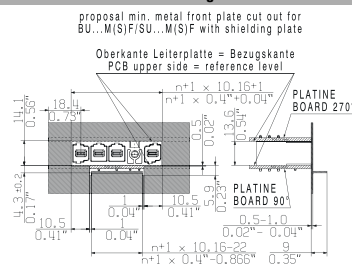

Representative deratings curve

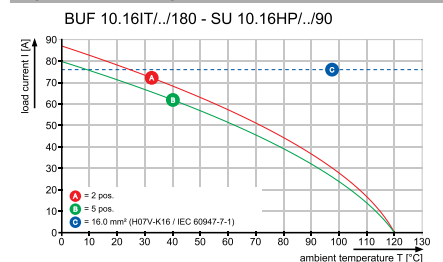

BUF 10.16IT../180MSF3 SH180



Dimensioned drawing

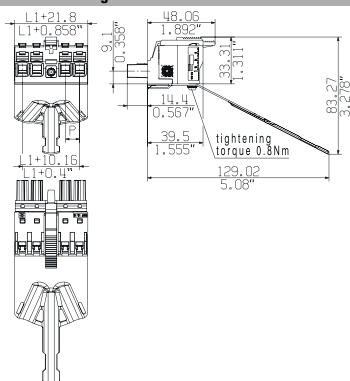

Ordering data

Solder pin length				
Colour	black			
Pitch	10.16 mm			
Pol.	L1	(inch)	Qty.	Order No.
3	30.48	1.200	20	2627880000
4	40.64	1.600	20	2627890000

BUF 10.16IT../180MSF3 SH200



Dimensioned drawing

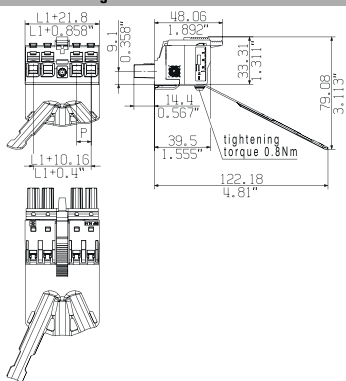

Ordering data

Solder pin length				
Colour	black			
Pitch	10.16 mm			
Pol.	L1	(inch)	Qty.	Order No.
3	30.48	1.200	20	2627930000
4	40.64	1.600	20	2627940000

Additional deratings curves

BUF 10.16IT../180 - SU 10.16HP../90

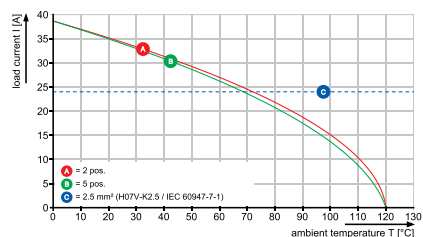

BUF 10.16IT../180MSF4 SH180



Dimensioned drawing

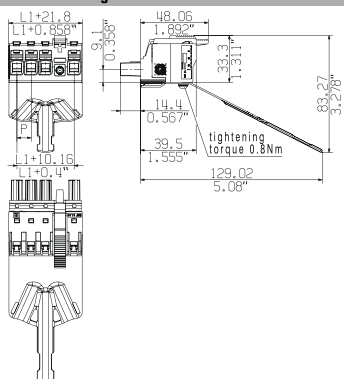

Ordering data

Solder pin length				
Colour	black			
Pitch	10.16 mm			
Pol.	L1	(inch)	Qty.	Order No.
4	40.64	1.600	20	2627900000

BUF 10.16IT../180MSF4 SH200



Dimensioned drawing

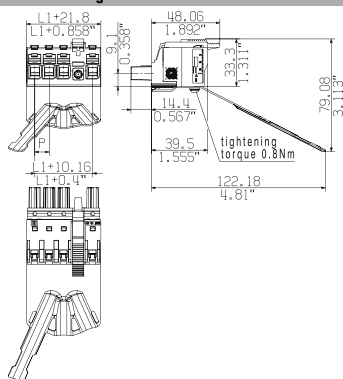

Ordering data

Solder pin length				
Colour	black			
Pitch	10.16 mm			
Pol.	L1	(inch)	Qty.	Order No.
4	40.64	1.600	20	2627950000

Additional deratings curves

BUF 10.16IT../180 - SU 10.16HP../90

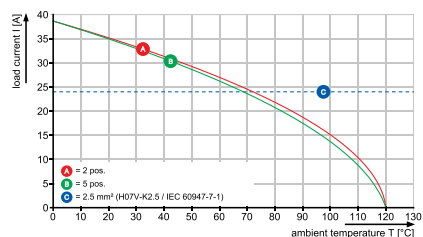

Connectors, pitch 10.16 mm
BU/SU 10.16 series - connection up to 16 mm²

BUF 10.16IT../180

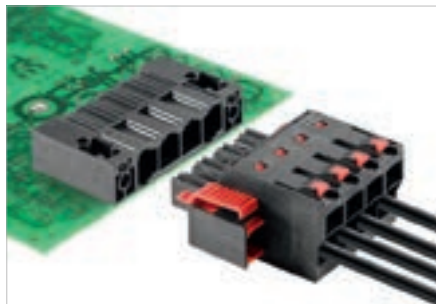

Female plug in 180° outlet direction with clamping yoke screw connection for TNC (S) systems. Meets the requirements of UL1059 for 600 V Use Group C. Ensures touch-safety of

> 3 mm in accordance with IEC 61800-5-1.

Maximum operational reliability with a derating up to 125°C, a mating profile that can only be plugged in correct and unique coding capability.

- Available with a flange (F) and screw flange (SF).

Product data

IEC: 1000 V / 76 A / 2.5 - 16 mm²
 UL: 600 V / 34 A / AWG 12 - 6



For additional articles and information, refer to catalog.weidmuller.com

Note:

- Additional variants on request
- Rated current related to rated cross-section & min. No. of poles.
- Wire end ferrule with plastic collar to DIN 46228/4
- Wire end ferrule without plastic collar to DIN 46228/1
- P on drawing = pitch
- Rated data refer only to the component itself. Clearance and creepage distances to other components are to be designed in accordance with the relevant application standards.
- Long term storage of the product with average temperature of 50 °C and average humidity 70%, 36 months

BUF 10.16IT../180



Dimensioned drawing

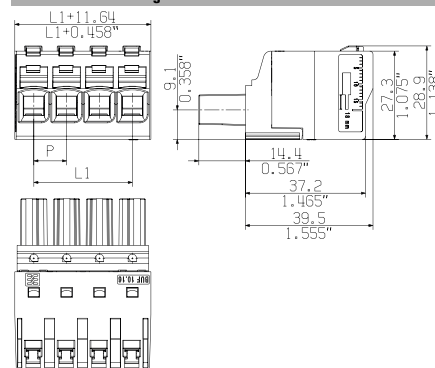

Technical data

In compliance with IEC 60664-1 / IEC 61984

Clamping range, max.	mm ²	2.5...16
Solid core H05(07) V-U	mm²	2.5...10
Stranded H07 V-R		
Flexible H05(07) V-K	mm ²	2.5...16
Flexible with ferrule	mm ²	2.5...16
Ferrule with plastic collar	mm ²	2.5...16
Stripping length	mm	18
Screwdriver blade	mm	0.8 x 4.0
According to norm		DIN 5264

Tightening torque range		
Rated current, max.	A	76 70
At ambient temperature		20°C 40°C

For conductor cross-section	mm ²	16
Overtolerance category		III III II
Pollution severity		3 2 2

Rated voltage	V	1000 1000 1000
Rated impulse voltage	kV	8 8 8

UL / CUL (Use Group)	B	C	D
-----------------------------	----------	----------	----------

Rated voltage	V	600	600
----------------------	----------	------------	------------

Rated current	A	34	34
----------------------	----------	-----------	-----------

AWG conductor	AWG	12-6
----------------------	------------	-------------

CSA (Use Group)	B	C	D
------------------------	----------	----------	----------

Rated voltage	V	
Rated current	A	
AWG conductor	AWG	-

General data

Type of insulation material	PA GF
UL 94 flammability rating	V-0
Contact base material	Copper alloy
Material of contact surface	silver-plated
Pin dimensions = d	mm
Solder eyelet Ø = D	mm
Solder eyelet Ø tolerance	mm

Accessories

Note: Refer to the Accessories chapter for additional accessories.

Coding		Order No.
	KO BU/SU10.16HP BK	1824410000
	KO BU/SU10.16HP WT	2592600000
Screwdriver		
	SDS 0.8X4.5X125	2749370000

Ordering data

Solder pin length				
Colour	black			
Pitch	10.16 mm			
Pol.	L1	(inch)	Qty.	Order No.
2	10.16	0.400	56	2493170000
3	20.32	0.800	36	2493400000
4	30.48	1.200	28	2493410000
5	40.64	1.600	24	2493420000
6	50.80	2.000	20	2586520000
7	60.96	2.400	20	2586550000
8	71.12	2.800	20	2586560000
9	81.28	3.200	20	2586570000

Representative deratings curve

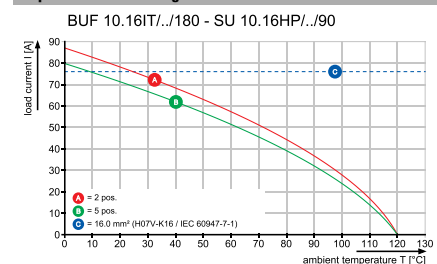

BUF 10.16IT../180F



Dimensioned drawing

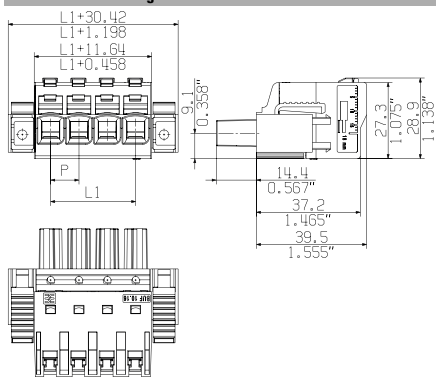

Ordering data

Solder pin length					
Colour					black
Pitch 10.16 mm					
Pol.	L1	(inch)	Qty.	Order No.	
2	10.16	0.400	28	2493300000	
3	20.32	0.800	24	2493310000	
4	30.48	1.200	20	2493320000	
5	40.64	1.600	16	2493330000	
6	50.80	2.000	16	2586530000	
7	60.96	2.400	20	2586580000	
8	71.12	2.800	20	2586690000	
9	81.28	3.200	20	2586600000	

BUF 10.16IT../180SF



Dimensioned drawing

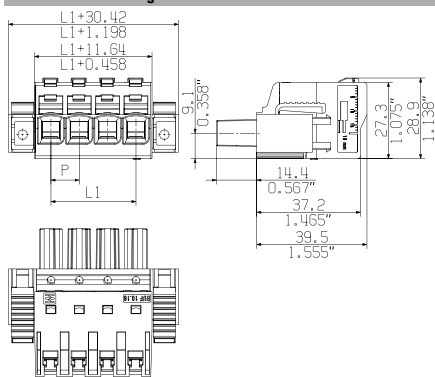

Ordering data

Solder pin length					
Colour					black
Pitch 10.16 mm					
Pol.	L1	(inch)	Qty.	Order No.	
2	10.16	0.400	28	2493340000	
3	20.32	0.800	24	2493350000	
4	30.48	1.200	20	2493360000	
5	40.64	1.600	16	2493370000	
6	50.80	2.000	20	2586610000	
7	60.96	2.400	20	2586620000	
8	71.12	2.800	20	2586630000	
9	81.28	3.200	20	2586640000	

Additional deratings curves

BUF 10.16IT../180 - SU 10.16HP../90

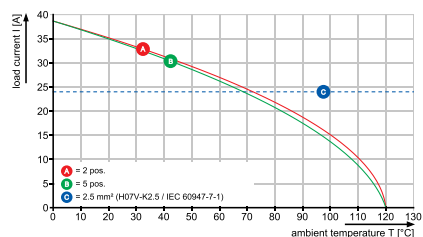

Connectors, pitch 10.16 mm
BU/SU 10.16 series - connection up to 16 mm²

BUL 10.16HP/./180

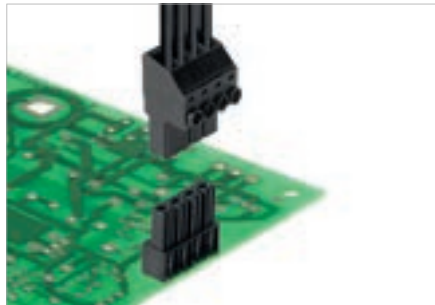

Finger-safe female header with 180° outlet direction for PCBs. Meets the requirements of IEC 61800-5-1 and allows UL approval in accordance with UL508 / UL840 for 600 V. An ideal finger-safe solution for power output and DC-link applications. The pin arrangement is finger-safe. The assembly coding ensures that it cannot be assembled on the PCB turned through 180°.

Features:

- Derating up to 130°C, 100%
- Pin arrangement that prevents wrong connections or wrong wiring
- Unique coding diversity and assembly coding

Technical data

In compliance with IEC 60664-1 / IEC 61984

Clamping range, max.			
Solid core H05(07) V-U			
Stranded H07 V-R			
Flexible H05(07) V-K			
Flexible with ferrule			
Ferrule with plastic collar			
Stripping length			
Screwdriver blade	mm		
According to norm			
Tightening torque range			
Rated current, max.	A	76	69
At ambient temperature		20°C	40°C
For conductor cross-section			
Overtoltage category		III	III II
Pollution severity		3	2 2
Rated voltage	V	630	630 1000
Rated impulse voltage	kV	6	6 6
UL / CUL (Use Group)		B	C D
Rated voltage	V	300	300 600
Rated current	A	57	57 5
AWG conductor	AWG		-
CSA (Use Group)		B	C D
Rated voltage	V	300	300 600
Rated current	A	57	57 5
AWG conductor	AWG		-
General data			
Type of insulation material	PA GF		
UL 94 flammability rating	V-0		
Contact base material	Copper alloy		
Material of contact surface	silver-plated		
Pin dimensions = d	mm	0.8 x 1.0	
Solder eyelet Ø = D	mm	1.3	
Solder eyelet Ø tolerance	mm	+ 0,1	

Product data

IEC: 1000 V / 76 A
 UL: 300 V / 57 A



For additional articles and information, refer to catalog.weidmueller.com

Note:

- Additional variants on request
- Rated current related to rated cross-section & min. No. of poles.
- P on drawing = pitch
- Rated data refer only to the component itself. Clearance and creepage distances to other components are to be designed in accordance with the relevant application standards.
- Long term storage of the product with average temperature of 50 °C and average humidity 70%, 36 months

BUL 10.16HP/./180

Without flange



Dimensioned drawing

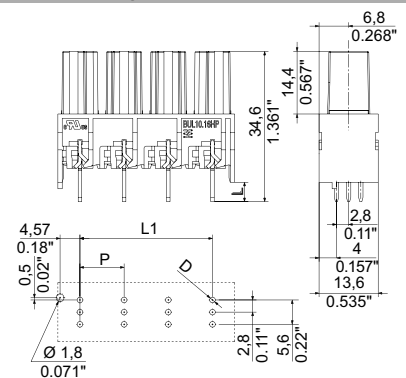

Ordering data

Solder pin length	4.5 mm		
Colour	black		
Pitch	10.16 mm		
Pol.	L1	(inch)	Qty. Order No.
2	10.16	0.400	50 1289000000
3	20.32	0.800	50 1341270000
4	30.48	1.200	50 1289010000

Accessories

Note: Refer to the Accessories chapter for additional accessories.

Coding	Order No.
K0 BU/SU10.16HP BK	1824410000
K0 BU/SU10.16HP WT	2592600000

Representative deratings curve

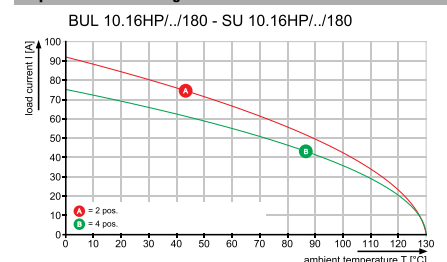

OMNIMATE® Power BUS connection system

OMNIMATE® Power BUS connection system	Explanation 0.2
	OMNIMATE® Power BUS connection system 160 A 0.4

Quick and simple installation of energy recovery by DC-Link for drives

OMNIMATE® Power BUS connection system

Q In the field of power electronics, straightforward and economical installation is becoming increasingly important. The new OMNIMATE® Power BUS connection system is the optimal busbar solution for use in IP20 multi-axis servo drives for intermediate circuits for energy recovery and 24V control voltage supplies.

The innovative latch-in bus system consists of two different busbar connectors with spring contacts. They enable a fast, tool-free connection of individual modules in addition to the connection of the entire module network to the power supply. A significant advantage of the modular system is the possibility of connecting intermediate circuits to the front or top of the device. Thus, the system is ideally adaptable to any particular installation conditions.

Your special advantages:

- Quick and easy installation of multi-axis servo drives without tools
- 100 % finger-safe system construction due to insulation end cap
- Safe latching of the busbar connectors
- Tolerance compensation for a module offset of up to 2 mm
- Simple device integration and uncomplicated device approval

High safety

The system guarantees a secure, absolutely finger-safe latching of the busbar connectors. The tolerance compensation of the rail system facilitates the secure fastening of the entire axle system.



Quick and easy installation

The simple plug-and-play solution is ideal for the fast, tool-free replacement of individual modules from a network of multi-axis servo drives.

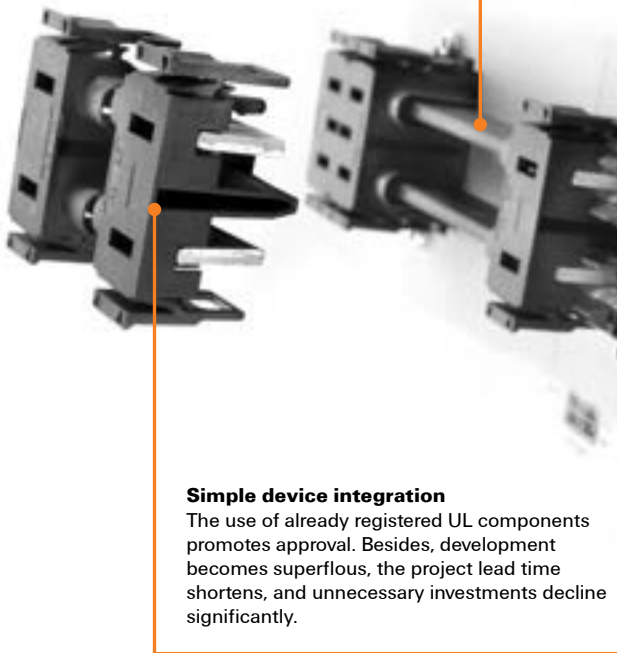

Simple device integration

The use of already registered UL components promotes approval. Besides, development becomes superfluous, the project lead time shortens, and unnecessary investments decline significantly.



BUS connection system 160 A



Modular current bar solution from Weidmüller. Optimally designed for use in IP20 multi-axis servo amplifiers for the intermediate circuit and the 24 V control voltage supply. The busbar system is designed in such a way that each module in the same axis system is quickly and easily connected to a spring contact by snapping a current bar into place. No tools are required for the innovative snap-in bus system. This simplifies assembly and installation.

Technical data

In compliance with IEC 60664-1 / IEC 61984

Clamping range, max.			
Solid core H05(07) V-U			
Stranded H07 V-R			
Flexible H05(07) V-K			
Flexible with ferrule			
Ferrule with plastic collar			
Stripping length			
Screwdriver blade	mm		
According to norm			
Tightening torque range			
Rated current, max.	A	160	140
At ambient temperature		20°C	40°C
For conductor cross-section			
Overvoltage category		III	III II
Pollution severity		3	2 2
Rated voltage	V	800	1000 1000
Rated impulse voltage	kV	8	8 6

UL 508

Rated voltage	V	750
Rated current	A	160

CSA (Use Group)

Rated voltage	
Rated current	

General data

Type of insulation material	PA GF
UL 94 flammability rating	V-0
Contact base material	Copper alloy
Material of contact surface	silver-plated
Pin dimensions = d	mm
Solder eyelet Ø = D	
Solder eyelet Ø tolerance	mm

Product data

IEC: 1000 V / 160 A
UL: 750 V / 160 A



For additional articles and information, refer to catalog.weidmueller.com

Note:

- Additional colours on request
- IEC-rated current is based on 20 °C ambiente temperature, further values see derating curve
- UL508-rated current based on 65 °C ambiente temperature and max. 20 devices
- Rated data refer only to the component itself. Clearance and creepage distances to other components are to be designed in accordance with the relevant application standards.
- Long term storage of the product with average temperature of 50 °C and average humidity 70 %, 36 months

PB-CON 160



Dimensioned drawing

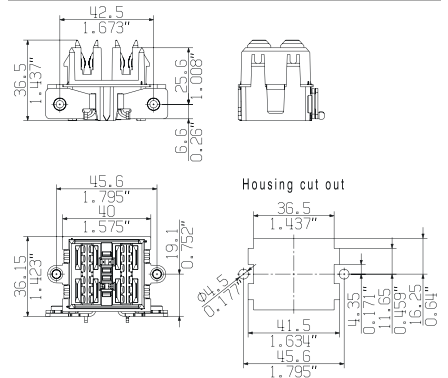

Accessories

Note: Refer to the Accessories chapter for additional accessories.

Cover		Order No.
	PB-ENDCAP 160 02RF BK BX	2594970000
	PB-CO RD	2654620000
	PB-CON IKSC M4X8 A2	2708610000
	PB-CON SF DELTA PT 40X12	2708620000

Ordering data

Solder pin length			
Colour		black	
Pitch	42.50 mm		
L1	Qty.	Order No.	
	20	2594720000	

PB-FEED 160



PB-LINK 160



Dimensioned drawing

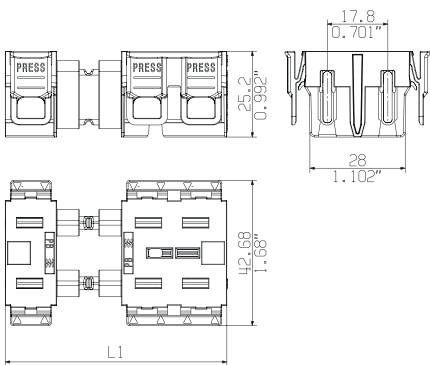

Dimensioned drawing

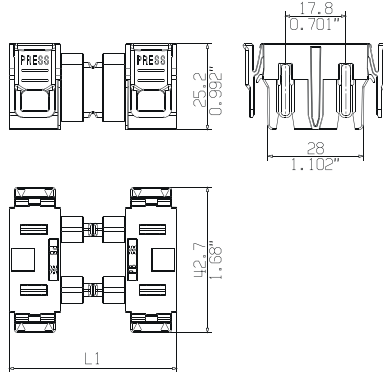

Ordering data

Solder pin length		
Colour	black	
Pitch	42.50 mm	
L1	Qty.	Order No..
50	20	2594950000
100	10	2595180000

Ordering data

Solder pin length		
Colour	black	
Pitch	42.50 mm	
L1	Qty.	Order No..
50	20	2595540000
100	10	2594960000

OMNIMATE® Power Through-Panel Terminals

OMNIMATE® Power Through-Panel Terminals

Through-Panel Terminals for devices
Series PGK 4 and WGK

Explanation	R.2
System overview	R.6
Quick selection	R.8

Through-Panel Terminals for devices
Series PGK 4 – PUSH IN connection

Product selection	
- Max. clamping range 4 mm ²	R.10

Through-Panel Terminals for devices
Series WGK – connects up to 95 mm²

Product selection	
- Max. clamping range 6 mm ²	R.12
- Max. clamping range 10 mm ²	R.14
- Max. clamping range 16 mm ²	R.16
- Max. clamping range 25 mm ²	R.18
- Max. clamping range 35 mm ²	R.20
- Max. clamping range 50 mm ²	R.22
- Max. clamping range 95 mm ²	R.24

OMNIMATE® – PUSH IN PGK 4 through-panel terminal

Comfortable, cost-saving installation and connection of conductors up to 4 mm²

In your applications space is limited. Save space and time for your housing feedthrough with our flexible connection system.

You are looking for a space-saving solution to quickly install wire connections for your device with panel or housing feed-throughs.

You'll find what you are looking for with our innovative PUSH IN connectivity technology solutions. Our PGK 4 feed-through terminal is worthy of note for its tool-free wire connection on the interior and exterior of your device. Thanks to its flexible, sliced construction and the intuitive fastening mechanism, it's easy for you to build blocks with plenty of poles.

With such features, our PGK 4 is currently the most compact and fastest solution for housing feedthroughs.

Flexible application options

Due to its construction with only 5.1 mm wide slices, you can build simple, space-saving terminal blocks with plenty of poles.

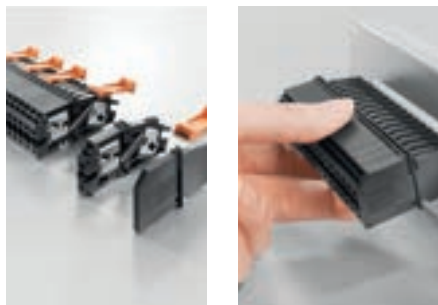

Clear marking

The terminals can be clearly labelled on the top and bottom, so that the terminal block can always be marked regardless of mounting position.

Simple handling and reduced assembly costs

Enjoy the benefits of the intuitive fastening mechanism and the ability to fasten the terminal block in the housing cut-out in seconds.



Secure attachment through thick and thin

The innovative terminal block fixing mechanism ensures a safe and reliable hold for the device feedthrough and is suited to panel thicknesses between 1.50 mm and 3.00 mm.



Solid contact with a large connection cross-section

Our innovative PUSH IN connection technology allows users to quickly and conveniently connect conductors. It also meets the need for permanent and vibration-resistant contacts. Conductor connections with a cross-section of up to 4.0 mm² with ferrules are possible.

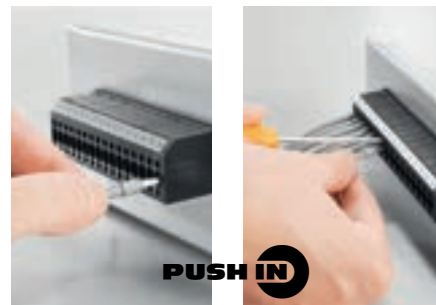

R

Available for testing at any time

You can perform a simple function check at any time using the easily accessible diagnostic test points.



Future-proofed materials and approvals

Halogen-free materials and additional international approvals increase the application options for new device designs.



Direct connected

PUSH IN the quick, tool-free, intuitive connection mechanism for prepared wires. www.push-in.com

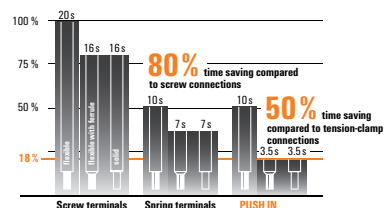

Through-Panel Terminals

WGK – OMNIMATE® Power

The universal solution to feed power through housing walls. Suitable for applications such as EMC filters, discretely structured converters for drive engineering, encapsulated equipment or inverters in the production of renewable energy.

Choose from the flexible range:

- Wide performance spectrum for currents up to 232 A and wire cross sections from 4 to 95 mm² (AWG 4/0)
- Various types of connections: castable solder connection, cable-lug-stud connection, and maintenance-free clamping-yoke screw connection
- Shapes for accommodating horizontal or vertical wire outlets

R

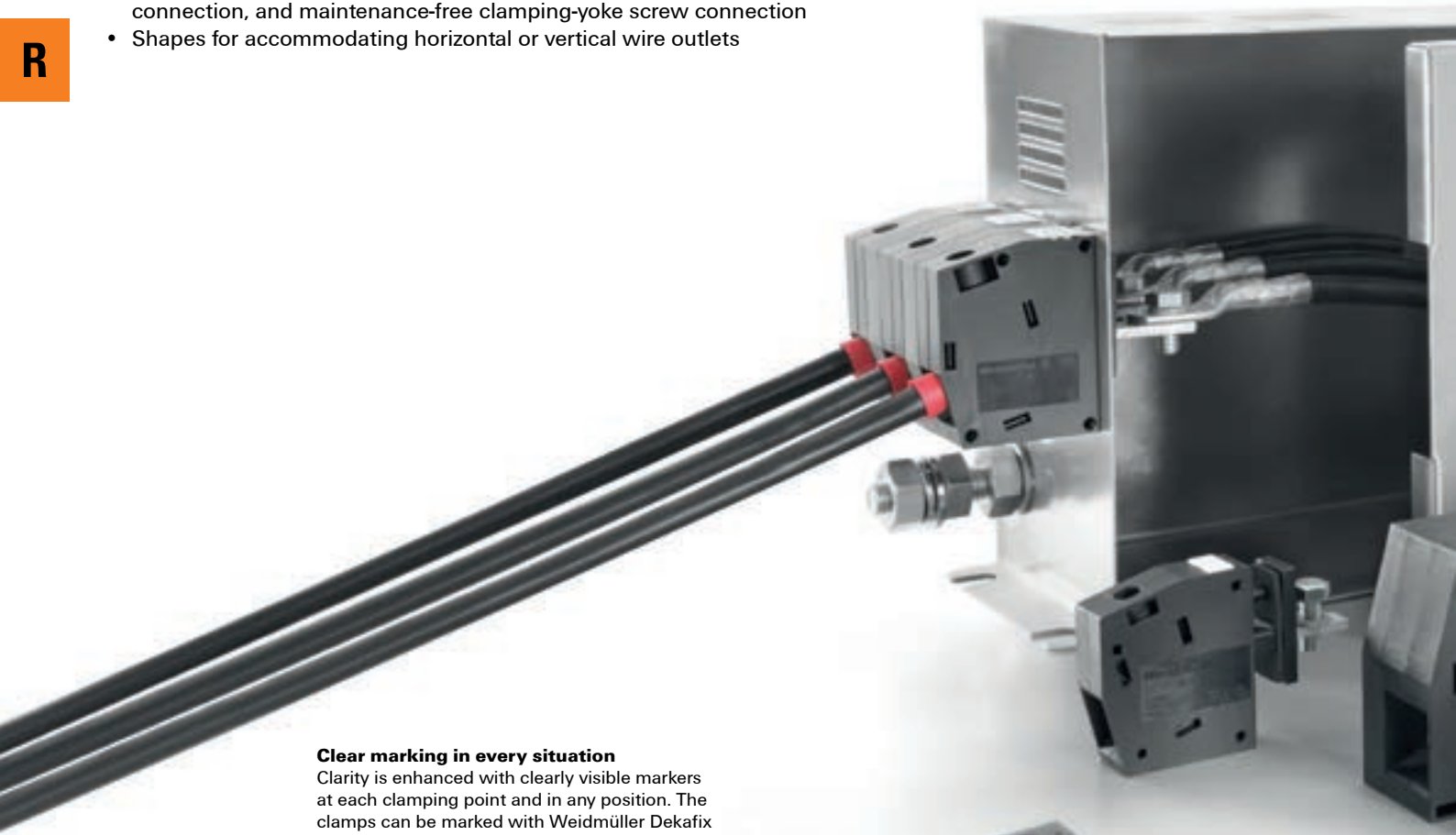

Clear marking in every situation

Clarity is enhanced with clearly visible markers at each clamping point and in any position. The clamps can be marked with Weidmüller Dekafix markers and flexible paster tabs.



Safety with extra power

The high-performance insulating material WEMID meets maximum system availability requirements: With an RTI (relative temperature index) of 120 °C, the OMNIMATE® power Through-Panel Terminals exceed the highest continued use temperature of standard PA (100 °C) at +20° K, thus creating more power reserves and maximum safety with temperature fluctuations and overloads



Easy handling

WGK series lead-through terminals consist of an inside and outside component that are easily locked with one another through the housing wall without any tools.

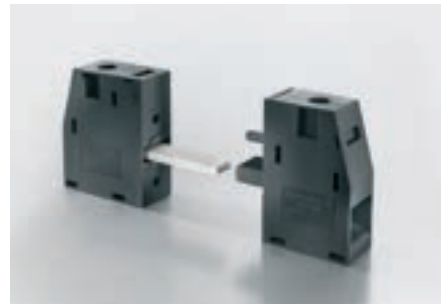

Solid and proven connection

Connections proven a million times. The terminal unit consists of hardened steel, for very high contact force. The current bar is made of copper, which gives a low voltage drop. The tin-plated surface ensures minimum contact resistances.

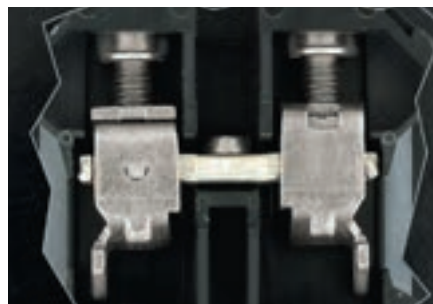

WGK series – System overview

WGK



Easy installation

WGK series feedthrough terminals consist of an inside and outside component that are easily locked with one another through the housing wall without any tools.



VWGK



Maximum freedom of design

Different types of connection on the inside such as a castable soldering connection (VWGK...), cable lug bolt connection (WGK ...VP) and a no-service clamping yoke-screw connection (WGK...) provide the optimum connection in any installation situation.

WGK...VP



WGK...WGKV



Weidmüller offers two models with a horizontal (WGK) and vertical (WGKV) outgoing direction to adapt the conductor guide to the given installation conditions.

The VP and VWGK models of the WGK lead-through terminals with an insulating housing and clamping yoke connection on the outside are enhanced for use in encapsulated and cast equipment (such as EMV filters).

These products are developed for 100 % sealing in completely cast units.



All Through-Panel Terminals terminals are available with pins (WGK.../Z) for easy locking. Multi-pole blocks can be built up quickly and easily.

Clearance and creepage distances to other components must be devised in accordance with the relevant application standard. This can be achieved in the device by full encapsulation or by the use of additional spacer plates.

Distance plates (DP WGK...) can be easily mounted with locking pins.

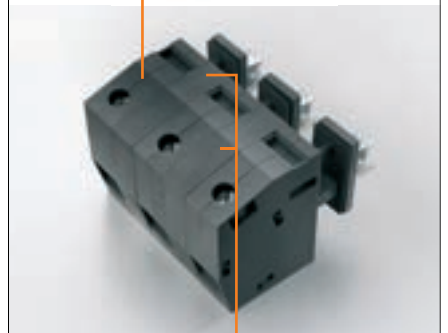

<http://www.OMNIMATE.net>

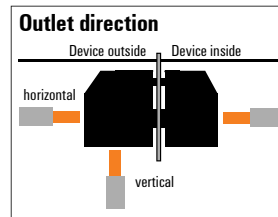

Through-Panel terminals - WGK

Device Outside	Device Inside	Clamping range IEC Clamping range UL	Max. rated voltage IEC Nominal current UL	Type	Outlet direction	
 PUSH IN	 PUSH IN	0.5 - 4 mm ² 24 - 10 AWG	32 A 30 A		PGK 4 horizontal	
 Screw Clamping yoke	 Solder connection	0.5 - 6 mm ² 30 - 10 AWG	32 A 30 A		VWGK 4 horizontal	
		0.5 - 10 mm ² 22 - 8 AWG	41 A 50 A		VWGK 6 horizontal	
	 Screw Clamping yoke	 Screw Clamping yoke	0.5 - 6 mm ² 30 - 10 AWG	32 A 30 A		WGK 4 WGKV 4 horizontal vertical
			0.5 - 16 mm ² 24 - 6 AWG	57 A 65 A		WGK 10 WGKV 10 horizontal vertical
	 Screw Clamping yoke	 Screw Clamping yoke	0.5 - 25 mm ² 20 - 4 AWG	76 A 85 A		WGK 16 WGKV 16 horizontal vertical
					 Cable lug	
	 Screw Clamping yoke	 Screw Clamping yoke	6 - 35 mm ² 10 - 3 AWG	101 A 100 A		WGK 25 WGKV 25 horizontal vertical
					 Cable lug	
	 Screw Clamping yoke	 Screw Clamping yoke	16 - 50 mm ² 6 - 1/0 AWG	150 A 145 A		WGK 50 horizontal
					 Cable lug	
	 Screw Clamping yoke	 Screw Clamping yoke	35 - 95 mm ² 4 - 4/0 AWG	232 A 230 A		WGK 95 horizontal
					 Cable lug	

Max. rated voltage IEC	400 V	500 V	690 V	1,000 V
	300 V		600 V	
Nominal voltage UL				
		○		
		○		
		○		
	○			
		○		
			○	
			○	
			○	
			○	
				○
				○

Feed-through terminals for devices PGK series – PUSH IN connection

max. clamping range: 4 mm²



The PGK 4 device feed-through terminal is the fastest and most compact solution for feed-throughs in housings.

The innovative PUSH IN connection system from Weidmüller makes for a simple, tool-free wire connection on the inside and outside of devices. The sliced design and an intuitive fastening mechanism enable high-density blocks to be constructed quickly and easily.

Technical data

In compliance with IEC 60664-1 / IEC 61984			
Clamping range, max.	mm ²	0.5...4	
Solid core H05(07) V-U	mm²	0.5...4	
Stranded H07 V-R			
Flexible H05(07) V-K	mm ²	0.5...4	
Flexible with ferrule	mm ²	0.5...4	
Ferrule with plastic collar	mm ²	0.5...2.5	
Stripping length	mm	12	
Screwdriver blade	mm	0.4 x 2.5	
According to norm			
Tightening torque range			
Rated current, max.	A	32	
At ambient temperature		20°C	40°C
For conductor cross-section	mm ²	4	
Overvoltage category		III	III II
Pollution severity		3	2 2
Rated voltage		500	
Rated impulse voltage		6	
UL / CUL (Use Group)	B C D		
Rated voltage	V	300 150 300	
Rated current	A	30 30 30	
AWG conductor	AWG	24-10	
CSA (Use Group)	B C D		
Rated voltage	V	300 150 300	
Rated current	A	30 30 30	
AWG conductor	AWG	24-10	
General data			
Type of insulation material		Wemid (PA)	
UL 94 flammability rating		V-0	
Contact base material		E-Cu	
Material of contact surface		tinned	
Pin dimensions = d	mm		
Solder eyelet Ø = D	mm		
Solder eyelet Ø tolerance	mm		

Product data

IEC: 500 V / 32 A / 0.5 - 4 mm²
UL: 300 V / 30 A / AWG 24 - 10



For additional articles and information, refer to catalog.weidmueller.com

Note:

- Packing unit incl. 30 locking elements (VREL PGK 4 OR - 1288610000)
- End plate required
- Clearance and creepage distances to other components must be devised in accordance with the relevant application standard. This can be achieved in the device by full encapsulation or by the use of additional spacer plates.
- Rated data refer only to the component itself. Clearance and creepage distances to other components are to be designed in accordance with the relevant application standards.
- Colours: SW = black; GN/YL = green/yellow; GY = grey
- Additional colours on request
- Long term storage of the product with average temperature of 50 °C and average humidity 70%, 36 months

PGK 4

PUSH IN connection



Dimensioned drawing

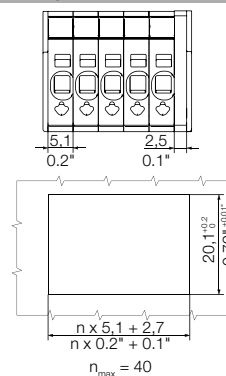

Accessories

Note: Refer to the Accessories chapter for additional accessories.

Additional locking	Order No.
VREL PGK4 OR VPE 30	1288610000
Testing / Checking	
PS 2.3 RT	0180400000
Screwdriver	
SDS 0.4X2.5X75	2749320000
SDS 0.5X3.0X80	2749330000
Pressing tool	
PZ 6/5	9011460000

Ordering data

Type	Qty.	Order No.
PGK 4 BK	100	1288470000

With lock pins

Representative dimensional drawing

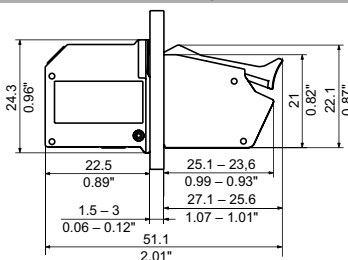

PGK 4 BT

PUSH IN connection



Dimensioned drawing

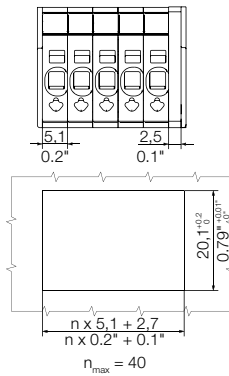

Ordering data

			With lock pins
Type	Qty.	Order No.	
PGK 4 BT BK	100	1288590000	

EPL PGK 4



Dimensioned drawing

Ordering data

			With lock pins
Type	Qty.	Order No.	
EPL PGK4 BK	50	1288600000	

R

Feed-through terminals for devices WGK series – connection up to 95 mm²

max. clamping range: 6 mm²



The high-current feed-through terminals of the WGK series provide a universal solution for feeding currents of different magnitude through the enclosure wall.

Various types of connection on the inside such as solder connections which can be encapsulated (VWGK...), cable lug connections (WGK ...VP) and maintenance-free clamping yoke screw connections (WGK...) with vertical and horizontal wire insertion provide the optimal connection for any installation situation.

The different peg types allow for a simple and quick assembly of multi-pole blocks.

Product data

IEC: 500 V / 32 A / 0.5 - 6 mm²
UL: 300 V / 30 A / AWG 30 - 10



For additional articles and information, refer to catalog.weidmueller.com

Note:

- Clearance and creepage distances to other components must be devised in accordance with the relevant application standard. This can be achieved in the device by full encapsulation or by the use of additional spacer plates.
- Rated data refer only to the component itself. Clearance and creepage distances to other components are to be designed in accordance with the relevant application standards.
- Colours: SW = black; GN/YL = green/yellow; GY = grey
- Additional colours on request
- WGK: Rated voltage plastic walls: 1 - 4 mm = 500 V; metal walls: 1 - 2.5 mm = 400 V; metal walls: 2.5 - 4 mm = 250 V
- WGKV: Rated voltage plastic walls: 1 - 4 mm = 400 V; metal walls: 1 - 2.5 mm = 400 V; metal walls: 2.5 - 4 mm = 250 V
- VWGK: Rated voltage plastic walls: 1 - 4 mm = 500 V; metal walls: 1 - 4 mm = 500 V
- Long term storage of the product with average temperature of 50 °C and average humidity 70%, 36 months

WGK 4

Screw connection



Dimensioned drawing

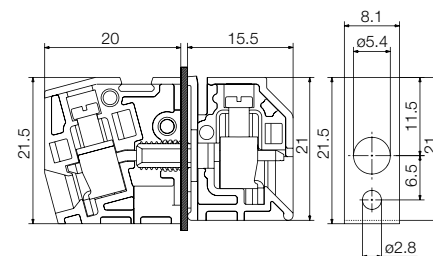



Technical data

In compliance with IEC 60664-1 / IEC 61984			
Clamping range, max.	mm ²	0.5...6	
Solid core H05(07) V-U	mm²	0.5...6	
Stranded H07 V-R			
Flexible H05(07) V-K	mm ²	0.5...4	
Flexible with ferrule	mm ²	0.5...4	
Ferrule with plastic collar			
Stripping length	mm	8	
Screwdriver blade	mm	0.6 x 3.5	
According to norm			
Tightening torque range	Nm	0.6...0.8	
Rated current, max.	A	32	
At ambient temperature		20°C	40°C
For conductor cross-section	mm ²	4	
Overvoltage category		III	III
Pollution severity		3	2
Rated voltage		500	
Rated impulse voltage		6	
UL / CUL (Use Group)	B C D		
Rated voltage	V	300	300
Rated current	A	30	30
AWG conductor	AWG	30-10	
CSA (Use Group)	B C D		
Rated voltage	V	300	300
Rated current	A	30	30
AWG conductor	AWG	30-10	
General data			
Type of insulation material		Wemid (PA)	
UL 94 flammability rating		V-0	
Contact base material		E-Cu	
Material of contact surface		tinned	
Pin dimensions = d	mm		
Solder eyelet Ø = D			
Solder eyelet Ø tolerance	mm		

Accessories

Note: Refer to the Accessories chapter for additional accessories.

Distance plate		Order No.
	DP WGK 4 BK BX	1297840000
	DP WGK 4 GY BX	1936450000
	DP VWGK 4 BK BX	1251030000
	DP VWGK 4 GY BX	1936430000
Screwdriver		
	SDIS 0.6X3.5X100	2749810000
Marking tags		
	DEK 5/8 MC NE WS	1856740000
	DEK 5/5 MC NE WS	1609801044
	DEK 5/6 MC NE WS	1609820000

Ordering data

Type	Qty.	Order No.	
		With lock pins	No lock pins
WGK 4/Z BK BX	50	1250940000	
WGK 4/Z GN/YE BX	50	1936560000	
WGK 4/Z GY BX	50	1936570000	
WGK 4 BK BX	50		1250930000
WGK 4 GN/YE BX	50		1936540000
WGK 4 GY BX	50		1936550000

WGKV 4

Screw connection



Dimensioned drawing

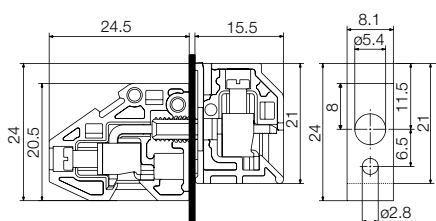

Ordering data

Type	Qty.	With lock pins		No lock pins	
		Order No.	Order No.	Order No.	Order No.
WGKV 4/Z BK BX	50	1250960000			
WGKV 4/Z GN/YE BX	50	1936620000			
WGKV 4/Z GY BX	50	1936630000			
WGKV 4 BK BX	50		1250950000		
WGKV 4 GN/YE BX	50		1936610000		
WGKV 4 GY BX	50		1934050000		

WGK 4 VP

Solder connection



Dimensioned drawing

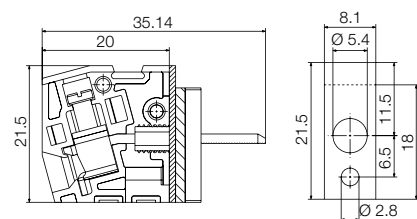

Ordering data

Type	Qty.	With lock pins		No lock pins	
		Order No.	Order No.	Order No.	Order No.
WGK 4 VP/Z GN/YE BX	50	1003900000			
WGK 4 VP/Z GY BX	50	1003910000			
WGK 4 VP GN/YE BX	50		1003890000		
WGK 4 VP GY BX	50		1981890000		

For the rated voltage of plastic and metal walls, see the "WGK" notes

VWGK 4

Solder connection



Dimensioned drawing

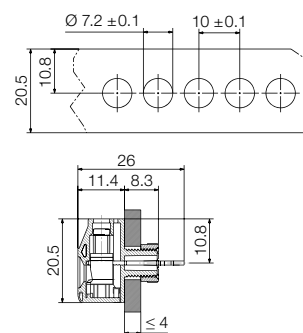

Ordering data

Type	Qty.	With lock pins	
		Order No.	Order No.
VWGK 4 BK BX	50	1250650000	
VWGK 4 GN/YE BX	50	1936480000	
VWGK 4 GY BX	50	1936490000	

Feed-through terminals for devices WGK series – connection up to 95 mm²

max. clamping range: 10 mm²



The V versions of the WGK feed-through terminals with an insulated housing and clamping yoke connection on the outside, and a solder connection on the inside. Optimal connection options for use in encapsulated devices (e.g. EMC filters and/or fully insulated transformers).

The different peg types allow for a simple and quick assembly of multi-pole blocks.

Product data

IEC: 500 V / 41 A / 0.5 - 10 mm²
UL: 300 V / 50 A / AWG 22 - 10



For additional articles and information, refer to catalog.weidmueller.com

Note:

- Clearance and creepage distances to other components must be devised in accordance with the relevant application standard. This can be achieved in the device by full encapsulation or by the use of additional spacer plates.
- Rated data refer only to the component itself. Clearance and creepage distances to other components are to be designed in accordance with the relevant application standards.
- Colours: SW = black; GN/YL = green/yellow; GY = grey
- Additional colours on request
- VWGK: Rated voltage plastic walls: 1 - 4 mm = 500 V; metal walls: 1 - 4 mm = 500 V
- Long term storage of the product with average temperature of 50 °C and average humidity 70%, 36 months

VWGK 6



Dimensioned drawing

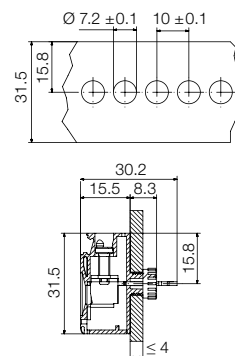

Technical data

In compliance with IEC 60664-1 / IEC 61984			
Clamping range, max.	mm ²	0.5...10	
Solid core H05(07) V-U	mm²	0.5...10	
Stranded H07 V-R		...6	
Flexible H05(07) V-K	mm ²	0.5...6	
Flexible with ferrule	mm ²	0.5...6	
Ferrule with plastic collar			
Stripping length	mm	13	
Screwdriver blade	mm	0.8 x 4.0	
According to norm			
Tightening torque range	Nm	0.8...1.8	
Rated current, max.	A	41	
At ambient temperature		20°C	40°C
For conductor cross-section	mm ²	6	
Overvoltage category		III	III II
Pollution severity		3	2 2
Rated voltage		500	
Rated impulse voltage		6	
UL / CUL (Use Group)	B C D		
Rated voltage	V	300 300 300	
Rated current	A	50 50 10	
AWG conductor	AWG	22-10	
CSA (Use Group)	B C D		
Rated voltage	V	300 300 300	
Rated current	A	50 50 10	
AWG conductor	AWG	22-10	
General data			
Type of insulation material		Wemid (PA)	
UL 94 flammability rating		V-0	
Contact base material		E-Cu	
Material of contact surface		tinned	
Pin dimensions = d	mm		
Solder eyelet Ø = D			
Solder eyelet Ø tolerance	mm		

Accessories

Note: Refer to the Accessories chapter for additional accessories.

Distance plate		Order No.
	DP VWGK 6 BK BX	1250630000
	DP VWGK 6 GY BX	1965750000
Screwdriver		
	SDIS 0.8X4.0X100	2749820000
Marking tags		
	DEK 5/5 MC NE WS	1609801044
	DEK 5/6 MC NE WS	1609820000
	DEK 5/8 MC NE WS	1856740000

Ordering data

No lock pins		
Type	Qty.	Order No.
VWGK 6 BK BX	50	2484810000
VWGK 6 GN/YE BX	50	2484680000
VWGK 6 GY BX	50	2484800000

Variants

The WGK...VP, VWGK 4 and VWGK 6 variants of the WGK series, with an insulating housing and clamping yoke connection on the outside, are specially enhanced for use in potted and through-panel applications.

These products are developed for 100 % sealing in completely enclosed units..

WGK variants are used, for example, as device connections for EMC filters or fully insulated transformers.

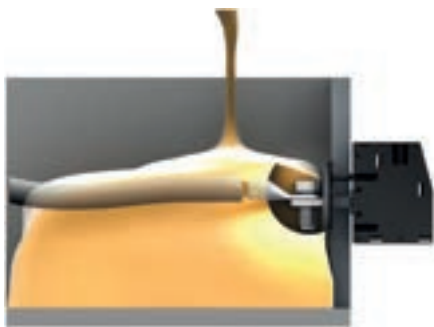

Clamping yoke screw connection

The clamping yoke connection is a proven connection in use around the world today.

Steel clamping yokes made using a stamping and bending process guarantee a vibration proof clamp connection.

When the screw on the clamp is tightened, there is a counter effect in the clamping yoke's threaded area which prevents the connection accidentally loosening.

As the screw thread is on an inclined plane, the force is amplified and a very high clamping force is achieved.

Weidmüller uses hardened steel with optimised corrosion protection for stability and safety in addition to copper alloys in the contact area for good electrical conductivity.

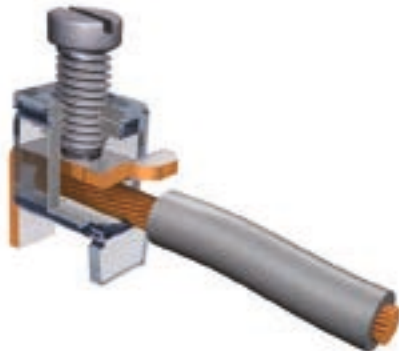

Feed-through terminals for devices WGK series – connection up to 95 mm²

max. clamping range: 16 mm²



The high-current feed-through terminals of the WGK series provide a universal solution for feeding currents of different magnitude through the enclosure wall.

Different types of connection on the inside, such as a solder connection which can be encapsulated (WGK...VP) or a maintenance-free clamping yoke screw connection (WGK...) with vertical and horizontal wire connections, provide the optimal connection for any installation situation.

The different peg types allow for a simple and quick assembly of multi-pole blocks.

Product data

IEC: 500 V / 57 A / 0.5 - 16 mm²
UL: 300 V / 65 A / AWG 24 - 6



For additional articles and information, refer to catalog.weidmueller.com

Note:

- Clearance and creepage distances to other components must be devised in accordance with the relevant application standard. This can be achieved in the device by full encapsulation or by the use of additional spacer plates.
- Rated data refer only to the component itself. Clearance and creepage distances to other components are to be designed in accordance with the relevant application standards.
- Colours: SW = black; GN/YL = green/yellow; GY = grey
- Additional colours on request
- WGK: Rated voltage plastic walls: 1 - 4 mm = 500 V; metal walls: 1 - 2.5 mm = 400 V; metal walls: 2.5 - 4 mm = 250 V
- Long term storage of the product with average temperature of 50 °C and average humidity 70%, 36 months

WGK 10



Dimensioned drawing

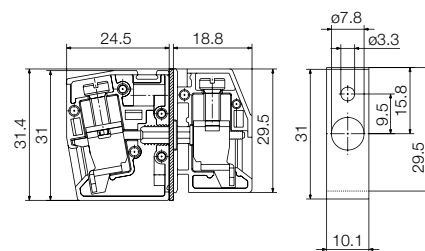

Technical data

In compliance with IEC 60664-1 / IEC 61984

Clamping range, max.	mm ²	0.5...16
Solid core H05(07) V-U	mm²	0.5...16
Stranded H07 V-R	mm ²	10...16
Flexible H05(07) V-K	mm ²	0.5...10
Flexible with ferrule	mm ²	0.5...10
Ferrule with plastic collar		
Stripping length	mm	11
Screwdriver blade	mm	0.8 x 4.0
According to norm		
Tightening torque range	Nm	1.2...2.4
Rated current, max.	A	57
At ambient temperature	20°C	40°C
For conductor cross-section	mm ²	10
Overvoltage category		III III II
Pollution severity		3 2 2
Rated voltage		500
Rated impulse voltage		6

UL / CUL (Use Group)

	B	C	D
Rated voltage	V	300	300
Rated current	A	65	65
AWG conductor	AWG	24-6	

	B	C	D
CSA (Use Group)			
Rated voltage	V	300	300
Rated current	A	65	65
AWG conductor	AWG	24-6	

General data

Type of insulation material	Wemid (PA)
UL 94 flammability rating	V-0
Contact base material	E-Cu
Material of contact surface	tinned
Pin dimensions = d	mm
Solder eyelet Ø = D	
Solder eyelet Ø tolerance	mm

Accessories

Note: Refer to the Accessories chapter for additional accessories.

Distance plate	Order No.
DP VWGK 6 BK BX	1250630000
DP VWGK 6 GY BX	1965750000
DP WGK 10 BK BX	
DP WGK 10 GY BX	
DP WGKV 10	

Screwdriver	Order No.
SDIS 0.8X4.0X100	2749820000

Marking tags	Order No.
DEK 5/5 MC NE WS	1609801044
DEK 5/6 MC NE WS	1609820000
DEK 5/8 MC NE WS	1856740000

Ordering data

Type	Qty.	Order No.	
		With lock pins	No lock pins
WGK 10/Z BK BX	50	2439460000	
WGK 10/Z GN/YE BX	50	2439400000	
WGK 10/Z GY BX	50	2439410000	
WGK 10 BK BX	50		2439470000
WGK 10 GN/YE BX	50		2439380000
WGK 10 GY BX	50		2439390000

WGKV 10



Dimensioned drawing

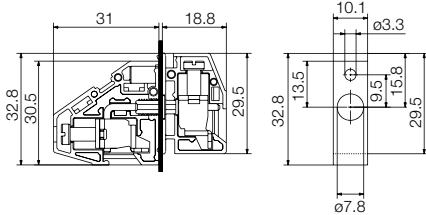

Ordering data

Type	Qty.	With lock pins		No lock pins	
		Order No.	Order No.	Order No.	Order No.
WGKV 10/Z BK BX	50	2439580000			
WGKV 10/Z GN/YE BX	50	2439540000			
WGKV 10/Z GY BX	50	2439550000			
WGKV 10 BK BX	50		2439570000		
WGKV 10 GN/YE BX	50		2439530000		
WGKV 10 GY BX	50		2439520000		

For the rated voltage of plastic and metal walls, see the "WGK" notes

WGK 10 VP



Dimensioned drawing

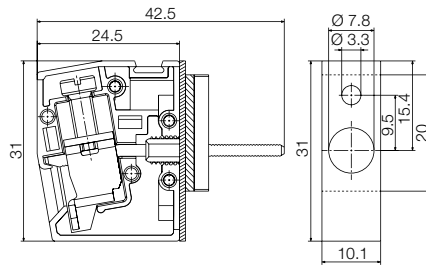

Ordering data

Type	Qty.	With lock pins		No lock pins	
		Order No.	Order No.	Order No.	Order No.
WGK 10 VP/Z GN/YE BX	50	2439440000			
WGK 10 VP/Z GY BX	50	2439420000			
WGK 10 VP GN/YE BX	50		2439430000		
WGK 10 VP GY BX	50		2439450000		

For the rated voltage of plastic and metal walls, see the "WGK" notes

Variants

The WGK...VP, VWGK 4 and VWGK 6 variants of the WGK series, with an insulating housing and clamping yoke connection on the outside, are specially enhanced for use in potted and through-panel applications. These products are developed for 100 % sealing in completely enclosed units..

WGK variants are used, for example, as device connections for EMC filters or fully insulated transformers.

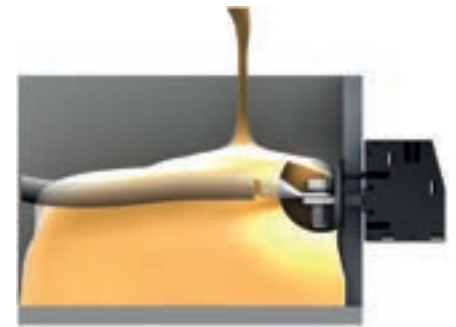

Clamping yoke screw connection

The clamping yoke connection is a proven connection in use around the world today.

Steel clamping yokes made using a stamping and bending process guarantee a vibration proof clamp connection. When the screw on the clamp is tightened, there is a counter effect in the clamping yoke's threaded area which prevents the connection accidentally loosening.

As the screw thread is on an inclined plane, the force is amplified and a very high clamping force is achieved. Weidmüller uses hardened steel with optimised corrosion protection for stability and safety in addition to copper alloys in the contact area for good electrical conductivity.

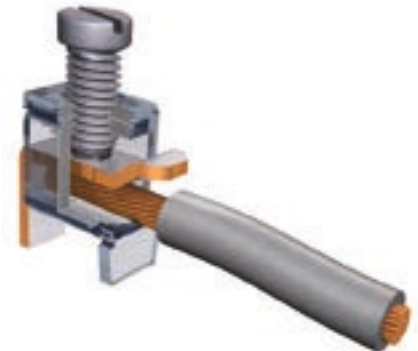

Feed-through terminals for devices WGK series – connection up to 95 mm²

max. clamping range: 25 mm²



The high-current feed-through terminals of the WGK series provide a universal solution for feeding currents of different magnitude through the enclosure wall.

Various types of connection on the inside, such as cable lug connections which can be encapsulated (WGK ...VP) and maintenance-free clamping yoke screw connections (WGK...) with vertical and horizontal wire insertion provide the optimal connection for any installation situation.

The different peg types allow for a simple and quick assembly of multi-pole blocks.

Product data

IEC: 500 V / 76 A / 0.5 - 25 mm²
UL: 600 V / 85 A / AWG 20 - 4



For additional articles and information, refer to catalog.weidmueller.com

Note:

- Clearance and creepage distances to other components must be devised in accordance with the relevant application standard. This can be achieved in the device by full encapsulation or by the use of additional spacer plates.
- Rated data refer only to the component itself. Clearance and creepage distances to other components are to be designed in accordance with the relevant application standards.
- Colours: SW = black; GN/YL = green/yellow; GY = grey
- Additional colours on request
- WGK: Rated voltage plastic walls: 1 - 6 mm = 800 V; metal walls: 1 - 2.5 mm = 800 V; metal walls: 2.5 - 4 mm = 690 V; metal walls: 4 - 6 mm = 500 V
- Long term storage of the product with average temperature of 50 °C and average humidity 70%, 36 months

WGK 16



Dimensioned drawing

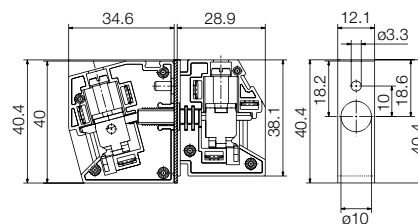

Technical data

In compliance with IEC 60664-1 / IEC 61984

Clamping range, max.	mm ²	0.5...25
Solid core H05(07) V-U	mm²	0.5...16
Stranded H07 V-R	mm ²	10...25
Flexible H05(07) V-K	mm ²	0.5...16
Flexible with ferrule	mm ²	0.5...16
Ferrule with plastic collar		
Stripping length	mm	16
Screwdriver blade	mm	1.0 x 5.5
According to norm		
Tightening torque range	Nm	2...2.3
Rated current, max.	A	76
At ambient temperature	20°C	40°C
For conductor cross-section	mm ²	16
Overvoltage category		III III II
Pollution severity		3 2 2
Rated voltage		500
Rated impulse voltage		6

UL / CUL (Use Group)

	B	C	D
Rated voltage	V	600	600
Rated current	A	85	85
AWG conductor	AWG	20-4	

CSA (Use Group)

	B	C	D
Rated voltage	V	600	600
Rated current	A	85	85
AWG conductor	AWG	20-4	

General data

Type of insulation material	Wemid (PA)
UL 94 flammability rating	V-0
Contact base material	E-Cu
Material of contact surface	tinned
Pin dimensions = d	mm
Solder eyelet Ø = D	mm
Solder eyelet Ø tolerance	mm

Accessories

Note: Refer to the Accessories chapter for additional accessories.

Distance plate	Order No.
DP WGK 16 BK BX	1250580000
DP WGK 16 GY BX	1936700000

Screwdriver	Order No.
SDIS 1.0X5.5X125	2749850000

Marking tags	Order No.
DEK 5/5 MC NE WS	1609801044
DEK 5/6 MC NE WS	1609820000
DEK 5/8 MC NE WS	1856740000

Ordering data

Type	Qty.	Order No.	
		With lock pins	No lock pins
WGK 16/Z BK BX	50	2440600000	
WGK 16/Z GN/YE BX	50	2440570000	
WGK 16/Z GY BX	50	2440580000	
WGK 16 BK BX	50		2440590000
WGK 16 GN/YE BX	50		2439600000
WGK 16 GY BX	50		2440560000

Feed-through terminals for devices WGK series – connection up to 95 mm²

max. clamping range: 35 mm²



The high-current feed-through terminals of the WGK series provide a universal solution for feeding currents of different magnitude through the enclosure wall.

Various types of connection on the inside, such as cable lug connections which can be encapsulated (WGK ...VP) and maintenance-free clamping yoke screw connections (WGK...) with vertical and horizontal wire insertion provide the optimal connection for any installation situation.

The different peg types allow for a simple and quick assembly of multi-pole blocks.

Product data

IEC: 690 V / 101 A / 6 - 35 mm²
UL: 600 V / 100 A / AWG 10 - 3



For additional articles and information, refer to catalog.weidmueller.com

Note:

- Clearance and creepage distances to other components must be devised in accordance with the relevant application standard. This can be achieved in the device by full encapsulation or by the use of additional spacer plates.
- Rated data refer only to the component itself. Clearance and creepage distances to other components are to be designed in accordance with the relevant application standards.
- Colours: SW = black; GN/YL = green/yellow; GY = grey
- Additional colours on request
- WGK: Rated voltage plastic walls: 1 - 6 mm = 800 V; metal walls: 1 - 4 mm = 800 V; metal walls: 4 - 6 mm = 690 V
- WGKV: Rated voltage plastic walls: 1 - 6 mm = 800 V; metal walls: 1 - 4 mm = 800 V; metal walls: 4 - 6 mm = 690 V
- WGK...VP: Rated voltage plastic walls: 1 - 6 mm = 800 V; metal walls: 1 - 2.5 mm = 800 V; metal walls: 2.5 - 4 mm = 690 V; metal walls: 4 - 6 mm = 500 V
- Wire-end ferrules are mandatory for stranded wires with more than 19 strands.
- Long term storage of the product with average temperature of 50 °C and average humidity 70%, 36 months

WGK 25



Dimensioned drawing

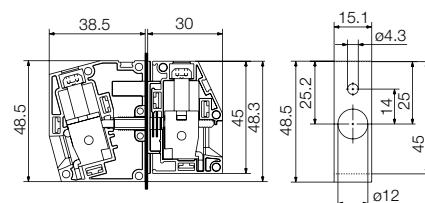

Technical data

In compliance with IEC 60664-1 / IEC 61984			
Clamping range, max.	mm ²	4...35	
Solid core H05(07) V-U	mm²	6...16	
Stranded H07 V-R	mm ²	10...35	
Flexible H05(07) V-K	mm ²	6...16	
Flexible with ferrule	mm ²	4...25	
Ferrule with plastic collar			
Stripping length	mm	18	
Screwdriver blade	mm	1.2 x 6.5	
According to norm			
Tightening torque range	Nm	4...4.5	
Rated current, max.	A	101	
At ambient temperature		20°C	40°C
For conductor cross-section	mm ²	25	
Overvoltage category		III	III II
Pollution severity		3	2 2
Rated voltage		690	
Rated impulse voltage		6	
UL / CUL (Use Group)	B C D		
Rated voltage	V	600	600
Rated current	A	100	100
AWG conductor	AWG	10-3	
CSA (Use Group)	B C D		
Rated voltage	V	600	600
Rated current	A	100	100
AWG conductor	AWG	10-3	
General data			
Type of insulation material		Wemid (PA)	
UL 94 flammability rating		V-0	
Contact base material		E-Cu	
Material of contact surface		tinned	
Pin dimensions = d	mm		
Solder eyelet Ø = D			
Solder eyelet Ø tolerance	mm		

Accessories

Note: Refer to the Accessories chapter for additional accessories.

Distance plate		Order No.
	DP WGK 25 BK BX	1250590000
	DP WGK 25 GY BX	1936710000
Screwdriver		
	SDIS 1.2X6.5X150	2749860000
Marking tags		
	DEK 5/5 MC NE WS	1609801044
	DEK 5/6 MC NE WS	1609820000
	DEK 5/8 MC NE WS	1856740000

Ordering data

Type	Qty.	Order No.	
		With lock pins	No lock pins
WGK 25/Z BK BX	50	2444680000	
WGK 25/Z GN/YE BX	50	2444640000	
WGK 25/Z GY BX	50	2444300000	
WGK 25 BK BX	50		2444670000
WGK 25 GN/YE BX	50		2444650000
WGK 25 GY BX	50		2444660000

WGKV 25



Dimensioned drawing

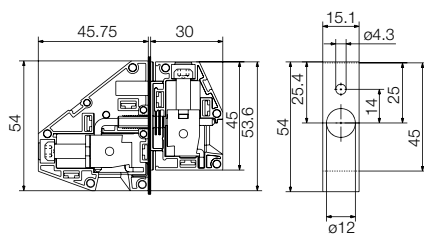

Ordering data

Type	Qty.	With lock pins		No lock pins	
		Order No.	Order No.	Order No.	Order No.
WGKV 25/Z BK BX	25	2444870000			
WGKV 25/Z GN/YE BX	25	2444810000			
WGKV 25/Z GY BX	25	2444860000			
WGKV 25 BK BX	25		2444840000		
WGKV 25 GN/YE BX	25		2444830000		
WGKV 25 GY BX	25		2444820000		

Rated voltage for plastic and metal walls such as WGK

WGK 25 VP



Dimensioned drawing

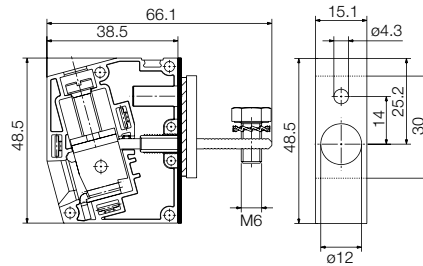

Ordering data

Type	Qty.	With lock pins		No lock pins	
		Order No.	Order No.	Order No.	Order No.
WGK 25 VP/Z BK BX	50	2444790000			
WGK 25 VP/Z GN/YE BX	50	2444720000			
WGK 25 VP/Z GY BX	50	2444730000			
WGK 25 VP BK BX	50		2444800000		
WGK 25 VP GN/YE BX	50		2444700000		
WGK 25 VP GY BX	50		2444710000		

Variants

The WGK...VP, VWGK 4 and VWGK 6 variants of the WGK series, with an insulating housing and clamping yoke connection on the outside, are specially enhanced for use in potted and through-panel applications. These products are developed for 100 % sealing in completely enclosed units..

WGK variants are used, for example, as device connections for EMC filters or fully insulated transformers.

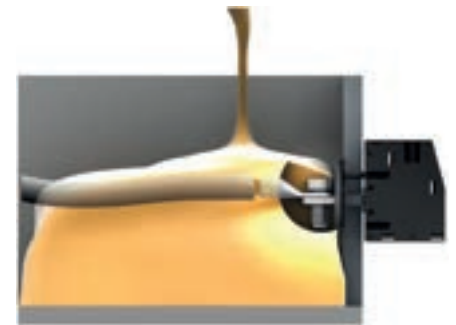

Clamping yoke screw connection

The clamping yoke connection is a proven connection in use around the world today.

Steel clamping yokes made using a stamping and bending process guarantee a vibration proof clamp connection. When the screw on the clamp is tightened, there is a counter effect in the clamping yoke's threaded area which prevents the connection accidentally loosening.

As the screw thread is on an inclined plane, the force is amplified and a very high clamping force is achieved. Weidmüller uses hardened steel with optimised corrosion protection for stability and safety in addition to copper alloys in the contact area for good electrical conductivity.

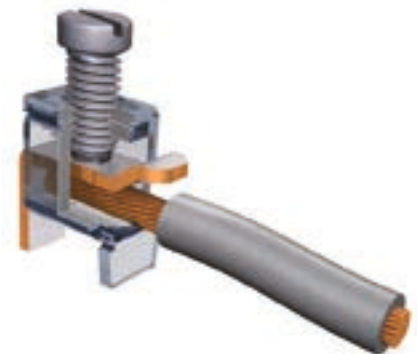

WGK 50 VP



Dimensioned drawing

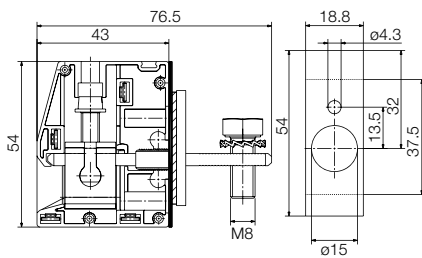

Variants

The WGK...VP, VWGK 4 and VWGK 6 variants of the WGK series, with an insulating housing and clamping yoke connection on the outside, are specially enhanced for use in potted and through-panel applications. These products are developed for 100 % sealing in completely enclosed units..

WGK variants are used, for example, as device connections for EMC filters or fully insulated transformers.

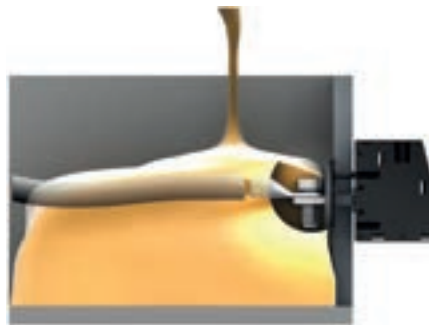

Ordering data

Type	Qty.	With lock pins		No lock pins	
		Order No.	Order No.	Order No.	Order No.
WGK 50 VP/Z BK BX	10	2428450000			
WGK 50 VP/Z GY BX	10	2428300000			
WGK 50 VP/Z GN/YE BX	10	2428290000			
WGK 50 VP BK BX	10		2428440000		
WGK 50 VP GN/YE BX	10		2428270000		
WGK 50 VP GY BX	10		2428280000		

Clamping yoke screw connection

The clamping yoke connection is a proven connection in use around the world today. Steel clamping yokes made using a stamping and bending process guarantee a vibration proof clamp connection. When the screw on the clamp is tightened, there is a counter effect in the clamping yoke's threaded area which prevents the connection accidentally loosening. As the screw thread is on an inclined plane, the force is amplified and a very high clamping force is achieved. Weidmüller uses hardened steel with optimised corrosion protection for stability and safety in addition to copper alloys in the contact area for good electrical conductivity.

For the rated voltage of plastic and metal walls, see the "WGK" notes



Feed-through terminals for devices WGK series – connection up to 95 mm²

max. clamping range: 95 mm²



The high-current feed-through terminals of the WGK series provide a universal solution for feeding currents of different magnitude through the enclosure wall.

Various types of connection on the inside, such as cable lug connections which can be encapsulated (WGK ...VP) and maintenance-free clamping yoke screw connections (WGK...) provide the optimal connection for any installation situation.

The different peg types allow for a simple and quick assembly of multi-pole blocks.

Product data

IEC: 1000 V / 232 A
UL: 600 V / 255 A / AWG 4 - kcmil 250



For additional articles and information, refer to catalog.weidmueller.com

Note:

- Clearance and creepage distances to other components must be devised in accordance with the relevant application standard. This can be achieved in the device by full encapsulation or by the use of additional spacer plates.
- Rated data refer only to the component itself. Clearance and creepage distances to other components are to be designed in accordance with the relevant application standards.
- Colours: SW = black; GN/YL = green/yellow; GY = grey
- Additional colours on request
- WGK: Rated voltage plastic walls: 1-6 mm = 1000 V; metal walls: < 1 mm = 1000 V; metal walls: 1-3.5 mm = 800 V; metal walls: 3.5-5.5 mm = 690 V
- Wire-end ferrules are mandatory for stranded wires with more than 19 strands.
- Long term storage of the product with average temperature of 50 °C and average humidity 70%, 36 months

WGK 95

Screw connection



Dimensioned drawing

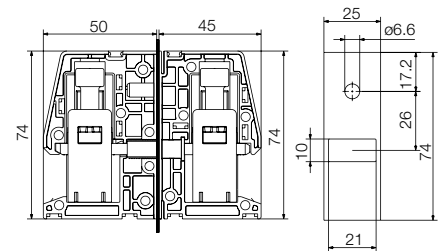

Technical data

In compliance with IEC 60664-1 / IEC 61984

Clamping range, max.	mm ²	35...95
Solid core H05(07) V-U		
Stranded H07 V-R	mm ²	35...95
Flexible H05(07) V-K	mm ²	35...95
Flexible with ferrule	mm ²	35...95
Ferrule with plastic collar		
Stripping length	mm	27
Screwdriver blade	mm	
According to norm		
Tightening torque range	Nm	15...20
Rated current, max.	A	232
At ambient temperature	20°C	40°C
For conductor cross-section	mm ²	95
Overtension category		III III II
Pollution severity		3 2 2
Rated voltage		1000
Rated impulse voltage		8

UL / CUL (Use Group)	B	C	D
Rated voltage	V	600	600
Rated current	A	255	255
AWG conductor	AWG	4-kcmil 250	
CSA (Use Group)	B	C	D
Rated voltage	V	600	600
Rated current	A	255	255
AWG conductor	AWG	4-kcmil 250	

General data	
Type of insulation material	Wemid (PA)
UL 94 flammability rating	V-0
Contact base material	E-Cu
Material of contact surface	tinned
Pin dimensions = d	mm
Solder eyelet Ø = D	mm
Solder eyelet Ø tolerance	mm

Accessories

Note: Refer to the Accessories chapter for additional accessories.

Distance plate	Order No.
DP WGK 95 BK BX	1250620000
DP WGK 95 GY BX	1937020000
Marking tags	
DEK 5/5 MC NE WS	1609801044
DEK 5/6 MC NE WS	1609820000
DEK 5/8 MC NE WS	1856740000

Ordering data

Type	Qty.	Order No.	
		With lock pins	No lock pins
WGK 95/Z BK BX	10	1250690000	
WGK 95/Z GN/YE BX	10	1937390000	
WGK 95/Z GY BX	10	1937400000	
WGK 95 BK BX	10		1250680000
WGK 95 GN/YE BX	10		1937370000
WGK 95 GY BX	10		1937380000

WGK 95 F VP

Cable lug connection



Dimensioned drawing

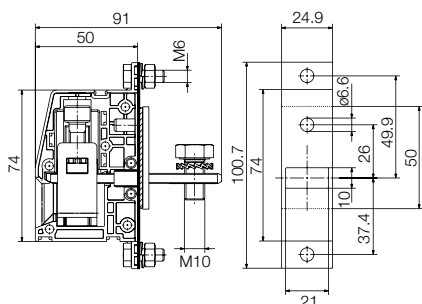

Variants

The WGK...VP, VWGK 4 and VWGK 6 variants of the WGK series, with an insulating housing and clamping yoke connection on the outside, are specially enhanced for use in potted and through-panel applications. These products are developed for 100 % sealing in completely enclosed units..

WGK variants are used, for example, as device connections for EMC filters or fully insulated transformers.



Ordering data

Type	Qty.	With lock pins		No lock pins	
		Order No.	Order No.	Order No.	Order No.
WGK 95F VP/Z BK BX	10	1250670000			
WGK 95F VP/Z GN/YE BX	10	1937360000			
WGK 95F VP/Z GY BX	10	1937140000			
WGK 95F VP BK BX	10		1250660000		
WGK 95F VP GN/YE BX	10		1937120000		
WGK 95F VP GY BX	10		1937130000		

Clamping yoke screw connection

The clamping yoke connection is a proven connection in use around the world today. Steel clamping yokes made using a stamping and bending process guarantee a vibration proof clamp connection. When the screw on the clamp is tightened, there is a counter effect in the clamping yoke's threaded area which prevents the connection accidentally loosening. As the screw thread is on an inclined plane, the force is amplified and a very high clamping force is achieved. Weidmüller uses hardened steel with optimised corrosion protection for stability and safety in addition to copper alloys in the contact area for good electrical conductivity.

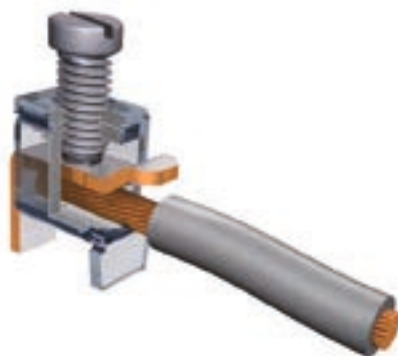

For the rated voltage of plastic and metal walls, see the "WGK" notes

R

OMNIMATE® Power Accessories

OMNIMATE® Power Accessories	Strain relief	S.2
	Shielding	S.3
	Coding elements / Anti-twist mechanism	S.4
	Screwdrivers	S.5
	Test plug	S.6

Strain relief

BV/SV 7.62HP/02 ZE GR

Strain relief



BV/SV 7.62HP/04 ZE GR

Strain relief



SVF/BVF 7.62HP COUPLE SET

Couple Set

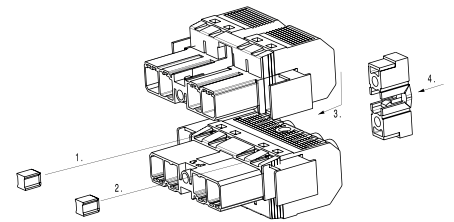

Ordering data

Colour		Grey
Type	Qty.	Order No.
BV/SV 7.62HP/02 ZE GR		1937550000

Ordering data

Colour		Grey
Type	Qty.	Order No.
BV/SV 7.62HP/04 ZE GR		1937560000

Ordering data

Colour		Grey
Type	Qty.	Order No.
SVF/BVF 7.62HP COUPLE SET		1440850000

BVF 7.62HP SH180 4-6 KIT

Shield support

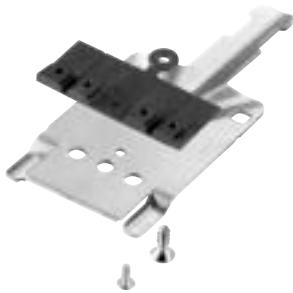

BVF 7.62HP SH150 4-6 KIT

Shield support



BVF 7.62HP SH150 4-6 KIT

Shield support

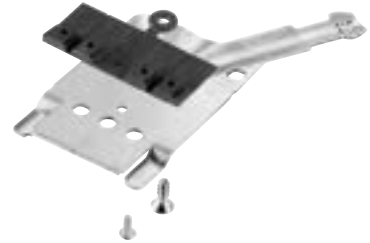

Ordering data

Colour	Grey	
Type	Qty.	Order No.
BVF 7.62HP SH180 4-6 KIT		1118470000

Ordering data

Colour	Grey	
Type	Qty.	Order No.
BVF 7.62HP SH150 4-6 KIT		1118480000

Ordering data

Colour	Grey	
Type	Qty.	Order No.
BVF 7.62HP SH210 4-6 KIT		1118490000

BV/SV 7.62 KO

Coding element



BV/SV 7.62 KO

Anti-twist mechanism



KO BU/SU 10.16HP BK

Coding element



Ordering data

Typ	Qty.	Order No.
BV/SV 7.62HP KO	100	1937590000

Ordering data

Type	Qty.	Order No.
SV 7.62 VDS	1	1853940000

Ordering data

Type	Qty.	Order No.
KO BU/SU 10.16HP BK	1	1824410000



SDI

VDE-insulated slotted screwdriver

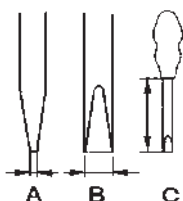
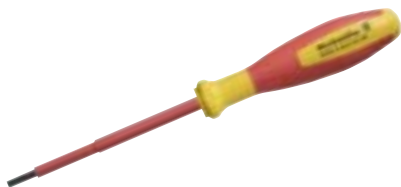

VDE-insulated slotted screwdriver, SDI

- SDI DIN 7437, ISO 2380/2
- Drive output acc. to DIN EN ISO/IEC 60900 and DIN ISO 2380



Ordering data

Type	Dims. (mm)	A	B	C	Order No.
SDI		0,4	2,5	75	2749790000
SDI		0,5	3,0	100	2749800000
SDI		0,6	3,5	100	2749810000
SDI		0,8	4,0	100	2749820000
SDI		1,0	4,5	125	2749830000
SDI		1,0	5,5	125	2749850000
SDI		1,2	6,5	150	2749860000
SDI		1,6	8,0	175	2749870000

SD

Slotted screwdriver with round blade

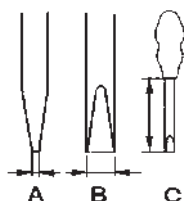

Slotted screwdriver with round blade, SD

- SD DIN 5265, DIN ISO 2380
- Drive output acc. to DIN 5264, DIN ISO 2380/1
- ChromTop tip



Ordering data

Type	Dims. (mm)	A	B	C	Order No.
SD		0,4	2,5	75	2749320000
SD		0,5	3,0	80	2749330000
SD		0,6	3,5	100	2749340000
SD		0,8	4,0	100	2749360000
SD		0,8	4,5	125	2749370000
SD		1,0	5,5	150	2749380000
SD		1,2	6,5	150	2749390000

Tension clamp terminal tool

Tool for PCB terminals with tension clamp connection



SD 0.6 x 3.5 x 100
(DIN 5264-A)

You do not need any special tool to connect or disconnect our tension clamp connection.

The opening is designed to accommodate a standard 0.6 x 3.5 x 100 screwdriver 9008330000 to DIN 5264-A (with flat blade).

SDK PH/PZ

Crosshead screwdriver



Crosshead screwdriver PH (Philips)

- SDK PH DIN 5262, DIN ISO 8764-PH
- Drive output acc. to DIN ISO 8764-PH
- ChromTop tip



Crosshead screwdriver PZ (Pozidrive)

- SDK PZ DIN 5262, DIN ISO 8764-PZ
- Drive output acc. to DIN ISO 8764-PZ
- Chrome top tip



Ordering data PH

Type	Dims. (mm)	A	B	C	Order No.
SDK PH0	0			60	2749400000
SDK PH1	1			80	2749410000
SDK PH2	2			100	2749420000
SDK PH3	3			150	2749430000

Ordering data PZ

Type	Dims. (mm)	A	B	C	Order No.
SDK PZ1	1			80	2749440000
SDK PZ2	2			100	2749450000
SDK PZ3	3			150	2749460000

Test plug**PS 2.0 MC****Test plug**

Ø 2.0 mm



- For conductors up to 0.75 mm² (AWG 18).
- Gold-plated lantern-type contact.
- Conductor must be soldered to contact in test plug.

Ordering data

Typ	Wire cross-sections	Qty.	Order No.
PS 2.0 MC	≤ 0,75 mm ²	20	031000000

OMNIMATE® Housings

Electronic housings

OMNIMATE® Housings Electronic housings	OMNIMATE® Housings		
		Explanation	T.2
		Orientation guide	T.4
<hr/>			
	CH20M modular housing series		
		Explanation	T.6
		Orientation guide	T.15
		Connection technology selection guide	T.18
		Product selection	T.20
<hr/>			
	MICROBOX / TERMINALBOX		
	Small housing series	Explanation	T.42
		Product selection	T.44
<hr/>			
	RS profile housing series		
		Explanation	T.46
		Orientation guide	T.48
		Product selection	T.50
<hr/>			
	Accessories		
		Mounting foot	T.56
		Identification systems	T.56
		Screwdrivers	T.57

OMNIMATE® Housings

Electronic housings

The perfect platform for form and function – including terminal layouts, bulk products and “tailor-made suits straight off the rack”.

Weidmüller’s electronics provide a state-of-the-art platform for electronics applications: for all design types and usage areas. The application and its requirements are the foundation for the housing design:

Modular housing using the standard pitch sizes are particularly well suited for standardised electrical cabinet applications.

Because of their excellent flexibility and variability, profile housings are the perfect solution for custom constructions and small-batch series.

The perfect blend of design, connection technology and functionality result in a design that is well tailored to market and application requirements.

T

Flexibility

Profile housing – the perfect solution for custom constructions and smallbatch series.

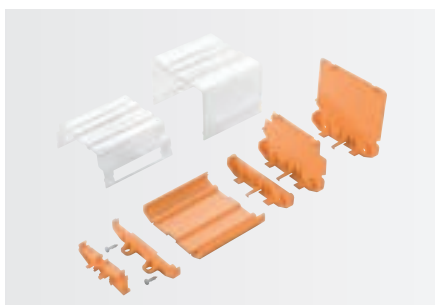

Reliability

Weidmüller’s legendary quality and well established, proven connection technology guarantee maximum availability for your systems.

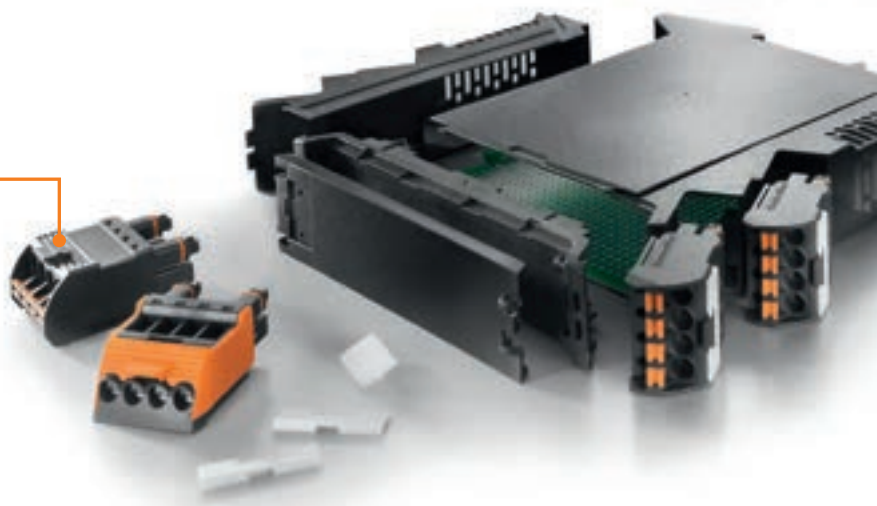

Innovation

Attention to detail: with the integrated, captive "AutoSet" coding function.



Efficiency

Reduce costs and increase productivity: SMT/SMD connectors packed suitably for fully automated production.



Modular housing for mounting on rail

Modular housing: function, form and processing all contribute to a single cohesive unit that offers safety, manufacturing efficiency and usability.



Profile housing in profile shape

Profile housing in profile shape - the flexible modular system of coloured and transparent plastic profiles and support modules provides the optimum balance between flexibility and efficiency.



Accessories

Comprehensive range of system accessories for integrating your assembled electronics "package" into the system environment - from attachment and connection to marking systems.

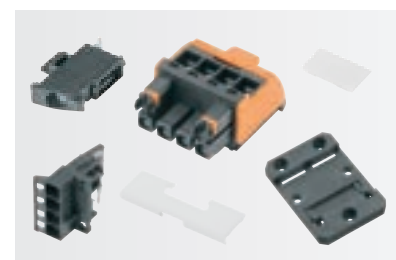

Electronic housings

With 6 housing systems, Weidmüller's electronics housing portfolio offers a platform for electronic applications in any design and for all application areas.

Detailed design information and the most important product-related data is available on the respective product pages. Data sheets and CAD models are available online for download.



CH20M – Modular Rail-mounted housing



System description (key points)	
Scalability	
Widths	
Design	Type of assembly of the PCB
Application	
Connection system	
Number of conductors that can be connected	
Number of slots for female plugs	
Design options	
Housing design	
PCB layout	
Labelling & marking	
Standard housing colours (Other colours on request)	
Additional features	
optional (excerpt)	
standard (excerpt)	

Component housing system IP 20	
<ul style="list-style-type: none"> • 7 housing widths from 6 to 67.5 mm: • 6,1 / 12,5 / 17,5 / 22,5 / 35¹⁾ / 45 / 67,5 • Individually configurable • THR and THT assemblies • Optional connection of devices via mounting rail bus 	
Connectors (touch-safe both sides)	
<ul style="list-style-type: none"> • 2 - 72 • 1 - 18 	
Individually configurable	
<ul style="list-style-type: none"> • Asymmetrical port configuration • Individual processing / modification 	
<ul style="list-style-type: none"> • Large net layout space of up to 9000 mm² • Up to 3 flexibly positioned PCBs • Both sides can be fitted with components 	
<ul style="list-style-type: none"> • Pad & laser printing • Device markers for female connector • Device markers for hinged cover 	
<ul style="list-style-type: none"> • Black • Black, transparent • Agate grey • Light grey 	<ul style="list-style-type: none"> • Graphite grey • Pebble grey • Traffic grey • Light blue
<ul style="list-style-type: none"> • Traffic red • Traffic yellow • Transparent 	
Optional or standard	
<ul style="list-style-type: none"> • Integrated mounting rail bus • FE mounting rail contac • Preparation for SIM card insertion 	
<ul style="list-style-type: none"> • Integrated, captive 16-fold "AutoSet" coding • Integrated release lever • Choice of PUSH-IN or clamping yoke connection • "Wire ready" and "wire guard" (protection against mis-inserting) • Transparent hinged cover, sealable 	

Legend of symbols

-  Clamping yoke screw connections
-  PUSH IN spring connection
-  Tension clamp connection

Note: 1) On request

Housing dimensions (exemplary)

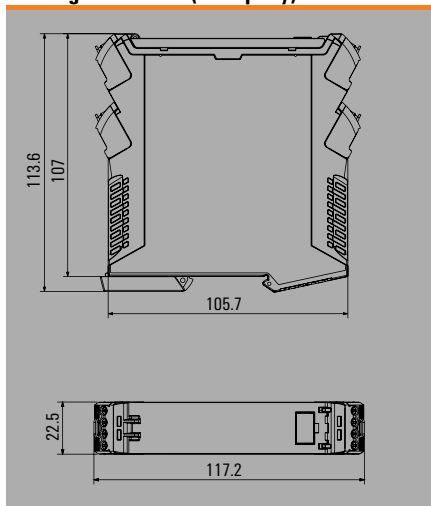

MICROBOX – Small housing
TERMINALBOX – Terminal housing

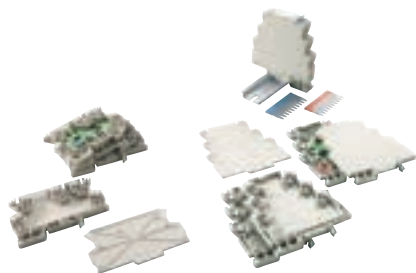

Small housing IP 20

- MICROBOX: 6.1 mm
- TERMINALBOX: 6.0 mm
- Miniature plate housing
- Compact enclosure in terminal format
- E.g. for I/O-plate applications

Connection terminals

- 4 - 6
- 2 - 3



2 versions

- MICROBOX: closed
- TERMINALBOX: optionally with cover plate

- Pad-print printing

- Black
- Pebble grey
- Grey beige
- Light blue

Optional

- Cross-connector 32 A

RS 45-122 – Profile housing variable

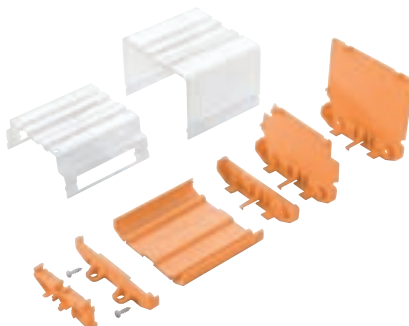

Variable extruded profile case IP 20

- Standard length 2 m, optionally cut to size
- Circuit boards 45 to 122 mm
- Precisely cut lengths
- Modules protected with a clear cover

Female connectors or terminals

- As needed
- 1 - 3



Combinable and a perfect fit

- See-through covers in 2 sizes
- End plates in 3 sizes
- Standard circuit cards (EURO format)
- Up to 2 PCBs stackable
- Double-sided installation
- Pad-print printing
- Standard connector markings
- Marking strips for the cover hood

- Black
- Orange
- Pebble grey
- Signal green

Optional

- Direct mounting

RS 70 – Profile housing modular



Modular profile case IP 00

- Individual elements, stackable modular
- Elements of 5 / 10 / 15 / 25 / 30 / 45 mm
- For 68 mm circuit boards
- Tool-free installation
- Sub-assembly accessible when opened

Female connectors or terminals

- As needed
- 1 - 3



tool-free installation

- 4 snap-on feet
- 5 different intermediate elements
- Standard circuit boards
- Double-sided installation

- Pad-print printing
- Standard connector markings

- Black
- Orange
- Grey beige

Optional

- Direct mounting

Housing dimensions (exemplary)

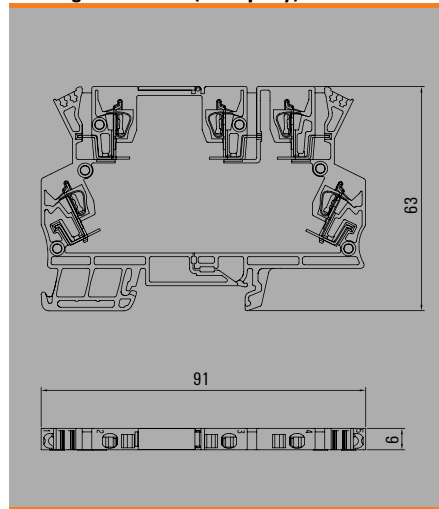

Housing dimensions (exemplary)

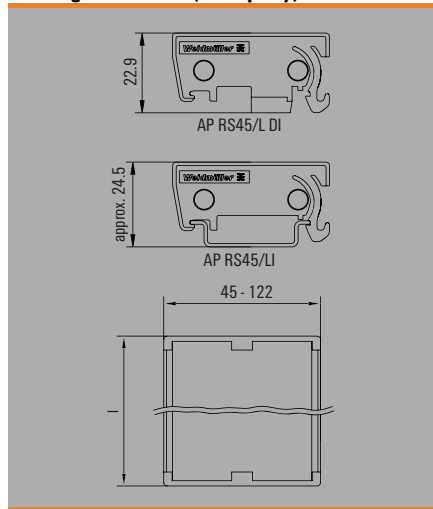

Housing dimensions (exemplary)

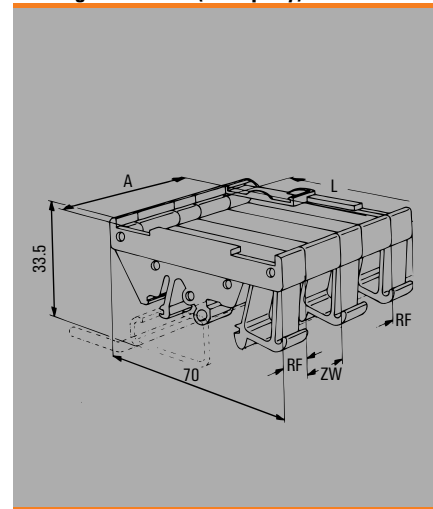

Individual design by combining form, function and appearance

CH20M (Component Housing IP 20 Modular) – Weidmüller’s new housing standard – represents the ideal platform for basing customised electronic applications.

Like a “tailor-made suit straight off the rack”, the ground breaking module concept combines freedom in design with the low cost and planning security of a standard system.

In addition to scalability, a high level of safety and innovative functionality in the application, the system also convinces with superior attention to detail.

The results are quicker installation, user-friendly operation, high operational reliability and resistance to interference. From development to production, the CH20M represents efficiency. It covers all of the requirements for a modern electronics platform built with the future in mind.

Designed configuration

As many connections as you require and as affordable as you need: scalable connection levels, up to 72 wire connections, individually configurable for each side with 1, 2 or 3 connection levels across all housing widths.



Designed basic colours

With a focus on the important elements: the unobtrusive housing colours (black graphite, grey graphite and light grey) make a competent impression without distracting from the key operational and display elements.



Designed printing

Detailed symbols, data, graphics or text can be printed (with either laser or pad printing) on the large surface available on the housing element.

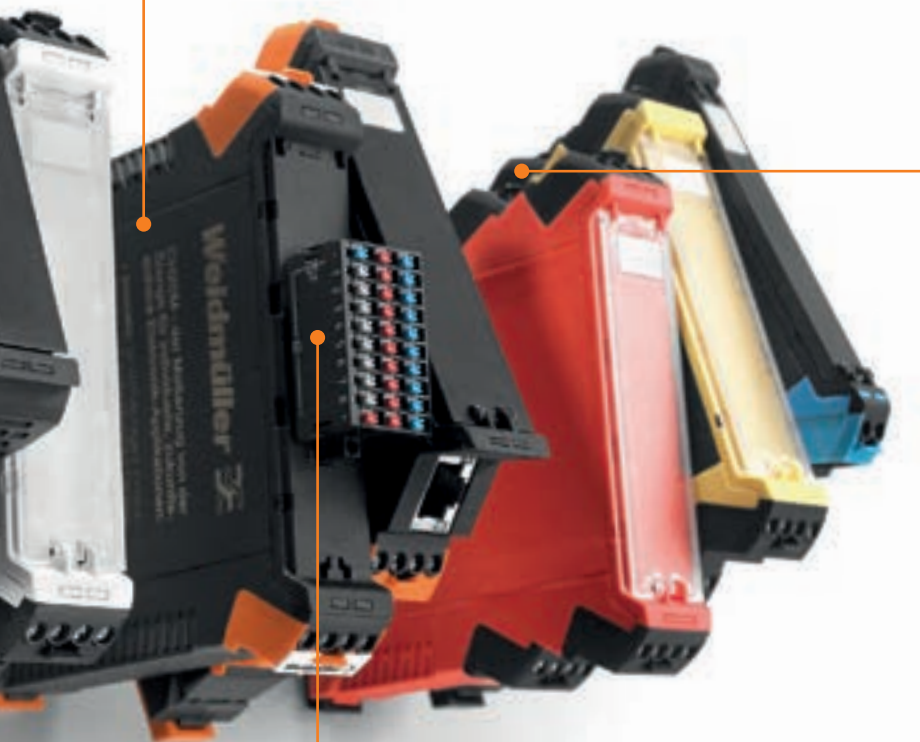

Designed modifications

Modifying after the configuration: for example by integrating the pluggable 30-pole BL-I/O LED digital I/O connection level in the front or with the RJ45 socket on the side.



Designed optical appearance

The standard variants, with their modularity and variety, enable you to customise a wide range of designs to fit your application.



Designed functionality

Our comprehensive, standardised configuration variants can be further supplemented with modification and design changes to fit your custom needs.



Designed functional colours

More operational confidence with functionally appropriate colour coding: three functional colours (red, yellow and blue coding) can be assigned to key industrial applications.



Power, signals and data are provided, connected and distributed securely and consistently

This customer-friendly bus solution brings power, signals and data to the rail in a quick and reliable manner. When supplying, connecting or distributing within modular applications, the rail bus can replace the tedious individual wiring process with a flexible and uninterrupted system solution. As a result, the wiring overhead and the error rate are both reduced. Redundant functions within complex applications can be efficiently centralised or intelligently distributed.

The system bus is securely integrated within the 35 mm standard mounting rail. The SMD-bus contact block can be reflow-soldered so that it can be completely automatically processed during the component assembly. The resistant, gold-plated contact surfaces ensure a permanent and reliable contact for all housing widths.

T

Scalability with no limits

Unique: The integrated connection solution covers all system widths: from the 6 mm slice to the 67 mm large-area housing.



Easy to service during installation:

Quick: It's easy to replace a module, even in existing modules groups - without any influence on the neighbouring modules.



Unlimited configuration

Compatible: The individual modules can be positioned anywhere on any TS 35 standard top-hat rail. Unused areas are safely covered.



Maximum availability:

Reliable: Five fully-galvanised and partially gold-plated twin-arched contacts are used to establish a permanent contact to the rail bus. THR solder flanges ensure that the connection to the circuit board is stable.

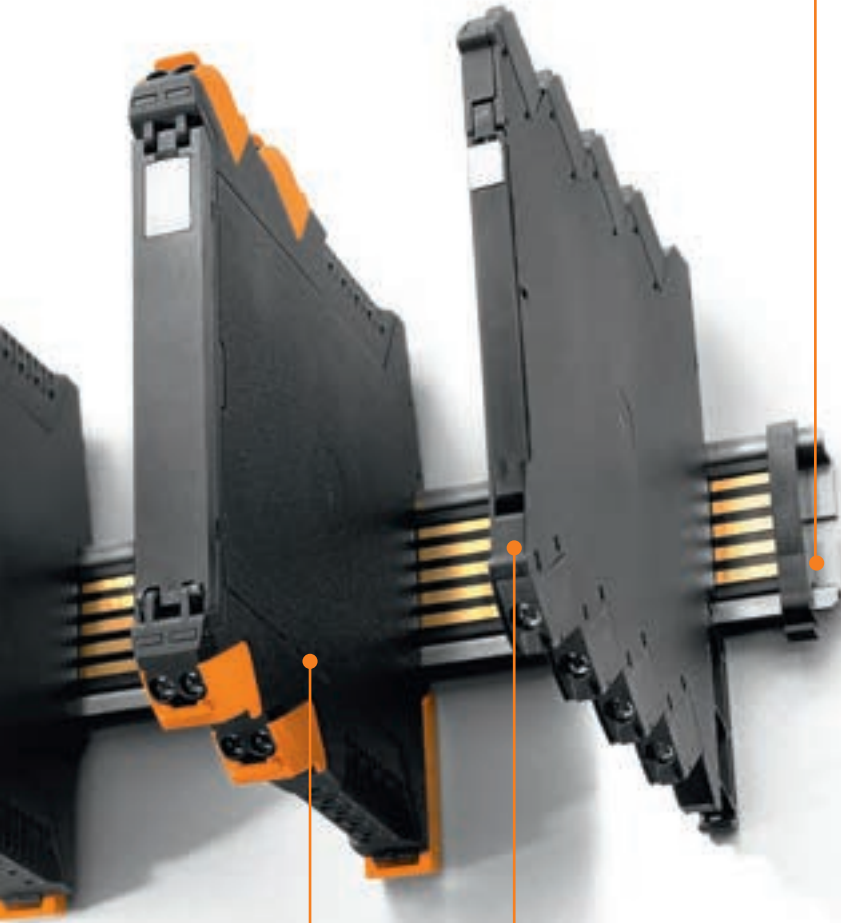
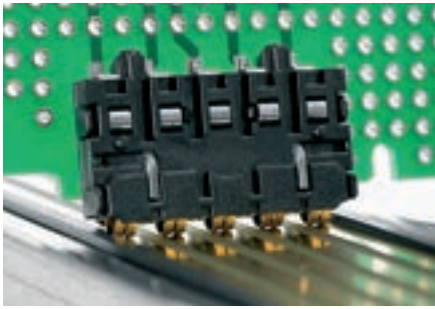

State-of-the-art processing

Efficient: The SMD-compatible bus contact block is made from high-temperature-resistant LCP. It is designed for the SMT reflow process and is delivered in machine-ready packaging.

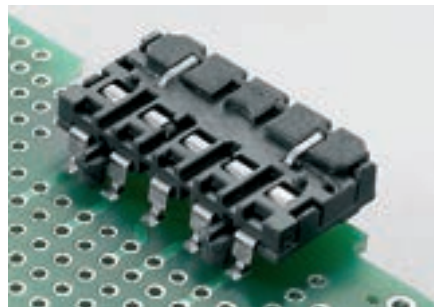

Affordable assembly

Fully automatic: No manual post processing is required for the bus contact block – it is processed with the assembly group in a single SMT assembly process.

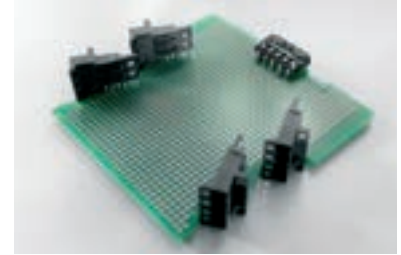

Safe installation

Low loss: You can safely avoid undesired bus interruptions and high contact resistances. Maximum facility availability ensured by the gold-plated contact surfaces on the system bus and contact block, as well as the consistent system design.



More flexibility in design

From design through production to application - CH20M6 sets the market standard with maximal board space with minimal exterior dimensions as well as allowing fully automatic reflow processing or bus connections.

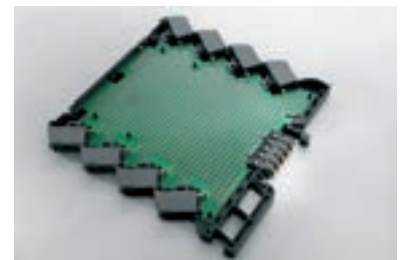

OMNIMATE® Housing – CH20M67

The new housing offers new assembly dimensions in the 67.5 mm equipment class.

The CH20M-67 sets new standards on the market as a large-scale housing in terms of flexibility for integrating intricate electronic subassemblies. You can distribute the electronic functions over as many as three printed-circuit boards. The front surface of the housings also has a unique size that can be used for freely laying out the operator interface.

Like all housings of the CH20M family from Weidmüller, the CH20M-67 also supports the connection to the mounting rail bus. The system bus is reliably integrated into the 35-mm standard mounting rail and replaces painstaking and error-prone individual wiring.

More reliability when connecting the conductors

Series equipment: The built-in conductor wire guard underinsertion protection prevents the hazardous underinsertion of the conductor and protects it from concealed contact faults. Being wire ready ensures that all connecting points are completely open at delivery.



More speed at installation

Series equipment: Screwed connections with wiring, supported by plus-minus screws, with power tools just right for automatic equipment.

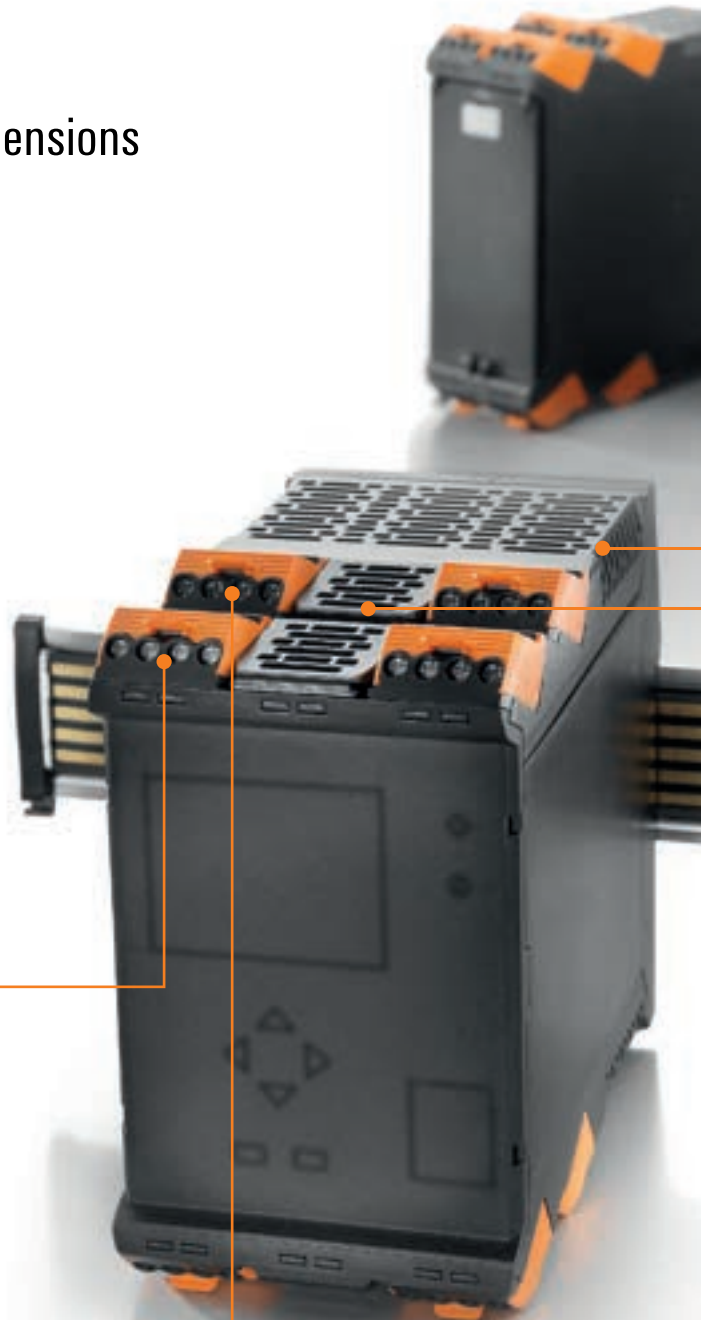



More layout area

The side Ventilation openings are standard equipment in the semi-cooling design and provide sufficient convection for demanding electronics with the maximised layout area on the printed-circuit board.



More flexibility for interfaces

Unused plug-in stations or connections that are only accessible from the factory side can be reliably and permanently sealed with the optional AD-SHL-SMT cover.



More stability on the mounting rail

The built-in click-in base is premounted at the factory which guarantees easy, reliable and vibration-free fastening on the DIN mounting rail. A guide with four points of support provides a solid base.



More design freedom

There is room for one to three printed-circuit boards placed on both sides CH20M-67. There is maximum design flexibility since each printed-circuit board can take four freely selectable positions in the housing.

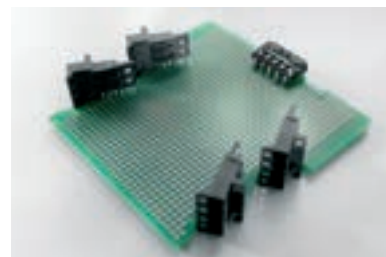

More mounting space

The printed-circuit boards can be positioned at a distance of 2.3 mm (and also 5 mm to the housing wall). This gives you the free choice of single- or double-sided assembly.



OMNIMATE® Housings Design-IN made easy

From the circuit diagram to the PCB

Our electronics housings can be customised quickly and easily with the aid of the Weidmüller Configurator.

Efficient digital engineering

The Weidmüller Configurator (WMC) & EDA data

1. Tried-and-tested configuration designs in real 3D

Configure your own housing quickly and easily with the Weidmüller Configurator. The smart linking of our assembly-specific individual parts enables a simple and clear assembly of your housing. The integrated plausibility and collision check together with the complete digital documentation ensures that you can rely 100% on your configuration.

2. Seamless CAD Integration

Integrated interfaces enable the simple export of product data between the WMC and all common CAD tools.

3. Quickly and easily back on the PCB

With our EDA component library and predefined PCB layouts, you can quickly and easily integrate our products into your EDA software.



T



Get started online now!
www.weidmueller.com/wmc



OMNIMATE® sample service

Quick and easy from an idea to your desk.

Try out our electronics housings yourself and order up to three free samples from the OMNIMATE® sample service. These are available in the form of pre-assembled demonstration samples and unassembled development kits.

For your first circuits, stripboards are also available from this service and will be on your desk within 72 hours.



www.weidmueller.com/housingsample









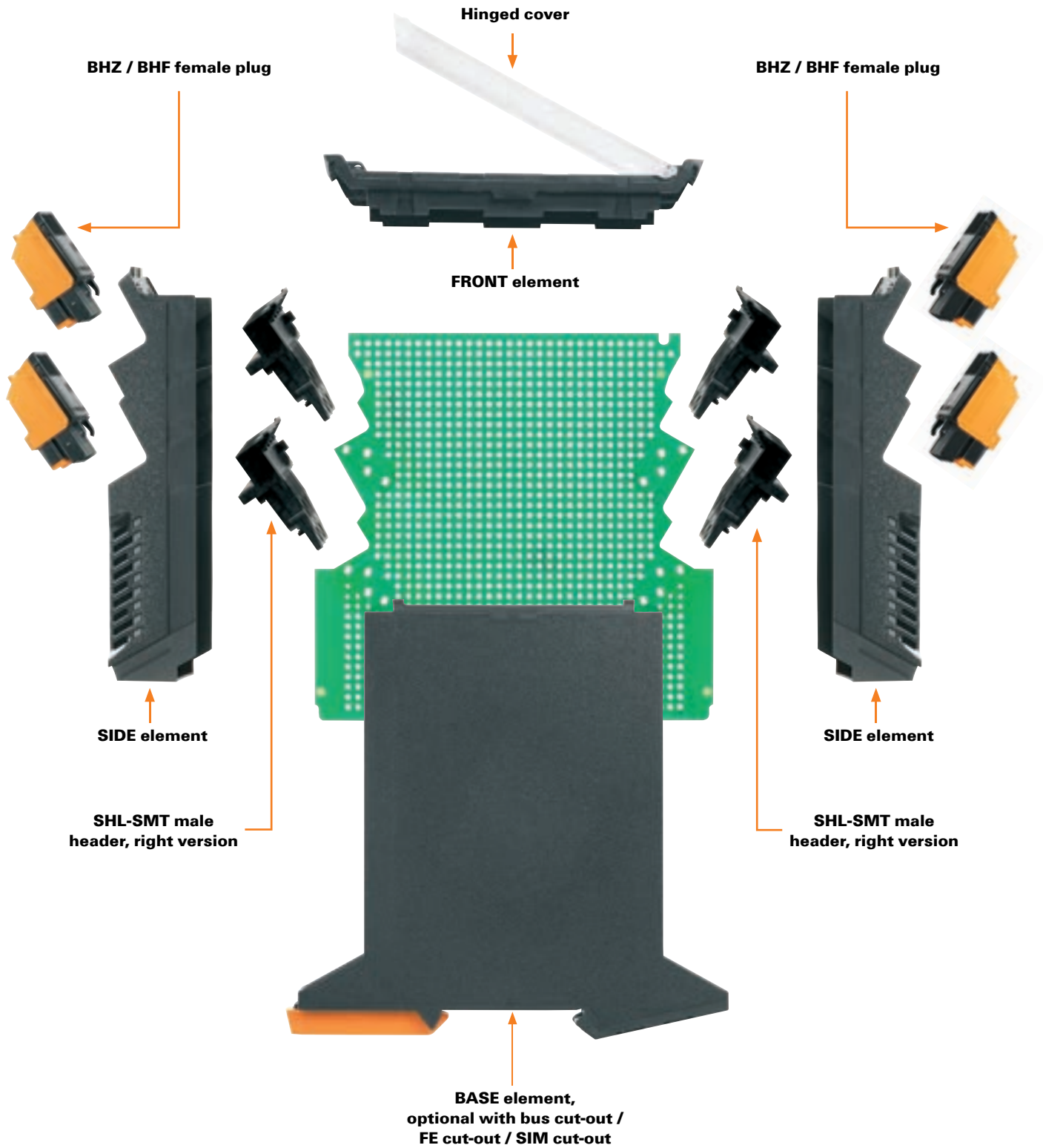





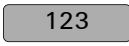



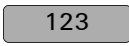





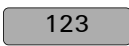

Type	Qty.	Order No.
Demonstration sample		
SK DEMO CH20M6	1	1203310000
SK DEMO CH20M12	1	1111630000
SK DEMO CH20M17	1	1167200000
SK DEMO CH20M22	1	1105600000
SK DEMO CH20M45	1	1111640000
SK DEMO CH20M67	1	1270820000
Development kit		
SK S-KIT CH20M6	1	1203290000
SK S-KIT CH20M12	1	1167190000
SK S-KIT CH20M17	1	1255820000
SK S-KIT CH20M22	1	1158390000
SK S-KIT CH20M45	1	1203350000
SK S-KIT CH20M67	1	1275810000
Hole pattern boards		
SAMPLE LP CH20M6	1	1171090000
SAMPLE LP CH20M22 PPX	1	1105580000
SAMPLE LP CH20M PPP	1	1317200000
Bus system sample		
SK S-KIT IN-RAIL BUS CH20M 12-67	1	1327040000

OMNIMATE® Housing – System CH20M

System overview

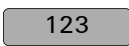

T

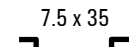
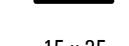
Housing elements	Description/Type	Design options
Hinged cover 	COVER (CH20Mxx C xx) <ul style="list-style-type: none"> • Transparent (light or dark) • Holds itself in place when opened • Sealable 	 Transparent  <ul style="list-style-type: none"> • Pad printing • Markable • Machinable  
Housing front 	FRONT (CH20Mxx F xx) <ul style="list-style-type: none"> • Large usable surface for the operational and display elements • Can be customised 	  Transparent   <ul style="list-style-type: none"> • Laser marking • With hinges for cover • Optionally without preparation for hinged cover
Connection area 	SIDE (CH20Mxx S xx) <ul style="list-style-type: none"> • 1 - 3 connection levels • Can be configured asymmetrically • For up to 3 circuit boards • Up to 72 wires can be connected • Up to 9 slots for female plugs 	  Transparent   <ul style="list-style-type: none"> • Laser marking • 1 - 3 plugging levels • Up to 3 circuit boards, can be populated on both sides • With or without bus cut-out
Housing base 	BASE (CH20Mxx B xx) <ul style="list-style-type: none"> • For TS 35 DIN rails • Pre-attached snap-on foot • ESD-protected (8kV acc. to EN 61000-4-2) • All elements are permanently snapped in 	  Transparent   <ul style="list-style-type: none"> • Laser marking • With or without bus / SIM cut-out • Optional FE contact • Snap-on foot in 3 standard colours (OR / SW / RD) ¹⁾
Connection system 	BHZ female plug / SHL male header <ul style="list-style-type: none"> • Reflow compatible • Integrated "AutoSet" coding optional factory-encoding • Release lever is standard • Plug can be removed in direction of operation • Can be automatically processed 	  Transparent   <ul style="list-style-type: none"> • Headers packaged in box or on tape • Clamping yoke screw connection • PUSH IN spring connection
Rail bus 	Bus <ul style="list-style-type: none"> • Integrated in TS 35 DIN rail • For power, signals and data • 5 conductor paths (max. 5 A / 63 V) • SMD-compatible bus contacts (2 A / 63 V) 	 Transparent   <ul style="list-style-type: none"> • Can be shortened to length • For 7.5 and 15 mm with finger-safe hood • Pre-assembled on request

  printable (pad printing / laser marking),
  markable,
  machinable,
  variable circuit board position

¹⁾ Other colours on request weitere Farben auf Anfrage

Design examples



Hinged cover, transparent
CH20M22 C TP
on FRONT element, black
CH20M22 F BK



Hinged cover, black
CH20M22 C BK



FRONT element, black
CH20M22 F BK



FRONT element, black:
for use without hinged cover
CH20M22 FC BK

Connection area (SIDE) with 1 – 3 connection levels



Black SIDE element
3-row,
12 connections
**CH20M22 S
PPP BK**



Black SIDE element
3-row,
8 connections
+ RJ45
**CH20M22 S
RPP BK**



Black SIDE element
2-row,
8 connections
**CH20M22 S
PPSC BK**



Black SIDE element
1-row,
4 connections
**CH20M22 S
PSCSC BK**

Connection area (SIDE) with 1 – 3 connection levels and varying connection configurations

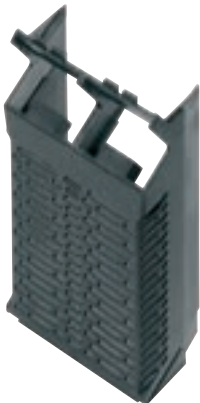

Black SIDE element
1-row 8 connections-
CH20M45 S P2SC/P2SC BK



Black SIDE element
2-row 16 connections
CH20M45 S 2PSC/2PSC BK
incl. Male header
CH20M AD-SHL

AD-SHL

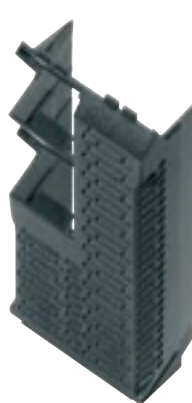

Black SIDE element
2-row 8 connections
CH20M45 S 2PSC/3SC BK

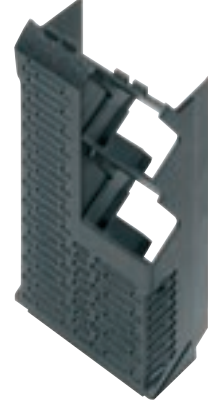

Black SIDE element
2-row 8 connections
CH20M45 S 3SC/2PSC BK

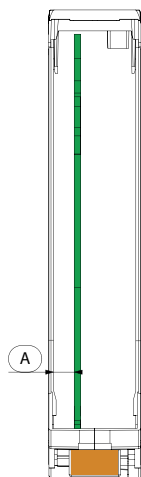

<http://www.OMNIMATE.net>

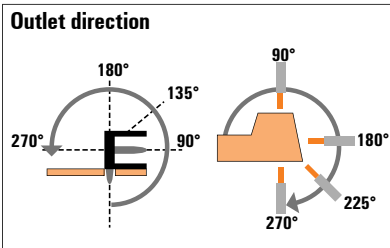

- = fits for CH20M6
- = fits for CH20M12
- = fits for CH20M17
- = fits for CH20M22, CH20M45, CH20M67



Type	Orientation	Number of poles	Alignment of connection side	Pin length	Distance moulding wall to PCB (A)
------	-------------	-----------------	------------------------------	------------	-----------------------------------

T

PCB-terminal	Clamping yoke	Type	Orientation	Number of poles	
Female plug			LHZ-SMT	90°	1
			BHZ 5.00	90°	2
			BHZ 5.00	90°	3
			BHZ 5.00	90°	4
PCB-terminal	PUSH IN	Type	Orientation	Number of poles	
Female plug			LHF-SMT	180°	1
			BHF 5.00	180°	2
			BHF 5.00	180°	3
			BHF 5.00	180°	4

PCB-terminal	Male header								
--------------	-------------	--	--	--	--	--	--	--	--

 THR solder connection	 THT solder connection								
---	---	--	--	--	--	--	--	--	--



LHZ/LHF-SMT	SHL-SMT	SHL-SMT	SHL-SMT	SHL-SMT	SHL-SMT	SHL-SMT	SHL-SMT	SHL-SMT	SHL-SMT
90°/180°	90°	90°	90°	90°	90°	90°	90°	90°	90°
1	2	3	3	4	4	2	3	4	4
left/right	left/right	left/right	left/right	left/right	left/right	left/right	left/right	left/right	left/right
1.5 mm	4.2 mm	1.5 mm	4.2 mm	1.5 mm	4.2 mm	5.9 mm	5.9 mm	5.9 mm	5.9 mm
	2.3 mm	5 mm	2.3 mm	5 mm	2.3 mm	2.3 mm	2.3 mm	2.3 mm	2.3 mm
○									
	●					●			
		●	●				●		
				●	●			●	
○									
	●					●			
		●	●				●		
				●	●			●	

T

CH20M6



Modular component housing for electronic components
 • 6.1mm wide

Technical data

Number of PCBs, max.	1
Number of connection levels, max.	8
Number of poles, max.	8
Height of components on the PCB, max.	3.5 mm
Type of assembly of the PCB	one-sided
UL 94 flammability rating	V-0
Type of insulation material	PBT
Insulating material group	II
Comparative Tracking Index (CTI)	400 ≤ CTI < 600

Demo/Sample Kit

Type	Qty.	Order No.
SK DEMO CH20M6	1	1203310000
SK S-KIT CH20M6	1	1203290000

Demo kits are already assembled in final configuration (demonstrationpieces), S-kits contain individual parts (e.g. for prototyping)

Dimensioned drawing

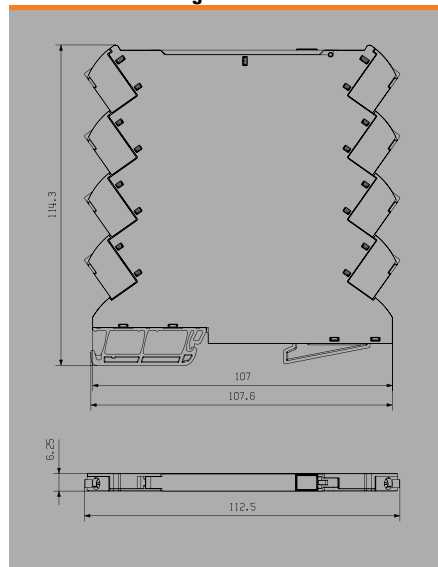

CH20M6 BP

Housing base



Ordering data

Version	Colour	Cut out in clip-on foot area for:	Type	Order No.
Housing base part				
	Agate grey		CH20M6 BP 4P-4P AGY LF 1 1293807	2771450000
	black		CH20M6 BP 4P-4P BK LF 1 1261494	2771470000
	Pebble grey		CH20M6 BP 4P-4P GY LF 1 1261516	2771460000
	red		CH20M6 BP 4P-4P RD LF 1 1261515	2771490000
	Traffic grey (RAL)		CH20M6 BP 4P-4P TGY LF 1 1293806	2771480000
Housing base part including preparation for busconnector				
	Agate grey	BUS-contact, contact not included!	CH20M6 BP 4P-4P BUS AGY LF 1 1293807	2771420000
	black	BUS-contact, contact not included!	CH20M6 BP 4P-4P BUS BK LF 1 1261494	2771430000
	Pebble grey	BUS-contact, contact not included!	CH20M6 BP 4P-4P BUS GY LF 1 1261516	2771440000
	red	BUS-contact, contact not included!	CH20M6 BP 4P-4P BUS RD LF 1 1261515	2771410000
	Traffic grey (RAL)	BUS-contact, contact not included!	CH20M6 BP 4P-4P BUS TGY LF 1 1293806	2771400000
Housing base part including functional earth connector				
	black	FE contact, Contact included!	CH20M6 BP 4P-4P FE BK 1 1261494	2435460000

Note

CH20M6 C



Ordering data

Version	Colour	Type	Order No.
Flip cover			
	black, Transparent	CH20M6 C BK 1819	2418620000
	Transparent	CH20M6 C TP 8089	1073410000

Note

CH20M6 BC

Housing side panel



Ordering data

Version	Colour	Cut out in clip-on foot area for:	Type	Order No.
Cover				
	Agate grey		CH20M6 BC 4P-4P AGY 1 1293807	2771210000
	black		CH20M6 BC 4P-4P BK 1 1261494	2771160000
	Pebble grey		CH20M6 BC 4P-4P GY 1 1261516	2771180000
	red		CH20M6 BC 4P-4P RD 1 1261515	2771190000
	Traffic grey (RAL)		CH20M6 BC 4P-4P TGY 1 1293806	2771200000
Cover including preparation for busconnector				
	Agate grey	BUS-contact, contact not included!	CH20M6 BC 4P-4P BUS AGY 1 1293807	2771220000
	black	BUS-contact, contact not included!	CH20M6 BC 4P-4P BUS BK 1 1261494	2771130000
	Pebble grey	BUS-contact, contact not included!	CH20M6 BC 4P-4P BUS GY 1 1261516	2771140000
	red	BUS-contact, contact not included!	CH20M6 BC 4P-4P BUS RD 1 1261515	2771150000
	Traffic grey (RAL)	BUS-contact, contact not included!	CH20M6 BC 4P-4P BUS TGY 1 1293806	2771170000
Note				

CH20M12



Modular component housing for electronic components

- 12.5 mm wide
- Pluggable wire connection

Technical data

Number of PCBs, max.	1
Number of connection levels, max.	3
Number of sockets for female connectors, max.	6
Number of poles, max.	12
Height of components on the PCB, max.	6.1 mm
Type of assembly of the PCB	double-sided
UL 94 flammability rating	V-0
Type of insulation material	PA 66 GF 30
Insulating material group	I
Comparative Tracking Index (CTI)	600 ≤ CTI

Demo/Sample Kit

Type	Qty.	Order No.
SK DEMO CH20M12	1	1111630000
SK S-KIT - CH20M12	1	1167190000

Demo kits are already assembled in final configuration (demonstrationpieces), S-kits contain individual parts (e.g. for prototyping)

Dimensioned drawing

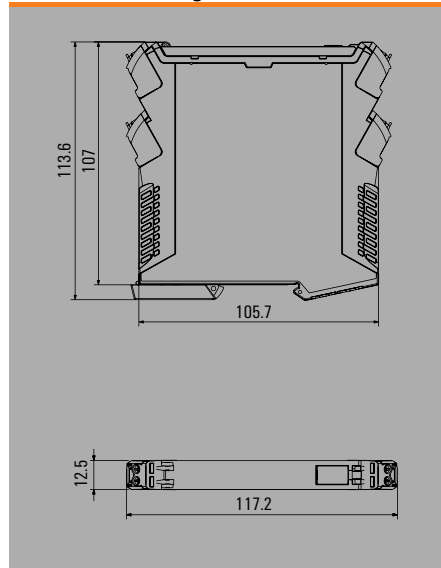

CH20M12 B

Base element



Ordering data

Version	Colour	Color of clip-on foot	Cut out in clip-on foot area for:	Type	Order No.
Housing base element					
	Agate grey	black		CH20M12 B AGY/BK 3747	2554620000
	black	black		CH20M12 B BK/BK 2010	1104170000
	black	orange		CH20M12 B BK/OR 2010	1104180000
	Light Grey	black		CH20M12 B LGY/BK 2018	1294310000
Housing base element including functional cut-out in snap-in foot area					
	black	black	BUS-contact, contact not included!	CH20M12 B BUS BK/BK 2010	1366350000
	black	orange	BUS-contact, contact not included!	CH20M12 B BUS BK/OR 2010	1176980000
	Light Grey	black	BUS-contact, contact not included!	CH20M12 B BUS LGY/BK 2018	1310520000
	black	orange	FE contact, contact not included!	CH20M12 B FE BK/OR 2010	1176990000
Note					

CH20M12 C / CH20M12 F

Cover element / Front element



Ordering data

Version	Colour	Flip cover mountable	Type	Order No.
Front element including preparation for flip cover				
	Agate grey	Yes	CH20M12 F AGY 3747	2554760000
	black	Yes	CH20M12 F BK 2010	1104190000
	Light Grey	Yes	CH20M12 F LGY 2018	1294350000
Flip cover				
	black, Transparent		CH20M12 C BK 1819	1104240000
	Transparent		CH20M12 C TP 8089	1104250000
Note				

CH20M12 S

Side element



Ordering data

Version	Colour	Number of slots for female plugs	Number of ventilation openings	Type	Order No.
Side element with three plugs per side					
	black	3	0	CH20M12 S PPP BK 2010	1174280000
	blue	3	0	CH20M12 S PPP BL 2013	1294340000
	Light Grey	3	0	CH20M12 S PPP LGY 2018	1294330000
	Agate grey	3	0	CH20M12 S PPP AGY 3747	2554690000
Side element with two plugs per side					
	Agate grey	2	1	CH20M12 S PPSC AGY 3747	2554860000
	black	2	1	CH20M12 S PPSC BK 2010	1104200000
	blue	2	1	CH20M12 S PPSC BL 2013	1104220000
	Light Grey	2	1	CH20M12 S PPSC LGY 2018	1294320000
Side element with one plug per side					
	Agate grey	1	2	CH20M12 S PSCSC AGY	2638340000
	black	1	2	CH20M12 S PSCSC BK 2010	1104210000
	blue	1	2	CH20M12 S PSCSC BL 2013	1104230000
	Light Grey	1	2	CH20M12 S PSCSC LGY 2018	1312680000
Note					

CH20M17



Modular component housing for electronic components

- 17.5 mm wide
- Pluggable wire connection

Technical data

Number of PCBs, max.	1
Number of connection levels, max.	3
Number of sockets for female connectors, max.	6
Number of poles, max.	18
Height of components on the PCB, max.	11.1 mm
Type of assembly of the PCB	double-sided
UL 94 flammability rating	V-0
Type of insulation material	PA 66 GF 30
Insulating material group	I
Comparative Tracking Index (CTI)	600 ≤ CTI

Demo/Sample Kit

Type	Qty.	Order No.
SK DEMO CH20M17	1	1167200000
SK S-KIT CH20M17	1	1255820000

Demo kits are already assembled in final configuration (demonstrationpieces), S-kits contain individual parts (e.g. for prototyping)

Dimensioned drawing

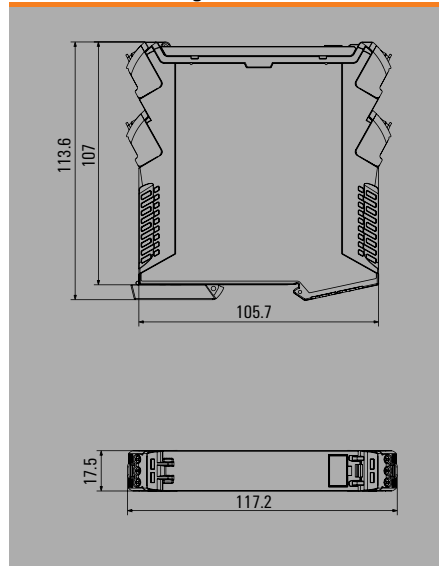

CH20M17 B

Base element



Ordering data

Version	Colour	Color of clip-on foot	Cut out in clip-on foot area for:	Type	Order No.
Housing base element					
	Agate grey	black		CH20M17 B AGY/BK 3747	2554640000
	black	black		CH20M17 B BK/BK 2010	1254120000
	black	orange		CH20M17 B BK/OR 2010	1254130000
	blue	black		CH20M17 B BL/BK 2013	1544520000
Housing base element including functional cut-out in snap-in foot area					
	black	black	BUS-contact, contact not included!	CH20M17 B BUS BK/BK 2010	1366280000
	black	orange	BUS-contact, contact not included!	CH20M17 B BUS BK/OR 2010	1254180000
	black	black	FE contact, contact not included!	CH20M17 B FE BK/BK 2010	1378000000
	black	orange	FE contact, contact not included!	CH20M17 B FE BK/OR 2010	1254190000
Note					

CH20M17 C / CH20M17 F

Cover element / Front element



Ordering data

Version	Colour	Flip cover mountable	Type	Order No.
Front element				
	black	No	CH20M17 FC BK 2010	2655080000
	black, Transparent	No	CH20M17 FC TP BK 1819	2697310000
	Traffic yellow	No	CH20M17 FC TYL 2083	2655070000
Front element including preparation for flip cover				
	Agate grey	Yes	CH20M17 F AGY 3747	2554750000
	black	Yes	CH20M17 F BK 2010	1254140000
	Light Grey	Yes	CH20M17 F LGY 2018	1529530000
Flip cover				
	black		CH20M17 C BK 1819	1254150000
	Transparent		CH20M17 C TP 8089	1254160000
Note				

CH20M17 S

Side element



Ordering data

Version	Colour	Number of slots for female plugs	Number of ventilation openings	Type	Order No.
Side element with three plugs per side					
	Agate grey	3	0	CH20M17 S PPP AGY 3747	2554700000
	black	3	0	CH20M17 S PPP BK 2010	1254170000
	Light Grey	3	0	CH20M17 S PPP LGY 2018	1529520000
	Traffic yellow	3	0	CH20M17 S PPP TYL 2083	1395730000
Note					

CH20M22



Modular component housing for electronic components

- 22.5 mm wide
- Pluggable wire connection

Technical data

Number of PCBs, max.	1
Number of connection levels, max.	3
Number of sockets for female connectors, max.	6
Number of poles, max.	24
Height of components on the PCB, max.	16.1 mm
Type of assembly of the PCB	double-sided
UL 94 flammability rating	V-0
Type of insulation material	PA 66 GF 30
Insulating material group	I
Comparative Tracking Index (CTI)	600 ≤ CTI

Demo/Sample Kit

Type	Qty.	Order No.
SK DEMO CH20M22	1	1105600000
SK S-KIT - CH20M22	1	1158390000

Demo kits are already assembled in final configuration (demonstrationpieces), S-kits contain individual parts (e.g. for prototyping)

Dimensioned drawing

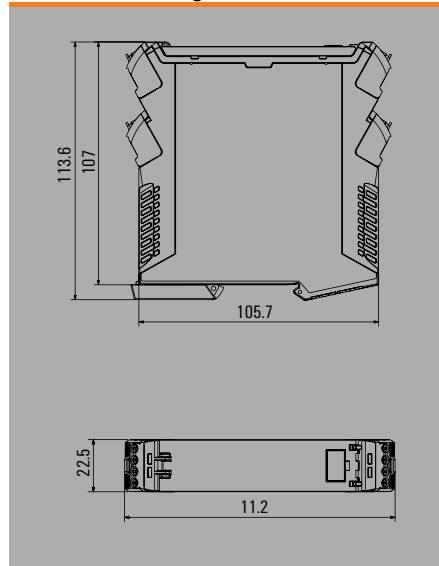

CH20M22 B

Base element



Ordering data

Version	Colour	Color of clip-on foot	Cut out in clip-on foot area for:	Type	Order No.
Housing base element					
	Agate grey	black		CH20M22 B AGY/BK 3747	1545130000
	black	black		CH20M22 B BK/BK 2010	2418630000
	black	orange		CH20M22 B BK/OR 2010	1104450000
	black	red		CH20M22 B BK/RD 2010	2555100000
	Graphite grey	black		CH20M22 B GGY/BK 2019	1073350000
	Light Grey	black		CH20M22 B LGY/BK 2018	1164670000
	red	black		CH20M22 B RD/BK 2014	1206870000
Housing base element including functional cut-out in snap-in foot area					
	black	black	BUS-contact, contact not included!	CH20M22 B BUS BK/BK 2010	1243030000
	black	orange	BUS-contact, contact not included!	CH20M22 B BUS BK/OR 2010	1177000000
	Agate grey	black	FE contact, contact not included!	CH20M22 B FE AGY/BK 3747	1472800000
	black	orange	FE contact, contact not included!	CH20M22 B FE BK/OR 2010	1177010000
	black	black	BUS-contact, FE contact, contact not included!	CH20M22 B BUS FE BK/BK 2010	1384030000
	black	orange	BUS-contact, FE contact, contact not included!	CH20M22 B BUS FE BK/OR 2010	2004700000

Note

CH20M22 C / CH20M22 F

Cover element / Front element



Ordering data

Version	Colour	Flip cover mountable	Type	Order No.
Front element				
	Agate grey	No	CH20M22 FC AGY 3747	1472810000
	black	No	CH20M22 FC BK 2010	1209350000
	Graphite grey	No	CH20M22 FC GGY 2019	1209360000
	Light Grey	No	CH20M22 FC LGY 2018	1209370000
	red	No	CH20M22 FC RD 2014	1206880000
	black, Transparent	No	CH20M22 FC TP BK 1819	2639980000
	Traffic yellow	No	CH20M22 FC TYL 2083	1304240000
Front element including preparation for flip cover				
	black	Yes	CH20M22 F AGY 3747	2554730000
	black	Yes	CH20M22 F BK 2010	2418640000
	Graphite grey	Yes	CH20M22 F GGY 2019	1073360000
	Light Grey	Yes	CH20M22 F LGY 2018	1164680000
	red	Yes	CH20M22 F RD 2014	1209380000
	Traffic yellow	Yes	CH20M22 F TYL 2083	1350230000
Flip cover				
	black, Transparent		CH20M22 C BK 1819	2418670000
	Transparent		CH20M22 C TP 8089	1073420000

Note

CH20M22 S

Side element



Ordering data

Version	Colour	Number of slots for female plugs	Number of ventilation openings	Cut out functional port	Type	Order No.
Side element with three plugs per side						
	Agate grey	3	0		CH20M22 S PPP AGY 3747	2554840000
	black	3	0		CH20M22 S PPP BK 2010	1139790000
	blue	3	0		CH20M22 S PPP BL 2013	1296430000
	Graphite grey	3	0		CH20M22 S PPP GGY 2019	1411500000
	Light Grey	3	0		CH20M22 S PPP LGY 2018	1296440000
Side element with two plugs per side						
	Agate grey	2	1		CH20M22 S PPSC AGY 3747	2554710000
	black	2	1		CH20M22 S PPSC BK 2010	2418650000
	blue	2	1		CH20M22 S PPSC BL 2013	2418660000
	Graphite grey	2	1		CH20M22 S PPSC GGY 2019	1073370000
	Light Grey	2	1		CH20M22 S PPSC LGY 2018	1164690000
	red	2	1		CH20M22 S PPSC RD 2014	1206890000
Side element with one plug per side						
	Agate grey	1	2		CH20M22 S PSCSC AGY 3747	2554850000
	black	1	2		CH20M22 S PSCSC BK 2010	1080630000
	blue	1	2		CH20M22 S PSCSC BL 2013	1070620000
	Graphite grey	1	2		CH20M22 S PSCSC GGY 2019	1451120000
	Light Grey	1	2		CH20M22 S PSCSC LGY 2018	1432860000
Side element with two plugs, one functional port per side						
	Agate grey	2	0	RJ45	CH20M22 S RPP AGY 3747	1472820000
	black	2	0	RJ45	CH20M22 S RPP BK 2010	1276590000
	Light Grey	2	0	RJ45	CH20M22 S RPP LGY 2018	1470700000
Note						

T

CH20M45



Modular component housing for electronic components

- 45 mm wide
- Pluggable wire connection

Technical data

Number of PCBs, max.	2
Number of connection levels, max.	3
Number of sockets for female connectors, max.	12
Number of poles, max.	48
Height of components on the PCB (usage of 1 PCB), max.	38.6 mm
Height of components on the PCB (usage of 2 PCB), max.	34.7 mm
Type of assembly of the PCB	double-sided
UL 94 flammability rating	V-0
Type of insulation material	PA 66 GF 30
Insulating material group	I
Comparative Tracking Index (CTI)	600 ≤ CTI

Demo/Sample Kit

Type	Qty.	Order No.
SK DEMO CH20M45	1	1111640000
SK S-KIT CH20M45	1	1203350000

Demo kits are already assembled in final configuration (demonstrationpieces), S-kits contain individual parts (e.g. for prototyping)

Dimensioned drawing

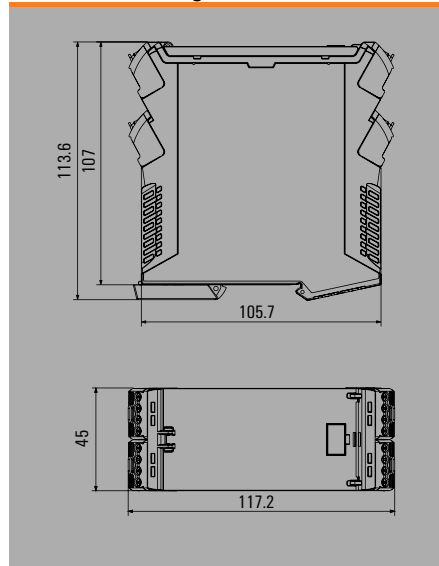

CH20M45 B

Base element



Ordering data

Version	Colour	Color of clip-on foot	Cut out in clip-on foot area for:	Type	Order No.
Housing base element					
	black	black		CH20M45 B BK/BK 2010	1104400000
	black	orange		CH20M45 B BK/OR 2010	1104410000
	black	red		CH20M45 B BK/RD 2010	2555110000
	Graphite grey	black		CH20M45 B GGY/BK 2019	1164710000
	Light Grey	black		CH20M45 B LGY/BK 2018	1164750000
	red	black		CH20M45 B RD/BK 2014	1206910000
Housing base element including functional cut-out in snap-in foot area					
	black	black	BUS-contact, contact not included!	CH20M45 B BUS BK/BK 2010	1476000000
	black	orange	BUS-contact, contact not included!	CH20M45 B BUS BK/OR 2010	1177020000
	Graphite grey	black	BUS-contact, contact not included!	CH20M45 B BUS GGY/BK 2019	1413770000
	black	orange	FE contact, contact not included!	CH20M45 B FE BK/OR 2010	1177030000
	blue	orange	FE contact, contact not included!	CH20M45 B FE BL/OR 2013	2579680000
	black	black	Micro SIM card (3FF)	CH20M45 B SIM BK/BK 2010	2738670000

Note

CH20M45 C / CH20M45 F

Cover element / Front element



Ordering data

Version	Colour	Flip cover mountable	Type	Order No.
Front element				
	black	No	CH20M45 FC BK 2010	1164800000
	Graphite grey	No	CH20M45 FC GGY 2019	1164730000
	Light Grey	No	CH20M45 FC LGY 2018	1164780000
	red	No	CH20M45 FC RD 2014	1206920000
	black, Transparent	No	CH20M45 FC TP BK 1819	2673070000
Front element including preparation for flip cover				
	black	Yes	CH20M45 F BK 2010	1104420000
	blue	Yes	CH20M45 F BL 2013	2579660000
	Graphite grey	Yes	CH20M45 F GGY 2019	1164720000
	Light Grey	Yes	CH20M45 F LGY 2018	1164770000
	red	Yes	CH20M45 F RD 2014	1209390000
	Traffic yellow	Yes	CH20M45 F TYL 2083	1337640000

Flip cover

	black, Transparent	CH20M45 C BK 1819	1104430000
	Transparent	CH20M45 C TP 8089	1104440000

Note

CH20M45 S

Side element



Ordering data

Version	Colour	Number of slots for female plugs	Number of ventilation openings	Cut out functional port	Type	Order No.
Side element with six plugs per side						
	black	6	0		CH20M45 S 3P/3P BK 2010	1137730000
	blue	6	0		CH20M45 S 3P/3P BL 2013	2624760000
	Light Grey	6	0		CH20M45 S 3P/3P LGY 2018	1444330000
	Traffic yellow	6	0		CH20M45 S 3P/3P TYL 2083	1482830000
Side element with four plugs per side						
	black	4	2		CH20M45 S 2PSC/2PSC BK 2010	1111720000
	blue	4	2		CH20M45 S 2PSC/2PSC BL 2013	1476910000
	Graphite grey	4	2		CH20M45 S 2PSC/2PSC GGY 2019	1164740000
	Light Grey	4	2		CH20M45 S 2PSC/2PSC LGY 2018	1164790000
	red	4	2		CH20M45 S 2PSC/2PSC RD 2014	1206930000
	Traffic yellow	4	2		CH20M45 S 2PSC/2PSC TYL 2083	1327990000
Side element with two plugs per side						
	black	2	4		CH20M45 S P2SC/P2SC BK 2010	1166180000
	blue	2	4		CH20M45 S P2SC/P2SC BL 2013	2579670000
Side element with two plugs per side, vertical left						
	black	2	4		CH20M45 S 2PSC/3SC BK 2010	1137740000
	Light Grey	2	4		CH20M45 S 2PSC/3SC LGY 2018	2585480000
Side element with two plugs per side, vertical right						
	black	2	4		CH20M45 S 3SC/2PSC BK 2010	1137750000
	Light Grey	2	4		CH20M45 S 3SC/2PSC LGY 2018	2585490000
Side element with three plugs, one functional port preparation per side						
	black	3	2	RJ45	CH20M45 S RPSC/2PSC BK 2010	1500040000
Side element with two plugs, one functional port per side						
	black	2	2	Mini-USB, RJ45	CH20M45 S 2PSC/RUSC BK 2010	1500050000
Note						

T

CH20M67



Modular component housing for electronic components

- 67.5 mm wide
- Pluggable wire connection

Technical data

Number of PCBs, max.	3
Number of connection levels, max.	3
Number of sockets for female connectors, max.	18
Number of poles, max.	72
Height of components on the PCB (usage of 1 PCB), max.	61.1 mm
Height of components on the PCB (usage of 2 PCB), max.	57.2 mm
Height of components on the PCB (usage of 3 PCB), max.	34.7 mm
Type of assembly of the PCB	double-sided
UL 94 flammability rating	V-0
Type of insulation material	PA 66 GF 30
Insulating material group	I
Comparative Tracking Index (CTI)	600 ≤ CTI

Demo/Sample Kit

Type	Qty.	Order No.
SK DEMO CH20M67	1	1270820000
SK S-KIT CH20M67	1	1275810000

Demo kits are already assembled in final configuration (demonstrationpieces), S-kits contain individual parts (e.g. for prototyping)

Dimensioned drawing

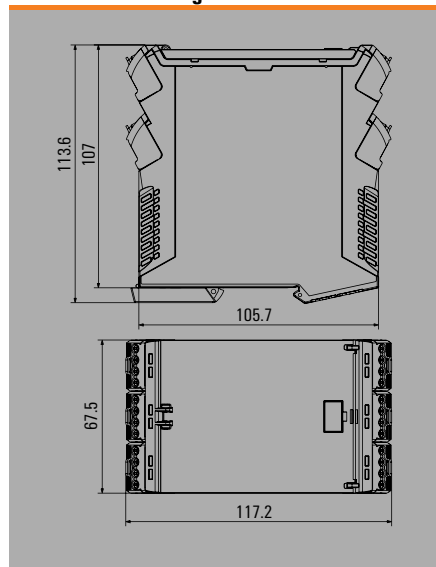

CH20M67 B

Base element



Ordering data

Version	Colour	Colour of clip-on foot	Cut out in clip-on foot area for:	Type	Order No.
Housing base element					
	black	black		CH20M67 B BK/BK 2010	1235270000
	black	orange		CH20M67 B BK/OR 2010	1235250000
	Traffic yellow	black		CH20M67 B TYL/BK 2083	2653360000

Housing base element including functional cut-out in snap-in foot area					
	black	black	BUS-contact, contact not included!	CH20M67 B BUS BK/BK 2010	1490820000
	black	orange	BUS-contact, contact not included!	CH20M67 B BUS BK/OR 2010	1247240000
	Graphite grey	black	BUS-contact, contact not included!	CH20M67 B BUS GGY/BK 2019	1413780000
	black	orange	FE contact, contact not included!	CH20M67 B FE BK/OR 2010	1247250000
black	orange	2x FE contact, contact not included!	CH20M67 B 2FE BK/OR	2745200000	

Note

CH20M67 F

Front element



Ordering data

Version	Colour	Flip cover mountable	Type	Order No.
Front element				
	black	No	CH20M67 FC BK 2010	1235310000
	Graphite grey	No	CH20M67 FC GGY 2019	1413810000
	black	No	CH20M67 FC TYL 2083	2653370000

Note

CH20M67 S

Side element



Ordering data

Version	Colour	Number of slots for female plugs	Number of ventilation openings	Type	Order No.
Side element with nine plugs per side					
	black	9	0	CH20M67 S 3P/3P/3P BK 2010	1420370000
	Graphite grey	9	0	CH20M67 S 3P/3P/3P GGY 2019	1455770000
	Traffic yellow	9	0	CH20M67 S 3P/3P/3P TYL 2083	2653380000
Side element with six plugs per side					
	black	6	3	CH20M67 S 2PSC/2PSC/2PSC BK 2010	1235320000
	Graphite grey	6	3	CH20M67 S 2PSC/2PSC/2PSC GGY 2019	1413820000
Note					

LHZ, LHF

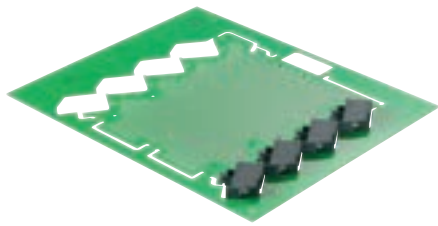

THR PCB terminal for 6 mm housings,
CH20M6 reflow-compatible,
Pole count: 1
solder pin length: 1.5 mm
Orientation: 90° / 180°

Technical data

Insulating material	LCP
Flammability rating (UL 94)	VO
Rated voltage	250 V
Rated current	13 A

Conductors that can be connected

Clamping range	0.13 mm ² - 2.5 mm ²
Wire cross-section, AWG, min.	AWG 26 - AWG 14
Solid, min. H05(07) V-U	0.2 mm ² - 2.5 mm ²
Flexible, min. H05(07) V-K	0.2 mm ² - 2.5 mm ²
With wire-end ferrule with DIN 46 228/4, min.	0.2 mm ² - 2.5 mm ²

Rated data according to DIN IEC

Rated voltage for surge voltage class / contamination degree III/3	250 V
Rated impulse voltage for surge voltage class / contamination degree III/3	4 kV
Rated voltage for surge voltage class / contamination degree III/2	320 V
Rated impulse voltage for surge voltage class / contamination degree III/2	4 kV
Rated voltage for surge voltage class / contamination degree II/2	500 V
Rated impulse voltage for surge voltage class / contamination degree II/2	4 kV

Dimensional drawing

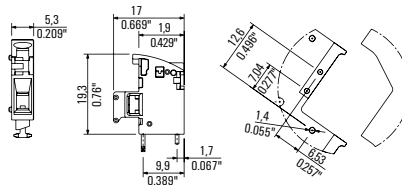

Version left

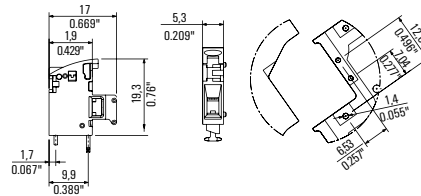

Version right

LHZ-SMT 1.5SN BK

PCB terminal with screw connection



Ordering data

Type / Version	Qty.	Order No.
LHZ-SMT L 1.5SN BK RL Left version, tape-on-reel	432	2418580000
LHZ-SMT R 1.5SN BK RL Right version, tape-on-reel	432	2418590000
LHZ-SMT L 1.5SN BK BX Left version, Box packaging	306	1137870000
LHZ-SMT R 1.5SN BK BX Right version, Box packaging	306	1137880000

LHF-SMT 1.5SN BK/GY

PCB terminal with PUSH IN connection



Ordering data

Type / Version	Qty.	Order No.
LHF-SMT L 1.5SN BK/GY RL Left version, tape-on-reel	432	2581750000
LHF-SMT R 1.5SN BK/GY RL Right version, tape-on-reel	432	2581380000
LHF-SMT L 1.5SN BK/GY BX Left version, Box packaging	306	on request
LHF-SMT R 1.5SN BK/GY BX Right version, Box packaging	306	on request

Derating curve

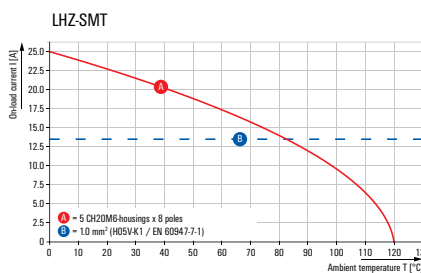

Note: Rated data according to UL - refer to the online data sheet

Circuit board positions in CH20M

Housing width (mm)	12.5	17.5	22.5	45.0	67.5
Number of circuit boards	1	1	1	2	3
Positions per circuit board	1	2	2	4	4



Dimensional sketch

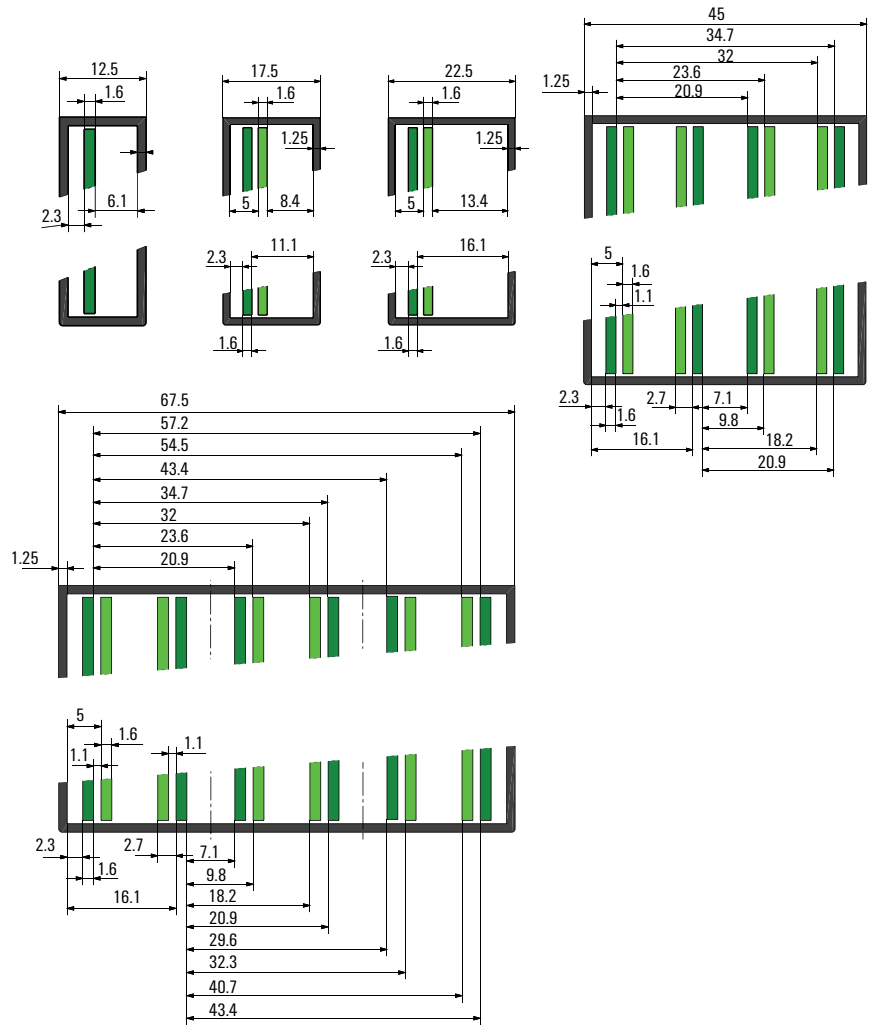

Features of the BHZ/BHF/SHL-SMT connector system

- Clamping yoke screw connection – with “WireReady”, wire guard protection and plus/minus screw
- Integrated, captive coding (with “AutoSet” function) protects against accidental mismatch
- Leading contact on the male headers
- Finger-safety provided for both, male and female connector
- PUSH IN wire connection for especially fast wiring of electronics

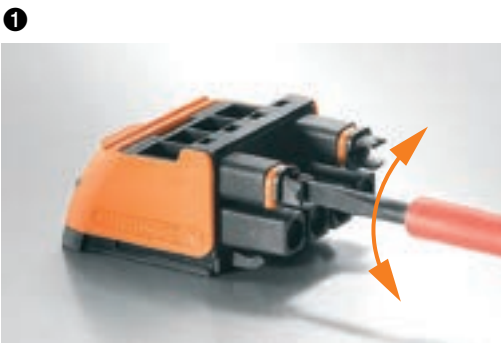

Coding can be set with one of 16 possible configurations

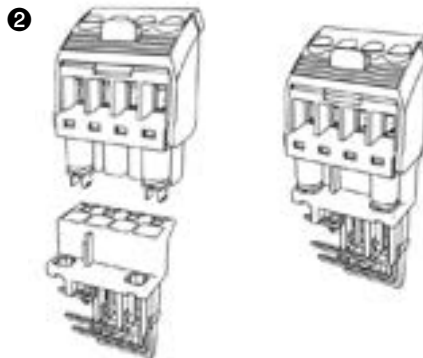

Connecting the female connector

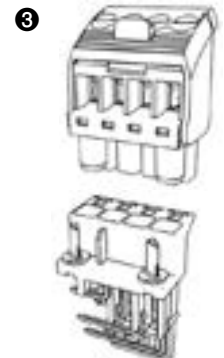

Male header coding transferred to module

SHL-SMT



THR male header for modular housing CH20M12-67
 Can be reflow soldered, resistant to high temperatures
 The position of the PCB (see also dimensional sketch) is determined through the configuration of the pin headers
 Suffix 1.5: PCB position 5,0 mm / pin length 1,5 mm (Reflow)
 Suffix 4.2: PCB position 2,3 mm / pin length 1,5 mm (Reflow)
 Suffix 5.9: PCB position 2,3 mm / pin length 3,2 mm (Wave)

Technical data

Insulating material	LCP
Flammability rating (UL 94)	VO
Rated voltage	250 V
Rated current	10 A

SHL-SMT 5.00/GL BX



Left-sided pin header
 Box packaging

Ordering data

Type / Version	Poles	Qty.	Order No.
SHL-SMT 5.00/02GL 4.2BX	2	150	1069620000
SHL-SMT 5.00/02GL 5.9BX	2	150	1069750000
SHL-SMT 5.00/03GL 1.5BX	3	120	1063210000
SHL-SMT 5.00/03GL 4.2BX	3	120	1069630000
SHL-SMT 5.00/03GL 5.9BX	3	120	1069760000
SHL-SMT 5.00/04GL 1.5BX	4	108	1063220000
SHL-SMT 5.00/04GL 4.2BX	4	108	1069640000
SHL-SMT 5.00/04GL 5.9BX	4	108	1069770000

Dimensional drawing

Version left
 2-pole

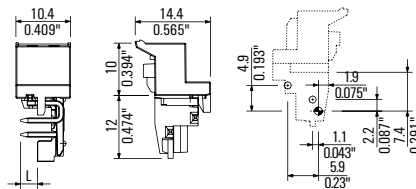

3-pole

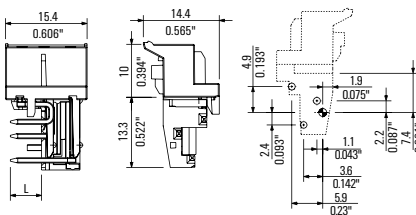

SHL-SMT 5.00/GL RL



Left-sided pin header
 Tape-on-reel

Ordering data

Type / Version	Poles	Qty.	Order No.
SHL-SMT 5.00/02GL 4.2RL	2	260	1069650000
SHL-SMT 5.00/02GL 5.9RL	2	260	1069780000
SHL-SMT 5.00/03GL 1.5RL	3	175	1063240000
SHL-SMT 5.00/03GL 4.2RL	3	175	1069660000
SHL-SMT 5.00/03GL 5.9RL	3	175	1069790000
SHL-SMT 5.00/04GL 1.5RL	4	130	1063250000
SHL-SMT 5.00/04GL 4.2RL	4	130	1069670000
SHL-SMT 5.00/04GL 5.9RL	4	130	1069810000

Dimensional drawing

Version right
 2-pole

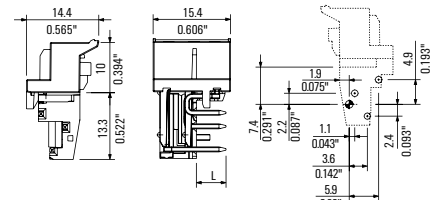

3-pole

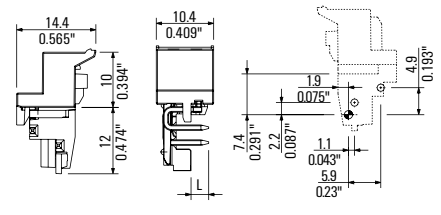

Rated data when used together with BHZxx female plug; refer to page N.32

SHL-SMT 5.00/GR BX



Version right
Box packaging

SHL-SMT 5.00/GR RL



Version right
Tape-on-reel

Ordering data

Type / Version	Poles	Qty.	Order No.
SHL-SMT 5.00/02GR 4.2BX	2	150	1069550000
SHL-SMT 5.00/02GR 5.9BX	2	150	1069680000
SHL-SMT 5.00/03GR 1.5BX	3	120	1063140000
SHL-SMT 5.00/03GR 4.2BX	3	120	1069560000
SHL-SMT 5.00/03GR 5.9BX	3	120	1069690000
SHL-SMT 5.00/04GR 1.5BX	4	108	1063150000
SHL-SMT 5.00/04GR 4.2BX	4	108	1069570000
SHL-SMT 5.00/04GR 5.9BX	4	108	1069710000

Dimensional drawing

Version left
4-pole

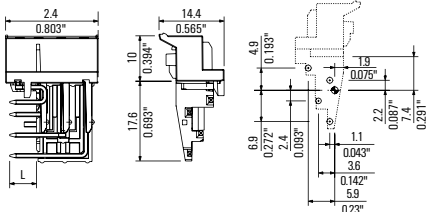

Ordering data

Type / Version	Poles	Qty.	Order No.
SHL-SMT 5.00/02GR 4.2RL	2	260	1069580000
SHL-SMT 5.00/02GR 5.9RL	2	260	1069720000
SHL-SMT 5.00/03GR 1.5RL	3	175	1063170000
SHL-SMT 5.00/03GR 4.2RL	3	175	1069590000
SHL-SMT 5.00/03GR 5.9RL	3	175	1069730000
SHL-SMT 5.00/04GR 1.5RL	4	130	1063180000
SHL-SMT 5.00/04GR 4.2RL	4	130	1069610000
SHL-SMT 5.00/04GR 5.9RL	4	130	1069740000

Dimensional drawing

Version right
4-pole

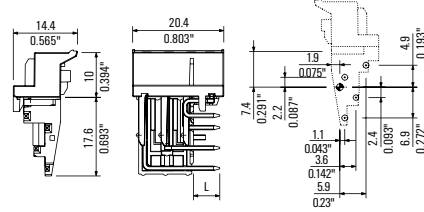

BHZ, BHF



Female plug for modular housing CH20M12-67
5.00 mm, PUSH IN or Screw connection, integrated coding, release lever can be colour coded

Available in other colours on request

Technical data

Insulating material	PA
Flammability rating (UL 94)	V0
Rated voltage	250 V
Rated current	10 A

Conductors that can be connected

Clamping range	0.13 mm ² - 3.31 mm ²
Wire cross-section, AWG, min	AWG 26 - AWG 12
Solid, min. H05(07) V-U	0.2 mm ² - 2.5 mm ²
Flexible, min. H05(07) V-K	0.2 mm ² - 2.5 mm ²
With wire end ferrule, acc. to DIN 46 228/1, max.	0.2 mm ² - 2.5 mm ²
With wire-end ferrule with DIN 46 228/4, min.	0.2 mm ² - 2.5 mm ²

Rated data according to DIN IEC

Rated current, Max. pole count (Tu=20 °C)	10 A
Rated current, Max. pole count (Tu=40 °C)	9 A
Rated voltage for surge voltage class / contamination degree III/3	250 V
Rated impulse voltage for surge voltage class / contamination degree III/3	4 kV
Rated impulse voltage for surge voltage class / contamination degree III/2	4 kV
Rated voltage for surge voltage class / contamination degree III/2	320 V
Rated voltage for surge voltage class / contamination degree II/2	400 V
Rated impulse voltage for surge voltage class / contamination degree II/2	4 kV

Note: Rated data according to UL - refer to the online data sheet

Dimensional drawing

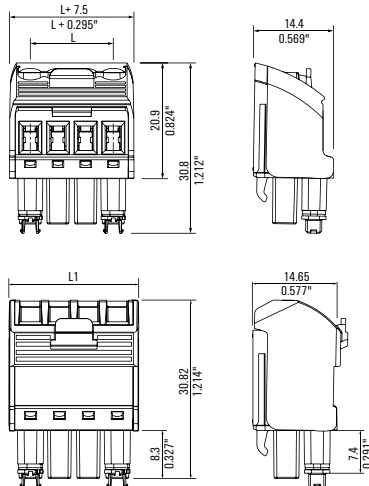

Derating curve

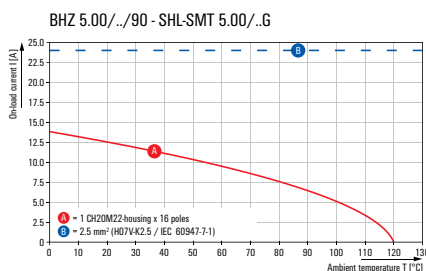
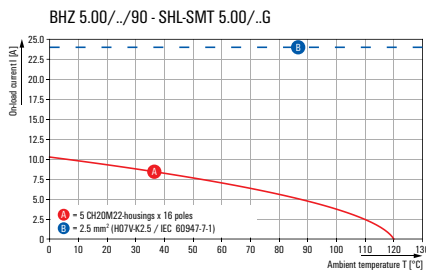

BHZ 5.00/90 BK/OR

Female header with screw connection



Ordering data

Type / Version	Poles	Qty.	Order No.
BHZ 5.00/02/90LH BK/OR	2	150	1063260000
BHZ 5.00/03/90LH BK/OR	3	108	1063270000
BHZ 5.00/04/90LH BK/OR	4	78	1063280000

BHF 5.00/180LH BK/OR

Female header with PUSH IN connection



Ordering data

Type / Version	Poles	Qty.	Order No.
BHF 5.00/02/180LH BK/OR	2	150	1988380000
BHF 5.00/03/180LH BK/OR	3	108	1989210000
BHF 5.00/04/180LH BK/OR	4	78	1989190000

BHZ 5.00/90 BK/BK

Female header with PUSH IN connection



BHZ 5.00/90 BK/BL

Female header with PUSH IN connection



Accessories

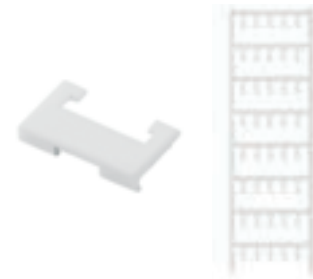

Marker for release lever

Ordering data

Type / Version	Poles	Qty.	Order No.
BHZ 5.00/02/90LH BK/BK	2	150	1069330000
BHZ 5.00/03/90LH BK/BK	3	108	1069340000
BHZ 5.00/04/90LH BK/BK	4	78	1069350000

Ordering data

Type / Version	Poles	Qty.	Order No.
BHZ 5.00/02/90LH BK/BL	2	150	1069360000
BHZ 5.00/03/90LH BK/BL	3	108	1069370000
BHZ 5.00/04/90LH BK/BL	4	78	1069380000

Ordering data

Type / Version	Poles	Qty.	Order No.
ESG 6.6/11 BHZ 5.00/02	2	200	1082490000
ESG 6.6/15 BHZ 5.00/03	3	200	1082520000
ESG 6.6/20 BHZ 5.00/04	4	200	1082540000
ESG 6.6/11 BHZ 5.00 SDR	2	200	1346330000
ESG 6.6/15 BHZ 5.00 SDR	3	200	1346320000
ESG 6.6/20 BHZ 5.00 SDR	4	40	1221520000

T

BHF 5.00/180LH BK/BK

Female header with PUSH IN connection



BHF 5.00/180LH BK/BL

Female header with PUSH IN connection



Ordering data

Type / Version	Poles	Qty.	Order No.
BHF 5.00/02/180LH BK/BK	2	150	1497740000
BHF 5.00/03/180LH BK/BK	3	108	1497670000
BHF 5.00/04/180LH BK/BK	4	78	1497500000

Ordering data

Type / Version	Poles	Qty.	Order No.
BHF 5.00/02/180LH BK/BL	2	150	1989220000
BHF 5.00/03/180LH BK/BL	3	108	1989200000
BHF 5.00/04/180LH BK/BL	4	78	1989090000

SR-SMD

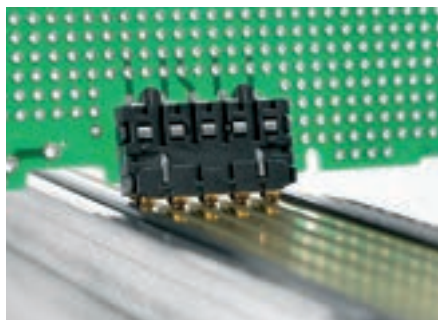

Bus contact block
Reflow-compatible, resistant to high temperatures,
5-pole, for rail bus

Technical data

Insulating material	LCP
Flammability rating (UL 94)	V0
Rated voltage IEC	63 V AC
Rated current IEC CH20M6	2 A (at 70 °C)
Rated current IEC CH20M22	4 A (at 70 °C)
Rated voltage UL	150 V
Rated current UL	5 A

Derating curve

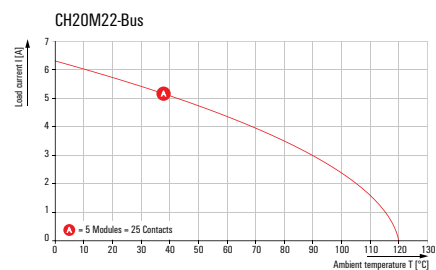
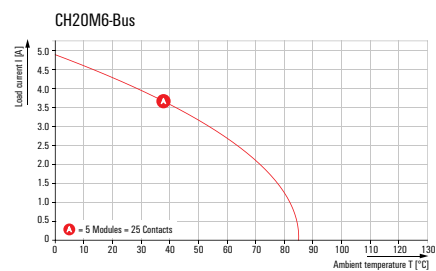

Note: Framework conditions of rating data available on request

SR-SMD

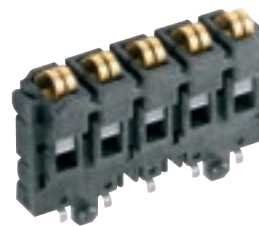

Bus contact for CH20M6

Dimensional drawing

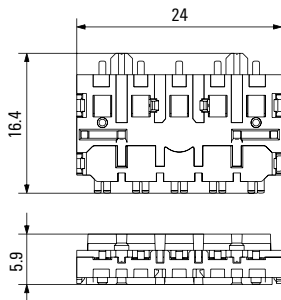

For CH20M6

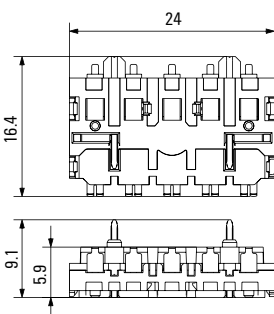

With centre solder flange for CH20M12-67

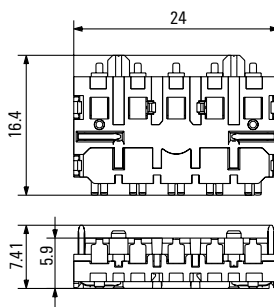

With solder flange for CH20M12-67

Ordering data

Type / Version	Qty.	Order No.
SR-SMD 4.50/05/90 AU BK BX	72	1155840000
SR-SMD 4.50/05/90 AU BK RL	300	1155850000

"BX" means box packaging, "RL" means tape-on-reel

SR-SMD

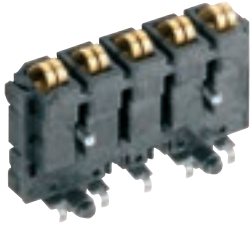

Bus contact with centre solder flange for CH20M12-67

SR-SMD

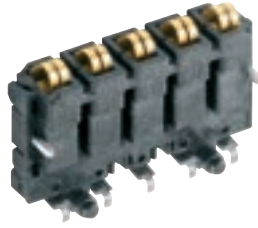

Bus contact with solder flange for CH20M12-67

CH20M FE 12-67

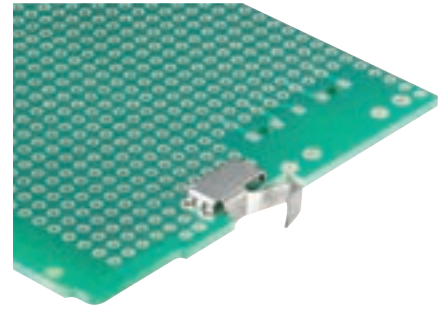

FE contact for CH20M 12-67

Ordering data

Type / Version	Qty.	Order No.
SR-SMD 4.50/05/90LFM AU BK BX	72	1155870000
SR-SMD 4.50/05/90LFM 3.2AU BK RL	300	1155880000

Ordering data

Type / Version	Qty.	Order No.
SR-SMD 4.50/05/90LF AU BK BX	72	1155890000
SR-SMD 4.50/05/90LF 1.5AU BK RL	300	1155900000

Ordering data

Type / Version	Qty.	Order No.
CH20M FE 12-67 1.5SN RL	750	1189370000
CH20M FE 12-67 3.2SN RL	750	1264240000

"BX" means box packaging, "RL" means tape-on-reel

"BX" means box packaging, "RL" means tape-on-reel

CH20M BUS-PROFIL TS35x7.5/1000

Support section for bus circuit board



- Support section for TS 35 x 7.5
- Length: 250, 500 or 750 mm

Ordering data

Type	Qty.	Order No.
CH20M BUS-PROFIL TS35x7.5/250	10	1248150000
CH20M BUS-PROFIL TS35x7.5/500	10	1248160000
CH20M BUS-PROFIL TS35x7.5/750	5	1248170000

Note: Length specification /XXX = 250, 500 or 750 mm. Other lengths available on request.

CH20M BUS-PROFIL TS35x15/1000

Support section for bus circuit board



- Support section for TS 35 x 15
- Length: 250, 500 or 750 mm

Ordering data

Type	Qty.	Order No.
CH20M BUS-PROFIL TS35x15/250	5	1248180000
CH20M BUS-PROFIL TS35x15/500	5	1248190000
CH20M BUS-PROFIL TS35x15/750	5	1248210000

Note: Length specification /XXX = 250, 500 or 750 mm. Other lengths available on request.

CH20M BUS 4.50/05 AU/1000

Bus PCB



- Bus circuit board for use on TS 35 x 7.5 and TS 35 x 15
- Length: 250, 500 or 750 mm
- Five conductor paths, gold-plated
- Electrical rating: 63 V AC, 5 A/conductor path

Ordering data

Type	Qty.	Order No.
CH20M BUS 4.50/05 AU/250	10	1248220000
CH20M BUS 4.50/05 AU/500	10	1248230000
CH20M BUS 4.50/05 AU/750	5	1248240000

Note: Length specification /XXX = 250, 500 or 750 mm. Other lengths available on request.

CH20M BUS-ADP TS35/1000

Cover plate



- Cover plate for DIN rail bus
- Length: 250, 500 or 750 mm

Ordering data

Type	Qty.	Order No.
CH20M BUS-ADP TS35/250	10	1248250000
CH20M BUS-ADP TS35/500	10	1248260000
CH20M BUS-ADP TS35/750	5	1248270000

Note: Length specification /XXX = 250, 500 or 750 mm. Other lengths available on request.

CH20M BUS-AP LI TS35x7.5 & 15

End plate



- End plate for DIN rail bus
- Fits on TS 35 x 7.5 and TS 35 x 15
- left

Ordering data

Type	Qty.	Order No.
CH20M BUS-AP LI TS35x7.5 & 15	50	1193160000

CH20M BUS-AP RE TS35x7.5 & 15

End plate



- End plate for DIN rail bus
- Fits on TS 35 x 7.5 and TS 35 x 15
- right

Ordering data

Type	Qty.	Order No.
CH20M BUS-AP RE TS35x7.5 & 15	50	1193170000

SET CH20M BUS 250MM TS 35X15

Set



- SET consists of one each of
CH20M BUS 4.50/05 AU/250
CH20M BUS-ADP TS 35/250
CH20M BUS-AP LI TS 35X7.5 & 15
CH20M BUS-AP RE TS 35X7.5 & 15
CH20M BUS-PROFIL TS 35X15/250

Ordering data

Type	Qty.	Order No.
SET CH20M BUS 250MM TS 35X15	1	1335150000

SET CH20M BUS 250MM TS 35X7.5

Set



- SET consists of one each of
CH20M BUS 4.50/05 AU/250
CH20M BUS-ADP TS 35/250
CH20M BUS-AP LI TS 35X7.5 & 15
CH20M BUS-AP RE TS 35X7.5 & 15
CH20M BUS-PROFIL TS 35X7.5/250

Ordering data

Type	Qty.	Order No.
SET CH20M BUS 250MM TS 35X7.5	1	1335140000

TS 35x7.5 / TS 35x15

Mounting rail

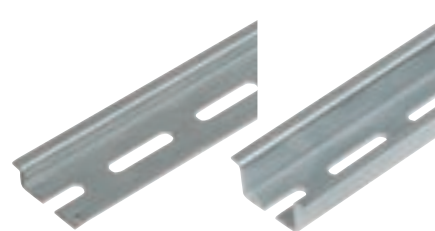

- Mounting rail with slot
- Steel, galvanised and passivated

Ordering data

Type	Qty.	Order No.
TS 35X7.5/LL 1M/ST/ZN	10	0514510000
TS 35X15/LL 1M/ST/ZN	10	0236510000

OMNIMATE® Housing MICROBOX / TERMINALBOX

The MICROBOX and TERMINALBOX series of small housings are the perfect solution for miniature sliced applications or for the protective circuitry used in connection with terminal blocks.

Up to 6 wires can be connected using the integrated (but high-performance) clamping-yoke screw or tension-clamp wire connection mechanisms.

Because of its closed construction, each individual MICROBOX is finger-safe. The TERMINALBOX can be aligned side-by-side without end or closed off using an end plate.

Pluggable cross-connectors from our terminal block line allow simple, safe power distribution of up to 32 A.

T

Secure contacts

The TERMINALBOX MCZ 1.5 can optionally be equipped with a contact element that automatically establishes contact with the rail when the housing is snapped on.



Compact integration

With a width of only 6.00 mm, the TERMINALBOX MCZ 1.5 provides enough space for a miniature circuit board and 5 tension clamp connection for wires up to 1.5 mm².

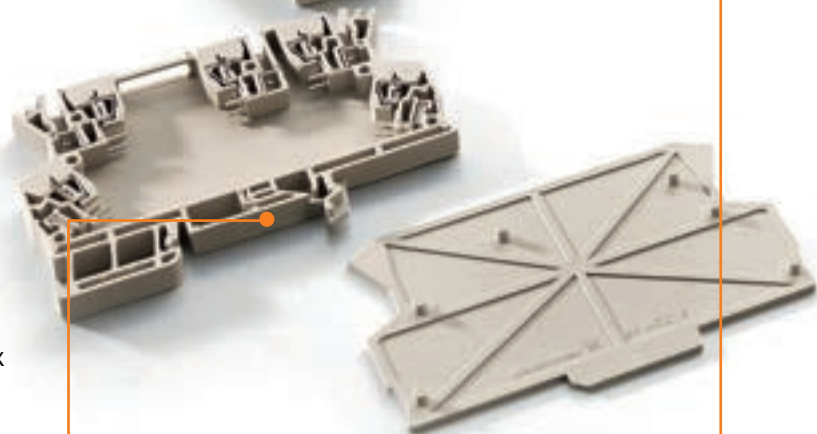
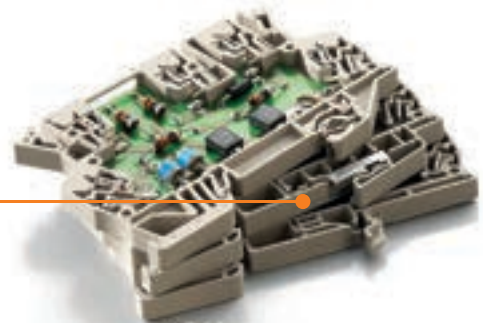
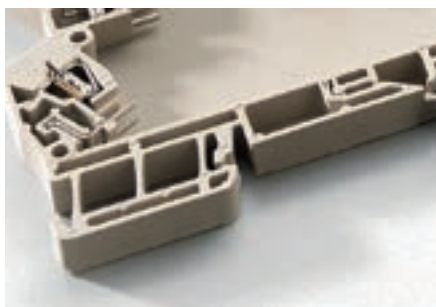

Seamlessly connected

High-power cross-connectors allow power (up to 32 A) to be easily and quickly distributed on up to three levels.



Easy to operate

The transparent hinged covers make adjustments simple (for example, using DIP switches). Labelling is also possible.

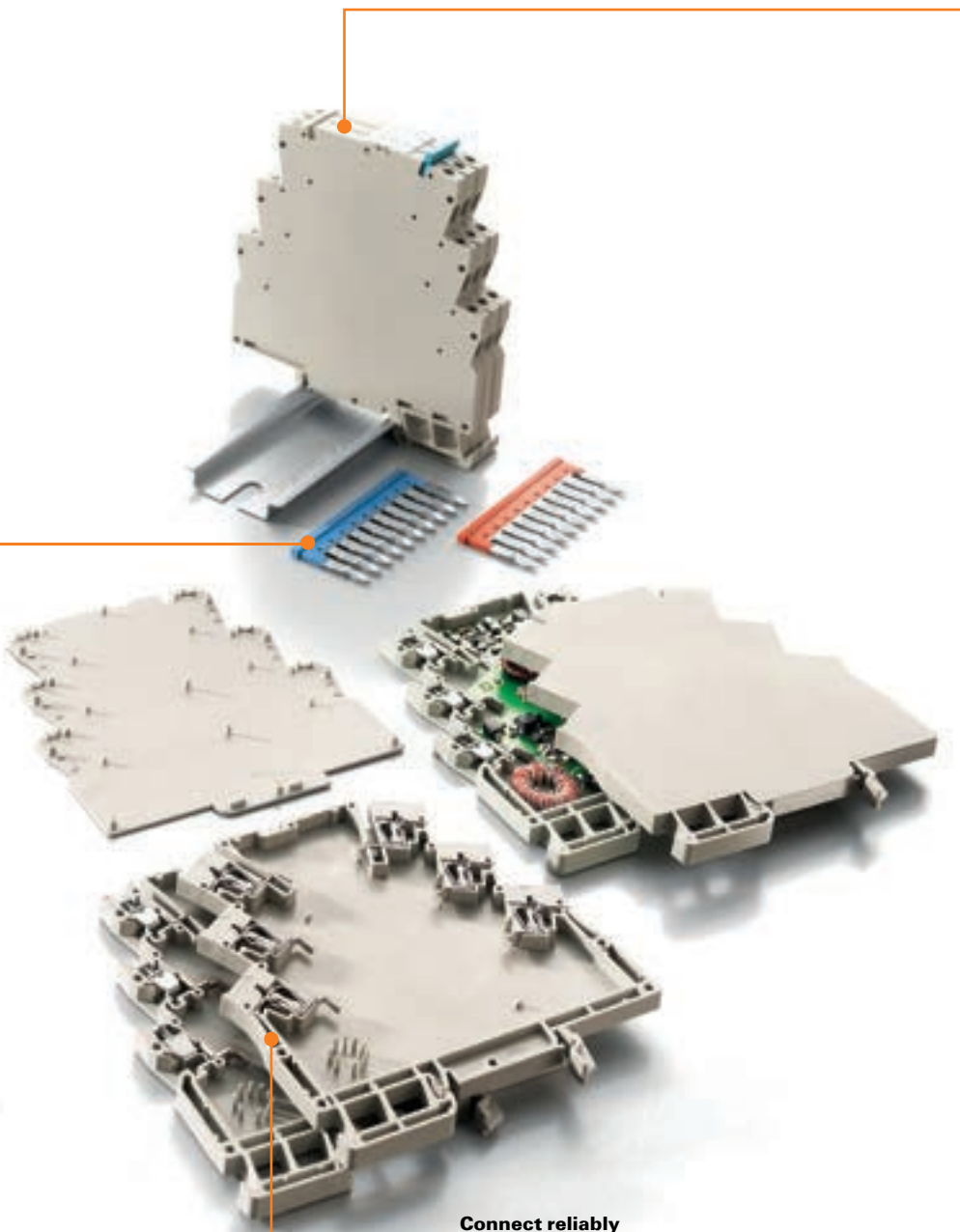

Connect reliably

The MICROBOX provides a permanent, secure clamp connection for 6 wires up to 2.5 mm² (MHS 6 with clamping yoke screw connection) or up to 1.5 mm² (MHZ 6 with tension-clamp spring connection).



MICROBOX MHS 6

Miniature sliced-section housing in 6.1 mm width A total of 6 clamping yoke screw connections (for 2.5 mm² wires) can be manually or selectively wave soldered.



MICROBOX MHZ 6

Miniature sliced-section housing in 6.1 mm width A total of 6 tension clamp connection (for 1.5 mm² wires) can be manually or selectively wave soldered.



TERMINALBOX MCZ 1.5

Terminal-block-format open housings with tension clamp connection for wires up to 1.5 mm². A total of 5 connection elements can be manually or selectively wave soldered.

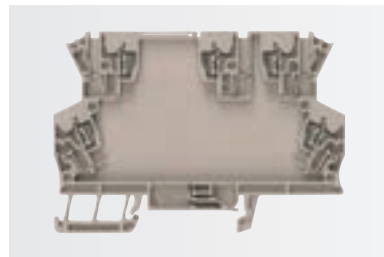

T

MCZ 1.5

The transparent hinged top plate is used for labelling and calibration. Maximum equipment level requires 2 short and 3 long current bars. The space available and the number of connections can be doubled using the frame. CAD Models that ease the production of layouts and equipping of boards (details of blocked area, max. component heights, pads, etc.), are available on request. The MCZ housing kit consists of:

- 1 terminal holder
- 1 top plate
- 1-5 current bars with tension clamp
- 1 end plate (if required)

Technical data

General data	
Dimensions W x L x H (w. TS 35 x 7.5)	mm
No. of connections	total
Access for calibration	
Shielding	
Contact to the mounting rail	
Number of PCB per module	
PCB-connection	
Thickness of PCB	
Ingress protection class	
Tightening torque range	
Stripping length	
Pollution severity	
Material	
Flammability class UL 94	
Colour of insulating material	
Clampable conductors (H05V/H07V)	
Solid	mm ²
Flexible	mm ²
Max. conductor AWG	
Plug gauge to 60947-1	
Note	

Ordering data

Individual parts	
For mounting rail TS 35	with connection element for connection element for mounting rail contact, for connection element
For mounting rail TS 32	with connection element
Frame for TS 35	
Frame for TS 35	for connection element
Frame for TS 32	
Top part	open closed
Current bars (w. tension clamp)	short version long version
Current bars	horizontal vertical
Clamp. yoke unit	clamp. yoke + screw
Screw	
Clamping yoke	
Mounting rail contact	
Housing cover	
Note	

Accessories

End plate	
Cross-connection	
Note	

MCZ 1.5

Tension clamp connection

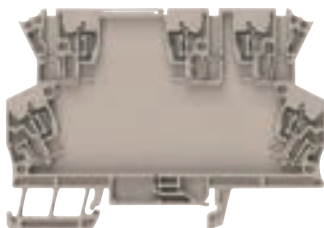

6 / 91.3 / 63.5	
5	
Movable top plate	
not available	
Earthing-contact	
1	
soldered connection, directly	
1.0 (+ 0.2) mm	
IP 20	
6 mm	
3	
PA	
V0	
beige/black	
Screw connection	
Tension clamp connection	
	0.2...1.5
	0.2...1.5
	AWG 26...AWG 16
Note	

Type	Qty.	Order No.
MCZ 5	10	8857560000
GH MCZ1.5	1	2224220000
GH MCZUE1.5/UE	1	2312290000
RA MCZ1.5	25	2224240000
KOPL MCZ1.5	18	2224040000
SMSE KU FE MCZ 1.5	1	2224390000
SMSE LN FE MCZ 1.5	1	2224380000
SMSE FE MCZ 1.5/PE	100	1003280000
Note		

Type	Qty.	Order No.
AP MCZ1.5	50	8389030000
ZQV 4N/2	60	1527930000
ZQV 4N/2 BL	60	1528040000
ZQV 4N/2 RD	60	2460450000
Note		
Full housing available as set on request.		

OMNIMATE® Housing RS

Profile housing

Flexible – more flexible – profile form

Build housing in profile form – the flexible modular system of coloured and transparent PVC profiles and carrier modules the perfect combination of any mounting utilising standard pitches and precisely cut to length, this creates the perfect balance between flexibility and efficiency: The modular approach is ideal for assemblies with high space requirements and is particularly suited for small quantities or variable widths.

Flexible covers

See-through covers in various heights protect assemblies even with high components safely.



Flexible installation

Extruded profiles can take several modules next to each other. Depending on the type of circuit boards can be installed on two different levels.



Flexible lengths

Cut, or joined together in a row: extruded profiles can be easily adjusted to the space requirements of every application.

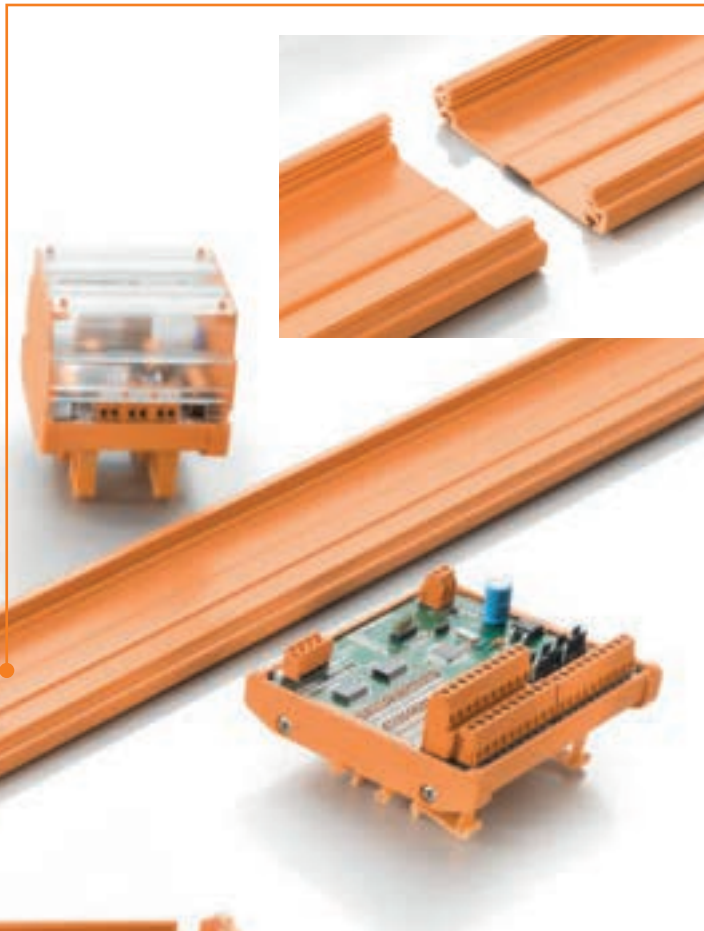

Flexible mounting

Mounting options: snapped onto the mounting rail or directly secured using screws.



Variable RS-profile housing

Variable, precision cut extruded profile with different height cover hoods allow maximum packing density even for large electronic sub-assemblies.

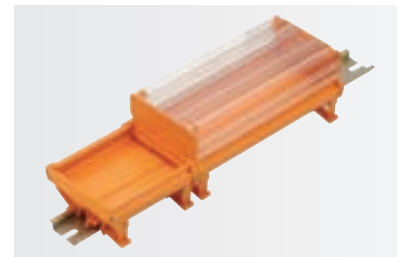

Modular RS-profile housing

Tool-free latching profiles with standard widths from 5 to 45 mm allow rapid assembly of tailor made solutions.



OMNIMATE® Housing RS

Profile housing

RS profile housings can be snapped on to DIN rails or mounted directly. They are available in six widths. The extruded profiles can be cut to length or joined together in modules and are ideal for low volume, special assemblies or test set-ups. Fitted transparent hoods are used to protect the components.

Width	Type	Construction/Width of circuit board	Catalogue pages	Colour scale ¹⁾
45.0 mm	RS 45	Variable / 42.0 mm	N.46	■ Similar to RAL 9011
70.0 mm	RS 70	Modular / 67.8 mm	N.47	■ Similar to RAL 7024
87.0 mm	RS 80	Variable / 67.8 mm	N.48	■ Similar to RAL 2000
86.0 mm	RS 90	Variable / 79.8 mm	N.49	
109.0 mm	RS 100	Variable / 100.0 mm	N.50	
130.8 mm	RS 122	Variable / 122.0 mm	N.51	

Note 1) Other colours on request

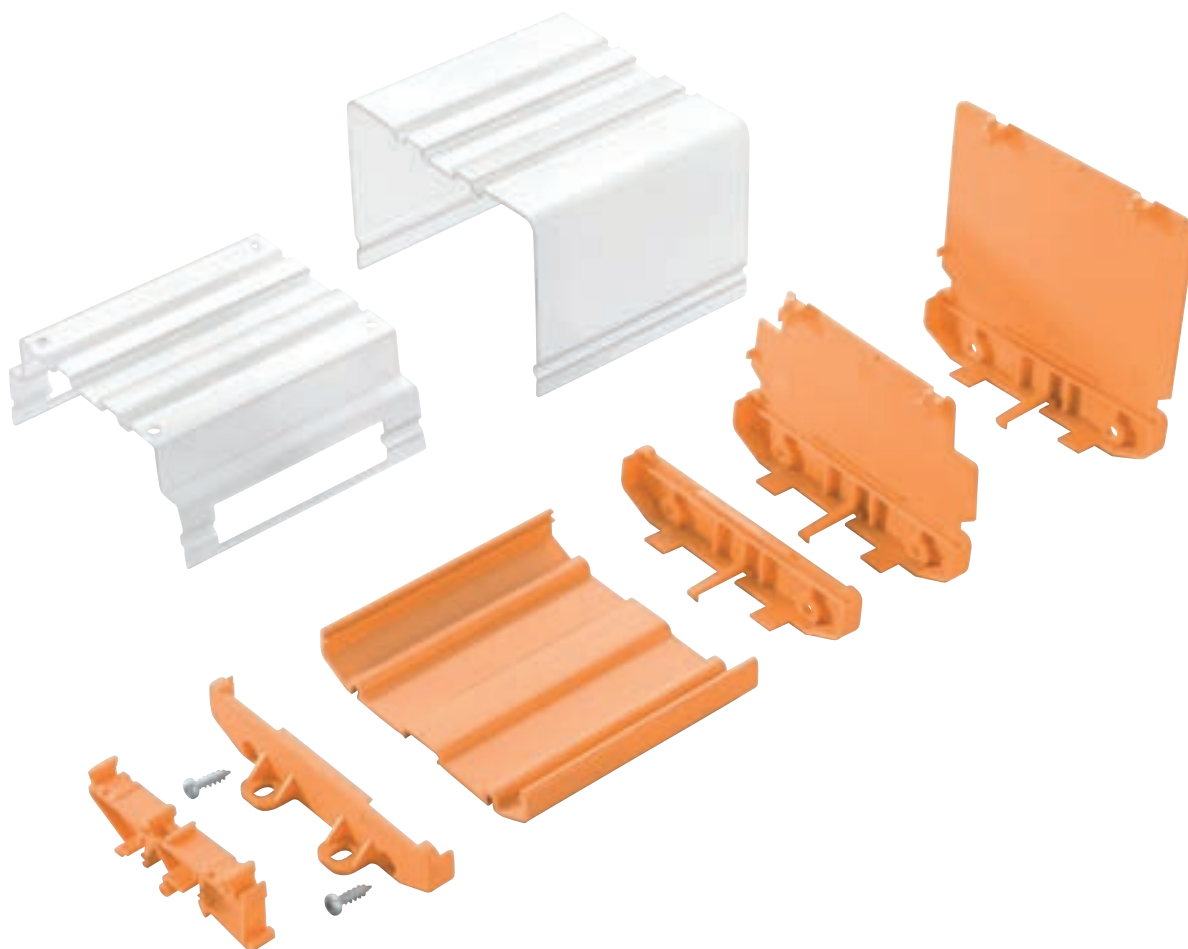

Housing variants

RS 45



Description/Type

RS extruded profile 45 mm, variable

Features:

- Width: 45 mm
- Circuit board width: 42 mm
- Number of circuit boards (max.): 1
- Protection class (max.): IP 00

Design options



- Can be shortened to any length
- Rail mounted
- Direct mount²⁾
- Machinable

RS 70



RS extruded profile 70 mm, modular

Features:

- Width: 70 mm
- Circuit board width: 67.8 mm
- Number of circuit boards (max.): 1
- Protection class (max.): IP 00



- Can be aligned side-by-side without any tools
- Rail mounted

RS 80



RS extruded profile 80 mm, variable

Features:

- Width: 87 mm
- Circuit board width: 67.8 mm
- Number of circuit boards (max.): 1
- Protection class (max.): IP 20
- Markable

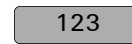

- Can be shortened to any length
- Rail mounted
- Direct mount²⁾
- Transparent hood (opt.)
- Machinable

RS 90



RS extruded profile 90 mm, variable

Features:

- Width 86: mm
- Circuit board width: 79.8 mm
- Number of circuit boards (max.): 1
- Protection class (max.): IP 00

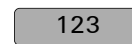

- Can be shortened to any length
- Rail mounted
- Direct mount²⁾
- Machinable

RS 100

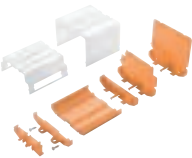

RS extruded profile 100 mm, variable

Features:

- Width 109: mm
- Circuit board width: 100 mm
- Number of circuit boards (max.): 1
- Protection class (max.): IP 20

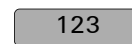

- Can be shortened to any length
- Rail mounted
- Direct mount²⁾
- Transparent hood (opt.)
- Machinable

RS 122

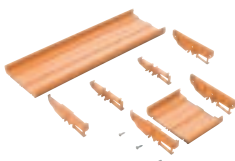

RS extruded profile 122 mm, variable

Features:

- Width: 130.8 mm
- Circuit board width: 122 mm
- Number of circuit boards (max.): 2
- Protection class (max.): IP 00



- Can be shortened to any length
- Rail mounted
- Machinable



pad printing,

123

markable,



can be machine-worked (drilling/milling),

²⁾ Screw mount

RS 45

Depending on the end plate design, the profiles can be mounted directly or on rail

1. The rail-mountable assembly requires:

- 2 end plates for DIN-rail mounting
- 1 extruded profile
- 4 screws

2. Direct-mountable assembly requires:

- 2 end plates for direct mounting
- 1 extruded profile
- 4 screws

Description

B3 heights are available for cover profile and end plates:

TS-mounting:

TS 32 = 45 mm, TS 35x7.5 = 40.5 mm

Direct mounting: 24 mm

Dimensions of PCB

Thickness: 1.6 (±0.2) mm, width:

42 (+0.5) mm

Size of RS segment = PCB length - 4.5 mm

Size of ADP segment = PCB length - 1 mm

Example:

PCB length 160 mm,

RS = 155.5 mm, ADP = 159 mm

Dimensioned drawing

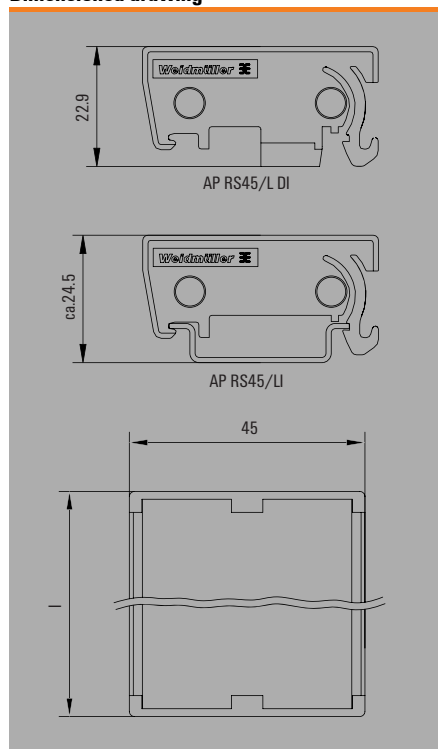

RS 45

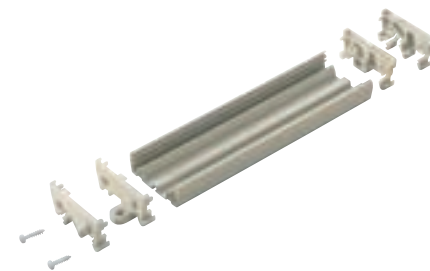

Technical data

General data	
Number of PCB per module	
Thickness of PCB	
Material	
Flammability class UL 94	
Colour of insulating material	
Note	

Ordering data

Extruded profile	
2000 mm	orange
2000 mm	grey
1000 mm	grey
155 mm	orange

Intermediate piece	
5 mm	
15 mm	
25 mm	
30 mm	
45 mm	

End plate w. locking foot	
Without cover	grey, left version
	grey, right-hand version
	orange, left version
	orange, right-hand version

Locking foot	
	orange
	grey
With marking facilities	left version
	right version
Without marking facilities	left version
	right version
Central	Intermediate foot

End plate for direct mounting	
Without cover	grey, left version
	grey, right version
	orange
	grey
For medium-high cover profile	orange
	grey
For high cover profile	orange
	grey

End plate for mounting rail installation	
Without cover	orange
	grey
For medium-high cover profile	orange
	grey
For high cover profile	orange
	grey

Cover profile 1000 mm	Medium-high
	high
Screws	

Note	
------	--

1
1.6 (± 0.2) mm
PVC/PA
V2
beige

Type		Qty.	Order No.
RF RS 45 OR 2000	VO	1	4340430000
PF RS 45 GR 2000	VO	1	4027750000
PF RS 45 GR 1000	VO	10	8140880000

AP 45/LI	V2	20	8143910000
AP 45/RE	V2	20	8143900000
AP 45/LI OR	V2	20	1011590000
AP 45/RE OR	V2	20	1011600000

AP 45/LI DI	V2	20	8140870000
AP 45/RE DI	V2	20	8140860000

ADP 1/HP1 1M	V2	1	0485200000
--------------	----	---	------------

LKSC M2.9x13VZ		100	4011200000
----------------	--	-----	------------

Other lengths on request.			
---------------------------	--	--	--

RS 70

Chassis Form:

Rail-mounted version

- 1 clip-on foot left
- 1 clip-on foot right
- 1 or more intermediate pieces
- 1 clip-on foot centre if required

Description

Height: TS 32 = 33.5 mm, TS 35x7.5 = 29 mm

Dimensions of PCB:

Thickness: 1.6 (± 0.2) mm

Length: 67.8 (- 0.2) mm

Width of intermediate piece = PCB width - 2x9 mm (snap-on feet)

Example:

PCB width = 68 mm

Width of intermediate piece = 50 mm

Intermediate piece 2x ZW 25 RS or

ZW 45 RS + ZW 5 RS

Dimensioned drawing

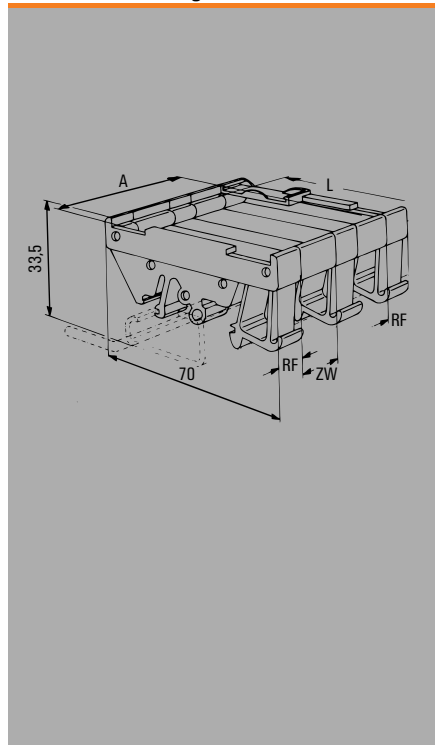

Technical data

General data

Number of PCB per module	
Thickness of PCB	
Material	
Flammability class UL 94	
Colour of insulating material	

Note

Ordering data

Extruded profile

2000 mm	orange
2000 mm	grey
1000 mm	grey
155 mm	orange

Intermediate piece

5 mm	
15 mm	
25 mm	
30 mm	
45 mm	

End plate w. locking foot

Without cover	grey, left version
	grey, right version

Locking foot

	orange
	grey
With marking facilities	left version
	right version
Without marking facilities	left version
	right version
Central	Intermediate foot

End plate for direct mounting

Without cover	grey, left version
	grey, right version
	orange
	grey
For medium-high cover profile	orange
	grey
For high cover profile	orange
	grey

End plate for mounting rail installation

Without cover	orange
	grey
For medium-high cover profile	orange
	grey
For high cover profile	orange
	grey

Cover profile	Medium-high
	high

Screws

Note

RS 70



Number of PCB per module	1
Thickness of PCB	1.6 (± 0.2) mm
Material	PA
Flammability class UL 94	V2
Colour of insulating material	orange

Type	Qty.	Order No.
ZW 5 RS OR	20	0119760000
ZW 15 RS OR	20	0119860000
ZW 25 RS OR	20	0126160000
ZW 30 RS OR	20	0119960000
ZW 45 RS OR	20	0120060000
RF RS 70 RE/A3/M.BEZ	20	0119560000
RF RS 70 LI/A2/O.SG	20	0119660000
RF RS 70 RE/A4/O.BEZ	20	0126260000
RF RS 70 MI/A6	20	0213760000

RS 90

Housing installation (plus 4 screws):

- 2 end plates
- 2 or more locking feet
- 1 extruded profile

Description

Dimensions of PCB

Thickness: 1.6 (±0.2) mm, width: 79.8 (+0.2) mm

Size of RS segment = PCB length - 4.5 mm

Example:

PCB length 160 mm

RS = 155.5 mm

Dimensioned drawing

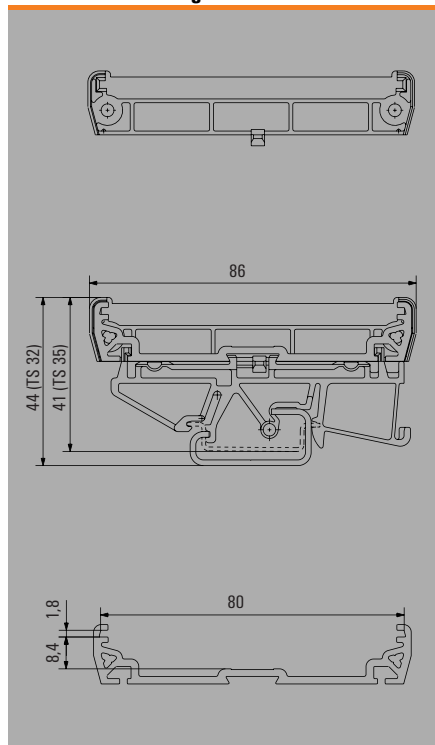

2833820000

Technical data

General data

Number of PCB per module
Thickness of PCB
Material
Flammability class UL 94
Colour of insulating material

Note

Ordering data

Extruded profile

2000 mm	orange
2000 mm	grey
1000 mm	grey
155 mm	orange

Intermediate piece

5 mm
15 mm
25 mm
30 mm
45 mm

End plate w. locking foot

Without cover	grey, left version
	grey, right version

Locking foot

	orange
	grey
With marking facilities	left version
	right version
Without marking facilities	left version
	right version
Central	intermediate foot

End plate for direct mounting

Without cover	grey, left version
	grey, right version
	orange
	grey
For medium-high cover profile	orange
	grey
For high cover profile	orange
	grey

End plate for mounting rail installation

Without cover	orange
	grey
For medium-high cover profile	orange
	grey
For high cover profile	orange
	grey

Cover profile	Medium-high
	high

Screws	LKSC M2.9x13VZ
--------	----------------

Note

RS 90



1
1.6 (± 0.2) mm
PVC/PA
VO
orange

Type	Qty.	Order No.
PF RS 90 OR 2000MM	VO 1	4053240000
PF RS 90 GR 2000MM	VO 1	4051810000

RF 180	V2 20	1324460000
RF 180 GR	V2 20	1773400000

AP 90 OR	V2 20	1961880000
AP 90 GR	V2 20	1961890000

LKSC M2.9x13VZ	100	4011200000
----------------	-----	------------

Other lengths on request.

RS 100

Housing installation (plus 4 screws):
Rail mounted variant (rail mounted assembly)

- 2 end plates for rail mounted assembly
- 2 or more locking feet
- 1 extruded profile
- 1 cover profile (optional)

Direct mounting variant

- 2 end plates, direct mounting
- 1 extruded profile
- 1 cover profile (optional)

Description

3 heights are available for cover profile and end plates:

Rail mounting without cover:

TS 32 = 45 mm, TS 35x7.5 = 40.5 mm

Rail mounting with low cover:

TS 32 = 89 mm, TS 35x7.5 = 84.5 mm

Rail mounting with high cover:

TS 32 = 121 mm, TS 35x7.5 = 116.5 mm

Direct mounting without/low/high cover:

24 / 69 / 99 mm

Dimensions of PCB

Thickness: 1.6 (±0.2) mm, width:

100 (+0.5) mm

Size of RS segment = PCB length - 4.5 mm

Size of ADP segment = PCB length - 1 mm

Example:

PCB length 160 mm

RS = 155.5 mm, ADP = 159 mm

Dimensioned drawing

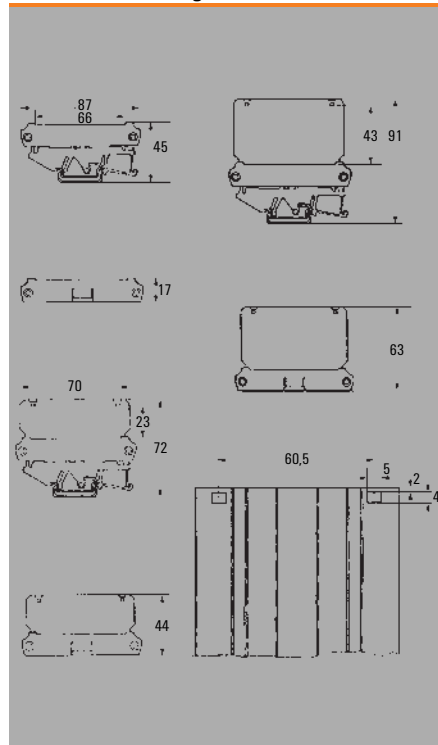

Technical data

General data	
Number of PCB per module	
Thickness of PCB	
Material	
Flammability class UL 94	
Colour of insulating material	
Note	

Ordering data

Extruded profile	
2000 mm	orange
2000 mm	grey
1000 mm	grey
155 mm	orange
Intermediate piece	
5 mm	
15 mm	
25 mm	
30 mm	
45 mm	
End plate w. locking foot	
Without cover	grey, left version grey, right version
Locking foot	
	orange grey
With marking facilities	left version right version
Without marking facilities	left version right version
Central	intermediate foot
End plate for direct mounting	
Without cover	grey, left version grey, right version orange grey
For medium-high cover profile	orange grey
For high cover profile	orange grey
End plate for mounting rail installation	
Without cover	orange grey
For medium-high cover profile	orange grey
For high cover profile	orange grey
Cover profile 2000 mm	Medium-high
2000 mm	high
Screws	
Note	

RS 100

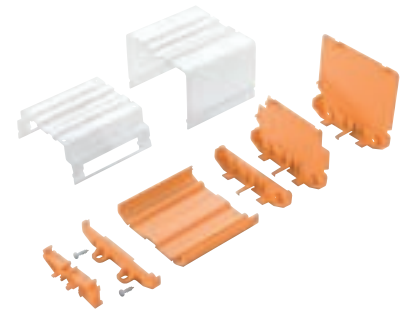

1
1.6 (± 0.2) mm
PVC/PA
VO
orange / grey (Black on request)

Type	Qty.	Order No.
PF RS 100 OR 2000MM A.1 VO	1	4144870000
PF RS 100 GR 2000MM A.1 VO	1	4010870000
PF RS 100 A.1 OR 155.5 VO	25	4148400000
RF 180 V2	20	1324460000
RF 180 GR V2	20	1773400000
AP 100 D V2	20	1185160000
AP 110 D V2	10	1185360000
AP 111 D V2	10	1185560000
AP 100 V2	20	1185060000
AP 110 V2	10	1185260000
AP 111 V2	10	1185460000
ADP 10 V2	1	4169320000
ADP 11 V2	1	4169330000
PTSC KB40X14	100	4019420000
Other lengths on request.		

RS 122

Housing construction (plus 4 screws):
available as a rail mounting version (TS mounting)

- 2 end plates for rail mounted assembly with locking foot
- 2 or more locking feet
- additional intermediate foot
- 1 Extruded profile

Description

Takes PCB in 2 positions

Dimensions of the PCB

Thickness: 1.6 (±0.2) mm, width: +0.5 mm
i.e. length RS section = PCB length - 5 mm

Example:

PCB length 160 mm,

RS section = 160 mm - 5 mm = 155 mm

Dimensioned drawing

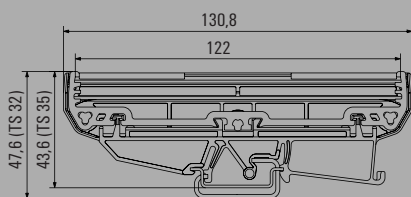

Technical data

General data

Number of PCB per module	
Thickness of PCB	
Material	
Flammability class UL 94	
Colour of insulating material	

Note

Ordering data

Extruded profile

2000 mm	orange
2000 mm	grey
1000 mm	grey
155 mm	orange

Intermediate piece

5 mm	
15 mm	
25 mm	
30 mm	
45 mm	

End plate w. locking foot

Without cover	grey, left version
	grey, right version

Locking foot

	orange
	grey
With marking facilities	left version
	right version
Without marking facilities	left version
	right version
Central	intermediate foot

End plate for direct mounting

Without cover	grey, left version
	grey, right version
	orange
	grey
For medium-high cover profile	orange
	grey
For high cover profile	orange
	grey

End plate for mounting rail installation

Without cover	orange, left version
	orange, right version
	grey
For medium-high cover profile	orange
	grey
For high cover profile	orange
	grey

Cover profile	Medium-high
	high

Screws

Note

RS 122

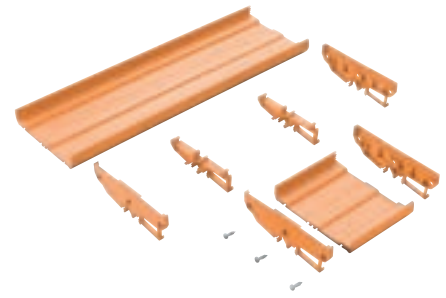

1
1.6 (± 0.2) mm
PVC/PA
VO
orange

Type	Qty.	Order No.
------	------	-----------

PF RS 122 OR 2000MM	10	1155940000
---------------------	----	------------

RF 108 OR	20	1020690000
-----------	----	------------

AP RF 122 LI OR	20	1020640000
-----------------	----	------------

AP RF 122 RE OR	20	1020650000
-----------------	----	------------

Other lengths on request.

T

MTA

Snap-on foot for terminal rail



MOFU

Mounting foot

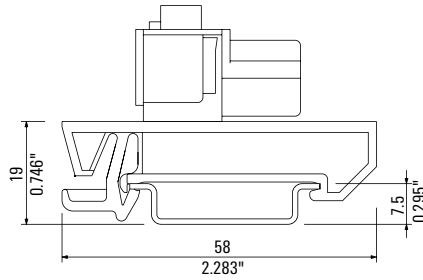

WS 10/5

WS 12/5

MultiCard marking



T

The MTA 45 mounting adapter enables many different modules to be securely attached to a terminal rail. The adapter, made of fibreglass-reinforced polyamide, ensures high stability and secure fixity to the terminal rail. It is assembled by simply clipping on, and disassembled by pushing up and tilting the module. No tools are required for this.

- WS 10/5 = 10 mm long x 5 mm wide
- WS 12/5 = 12 mm long x 5 mm wide
- Delivered as MultiCard 5 mats with 144 markers

Ordering data

Snap-on foot for TS 35		Black
Type	Qty.	Order No.
MTA 30 BK	45	1168970000
MTA 45 BK	30	1962250000

Ordering data

Colour		Black
Type	Qty.	Order No.
Mounting foot Mofu	20	0646210000

Ordering data

Type	Length mm	Order No.
WS 10/5	10	1635000000
WS 12/5	12	1609860000

SDI

VDE-insulated slotted screwdriver

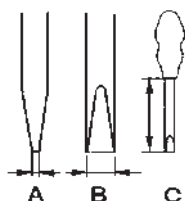
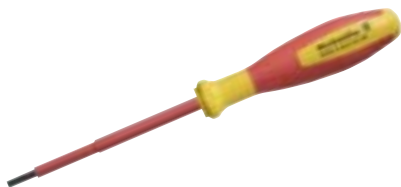

VDE-insulated slotted screwdriver, SDI

- SDI DIN 7437, ISO 2380/2
- Drive output acc. to DIN EN ISO/IEC 60900 and DIN ISO 2380



Ordering data

Type	Dims. (mm)	A	B	C	Order No.
SDI		0,4	2,5	75	2749790000
SDI		0,5	3,0	100	2749800000
SDI		0,6	3,5	100	2749810000
SDI		0,8	4,0	100	2749820000
SDI		1,0	4,5	125	2749830000
SDI		1,0	5,5	125	2749850000
SDI		1,2	6,5	150	2749860000
SDI		1,6	8,0	175	2749870000

SD

Slotted screwdriver with round blade

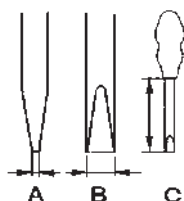

Slotted screwdriver with round blade, SD

- SD DIN 5265, DIN ISO 2380
- Drive output acc. to DIN 5264, DIN ISO 2380/1
- ChromTop tip



Ordering data

Type	Dims. (mm)	A	B	C	Order No.
SD		0,4	2,5	75	2749320000
SD		0,5	3,0	80	2749330000
SD		0,6	3,5	100	2749340000
SD		0,8	4,0	100	2749360000
SD		0,8	4,5	125	2749370000
SD		1,0	5,5	150	2749380000
SD		1,2	6,5	150	2749390000

Tension clamp terminal tool

Tool for PCB terminals with tension clamp connection



You do not need any special tool to connect or disconnect our tension clamp connection.
The opening is designed to accommodate a standard 0.6 x 3.5 x 100 screwdriver 9008330000 to DIN 5264-A (with flat blade).

SDK PH/PZ

Crosshead screwdriver



Crosshead screwdriver PH (Philips)

- SDK PH DIN 5262, DIN ISO 8764-PH
- Drive output acc. to DIN ISO 8764-PH
- ChromTop tip



Crosshead screwdriver PZ (Pozidrive)

- SDK PZ DIN 5262, DIN ISO 8764-PZ
- Drive output acc. to DIN ISO 8764-PZ
- Chrome top tip



Ordering data PH

Type	Dims. (mm)	A	B	C	Order No.
SDK PH0	0			60	2749400000
SDK PH1	1			80	2749410000
SDK PH2	2			100	2749420000
SDK PH3	3			150	2749430000

Ordering data PZ

Type	Dims. (mm)	A	B	C	Order No.
SDK PZ1	1			80	2749440000
SDK PZ2	2			100	2749450000
SDK PZ3	3			150	2749460000

Service and support

Service and support	Service connects - worldwide	V.2
	Engineering support and customised products	V.3
	easyConnect - Your Industrial Service Platform	V.4
	Support Center	V.6
	Additional support services	V.7
	Weidmüller Configurator: intuitive, uncomplicated & fast digital engineering	V.8

Our expertise for your requirements

Service connects – worldwide



Automation technology functions are becoming more complex in a globally-oriented world facing ambitious targets in terms of energy efficiency and smart production. We are your equal partners for the best connections in Industrial Connectivity.

Our personal support answers all questions reliably and expertly. During planning, installation or operation our service and support offer is your best companion.

In short: Weidmüller's global service combines our expertise with your requirements.

V



Your way to our service
www.weidmueller.com/service

Engineering services and customised products

Automation engineering and connectivity consulting belongs to our services as well as assembly of engineered products. We also support the process from the idea to the product with our Weidmüller Configurator and the Configure-to-Order process.



Consulting and engineering

The challenge for you is reducing costs and increasing efficiency. This requires intelligent, individual solutions. Whether it is modified products, pre-fitted mounting rails or complete small cabinets – our application centres provide a highly qualified custom-made engineering and production service.



Connectivity Consulting

Increase your competitiveness - supported by our experts. Our drive is to optimise your competitiveness. That's why our team of experts supports you in significantly increasing your efficiency in electrical machine design and control cabinet construction. With proven products and services from the Weidmüller portfolio – and with the experience gained from over 300 projects worldwide.



Assembled terminal rails - Flexibly designed to suit your requirements

Your processes in panel building have to be fast, flexible and productive. This is the only way you can cut your costs and increase efficiency. Depending on the application in question, you will have different requirements with respect to the engineering service, delivery speed and flexibility to be provided.



Modified and assembled enclosures - Competitive advantages included

To compete internationally, your plants need to satisfy high standards of safety, quality and performance. The smart combination of consultation, application expertise and industry know-how is our key to finding a custom-fit solution for your application. Reduce costs and increase efficiency.

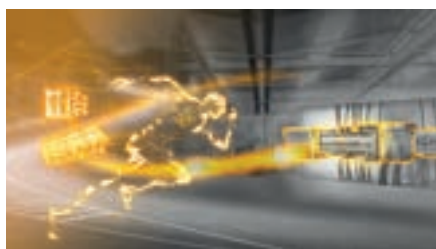

Fast Delivery Service - Your ideas deserve a quick realisation

Obtain offers 24/7 and within minutes, including directly orderable article numbers with our Fast Delivery Service. The Weidmüller Configurator (WMC) for planning and configuration is key for consistent processes. Dispatch your orders in 5 days. Assemble individual terminal strips and enclosures from batch size 1!

Your ticket to the world of digital service

easyConnect – Your Industrial Service Platform



Our cloud-based platform is your ticket to the world of digital services from Weidmüller, and the intuitive and future-proof tool for your way to the Industrial IoT. Realise your use cases easily, consistently and without any relevant prior knowledge, thanks to the perfect interaction of platform, devices and diverse software services.

As an open, modular and perfectly integrable system, the platform is your enabler for a wide range of use cases. Increase your efficiency and unleash your full innovation potential with easyConnect.

V



Interested in using easyConnect?

Learn how to get started with easyConnect step-by-step.

www.weidmueller.com/easyconnect

Why should you use easyConnect?

- You want to enter your digital transformation step-by-step?
- You want to make the step into Industrial IOT, but have no or little IT expertise?
- You want to use your digital data for smart & scalable services?
- You want to offer digital services (such as customised dashboard) to your customers?
- You want to improve your service offering and efficiency, e.g. through remote access?
- You feel Weidmüller's digital services are interesting, but you have „your cloud“ already?



Weidmüller comes up with the solution: easyConnect, the new digitalisation platform. It bundles Weidmüller's digital services at one place in the cloud and connects them with various Weidmüller devices.

With easyConnect you start digitalising your application step-by-step without ballast in a secure way.

The following services are initially available on easyConnect:



Device management

Adding and managing cloud-connected devices is typically the first step in any Industrial IoT use case.

Asset management

The asset management service is a modelling tool that allows users to model their assets and processes and link them to relevant time series data.

Remote access (u-link)

u-link guarantees a quick and secure access to machines and plants while also allowing for efficient management.

Data visualisation

easyConnect data visualisation services enable users to view, monitor and display live and historical data.

AutoML

With Weidmüller Industrial AutoML, you can optimize operations, increase product quality and develop new business models by benefiting from advanced analytics.

Expand the possibilities of our products

Our Support Center provides you with comprehensive, clear and personal assistance



Receive fast and intuitive support to get the most out of our products in your application. In our new Support Center you can search or navigate to the many application notes, product information, video tutorials or software downloads of our products.

- **Everything at a glance** – One central support hub, where all relevant information is available
- **Powerful search** – Provides filter functions for various types of information and products
- **Different views and navigations** – Content provided in views product information, engineering support or software downloads
- **More than 170,000 downloads** – Application notes, video tutorials, templates and examples, user documentation, engineering data, ...
- **Personal contact** – Direct access to your personal technical contact in your country



Explore the world of our new Support Center
support.weidmueller.com

Additional support services



Training and Webinars

Stay tuned in a world that is accelerating. In our entertaining interactive webinars, we offer you the opportunity to learn about new products and technology topics and to interact with our experts.



Repairs and replacement parts

We offer repair and components for our Workplace Solutions as well as assistance for other Weidmüller products. Find out how our experts can help you with your repair request.



Security advisory board

Our Product Security Incident Response Team (PSIRT) continuously informs you about possible security-related vulnerabilities of our products.



Engineering data

For the quick integration of our products into your design, there are a lot of digital product data for engineering systems like EPLAN, Zuken E3.series, WSCAD and many others available for download.



Product change notifications

Technical modifications of our products always available online.



Technical product catalogues

Technical data for our entire program in Industrial Connectivity for download in PDF-format.

From the idea to the finished solution

Weidmüller Configurator: intuitive, uncomplicated & fast digital engineering

Digital engineering can be so easy – with the Weidmüller Configurator!

It's a **free to use** software application to easily configure industrial solutions. It features more than **12,000 articles** from multiple product families including rail-mounted components, industrial and ex-certified enclosures, Heavy Duty Connectors, remote I/O-systems and PCB connectors.

Unleash the full power of digital engineering:

Our application wizards help you choose the right articles.

Place, mark or modify them to your needs and get your solution **visualized in 3D** – what you see is what you get!

Our promise: Speed up your solution planning process by up to 70%!

Your benefits:

- **Proven configuration designs in real 3D:** The plausibility and collision check with the complete digital documentation ensures that you can rely 100% on your configuration.
- **Seamless E-CAD Roundtrip:** Interfaces enable the simple exchange of product data between the WMC and all common engineering tools, such as Zuken E3 or EPLAN Electric P8.
- **Sample Service & Fast Delivery Service:** to support your design-in process, we offer a **3-day sample service** for many products. Inquire them directly online – for free!
You want your solution right away? Our **Fast Delivery Service** guarantees delivery of individually assembled terminal strips or enclosures within a few days.

Get started online now!

The Weidmüller Configurator makes solution planning easy. Visit our website for more information, tutorials and download it for free:



www.weidmueller.com/wmc



or register on easyconnect.weidmueller.com and use it online.



Wizards:
Design complete applications within few clicks – even without detailed product knowledge – for signal wiring, load monitoring, instrument transformers, enclosures, remote I/O-systems and many more.



Assistants:
Finalize your solutions with supporting assistants to add cross-connectors, markers or colors and verify the faultlessness. Automatic modes save valuable time!



1-click documentation:
Get assembly drawings for production – only 1 click. Bill of material – only 1 click. The complete solution documentation including all component data sheets – you’re right, only 1 click!



Technical appendix

Technical appendix	Overview of the icons used in the catalogue	W.2
	Wire connection technologies and surface mounting	W.4
	Fastening options for OMNIMATE® device connection technology	W.8
	Insulating materials	W.12
	Metals	W.14
	Derating curve	W.15
	Measurement of clearance and creepage distances according to VDE / IEC	W.16
	Measurement of clearance and creepage distances according to UL	W.20
	UL design-in recommendations for 600 V applications	W.21
	Device connection technology in the reflow soldering process (SMT)	W.22
	The SMD solder connection	W.28
	AWG conductor table	W.29

Overview of icons used in catalogue

The OMNIMATE® device connection methodology and electronics housing range is highly flexible, ensuring your application requirements are met. The more familiar you are with it, the easier it is to find the optimum component. To help you, we have listed and described the meaning of icons used in the catalogue. Let's connect.

Grid size in mm



Different grid sizes of between 3.50 mm and 15.00 mm require different installation sizes to meet electrical requirements.

Outlet direction of terminals, connectors and plugs



Each device design requires different wire feeds or actuation directions. Combine options between 90° and 270°.

Soldering connection technology



Choose from manual, wave or reflow soldering with push-through or surface mounting. OMNIMATE® can do it all.

Wire connection method

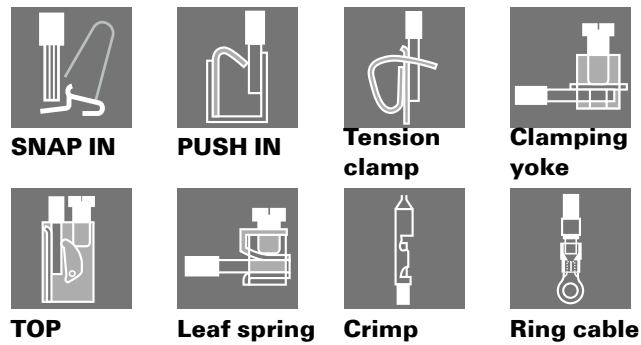

One of our core competencies. Individual strand connections for any application – tried-and-tested effectiveness.

Wire cross-section, in mm²

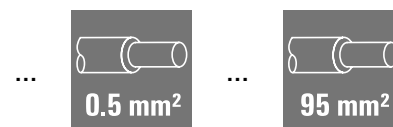

Different wire thicknesses of between 0.14 mm² and 95 mm² require different installation sizes for the mechanical and electrical requirements to be met.

Component design of terminals, connectors and plugs

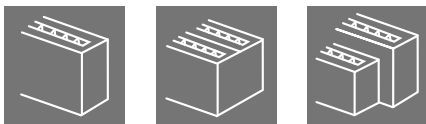

Single-row is standard. Multi-row and multi-story designs increase the packing density and enable a large number of connections in a smaller space.

Type of packaging



Whether they come on reels, as tubes or boxes – our components are optimally packed so that they are fit for purpose.

Feature of our OMNIMATE® Power products



Can be used for 600 V according to UL

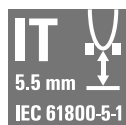

Can be used for IT networks according to IEC 61800-5-1

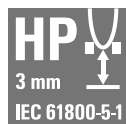

Can be used for very stringent requirements according to IEC 61800-5-1

Our service



Your time-saving, design-in sample service

Connection system



SNAP IN spring connection



The SNAP IN spring connection is the fastest connection and speeds up wiring processes in the field. The conductor only needs to be stripped and can be inserted directly into the clamping point, even without a ferrule. Thanks to the mousetrap concept, the connection spring closes and the conductor is already contacted. Even flexible conductors can be connected without any further preparation. This makes wiring as quick as snapping your fingers. The integrated green indicator gives, besides an audible click, a visual feedback when the wiring is done. The SNAP IN clamping point is already open when delivered and thus ready to robot, which means that the SNAP IN connection enables fully automated wiring processes without any necessary preparation. Like the connection, the rewiring is also simple and does not require any tools. By actuating the lever, the clamping point is opened and the connected conductor can be removed. At the same time, the clamping point remains open and is thus directly ready for the next wiring.

Customer benefits:

- Simple and fastest conductor connection thanks to the mousetrap concept
- Direct connection of stripped conductors without further preparation - even for flexible conductors without ferrules
- Robust and vibration-resistant wire connection with constantly high wire clamping force
- Visual and audible indication when wiring is complete
- Ready to robot thanks to open clamping point for fully automated wiring processes
- Simple and tool-free operation of the lever for rewiring

Field of application:

The innovative connector for any application in the field with fastest possible and tool-free wiring. Ideal for fully automated wiring processes and in harsh environmental conditions.



PUSH IN spring connection



The PUSH IN spring connection with direct plug-in technology allows the fast wiring process: the stripped or prepared wire is simply pushed into the terminal point as far as it will go and the connection is finished. Operating the release lever is only required with flexible wires or to release the connection. The stainless steel spring ensures a high contact force between wire and the tinned copper busbar. A stainless steel cage enclosure prevents subsidence in the contact area. To prevent any drop in clamping force plastic parts were deliberately not used.

Customer benefits:

- Fast, tool-less wire connection with direct insertion technology
- The stainless steel spring results in a vibration-resistant connection
- Higher resistance to wire pull-out than in a tension clamp system
- Constant conductor clamping force independent of the operator
- Operator error is reduced using a colour-coded and intuitive actuator
- Wire feed and the operation are aligned in the same direction which permits a compact equipment design

Field of application:

The default choice for operation in the field; it permits speedy wiring and, combined with its small size, its intuitive use is also advantageous even in environments with severe vibration.



Tension clamp connection



The pre-tensioned tension clamp is made from high quality rust and acid resistant steel, which pulls the wire against the galvanised copper busbar. This results in a permanent and vibration resistant connection. Operation is simple; the spring is opened with a screwdriver, the wire is fed through the wire guide into the spring cage and the screwdriver is removed, resulting in a clamped wire. The surface-treated busbar ensures low contact resistance and a high resistance to corrosion.

Customer benefits:

- Constant conductor clamping force independent of the operator
- Wide-spread connection technology
- Simple operation using a screwdriver or the integrated release lever

Field of application:

Fast wiring with a constant clamping force, even in environments with severe vibration.



Clamping yoke screw connection



The clamping-yoke connection is the most used screw connection in the world. Steel clamping-yokes made of using a stamping and bending process guarantee a vibration proof clamp connection. When the screw on the clamp is tightened, there is a counter effect in the clamping yoke's threaded area which prevents the connection from accidentally loosening. As the screw thread is on an inclined plane, there is a force gain created and a very high clamping force is achieved. Weidmüller uses hardened steel with optimal corrosion protection for stability and security and copper alloys in the contact area for good electrical conductivity.

Customer benefits:

- The screw connection guarantees a globally accepted, vibration proof and maintenance free connection.
- A large conductor clamping area is covered.
- The "Wire Ready" technology ensures that the terminal points are fully open at delivery, even after being transported world-wide
- The "Wire Guard" protection mechanism prevents accidental insertion of the wire underneath the clamping area which can be dangerous, it protects against hidden faulty contacts
- The flat clamping yoke also enables the clamping of very small cross-section wires

Field of application:

The standard connection for applications in industrial environments with the highest requirements for reliability even under harsh conditions.

Connection system



TOP screw connection terminal with Pull-Effect



In the traditional case, the screw is always at a right angle to the conductor outlet direction. The TOP connection, however, allows wire insertion and the screw orientation in the same direction.

The TOP connection produces the greatest possible packing density in the terminal area. The "pull effect" ensures that the connected wire is pulled in to the clamping point producing a secure contact.

Customer benefits:

- The "pull effect" pulls the wire into the terminal point. Problems with clearance and creepage distances are avoided.
- Wire feed and the operation are aligned in the same direction which permits a compact equipment design
- The minimum installation height results in an extremely high packing density

Field of application:

Housing design or installation requirements such as PCB slots, that do not allow a right angled screw operation for reasons of space.



Crimp connection



The crimp connection technology provides an affordable solution with pre-assembled female plugs that is also appropriate for large batch jobs. The crimp contacts can be attached using hand

tools or with a crimping machine for producing large batches. The contacts are then locked into the housing provided. For fully automated processing, taped crimp contacts are available.

Customer benefits:

- Rapid, fully automated pre-assembly of connectors is possible
- Long-lasting, positive connection technologies
- Minimal contact resistances
- The conductor connection is extremely thermal shock and vibration resistant

Field of application:

Applications that combine fully automatic and factory oriented processing steps with the actual field wiring. Works in environments with severe vibration or temperature fluctuations.

Surface mounting

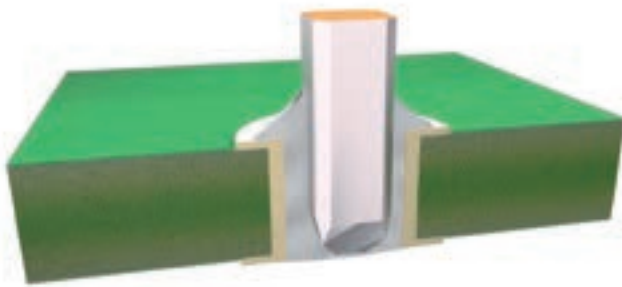

THR soldered connection



Reflow products in THT (through-hole technology) are the best alternative to using just SMT (surface-mount technology) if higher forces might be operating on the printed-circuit board

components. The component design of Weidmüller products is specifically developed for this application and takes into account the requirements in terms of structural shape, temperature stability and processing for THT products from the word "go".

Customer benefits:

- Special temperature-resistant plastics with a melting point of over 300 °C.
- 2 pin lengths – 1.5 mm for low paste requirements and 3.2 mm for focus on quality assurance.
- Packed in standard cardboard boxes or antistatic belts, for use in pick-and-place machines.
- Comparably higher current-carrying capacity due to the plastic's high temperature stability.

Field of application:

Applications where fast processing and reliable and stable connections to the printed-circuit board are of the essence.

Reflow, wave or hand soldering with high temperature requirements.

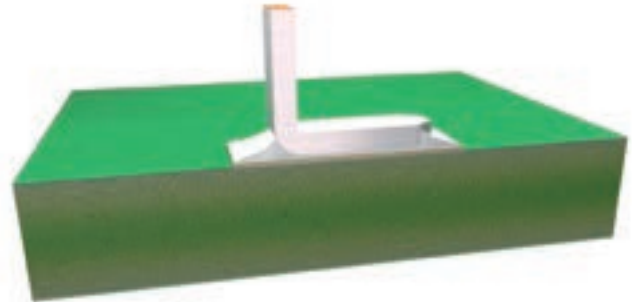

SMD surface soldering connection



Electronic subassemblies are manufactured economically using surface-mount technology (SMT) with surface-mount devices (SMD). Design measures such as co-planarity and the size/shape

of the soldering pads lend electromechanical components a reliable and stable printed-circuit board connection. The structural shape and temperature stability of Weidmüller SMD components are matched to processing in automated surface mounting equipment.

Customer benefits:

- In contrast to THR, no holes are necessary for printed-circuit boards (for instance, with glass ceramic-printed circuit boards).
- Two soldering pads per connecting point boost mechanical stability.
- Standard packaging in the antistatic belt means it can be used in pick-and-place machines.
- High dimensional stability due to plastic with a high level of temperature resistance, with a melting point over 300 °C.

Field of application:

Subassemblies that are exclusively equipped with SMD components and exposed to medium electromechanical loads.

You are looking for the best connectors for your project

We help you find the right solution

Every new design needs different components to provide a suitable solution for your application. For example, the mating connectors on the PCB and in the housing have to meet different requirements. When installing the mating connectors, your customers will expect enhanced features for safety and convenience.

Possible fastening options for male and female connectors on the printed circuit board:

Connector without fastening option for the plug

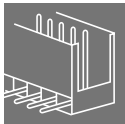

Open (O): this simplest connector version has no side panels. Open variants can be positioned next to one another without a loss of poles (end-stackable). Two 2-pole connectors can therefore be used to produce one 4-pole connector on the printed circuit board. The end-stackable design is flexible when producing very large numbers of poles on the printed circuit board.

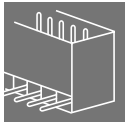

Closed (G): closed versions are used to prevent the plug being incorrectly inserted and to provide better dust protection. Ideally suited to prevent mismatching.

Connector with secure fastening with screw option

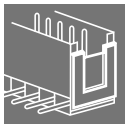

Dovetail (B): the dovetail variant is closed and allows mounted blocks to be added. Our mounting options deliver all the flexibility you require.

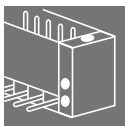

Flange with nut (F): for the classic screw option, each flange is paired with a nut for the screw in the flange plug counterpart.

Connector with additional fastening on printed circuit board

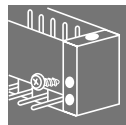

With optional screw: for increased mechanical stability, you can also use a screw to fasten the flange connector to the PCB. An extra hole must be provided on the printed circuit board for the screws.

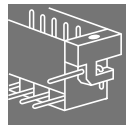

With solder pin (LF): solder flange rather than screw. For increased mechanical stability on the printed circuit board, an additional solder pin is integrated into the flange sides on the printed circuit board. This pin can be simply soldered during the soldering process. There is no need for any more screw connections.

Connector with fastening option for plug – with release latch

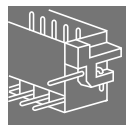

Clip-on flange (RF): if you only want to link connectors and plugs with a release latch and don't want to fix them with a screw, this is the best solution. The clip-on flange provides the plug's latching hook, with the contour needed to ensure a secure fix, which is easy to release later on.

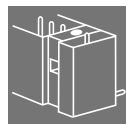

Middle flange (MF): for some OMNIMATE® Power series, alongside the classic flange versions located externally on the right and left of the male and female connectors, we also provide an innovative middle flange with a latching hook mechanism. This clever solution makes very simple and safe handling possible. The pin and plug can be securely fixed and released with just one hand. As an option, the clip-on flange, with an extra nut in the male connector, can also be screwed down to the plug. Variants with a solder pin for additional fixing on the printed circuit board are also possible.

Fixing and releasing a plug with the connector / device:

Plug without fixing option



Closed (G): the standard version – without additional flange or latch. To release, simply pull the plug. In most series, the plugs can be plugged next to one another, without a loss of poles.

Plug with fastening option – with screw

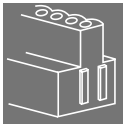

Dovetail (B): the variant with a dovetail contour on the left and right is closed and if necessary, you can mount extra small fastening blocks (flanges) for installation. With little effort, you can therefore prepare versions

which are both closed and feature a flange.

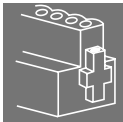

Flange version (F): plugs with flange have a screw on either end. This ensures secure fixing of the plug with the matching connector, with flange and nut. Increased safety means that no one can release the plug by mistake.

In our OMNIMATE® Power series, a latching hook provides secure retention. The screw can also be used for fastening purposes. The latch between the plug and pin can be released by simply pressing on both sides.

Plug with convenient release function – with release lever or latch



Release latch (LR): there is a lever on the right and left of the plug which can be easily moved by pressing with a screwdriver or fingers. Plug and pin are also automatically linked with just one click. Because of the lock mechanism, the plug cannot be released by mistake. Pulling forces are increased, for connectors with large numbers of pins in particular. However the release latch can be used to simply release the plug from the connector with flange, or from the housing without the wires having to be pulled. The plug can only be released from the pin by manually unlocking the release catch at the same time.

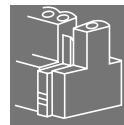

Middle flange (MF): for some OMNIMATE® Power series, alongside the classic flange versions located on the right and left of the male and female plugs, we also provide an innovative middle flange. This clever solution makes very simple and safe handling possible. The pin and plug can be securely fixed and released with just one hand. To fix the components, either simply latch together or, for increased safety, you can also insert a screw through the latching hook.

Fastening options for OMNIMATE® printed-circuit board plug-and-socket connectors

Flange options for plug-and-socket connectors

<http://www.OMNIMATE.net>

- = recommended
- = possible to a limited extent

				Fastening for the printed-circuit board		O	G
						open	closed
						no	no
OMNIMATE® Power	MF/MSF	centre flange	locking hook/ with screw				
	F1/SF1	inverted flange	locking hook/ with screw				
	F	flange	locking hook				
	LR	release latch	bar			●	●
	LH	release gear	no			●	●
	FI	inverted flange	nut			●	●
	F	flange	screw			●	●
	B	dovetail for B block	via accessories with a screw			●	●
	G	closed	no			●	●
					Fastening for the strip		
				Female connector			
				Male connector			

W

B	F / FI	LF/LFI/FLF	RF	MF/MSF
dovetail for B block	flange with nut	flange with nut	locking flange without a nut (for release latch)	centre flange with/without nut
with the nut from accessories	optional screw	terminal pin	terminal pin	terminal pin (partially)

Pin headers

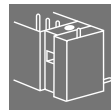
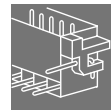
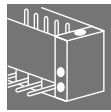
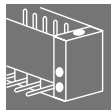
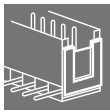

Socket terminal strips

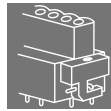
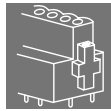
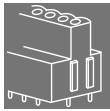

●	●	●	●	
●	●	●		
●	●	●		
●	●	●		
●	●	●		
●	●	●	●	
	●			
	●	●		
				●

Insulating materials

Weidmüller uses different insulating materials because of the diverse requirements placed on our products. The insulating materials do not contain any hazardous substances. The use of cadmium-free materials is a very high priority. Our insulating materials contain neither pigments based on heavy metals nor any substances that lead to the formation of dioxin or furan.

Thermoplastics			
Plastic Abbreviation	Wemid PA66	Wemid GF	Polyamide PA
	<p>Wemid is a modified thermoplastic, its properties are specially tailored to meet the needs of our cable connectors. Advantages over PA are the improved fire protection and the higher sustained working temperature. WEMID meets the stringent requirements for use in railway carriages according to NF F 16-101.</p>	<p>Glass-fibre reinforced WEMID offers excellent dimensional stability and very good mechanical properties. This makes a difference when used as an end bracket. The material falls in the V-0 flammability class according to UL 94.</p>	<p>Polyamide (PA) is one of the most widely used engineering plastics. Advantages of this material are its good electrical and mechanical characteristics, its flexibility and resistance to breakage. In addition, PA offers good fire resistance on account of its chemical structure even without the addition of flame retardants.</p>
Description	<p>higher sustained working temperature</p> <p>improved fire resistance</p> <p>halogen-free and phosphor-free flame-retardant material</p> <p>low smoke produced in the event of fire</p> <p>permitted for use in railway applications following NF F 16-101 specifications</p>	<p>excellent dimensional stability</p> <p>very good mechanical characteristics</p> <p>halogen-free flame retardant material</p>	<p>flexible, resistant to breakage</p> <p>good electrical and mechanical characteristics</p> <p>self-extinguishing characteristic</p> <p>halogen-free flame retardant material</p>
Properties			
Specific volume resistance to IEC 60093	$\Omega \times \text{cm}$	10^{12}	10^{15}
Electric strength to IEC 60243-1	kV / mm	25	35
Tracking resistance (A) to IEC 60112	CTI	600	550
Upper max. permissible temperature	°C	120	120
Lower max. permissible temperature, static	°C	-50	-40
Flamability class to UL 94		V-0	V-0
Fire behaviour to railway standard		I2 / F2 *)	-

W

Thermoplastics

<p>Polyamide PAGF</p>	<p>Polyphthalamide PPA (PA9T)</p>	<p>Polybutylene terephthalate PBT</p>	<p>Polybutylene terephthalate PBT (GF)</p>	<p>Liquid crystal polymer LCP (GF)</p>
<p>Glass-fibre reinforced polyamide (PAGF) offers excellent dimensional stability and very good mechanical characteristics. This makes a difference when used as an end bracket. As compared to unreinforced PA, this material has flammability rating HB according to UL 94.</p>	<p>Polyphthalamide (PPA) offers excellent mechanical and electrical properties. In addition, the high-performance material is characterized by its low water absorption and thus high dimensional stability and is suitable for both wave and reflow soldering processes.</p>	<p>Thermoplastic polyester (PBT) offers excellent dimensional stability (hence its use in plug connectors) and a high constant operating temperature. Compared to other insulating materials, the creepage-current resistance is lower.</p>	<p>Thermoplastic polyester (PBT/glass fibre reinforced) offers excellent dimensional stability (hence its use in plug connectors) and a high constant operating temperature. Compared to other insulating materials, the creepage-current resistance is lower.</p>	<p>LCP (glass fibre reinforced) offers excellent dimensional stability, particularly at high temperatures. As the material is similar to PCBs and has a very low thermal expansion coefficient, it is particularly suitable for components that are soldered in the reflow oven.</p>
<p>excellent dimensional stability</p> <p>very good mechanical characteristics</p> <p>halogen-free flame retardant material</p>	<p>increased continuous operating temperature</p> <p>very good electrical and mechanical properties</p> <p>low water absorption</p> <p>halogen-free flame retardant</p>	<p>high dimensional stability</p> <p>good electrical and mechanical characteristics</p> <p>Flame retardants that do not form dioxin or furan.</p>	<p>high dimensional stability</p> <p>good electrical and mechanical characteristics</p> <p>Flame retardants that do not form dioxin or furan.</p>	<p>excellent dimensional stability</p> <p>high constant operating temperature</p> <p>minimal water absorption</p> <p>low thermal expansion coefficient</p>
<p>10¹²</p> <p>30</p> <p>500</p> <p>100</p> <p>-50</p> <p>HB</p>	<p>35</p> <p>≥ 600</p> <p>125</p> <p>-50</p> <p>V-2 / V-0</p> <p>I2 / F2</p>	<p>10¹³</p> <p>28</p> <p>200</p> <p>115</p> <p>-50</p> <p>V-0</p>	<p>10¹³</p> <p>29</p> <p>200</p> <p>130</p> <p>-50</p> <p>V-0</p>	<p>10¹⁵</p> <p>35</p> <p>175</p> <p>240</p> <p>-50</p> <p>V-0</p> <p>-</p>

Metals

Metals

All the metals used by Weidmüller are selected and processed with their surfaces treated according to the latest technical standards.

Steels

Steel parts are electrogalvanised and treated with an additional Weidmüller passivation technique, WInQ®. The surface protection conforms to the highest standards, is matched to the special requirements of the connection systems used and is RoHS-compatible (RoHS = Restriction of Hazardous Substances). Experience gained from storage in outdoor test racks at different locations (industrial, marine, tropical and normal atmospheres) has been incorporated into the design of the surface protection.

Zinc protects against corrosion for a long time even after the zinc coating has been partially damaged by scratches or pores. In the presence of an electrolyte, zinc acts as a cathode (i.e. negative) with respect to steel. The metal ions of the zinc migrate to the steel, which provides long-term protection for the parent metal.

Conductive materials

The current-carrying materials copper, brass and bronze are characterised by a high conductivity plus good mechanical properties. The surfaces are usually given a coating of tin, which creates an extremely good, "malleable" contact with a low contact resistance.

Apart from ensuring consistently good electrical properties, the tin coating provides excellent protection against corrosion. Solder connections are also given a coating of tin.

In order to guarantee the long-term solderability (shelf life), the brass parts are given an additional nickel coating as a diffusion barrier. The nickel coating provides effective protection against the loss of zinc atoms from the brass.

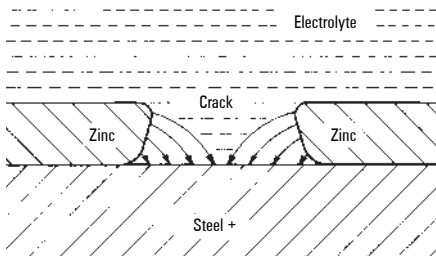

Derating curve (current-carrying capacity curve)

The **derating curve** shows which currents may flow continuously and simultaneously via all possible connections when the component is subjected to various ambient temperatures below its upper limit temperature.

The **upper limit temperature** of a component is the rated value determined by the materials used. The total of the ambient temperature plus the temperature rise caused by the current load (power loss at volume resistance) may not exceed the upper limit temperature of the component, otherwise it will be damaged or even completely ruined.

The current-carrying capacity is hence not a constant value, but rather decreases as the component ambient temperature increases. Furthermore, the current-carrying capacity is influenced by the geometry of the component, the number of poles and the conductor(s) connected to it. The current-carrying capacity is determined empirically according to DIN IEC 605 12-3. To do this, the resulting component temperatures $t_{b1}, t_{b2} \dots$ and the ambient temperatures t_{u1}, t_{u2} are measured for three different currents $I_1, I_2, I_3 \dots$

The values are entered on a graph with a system of linear coordinates to illustrate the relationships between the currents, the ambient temperatures and the temperature rise in the component.

The **loading currents** are plotted on the y-axis, the **component ambient temperatures** on the x-axis.

A line drawn perpendicular to the x-axis at the upper limit temperature t_g of the component completes the system of coordinates.

The associated average values of the temperature rise in the component, $\Delta t_1 = t_{b1} - t_{u1}, \Delta t_2 = t_{b2} - t_{u2}, \dots$ are plotted for every current I_1, I_2, \dots to the left of the perpendicular line. The points generated in this way are joined to form a roughly parabolic curve.

As it is practically impossible to choose components with the maximum permissible volume resistances for the measurements, the base curve must be reduced.

Reducing the currents to 80 % results in the **"derating curve"** in which the maximum permissible volume resistances and the measuring uncertainties in the temperature measurements are taken into account in such a way that they are suitable for practical applications, as experience has shown. If the derating curve exceeds the currents in the low ambient temperature zone, which is given by the current-carrying capacity of the conductor cross-sections to be connected, then the derating curve should be limited to the smaller current in this zone.

Base curve

max. temperature of component

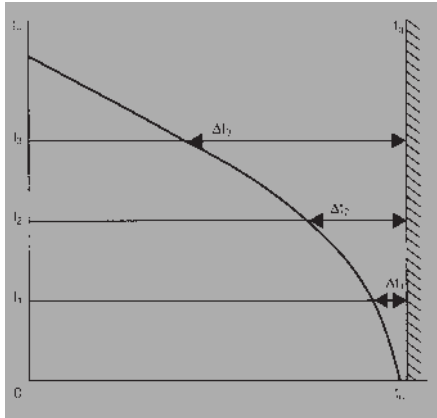

t_g = upper limit temperature of component
 t_u = ambient temperature
 I_n = current

Derating curve

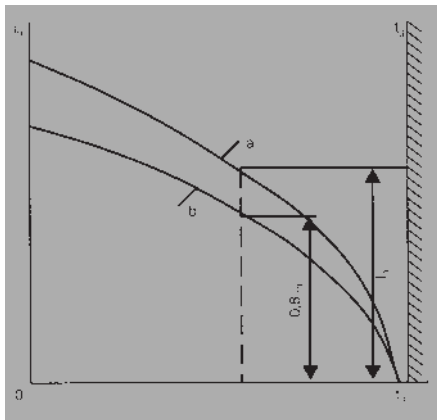

t_g = upper limit temperature of component
 t_u = ambient temperature
 I_n = current
a = base curve
b = reduced base curve (derating curve)

Example: derating curve for minimum and maximum number of poles

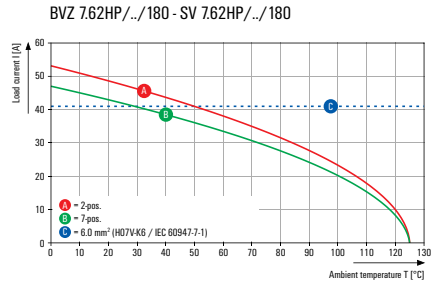

Design of clearance and creepage distances in electrical equipment

General:

Since April 1997 the sizing of clearance and creepage distances has been covered by DIN VDE 0110 part 1 "Insulation coordination for electrical equipment in low-voltage systems".

DIN VDE 0110 part 1 contains the modified edition of IEC Report 664-1 (see also IEC 664-1/Oct 1992). The design data resulting from these provisions is – if applicable – specified in this catalogue for each product.

Dimensioning of clearance and creepage distances to VDE 0110/Apr 1997 (IEC Report 664-1) "Insulation coordination for electrical equipment in low-voltage systems"

The provisions for insulation coordination result in the following relationships for dimensioning of clearance and creepage distances:

- **Clearances** are dimensioned according to the anticipated **overvoltages** taking into account the ratings of the **overvoltage protection precautions** in use and the anticipated environmental conditions taking into account the protective measures taken to prevent **pollution**.
- **Creepage distances** are dimensioned according to the **operating voltage** and the anticipated environmental conditions taking into account the **insulating materials** used and the protective measures taken to prevent **pollution**.

Table 1: Rated impulse withstand voltages for electrical equipment

Rated voltage of power supply system*) in V		Rated impulse withstand voltage in kV			
Three-phase systems	Single-phase systems with neutral point	Electrical equipment at the supply point of the installation (Overvoltage category IV)	Electrical equipment as part of the permanent installation (Overvoltage category III)	Electrical equipment to be connected to the permanent installation (Overvoltage category II)	Specially protected electrical equipment (Overvoltage category I)
	120 to 240	4,00	2,50	1,50	0,80
230/400 277/480		6,00	4,00	2,50	1,50
400/690 1000		8,00	6,00	4,00	2,50
		Values depend on the particular project or, if no values are available, the values above for 400/690 V can be used.			

*) to IEC 38

Category I is valid for specially rated equipment.

Category II is valid for technical committees responsible for electrical equipment specified for connecting to the mains power supply.

Category III is valid for technical committees responsible for installation materials, and for some specific technical committees.

Category IV is valid for power supply companies and particular projects.

Dimensioning of clearances

Decisive for the dimensioning of clearances are the **rated impulse withstand voltages** shown in table 1, which are derived from the **overvoltage category** and the **phase-to-earth** voltage depending on the rated mains voltage (taking into account all types of supply systems).

The minimum clearances (up to site altitudes of 2000 m above mean sea level) are determined from table 2a based on the **rated impulse withstand voltage** and the **pollution severity**.

Note: Clearances that do not comply with case A must be subjected to an impulse withstand voltage test (see table 2a, footnote 1).

Table 2a: Minimum clearances to VDE 0110-1/Apr 1997

Rated impulse withstand volt. in KV	Minimum clearance distances in mm for sites up to 2000 m above sea level										
	Case A (inhomogeneous field)				Case B (homogeneous field)						
	Pollution severity				Pollution severity						
	1	2	1)	3	4	1	2	1)	3	4	
0,33	0,01			0,80	1,60	0,01	0,20	0,20	0,80	1,60	
0,40	0,02		0,10			0,02					0,10
0,50	0,04	0,20				0,04					
0,60	0,06		0,12			0,06					0,12
0,80	0,10					0,10					
1,00	0,15		0,20			0,15					0,20
1,20	0,25	0,25		0,20			0,30				
1,50	0,50	0,25				0,45	0,45				
2,00	1,00	1,00		1,00		0,60	0,60				
2,50	1,50	1,50		1,50		0,80	0,80				
3,00	2,00	2,00		2,00	2,00	1,20	1,20		1,20		
4,00	3,00	3,00		3,00	3,00	1,50	1,50		1,50		
5,00	4,00	4,00		4,00	4,00	2,00	2,00		2,00	2,00	
6,00	5,50	5,50		5,50	5,50	3,00	3,00		3,00	3,00	
8,00	8,00	8,00		8,00	8,00	3,50	3,50		3,50	3,50	
10,00	11,00	11,00		11,00	11,00	4,50	4,50		4,50	4,50	
12,00	14,00	14,00		14,00	14,00	5,50	5,50		5,50	5,50	
15,00	18,00	18,00		18,00	18,00						

1) Pollution severity 2 is split for impulse voltages up to 1.00 kV (case A) or 1.20 kV (case B). These values apply for printed circuits but deviate from those in IEC Report 664.

The **pollution severity categories** are as follows:

Pollution severity category 1:
No pollution, or only dry, non-conductive pollution that has no influence.

Pollution severity category 2:
Non-conductive pollution only; occasional condensation may cause temporary conductivity.

Pollution severity category 3:
Conductive pollution, or dry, non-conductive pollution that is liable to be rendered conductive through condensation.

Pollution severity category 4:
Contamination results in constant conductivity, e.g. caused by conductive dust, rain or snow.

The following aspects apply to the **overvoltage categories** in accordance with the German standard DIN VDE 0110-1:

Electrical equipment fed directly from the low-voltage mains
Specification of a specific overvoltage category shall be based on the following:

– Equipment of *overvoltage category I* is equipment that is intended to be connected to the permanent electrical installation of a building. Measures to limit transient overvoltages to the specific level are taken outside the equipment, either in the permanent installation or between the permanent installation and the equipment.

– Equipment of *overvoltage category II* is equipment to be connected to the permanent electrical installation of a building.

Note: Examples of such equipment are household appliances, portable tools and similar loads.

– Equipment of *overvoltage category III* is equipment that is part of the permanent electrical installation and other equipment where a higher degree of availability is expected.

Note: Examples of such equipment are distribution boards, circuit-breakers, wiring systems (IEV 826-06-01, including cables, busbars, junction boxes, switches,

power sockets) in the permanent installation, and equipment for industrial use and some other equipment, e.g. stationary motors with permanent connections to the permanent installation.

– Equipment of *overvoltage category IV* is for use at or in the proximity of the incoming supply point of the electrical installations of buildings upstream of the main distribution board.

Table 3a: Single-phase 2- or 3-wire AC or DC systems

Rated voltage of the power supply (mains) ¹⁾	Voltages for table 4	
	For insulation phase-to-phase ¹⁾	For insulation phase-to-earth ¹⁾
	All systems	3-wire systems, neutr. point earthing
V	V	V
12,5	12,5	-
24	25	-
25		
30	32	-
42		
48	50	-
50**)		
60	63	-
30-60	63	32
100**)	100	-
110	125	-
120		
150**)	160	-
220	250	-
110-220	250	125
120-240		
300**)	320	-
220-440	500	250
600**)	630	-
480-960	1000	500
1000**)	1000	-

1) Phase-to-earth insulation levels for unearthed or impedance-earthed systems are equal to those of phase-to-phase because the operating voltage to earth of any phase can, in practice, reach full phase-to-phase voltage. This is because the actual voltage to earth is determined by the insulation resistance and capacitive reactance of each phase to earth; thus, a low (but acceptable) insulation resistance of one phase can earth it and raise the other two to full phase-to-phase voltage to earth.

*) It is assumed that the rated voltage of the electrical equipment is not lower than the nominal voltage of the power supply.

***) Because of the common changes, the meaning of the ** symbol has not been used in table 1; i.e. the / symbol indicates a 4-wire 3-phase distribution system. The lower value is the phase-to-neutral voltage, while the higher value is the phase-to-phase voltage. Where only one value is indicated, it refers to 3-wire, 3-phase systems and specifies the value phase-to-phase. The values given in table 1 are still taken into account in tables 3a and 3b by the ** symbol.

Table 3b: 3-phase 3- or 4-wire AC systems

Rated voltage of the power supply (mains) ¹⁾	Voltages for table 4			
	For insulation phase-to-phase ¹⁾	For insulation phase-to-earth ¹⁾		
		All systems	3-phase 4-wire systems with earthed neutral wire ²⁾	3-phase 3-wire systems unearthed ¹⁾ or phase-earthed
V	V	V	V	
60	63	32	63	
110/120/127	125	80	125	
150**)	160	-	160	
208	200	125	200	
220/230/240	250	160	250	
300**)	320	-	320	
380/400/415	400	250	400	
440	500	250	500	
480/500	500	320	500	
575	630	400	630	
600**)	630	-	630	
660/690	630	400	630	
720/830	800	500	800	
960	1000	630	1000	
1000**)	1000	-	1000	

1) Phase-to-earth insulation levels for unearthed or impedance-earthed systems are equal to those of phase-to-phase because the operating voltage to earth of any phase can, in practice, reach full phase-to-phase voltage. This is because the actual voltage to earth is determined by the insulation resistance and capacitive reactance of each phase to earth; thus, a low (but acceptable) insulation resistance of one phase can earth it and raise the other two to full phase-to-phase voltage to earth.

2) For electrical equipment for use in both 3-phase 4-wire and 3-phase 3-wire supplies, earthed and unearthed, use the values for 3-wire systems only.

*) It is assumed that the rated voltage of the electrical equipment is not lower than the nominal voltage of the power supply.

***) Because of the common changes, the meaning of the ** symbol has not been used in table 1; i.e. the / symbol indicates a 4-wire 3-phase distribution system. The lower value is the phase-to-neutral voltage, while the higher value is the phase-to-phase voltage. Where only one value is indicated, it refers to 3-wire, 3-phase systems and specifies the value phase-to-phase. The values given in table 1 are still taken into account in tables 3a and 3b by the ** symbol.

Measurement of clearance and creepage distances according to VDE / IEC

Note: Examples of such equipment are electricity meters, circuit-breakers and ripple control units.

Note on application of pollution severity and overvoltage categories

The pollution severity and rated impulse withstand voltage derived from the overvoltage category are each specified in this catalogue and are product-related. In principle, the dimensioning of clearance and creepage distances, and the resulting specification of ratings for electromechanical products (terminal

blocks, terminal strips, PCB terminals/connectors) is based on pollution severity 3 and overvoltage category III considering all types of systems.

Dimensioning of creepage distances

Decisive for dimensioning of creepage distances are the rated voltages derived from the **system voltages** of the power supply for the respective **type of supply system** in conjunction with the **pollution severity** (classification, see "Clearances") and the **insulating material** used. Taking into account tables 3a and 3b and the CTI (Comparative Tracking

Index) of the insulating material, the minimum creepage distances are determined from table 4.

The insulating materials are subdivided into four groups according to their CTI (Comparative Tracking Index):

Insulating material	
I	600 ≤ CTI
II	400 ≤ CTI < 600
III a	175 ≤ CTI < 400
III b	100 ≤ CTI < 175

Table 4: Minimum creepage distances

Rated voltage U _{eff} or U _i in V	Creepage distance in mm											
	Printed circuits		Other electrical equipment	Pollution severity								
	Pollution severity		1	2			3			4		
	Insulating mat.	Insulating mat.	Insulating mat.	Insulating material group			Insulating material group			Insulating material group		
2)	3)	2)	I	II	III	I	II	III ⁴⁾	I	II	III ⁴⁾	
10	0,025	0,04	0,08	0,40	0,40	0,40	1,00	1,00	1,00	1,60	1,60	1,60
12,5	0,025	0,04	0,09	0,42	0,42	0,42	1,05	1,05	1,05	1,60	1,60	1,60
16	0,025	0,04	0,10	0,45	0,45	0,45	1,10	1,10	1,10	1,60	1,60	1,60
20	0,025	0,04	0,11	0,48	0,48	0,48	1,20	1,20	1,20	1,60	1,60	1,60
25	0,025	0,04	0,125	0,50	0,50	0,50	1,25	1,25	1,25	1,70	1,70	1,70
32	0,025	0,04	0,14	0,53	0,53	0,53	1,30	1,30	1,30	1,80	1,80	1,80
40	0,025	0,04	0,16	0,56	0,80	1,10	1,40	1,60	1,80	1,90	2,40	3,00
50	0,025	0,04	0,18	0,60	0,85	1,20	1,50	1,70	1,90	2,00	2,50	3,20
63	0,040	0,63	0,20	0,63	0,90	1,25	1,60	1,80	2,00	2,10	2,60	3,40
80	0,063	0,10	0,22	0,67	0,95	1,30	1,70	1,90	2,10	2,20	2,80	3,60
100	0,10	0,16	0,25	0,71	1,00	1,40	1,80	2,00	2,20	2,40	3,00	3,80
125	0,16	0,25	0,28	0,75	1,05	1,50	1,90	2,10	2,40	2,50	3,20	4,00
160	0,25	0,40	0,32	0,80	1,10	1,60	2,00	2,20	2,50	3,20	4,00	5,00
200	0,40	0,63	0,42	1,00	1,40	2,00	2,50	2,80	3,20	4,00	5,00	6,30
250	0,56	1,00	0,56	1,25	1,80	2,50	3,20	3,60	4,00	5,00	6,30	8,00
320	0,75	1,60	0,75	1,60	2,20	3,20	4,00	4,50	5,00	6,30	8,00	10,00
400	1,00	2,00	1,00	2,00	2,80	4,00	5,00	5,60	6,30	8,00	10,00	12,50
500	1,30	2,50	1,30	2,50	3,60	5,00	6,30	7,10	8,00	10,00	12,50	16,00
630	1,80	3,20	1,80	3,20	4,50	6,30	8,00	9,00	10,00	12,50	16,00	20,00
800	2,40	4,00	2,40	4,00	5,60	8,00	10,00	11,00	12,50	16,00	20,00	25,00
1000	3,20	5,00	3,20	5,00	7,10	10,00	12,50	14,00	16,00	20,00	25,00	32,00

2) Insulating materials I, II, IIIa, IIIb
 3) Insulating materials I, II, IIIa
 4) Creepage distances are not determined in this range. Insulation group IIIb is generally not recommended for pollution severity 3 with voltages > 630 V, and is never recommended for pollution severity 4.



The comparative tracking index must be determined according to DIN IEC 112/VDE 0303 part 1 on the basis of specially prepared samples with test solution A.

Slots are taken into account in the measurement of creepage distances when their minimum width x is dimensioned according to the following table:

Pollution-severity	Minimum width x mm
1	0,25
2	1,0
3	1,5
4	2,5

If the associated clearance is less than 3 mm, the minimum slot width can be reduced to 1/3 of the clearance.

Clearance and creepage distances

The maximum voltage to be applied to the connector depends on the distance between two connections.

Two distances have to be taken in account:

- Clearance = shortest distance between two conductive parts (in air)
- Creepage distance = distance along surface

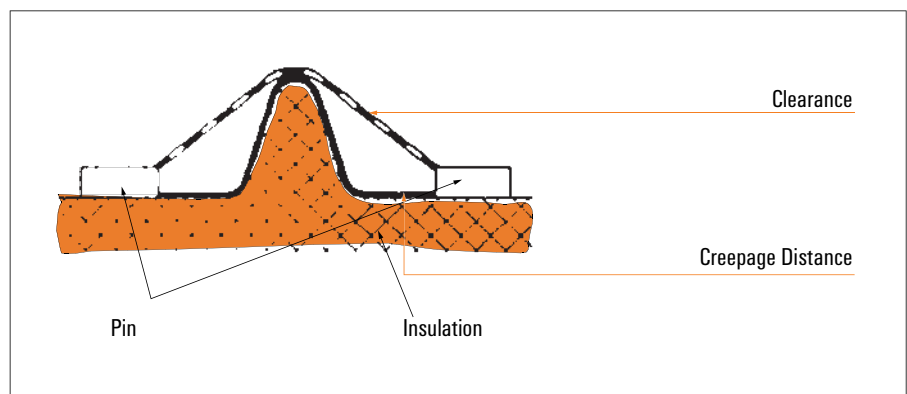

Measurement of clearance and creepage distances according to UL

300 V

Comparison of UL clearance and creepage distances for UL 300 Volt

				min. clearance	
UL 1059	minimum spacing (Table 8.1)	151 - 300 V		6.4 mm	9.5 mm
UL 508C	minimum spacing (Table 36.1)	151 - 300 V		6.4 mm	9.5 mm
UL 508C	minimum spacing for products with known controlled transient voltages (Table 36.3)	Peak working voltage:	226 - 450 V / > 10 kVA	3.81 mm	5.08 mm
		Peak working voltage:	226 - 400 V / 500 VA - 10 kVA	2.54 mm	2.54 mm

Creepage distance determination related to UL 840

	Operating Voltage	Creepage distance for material group (CTI)*		
		I	II	IIIa & IIIb
UL 840 Table 9.1 Pollution degree 3 (alternate 36.9.3 UL 508C)	320 V	4.0 mm	4.5 mm	5.0 mm
	400 V	5.0 mm	5.6 mm	6.3 mm
UL 840 is similar to IEC 664-1	500 V	6.3 mm	7.1 mm	8.0 mm
UL 840 Table 9.1 Pollution degree 2 (alternate 36.9.3 UL 508C)	320 V	1.6 mm	2.2 mm	3.2 mm
	400 V	2.0 mm	2.8 mm	4.0 mm
	500 V	2.5 mm	3.6 mm	5.0 mm

Clearance determination related to UL 840 for 300 Volt

	Overvoltage category	Rated Impulse withstand voltage peak	minimum Clearance (600 V)
UL 840 Table 8.1 Pollution degree 3 (alternate 36.9.3 UL 508C)	II	2.5 kV	1.5 mm
	III	4.0 kV	3.0 mm
UL 840 is similar to IEC 664-1	IV	6.0 kV	5.5 mm
UL 840 Table 8.1 Pollution degree 2 (alternate 36.9.3 UL 508C)	II	2.5 kV	1.5 mm
	III	4.0 kV	3.0 mm
	IV	6.0 kV	5.5 mm

600 V

Comparison of UL clearance and creepage distances for UL 600 Volt

				min. clearance	
UL 1059	minimum spacing (Table 8.1)	301 - 600 V		9.5 mm	12.7 mm
UL 508C	minimum spacing (Table 36.1)	151 - 300 V		9.5 mm	12.7 mm
UL 508C	minimum spacing for products with known controlled transient voltages (Table 36.3)	Peak working voltage:	451 - 900 V / > 10 kVA	7.62 mm	10.16 mm
		Peak working voltage:	451 - 900 V / 500 VA - 10 kVA	5.08 mm	5.08 mm

Creepage distance determination related to UL 840

	Operating Voltage	Creepage distance for material group (CTI)*		
		I	II	IIIa & IIIb
UL 840 Table 9.1 Pollution degree 3 (alternate 36.9.3 UL 508C)	630 V	8.0 mm	9.0 mm	10.0 mm
	800 V	10.0 mm	11.0 mm	12.5 mm
UL 840 is similar to IEC 664-1	1000 V	12.5 mm	14.0 mm	16.0 mm
UL 840 Table 9.1 Pollution degree 2 (alternate 36.9.3 UL 508C)	630 V	3.2 mm	4.5 mm	6.3 mm
	800 V	4.0 mm	5.6 mm	8.0 mm
	1000 V	5.0 mm	7.1 mm	10.0 mm

Clearance determination related to UL 840 for 600 Volt

	Overvoltage category	Rated Impulse withstand voltage peak	minimum Clearance (600 V)
UL 840 Table 8.1 Pollution degree 3 (alternate 36.9.3 UL 508C)	II	4.0 kV	3.0 mm
	III	6.0 kV	5.5 mm
UL 840 is similar to IEC 664-1	IV	8.0 kV	8.0 mm
UL 840 Table 8.1 Pollution degree 2 (alternate 36.9.3 UL 508C)	II	4.0 kV	3.0 mm
	III	6.0 kV	5.5 mm
	IV	8.0 kV	8.0 mm

Guideline: relationship between approvals

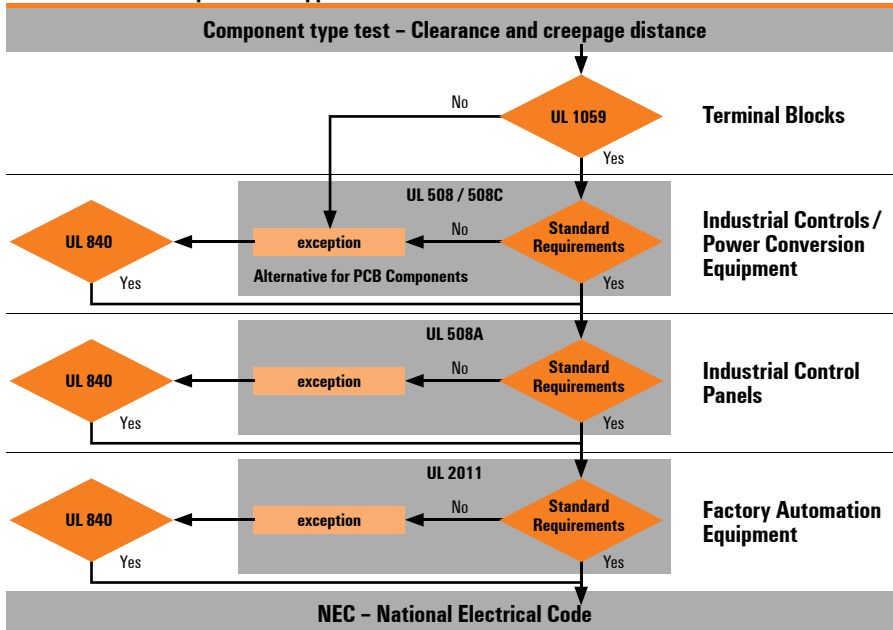

White Paper UL:

Webcode: #11359

We share our expertise: Find out detailed information and interesting facts about trend topics in the field of device connectivity in our Whitepaper section.



W

Design-in recommendations: applications for 600 V in accordance with UL

Summary of the most important UL requirements:

- PCB components are approved to UL 1059 and are tested without a PCB or application environment.
- Applications are approved to UL 508 (or UL 508C Power Conversion Equipment, e.g. frequency converters).
- The application designer must refer to the application-related UL standards, not to UL 1059.
- UL 508C enables the use of field terminals approved to UL 1059 for 300 V to be used for 600 V applications under certain conditions.
- Weidmüller Powermate Range plug-in connectors and power terminals comply with the conditions and may be used for 600 V applications to UL 508C.
- For more detailed information, please refer to the drawing below.

The approval for higher voltages to UL 508C / UL 840:

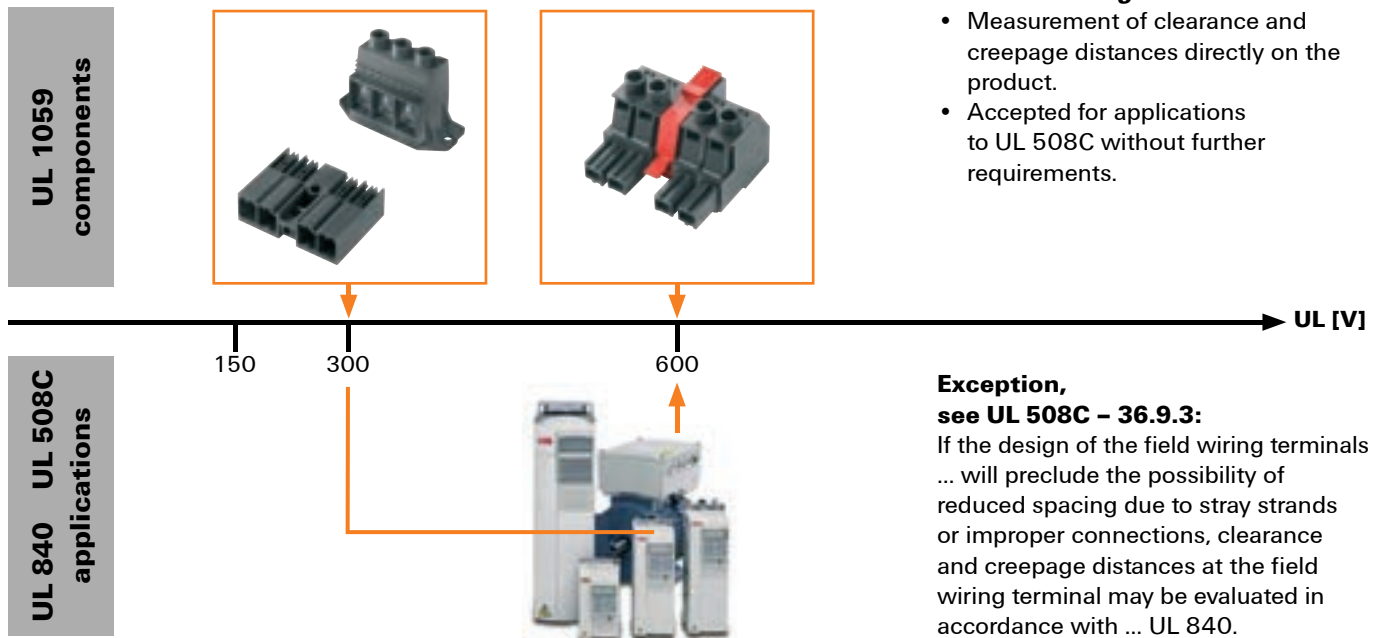

Extract from UL 508C: (36.9 Spacings for drives evaluated in accordance with UL 840)

- 36.9.1 Other than as noted in 36.9.2 and 36.9.3, clearance and creepage distances are able to be evaluated in accordance with the requirements in the Standard for Insulation Coordination Including Clearance and Creepage Distances for Electrical Equipment, UL 840. See 36.9.4 for details on applying UL 840.
- 36.9.2 Clearances between an uninsulated live part and the walls of a metal enclosure, including fittings for conduit or armored cable, shall be in accordance with 36.2.2. The clearances shall be determined by physical measurement.
- 36.9.3 The clearance and creepage distance at field wiring terminals shall be in accordance with the requirements in 36.3.1. Exception: When the design of the field wiring terminals precludes the possibility of reduced spacing due to stray strands or improper wiring installation, then clearance and creepage distances at these terminals are able to be evaluated in accordance with the Standard for Insulation Coordination Including Clearance and Creepage Distances for Electrical Equipment, UL 840.

Weidmüller connectors in the reflow soldering process

The PCB assembly process has undergone a fundamental change in recent years. The conventional through-hole mounting technology (Through Hole Technology, THT) has been increasingly replaced by surface mounting technology (SMT). The reasons for this was the increasing demands of miniaturisation, higher functional density and lower manufacturing costs. The progress made in the development of surface mounted devices (SMD), that allowed the development of the SMT manufacturing process in the first place has also played a role. SMT is now the accepted standard in PCB manufacturing. There are still some components, in the main electro-mechanical components like connectors or relays, which are not available in a SMD version, they are therefore mounted following the SMT process using the classical THT assembly onto the PCB. Weidmüller has developed a product range for the through hole reflow process (THR), that makes wired component parts usable in the SMT process and allows 100 % processing in the SMT production line.

Through-hole reflow is a process for linking THT components with the SMT reflow soldering process. In addition to just SMD assembly, the SMD components with THR can be placed onto the SMT printed-circuit board together with wired components and be soldered in the reflow process. The THR process was developed from the realisation that stable soldering connections are still necessary with heavy components such as coils or transformers, as well as wherever mechanical forces come to bear on the printed-circuit boards, (such as with connection terminals, plug-and-socket connectors or relay sockets). SMD soldered joints are less suited for heavy components under substantial mechanical stress.

A SMT compatible product is always a compromise between optimal SMT capability and the stability of the solder connection. THR ensures a stable connection of the THT components to the PCB using the push-through pins. At the same time this ensures 100 % compatibility with the SMT process.

Benefits of THR:

- stable connection to the PCB
- only one soldering process
- No longer a need for hand or wave soldering
- automatic assembly
- lower production costs



In order to use THR components in the SMT process, they must meet certain requirements.

Stability in a new dimension

Our pin headers are made of glass-fibre reinforced LCP (liquid crystal polymers). This guarantees a high level of shape stability. The material's excellent temperature characteristics and the built-in grid space are excellent for the SMT process as well as "lead-free soldering".

The benefits:

- High temperature resistance
- Melting point of 335 °C
- Free from halogens
- Low thermal expansion coefficient
- Should be processed without drying

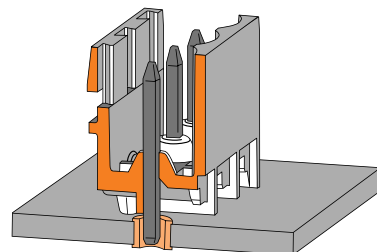

Remains true even to the pitches

Weidmüller's makes its male headers SL-SMT from LCP (liquid crystal polymer) to prevent undesirable dimensional changes caused by water absorption during storage. This ensures the highest pitch accuracy, even at high pin counts and secures the placement process.

The basis for high quality, reliability and efficiency

THR technology

THR soldering process is the processing of components that are inserted through a hole in the PCB and then soldered along with the other SMT components. In this technology the components themselves must be able to withstand the higher temperatures of the SMT process.

Through hole technology in the SMT process

The placement process of PCBs has undergone a fundamental change in recent years. The conventional through hole mounting technique (THT) was increasingly replaced by the surface mounting process (SMT). SMT is now the accepted standard for PCB manufacture.

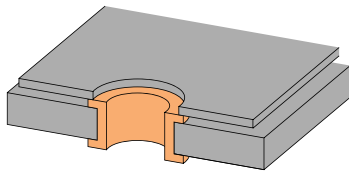

"Design in" – "Design out" from experience

Standard-process parameters help when drafting the printed-circuit board and template layout. Weidmüller recommends pin headers with short pins of 1.5 mm length. The following parameters have to be determined for the printed-circuit board design:

- Mounting hole diameter
- Soldering terminal diameter
- Stencil hole diameter
(with sufficient paste filling)
- Stencil hole diameter
(with insufficient paste filling)

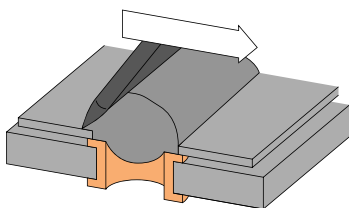

Paste printing – low volume in the best shape

Weidmüller SL-SMT pin headers have short octagonal pins with a chamfered pin end to keep the required paste volume as low as possible. Due to the pin length of just 1.5 mm for standard PCBs with a 1.6 mm thickness, an optimal solder joint shape can be achieved with a paste filling of approximately 90 %.

In addition, most normal one layer stencils for fine pitch techniques and the standard process parameters for squeegee speed and printing can be used.

Unbeatable advantage: the paste is pushed out of the placement hole during the placement process.

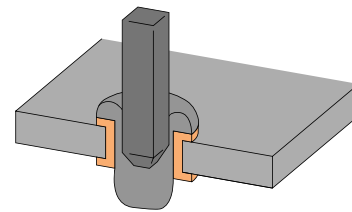

Assembly – short pins – great performance

Due to the shorter pins of 1.5 mm, you can have a higher packing volume for tape on reel or tray. This is also supported on the one side by the fact that SL-SMT male headers have a low profile, and also the reduced packaging height. Standard and anti-static packaging also allows fully automatic assembly with the commonly available Pick & Place systems. Outstanding advantages are offered by the short pins of the SL-SMT and the optimising of the travel height as well as the precision of the pin end position. Additionally, collisions between the components and the PCB can be completely avoided. At the same time, the SMT optimised male headers from Weidmüller increase the assembly strength due to their low weight.

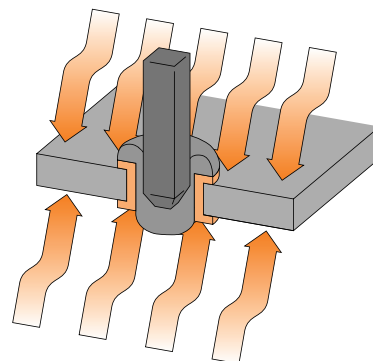

Reflow solder – the material of the future

High temperature resistant, halogen free insulating material LCP (Liquid Crystal Polymer) has a melting point of 335 °C. It not only has high dimensional stability, but also good resistance to the heat of soldering. Our SL-SMT male headers made from LCP are future proof, and can be used in lead-free solder processes. This leads to another key advantage of LCP: though its low thermal expansion coefficient, the bending of an assembly following the soldering process is avoided.

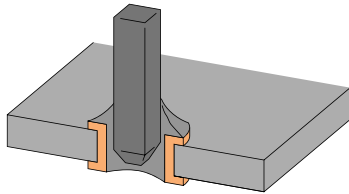

Quality control – control is better

To determine the quality of the solder joints of the THR components with short or long pins, Weidmüller has chosen the quick and simple checking using optical inspection, or X-ray examination. This meets the requirements of the internationally recognised norms and standards.

Our specially designed SL-SMT male headers allow optical inspection of the primary side of a PCB even for varieties with 180° outlet direction. This meets the requirements for in-process quality control.

Design recommendations for the through-hole reflow process

Solder paste volume and filling degree for 1.2 mm pin diameter.

The volume of paste and hence the degree of filling of the solder paste in the paste printing technology is critical for optimum soldering results in the SMT process. We recommend determining the quantity of solder paste as follows:

Volume of paste (or rather, degree of filling):

for solder joint filling and solder joint form within the tolerances to IPC-A610

Male conn. (open and closed):	2 to 8 poles	9 to 24 poles
Male conn. (solder flange LF):	-	2 to 24 poles
Recommended finished hole I.D. *1):	$d_i = 1,4^{+0,1}$ mm	$d_i = 1,5^{+0,1}$ mm
	Paste volume V_p [mm ³] / filling level f_p [%] after stencil print	
Minimum solder joint shape	2,4 mm ³ / 70 %	3,1 mm ³ / 85 %
Optimum solder joint shape	2,9 mm ³ / 90 %	3,5 mm ³ / 100 %

Valid with the following parameters for all SL-SMT variations:

Male connector:

Pin length = **L** [mm] = 1,5^{-0,3}
 Pin diameter = **d** [mm] = 1,2

PCB:

Thickness = **H** [mm] = 1,6
 Placement hole = metallised
 Placement hole inner diameter ID = **d_i** [mm] = see table¹⁾
 Placement hole outer diameter OD = **d_A** [mm] = 2,3
 Positioning tolerance to IEC 326-3 = very fine

Stencil:

Thickness = **D_s** [µm] = 120 - 180
 Stencil hole diameter = **d_s** [mm] = 2,1²⁾

Solder paste:

Solder paste particle size [µm] = 20 - 40 = Type 3
 Evaporation volume of solder paste [%] = approx. 50

Process:

Stencil print technology = squeegee print, single
 Filling level in placement hole = **f_p** [%] = see table
 Technology for automatic assembly = pick&place
 Temperature profile = to EN 61760-1

¹⁾ Tolerances for components, PCBs and automatic machines must be taken into account.

²⁾ Stencil hole diameter approx. 10 % smaller than placement hole outer diameter **d_A**

Recommendations for S2C-SMT and SC-SMT 3.81 see:

<http://catalog.weidmueller.com>

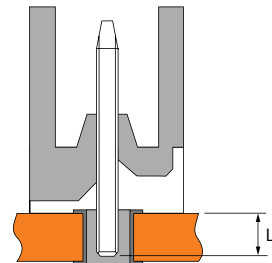

Male connector parameters

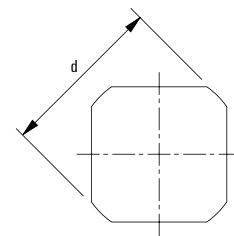

Pin cross-section

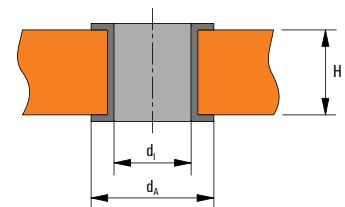

PCB parameters

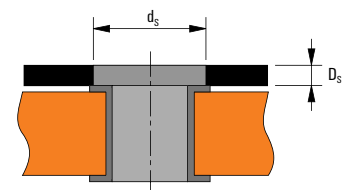

Stencil parameters

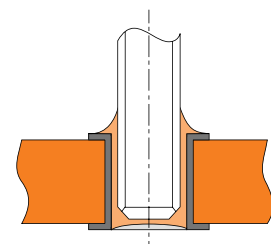

Optimum solder joint form

Quality control

Quality control completes the SMT production process. The goal in this process step is, using appropriate techniques, to check the quality of the solder joints of the THR components with short or long pins quickly and easily. The quality control rules for the THR solder technique are the same as for flow or wave soldering of THT components.

Control process:

The process quality control can be achieved by using various technologies. Currently optical or X-ray examination is mostly used. The optical examination evaluates the shape, reflectivity and colour of the solder joints.

In the manual process, a magnifying glass or microscope is used, in the automatic process a computer controlled camera and software based image analysis is used.

In X-ray inspection, however, radiographic evaluation using automated X-ray microscopy is carried out. An important control factor are destructive testing in addition to the inspection process. Random samples are taken and used to verify measurable quantities:

- Analysis of the filling behaviour by cutting through the solder joint
- Mechanical testing of the pin pull-out resistance from the contacts

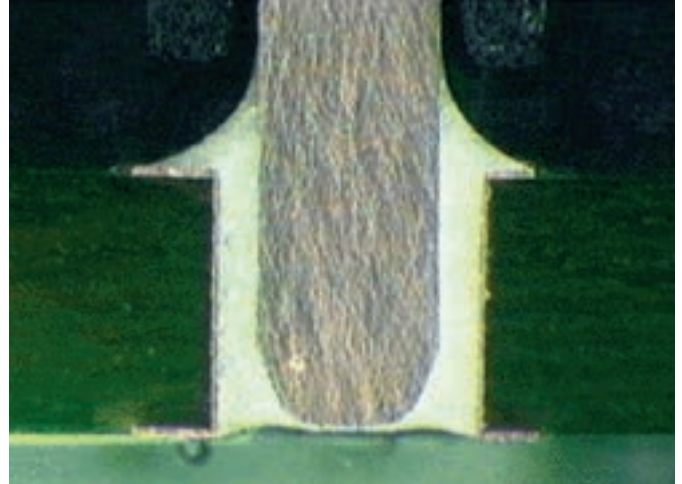

Cutting through the THR solder joint with the short pin

Norms and standards:

To make quality control more objective, norms and standards have been introduced over the recent years. In addition to other acceptance criteria for the manufacturing of electronic components, the quality control assessment criteria of the IPC-A-610E Norm are globally recognised.

According to IPC-A-610E quality requirements, THR solder joints are divided into three classes. For industrial applications where high power demands are made, Class 3 is the usual requirement. The following values are set for the five assessment criteria:

- The primary side solder wetting coverage (i.e. the insertion side from the view of the component), connection and sleeve should not be less than 270°.
- The vertical solder filling must be at least 75 %.

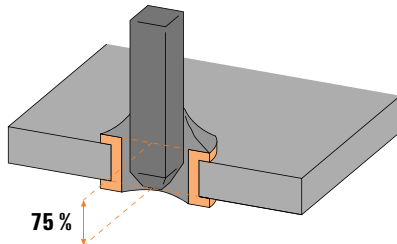
**Measuring the filling level of through hole solder joints according to IPC-A-610E**

- The secondary side solder wetting coverage (i.e. the underside from the view of the component) should not be less than 330°.
- Solder wetting of the solder pads (i.e. remains of the original ring of the THR solder joint) on the primary side is to be 0 %.
- Solder wetting of the solder pads on the secondary side must be at least 75 %.

These standards produce many demands on the wired components in the quality control. It should be noted that, in the THR process, there are typically two different construction types:

- Short pins when compared to the PCB thickness
- Longer pins when compared to the PCB thickness (about 1 to 1.5 mm protrusion)

For short pin construction there are the following requirements:

- The solder joints on the primary side of the PCB must be visible.
- For components with pins under the insulating body, the height of the component over the PCB must be sufficient to allow optical inspection.

For long pins, there are the following requirements:

- The solder joints on the secondary side must be visible.
- Solder joints on the primary side are, however, not required.

Additionally, in destructive testing with THR components there are requirements placed on the PCB itself. To control the quality of the PCB construction, the pull out strength of the solder pins from the solder joint is tested.

Required pull out strength:

- with short pins: approximately > 150 N.
- for long pins with a solder meniscus on the primary and secondary sides: approximately 220 N.

In comparison,

For surface connections for SMD components the required pull-out strength is only about 15 - 20 N.

According to IPC-A-610 Revision E-2010, section 7.3.3 the use of pins that are shorter than the PCB thickness is permissible in principle.

OMNIMATE® Signal SMD goes one step further in the development of a conventional THR solder connection

OMNIMATE® Signal terminals are now available as SMD components. Surface-mount connectors are increasingly being incorporated into standard SMT processes in electronic module production. Solder pad design and co-planarity produce optimum holding forces on the printed circuit board and guarantee a secure connection.

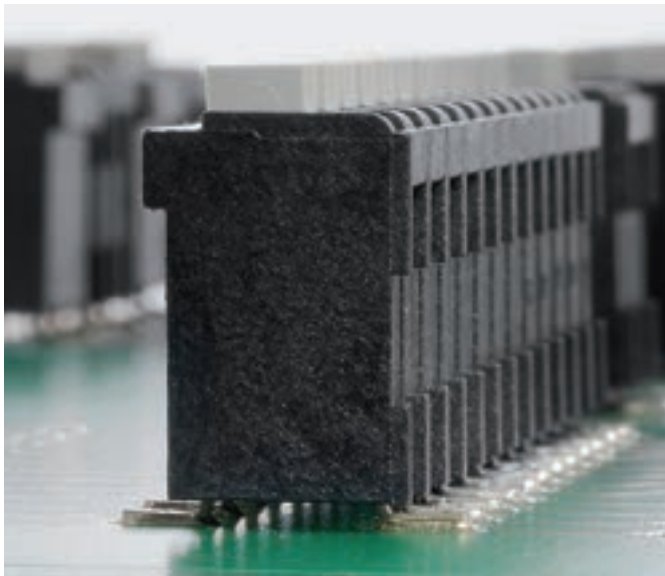
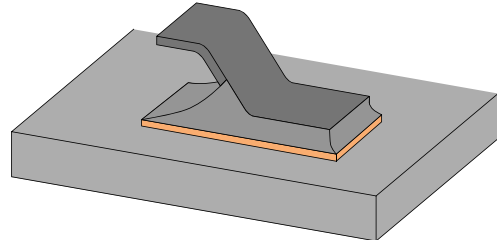

LSF-SMD

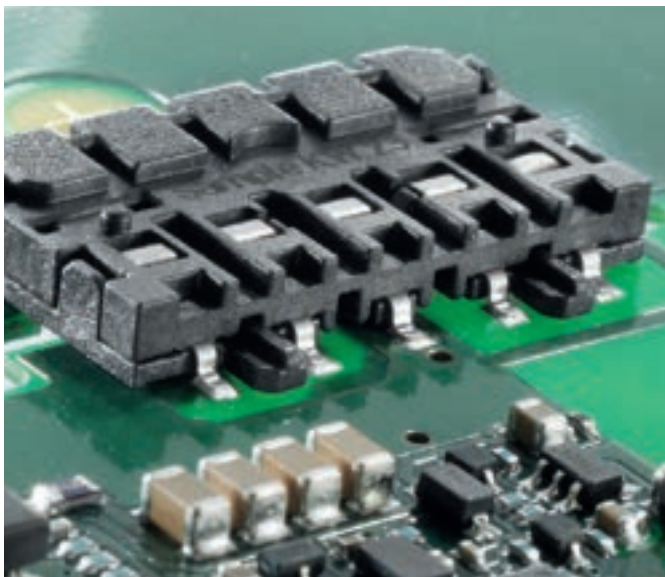

CH20M bus contact block

The SMD PCB terminal, LSF-SMD, meets the needs of fully-automated PCB manufacturing processes. This genuine SMD variant is a valuable addition to the existing range of reflow-capable LSF SMT PCB terminals, with THR soldering processes from Weidmüller. Applications on glass, ceramic or aluminium composite PCBs can now also be safely connected.

Benefits of the LSF for surface mounting

- All of our tape-on-reel product is supplied on industry-standard reels. Enhanced pick-and-place pads guarantee reliable positioning on the printed circuit board.
- With two solder pins per pole, the LSF-SMD printed-circuit board clamp meets the high demands made of mechanical fixing on the printed-circuit board without additional fastening flanges according to IPC-A-610 of class 2.
- Additional function space on rear of PCB. Use of our SMD products eliminates the need to through connect THR components, giving you more function space for two-sided mounting on the rear of the PCB with design-in.

SMD plug-in connectors are also used in the modular CH20M Housing. The bus contact block is resistant to high temperatures and, with its gold-plated springs, provides a secure and permanent connection to the system bus.

Conversion table

AWG to mm² conductors

AWG is the abbreviation for “**A**merican **W**ire **G**auge”. This designation bears no resemblance to the actual cross-section of the conductor.

The relationship between AWG and mm² is shown in the following table.

AWG	mm ²
28	0.08
26	0.13
24	0.21
22	0.32
20	0.52
19	0.65
18	0.82
17	1.04
16	1.31
15	1.65
14	2.08
13	2.63
12	3.31
11	4.17
10	5.26
9	6.63
8	8.37
7	10.55
6	13.30
5	16.77
4	21.15
3	26.67
2	33.63
1	42.41
0	53.48

Index

Index	Index Type	X.2
	Index Order No.	X.22
	Addresses worldwide	X.44

Type	Order No.	Page
A		
ADP 1/HP1 1M	048520000	T.50
ADP 10	416932000	T.54
ADP 11	416933000	T.54
ADP 5	416715000	T.52
ADP 6	416716000	T.52
AP 100 D OR	118516000	T.54
AP 100 OR 1665	118506000	T.54
AP 110 D OR	118536000	T.54
AP 110 OR	118526000	T.54
AP 111 D OR	118556000	T.54
AP 111 OR	118546000	T.54
AP 45/L DI GR	814087000	T.50
AP 45/LI GR 2025	814391000	T.50
AP 45/LI OR 1665	101159000	T.50
AP 45/RE DI GR	814086000	T.50
AP 45/RE GR 2025	814390000	T.50
AP 45/RE OR 1665	101160000	T.50
AP 80 D OR	132436000	T.52
AP 80 GR	832030000	T.52
AP 80 OR	132426000	T.52
AP 85 D OR	141106000	T.52
AP 85 OR	141086000	T.52
AP 86 D OR	141116000	T.52
AP 86 OR	141096000	T.52
AP 90 GR	196189000	T.53
AP 90 OR	196188000	T.53
AP MCZ1.5 1674	838903000	T.45
AP RF 122 LI OR	102064000	T.56
AP RF 122 RE OR	102065000	T.55
AP RF 80 LI 2025	815621000	T.52
AP RF 80 RE 2025	815620000	T.52
B		
B2CF 3.50/04/180 SN OR BX	127727000	J.12
B2CF 3.50/04/180F SN OR BX	127765000	J.13
B2CF 3.50/04/180LR SN OR BX	127804000	J.13
B2CF 3.50/06/180 SN OR BX	127728000	J.12
B2CF 3.50/06/180F SN OR BX	127767000	J.13
B2CF 3.50/06/180LR SN OR BX	127805000	J.13
B2CF 3.50/08/180 SN OR BX	127729000	J.12
B2CF 3.50/08/180F SN OR BX	127768000	J.13
B2CF 3.50/08/180LR SN OR BX	127806000	J.13
B2CF 3.50/10/180 SN OR BX	127731000	J.12
B2CF 3.50/10/180F SN OR BX	127769000	J.13
B2CF 3.50/10/180LR SN OR BX	127807000	J.13
B2CF 3.50/12/180 SN OR BX	127732000	J.12
B2CF 3.50/12/180F SN OR BX	127772000	J.13
B2CF 3.50/12/180LR SN OR BX	127808000	J.13
B2CF 3.50/14/180 SN OR BX	127733000	J.12
B2CF 3.50/14/180F SN OR BX	127773000	J.13
B2CF 3.50/14/180LR SN OR BX	127809000	J.13
B2CF 3.50/16/180 SN OR BX	127734000	J.12
B2CF 3.50/16/180F SN OR BX	127774000	J.13
B2CF 3.50/16/180LR SN OR BX	127810000	J.13
B2CF 3.50/18/180 SN OR BX	127735000	J.12
B2CF 3.50/18/180F SN OR BX	127775000	J.13
B2CF 3.50/18/180LR SN OR BX	127811000	J.13
B2CF 3.50/20/180 SN OR BX	127736000	J.12
B2CF 3.50/20/180F SN OR BX	127776000	J.13
B2CF 3.50/20/180LR SN OR BX	127812000	J.13
B2CF 3.50/22/180 SN OR BX	127737000	J.12
B2CF 3.50/22/180F SN OR BX	127777000	J.13
B2CF 3.50/22/180LR SN OR BX	127813000	J.13
B2CF 3.50/24/180 SN OR BX	127738000	J.12
B2CF 3.50/24/180F SN OR BX	127778000	J.13
B2CF 3.50/24/180LR SN OR BX	127814000	J.13
B2L 3.50 AH06 BK BX	178156000	N.4
B2L 3.50 AH06 BK BX	178156000	N.4
B2L 3.50 AH08 BK BX	178157000	N.4
B2L 3.50 AH08 BK BX	178157000	N.4
B2L 3.50 AH10 BK BX	178158000	J.18
B2L 3.50 AH10 BK BX	178158000	N.4
B2L 3.50 AH12 BK BX	178159000	J.18
B2L 3.50 AH12 BK BX	178159000	N.4
B2L 3.50 AH14 BK BX	178160000	J.18
B2L 3.50 AH14 BK BX	178160000	N.4
B2L 3.50 AH16 BK BX	178161000	J.18
B2L 3.50 AH16 BK BX	178161000	N.4
B2L 3.50 AH18 BK BX	178162000	J.18
B2L 3.50 AH18 BK BX	178162000	N.4
B2L 3.50 AH20 BK BX	178163000	J.18
B2L 3.50 AH20 BK BX	178163000	N.4
B2L 3.50 AH22 BK BX	178164000	J.18
B2L 3.50 AH22 BK BX	178164000	N.4
B2L 3.50 AH24 BK BX	178165000	J.18
B2L 3.50 AH24 BK BX	178165000	N.4
B2L 3.50 AH26 BK BX	178166000	J.18
B2L 3.50 AH26 BK BX	178166000	N.4
B2L 3.50 AH28 BK BX	178167000	J.18
B2L 3.50 AH30 BK BX	178168000	J.18
B2L 3.50 AH32 BK BX	178169000	J.18
B2L 3.50 AH34 BK BX	178170000	J.18
B2L 3.50 AH36 BK BX	178171000	J.18
B2L 3.50/06/180FV3 SN BK BX	194467000	J.19
B2L 3.50/06/180LHV3 SN BK BX	194475000	J.19
B2L 3.50/06/180QV3 SN BK BX	194459000	J.18

Type	Order No.	Page
B2L 3.50/08/180FQV4 SN BK BX	194468000	J.19
B2L 3.50/08/180LHV4 SN BK BX	194476000	J.19
B2L 3.50/08/180QV4 SN BK BX	194469000	J.19
B2L 3.50/10/180FQV5 SN BK BX	194469000	J.18
B2L 3.50/10/180LHV5 SN BK BX	194477000	J.19
B2L 3.50/10/180QV5 SN BK BX	194461000	J.18
B2L 3.50/12/180FQV6 SN BK BX	194470000	J.19
B2L 3.50/12/180LHV6 SN BK BX	194478000	J.19
B2L 3.50/12/180QV6 SN BK BX	194462000	J.18
B2L 3.50/14/180FQV7 SN BK BX	194471000	J.19
B2L 3.50/14/180LHV7 SN BK BX	194479000	J.19
B2L 3.50/14/180QV7 SN BK BX	194463000	J.18
B2L 3.50/16/180FQV8 SN BK BX	194472000	J.19
B2L 3.50/16/180LHV8 SN BK BX	194480000	J.19
B2L 3.50/16/180QV8 SN BK BX	194464000	J.18
B2L 3.50/18/180FQV9 SN BK BX	194473000	J.19
B2L 3.50/18/180LHV9 SN BK BX	194481000	J.19
B2L 3.50/18/180QV9 SN BK BX	194465000	J.18
B2L/S2L 3.50 KO BK BX	184974000	J.6
B2L/S2L 3.50 KO BK BX	184974000	J.8
B2L/S2L 3.50 KO BK BX	184974000	J.10
B2L/S2L 3.50 KO BK BX	184974000	J.12
B2L/S2L 3.50 KO BK BX	184974000	J.14
B2L/S2L 3.50 KO BK BX	184974000	J.16
B2L/S2L 3.50 KO BK BX	184974000	J.18
B2L/S2L 3.50 KO BK BX	184974000	N.10
B2L/S2L 3.50 KO BK BX	184973000	J.6
B2L/S2L 3.50 KO BK BX	184973000	J.8
B2L/S2L 3.50 KO BK BX	184973000	J.10
B2L/S2L 3.50 KO BK BX	184973000	J.12
B2L/S2L 3.50 KO BK BX	184973000	J.14
B2L/S2L 3.50 KO BK BX	184973000	J.16
B2L/S2L 3.50 KO BK BX	184973000	J.18
B2L/S2L 3.50 KO BK BX	184973000	N.10
B2L/S2L 3.50 KO BK BX	130758000	N.5
B2L/S2L 3.50 KO BK BX	130757000	N.5
B2CF 3.81/02/180 SN OR BX	196909000	K.54
B2CF 3.81/02/180F SN OR BX	197030000	K.55
B2CF 3.81/02/180LR SN OR BX	244204000	K.55
B2CF 3.81/03/180 SN OR BX	196910000	K.54
B2CF 3.81/03/180F SN OR BX	197033000	K.55
B2CF 3.81/03/180LR SN OR BX	244261000	K.55
B2CF 3.81/04/180 SN OR BX	196911000	K.54
B2CF 3.81/04/180F SN OR BX	197037000	K.55
B2CF 3.81/04/180LR SN OR BX	244262000	K.55
B2CF 3.81/05/180 SN OR BX	196912000	K.54
B2CF 3.81/05/180F SN OR BX	197038000	K.55
B2CF 3.81/05/180LR SN OR BX	244263000	K.55
B2CF 3.81/05/180FZE SN OR BX	123597000	K.57
B2CF 3.81/05/180LR SN OR BX	244263000	K.57
B2CF 3.81/05/180LRZE SN OR BX	244296000	K.57
B2CF 3.81/05/180ZE SN OR BX	123579000	K.56
B2CF 3.81/06/180 SN OR BX	196913000	K.54
B2CF 3.81/06/180F SN OR BX	197040000	K.55
B2CF 3.81/06/180LR SN OR BX	244264000	K.55
B2CF 3.81/06/180LRZE SN OR BX	244301000	K.57
B2CF 3.81/06/180ZE SN OR BX	123580000	K.56
B2CF 3.81/07/180 SN OR BX	196914000	K.54
B2CF 3.81/07/180F SN OR BX	197044000	K.55
B2CF 3.81/07/180LR SN OR BX	244265000	K.55
B2CF 3.81/07/180LRZE SN OR BX	244306000	K.57
B2CF 3.81/07/180ZE SN OR BX	123581000	K.56
B2CF 3.81/08/180 SN OR BX	196915000	K.54
B2CF 3.81/08/180F SN OR BX	197055000	K.55
B2CF 3.81/08/180LR SN OR BX	244266000	K.55
B2CF 3.81/08/180LRZE SN OR BX	244302000	K.57
B2CF 3.81/08/180ZE SN OR BX	123582000	K.56
B2CF 3.81/09/180 SN OR BX	196916000	K.54
B2CF 3.81/09/180F SN OR BX	197057000	K.55
B2CF 3.81/09/180LR SN OR BX	244267000	K.55
B2CF 3.81/09/180LRZE SN OR BX	244303000	K.57
B2CF 3.81/09/180ZE SN OR BX	123583000	K.56
B2CF 3.81/10/180 SN OR BX	196917000	K.54
B2CF 3.81/10/180F SN OR BX	197058000	K.55
B2CF 3.81/10/180LR SN OR BX	244268000	K.55
B2CF 3.81/10/180LRZE SN OR BX	244304000	K.57
B2CF 3.81/10/180ZE SN OR BX	123584000	K.56
B2CF 3.81/11/180 SN OR BX	196918000	K.54
B2CF 3.81/11/180F SN OR BX	197062000	K.55
B2CF 3.81/11/180LR SN OR BX	244269000	K.55
B2CF 3.81/11/180LRZE SN OR BX	244305000	K.57
B2CF 3.81/11/180ZE SN OR BX	123587000	K.56
B2CF 3.81/12/180 SN OR BX	196919000	K.54
B2CF 3.81/12/180F SN OR BX	197065000	K.55
B2CF 3.81/12/180LR SN OR BX	244270000	K.55
B2CF 3.81/12/180LRZE SN OR BX	244306000	K.57
B2CF 3.81/12/180ZE SN OR BX	123602000	K.57
B2CF 3.81/10/180LR SN OR BX	244268000	K.55
B2CF 3.81/10/180LRZE SN OR BX	244291000	K.57
B2CF 3.81/10/180ZE SN OR BX	123584000	K.56
B2CF 3.81/11/180 SN OR BX	196918000	K.54
B2CF 3.81/11/180F SN OR BX	197062000	K.55
B2CF 3.81/11/180LR SN OR BX	244269000	K.55
B2CF 3.81/11/180LRZE SN OR BX	244305000	K.57
B2CF 3.81/11/180ZE SN OR BX	123587000	K.56
B2CF 3.81/12/180 SN OR BX	196919000	K.54
B2CF 3.81/12/180F SN OR BX	197065000	K.55
B2CF 3.81/12/180LR SN OR BX	244270000	K.55
B2CF 3.81/12/180LRZE SN OR BX	244306000	K.57
B2CF 3.81/12/180ZE SN OR BX	123604000	K.57
B2CF 3.81/12/180LR SN OR BX	244270000	K.55
B2CF 3.81/12/180LRZE SN OR BX	244305000	K.57
B2CF 3.81/12/180ZE SN OR BX	123588000	K.56
BCL-SMT 3.81/02/180 1.5SN BK BX	197649000	K.60
BCL-SMT 3.81/02/180LF 1.5SN BK BX	102926000	K.61
BCL-SMT 3.81/02/90 1.5SN BK BX	197475000	K.58
BCL-SMT 3.81/03/180 1.5SN BK BX	197650000	K.59
BCL-SMT 3.81/03/90 1.5SN BK BX	197477000	K.58
BCL-SMT 3.81/04/180LF 1.5SN BK BX	102929000	K.61
BCL-SMT 3.81/04/90 1.5SN BK BX	197478000	K.58
BCL-SMT 3.81/04/90F 1.5SN BK BX	197510000	K.59
BCL-SMT 3.81/05/180 1.5SN BK BX	197653000	K.60
BCL-SMT 3.81/05/180F 1.5SN BK BX	102929000	K.61
BCL-SMT 3.81/05/90 1.5SN BK BX	197480000	K.58
BCL-SMT 3.81/05/90F 1.5SN BK BX	197530000	K.59
BCL-SMT 3.81/06/180 1.5SN BK BX	197656000	K.60
BCL-SMT 3.81/06/180LF 1.5SN BK BX	102931000	K.61
BCL-SMT 3.81/06/90 1.5SN BK BX	197482000	K.58
BCL-SMT 3.81/06/90F 1.5SN BK BX	197574000	K.59
BCL-SMT 3.81/06/90LF 1.5SN BK BX	102876000	K.59
BCL-SMT 3.81/07/180 1.5SN BK BX	197657000	K.60
BCL-SMT 3.81/07/180LF 1.5SN BK BX	102932000	K.61
BCL-SMT 3.81/07/90 1.5SN BK BX	197484000	K.58
BCL-SMT 3.81/07/90F 1.5SN BK BX	197575000	K.59
BCL-SMT 3.81/07/90LF 1.5SN BK BX	102877000	K.59
BCL-SMT 3.81/08/180 1.5SN BK BX	197658000	K.60
BCL-SMT 3.81/08/180LF 1.5SN BK BX	102933000	K.61
BCL-SMT 3.81/08/90 1.5SN BK BX	197485000	K.58
BCL-SMT 3.81/08/90F 1.5SN BK BX	197576000	K.59
BCL-SMT 3.81/08/90LF 1.5SN BK BX	102879000	K.60
BCL-SMT 3.81/09/180 1.5SN BK BX	197659000	K.60
BCL-SMT 3.81/09/180LF 1.5SN BK BX	102934000	K.61
BCL-SMT 3.81/09/90 1.5SN BK BX	197488000	K.58
BCL-SMT 3.81/09/90F 1.5SN BK BX	197578000	K.59
BCL-SMT 3.81/09/90LF 1.5SN BK BX	102881	

Table with columns: Type, Order No., Page. Contains product codes like BVDF 7.62HP/04/180SF SN BK BX and their corresponding order numbers and page references.

Table with columns: Type, Order No., Page. Contains product codes like BVF 7.62HP/05/180MF2 BCF/06R SN BK BX and their corresponding order numbers and page references.

Table with columns: Type, Order No., Page. Contains product codes like BVFL 7.62HP/05/180MF3 BCF/04R SN BK BX and their corresponding order numbers and page references.

Table with columns: Type, Order No., Page. Contains product codes like BVZ 7.62HP/04/180SFC SN BK BX and their corresponding order numbers and page references.

C

Table with columns: Type, Order No., Page. Contains product codes like CB1.6E14-12 AU.75 I3.5 and their corresponding order numbers and page references.

Type	Order No.	Page
CH20M12 B BUS BK/ BK 2010	1366350000	T.22
CH20M12 B BUS BK/ OR 2010	1176980000	T.22
CH20M12 B BUS LGV/ BK 2010	1310520000	T.22
CH20M12 B FE BK/ OR 2018	1176990000	T.22
CH20M12 B LGV/ BK 2018	1294310000	T.22
CH20M12 C BK 1819	1104240000	T.22
CH20M12 C TP 8089	1104250000	T.22
CH20M12 F AGY 3747	2554760000	T.22
CH20M12 F BK 2010	1104190000	T.22
CH20M12 F LGY 2018	1294350000	T.22
CH20M12 S PPP AGY 3747	2554690000	T.23
CH20M12 S PPP BK 2010	1174280000	T.23
CH20M12 S PPP BL 2013	1294340000	T.23
CH20M12 S PPP LGY 2018	1294330000	T.23
CH20M12 S PPSC AGY 3747	2554860000	T.23
CH20M12 S PPSC BK 2010	1104230000	T.23
CH20M12 S PPSC BL 2013	1104230000	T.23
CH20M12 S PPSC LGY 2018	1312680000	T.23
CH20M17 B AGY/ BK 3747	2554640000	T.24
CH20M17 B BK/ BK 2010	1254120000	T.24
CH20M17 B BK/ OR 2010	1254130000	T.24
CH20M17 B BL/ BK 2013	1844520000	T.24
CH20M17 B BUS BK/ BK 2010	1366280000	T.24
CH20M17 B BUS BK/ OR 2010	1254180000	T.24
CH20M17 B FE BK/ BK 2010	1378000000	T.24
CH20M17 B FE BK/ OR 2010	1254190000	T.24
CH20M17 C BK 1819	1254150000	T.24
CH20M17 C TP 8089	1254160000	T.24
CH20M17 F AGY 3747	2554750000	T.24
CH20M17 F BK 2010	1254140000	T.24
CH20M17 F LGY 2018	1529530000	T.24
CH20M17 FC BK 2010	2655800000	T.24
CH20M17 FC TP BK 1819	2697310000	T.24
CH20M17 FCTYL 2083	2655070000	T.24
CH20M17 S PPP AGY 3747	2554700000	T.25
CH20M17 S PPP BK 2010	1254170000	T.25
CH20M17 S PPP LGY 2018	1529520000	T.25
CH20M17 S PPP TYL 2083	1395730000	T.25
CH20M22 B AGY/ BK 3747	1545130000	T.26
CH20M22 B BK/ BK 2010	2418630000	T.26
CH20M22 B BK/ OR 2010	1104450000	T.26
CH20M22 B BK/ RD 2010	2555100000	T.26
CH20M22 B BUS BK/ BK 2010	1243030000	T.26
CH20M22 B BUS BK/ OR 2010	1177000000	T.26
CH20M22 B BUS FE BK/ BK 2010	1394030000	T.26
CH20M22 B BUS FE BK/ OR 2010	2004700000	T.26
CH20M22 B FE AGY/ BK 3747	1472800000	T.26
CH20M22 B FE BK/ OR 2010	1177010000	T.26
CH20M22 B GGY/ BK 2019	1073350000	T.26
CH20M22 B LGV/ BK 2018	1164670000	T.26
CH20M22 B RD/ BK 2014	1206870000	T.26
CH20M22 C BK 1819	2418670000	T.26
CH20M22 C TP 8089	1073420000	T.26
CH20M22 F AGY 3747	2554730000	T.26
CH20M22 F BK 2010	2418640000	T.26
CH20M22 F GGY 2019	1073360000	T.26
CH20M22 F LGY 2018	1164680000	T.26
CH20M22 FRD 2014	1209380000	T.26
CH20M22 F TYL 2083	1350230000	T.26
CH20M22 FC AGY 3747	1472810000	T.26
CH20M22 FC BK 2010	1209350000	T.26
CH20M22 FC GGY 2019	1209360000	T.26
CH20M22 FC LGY 2018	1209370000	T.26
CH20M22 FC RD 2014	1206880000	T.26
CH20M22 FC TP BK 1819	2639980000	T.26
CH20M22 FCTYL 2083	1304240000	T.26
CH20M22 S PPP AGY 3747	2554840000	T.27
CH20M22 S PPP BK 2010	1138790000	T.27
CH20M22 S PPP BL 2013	1296430000	T.27
CH20M22 S PPP GGY 2019	1411500000	T.27
CH20M22 S PPP LGY 2018	1296440000	T.27
CH20M22 S PPSC AGY 3747	2554710000	T.27
CH20M22 S PPSC BK 2010	2418650000	T.27
CH20M22 S PPSC BL 2013	2418660000	T.27
CH20M22 S PPSC GGY 2019	1073370000	T.27
CH20M22 S PPSC LGY 2018	1164690000	T.27
CH20M22 S PPSC RD 2014	1208990000	T.27
CH20M22 S PPSC AGY 3747	2554850000	T.27
CH20M22 S PPSC BK 2010	1080630000	T.27
CH20M22 S PPSC BL 2013	1070620000	T.27
CH20M22 S PPSC GGY 2019	1451120000	T.27
CH20M22 S PPSC LGY 2018	1432860000	T.27
CH20M22 S RPP AGY 3747	1472820000	T.27
CH20M22 S RPP BK 2010	1276890000	T.27
CH20M22 S RPP LGY 2018	1470700000	T.28
CH20M45 B BK/ BK 2010	1104400000	T.28
CH20M45 B BK/ OR 2010	1104410000	T.28
CH20M45 B BK/ RD 2010	2555110000	T.28
CH20M45 B BUS BK/ BK 2010	1478000000	T.28
CH20M45 B BUS BK/ OR 2010	1177020000	T.28
CH20M45 B BUS GGY/ BK 2019	1413770000	T.28
CH20M45 B FE BK/ OR 2010	1177030000	T.28
CH20M45 B FE BL/ OR 2013	2579680000	T.28
CH20M45 B GGY/ BK 2019	1164710000	T.28
CH20M45 B LGV/ BK 2018	1164750000	T.28

Type	Order No.	Page
CH20M45 B RD/ BK 2014	1206910000	T.28
CH20M45 B SIM BK/ BK 2010	2738670000	T.28
CH20M45 C BK 1819	1104430000	T.28
CH20M45 C TP 8089	1104440000	T.28
CH20M45 F BK 2010	1104420000	T.28
CH20M45 F BL 2013	2579660000	T.28
CH20M45 F GGY 2019	1164720000	T.28
CH20M45 F LGY 2018	1164770000	T.28
CH20M45 F RD 2014	1209390000	T.28
CH20M45 F TYL 2083	1337640000	T.28
CH20M45 FC BK 2010	1164800000	T.28
CH20M45 FC GGY 2019	1164730000	T.28
CH20M45 FC LGY 2018	1164780000	T.28
CH20M45 FC RD 2014	1206920000	T.28
CH20M45 FC TP BK 1819	2673070000	T.28
CH20M45 S 2PSC/2PSC BK 2010	1111720000	T.29
CH20M45 S 2PSC/2PSC BL 2013	1476910000	T.29
CH20M45 S 2PSC/2PSC GGY 2019	1164740000	T.29
CH20M45 S 2PSC/2PSC LGY 2018	1164790000	T.29
CH20M45 S 2PSC/2PSC RD 2014	1206930000	T.29
CH20M45 S 2PSC/2PSC TYL 2083	1327990000	T.29
CH20M45 S 2PSC/3SC BK 2010	1137740000	T.29
CH20M45 S 2PSC/3SC LGY 2018	2585480000	T.29
CH20M45 S 2PSC/3SC BK 2010	1500050000	T.29
CH20M45 S 3P/3P BK 2010	1137730000	T.29
CH20M45 S 3P/3P BL 2013	2624760000	T.29
CH20M45 S 3P/3P LGY 2018	1444330000	T.29
CH20M45 S 3P/3P TYL 2083	1482830000	T.29
CH20M45 S 3SC/2PSC BK 2010	1137750000	T.29
CH20M45 S 3SC/2PSC LGY 2018	2585490000	T.29
CH20M45 S P2SC/P2SC BK 2010	1166180000	T.29
CH20M45 S P2SC/P2SC BL 2013	2579670000	T.29
CH20M45 S RPSC/2PSC BK 2010	1500040000	T.29
CH20M6 BC 4P-4P AGY 1 1293807	2711210000	T.21
CH20M6 BC 4P-4P BK 1 1261494	2771160000	T.21
CH20M6 BC 4P-4P BUS AGY 1 1293807	2771220000	T.21
CH20M6 BC 4P-4P BUS BK 1 1261494	2771130000	T.21
CH20M6 BC 4P-4P BUS GY 1 1261516	2771140000	T.21
CH20M6 BC 4P-4P BUS RD 1 1261515	2771150000	T.21
CH20M6 BC 4P-4P BUS TGY 1 1293806	2771170000	T.21
CH20M6 BC 4P-4P GY 1 1261516	2771180000	T.21
CH20M6 BC 4P-4P RD 1 1261515	2771190000	T.21
CH20M6 BC 4P-4P TGY 1 1293806	2771200000	T.21
CH20M6 BP 4P-4P AGY LF 1 1293807	2771450000	T.20
CH20M6 BP 4P-4P BK LF 1 1261494	2771470000	T.20
CH20M6 BP 4P-4P BUS AGY LF 1 1293807	2771420000	T.20
CH20M6 BP 4P-4P BUS BK LF 1 1261494	2771430000	T.20
CH20M6 BP 4P-4P BUS GY LF 1 1261516	2771440000	T.20
CH20M6 BP 4P-4P BUS RD LF 1 1261515	2771410000	T.20
CH20M6 BP 4P-4P BUS TGY LF 1 1293806	2771400000	T.20
CH20M6 BP 4P-4P FE BK 1 1261494	2435460000	T.20
CH20M6 BP 4P-4P GY LF 1 1261516	2771460000	T.20
CH20M6 BP 4P-4P RD LF 1 1261515	2771490000	T.20
CH20M6 BP 4P-4P TGY LF 1 1293806	2771480000	T.20
CH20M6 C BK 1819	2418620000	T.20
CH20M6 C TP 8089	1073410000	T.20
CH20M67 B 2FE BK/ OR	1073420000	T.30
CH20M67 B BK/ BK 2010	1235270000	T.30
CH20M67 B BK/ OR 2010	1235250000	T.30
CH20M67 B BUS BK/ BK 2010	1498200000	T.30
CH20M67 B BUS BK/ OR 2010	1247240000	T.30
CH20M67 B BUS GGY/ BK 2019	1413780000	T.30
CH20M67 B FE BK/ OR 2010	1247250000	T.30
CH20M67 B TYL/ BK 2083	2653360000	T.30
CH20M67 FC BK 2010	1235310000	T.30
CH20M67 FC GGY 2019	1413810000	T.30
CH20M67 FC TYL 2083	2653370000	T.30
CH20M67 S 2PSC/2PSC/2PSC BK 2010	1235320000	T.31
CH20M67 S 2PSC/2PSC/2PSC GGY 2019	1413820000	T.31
CH20M67 S 3P/3P/3P BK 2010	1420370000	T.31
CH20M67 S 3P/3P/3P GGY 2019	1455770000	T.31
CH20M67 S 3P/3P/3P TYL 2083	2653380000	T.31
CS1.6E14-12 AU.75 I3,5	1428600000	M.16
CS1.6E14-12 AU.75 I4,2	1582290000	M.16
CS1.6E14-12 SN I3,5	1429600000	M.16
CS1.6E14-12 SN I4,2	1582310000	M.16
CS1.6E18-16 AU.75 I2,5	1426600000	M.16
CS1.6E18-16 AU.75 I3,5	1582250000	M.16
CS1.6E18-16 SN I2,5	1427600000	M.16
CS1.6E18-16 SN I3,5	1582270000	M.16
CS1.6E22-20 AU.75 I1,8	1422600000	M.16
CS1.6E22-20 AU.75 I2,5	1424600000	M.16
CS1.6E22-20 SN I1,8	1423600000	M.16
CS1.6E22-20 SN I2,5	1425600000	M.16
CS1.6E26-24 AU.75 I1,4	1426000000	M.16
CS1.6E26-24 SN I1,4	1421600000	M.16
CS1.6R14-12 AU.75 I3,5	1426500000	M.16
CS1.6R14-12 AU.75 I4,2	1582300000	M.16
CS1.6R14-12 SN I3,5	1429500000	M.16
CS1.6R14-12 SN I4,2	1582320000	M.16
CS1.6R18-16 AU.75 I2,5	1426500000	M.16
CS1.6R18-16 AU.75 I3,5	1582260000	M.16
CS1.6R18-16 SN I2,5	1427500000	M.16
CS1.6R18-16 SN I3,5	1582280000	M.16
CS1.6R22-20 AU.75 I1,8	1425600000	M.16
CS1.6R22-20 AU.75 I2,5	1424500000	M.16
CS1.6R22-20 SN I1,8	1425500000	M.16
CS1.6R22-20 SN I2,5	1420500000	M.16

Type	Order No.	Page
CS1.6R26-24 SN I1,4	1421500000	M.16
CSL1.6E14-12 AU.75 I3,5	1426700000	M.16
CSL1.6E14-12 AU.75 I4,2	1582370000	M.16
CSL1.6E14-12 SN I3,5	1429700000	M.16
CSL1.6E14-12 SN I4,2	1582390000	M.16
CSL1.6E18-16 AU.75 I2,5	1426700000	M.16
CSL1.6E18-16 AU.75 I3,5	1582330000	M.16
CSL1.6E18-16 SN I2,5	1427700000	M.16
CSL1.6E18-16 SN I3,5	1582350000	M.16
CSL1.6E22-20 AU.75 I1,8	1422700000	M.16
CSL1.6E22-20 AU.75 I2,5	1424700000	M.16
CSL1.6E22-20 SN I1,8	1423700000	M.16
CSL1.6E22-20 SN I2,5	1425700000	M.16
CSL1.6E26-24 AU.75 I1,4	1420700000	M.16
CSL1.6E26-24 SN I1,4	1421700000	M.16
CSL1.6R14-12 AU.75 I3,5	1565760000	M.16
CSL1.6R14-12 AU.75 I4,2	1582380000	M.16
CSL1.6R14-12 SN I3,5	1565780000	M.16
CSL1.6R14-12 SN I4,2	1582400000	M.16
CSL1.6R18-16 AU.75 I2,5	1565790000	M.16
CSL1.6R18-16 AU.75 I3,5	1582340000	M.16
CSL1.6R18-16 SN I2,5	1565810000	M.16
CSL1.6R18-16 SN I3,5	1582360000	M.16
CSL1.6R22-20 AU.75 I1,8	1565850000	M.16
CSL1.6R22-20 AU.75 I2,5	1565820000	M.16
CSL1.6R22-20 SN I1,8	1565870000	M.16
CSL1.6R22-20 SN I2,5	1565840000	M.16
CSL1.6R26-24 AU.75 I1,4	1565880000	M.16
CSL1.6R26-24 SN I1,4	1565900000	M.16

D

D-SUB F6.3 T09H6 3.2B4 TY BK	2706970000	F.8
D-SUB F6.3 T09H9 3.2B4 TY BK	2701710000	F.6
D-SUB F6.3 T09V6 3.2B4 TY BK	2707200000	F.12
D-SUB F6.3 T09V9 3.2B4 TY BK	2707150000	F.8
D-SUB F6.3 T15H6 3.2B4 TY BK	2706980000	F.10
D-SUB F6.3 T15H9 3.2B4 TY BK	2701730000	F.8
D-SUB F6.3 T15V6 3.2B4 TY BK	2707210000	F.12
D-SUB F6.3 T15V9 3.2B4 TY BK	2707160000	F.10
D-SUB F6.3 T25H6 3.2B4 TY BK	2707100000	F.8
D-SUB F6.3 T25H9 3.2B4 TY BK	2724020000	F.6
D-SUB F6.3 T25V6 3.2B4 TY BK	2707220000	F.12
D-SUB F6.3 T25V9 3.2B4 TY BK	2701740000	F.10
D-SUB HD6.3 T15H6 3.2B4 TY BK	2706950000	F.14
D-SUB HD6.3 T15H9 3.2B4 TY BK	2701690000	F.15
D-SUB M6.3 T09H6 3.2B4 TY BK	2701720000	F.9
D-SUB M6.3 T09H9 3.2B4 TY BK	2724030000	F.7
D-SUB M6.3 T09V6 3.2B4 TY BK	2707230000	F.13
D-SUB M6.3 T09V9 3.2B4 TY BK	2707170000	F.11
D-SUB M6.3 T15H6 3.2B4 TY BK		

Type	Order No.	Page
FFH6 S1/40V F1 B RL	2747300000	H.14
FFH6 S1/50V F1 B RL	2747310000	H.14
FFH6 S1/68V F1 B RL	2747320000	H.14
FFH6 S1/80V F1 B RL	2747330000	H.14
FFH9 S1/12V F1 B RL	2747340000	H.16
FFH9 S1/16V F1 B RL	2747350000	H.16
FFH9 S1/20V F1 B RL	2747360000	H.16
FFH9 S1/26V F1 B RL	2747370000	H.16
FFH9 S1/32V F1 B RL	2747380000	H.16
FFH9 S1/40V F1 B RL	2747390000	H.16
FFH9 S1/50V F1 B RL	2747400000	H.16
FFH9 S1/68V F1 B RL	2747410000	H.16
FFH9 S1/80V F1 B RL	2747420000	H.16
FFP D1/12H S1 B TY	2747520000	H.18
FFP D1/16H S1 B TY	2747530000	H.18
FFP D1/20H S1 B TY	2747540000	H.18
FFP D1/26H S1 B TY	2747550000	H.18
FFP D1/32H S1 B RL	2747560000	H.18
FFP D1/40H S1 B TY	2747570000	H.18
FFP D1/50H S1 B TY	2747580000	H.18
FFP D1/68H S1 B TY	2747590000	H.18
FFP D1/80H S1 B TY	2747600000	H.18
FHM S1/12H F1 B RL	2747160000	H.6
FHM S1/16H F1 B RL	2747170000	H.6
FHM S1/20H F1 B RL	2747180000	H.6
FHM S1/26H F1 B RL	2747190000	H.6
FHM S1/32H F1 B RL	2747200000	H.6
FHM S1/40H F1 B RL	2747210000	H.6
FHM S1/50H F1 B RL	2747220000	H.6
FHM S1/68H F1 B RL	2747230000	H.6
FHM S1/80H F1 B RL	2747240000	H.6
FMH1 S1/12V F1 B RL	2746980000	H.8
FMH1 S1/16V F1 B RL	2746990000	H.8
FMH1 S1/20V F1 B RL	2747000000	H.8
FMH1 S1/26V F1 B RL	2747010000	H.8
FMH1 S1/32V F1 B RL	2747020000	H.8
FMH1 S1/40V F1 B RL	2747030000	H.8
FMH1 S1/50V F1 B RL	2747040000	H.8
FMH1 S1/68V F1 B RL	2747050000	H.8
FMH1 S1/80V F1 B RL	2747060000	H.8
FMH3 S1/12V F1 B RL	2747070000	H.10
FMH3 S1/16V F1 B RL	2747080000	H.10
FMH3 S1/20V F1 B RL	2747090000	H.10
FMH3 S1/26V F1 B RL	2747100000	H.10
FMH3 S1/32V F1 B RL	2747110000	H.10
FMH3 S1/40V F1 B RL	2747120000	H.10
FMH3 S1/50V F1 B RL	2747130000	H.10
FMH3 S1/68V F1 B RL	2747140000	H.10
FMH3 S1/80V F1 B RL	2747150000	H.10

G

GH MCZ1.5 1674	2224220000	T.45
GH MCZUE1.5/UE 1674	2312290000	T.45
GHDE MSA ZB FR 12 1676	2279280000	T.44
GHDE MSA ZF 1676	2279300000	T.44

H

H0.5/14S W	9004590000	L.46
H0.5/14S W	9004590000	L.46
H0.5/14S W	9004590000	L.84
H0.5/14S W	9004590000	L.88
H0.5/14S W	9004590000	L.94
H0.5/14S W	9004590000	L.100
H0.5/14S W	9004590000	L.112
H0.5/14S W	9004590000	L.114
H1.0/14S R	9018560000	L.46
H1.0/14S R	9018560000	L.48
H1.0/14S R	9018560000	L.94
H1.0/14S R	9018560000	L.100
H1.0/14S R	9018560000	L.108
H1.0/14S R	9018560000	L.112
H1.0/14S R	9018560000	L.114
H1.5/14DS SW	9025240000	L.46
H1.5/14DS SW	9025240000	L.48
H1.5/14DS SW	9025240000	L.84
H1.5/14DS SW	9025240000	L.88
H1.5/14DS SW	9025240000	L.94
H1.5/14DS SW	9025240000	L.100
H1.5/14DS SW	9025240000	L.108
H1.5/14DS SW	9025240000	L.112
H1.5/14DS SW	9025240000	L.114
H2.5/14DS BL	1333100000	L.46
H2.5/14DS BL	1333100000	L.48
H2.5/14DS BL	1333100000	L.84
H2.5/14DS BL	1333100000	L.88
H2.5/14DS BL	1333100000	L.94
H2.5/14DS BL	1333100000	L.100
H2.5/14DS BL	1333100000	L.108
H2.5/14DS BL	1333100000	L.112
H2.5/14DS BL	1333100000	L.114
HTF 28	9013090000	N.14
HTF 63	9013400000	N.14
HTF DFF	9014140000	N.16
HTF DFF	9014140000	N.16
HTF RSV 12	9013550000	N.14
HTF RSV 16	9013560000	N.14

Type	Order No.	Page
HTF RSV 16	9013560000	N.14
IE-AD-SPD-P-SPM-P-90	2814400000	C.9
IE-AD-SPD-P-SPM-P-90	2814400000	C.18
IE-BHD-SPE-PP-CN-M10X0.75	2739640000	C.9
IE-BHD-SPE-PP-CN-M10X0.75	2739640000	C.16
IE-BHD-SPE-M8-OT-BP	2726030000	C.9
IE-BHD-SPE-M8-OT-BP	2726030000	C.16
IE-BHD-SPE-M8-OT-PP	2726020000	C.9
IE-BHD-SPE-M8-OT-PP	2726020000	C.16
IE-PCB-SPD-P-180V-THR	2795170000	C.9
IE-PCB-SPD-P-180V-THR	2795170000	C.15
IE-PCB-SPD-P-90V-THR	2726010000	C.9
IE-PCB-SPD-P-90V-THR	2726010000	C.14
IE-PCB-SPD-P-90V-THR-YG/YG	2795120000	C.9
IE-PCB-SPD-P-90V-THR-YG/YG	2795120000	C.14
IE-PCB-SPM-P-180-SMD	2795110000	C.9
IE-PCB-SPM-P-180-SMD	2795110000	C.17
IE-PCB-SPM-P-180-THR	2735920000	C.9
IE-PCB-SPM-P-180-THR	2735920000	C.17
IE-PCB-SPM-P-90-THR	2795100000	C.9
IE-PCB-SPM-P-90-THR	2795100000	C.17
IE-PS-SPD-S-FH-180	2726040000	C.9
IE-PS-SPD-S-FH-180	2726040000	C.13
IE-SIDS2VE0010T01T01-E	2725850010	C.8
IE-SIDS2VE0010T01T01-E	2725850010	C.10
IE-SIDS2VE0020T01T01-E	2725850020	C.8
IE-SIDS2VE0020T01T01-E	2725850020	C.10
IE-SIDS2VE0020T01TM1-E	2726050020	C.8
IE-SIDS2VE0020T01TM1-E	2726050020	C.11
IE-SIDS2VE0020T01TM2-E	2726060020	C.8
IE-SIDS2VE0020T01TM2-E	2726060020	C.11
IE-SIDS2VE0020T02TM2-E	2726070020	C.8
IE-SIDS2VE0020T02TM2-E	2726070020	C.12
IE-SIDS2VE0030T01T01-E	2725850030	C.8
IE-SIDS2VE0030T01T01-E	2725850030	C.10
IE-SIDS2VE0050T01T01-E	2725850050	C.8
IE-SIDS2VE0050T01T01-E	2725850050	C.10
IE-SIDS2VE0050T01TM1-E	2726050050	C.8
IE-SIDS2VE0050T01TM1-E	2726050050	C.11
IE-SIDS2VE0100T01T01-E	2725850100	C.8
IE-SIDS2VE0100T01T01-E	2725850100	C.10
IE-SIDS2VE0100T01TM1-E	2726050100	C.8
IE-SIDS2VE0100T01TM1-E	2726050100	C.11
IE-SIDS2VE0150T01T01-E	2725850150	C.8
IE-SIDS2VE0150T01T01-E	2725850150	C.10
IE-SIDS2VE0150T01TM1-E	2726050150	C.8
IE-SIDS2VE0150T01TM1-E	2726050150	C.11
IE-SIDS2VE0200T01TM1-E	2726050200	C.8
IE-SIDS2VE0200T01TM1-E	2726050200	C.11
IE-SIDS2VE0400T01T01-E	2725850400	C.8
IE-SIDS2VE0400T01T01-E	2725850400	C.10
IE-SIDS2VE0400T01TM1-E	2726050400	C.8
IE-SIDS2VE0400T01TM1-E	2726050400	C.11
K0 BU/SU10.16HP BK	1824410000	P.78
K0 BU/SU10.16HP BK	1824410000	P.80
K0 BU/SU10.16HP BK	1824410000	P.82
K0 BU/SU10.16HP BK	1824410000	P.84
K0 BU/SU10.16HP BK	1824410000	P.86
K0 BU/SU10.16HP BK	1824410000	P.88
K0 BU/SU10.16HP BK	1824410000	P.90
K0 BU/SU10.16HP BK	1824410000	P.92
K0 BU/SU10.16HP BK	1824410000	P.94
K0 BU/SU10.16HP BK	1824410000	P.96
K0 BU/SU10.16HP BK	1824410000	P.98
K0 BU/SU10.16HP BK	1824410000	P.100
K0 BU/SU10.16HP BK	1824410000	P.102
K0 BU/SU10.16HP BK	1824410000	P.104
K0 BU/SU10.16HP BK	1824410000	P.106
K0 BU/SU10.16HP BK	1824410000	P.108
K0 BU/SU10.16HP BK	1824410000	P.110
K0 BU/SU10.16HP BK	1824410000	P.112
K0 BU/SU10.16HP BK	1824410000	P.114
K0 BU/SU10.16HP BK	1824410000	P.116
K0 BU/SU10.16HP BK	1824410000	P.118
K0 BU/SU10.16HP BK	1824410000	P.120
K0 BU/SU10.16HP BK	1824410000	P.122
K0 BU/SU10.16HP BK	1824410000	P.124
K0 BU/SU10.16HP BK	1824410000	P.126
K0 BU/SU10.16HP BK	1824410000	P.128
K0 BU/SU10.16HP BK	1824410000	P.130
K0 BU/SU10.16HP BK	1824410000	P.132
K0 BU/SU10.16HP BK	1824410000	P.134
K0 BU/SU10.16HP BK	1824410000	P.136
K0 BU/SU10.16HP BK	1824410000	P.138
K0 BU/SU10.16HP BK	1824410000	P.140
K0 BU/SU10.16HP BK	1824410000	P.142
K0 BU/SU10.16HP BK	1824410000	P.144
K0 BU/SU10.16HP BK	1824410000	P.146
K0 BU/SU10.16HP BK	1824410000	P.148
K0 BU/SU10.16HP BK	1824410000	P.150
K0 BU/SU10.16HP BK	1824410000	P.152
K0 BU/SU10.16HP BK	1824410000	P.154
K0 BU/SU10.16HP BK	1824410000	P.156
K0 BU/SU10.16HP BK	1824410000	P.158
K0 BU/SU10.16HP BK	1824410000	P.160
K0 BU/SU10.16HP BK	1824410000	P.162
K0 BU/SU10.16HP BK	1824410000	P.164
K0 BU/SU10.16HP BK	1824410000	P.166
K0 BU/SU10.16HP BK	1824410000	P.168
K0 BU/SU10.16HP BK	1824410000	P.170

Type	Order No.	Page
K0 BU/SU10.16HP WT	2592600000	P.92
K0 BU/SU10.16HP WT	2592600000	P.94
K0 BU/SU10.16HP WT	2592600000	P.96
K0 BU/SU10.16HP WT	2592600000	P.98
K0 BU/SU10.16HP WT	2592600000	P.100
K0 BU/SU10.16HP WT	2592600000	P.102
K0 BU/SU10.16HP WT	2592600000	P.104
K0 BU/SU10.16HP WT	2592600000	P.106
K0 BU/SU10.16HP WT	2592600000	P.108
K0 BU/SU10.16HP WT	2592600000	P.110
K0 BU/SU10.16HP WT	2592600000	P.112
K0 BU/SU10.16HP WT	2592600000	P.114
K0 BU/SU10.16HP WT	2592600000	P.116
K0 BU/SU10.16HP WT	2592600000	P.118
K0 BU/SU10.16HP WT	2592600000	P.120
K0 BU/SU10.16HP WT	2592600000	P.122
K0 BU/SU10.16HP WT	2592600000	P.124
K0 BU/SU10.16HP WT	2592600000	P.126
K0 BU/SU10.16HP WT	2592600000	P.128
K0 BU/SU10.16HP WT	2592600000	P.130
K0 BU/SU10.16HP WT	2592600000	P.132
K0 BU/SU10.16HP WT	2592600000	P.134
K0 BU/SU10.16HP WT	2592600000	P.136
K0 BU/SU10.16HP WT	2592600000	P.138
K0 BU/SU10.16HP WT	2592600000	P.140
K0 BU/SU10.16HP WT	2592600000	P.142
K0 BU/SU10.16HP WT	2592600000	P.144
K0 BU/SU10.16HP WT	2592600000	P.146
K0 BU/SU10.16HP WT	2592600000	P.148
K0 BU/SU10.16HP WT	2592600000	P.150
K0 BU/SU10.16HP WT	2592600000	P.152
K0 BU/SU10.16HP WT	2592600000	P.154
K0 BU/SU10.16HP WT	2592600000	P.156
K0 BU/SU10.16HP WT	2592600000	P.158
K0 BU/SU10.16HP WT	2592600000	P.160
K0 BU/SU10.16HP WT	2592600000	P.162
K0 BU/SU10.16HP WT	2592600000	P.164
K0 BU/SU10.16HP WT	2592600000	P.166
K0 BU/SU10.16HP WT	2592600000	P.168
K0 BU/SU10.16HP WT	2592600000	P.170
K0 BU/SU10.16HP WT	2592600000	P.172
K0 BU/SU10.16HP WT	2592600000	P.174
K0 BU/SU10.16HP WT	2592600000	P.176
K0 BU/SU10.16HP WT	2592600000	P.178
K0 BU/SU10.16HP WT	2592600000	P.180
K0 BU/SU10.16HP WT	2592600000	P.182
K0 BU/SU10.16HP WT	2592600000	P.184
K0 BU/SU10.16HP WT	2592600000	P.186
K0 BU/SU10.16HP WT	2592600000	P.188
K0 BU/SU10.16HP WT	2592600000	P.190
K0 BU/SU10.16HP WT	2592600000	P.192
K0 BU/SU10.16HP WT	2592600000	P.194
K0 BU/SU10.16HP WT	2592600000	P.196
K0 BU/SU10.16HP WT	2592600000	P.198
K0 BU/SU10.16HP WT	2592600000	P.200
K0 BU/SU10.16HP WT	2592600000	P.202
K0 BU/SU10.16HP WT	2592600000	P.204
K0 BU/SU10.16HP WT	2592600000	P.206
K0 BU/SU10.16HP WT	2592600000	P.208
K0 BU/SU10.16HP WT	2592600000	P.210
K0 BU/SU10.16HP WT	2592600000	P.212
K0 BU/SU10.16HP WT	2592600000	P.214
K0 BU/SU10.16HP WT	2592600000	P.216
K0 BU/SU10.16HP WT	2592600000	P.218
K0 BU/SU10.16HP WT	2592600000	P.220
K0 BU/SU10.16HP WT	2592600000	P.222
K0 BU/SU10.16HP WT	2592600000	P.224
K0 BU/SU10.16HP WT	2592600000	P.226
K0 BU/SU10.16HP WT	2592600000	P.228
K0 BU/SU10.16HP WT	2592600000	P.230
K0 BU/SU10.16HP WT	2592600000	P.232
K0 BU/SU10.16HP WT	2592600000	P.234
K0 BU/SU10.16HP WT	2592600000	P.236
K0 BU/SU10.16HP WT	2592600000	P.238
K0 BU/SU10.16HP WT	2592600000	P.240
K0 BU/SU10.		

Type	Order No.	Page	Type	Order No.	Page	Type	Order No.	Page	Type	Order No.	Page
LS2HF 3.50/10/90 3.55N OR BX	2000970000	G.96	LSF-SMT 3.50/03/90 3.55N BK RL	1875030000	G.47	LSF-SMT 3.50/12/135 1.55N BK TU	1885280000	G.48	LSF-SMT 3.81/09/180 1.55N BK RL	1875390000	G.57
LS2HF 3.50/12/90 3.55N OR BX	2000980000	G.96	LSF-SMT 3.50/03/90 3.55N BK TU	1824430000	G.46	LSF-SMT 3.50/12/135 3.55N BK RL	1887530000	G.49	LSF-SMT 3.81/09/180 1.55N BK TU	1869960000	G.56
LS2HF 3.50/14/90 3.55N OR BX	2000990000	G.96	LSF-SMT 3.50/04/135 1.55N BK RL	1887580000	G.49	LSF-SMT 3.50/12/135 3.55N BK TU	1885750000	G.48	LSF-SMT 3.81/09/180 3.55N BK RL	1875730000	G.57
LS2HF 3.50/16/90 3.55N OR BX	2001000000	G.96	LSF-SMT 3.50/04/135 1.55N BK TU	1885200000	G.48	LSF-SMT 3.50/12/135 1.55N BK RL	1874420000	G.51	LSF-SMT 3.81/09/180 3.55N BK TU	1825270000	G.56
LS2HF 3.50/18/90 3.55N OR BX	2001010000	G.96	LSF-SMT 3.50/04/135 3.55N BK RL	1887360000	G.49	LSF-SMT 3.50/12/180 1.55N BK TU	1870740000	G.50	LSF-SMT 3.81/09/180 1.55N BK RL	1875290000	G.53
LS2HF 3.50/20/90 3.55N OR BX	2001020000	G.96	LSF-SMT 3.50/04/135 3.55N BK TU	1885670000	G.48	LSF-SMT 3.50/12/180 3.55N BK RL	1874680000	G.51	LSF-SMT 3.81/09/180 3.55N BK TU	1869430000	G.52
LS2HF 3.50/22/90 3.55N OR BX	2001030000	G.96	LSF-SMT 3.50/04/180 1.55N BK RL	1874280000	G.51	LSF-SMT 3.50/12/180 3.55N BK TU	1825740000	G.50	LSF-SMT 3.81/09/180 3.55N BK RL	1875990000	G.53
LS2HF 3.50/24/90 3.55N OR BX	2001040000	G.96	LSF-SMT 3.50/04/180 1.55N BK TU	1870660000	G.50	LSF-SMT 3.50/12/90 1.55N BK RL	1874970000	G.47	LSF-SMT 3.81/09/180 1.55N BK TU	1824710000	G.52
LSF-SMD 3.50/02/135 SN BK RL	1473310000	G.83	LSF-SMT 3.50/04/180 3.55N BK RL	1874540000	G.51	LSF-SMT 3.50/12/90 1.55N BK TU	1871070000	G.46	LSF-SMT 3.81/10/135 1.55N BK RL	1888530000	G.55
LSF-SMD 3.50/02/180 SN BK RL	1250360000	G.83	LSF-SMT 3.50/04/180 3.55N BK TU	1825660000	G.50	LSF-SMT 3.50/12/90 3.55N BK RL	1875160000	G.47	LSF-SMT 3.81/10/135 1.55N BK TU	1885490000	G.54
LSF-SMD 3.50/02/90 SN BK RL	1412410000	G.82	LSF-SMT 3.50/04/90 1.55N BK RL	1874730000	G.47	LSF-SMT 3.50/12/90 3.55N BK TU	1824520000	G.46	LSF-SMT 3.81/10/135 3.55N BK RL	1888430000	G.55
LSF-SMD 3.50/03/135 SN BK RL	1473320000	G.83	LSF-SMT 3.50/04/90 1.55N BK TU	1870550000	G.46	LSF-SMT 3.81/02/135 1.55N BK RL	1888450000	G.55	LSF-SMT 3.81/10/135 3.55N BK TU	1885960000	G.54
LSF-SMD 3.50/03/180 SN BK RL	1250370000	G.83	LSF-SMT 3.50/04/90 3.55N BK RL	1875050000	G.47	LSF-SMT 3.81/02/135 1.55N BK TU	1885410000	G.54	LSF-SMT 3.81/10/180 1.55N BK RL	1875400000	G.57
LSF-SMD 3.50/03/90 SN BK RL	1412420000	G.82	LSF-SMT 3.50/04/90 3.55N BK TU	1824440000	G.46	LSF-SMT 3.81/02/135 3.55N BK RL	1888320000	G.55	LSF-SMT 3.81/10/180 1.55N BK TU	1869970000	G.56
LSF-SMD 3.50/04/135 SN BK RL	1473330000	G.83	LSF-SMT 3.50/05/135 1.55N BK RL	1887630000	G.49	LSF-SMT 3.81/02/135 3.55N BK TU	1885680000	G.54	LSF-SMT 3.81/10/180 3.55N BK RL	1875760000	G.57
LSF-SMD 3.50/04/180 SN BK RL	1250380000	G.83	LSF-SMT 3.50/05/135 1.55N BK TU	1885210000	G.48	LSF-SMT 3.81/02/135 1.55N BK RL	1875320000	G.57	LSF-SMT 3.81/10/180 3.55N BK TU	1825890000	G.56
LSF-SMD 3.50/04/90 SN BK RL	1473510000	G.82	LSF-SMT 3.50/05/135 3.55N BK RL	1887460000	G.49	LSF-SMT 3.81/02/180 1.55N BK RL	1869990000	G.56	LSF-SMT 3.81/10/180 1.55N BK RL	1875300000	G.53
LSF-SMD 3.50/05/135 SN BK RL	1473340000	G.83	LSF-SMT 3.50/05/135 3.55N BK TU	1885680000	G.48	LSF-SMT 3.81/02/180 3.55N BK RL	1875550000	G.57	LSF-SMT 3.81/10/90 1.55N BK RL	1869440000	G.52
LSF-SMD 3.50/05/180 SN BK RL	1250390000	G.83	LSF-SMT 3.50/05/180 1.55N BK RL	1874310000	G.51	LSF-SMT 3.81/02/180 3.55N BK TU	1825790000	G.56	LSF-SMT 3.81/10/90 3.55N BK RL	1876000000	G.53
LSF-SMD 3.50/05/90 SN BK RL	1473520000	G.82	LSF-SMT 3.50/05/180 1.55N BK TU	1870670000	G.50	LSF-SMT 3.81/02/90 1.55N BK RL	1875170000	G.53	LSF-SMT 3.81/10/90 3.55N BK TU	1824720000	G.52
LSF-SMD 3.50/06/135 SN BK RL	1473350000	G.83	LSF-SMT 3.50/05/180 3.55N BK RL	1874560000	G.51	LSF-SMT 3.81/02/90 1.55N BK TU	1869360000	G.52	LSF-SMT 3.81/11/135 1.55N BK RL	1888540000	G.55
LSF-SMD 3.50/06/180 SN BK RL	1250410000	G.83	LSF-SMT 3.50/05/180 3.55N BK TU	1825670000	G.50	LSF-SMT 3.81/02/90 3.55N BK RL	1875920000	G.53	LSF-SMT 3.81/11/135 1.55N BK TU	1885510000	G.54
LSF-SMD 3.50/06/90 SN BK RL	1473530000	G.82	LSF-SMT 3.50/05/90 1.55N BK RL	1874740000	G.47	LSF-SMT 3.81/02/90 3.55N BK TU	1824620000	G.52	LSF-SMT 3.81/11/135 3.55N BK RL	1888440000	G.55
LSF-SMD 3.50/07/135 SN BK RL	1473370000	G.83	LSF-SMT 3.50/05/90 1.55N BK TU	1870580000	G.46	LSF-SMT 3.81/03/135 1.55N BK RL	1888460000	G.55	LSF-SMT 3.81/11/135 3.55N BK TU	1885970000	G.54
LSF-SMD 3.50/07/180 SN BK RL	1250420000	G.83	LSF-SMT 3.50/05/90 3.55N BK RL	1875070000	G.47	LSF-SMT 3.81/03/135 1.55N BK TU	1885420000	G.54	LSF-SMT 3.81/11/180 1.55N BK RL	1875410000	G.57
LSF-SMD 3.50/07/90 SN BK RL	1473540000	G.82	LSF-SMT 3.50/05/90 3.55N BK TU	1824450000	G.46	LSF-SMT 3.81/03/135 3.55N BK RL	1888330000	G.55	LSF-SMT 3.81/11/180 1.55N BK TU	1870000000	G.56
LSF-SMD 3.50/08/135 SN BK RL	1473380000	G.83	LSF-SMT 3.50/06/135 1.55N BK RL	1887640000	G.49	LSF-SMT 3.81/03/135 3.55N BK TU	1885690000	G.54	LSF-SMT 3.81/11/180 3.55N BK RL	1875810000	G.57
LSF-SMD 3.50/08/180 SN BK RL	1250430000	G.83	LSF-SMT 3.50/06/135 1.55N BK TU	1885220000	G.48	LSF-SMT 3.81/03/135 1.55N BK RL	1875330000	G.57	LSF-SMT 3.81/11/180 3.55N BK TU	1825890000	G.56
LSF-SMD 3.50/08/90 SN BK RL	1473550000	G.82	LSF-SMT 3.50/06/135 3.55N BK RL	1887470000	G.49	LSF-SMT 3.81/03/180 1.55N BK RL	1869990000	G.56	LSF-SMT 3.81/11/180 1.55N BK RL	1875310000	G.53
LSF-SMD 3.50/09/135 SN BK RL	1473390000	G.83	LSF-SMT 3.50/06/135 3.55N BK TU	1885690000	G.48	LSF-SMT 3.81/03/180 3.55N BK RL	1875570000	G.57	LSF-SMT 3.81/11/90 1.55N BK RL	1869450000	G.52
LSF-SMD 3.50/09/180 SN BK RL	1250440000	G.83	LSF-SMT 3.50/06/180 1.55N BK RL	1874320000	G.51	LSF-SMT 3.81/03/180 3.55N BK TU	1825800000	G.56	LSF-SMT 3.81/11/90 3.55N BK RL	1876010000	G.53
LSF-SMD 3.50/09/90 SN BK RL	1473570000	G.82	LSF-SMT 3.50/06/180 1.55N BK TU	1870680000	G.50	LSF-SMT 3.81/03/90 1.55N BK RL	1875230000	G.53	LSF-SMT 3.81/11/90 3.55N BK TU	1824730000	G.52
LSF-SMD 3.50/10/135 SN BK RL	1473410000	G.83	LSF-SMT 3.50/06/180 3.55N BK RL	1874590000	G.51	LSF-SMT 3.81/03/90 1.55N BK TU	1869370000	G.52	LSF-SMT 3.81/12/135 1.55N BK RL	1885980000	G.54
LSF-SMD 3.50/10/180 SN BK RL	1250450000	G.83	LSF-SMT 3.50/06/180 3.55N BK TU	1825680000	G.50	LSF-SMT 3.81/03/90 3.55N BK RL	1875930000	G.53	LSF-SMT 3.81/12/135 3.55N BK RL	1888690000	G.55
LSF-SMD 3.50/10/90 SN BK RL	1473590000	G.82	LSF-SMT 3.50/06/90 1.55N BK RL	1874810000	G.47	LSF-SMT 3.81/03/90 3.55N BK TU	1824630000	G.52	LSF-SMT 3.81/12/180 1.55N BK RL	1870010000	G.56
LSF-SMD 3.50/11/135 SN BK RL	1473420000	G.83	LSF-SMT 3.50/06/90 1.55N BK TU	1870590000	G.46	LSF-SMT 3.81/04/135 1.55N BK RL	1888470000	G.55	LSF-SMT 3.81/12/180 3.55N BK RL	1825920000	G.52
LSF-SMD 3.50/11/180 SN BK RL	1250460000	G.83	LSF-SMT 3.50/06/90 3.55N BK RL	1875090000	G.47	LSF-SMT 3.81/04/135 3.55N BK RL	1888340000	G.55	LSF-SMT 3.81/12/90 1.55N BK RL	1869460000	G.52
LSF-SMD 3.50/11/90 SN BK RL	1473620000	G.82	LSF-SMT 3.50/06/90 3.55N BK TU	1824460000	G.46	LSF-SMT 3.81/04/135 3.55N BK TU	1885900000	G.54	LSF-SMT 3.81/12/90 3.55N BK TU	1825300000	G.52
LSF-SMD 3.50/12/135 SN BK RL	1473430000	G.83	LSF-SMT 3.50/07/135 1.55N BK RL	1887650000	G.49	LSF-SMT 3.81/04/135 3.55N BK RL	1885900000	G.54	LSF-SMT 5.00/02/135 1.55N BK RL	1888570000	G.61
LSF-SMD 3.50/12/180 SN BK RL	1250470000	G.83	LSF-SMT 3.50/07/135 1.55N BK TU	1885230000	G.48	LSF-SMT 3.81/04/135 1.55N BK RL	1875340000	G.57	LSF-SMT 5.00/02/135 1.55N BK TU	1884530000	G.60
LSF-SMD 3.50/12/90 SN BK RL	1473650000	G.82	LSF-SMT 3.50/07/135 3.55N BK RL	1887480000	G.49	LSF-SMT 3.81/04/135 1.55N BK TU	1869910000	G.56	LSF-SMT 5.00/02/135 3.55N BK RL	1888640000	G.61
LSF-SMD 5.00/02/135 SN BK RL	1473690000	G.85	LSF-SMT 3.50/07/135 3.55N BK TU	1885700000	G.48	LSF-SMT 3.81/04/180 1.55N BK RL	1875590000	G.57	LSF-SMT 5.00/02/135 3.55N BK TU	1884340000	G.60
LSF-SMD 5.00/02/180 SN BK RL	1473560000	G.85	LSF-SMT 3.50/07/180 1.55N BK RL	1874340000	G.51	LSF-SMT 3.81/04/180 3.55N BK RL	1875590000	G.57	LSF-SMT 5.00/02/180 1.55N BK RL	1876020000	G.63
LSF-SMD 5.00/02/90 SN BK RL	1473770000	G.84	LSF-SMT 3.50/07/180 1.55N BK TU	1870690000	G.50	LSF-SMT 3.81/04/180 3.55N BK TU	1825810000	G.56	LSF-SMT 5.00/02/180 1.55N BK TU	1870140000	G.62
LSF-SMD 5.00/03/135 SN BK RL	1473700000	G.85	LSF-SMT 3.50/07/180 3.55N BK RL	1874600000	G.51	LSF-SMT 3.81/04/90 1.55N BK RL	1869380000	G.52	LSF-SMT 5.00/02/180 3.55N BK RL	1876110000	G.63
LSF-SMD 5.00/03/180 SN BK RL	1473580000	G.85	LSF-SMT 3.50/07/180 3.55N BK TU	1825690000	G.50	LSF-SMT 3.81/04/90 3.55N BK RL	1875940000	G.53	LSF-SMT 5.00/02/180 3.55N BK TU	1825960000	G.62
LSF-SMD 5.00/03/90 SN BK RL	1473780000	G.84	LSF-SMT 3.50/07/90 1.55N BK RL	1874840000	G.47	LSF-SMT 3.81/04/90 3.55N BK TU	1824640000	G.52	LSF-SMT 5.00/02/90 1.55N BK RL	1876240000	G.59
LSF-SMD 5.00/04/135 SN BK RL	1473710000	G.85	LSF-SMT 3.50/07/90 1.55N BK TU	1871020000	G.46	LSF-SMT 3.81/05/135 1.55N BK RL	1888480000	G.55	LSF-SMT 5.00/02/90 1.55N BK TU	1869600000	G.58
LSF-SMD 5.00/04/180 SN BK RL	1473610000	G.85	LSF-SMT 3.50/07/90 3.55N BK RL	1875100000	G.47	LSF-SMT 3.81/05/135 1.55N BK TU	1885440000	G.54	LSF-SMT 5.00/02/90 3.55N BK RL	1876430000	G.59
LSF-SMD 5.00/04/90 SN BK RL	1473790000	G.84	LSF-SMT 3.50/07/90 3.55N BK TU	1824470000	G.46	LSF-SMT 3.81/05/135 3.55N BK RL	1888380000	G.55	LSF-SMT 5.00/02/90 3.55N BK TU	1824740000	G.58
LSF-SMD 5.00/05/135 SN BK RL	1473720000	G.85	LSF-SMT 3.50/08/135 1.55N BK RL	1887660000	G.49	LSF-SMT 3.81/05/135 3.55N BK RL	1885910000	G.54	LSF-SMT 5.00/03/135 1.55N BK RL	1888580000	G.61
LSF-SMD 5.00/05/180 SN BK RL	1473640000	G.85	LSF-SMT 3.50/08/135 1.55N BK TU	1885240000	G.48	LSF-SMT 3.81/05/180 1.55N BK RL	1875350000	G.57	LSF-SMT 5.00/03/135 1.55N BK TU	1884540000	G.60
LSF-SMD 5.00/05/90 SN BK RL	1473800000	G.84	LSF-SMT 3.50/08/135 3.55N BK RL	1887490000	G.49	LSF-SMT 3.81/05/180 1.55N BK TU	1869920000	G.56	LSF-SMT 5.00/03/135 3.55N BK RL	1888650000	G.61
LSF-SMD 5.00/06/135 SN BK RL	1473740000	G.85	LSF-SMT 3.50/08/135 3.55N BK TU	1885710000	G.48	LSF-SMT 3.81/05/180 3.55N BK RL	1875650000	G.57	LSF-SMT 5.00/03/135 3.55N BK TU	1884370000	G.60
LSF-SMD 5.00/06/180 SN BK RL	1473660000	G.85	LSF-SMT 3.50/08/180 1.55N BK RL	1874350000	G.51	LSF-SMT 3.81/05/180 3.55N BK TU	1825820000	G.56	LSF-SMT 5.00/03/180 1.55N BK RL	1876030000	G.63
LSF-SMD 5.00/06/90 SN BK RL	1473810000	G.84	LSF-SMT 3.50/08/180 1.55N BK TU	1870700000	G.50	LSF-SMT 3.81/05/90 1.55N BK RL	1875250000	G.53	LSF-SMT 5.00/03/180 1.55N BK TU	1870150000	G.62
LSF-SMD 5.00/07/135 SN BK RL	1473750000	G.85	LSF-SMT 3.50/08/180 3.55N BK RL	1874610000	G.51	LSF-SMT 3.81/05/90 1.55N BK TU	1869390000	G.52	LSF-SMT 5.00/03/180 3.55N BK RL	1876130000	G.63
LSF-SMD 5.00/07/180 SN BK RL	1473670000	G.85	LSF-SMT 3.50/08/180 3.55N BK TU	1825700000	G.50	LSF-SMT 3.81/05/90 3.55N BK RL	1875950000	G.53	LSF-SMT 5.00/03/180 3.55N BK TU	1825970000	G.62
LSF-SMD 5.00/07/90 SN BK RL	1473820000	G.84	LSF-SMT 3.50/08/90 1.55N BK RL	1874890000	G.47	LSF-SMT 3.81/05/90 3.55N BK TU	1824650000	G.52	LSF-SMT 5.00/03/9		

Type	Order No.	Page
LXXX 15.00/02/90F 4.5SN BK BX	1047290000	0.25
LXXX 15.00/02/90FL 4.5SN BK BX	1047450000	0.25
LXXX 15.00/02/90FR 4.5SN BK BX	1047610000	0.25
LXXX 15.00/03/90 4.5SN BK BX	1047140000	0.24
LXXX 15.00/03/90F 4.5SN BK BX	1047300000	0.25
LXXX 15.00/03/90FL 4.5SN BK BX	1047460000	0.25
LXXX 15.00/03/90FR 4.5SN BK BX	1047620000	0.25
LXXX 15.00/04/90 4.5SN BK BX	1047150000	0.24
LXXX 15.00/04/90F 4.5SN BK BX	1047310000	0.25
LXXX 15.00/04/90FL 4.5SN BK BX	1047470000	0.25
LXXX 15.00/04/90FR 4.5SN BK BX	1047630000	0.25
LXXX 15.00/05/90 4.5SN BK BX	1386250000	0.24
LXXX 15.00/05/90F 4.5SN BK BX	1386290000	0.25
LXXX 15.00/05/90FL 4.5SN BK BX	1386330000	0.25
LXXX 15.00/05/90FR 4.5SN BK BX	1386370000	0.25
LXXX 15.00/06/90 4.5SN BK BX	1386400000	0.24
LXXX 15.00/06/90F 4.5SN BK BX	1386440000	0.25
LXXX 15.00/06/90FL 4.5SN BK BX	1386480000	0.25
LXXX 15.00/06/90FR 4.5SN BK BX	1386520000	0.25
LXXX 15.00/07/90 4.5SN BK BX	1386550000	0.24
LXXX 15.00/07/90F 4.5SN BK BX	1386590000	0.25
LXXX 15.00/07/90FL 4.5SN BK BX	1386630000	0.25
LXXX 15.00/07/90FR 4.5SN BK BX	1386670000	0.25
LXXX 15.00/08/90 4.5SN BK BX	1386700000	0.24
LXXX 15.00/08/90F 4.5SN BK BX	1386740000	0.25
LXXX 15.00/08/90FL 4.5SN BK BX	1386780000	0.25
LXXX 15.00/08/90FR 4.5SN BK BX	1386820000	0.25
LXXX 15.00/09/90 4.5SN BK BX	1386850000	0.24
LXXX 15.00/09/90F 4.5SN BK BX	1386890000	0.25
LXXX 15.00/09/90FL 4.5SN BK BX	1386930000	0.25
LXXX 15.00/09/90FR 4.5SN BK BX	1386970000	0.25

M

MCZ5	8857560000	T.45
MHS 5/02 H T3 B T	2741400000	B.10
MHS 5/02 V T3 B T	8000072425	B.11
MHS 5/02 W T3 B T	8000072497	B.12
MHS 5/03 D11 H T3 B T	2741520000	B.22
MHS 5/03 H T3 B T	2741420000	B.10
MHS 5/03 V T3 B T	8000072430	B.11
MHS 5/03 W T3 B T	8000072503	B.12
MHS 5/04 D11 H T3 B T	2741530000	B.22
MHS 5/04 H T3 B T	2741430000	B.10
MHS 5/04 V T3 B T	8000072431	B.11
MHS 5/04 W T3 B T	8000072506	B.12
MHS 5/05 D11 H T3 B T	2741540000	B.22
MHS 5/05 H T3 B T	2741440000	B.10
MHS 5/05 V T3 B T	8000072435	B.11
MHS 5/05 W T3 B T	8000072508	B.12
MHS 5/06 D11 H T3 B T	2741550000	B.22
MHS 5/06 H T3 B T	2741450000	B.10
MHS 5/06 V T3 B T	8000072438	B.11
MHS 5/06 W T3 B T	8000072509	B.12
MHS 5/07 H T3 B T	2741460000	B.10
MHS 5/07 V T3 B T	8000072450	B.11
MHS 5/07 W T3 B T	8000072510	B.12
MHS 5/08 H T3 B T	2741470000	B.10
MHS 5/08 V T3 B T	8000072453	B.11
MHS 5/08 W T3 B T	8000072511	B.12
MHS 5/09 H T3 B T	2741480000	B.10
MHS 5/09 V T3 B T	8000072454	B.11
MHS 5/09 W T3 B T	8000072512	B.12
MHS 5/10 H T3 B T	2741490000	B.10
MHS 5/10 V T3 B T	8000072456	B.11
MHS 5/10 W T3 B T	8000072513	B.12
MHS 5/11 H T3 B T	2741500000	B.10
MHS 5/11 V T3 B T	8000072461	B.11
MHS 5/11 W T3 B T	8000072514	B.12
MHS 5/12 H T3 B T	2741510000	B.10
MHS 5/12 V T3 B T	8000072470	B.11
MHS 5/12 W T3 B T	8000072515	B.12
MHS 6	1925740000	T.44
MHS 7S/02 H T3 B T	8000078306	B.15
MHS 7S/02 V T3 B T	8000078314	B.16
MHS 7S/02 W T3 B T	8000078321	B.17
MHS 7S/02-5/02 H	8000078335	B.20
MHS 7S/02-5/03 H	8000078338	B.20
MHS 7S/02-5/04 H	8000078341	B.20
MHS 7S/03 H T3 B T	8000078308	B.15
MHS 7S/03 V T3 B T	8000078315	B.16
MHS 7S/03 W T3 B T	8000078322	B.17
MHS 7S/03-5/02 D11 H T3 B T	8000085192	B.25
MHS 7S/03-5/02 H	8000078336	B.20
MHS 7S/03-5/03 H	8000078339	B.20
MHS 7S/03-5/04 H	8000085261	B.25
MHS 7S/03-5/04 H	8000078342	B.15
MHS 7S/04 H T3 B T	8000078309	B.15
MHS 7S/04 V T3 B T	8000078316	B.16
MHS 7S/04 W T3 B T	8000078323	B.17
MHS 7S/04-5/02 D11 H T3 B T	8000085260	B.25
MHS 7S/04-5/02 H	8000078337	B.20
MHS 7S/04-5/03 H	8000078340	B.20
MHS 7S/04-5/04 H	8000085263	B.25
MHS 7S/04-5/04 H	8000078343	B.20
MHS 7S/05 H T3 B T	8000078310	B.15
MHS 7S/05 V T3 B T	8000078317	B.16
MHS 7S/05 W T3 B T	8000078324	B.17
MHS 7S/06 H T3 B T	8000078311	B.15

Type	Order No.	Page
MHS 7S/06 V T3 B T	8000078318	B.16
MHS 7S/06 W T3 B T	8000078325	B.17
MHS 7S/07 H T3 B T	8000078312	B.15
MHS 7S/07 V T3 B T	8000078319	B.16
MHS 7S/07 W T3 B T	8000078326	B.17
MHS 7S/08 H T3 B T	8000078313	B.15
MHS 7S/08 V T3 B T	8000078320	B.16
MHS 7S/08 W T3 B T	8000078327	B.17
MHZ6	1925760000	T.44
MOFU 35/LD/1 SW	0646210000	T.56
MPS 5/02 S F1 TN B B	2741670000	B.14
MPS 5/02 S TN B B	2741560000	B.13
MPS 5/03 D11 S F2 TN B B	2741890000	B.24
MPS 5/03 D11 S TN B B	2741780000	B.23
MPS 5/03 S F2 TN B B	2741680000	B.14
MPS 5/03 S TN B B	2741570000	B.13
MPS 5/04 D11 S F2 TN B B	2741900000	B.24
MPS 5/04 D11 S TN B B	2741790000	B.23
MPS 5/04 S F2 TN B B	2741690000	B.14
MPS 5/04 S TN B B	2741580000	B.13
MPS 5/05 D11 S F3 TN B B	2741910000	B.24
MPS 5/05 D11 S TN B B	2741800000	B.23
MPS 5/05 S F3 TN B B	2741700000	B.14
MPS 5/05 S TN B B	2741590000	B.13
MPS 5/06 D11 S F3 TN B B	2741920000	B.24
MPS 5/06 D11 S TN B B	2741810000	B.23
MPS 5/06 S F3 TN B B	2741710000	B.14
MPS 5/06 S TN B B	2741600000	B.13
MPS 5/07 S F4 TN B B	2741720000	B.14
MPS 5/07 S TN B B	2741610000	B.13
MPS 5/08 S F4 TN B B	2741730000	B.14
MPS 5/08 S TN B B	2741620000	B.13
MPS 5/09 S F5 TN B B	2741740000	B.14
MPS 5/09 S TN B B	2741630000	B.13
MPS 5/10 S F5 TN B B	2741750000	B.14
MPS 5/10 S TN B B	2741640000	B.13
MPS 5/11 S F6 TN B B	2741760000	B.14
MPS 5/11 S TN B B	2741650000	B.13
MPS 5/12 S F6 TN B B	2741770000	B.14
MPS 5/12 S TN B B	2741660000	B.13
MPS 7S/02 S F1 TN B B	8000078353	B.19
MPS 7S/02 S TN B B	8000078328	B.18
MPS 7S/02-5/02	8000078344	B.21
MPS 7S/02-5/03	8000078347	B.21
MPS 7S/02-5/04	8000078350	B.21
MPS 7S/03 S F2 TN B B	8000078354	B.19
MPS 7S/03 S TN B B	8000078329	B.18
MPS 7S/03-5/02	8000078345	B.21
MPS 7S/03-5/02 D11 S TN B B	8000085268	B.26
MPS 7S/03-5/03	8000078348	B.21
MPS 7S/03-5/04	8000078351	B.21
MPS 7S/03-5/04 D11 S TN B B	8000085270	B.26
MPS 7S/04 S F2 TN B B	8000078355	B.19
MPS 7S/04 S TN B B	8000078330	B.18
MPS 7S/04-5/02	8000078346	B.21
MPS 7S/04-5/02 D11 S TN B B	8000085269	B.26
MPS 7S/04-5/03	8000078349	B.21
MPS 7S/04-5/04	8000078352	B.21
MPS 7S/04-5/04 D11 S TN B B	8000085271	B.26
MPS 7S/05 S F3 TN B B	8000078356	B.19
MPS 7S/05 S TN B B	8000078331	B.18
MPS 7S/06 S F3 TN B B	8000078357	B.19
MPS 7S/06 S TN B B	8000078332	B.18
MPS 7S/07 S F4 TN B B	8000078358	B.19
MPS 7S/07 S TN B B	8000078333	B.18
MPS 7S/08 S F4 TN B B	8000078359	B.19
MPS 7S/08 S TN B B	8000078334	B.18
MTA 30 BK	1168970000	T.56
MTA 45 BK	1962250000	T.56

P

PB-CO RD	2654620000	Q.4
PB-CON 160 S/02/90RFSFAG BK BX	2594720000	Q.4
PB-CON IKSC M4X8 A2	2708610000	Q.4
PB-CON SF DELTA PT 40X12	2708620000	Q.4
PB-ENDCAP 160 Q2RF BK BX	2594970000	Q.4
PB-FEED 160 100/Q2RF AG BK BX	2595180000	Q.5
PB-FEED 160 50/Q2RF AG BK BX	2594950000	Q.5
PB-LINK 160 100/Q2RF AG BK BX	2594960000	Q.5
PB-LINK 160 50/Q2RF AG BK BX	2595540000	Q.5
PF RS 100 GR 2000MM A.1	4010870000	T.54
PF RS 100 OR 155.5 MM	4148400000	T.54
PF RS 100 OR 2000MM A.1	4144870000	T.54
PF RS 122 OR 2000MM	1155940000	T.55
PF RS 45 GR 1000MM	8140880000	T.50
PF RS 45 GR 2000MM	4027750000	T.50
PF RS 45 OR 2000MM	4340430000	T.50
PF RS 80 GR 2000MM	4183130000	T.52
PF RS 80 OR 2000MM	4157440000	T.52
PF RS 90 GR 2000MM	4051810000	T.53
PF RS 90 OR 2000MM	4053240000	T.53
PGK 4 BK	1288470000	R.10
PGK 4 BT BK	1288590000	R.10
PM 5.00/02/90 3.5SN OR BX	1791610000	G.44
PM 5.00/03/90 3.5SN OR BX	1791620000	G.44
PM 5.00/04/90 3.5SN OR BX	1234650000	G.44
PM 5.00/05/90 3.5SN OR BX	1234670000	G.44
PM 5.00/06/90 3.5SN OR BX	1234680000	G.44

Type	Order No.	Page
PM 5.00/07/90 3.5SN OR BX	1234690000	G.44
PM 5.00/08/90 3.5SN OR BX	1234700000	G.44
PM 5.00/09/90 3.5SN OR BX	1234710000	G.44
PM 5.00/10/90 3.5SN OR BX	1234720000	G.44
PM 5.00/11/90 3.5SN OR BX	1234730000	G.44
PM 5.00/12/90 3.5SN OR BX	1234740000	G.44
PM 5.08/02/90 3.5SN OR BX	1760490000	G.45
PM 5.08/03/90 3.5SN OR BX	1760500000	G.45
PM 5.08/04/90 3.5SN OR BX	1234550000	G.45
PM 5.08/05/90 3.5SN OR BX	1234570000	G.45
PM 5.08/06/90 3.5SN OR BX	1234580000	G.45
PM 5.08/07/90 3.5SN OR BX	1234590000	G.45
PM 5.08/08/90 3.5SN OR BX	1234600000	G.45
PM 5.08/09/90 3.5SN OR BX	1234610000	G.45
PM 5.08/10/90 3.5SN OR BX	1234620000	G.45
PM 5.08/11/90 3.5SN OR BX	1234630000	G.45
PM 5.08/12/90 3.5SN OR BX	1234640000	G.45
PS 2.0 MC	0310000000	G.88
PS 2.0 MC	0310000000	G.90
PS 2.0 MC	0310000000	N.12
PS 2.0 MC	0310000000	O.19
PS 2.0 MC	0310000000	O.20
PS 2.0 MC	0310000000	O.21
PS 2.0 MC	0310000000	O.22
PS 2.0 MC	0310000000	O.24
PS 2.0 MC	0310000000	O.26
PS 2.0 MC	0310000000	O.27
PS 2.0 MC	0310000000	O.28
PS 2.0 MC	0310000000	O.29
PS 2.0 MC	0310000000	O.30
PS 2.0 MC	0310000000	O.31
PS 2.0 MC	0310000000	O.32
PS 2.0 MC	0310000000	O.33
PS 2.0 MC	0310000000	O.34
PS 2.0 MC	0310000000	O.35
PS 2.0 MC	0310000000	O.36
PS 2.0 MC	0310000000	O.37
PS 2.0 MC	0310000000	O.38
PS 2.0 MC	0310000000	O.39
PS 2.0 MC	0310000000	O.40
PS 2.0 MC	0310000000	O.41
PS 2.0 MC	0310000000	S.6
PS 2.3 RT	0180400000	R.10
PS 3.50/02/90 3.5SN OR BX	1912320000	G.42
PS 3.50/03/90 3.5SN OR BX	1912330000	G.42
PS 3.50/04/90 3.5SN OR BX	1912340000	G.42
PS 3.50/05/90 3.5SN OR BX	1912350000	G.42
PS 3.50/06/90 3.5SN OR BX	1912360000	G.42
PS 3.50/07/90 3.5SN OR BX	1912370000	G.42
PS 3.50/08/90 3.5SN OR BX	1912380000	G.42
PS 3.50/09/90 3.5SN OR BX	1912390000	G.42
PS 3.50/10/90 3.5SN OR BX	1912400000	G.42
PS 3.50/11/90 3.5SN OR BX	1912410000	G.42
PS 3.50/12/90 3.5SN OR BX	1912420000	G.42
PTSC KA 2.2X4.5 WN1412	1610740000	J.14
PTSC KA 2.2X4.5 WN1412	1610740000	J.16
PTSC KA 2.2X4.5 WN1412	1610740000	J.30
PTSC KA 2.2X4.5 WN1412	1610740000	J.36
PTSC KA 2.2X4.5 WN1412	1610740000	J.38
PTSC KA 2.2X4.5 WN1412	1610740000	K.18
PTSC KA 2.2X4.5 WN1412	1610740000	K.24
PTSC KA 2.2X4.5 WN1412	1610740000	K.28
PTSC KA 2.2X4.5 WN1412	1610740000	K.36
PTSC KA 2.2X4.5 WN1412	1610740000	K.42
PTSC KB40X14	4	

Type	Order No.	Page	Type	Order No.	Page	Type	Order No.	Page	Type	Order No.	Page
SC-SMT 3.81/05/90LF 3.2SN BK BX	186370000	K.9	SCD 3.81/16/90F 3.2SN OR BX	197332000	K.35	SCDN-THR 3.81/20/90F 3.2SN BK BX	103903000	K.20	SCZ 3.81/02/180F SN OR BX	197026000	K.45
SC-SMT 3.81/06/135G 3.2SN BK BX	197724000	K.12	SCD 3.81/16/90G 3.2SN OR BX	197286000	K.34	SCDN-THR 3.81/20/90G 3.2SN BK BX	103957000	K.21	SCZ 3.81/02/180G SN OR BX	196952000	K.44
SC-SMT 3.81/06/135LF 3.2SN BK BX	197812000	K.13	SCD 3.81/18/180F 3.2SN OR BX	103052000	K.37	SCDN-THR 3.81/20/90G 3.2SN BK BX	103904000	K.20	SCZ 3.81/02/180L SN OR BX	244205000	K.45
SC-SMT 3.81/06/180G 1.5SN BK RL	186431000	K.11	SCD 3.81/18/180G 3.2SN OR BX	103001000	K.36	SCDN-THR 3.81/22/90F 3.2SN BK BX	103958000	K.21	SCZ 3.81/03/180F SN OR BX	197092000	K.45
SC-SMT 3.81/06/180G 3.2SN BK BX	186302000	K.10	SCD 3.81/18/90F 3.2SN OR BX	197333000	K.35	SCDN-THR 3.81/22/90G 3.2SN BK BX	103905000	K.20	SCZ 3.81/03/180L SN OR BX	197027000	K.45
SC-SMT 3.81/06/180LF 1.5SN BK RL	186426000	K.11	SCD 3.81/18/90G 3.2SN OR BX	197286000	K.34	SCDN-THR 3.81/24/90F 3.2SN BK BX	103959000	K.21	SCZ 3.81/03/180L SN OR BX	196954000	K.44
SC-SMT 3.81/06/180LF 3.2SN BK BX	186330000	K.11	SCD 3.81/20/180F 3.2SN OR BX	103053000	K.37	SCDN-THR 3.81/24/90G 3.2SN BK BX	103906000	K.20	SCZ 3.81/03/180L SN OR BX	244406000	K.45
SC-SMT 3.81/06/270F 3.2SN BK BX	103704000	K.15	SCD 3.81/20/180G 3.2SN OR BX	103002000	K.36	SCDV 3.81/04/180F 3.2SN OR BX	103498000	K.42	SCZ 3.81/04/180F SN OR BX	197093000	K.45
SC-SMT 3.81/06/270G 3.2SN BK BX	103653000	K.14	SCD 3.81/20/90F 3.2SN OR BX	197334000	K.35	SCDV 3.81/04/180G 3.2SN OR BX	103447000	K.43	SCZ 3.81/04/180F SN OR BX	197031000	K.45
SC-SMT 3.81/06/90G 1.5SN BK RL	186318000	K.9	SCD 3.81/20/90G 3.2SN OR BX	197287000	K.34	SCDV 3.81/04/90F 3.2SN OR BX	103258000	K.41	SCZ 3.81/04/180FZ SN OR BX	123755000	K.47
SC-SMT 3.81/06/90G 3.2SN BK BX	186251000	K.8	SCD 3.81/22/180F 3.2SN OR BX	103054000	K.37	SCDV 3.81/04/90G 3.2SN OR BX	103209000	K.40	SCZ 3.81/04/180FZ SN OR BX	123712000	K.47
SC-SMT 3.81/06/90LF 1.5SN BK RL	186282000	K.9	SCD 3.81/22/180G 3.2SN OR BX	103003000	K.36	SCDV 3.81/06/180F 3.2SN OR BX	103499000	K.42	SCZ 3.81/04/180G SN OR BX	196956000	K.44
SC-SMT 3.81/06/90LF 3.2SN BK BX	186371000	K.9	SCD 3.81/22/90F 3.2SN OR BX	197335000	K.35	SCDV 3.81/06/180G 3.2SN OR BX	103449000	K.43	SCZ 3.81/04/180GZ SN OR BX	123700000	K.46
SC-SMT 3.81/07/135G 3.2SN BK BX	197725000	K.12	SCD 3.81/22/90G 3.2SN OR BX	197288000	K.34	SCDV 3.81/06/90F 3.2SN OR BX	103259000	K.41	SCZ 3.81/04/180L SN OR BX	244089000	K.45
SC-SMT 3.81/07/135LF 3.2SN BK BX	197813000	K.13	SCD 3.81/24/180F 3.2SN OR BX	103055000	K.37	SCDV 3.81/06/90G 3.2SN OR BX	103211000	K.40	SCZ 3.81/04/180LZ SN OR BX	244420000	K.47
SC-SMT 3.81/07/180G 1.5SN BK RL	186432000	K.11	SCD 3.81/24/180G 3.2SN OR BX	103004000	K.36	SCDV 3.81/08/180F 3.2SN OR BX	103501000	K.43	SCZ 3.81/05/180L SN OR BX	197094000	K.45
SC-SMT 3.81/07/180G 3.2SN BK BX	186303000	K.10	SCD 3.81/24/90F 3.2SN OR BX	197336000	K.35	SCDV 3.81/08/180G 3.2SN OR BX	103451000	K.42	SCZ 3.81/05/180L SN OR BX	197032000	K.45
SC-SMT 3.81/07/180LF 1.5SN BK RL	186427000	K.11	SCD 3.81/24/90G 3.2SN OR BX	197289000	K.34	SCDV 3.81/08/90F 3.2SN OR BX	103260000	K.41	SCZ 3.81/05/180FZ SN OR BX	123756000	K.47
SC-SMT 3.81/07/180LF 3.2SN BK BX	186331000	K.11	SCD-THR 3.81/04/180F 3.2SN BK BX	103146000	K.19	SCDV 3.81/08/90G 3.2SN OR BX	103212000	K.40	SCZ 3.81/05/180FZ SN OR BX	123713000	K.47
SC-SMT 3.81/07/270F 3.2SN BK BX	103705000	K.15	SCD-THR 3.81/04/180G 3.2SN BK BX	103095000	K.18	SCDV 3.81/10/180F 3.2SN OR BX	103502000	K.43	SCZ 3.81/05/180G SN OR BX	196957000	K.44
SC-SMT 3.81/07/270G 3.2SN BK BX	103654000	K.14	SCD-THR 3.81/04/90F 3.2SN BK BX	197418000	K.17	SCDV 3.81/10/180G 3.2SN OR BX	103452000	K.42	SCZ 3.81/05/180GZ SN OR BX	123701000	K.46
SC-SMT 3.81/07/90G 1.5SN BK RL	186319000	K.9	SCD-THR 3.81/04/90G 3.2SN BK BX	197373000	K.16	SCDV 3.81/10/90F 3.2SN OR BX	103261000	K.41	SCZ 3.81/05/180L SN OR BX	244410000	K.45
SC-SMT 3.81/07/90G 3.2SN BK BX	186252000	K.8	SCD-THR 3.81/06/180F 3.2SN BK BX	103147000	K.19	SCDV 3.81/10/90G 3.2SN OR BX	103213000	K.40	SCZ 3.81/05/180LZ SN OR BX	244220000	K.47
SC-SMT 3.81/07/90LF 1.5SN BK RL	186283000	K.9	SCD-THR 3.81/06/180G 3.2SN BK BX	103096000	K.18	SCDV 3.81/12/180F 3.2SN OR BX	103503000	K.42	SCZ 3.81/06/180F SN OR BX	197096000	K.45
SC-SMT 3.81/07/90LF 3.2SN BK BX	186374000	K.9	SCD-THR 3.81/06/90F 3.2SN BK BX	197419000	K.17	SCDV 3.81/12/180G 3.2SN OR BX	103453000	K.43	SCZ 3.81/06/180F SN OR BX	197034000	K.45
SC-SMT 3.81/09/135G 3.2SN BK BX	197769000	K.12	SCD-THR 3.81/06/90G 3.2SN BK BX	197374000	K.16	SCDV 3.81/12/180G 3.2SN OR BX	103262000	K.41	SCZ 3.81/06/180FZ SN OR BX	123757000	K.47
SC-SMT 3.81/09/135LF 3.2SN BK BX	197814000	K.13	SCD-THR 3.81/08/180F 3.2SN BK BX	103149000	K.19	SCDV 3.81/12/90G 3.2SN OR BX	103214000	K.40	SCZ 3.81/06/180FZ SN OR BX	123714000	K.47
SC-SMT 3.81/08/180G 1.5SN BK RL	186433000	K.11	SCD-THR 3.81/08/180G 3.2SN BK BX	103097000	K.18	SCDV 3.81/14/180F 3.2SN OR BX	103504000	K.43	SCZ 3.81/06/180G SN OR BX	196958000	K.44
SC-SMT 3.81/08/180G 3.2SN BK BX	186324000	K.10	SCD-THR 3.81/08/90F 3.2SN BK BX	197420000	K.17	SCDV 3.81/14/180G 3.2SN OR BX	103454000	K.42	SCZ 3.81/06/180GZ SN OR BX	123702000	K.46
SC-SMT 3.81/08/180LF 1.5SN BK RL	186428000	K.11	SCD-THR 3.81/08/90G 3.2SN BK BX	197375000	K.16	SCDV 3.81/14/90F 3.2SN OR BX	103263000	K.41	SCZ 3.81/06/180L SN OR BX	244411000	K.45
SC-SMT 3.81/08/180LF 3.2SN BK BX	186334000	K.11	SCD-THR 3.81/10/180F 3.2SN BK BX	103151000	K.19	SCDV 3.81/14/90G 3.2SN OR BX	103215000	K.40	SCZ 3.81/06/180LZ SN OR BX	244427000	K.47
SC-SMT 3.81/08/270F 3.2SN BK BX	103706000	K.15	SCD-THR 3.81/10/180G 3.2SN BK BX	103098000	K.18	SCDV 3.81/16/180F 3.2SN OR BX	103505000	K.43	SCZ 3.81/07/180F SN OR BX	197097000	K.45
SC-SMT 3.81/08/270G 3.2SN BK BX	103655000	K.14	SCD-THR 3.81/10/90F 3.2SN BK BX	197421000	K.17	SCDV 3.81/16/180G 3.2SN OR BX	103455000	K.42	SCZ 3.81/07/180F SN OR BX	197035000	K.45
SC-SMT 3.81/08/90G 1.5SN BK RL	186320000	K.9	SCD-THR 3.81/10/90G 3.2SN BK BX	197376000	K.16	SCDV 3.81/16/90F 3.2SN OR BX	103264000	K.41	SCZ 3.81/07/180FZ SN OR BX	123758000	K.47
SC-SMT 3.81/08/90G 3.2SN BK BX	186253000	K.8	SCD-THR 3.81/12/180F 3.2SN BK BX	103152000	K.19	SCDV 3.81/16/90G 3.2SN OR BX	103216000	K.40	SCZ 3.81/07/180FZ SN OR BX	123715000	K.47
SC-SMT 3.81/08/90LF 1.5SN BK RL	186285000	K.9	SCD-THR 3.81/12/180G 3.2SN BK BX	103099000	K.18	SCDV 3.81/18/180F 3.2SN OR BX	103506000	K.42	SCZ 3.81/07/180G SN OR BX	196959000	K.44
SC-SMT 3.81/08/90LF 3.2SN BK BX	186375000	K.9	SCD-THR 3.81/12/90F 3.2SN BK BX	197422000	K.17	SCDV 3.81/18/180G 3.2SN OR BX	103456000	K.43	SCZ 3.81/07/180GZ SN OR BX	123703000	K.46
SC-SMT 3.81/09/135G 3.2SN BK BX	197770000	K.12	SCD-THR 3.81/12/90G 3.2SN BK BX	197377000	K.16	SCDV 3.81/18/90F 3.2SN OR BX	103265000	K.41	SCZ 3.81/07/180L SN OR BX	244412000	K.45
SC-SMT 3.81/09/135LF 3.2SN BK BX	197815000	K.13	SCD-THR 3.81/14/180F 3.2SN BK BX	103153000	K.19	SCDV 3.81/18/90G 3.2SN OR BX	103217000	K.40	SCZ 3.81/07/180LZ SN OR BX	244420000	K.47
SC-SMT 3.81/09/180G 1.5SN BK RL	186434000	K.11	SCD-THR 3.81/14/180G 3.2SN BK BX	103101000	K.18	SCDV 3.81/20/180F 3.2SN OR BX	103507000	K.43	SCZ 3.81/08/180F SN OR BX	197098000	K.45
SC-SMT 3.81/09/180G 3.2SN BK BX	186327000	K.10	SCD-THR 3.81/14/90F 3.2SN BK BX	197423000	K.17	SCDV 3.81/20/180G 3.2SN OR BX	103457000	K.42	SCZ 3.81/08/180F SN OR BX	197036000	K.45
SC-SMT 3.81/09/180LF 1.5SN BK RL	186429000	K.11	SCD-THR 3.81/14/90G 3.2SN BK BX	197378000	K.16	SCDV 3.81/20/90F 3.2SN OR BX	103266000	K.41	SCZ 3.81/08/180FZ SN OR BX	123759000	K.47
SC-SMT 3.81/09/180LF 3.2SN BK BX	186335000	K.11	SCD-THR 3.81/16/180F 3.2SN BK BX	103154000	K.19	SCDV 3.81/20/90G 3.2SN OR BX	103218000	K.40	SCZ 3.81/08/180L SN OR BX	244413000	K.45
SC-SMT 3.81/09/270F 3.2SN BK BX	103707000	K.15	SCD-THR 3.81/16/180G 3.2SN BK BX	103102000	K.18	SCDV 3.81/22/180F 3.2SN OR BX	103508000	K.43	SCZ 3.81/08/180LZ SN OR BX	244423000	K.47
SC-SMT 3.81/09/270G 3.2SN BK BX	103656000	K.14	SCD-THR 3.81/16/90F 3.2SN BK BX	197424000	K.17	SCDV 3.81/22/180G 3.2SN OR BX	103458000	K.42	SCZ 3.81/08/180G SN OR BX	196960000	K.44
SC-SMT 3.81/09/90G 1.5SN BK RL	186321000	K.9	SCD-THR 3.81/16/90G 3.2SN BK BX	197379000	K.16	SCDV 3.81/22/90F 3.2SN OR BX	103267000	K.41	SCZ 3.81/08/180GZ SN OR BX	123704000	K.46
SC-SMT 3.81/09/90G 3.2SN BK BX	186254000	K.8	SCD-THR 3.81/18/180F 3.2SN BK BX	103156000	K.19	SCDV 3.81/22/90G 3.2SN OR BX	103219000	K.40	SCZ 3.81/08/180L SN OR BX	244413000	K.45
SC-SMT 3.81/09/90LF 1.5SN BK RL	186377000	K.9	SCD-THR 3.81/18/180G 3.2SN BK BX	103103000	K.18	SCDV 3.81/24/180F 3.2SN OR BX	103509000	K.42	SCZ 3.81/08/180LZ SN OR BX	244426000	K.47
SC-SMT 3.81/09/90LF 3.2SN BK BX	186328000	K.10	SCD-THR 3.81/18/90F 3.2SN BK BX	197425000	K.17	SCDV 3.81/24/180G 3.2SN OR BX	103459000	K.43	SCZ 3.81/08/180L SN OR BX	197099000	K.45
SC-SMT 3.81/10/135G 3.2SN BK BX	197816000	K.12	SCD-THR 3.81/18/90G 3.2SN BK BX	197380000	K.16	SCDV 3.81/24/90F 3.2SN OR BX	103268000	K.41	SCZ 3.81/08/180FZ SN OR BX	123761000	K.47
SC-SMT 3.81/10/135LF 3.2SN BK BX	186435000	K.11	SCD-THR 3.81/18/90G 3.2SN BK BX	103157000	K.19	SCDV 3.81/24/90G 3.2SN OR BX	103220000	K.40	SCZ 3.81/08/180GZ SN OR BX	123716000	K.47
SC-SMT 3.81/10/180G 3.2SN BK BX	186329000	K.10	SCD-THR 3.81/20/180F 3.2SN BK BX	103158000	K.18	SCDV 3.81/24/180G 3.2SN BK BX	103509000	K.25	SCZ 3.81/08/180L SN OR BX	196963000	K.44
SC-SMT 3.81/10/180G 3.2SN BK BX	186338000	K.10	SCD-THR 3.81/20/180G 3.2SN BK BX	103104000	K.19	SCDV 3.81/04/180G 3.2SN BK BX	103547000	K.24	SCZ 3.81/08/180LZ SN OR BX	244414000	K.45
SC-SMT 3.81/10/270F 3.2SN BK BX	103708000	K.15	SCD-THR 3.81/20/90F 3.2SN BK BX	197429000	K.17	SCDV 3.81/04/180G 3.2SN BK BX	103547000	K.24	SCZ 3.81/09/180F SN OR BX	197037000	K.45
SC-SMT 3.81/10/270G 3.2SN BK BX	103657000	K.14	SCD-THR 3.81/20/90G 3.2SN BK BX	197381000	K.16	SCDV 3.81/04/90F 3.2SN BK BX	103397000	K.23	SCZ 3.81/09/180FZ SN OR BX	123704000	K.46
SC-SMT 3.81/10/270G 3.2SN BK BX	103657000	K.14	SCD-THR 3.81/22/180F 3.2SN BK BX	103159000	K.19	SCDV 3.81/04/90G 3.2SN BK BX	103394000	K.22	SCZ 3.81/09/180L SN OR BX	244423000	K.47
SC-SMT 3.81/10/90G 1.5SN BK RL	186322000	K.9	SCD-THR 3.81/22/180G 3.2SN BK BX	103105000	K.18	SCDV 3.81/06/180F 3.2SN BK BX	103596000	K.25	SCZ 3.81/09/180LZ SN OR BX	244420000	K.47
SC-SMT 3.81/10/90G 3.2SN BK BX	186255000	K.8	SCD-THR 3.81/22/90F 3.2SN BK BX	197431000	K.17	SCDV 3.81/06/180G 3.2SN BK BX	103548000	K.24	SCZ 3.81/09/180G SN OR BX	197010000	K.45
SC-SMT 3.81/10/90LF 1.5SN BK RL	186378000	K.9	SCD-THR 3.81/22/90G 3.2SN BK BX	197382000	K.16	SCDV 3.81/06/90F 3.2SN BK BX	103398000	K.23	SCZ 3.81/10/180FZ SN OR BX	123762000	K.47
SC-SMT 3.81/10/90LF 3.2SN BK BX	186329000	K.10	SCD-THR 3.81/24/180F 3.2SN BK BX	103161000	K.19	SCDV 3.81/06/90G 3.2SN BK BX	103351000	K.22	SCZ 3.81/10/180GZ SN OR BX	123720000	K.47
SC-SMT 3.81/11/135G 3.2SN BK BX	197772000	K.12	SCD-THR 3.81/24/180G 3.2SN BK BX	103106000	K.18	SCDV 3.81/08/180F 3.2SN BK BX	103597000	K.25	SCZ 3.81/10/180G SN OR BX	196964000	K.44
SC-SMT 3.81/11/135LF 3.2SN BK BX	197817000	K.13	SCD-THR 3.81/24/90F 3.2SN BK BX	197433000	K.17						

Type	Order No.	Page
SL-SMT 5.08HC/03/180LF 1.5SN BK RL	1776374001	L61
SL-SMT 5.08HC/03/180LF 3.2SN BK BX	1838450000	L60
SL-SMT 5.08HC/03/270FH 1.5SN BK RL	1876930000	L65
SL-SMT 5.08HC/03/270FH 3.2SN BK BX	1877210000	L66
SL-SMT 5.08HC/03/270LF 1.5SN BK RL	1877000000	L64
SL-SMT 5.08HC/03/270LF 3.2SN BK BX	1876860000	L65
SL-SMT 5.08HC/03/270GH 1.5SN BK RL	1877600000	L63
SL-SMT 5.08HC/03/270GH 3.2SN BK BX	1877380000	L63
SL-SMT 5.08HC/03/270GL 1.5SN BK RL	1877500000	L63
SL-SMT 5.08HC/03/270GL 3.2SN BK BX	1877490000	L62
SL-SMT 5.08HC/03/90 1.5SN BK RL	1821170000	L51
SL-SMT 5.08HC/03/90 3.2SN BK BX	1779960000	L50
SL-SMT 5.08HC/03/90F 3.2SN BK BX	1837640000	L52
SL-SMT 5.08HC/03/90G 1.5SN BK RL	1775014001	L51
SL-SMT 5.08HC/03/90G 3.2SN BK BX	1780190000	L51
SL-SMT 5.08HC/03/90LF 1.5SN BK RL	1775244001	L55
SL-SMT 5.08HC/03/90LF 3.2SN BK BX	1780420000	L54
SL-SMT 5.08HC/04/180 1.5SN BK RL	1775594001	L57
SL-SMT 5.08HC/04/180 3.2SN BK BX	1838000000	L56
SL-SMT 5.08HC/04/180G 1.5SN BK RL	1837870000	L58
SL-SMT 5.08HC/04/180G 3.2SN BK BX	1775944001	L57
SL-SMT 5.08HC/04/180G 3.2SN BK BX	1838230000	L57
SL-SMT 5.08HC/04/180LF 1.5SN BK RL	1776384001	L61
SL-SMT 5.08HC/04/180LF 3.2SN BK BX	1838460000	L60
SL-SMT 5.08HC/04/270FH 1.5SN BK RL	1876940000	L65
SL-SMT 5.08HC/04/270FH 3.2SN BK BX	1877330000	L66
SL-SMT 5.08HC/04/270FL 1.5SN BK RL	1877020000	L64
SL-SMT 5.08HC/04/270FL 3.2SN BK BX	1876870000	L65
SL-SMT 5.08HC/04/270GH 1.5SN BK RL	1877610000	L63
SL-SMT 5.08HC/04/270GH 3.2SN BK BX	1877390000	L63
SL-SMT 5.08HC/04/270GL 1.5SN BK RL	1877760000	L63
SL-SMT 5.08HC/04/270GL 3.2SN BK BX	1877510000	L62
SL-SMT 5.08HC/04/90 1.5SN BK RL	1774784001	L51
SL-SMT 5.08HC/04/90 3.2SN BK BX	1779700000	L50
SL-SMT 5.08HC/04/90F 3.2SN BK BX	1837650000	L52
SL-SMT 5.08HC/04/90G 1.5SN BK RL	1775024001	L51
SL-SMT 5.08HC/04/90G 3.2SN BK BX	1780220000	L51
SL-SMT 5.08HC/04/90LF 1.5SN BK RL	1775254001	L55
SL-SMT 5.08HC/04/90LF 3.2SN BK BX	1780430000	L54
SL-SMT 5.08HC/04/90L 3.2SN BK BX	1780430000	L54
SL-SMT 5.08HC/05/180 1.5SN BK RL	1775634001	L57
SL-SMT 5.08HC/05/180 3.2SN BK BX	1838010000	L56
SL-SMT 5.08HC/05/180G 1.5SN BK RL	1838070000	L58
SL-SMT 5.08HC/05/180G 3.2SN BK BX	1837920000	L57
SL-SMT 5.08HC/05/180LF 1.5SN BK RL	1838070000	L58
SL-SMT 5.08HC/05/180LF 3.2SN BK BX	1838050000	L57
SL-SMT 5.08HC/05/180G 1.5SN BK RL	1775954001	L57
SL-SMT 5.08HC/05/180G 3.2SN BK BX	1838240000	L57
SL-SMT 5.08HC/05/180LF 1.5SN BK RL	1776394001	L61
SL-SMT 5.08HC/05/180LF 3.2SN BK BX	1838470000	L60
SL-SMT 5.08HC/05/270FH 1.5SN BK RL	1876950000	L65
SL-SMT 5.08HC/05/270FH 3.2SN BK BX	1877430000	L66
SL-SMT 5.08HC/05/270FL 1.5SN BK RL	1877070000	L65
SL-SMT 5.08HC/05/270FL 3.2SN BK BX	1877080000	L64
SL-SMT 5.08HC/05/270GH 1.5SN BK RL	1876860000	L64
SL-SMT 5.08HC/05/270GH 3.2SN BK BX	1877620000	L63
SL-SMT 5.08HC/05/270GL 1.5SN BK RL	1877400000	L63
SL-SMT 5.08HC/05/270GL 3.2SN BK BX	1877700000	L62
SL-SMT 5.08HC/05/90 1.5SN BK RL	1774794001	L51
SL-SMT 5.08HC/05/90 3.2SN BK BX	1779980000	L50
SL-SMT 5.08HC/05/90F 3.2SN BK BX	1837600000	L52
SL-SMT 5.08HC/05/90G 1.5SN BK RL	1775034001	L51
SL-SMT 5.08HC/05/90G 3.2SN BK BX	1780210000	L51
SL-SMT 5.08HC/05/90LF 1.5SN BK RL	1775264001	L55
SL-SMT 5.08HC/05/90LF 3.2SN BK BX	1780440000	L54
SL-SMT 5.08HC/06/180 1.5SN BK RL	1775644001	L57
SL-SMT 5.08HC/06/180 3.2SN BK BX	1838020000	L56
SL-SMT 5.08HC/06/180G 1.5SN BK RL	1820610000	L58
SL-SMT 5.08HC/06/180G 3.2SN BK BX	1775964001	L57
SL-SMT 5.08HC/06/180LF 1.5SN BK RL	1776404001	L61
SL-SMT 5.08HC/06/180LF 3.2SN BK BX	1838480000	L60
SL-SMT 5.08HC/06/270FH 1.5SN BK RL	1876960000	L65
SL-SMT 5.08HC/06/270FH 3.2SN BK BX	1877090000	L66
SL-SMT 5.08HC/06/270FL 1.5SN BK RL	1876890000	L64
SL-SMT 5.08HC/06/270FL 3.2SN BK BX	1877630000	L63
SL-SMT 5.08HC/06/270GH 1.5SN BK RL	1877410000	L63
SL-SMT 5.08HC/06/270GH 3.2SN BK BX	1877780000	L63
SL-SMT 5.08HC/06/270GL 1.5SN BK RL	1877530000	L62
SL-SMT 5.08HC/06/270GL 3.2SN BK BX	1877590000	L62
SL-SMT 5.08HC/06/90 1.5SN BK RL	1774840001	L51
SL-SMT 5.08HC/06/90 3.2SN BK BX	1779990000	L50
SL-SMT 5.08HC/06/90F 3.2SN BK BX	1837670000	L52
SL-SMT 5.08HC/06/90G 1.5SN BK RL	1775044001	L51
SL-SMT 5.08HC/06/90G 3.2SN BK BX	1780220000	L51
SL-SMT 5.08HC/06/90LF 1.5SN BK RL	1775274001	L55
SL-SMT 5.08HC/06/90LF 3.2SN BK BX	1780230000	L54
SL-SMT 5.08HC/07/180 1.5SN BK RL	1775654001	L57
SL-SMT 5.08HC/07/180 3.2SN BK BX	1838030000	L56
SL-SMT 5.08HC/07/180F 3.2SN BK BX	1837880000	L58
SL-SMT 5.08HC/07/180G 1.5SN BK RL	1775974001	L57
SL-SMT 5.08HC/07/180G 3.2SN BK BX	1838260000	L57
SL-SMT 5.08HC/07/180LF 3.2SN BK BX	1838490000	L60
SL-SMT 5.08HC/07/180LF 3.2SN BK BX	1876970000	L65
SL-SMT 5.08HC/07/270FH 3.2SN BK BX	1877480000	L65
SL-SMT 5.08HC/07/270FL 1.5SN BK RL	1877110000	L64
SL-SMT 5.08HC/07/270FL 3.2SN BK BX	1877100000	L65
SL-SMT 5.08HC/07/270GH 1.5SN BK RL	1877400000	L63
SL-SMT 5.08HC/07/270GH 3.2SN BK BX	1877420000	L63
SL-SMT 5.08HC/07/270GL 1.5SN BK RL	1877790000	L62
SL-SMT 5.08HC/07/270GL 3.2SN BK BX	1877540000	L63
SL-SMT 5.08HC/07/90 1.5SN BK RL	1774814001	L51
SL-SMT 5.08HC/07/90 3.2SN BK BX	1780000000	L50

Type	Order No.	Page
SL-SMT 5.08HC/07/90F 3.2SN BK BX	1837680000	L52
SL-SMT 5.08HC/07/90G 1.5SN BK RL	1775054001	L51
SL-SMT 5.08HC/07/90G 3.2SN BK BX	1780230000	L51
SL-SMT 5.08HC/08/180F 3.2SN BK BX	1780460000	L54
SL-SMT 5.08HC/08/180 1.5SN BK RL	1775664001	L57
SL-SMT 5.08HC/08/180 3.2SN BK BX	1838040000	L56
SL-SMT 5.08HC/08/180F 3.2SN BK BX	1820620000	L58
SL-SMT 5.08HC/08/180G 1.5SN BK RL	1838270000	L57
SL-SMT 5.08HC/08/180G 3.2SN BK BX	1838500000	L60
SL-SMT 5.08HC/08/270FH 1.5SN BK RL	1876980000	L65
SL-SMT 5.08HC/08/270FH 3.2SN BK BX	1877500000	L65
SL-SMT 5.08HC/08/270FL 1.5SN BK RL	1877120000	L64
SL-SMT 5.08HC/08/270FL 3.2SN BK BX	1876910000	L65
SL-SMT 5.08HC/08/270GH 1.5SN BK RL	1877650000	L63
SL-SMT 5.08HC/08/270GH 3.2SN BK BX	1877450000	L63
SL-SMT 5.08HC/08/270GL 1.5SN BK RL	1877800000	L63
SL-SMT 5.08HC/08/270GL 3.2SN BK BX	1877550000	L62
SL-SMT 5.08HC/08/90 1.5SN BK RL	1774824001	L51
SL-SMT 5.08HC/08/90 3.2SN BK BX	1780010000	L50
SL-SMT 5.08HC/08/90F 3.2SN BK BX	1837690000	L52
SL-SMT 5.08HC/08/90G 3.2SN BK BX	1780240000	L51
SL-SMT 5.08HC/08/90LF 3.2SN BK BX	1780470000	L54
SL-SMT 5.08HC/08/90L 3.2SN BK BX	1838050000	L56
SL-SMT 5.08HC/08/180F 3.2SN BK BX	1837890000	L57
SL-SMT 5.08HC/08/180G 3.2SN BK BX	1838280000	L58
SL-SMT 5.08HC/08/180LF 3.2SN BK BX	1838510000	L60
SL-SMT 5.08HC/08/90 3.2SN BK BX	1780200000	L50
SL-SMT 5.08HC/09/90F 3.2SN BK BX	1837700000	L52
SL-SMT 5.08HC/09/90G 3.2SN BK BX	1780250000	L51
SL-SMT 5.08HC/09/180F 3.2SN BK BX	1780480000	L54
SL-SMT 5.08HC/10/180 3.2SN BK BX	1838060000	L56
SL-SMT 5.08HC/10/180F 3.2SN BK BX	1827080000	L58
SL-SMT 5.08HC/10/180G 3.2SN BK BX	1838290000	L57
SL-SMT 5.08HC/10/180LF 3.2SN BK BX	1838520000	L60
SL-SMT 5.08HC/10/90 3.2SN BK BX	1780030000	L50
SL-SMT 5.08HC/10/90F 3.2SN BK BX	1837710000	L52
SL-SMT 5.08HC/10/90G 3.2SN BK BX	1780260000	L51
SL-SMT 5.08HC/10/90LF 3.2SN BK BX	1780490000	L54
SL-SMT 5.08HC/11/180 3.2SN BK BX	1838070000	L58
SL-SMT 5.08HC/11/180F 3.2SN BK BX	1837900000	L56
SL-SMT 5.08HC/11/180G 3.2SN BK BX	1838080000	L57
SL-SMT 5.08HC/11/180LF 3.2SN BK BX	1838530000	L60
SL-SMT 5.08HC/11/90 3.2SN BK BX	1780040000	L50
SL-SMT 5.08HC/11/90F 3.2SN BK BX	1837720000	L52
SL-SMT 5.08HC/11/90G 3.2SN BK BX	1780270000	L51
SL-SMT 5.08HC/11/90LF 3.2SN BK BX	1780500000	L54
SL-SMT 5.08HC/12/180 3.2SN BK BX	1838080000	L56
SL-SMT 5.08HC/12/180F 3.2SN BK BX	1820630000	L58
SL-SMT 5.08HC/12/180G 3.2SN BK BX	1838310000	L57
SL-SMT 5.08HC/12/180LF 3.2SN BK BX	1838540000	L60
SL-SMT 5.08HC/12/90 3.2SN BK BX	1780050000	L50
SL-SMT 5.08HC/12/90F 3.2SN BK BX	1837730000	L52
SL-SMT 5.08HC/12/90G 3.2SN BK BX	1780280000	L51
SL-SMT 5.08HC/12/90LF 3.2SN BK BX	1780510000	L54
SLA BB11R DR	1604120000	L32
SLA BB11R DR	1604120000	L34
SLA BB11R DR	1604120000	L36
SLA BB11R DR	1604120000	L72
SLA BB11R DR	1604120000	L70
SLA BB11R DR	1604120000	L118
SLA BB11R DR	1604120000	L120
SLA BB11R DR	1604120000	N.6
SLA BB11R SW	1692340000	L32
SLA BB11R SW	1692340000	L34
SLA BB11R SW	1692340000	L36
SLA BB11R SW	1692340000	L72
SLA BB11R SW	1692340000	L70
SLA BB11R SW	1692340000	L118
SLA BB11R SW	1692340000	L120
SLA BB11R SW	1692340000	N.6
SLA BB12R DR	1593450000	N.6
SLA BB12R SW	1626880000	N.6
SLA BB14 DR	1594200000	L76
SLA BB14 DR	1594200000	N.7
SLA BB14 SW	1774460000	N.7
SLA BB14 SW	1774460000	L76
SLA BB1R DR	1723430000	N.6
SLA BB1R SW	1723480000	N.6
SLA BB2R DR	1723440000	N.6
SLA BB2R SW	1723490000	N.6
SLA BB4 DR	1571720000	L92
SLA BB4 DR	1571720000	L93
SLA BB8 RH DR	1446060000	L92
SLA BB8 RH DR	1446060000	L93
SLD 3.50 V/04/180F 3.2 SN DR BX	1641240000	J47
SLD 3.50 V/04/90F 3.2 SN DR BX	1642370000	J45
SLD 3.50 V/06/180F 3.2 SN DR BX	1691060000	J47
SLD 3.50 V/08/180F 3.2 SN DR BX	1641250000	J47
SLD 3.50 V/08/90F 3.2 SN DR BX	1642380000	J45
SLD 3.50 V/10/180F 3.2 SN DR BX	1891070000	J47
SLD 3.50 V/12/180F 3.2 SN DR BX	1641260000	J47
SLD 3.50 V/12/90F 3.2 SN DR BX	1642390000	J45
SLD 3.50 V/14/180F 3.2 SN DR BX	1891080000	J47
SLD 3.50 V/16/180F 3.2 SN DR BX	1641270000	J47
SLD 3.50 V/16/90F 3.2 SN DR BX	1642400000	J45
SLD 3.50 V/18/180F 3.2 SN DR BX	1891090000	J47
SLD 3.50 V/20/180F 3.2 SN DR BX	1641280000	J47
SLD 3.50 V/20/90F 3.2 SN DR BX	1642410000	J45
SLD 3.50 V/22/180F 3.2 SN DR BX	1891100000	J47

Type	Order No.	Page
SLD 3.50 V/24/180F 3.2 SN DR BX	1641290000	J47
SLD 3.50 V/24/90F 3.2 SN DR BX	1642420000	J45
SLD 3.50 V/04/90F 3.2SN DR BX	1633810000	J43
SLD 3.50 V/04/90G 3.2SN DR BX	1633580000	J42
SLD 3.50 V/06/90F 3.2SN DR BX	1633820000	J43
SLD 3.50 V/06/90G 3.2SN DR BX	1633590000	J42
SLD 3.50 V/08/90F 3.2SN DR BX	1633830000	J43
SLD 3.50 V/08/90G 3.2SN DR BX	1633600000	J42
SLD 3.50 V/10/90F 3.2SN DR BX	1633840000	J43
SLD 3.50 V/10/90G 3.2SN DR BX	1633610000	J42
SLD 3.50 V/12/90F 3.2SN DR BX	1633850000	J43
SLD 3.50 V/12/90G 3.2SN DR BX	1633620000	J42
SLD 3.50 V/14/90F 3.2SN DR BX	1633860000	J43
SLD 3.50 V/14/90G 3.2SN DR BX	1633630000	J42
SLD 3.50 V/16/90F 3.2SN DR BX	1633870000	J43
SLD 3.50 V/16/90G 3.2SN DR BX	1633640000	J42
SLD 3.50 V/18/90F 3.2SN DR BX	1633880000	J43
SLD 3.50 V/18/90G 3.2SN DR BX	1633650000	J42
SLD 3.50 V/20/90F 3.2SN DR BX	1633890000	J43
SLD 3.50 V/20/90G 3.2SN DR BX	1633660000	J42
SLD 3.50 V/22/90F 3.2SN DR BX	1633900000	J43
SLD 3.50 V/22/90G 3.2SN DR BX	1633670000	J42
SLD 3.50 V/24/90F 3.2SN DR BX	1633910000	J43
SLD 3.50 V/24/90G 3.2SN DR BX	1633680000	J42
SLD 3.50 V/04/180G 3.2SN DR BX	1641110000	J46
SLD 3.50 V/04/90G 3.2SN DR BX	1642240000	J44
SLD 3.50 V/06/180G 3.2SN DR BX	1891190000	J46
SLD 3.50 V/06/9		

Type	Order No.	Page	Type	Order No.	Page	Type	Order No.	Page	Type	Order No.	Page
SLS 5.08/03/180 SN DR BX	1335340000	L94	SLS 5.08/07/180FI SN DR BX	1846260000	L91	SU 10.16HP/05/270F 3.5AG BK BX	1813760000	P227	SV 7.62HP/02/90MF2 SC/08R SN BK BX	1156820000	P24
SLS 5.08/03/180B SN DR BX	1335450000	L95	SLS 5.08/08/180 SN DR BX	1627150000	L90	SU 10.16HP/05/270G 3.5AG BK BX	1813520000	P226	SV 7.62HP/02/90MSF2 SC/04R SN BK BX	1089510000	P26
SLS 5.08/03/180DF SN DR BX	1335390000	L84	SLS 5.08/08/180B SN DR BX	1627300000	L91	SU 10.16HP/05/270MF2 3.5AG BK BX	2597290000	P228	SV 7.62HP/02/90MSF2 SC/06R SN BK BX	1089570000	P26
SLS 5.08/03/180F SN DR BX	1335620000	L94	SLS 5.08/08/180DF SN DR BX	1335340000	L82	SU 10.16HP/05/270MF3 3.5AG BK BX	2597310000	P229	SV 7.62HP/02/90MSF2 SC/08R SN BK BX	1156830000	P26
SLS 5.08/03/180FI SN DR BX	1336410000	L95	SLS 5.08/08/180F SN DR BX	1846240000	L91	SU 10.16HP/05/270MF4 3.5AG BK BX	2597330000	P229	SV 7.62HP/02/90SF 3.5SN BK BX	1930490000	P159
SLS 5.08/04/180 SN DR BX	1335350000	L94	SLS 5.08/08/180FI SN DR BX	1846270000	L91	SU 10.16HP/05/270SF 3.5AG BK BX	1851150000	P227	SV 7.62HP/03/180F 3.5SN BK BX	1930720000	P163
SLS 5.08/04/180B SN DR BX	1335460000	L95	SLS 5.08/08/180TB KF SN DR BX	1846150000	L93	SU 10.16HP/05/90F 3.5AG BK BX	1813600000	P221	SV 7.62HP/03/180G 3.5SN BK BX	1930610000	P162
SLS 5.08/04/180DF SN DR BX	1335600000	L84	SLS 5.08/08/180TB RF15 SN DR BX	1846070000	L92	SU 10.16HP/05/90G 3.5AG BK BX	1813360000	P220	SV 7.62HP/03/180MF2 3.5SN BK BX	1048410000	P164
SLS 5.08/04/180F SN DR BX	1335640000	L95	SLS 5.08/09/180 SN DR BX	1627160000	L90	SU 10.16HP/05/90MF2 3.5AG BK BX	2597200000	P222	SV 7.62HP/03/180MF3 3.5SN BK BX	1048420000	P165
SLS 5.08/04/180FI SN DR BX	1336420000	L95	SLS 5.08/09/180B SN DR BX	1627310000	L91	SU 10.16HP/05/90MF3 3.5AG BK BX	2597220000	P223	SV 7.62HP/03/180SF 3.5SN BK BX	1930830000	P163
SLS 5.08/05/180 SN DR BX	1335360000	L94	SLS 5.08/09/180DF SN DR BX	1335350000	L82	SU 10.16HP/05/90MF4 3.5AG BK BX	2597240000	P223	SV 7.62HP/03/270F 3.5SN BK BX	1931380000	P167
SLS 5.08/05/180B SN DR BX	1335470000	L95	SLS 5.08/09/180F SN DR BX	1846430000	L91	SU 10.16HP/05/90SF 3.5AG BK BX	1851070000	P221	SV 7.62HP/03/270G 3.5SN BK BX	1931270000	P166
SLS 5.08/05/180DF SN DR BX	1335620000	L84	SLS 5.08/09/180FI SN DR BX	1846280000	L91	SU 10.16HP/06/180F 3.5AG BK BX	1813690000	P224	SV 7.62HP/03/270G SC/04R SN BK BX	1090950000	P28
SLS 5.08/05/180F SN DR BX	1335660000	L95	SLS 5.08/10/180 SN DR BX	1627170000	L90	SU 10.16HP/06/180G 3.5AG BK BX	1813450000	P225	SV 7.62HP/03/270G SC/06R SN BK BX	1091010000	P28
SLS 5.08/05/180FI SN DR BX	1336430000	L95	SLS 5.08/10/180B SN DR BX	1627320000	L91	SU 10.16HP/06/180SF 3.5AG BK BX	1850920000	P225	SV 7.62HP/03/270G SC/08R SN BK BX	1156940000	P28
SLS 5.08/06/180 SN DR BX	1335370000	L94	SLS 5.08/10/180DF SN DR BX	1335370000	L82	SU 10.16HP/06/270F 3.5AG BK BX	1813770000	P227	SV 7.62HP/03/270MF2 3.5SN BK BX	1048450000	P168
SLS 5.08/06/180B SN DR BX	1335480000	L95	SLS 5.08/10/180F SN DR BX	1846440000	L91	SU 10.16HP/06/270G 3.5AG BK BX	1813530000	P226	SV 7.62HP/03/270MF2 SC/04R SN BK BX	1156140000	P30
SLS 5.08/06/180DF SN DR BX	1335630000	L84	SLS 5.08/10/180FI SN DR BX	1846290000	L91	SU 10.16HP/06/270MF2 3.5AG BK BX	2597300000	P228	SV 7.62HP/03/270MF2 SC/06R SN BK BX	1156150000	P30
SLS 5.08/06/180F SN DR BX	1335680000	L95	SLS 5.08/10/180TB KF SN DR BX	1846160000	L93	SU 10.16HP/06/270MF3 3.5AG BK BX	2597320000	P229	SV 7.62HP/03/270MF2 SC/08R SN BK BX	1156170000	P31
SLS 5.08/06/180FI SN DR BX	1336440000	L95	SLS 5.08/10/180TB RF15 SN DR BX	1846080000	L92	SU 10.16HP/06/270MF4 3.5AG BK BX	2597340000	P229	SV 7.62HP/03/270MF3 3.5SN BK BX	1048460000	P169
SLS 5.08/07/180 SN DR BX	1335380000	L94	SLS 5.08/11/180 SN DR BX	1627180000	L90	SU 10.16HP/06/270SF 3.5AG BK BX	1851160000	P227	SV 7.62HP/03/270MF3 SC/04R SN BK BX	1089440000	P31
SLS 5.08/07/180B SN DR BX	1335490000	L95	SLS 5.08/11/180B SN DR BX	1627330000	L91	SU 10.16HP/06/90F 3.5AG BK BX	1813610000	P221	SV 7.62HP/03/270MF3 SC/06R SN BK BX	1089490000	P31
SLS 5.08/07/180DF SN DR BX	1335630000	L84	SLS 5.08/11/180DF SN DR BX	1846450000	L91	SU 10.16HP/06/90G 3.5AG BK BX	1813370000	P220	SV 7.62HP/03/270MF3 SC/08R SN BK BX	1156180000	P31
SLS 5.08/07/180F SN DR BX	1335700000	L95	SLS 5.08/11/180FI SN DR BX	1846300000	L91	SU 10.16HP/06/90MF2 3.5AG BK BX	2597210000	P222	SV 7.62HP/03/270MF3 SC/04R SN BK BX	1156190000	P32
SLS 5.08/07/180FI SN DR BX	1336450000	L95	SLS 5.08/12/180 SN DR BX	1627190000	L90	SU 10.16HP/06/90MF3 3.5AG BK BX	2597230000	P222	SV 7.62HP/03/270MF3 SC/06R SN BK BX	1156200000	P32
SLS 5.08/08/180 SN DR BX	1335390000	L94	SLS 5.08/12/180B SN DR BX	1627340000	L91	SU 10.16HP/06/90MF4 3.5AG BK BX	2597250000	P223	SV 7.62HP/03/270MF3 SC/08R SN BK BX	1156210000	P32
SLS 5.08/08/180B SN DR BX	1335510000	L95	SLS 5.08/12/180DF SN DR BX	1846460000	L91	SU 10.16HP/06/90SF 3.5AG BK BX	1851080000	P221	SV 7.62HP/03/270MF3 SC/04R SN BK BX	1089610000	P33
SLS 5.08/08/180DF SN DR BX	1335650000	L84	SLS 5.08/12/180F SN DR BX	1846310000	L91	SU 10.16HP/06/90SF 3.5AG BK BX	1813700000	P225	SV 7.62HP/03/270MF3 SC/06R SN BK BX	1089670000	P33
SLS 5.08/08/180F SN DR BX	1335720000	L95	SLS 5.08/12/180TB KF SN DR BX	1846170000	L93	SU 10.16HP/07/180G 3.5AG BK BX	1813460000	P224	SV 7.62HP/03/270MF3 SC/08R SN BK BX	1156220000	P33
SLS 5.08/08/180FI SN DR BX	1336470000	L95	SLS 5.08/12/180TB RF15 SN DR BX	1846090000	L92	SU 10.16HP/07/180SF 3.5AG BK BX	1850930000	P225	SV 7.62HP/03/270SF 3.5SN BK BX	1931490000	P167
SLS 5.08/09/180 SN DR BX	1335400000	L94	SMSE 1 MSD ZB	4060540000	T44	SU 10.16HP/07/270F 3.5AG BK BX	1813780000	P227	SV 7.62HP/03/90F 3.5SN BK BX	1930390000	P159
SLS 5.08/09/180B SN DR BX	1335520000	L95	SMSE FE MCZ 1.5/PE	1003280000	T45	SU 10.16HP/07/270G 3.5AG BK BX	1813540000	P226	SV 7.62HP/03/90G 3.5SN BK BX	1930280000	P158
SLS 5.08/09/180DF SN DR BX	1335670000	L84	SMSE FE MSA	2279350000	T44	SU 10.16HP/07/270SF 3.5AG BK BX	1851170000	P227	SV 7.62HP/03/90G SC/04R SN BK BX	1090400000	P22
SLS 5.08/09/180F SN DR BX	1335740000	L95	SMSE KU FE MCZ 1.5	2242390000	T45	SU 10.16HP/07/90F 3.5AG BK BX	1813620000	P221	SV 7.62HP/03/90G SC/06R SN BK BX	1090120000	P22
SLS 5.08/09/180FI SN DR BX	1336480000	L95	SMSE LN FE MCZ 1.5	2242380000	T45	SU 10.16HP/07/90G 3.5AG BK BX	1813380000	P220	SV 7.62HP/03/90G SC/08R SN BK BX	1157050000	P22
SLS 5.08/10/180 SN DR BX	1335410000	L94	SMSE MSA ZB	4286620000	T44	SU 10.16HP/07/90SF 3.5AG BK BX	1851090000	P221	SV 7.62HP/03/90MF2 3.5SN BK BX	1048490000	P161
SLS 5.08/10/180B SN DR BX	1335530000	L95	SMSE ZF MSD	2277000000	T44	SU 10.16HP/08/180F 3.5AG BK BX	1813710000	P225	SV 7.62HP/03/90MF2 SC/04R SN BK BX	1156230000	P24
SLS 5.08/10/180DF SN DR BX	1335680000	L84	SR-SMD 4.50/05/90 AU BK BX	1155840000	T38	SU 10.16HP/08/180G 3.5AG BK BX	1813470000	P224	SV 7.62HP/03/90MF2 SC/06R SN BK BX	1156240000	P24
SLS 5.08/10/180F SN DR BX	1335760000	L95	SR-SMD 4.50/05/90 AU BK RL	1155850000	T38	SU 10.16HP/08/180SF 3.5AG BK BX	1850940000	P225	SV 7.62HP/03/90MF2 SC/08R SN BK BX	1156840000	P24
SLS 5.08/10/180FI SN DR BX	1336490000	L95	SR-SMD 4.50/05/90LF 1.5AU BK BX	1155890000	T39	SU 10.16HP/08/270F 3.5AG BK BX	1813790000	P227	SV 7.62HP/03/90MF3 3.5SN BK BX	1048500000	P160
SLS 5.08/11/180 SN DR BX	1335420000	L94	SR-SMD 4.50/05/90LF 1.5AU BK RL	1155900000	T39	SU 10.16HP/08/270G 3.5AG BK BX	1813550000	P226	SV 7.62HP/03/90MF3 SC/04R SN BK BX	1089660000	P25
SLS 5.08/11/180B SN DR BX	1335540000	L95	SR-SMD 4.50/05/90LFM 3.2AU BK BX	1155870000	T39	SU 10.16HP/08/270SF 3.5AG BK BX	1851180000	P227	SV 7.62HP/03/90MF3 SC/06R SN BK BX	1089730000	P25
SLS 5.08/11/180DF SN DR BX	1335780000	L95	SR-SMD 4.50/05/90LFM 3.2AU BK RL	1155880000	T39	SU 10.16HP/08/90F 3.5AG BK BX	1813630000	P221	SV 7.62HP/03/90MF3 SC/08R SN BK BX	1156850000	P25
SLS 5.08/11/180F SN DR BX	1335800000	L95	SU 10.16 BFSC P 35X 14	2812340000	P80	SU 10.16HP/08/90G 3.5AG BK BX	1813390000	P221	SV 7.62HP/03/90MF3 SC/04R SN BK BX	1156250000	P26
SLS 5.08/11/180FI SN DR BX	1336500000	L95	SU 10.16 BFSC P 35X 14	2812340000	P80	SU 10.16HP/08/90SF 3.5AG BK BX	1851100000	P221	SV 7.62HP/03/90MSF2 SC/06R SN BK BX	1156270000	P26
SLS 5.08/12/180 SN DR BX	1335550000	L94	SU 10.16 BFSC P 35X 14	2812340000	P80	SU 10.16HP/09/180F 3.5AG BK BX	1813720000	P225	SV 7.62HP/03/90MSF2 SC/08R SN BK BX	1156870000	P26
SLS 5.08/12/180B SN DR BX	1335600000	L95	SU 10.16 BFSC P 35X 14	2812340000	P80	SU 10.16HP/09/180G 3.5AG BK BX	1813480000	P224	SV 7.62HP/03/90MSF2 SC/04R SN BK BX	1089890000	P27
SLS 5.08/12/180DF SN DR BX	1335720000	L95	SU 10.16 BFSC P 35X 14	2812340000	P80	SU 10.16HP/09/180SF 3.5AG BK BX	1850950000	P225	SV 7.62HP/03/90MSF2 SC/06R SN BK BX	1156900000	P27
SLS 5.08/12/180F SN DR BX	1336520000	L95	SU 10.16 BFSC P 35X 14	2812340000	P80	SU 10.16HP/09/270F 3.5AG BK BX	1813800000	P227	SV 7.62HP/03/90MSF2 SC/08R SN BK BX	1156920000	P27
SLS 5.08/12/180FI SN DR BX	1336560000	L95	SU 10.16 BFSC P 35X 12	2812340000	P80	SU 10.16HP/09/270SF 3.5AG BK BX	1813560000	P226	SV 7.62HP/03/90SF 3.5SN BK BX	1930500000	P159
SLS 5.08/12/180B SN DR BX	1335580000	L95	SU 10.16 BFSC S 35X12	2812290000	P78	SU 10.16HP/09/270SF 3.5AG BK BX	1851190000	P227	SV 7.62HP/04/180F 3.5SN BK BX	1930730000	P163
SLS 5.08/12/180DF SN DR BX	1335700000	L95	SU 10.16 BFSC S 35X12	2812290000	P78	SU 10.16HP/09/90F 3.5AG BK BX	1813640000	P221	SV 7.62HP/04/180G 3.5SN BK BX	1930620000	P162
SLS 5.08/12/180F SN DR BX	1335800000	L95	SU 10.16 BFSC S 35X12	2812290000	P78	SU 10.16HP/09/90G 3.5AG BK BX	1813400000	P220	SV 7.62HP/04/180MF2 3.5SN BK BX	1464310000	P164
SLS 5.08/12/180FI SN DR BX	1336510000	L95	SU 10.16 BFSC S 35X12	2812290000	P78	SU 10.16HP/09/90SF 3.5AG BK BX	1851110000	P221	SV 7.62HP/04/180MF3 3.5SN BK BX	1048350000	P165
SLS 7.62HP/02/180 SN BK BX	1043670000	P129	SU 10.16 BFSC S 35X12	2812290000	P78	SU 10.16HP/09/90SF 3.5AG BK BX	1851110000	P221	SV 7.62HP/04/180MF4 3.5SN BK BX	1464330000	P165
SLS 7.62HP/02/180B SN BK BX	1043690000	P129	SU 10.16 BFSC S 35X12	2812290000	P78	SU 10.18IT/02/270MF2 3.5AG BK BX SO	1157310000	P80	SV 7.62HP/04/180SF 3.5SN BK BX	1930840000	P163
SLS 7.62HP/02/180DF SN BK BX	1043750000	P129	SU 10.16 BFSC S 35X12	2812290000	P78	SU 10.18IT/02/90MF2 3.5AG BK BX SO	1156850000	P78	SV 7.62HP/04/180SF2 3.5SN BK BX	1931390000	P167
SLS 7.62HP/02/180F SN BK BX	1043760000	P128	SU 10.16 BFSC S 35X12	2812290000	P78	SU 10.18IT/03/270MF2 3.5AG BK BX	1157320000	P80	SV 7.62HP/04/270G 3.5SN BK BX	1931280000	P166
SLS 7.62HP/02/180FI SN BK BX	1043770000	P129	SU 10.16 BFSC S 35X12	2812290000	P78	SU 10.18IT/03/270MF3 3.5AG BK BX	1157330000	P81	SV 7.62HP/04/270G SC/08R SN BK BX	19	

Type	Order No.	Page
SVF 7.62HP/04/180SFMF2 SN BK BX	1427250000	P.180
SVF 7.62HP/04/180SFMF3 SN BK BX	1427260000	P.181
SVF 7.62HP/04/180SFMF4 SN BK BX	1427270000	P.181
SVF 7.62HP/05/180F SN BK BX	1060930000	P.173
SVF 7.62HP/05/180FI SN BK BX	1124780000	P.174
SVF 7.62HP/05/180G SN BK BX	1060870000	P.172
SVF 7.62HP/05/180MF2 SN BK BX	1430020000	P.178
SVF 7.62HP/05/180MF3 SN BK BX	1061070000	P.177
SVF 7.62HP/05/180MF4 SN BK BX	1061080000	P.177
SVF 7.62HP/05/180MSF2 SN BK BX	1430070000	P.178
SVF 7.62HP/05/180MSF3 SN BK BX	1061150000	P.179
SVF 7.62HP/05/180MSF4 SN BK BX	1061170000	P.179
SVF 7.62HP/05/180SF SN BK BX	1061000000	P.173
SVF 7.62HP/05/180SFI SN BK BX	1124840000	P.175
SVF 7.62HP/06/180G SN BK BX	1060880000	P.172
SVF 7.62HP/06/180MF4 SN BK BX	1061100000	P.177
SVF 7.62HP/06/180MSF3 SN BK BX	1061180000	P.179
SVF/BVF 7.62HP COUPLE SET	1440850000	P.180
SVF/BVF 7.62HP COUPLE SET	1440850000	P.182
SVF/BVF 7.62HP COUPLE SET	1440850000	P.196
SVF/BVF 7.62HP COUPLE SET	1440850000	P.198
SVF/BVF 7.62HP COUPLE SET	1440850000	P.202
SVF/BVF 7.62HP COUPLE SET	1440850000	S.2
SVFL 7.62HP/02/180MF2 SN BK BX	2630260000	P.186
SVFL 7.62HP/03/180MF2 SN BK BX	2630420000	P.186
SVFL 7.62HP/03/180MF3 SN BK BX	2630450000	P.187
SVFL 7.62HP/04/180F SN BK BX	1547570000	P.185
SVFL 7.62HP/04/180G SN BK BX	1547550000	P.184
SVFL 7.62HP/04/180MF2 SN BK BX	2630430000	P.186
SVFL 7.62HP/04/180MF3 SN BK BX	1547580000	P.187
SVFL 7.62HP/04/180MF4 SN BK BX	2630470000	P.187
SVFL 7.62HP/05/180MF2 SN BK BX	2630440000	P.186
SVFL 7.62HP/05/180MF3 SN BK BX	2630460000	P.187
SVFL 7.62HP/05/180MF4 SN BK BX	2630480000	P.187

T

TOP1.5G5 BB OR	1539860000	N.7
TS 35X15/LL 1M/ST/ZN	0236510000	T.41
TS 35X7.5/LL 1M/ST/ZN	0514510000	T.41

U

USB2.0A RIV 2.5N4 TY BK	2563730000	E.8
USB2.0A S1H 1.4N4 TY BK	2563720000	E.6
USB2.0A T1H 2.5N4 TY BK	2563710000	E.12
USB2.0A T1V 2.5N4 TY BK	1985910000	E.10
USB3.0A RIV 3.0N2 TY BL	1549730000	E.9
USB3.0A T1H 2.3N4 TY BL	2563550000	E.13

V

VDS180 SV7.62	1853940000	P.162
VDS180 SV7.62	1853940000	P.164
VDS180 SV7.62	1853940000	P.208
VDS180 SV7.62	1853940000	P.224
VDS180 SV7.62	1853940000	S.4
VREL PGK4 OR VPE 30	1288610000	R.10
VWVG 4 BK BX	1250650000	R.13
VWVG 4 GN/YE BX	1936480000	R.13
VWVG 4 GY BX	1936490000	R.13
VWVG 6 BK BX	2484810000	R.14
VWVG 6 GN/YE BX	2484880000	R.14
VWVG 6 GY BX	2484800000	R.14

W

WGK 10 BK BX	2439470000	R.16
WGK 10 GN/YE BX	2439380000	R.16
WGK 10 GY BX	2439390000	R.16
WGK 10 VP GN/YE BX	2439430000	R.17
WGK 10 VP GY BX	2439450000	R.17
WGK 10 VP/Z GN/YE BX	2439440000	R.17
WGK 10 VP/Z GY BX	2439420000	R.17
WGK 10/Z BK BX	2439460000	R.16
WGK 10/Z GN/YE BX	2439400000	R.16
WGK 10/Z GY BX	2439410000	R.16
WGK 16 BK BX	2440590000	R.18
WGK 16 GN/YE BX	2439600000	R.18
WGK 16 GY BX	2440560000	R.18
WGK 16 VP BK BX	2440660000	R.19
WGK 16 VP GN/YE BX	2440610000	R.19
WGK 16 VP GY BX	2440620000	R.19
WGK 16 VP/Z BK BX	2440710000	R.19
WGK 16 VP/Z GN/YE BX	2440630000	R.19
WGK 16 VP/Z GY BX	2440640000	R.19
WGK 16/Z BK BX	2440600000	R.18
WGK 16/Z GN/YE BX	2440570000	R.18
WGK 16/Z GY BX	2440580000	R.18
WGK 25 BK BX	2444670000	R.20
WGK 25 GN/YE BX	2444650000	R.20
WGK 25 GY BX	2444660000	R.20
WGK 25 VP BK BX	2444800000	R.21
WGK 25 VP GN/YE BX	2444700000	R.21
WGK 25 VP GY BX	2444710000	R.21
WGK 25 VP/Z BK BX	2444790000	R.21
WGK 25 VP/Z GN/YE BX	2444720000	R.21
WGK 25 VP/Z GY BX	2444730000	R.21
WGK 25/Z BK BX	2444680000	R.20

Type	Order No.	Page
WGK 25/Z GN/YE BX	2444640000	R.20
WGK 25/Z GY BX	2444300000	R.20
WGK 4 BK BX	1250930000	R.12
WGK 4 GN/YE BX	1936540000	R.12
WGK 4 GY BX	1936550000	R.12
WGK 4 VP GN/YE BX	1003890000	R.13
WGK 4 VP GY BX	1981890000	R.13
WGK 4 VP/Z GN/YE BX	1003900000	R.13
WGK 4 VP/Z GY BX	1003910000	R.13
WGK 4/Z BK BX	1250940000	R.12
WGK 4/Z GN/YE BX	1936560000	R.12
WGK 4/Z GY BX	1936570000	R.12
WGK 50 BK BX	2427680000	R.22
WGK 50 GN/YE BX	2427660000	R.22
WGK 50 GY BX	2427640000	R.22
WGK 50 VP BK BX	2428440000	R.23
WGK 50 VP GN/YE BX	2428270000	R.23
WGK 50 VP GY BX	2428280000	R.23
WGK 50 VP/Z GY BX	2428300000	R.23
WGK 50 VP/Z BK BX	2428450000	R.23
WGK 50 VP/Z GN/YE BX	2428290000	R.23
WGK 50/Z BK BX	2427690000	R.22
WGK 50/Z GN/YE BX	2427810000	R.22
WGK 50/Z GY BX	2427650000	R.22
WGK 95 BK BX	1250680000	R.24
WGK 95 GN/YE BX	1937370000	R.24
WGK 95 GY BX	1937380000	R.24
WGK 95/Z BK BX	1250690000	R.24
WGK 95/Z GN/YE BX	1937390000	R.24
WGK 95/Z GY BX	1937400000	R.24
WGK 95F VP BK BX	1250660000	R.25
WGK 95F VP GN/YE BX	1937120000	R.25
WGK 95F VP GY BX	1937130000	R.25
WGK 95F VP/Z BK BX	1250670000	R.25
WGK 95F VP/Z GN/YE BX	1937360000	R.25
WGK 95F VP/Z GY BX	1937140000	R.25
WGKV 10 BK BX	2439570000	R.17
WGKV 10 GN/YE BX	2439530000	R.17
WGKV 10 GY BX	2439520000	R.17
WGKV 10/Z BK BX	2439580000	R.17
WGKV 10/Z GN/YE BX	2439540000	R.17
WGKV 10/Z GY BX	2439550000	R.17
WGKV 16 BK BX	2440790000	R.19
WGKV 16 GN/YE BX	2440740000	R.19
WGKV 16 GY BX	2440750000	R.19
WGKV 16/Z BK BX	2440800000	R.19
WGKV 16/Z GN/YE BX	2440720000	R.19
WGKV 16/Z GY BX	2440730000	R.19
WGKV 25 BK BX	2444840000	R.21
WGKV 25 GN/YE BX	2444830000	R.21
WGKV 25 GY BX	2444820000	R.21
WGKV 25/Z BK BX	2444870000	R.21
WGKV 25/Z GN/YE BX	2444810000	R.21
WGKV 25/Z GY BX	2444860000	R.21
WGKV 4 BK BX	1250950000	R.13
WGKV 4 GN/YE BX	1936610000	R.13
WGKV 4 GY BX	1934050000	R.13
WGKV 4/Z BK BX	1250960000	R.13
WGKV 4/Z GN/YE BX	1936620000	R.13
WGKV 4/Z GY BX	1936630000	R.13
WS 10/5 MC NE WS	1635000000	T.56
WS 12/5 MC NE WS	1609860000	T.56
WSM TDOL AUTOMATIK	1774470000	P.40
WSM TOOL AUTOMATIK	1774470000	P.42
WSM TOOL AUTOMATIK	1774470000	P.46

Z

ZBSC DL12.5/M2.5X6 SET	1919670000	T.44
Z0V 4N/2	1527930000	T.44
Z0V 4N/2	1527930000	T.45
Z0V 4N/2 BL	1528040000	T.44
Z0V 4N/2 BL	1528040000	T.45
Z0V 4N/2 RD	2460450000	T.44
Z0V 4N/2 RD	2460450000	T.45
ZW 15 RS OR 1665	0119860000	T.51
ZW 25 RS OR	0126160000	T.51
ZW 30 RS OR	0119860000	T.51
ZW 45 RS OR	0120060000	T.51
ZW 5 RS OR	0119760000	T.51

Order No.	Type	Page
011000000		
0119560000	RF RS 70 RE/A3/M BEZ OR	T.51
0119660000	RF RS 70 LI/A2/O.SG OR 1665	T.51
0119760000	ZW 5 RS OR	T.51
0119860000	ZW 15 RS OR 1665	T.51
0119960000	ZW 30 RS OR	T.51

Order No.	Type	Page
012000000		
0120060000	ZW 45 RS OR	T.51
0126160000	ZW 25 RS OR	T.51
0126260000	RF RS 70 RE/A4/O.BEZ OR 1665	T.51

Order No.	Type	Page
018000000		
0180400000	PS 2.3 RT	R.10

Order No.	Type	Page
021000000		
0213760000	RF RS 70 MI/A6 OR	T.51

Order No.	Type	Page
023000000		
0236510000	TS 35X15/LL 1M/ST/ZN	T.41

Order No.	Type	Page
031000000		
0310000000	PS 2.0 MC	G.88
0310000000	PS 2.0 MC	G.90
0310000000	PS 2.0 MC	N.12
0310000000	PS 2.0 MC	0.19
0310000000	PS 2.0 MC	0.20
0310000000	PS 2.0 MC	0.21
0310000000	PS 2.0 MC	0.22
0310000000	PS 2.0 MC	0.24
0310000000	PS 2.0 MC	0.26
0310000000	PS 2.0 MC	0.27
0310000000	PS 2.0 MC	0.28
0310000000	PS 2.0 MC	0.29
0310000000	PS 2.0 MC	0.30
0310000000	PS 2.0 MC	0.31
0310000000	PS 2.0 MC	0.32
0310000000	PS 2.0 MC	0.33
0310000000	PS 2.0 MC	0.34
0310000000	PS 2.0 MC	0.35
0310000000	PS 2.0 MC	0.36
0310000000	PS 2.0 MC	0.37
0310000000	PS 2.0 MC	0.38
0310000000	PS 2.0 MC	0.39
0310000000	PS 2.0 MC	0.40
0310000000	PS 2.0 MC	0.41
0310000000	PS 2.0 MC	S.6

Order No.	Type	Page
047000000		
0473360000	DEK 5 NEUTRAL	0.18
0473360000	DEK 5 NEUTRAL	0.19
0473360000	DEK 5 NEUTRAL	0.20
0473360000	DEK 5 NEUTRAL	0.21
0473360000	DEK 5 NEUTRAL	0.22
0473360000	DEK 5 NEUTRAL	0.24

Order No.	Type	Page
048000000		
0485200000	ADP 1/HP1 1M	T.50

Order No.	Type	Page
051000000		
0514510000	TS 35X7.5/LL 1M/ST/ZN	T.41

Order No.	Type	Page
064000000		
0646210000	MOFU 35/LO/1 SW	T.56

Order No.	Type	Page
100000000		
1000550000	BLI/O 3.50/30LR SN BK BX	J.53
1000570000	BLI/O 3.50/30LR PNP LED SN BK BX	J.55
1000590000	BLI/O 3.50/30LR NPN LED SN BK BX	J.57
1000600000	SL-SMT 3.50/04/90RF 1.5SN BK BX	J.33
1000610000	SL-SMT 3.50/05/90RF 1.5SN BK BX	J.33
1000620000	SL-SMT 3.50/06/90RF 1.5SN BK BX	J.33
1000630000	SL-SMT 3.50/07/90RF 1.5SN BK BX	J.33
1000640000	SL-SMT 3.50/08/90RF 1.5SN BK BX	J.33
1000650000	SL-SMT 3.50/09/90RF 1.5SN BK BX	J.33
1000660000	SL-SMT 3.50/11/90RF 1.5SN BK BX	J.33
1000670000	SL-SMT 3.50/12/90RF 1.5SN BK BX	J.33
1001150000	BLDF 5.08/02/180 SN DR BX	L.114
1001160000	BLDF 5.08/03/180 SN DR BX	L.114
1001170000	BLDF 5.08/04/180 SN DR BX	L.114
1001180000	BLDF 5.08/05/180 SN DR BX	L.114
1001190000	BLDF 5.08/06/180 SN DR BX	L.114
1001200000	BLDF 5.08/07/180 SN DR BX	L.114
1001210000	BLDF 5.08/08/180 SN DR BX	L.114
1001220000	BLDF 5.08/02/180F SN DR BX	L.115
1001530000	BLF 5.08HC/02/90 SN OR BX	L.110
1001540000	BLF 5.08HC/03/90 SN OR BX	L.110
1001550000	BLF 5.08HC/04/90 SN OR BX	L.110

Order No.	Type	Page
1001560000	BLF 5.08HC/05/90 SN OR BX	L.110
1001570000	BLF 5.08HC/06/90 SN OR BX	L.110
1001580000	BLF 5.08HC/07/90 SN OR BX	L.110
1001590000	BLF 5.08HC/08/90 SN OR BX	L.110
1001600000	BLF 5.08HC/09/90 SN OR BX	L.110
1001610000	BLF 5.08HC/10/90 SN OR BX	L.110
1001620000	BLF 5.08HC/11/90 SN OR BX	L.110
1001630000	BLF 5.08HC/12/90 SN OR BX	L.110
1001720000	LL 5.00/04/90 3.2SN OR BX	G.32
1001730000	LL 5.00/05/90 3.2SN OR BX	G.32
1001740000	LL 5.00/06/90 3.2SN OR BX	G.32
1001750000	LL 5.00/07/90 3.2SN OR BX	G.32
1001760000	LL 5.00/08/90 3.2SN OR BX	G.32
1001770000	LL 5.00/09/90 3.2SN OR BX	G.32
1001780000	LL 5.00/10/90 3.2SN OR BX	G.32
1001790000	LL 5.00/11/90 3.2SN OR BX	G.32
1001800000	LL 5.00/12/90 3.2SN OR BX	G.32
1001850000	LL 5.08/04/90 3.2SN OR BX	G.33
1001860000	LL 5.08/05/90 3.2SN OR BX	G.33
1001870000	LL 5.08/06/90 3.2SN OR BX	G.33
1001880000	LL 5.08/07/90 3.2SN OR BX	G.33
1001890000	LL 5.08/08/90 3.2SN OR BX	G.33
1001900000	LL 5.08/09/90 3.2SN OR BX	G.33
1001910000	LL 5.08/10/90 3.2SN OR BX	G.33
1001920000	LL 5.08/11/90 3.2SN OR BX	G.33
1001930000	LL 5.08/12/90 3.2SN OR BX	G.33
1002090000	BLF 5.08HC/02/90F SN OR BX	L.111
1002100000	BLF 5.08HC/03/90F SN OR BX	L.111
1002110000	BLF 5.08HC/04/90F SN OR BX	L.111
1002120000	BLF 5.08HC/05/90F SN OR BX	L.111
1002130000	BLF 5.08HC/06/90F SN OR BX	L.111
1002140000	BLF 5.08HC/07/90F SN OR BX	L.111
1002150000	BLF 5.08HC/08/90F SN OR BX	L.111
1002160000	BLF 5.08HC/09/90F SN OR BX	L.111
1002170000	BLF 5.08HC/10/90F SN OR BX	L.111
1002180000	BLF 5.08HC/11/90F SN OR BX	L.111
1002190000	BLF 5.08HC/12/90F SN OR BX	L.111
1002200000	BLF 5.08HC/02/90LR SN OR BX	L.111
1002230000	BLF 5.08HC/03/90LR SN OR BX	L.111
1002230000	BLF 5.08HC/04/90LR SN OR BX	L.111
1002230000	BLF 5.08HC/05/90LR SN OR BX	L.111
1002230000	BLF 5.08HC/06/90LR SN OR BX	L.111
1002230000	BLF 5.08HC/07/90LR SN OR BX	L.111
1002230000	BLF 5.08HC/08/90LR SN OR BX	L.111
1002230000	BLF 5.08HC/09/90LR SN OR BX	L.111
1002230000	BLF 5.08HC/10/90LR SN OR BX	L.111
1002230000	BLF 5.08HC/11/90LR SN OR BX	L.111
1002230000	BLF 5.08HC/12/90LR SN OR BX	L.111
1002320000	BLF 5.08HC/02/90LR SN OR BX	L.111
1002320000	BLF 5.08HC/03/90LR SN OR BX	L.111
1002320000	BLF 5.08HC/04/90LR SN OR BX	L.111
1002320000	BLF 5.08HC/05/90LR SN OR BX	L.111
1002320000	BLF 5.08HC/06/90LR SN OR BX	L.111
1002320000	BLF 5.08HC/07/90LR SN OR BX	L.111
1002320000	BLF 5.08HC/08/90LR SN OR BX	L.111
1002320000	BLF 5.08HC/09/90LR SN OR BX	L.111
1002320000	BLF 5.08HC/10/90LR SN OR BX	L.111
1002320000	BLF 5.08HC/11/90LR SN OR BX	L.111
1002320000	BLF 5.08HC/12/90LR SN OR BX	L.111
1002320000	SMSE FE MCZ 1.5/PE	T.45
1003510000	SL-SMT 3.50/02/135F 3.2SN BK BX	J.41
1003520000	SL-SMT 3.50/03/135F 3.2SN BK BX	J.41
1003530000	SL-SMT 3.50/04/135F 3.2SN BK BX	J.41
1003540000	SL-SMT 3.50/05/135F 3.2SN BK BX	J.41
1003550000	SL-SMT 3.50/06/135F 3.2SN BK BX	J.41
1003560000	SL-SMT 3.50/07/135F 3.2SN BK BX	J.41
1003570000	SL-SMT 3.50/08/135F 3.2SN BK BX	J.41
1003580000	SL-SMT 3.50/09/135F 3.2SN BK BX	J.41
1003590000	SL-SMT 3.50/10/135F 3.2SN BK BX	J.41
1003600000	SL-SMT 3.50/11/135F 3.2SN BK BX	J.41
1003620000	SL-SMT 3.50/12/135F 3.2SN BK BX	J.41
1003890000	WGK 4 VP GN/YE BX	R.13
1003900000	WGK 4 VP/Z GN/YE BX	R.13
1003910000	WGK 4 VP/Z GY BX	R.13
1005180000	SL-SMT 3.50/10/90LF 1.5SN BK BL	J.31
1005280000	BCZ 3.81 AH03 BK BX	K.48
1005280000	BCZ 3.81 AH03 BK BX	N.4
1005290000	BCZ 3.81 AH04 BK BX	K.48
1005290000	BCZ 3.81 AH04 BK BX	N.4
1005300000	BCZ 3.81 AH05 BK BX	K.48
1005300000	BCZ 3.81 AH05 BK BX	N.4
1005310000	BCZ 3.81 AH06 BK BX	K.48
1005310000	BCZ 3.81 AH06 BK BX	N.4
1005320000	BCZ 3.81 AH07 BK BX	K.48
1005320000	BCZ 3.81 AH07 BK BX	N.4
1005330000	BCZ 3.81 AH08 BK BX	K.48
1005330000	BCZ 3.81 AH08 BK BX	N.4
1005340000	BCZ 3.81 AH09 BK BX	K.48
1005340000	BCZ 3.81 AH09 BK BX	N.4
1005350000	BCZ 3.81 AH10 BK BX	K.48
1005350000	BCZ 3.81 AH10 BK BX	N.4
1005360000	BCZ 3.81 AH11 BK BX	K.48
1005370000	BCZ 3.81 AH12 BK BX	K.48
1005370000	BCZ 3.81 AH12 BK BX	N.4
1005380000	BCZ 3.81 AH13 BK BX	K.48
1005390000	BCZ 3.81 AH14 BK BX	K.48
1005400000	BCZ 3.81 AH15 BK BX	K.48
1005410000	BCZ 3.81 AH16 BK BX	K.48

Order No.	Type	Page
101000000		
1011590000	AP 45/LIOR 1665	T.50
1011600000	AP 45/RE OR 1665	T.50
1012060000	BLDF 5.08/03/180F SN OR BX	L.115
1013070000	BLF 5.08HC/02/180F SN OR BX	L.109
1013090000	BLF 5.08HC/03/180F SN OR BX	L.109
1013110000	BLF 5.08HC/04/180F SN OR BX	L.109
1013120000	BLF 5.08HC/05/180F SN OR BX	L.109
1013130000	BLF 5.08HC/06/180F SN OR BX	L.109
1013140000	BLF 5.08HC/07/180F SN OR BX	L.109

Order No.	Type	Page
1013150000	BLF 5.08HC/08/180F SN OR BX	L.109
1013160000	BLF 5.08HC/09/180F SN OR BX	L.109
1013170000	BLF 5.08HC/10/180F SN OR BX	L.109
1013180000	BLF 5.08HC/11/180F SN OR BX	L.109
1013190000	BLF 5.08HC/12/180F SN OR BX	L.109
1013680000	BLF 5.08HC/02/180 SN DR BX	L.108
1013690000	BLF 5.08HC/03/180 SN DR BX	L.108
1013710000	BLF 5.08HC/04/180 SN DR BX	L.108
1013720000	BLF 5.08HC/05/180 SN DR BX	L.108
1013730000	BLF 5.08HC/06/180 SN DR BX	L.108
1013740000	BLF 5.08HC/07/180 SN DR BX	L.108
1013750000	BLF 5.08HC/08/180 SN DR BX	L.108
1013760000	BLF 5.08HC/09/180 SN DR BX	L.108
1013770000	BLF 5.08HC/10/180 SN DR BX	L.108
1013780000	BLF 5.08HC/11/180 SN DR BX	L.108
1013790000	BLF 5.08HC/12/180 SN DR BX	L.108
1014370000	BLF 5.08HC/02/180LR SN OR BX	L.109
1014380000	BLF 5.08HC/03/180LR SN OR BX	L.109
1014390000	BLF 5.08HC/04/180LR SN OR BX	L.109
1014410000	BLF 5.08HC/05/180LR SN OR BX	L.109
1014420000	BLF 5.08HC/06/180LR SN OR BX	L.109
1014430000	BLF 5.08HC/07/180LR SN OR BX	L.109
1014440000	BLF 5.08HC/08/180LR SN OR BX	L.109
1014450000	BLF 5.08HC/09/180LR SN OR BX	L.109
1014460000	BLF 5.08HC/10/180LR SN OR BX	L.109
1014470000	BLF 5.08HC/11/180LR SN OR BX	L.109

Order No.	Type	Page
1089970000	SV 7.6ZHP/03/90MSF3 SC/06R SN BK BX	P.27

1090000000

1090400000	SV 7.6ZHP/03/90G SC/04R SN BK BX	P.22
1090600000	SV 7.6ZHP/04/270MSF4 SC/04R SN BK BX	P.33
1090120000	SV 7.6ZHP/03/90G SC/06R SN BK BX	P.22
1090130000	SV 7.6ZHP/04/90MF4 SC/04R SN BK BX	P.25
1090450000	SV 7.6ZHP/04/90MSF4 SC/06R SN BK BX	P.33
1090210000	SV 7.6ZHP/04/90MF4 SC/06R SN BK BX	P.25
1090280000	SV 7.6ZHP/04/90G SC/04R SN BK BX	P.22
1090300000	SV 7.6ZHP/05/270MF4 SC/04R SN BK BX	P.31
1090360000	SV 7.6ZHP/04/90G SC/06R SN BK BX	P.22
1090370000	SV 7.6ZHP/04/90MSF4 SC/04R SN BK BX	P.22
1090380000	SV 7.6ZHP/05/270MF4 SC/06R SN BK BX	P.31
1090450000	SV 7.6ZHP/04/90MSF4 SC/06R SN BK BX	P.27
1090520000	SV 7.6ZHP/05/90G SC/04R SN BK BX	P.22
1090540000	SV 7.6ZHP/05/270MSF4 SC/04R SN BK BX	P.33
1090590000	SV 7.6ZHP/05/90G SC/06R SN BK BX	P.22
1090600000	SV 7.6ZHP/05/90MF4 SC/04R SN BK BX	P.22
1090610000	SV 7.6ZHP/05/270MSF4 SC/06R SN BK BX	P.33
1090670000	SV 7.6ZHP/05/90MF4 SC/06R SN BK BX	P.25
1090770000	SV 7.6ZHP/02/270G SC/04R SN BK BX	P.28
1090830000	SV 7.6ZHP/05/90MSF4 SC/04R SN BK BX	P.27
1090850000	SV 7.6ZHP/02/270G SC/06R SN BK BX	P.28
1090900000	SV 7.6ZHP/05/90MSF4 SC/04R SN BK BX	P.27
1090950000	SV 7.6ZHP/03/270G SC/04R SN BK BX	P.28
1091010000	SV 7.6ZHP/03/270G SC/06R SN BK BX	P.28
1091120000	SV 7.6ZHP/04/270G SC/04R SN BK BX	P.28
1091160000	SV 7.6ZHP/04/270G SC/06R SN BK BX	P.28
1091240000	SV 7.6ZHP/05/270G SC/04R SN BK BX	P.28
1091260000	SV 7.6ZHP/05/270G SC/06R SN BK BX	P.28
1093430000	BLZ 7.6ZHP/02/180LR SN BK BX	P.131
1093440000	BLZ 7.6ZHP/03/180LR SN BK BX	P.131
1093450000	BLZ 7.6ZHP/04/180LR SN BK BX	P.131
1093460000	BLZ 7.6ZHP/05/180LR SN BK BX	P.131
1095640000	BLL 7.6ZHP/02/90LF 3.2SN BK BX	P.135
1095650000	BLL 7.6ZHP/03/90LF 3.2SN BK BX	P.135
1095660000	BLL 7.6ZHP/04/90LF 3.2SN BK BX	P.135
1095670000	BLL 7.6ZHP/05/90LF 3.2SN BK BX	P.135
1095920000	BLL 7.6ZHP/02/90LF 3.2 SN BK BX	P.119
1095930000	SL 7.6ZHP/03/90LF 3.2 SN BK BX	P.119
1095940000	SL 7.6ZHP/04/90LF 3.2 SN BK BX	P.119
1095950000	SL 7.6ZHP/05/90LF 3.2 SN BK BX	P.119
1095960000	SL 7.6ZHP/06/90LF 3.2 SN BK BX	P.119
1095970000	SL 7.6ZHP/07/90LF 3.2 SN BK BX	P.119
1095980000	SL 7.6ZHP/08/90LF 3.2 SN BK BX	P.119
1095990000	SL 7.6ZHP/09/90LF 3.2 SN BK BX	P.119
1096000000	SL 7.6ZHP/10/90LF 3.2 SN BK BX	P.119
1096010000	SL 7.6ZHP/11/90LF 3.2 SN BK BX	P.119
1096020000	SL 7.6ZHP/12/90LF 3.2 SN BK BX	P.119

1100000000

1104170000	CH20M12 B BK/ BK 2010	T.22
1104180000	CH20M12 B BK/ OR 2010	T.22
1104190000	CH20M12 F BK 2010	T.22
1104200000	CH20M12 S PPSC BK 2010	T.23
1104210000	CH20M12 S PPSC BK 2010	T.23
1104220000	CH20M12 S PPSC BL 2013	T.23
1104230000	CH20M12 S PPSC BL 2013	T.23
1104240000	CH20M12 C BK 1819	T.22
1104250000	CH20M12 C TP 8089	T.22
1104400000	CH20M45 B BK/ BK 2010	T.28
1104410000	CH20M45 B BK/ OR 2010	T.28
1104420000	CH20M45 F BK 2010	T.28
1104430000	CH20M45 C BK 1819	T.28
1104440000	CH20M45 C TP 8089	T.28
1104500000	CH20M22 B BK/ OR 2010	T.26
1105580000	SAMPLE LP CH20M22 PPX	T.13
1105600000	SK DEMO CH20M22	T.13
1105600000	SK DEMO CH20M22	T.26

1110000000

1110720000	SL-SMT 5.0OHC/08/180G 1.5SN BK RL	L.27
1111630000	SK DEMO CH20M12	T.13
1111630000	SK DEMO CH20M12	T.22
1111640000	SK DEMO CH20M45	T.13
1111640000	SK DEMO CH20M45	T.28
1111720000	CH20M45 S 2PSC/2PSC BK 2010	L.72
1118470000	BVF 7.6ZHP SH180 4-6 KIT	P.36
1118470000	BVF 7.6ZHP SH180 4-6 KIT	P.38
1118470000	BVF 7.6ZHP SH180 4-6 KIT	P.50
1118470000	BVF 7.6ZHP SH180 4-6 KIT	P.52
1118470000	BVF 7.6ZHP SH180 4-6 KIT	S.3
1118480000	BVF 7.6ZHP SH150 4-6 KIT	P.36
1118480000	BVF 7.6ZHP SH150 4-6 KIT	P.38
1118480000	BVF 7.6ZHP SH150 4-6 KIT	P.50
1118480000	BVF 7.6ZHP SH150 4-6 KIT	P.52
1118490000	BVF 7.6ZHP SH150 4-6 KIT	S.3
1118490000	BVF 7.6ZHP SH210 4-6 KIT	P.36
1118490000	BVF 7.6ZHP SH210 4-6 KIT	P.38
1118490000	BVF 7.6ZHP SH210 4-6 KIT	P.50
1118490000	BVF 7.6ZHP SH210 4-6 KIT	P.52
1118490000	BVF 7.6ZHP SH210 4-6 KIT	S.3

Order No.	Type	Page
-----------	------	------

1120000000

1122070000	BLL 7.6ZHP/02/180 3.2SN BK BX	P.136
1122080000	BLL 7.6ZHP/03/180 3.2SN BK BX	P.136
1122090000	BLL 7.6ZHP/04/180 3.2SN BK BX	P.136
1122100000	BLL 7.6ZHP/05/180 3.2SN BK BX	P.136
1122110000	BLL 7.6ZHP/02/180F 3.2SN BK BX	P.137
1122120000	BLL 7.6ZHP/03/180F 3.2SN BK BX	P.137
1122130000	BLL 7.6ZHP/04/180F 3.2SN BK BX	P.137
1122140000	BLL 7.6ZHP/05/180F 3.2SN BK BX	P.137
1122560000	SL 7.6ZHP/02/180G 3.2SN BK BX	P.120
1122570000	SL 7.6ZHP/03/180G 3.2SN BK BX	P.120
1122580000	SL 7.6ZHP/04/180G 3.2SN BK BX	P.120
1122590000	SL 7.6ZHP/07/180G 3.2SN BK BX	P.120
1122600000	SL 7.6ZHP/09/180G 3.2SN BK BX	P.120
1122610000	SL 7.6ZHP/10/180G 3.2SN BK BX	P.120
1122640000	SL 7.6ZHP/11/180G 3.2SN BK BX	P.120
1122650000	SL 7.6ZHP/12/180G 3.2SN BK BX	P.120
1124250000	SL 7.6ZHP/06/90F 3.2 SN BK BX	P.119
1124270000	SL 7.6ZHP/07/90F 3.2 SN BK BX	P.119
1124280000	SL 7.6ZHP/08/90F 3.2 SN BK BX	P.119
1124290000	SL 7.6ZHP/09/90F 3.2 SN BK BX	P.119
1124300000	SL 7.6ZHP/10/90F 3.2 SN BK BX	P.119
1124310000	SL 7.6ZHP/11/90F 3.2 SN BK BX	P.119
1124320000	SL 7.6ZHP/12/90F 3.2 SN BK BX	P.119
1124750000	SVF 7.6ZHP/02/180FSI SN BK BX	P.174
1124760000	SVF 7.6ZHP/03/180FSI SN BK BX	P.174
1124770000	SVF 7.6ZHP/04/180FSI SN BK BX	P.174
1124780000	SVF 7.6ZHP/05/180FSI SN BK BX	P.174
1124810000	SVF 7.6ZHP/02/180FSI SN BK BX	P.174
1124820000	SVF 7.6ZHP/03/180FSI SN BK BX	P.175
1124830000	SVF 7.6ZHP/04/180FSI SN BK BX	P.175
1124840000	SVF 7.6ZHP/05/180FSI SN BK BX	P.175

1130000000

1134080000	BLL 7.6ZHP/02/180LF 3.2SN BK BX	P.137
1134090000	BLL 7.6ZHP/03/180LF 3.2SN BK BX	P.137
1134110000	BLL 7.6ZHP/04/180LF 3.2SN BK BX	P.137
1134120000	BLL 7.6ZHP/05/180LF 3.2SN BK BX	P.137
1137730000	CH20M45 S 3P/3C BK 2010	T.29
1137740000	CH20M45 S 2PSC/3SC BK 2010	T.29
1137750000	CH20M45 S 3SC/2PSC BK 2010	T.29
1137870000	LHZ-SMT L 1.5SN BK BX	T.32
1137880000	LHZ-SMT R 1.5SN BK BX	T.32
1139790000	CH20M22 S PPP BK 2010	T.27

1140000000

1140870000	SL 7.6ZHP/02/180F 3.2 SN BK BX	P.121
1140880000	SL 7.6ZHP/03/180F 3.2 SN BK BX	P.121
1140890000	SL 7.6ZHP/04/180F 3.2 SN BK BX	P.121
1140900000	SL 7.6ZHP/05/180F 3.2 SN BK BX	P.121
1140910000	SL 7.6ZHP/06/180F 3.2 SN BK BX	P.121
1140920000	SL 7.6ZHP/07/180F 3.2 SN BK BX	P.121
1140930000	SL 7.6ZHP/08/180F 3.2 SN BK BX	P.121
1140940000	SL 7.6ZHP/09/180F 3.2 SN BK BX	P.121
1140950000	SL 7.6ZHP/10/180F 3.2 SN BK BX	P.121
1140960000	SL 7.6ZHP/11/180F 3.2 SN BK BX	P.121
1140970000	SL 7.6ZHP/12/180F 3.2 SN BK BX	P.121
1141090000	SL 7.6ZHP/02/180LF 3.2 SN BK BX	P.121
1141100000	SL 7.6ZHP/03/180LF 3.2 SN BK BX	P.121
1141110000	SL 7.6ZHP/04/180LF 3.2 SN BK BX	P.121
1141120000	SL 7.6ZHP/05/180LF 3.2 SN BK BX	P.121
1141130000	SL 7.6ZHP/06/180LF 3.2 SN BK BX	P.121
1141140000	SL 7.6ZHP/07/180LF 3.2 SN BK BX	P.121
1141150000	SL 7.6ZHP/08/180LF 3.2 SN BK BX	P.121
1141160000	SL 7.6ZHP/09/180LF 3.2 SN BK BX	P.121
1141170000	SL 7.6ZHP/10/180LF 3.2 SN BK BX	P.121
1141180000	SL 7.6ZHP/11/180LF 3.2 SN BK BX	P.121
1141190000	SL 7.6ZHP/12/180LF 3.2 SN BK BX	P.121
1146320000	SL 5.08HC/02/180 3.2SN DR BX	L.72
1146340000	SL 5.08HC/03/180 3.2SN DR BX	L.72
1146380000	SL 5.08HC/04/180 3.2SN DR BX	L.72
1146410000	SL 5.08HC/05/180 3.2SN DR BX	L.72
1146450000	SL 5.08HC/06/180 3.2SN DR BX	L.72
1146490000	SL 5.08HC/07/180 3.2SN DR BX	L.72
1146510000	SL 5.08HC/08/180 3.2SN DR BX	L.72
1146530000	SL 5.08HC/09/180 3.2SN DR BX	L.72
1146550000	SL 5.08HC/11/180 3.2SN DR BX	L.72
1146570000	SL 5.08HC/12/180 3.2SN DR BX	L.72
1146720000	SL 5.08HC/02/90 3.2SN DR BX	L.68
1146730000	SL 5.08HC/02/180G 3.2SN DR BX	L.73
1146740000	SL 5.08HC/03/90 3.2SN DR BX	L.68
1146750000	SL 5.08HC/03/180G 3.2SN DR BX	L.73
1146770000	SL 5.08HC/04/90 3.2SN DR BX	L.68
1146780000	SL 5.08HC/04/180G 3.2SN DR BX	L.73
1146790000	SL 5.08HC/05/90 3.2SN DR BX	L.68
1146800000	SL 5.08HC/05/180G 3.2SN DR BX	L.73
1146810000	SL 5.08HC/06/90 3.2SN DR BX	L.68
1146820000	SL 5.08HC/06/180 3.2SN DR BX	L.73
1146830000	SL 5.08HC/07/90 3.2SN DR BX	L.68
1146840000	SL 5.08HC/07/180G 3.2SN DR BX	L.73
1146850000	SL 5.08HC/08/90 3.2SN DR BX	L.68
1146860000	SL 5.08HC/08/180G 3.2SN DR BX	L.73
1146870000	SL 5.08HC/09/90 3.2SN DR BX	L.68
1146880000	SL 5.08HC/09/180G 3.2SN DR BX	L.73
1146890000	SL 5.08HC/10/90 3.2SN DR BX	L.68
1146900000	SL 5.08HC/10/180G 3.2SN DR BX	L.73

Order No.	Type	Page
-----------	------	------

1146910000	SL 5.08HC/10/180G 3.2SN DR BX	L.73
1146920000	SL 5.08HC/11/90 3.2SN DR BX	L.68
1146930000	SL 5.08HC/11/180G 3.2SN DR BX	L.73
1146940000	SL 5.08HC/12/90 3.2SN DR BX	L.68
1146950000	SL 5.08HC/12/180G 3.2SN DR BX	L.73
1147130000	SL 5.08HC/02/180F 3.2SN DR BX	L.74
1147170000	SL 5.08HC/03/180F 3.2SN DR BX	L.74
1147200000	SL 5.08HC/04/180F 3.2SN DR BX	L.74
1147230000	SL 5.08HC/05/180F 3.2SN DR BX	L.74
1147260000	SL 5.08HC/06/180F 3.2SN DR BX	L.74
1147280000	SL 5.08HC/02/90G 3.2SN DR BX	L.69
1147290000	SL 5.08HC/07/180F 3.2SN DR BX	L.74
1147300000	SL 5.08HC/02/180B 3.2SN DR BX	L.73
1147310000	SL 5.08HC/03/90G 3.2SN DR BX	L.69
1147320000	SL 5.08HC/08/180F 3.2SN DR BX	L.74
1147330000	SL 5.08HC/09/180B 3.2SN DR BX	L.73
1147340000	SL 5.08HC/04/90G 3.2SN DR BX	L.69
1147350000	SL 5.08HC/09/180F 3.2SN DR BX	L.74
1147360000	SL 5.08HC/04/180B 3.2SN DR BX	L.73
1147370000	SL 5.08HC/05/90G 3.2SN DR BX	L.69
1147380000	SL 5.08HC/10/180F 3.2SN DR BX	L.74
1147390000	SL 5.08HC/05/180B 3.2SN DR BX	L.73
1147400000	SL 5.08HC/06/90G 3.2SN DR BX	L.69
1147410000	SL 5.08HC/11/180F 3.2SN DR BX	L.74
1147420000	SL 5.08HC/07/90G 3.2SN DR BX	L.69
1147430000	SL 5.08HC/06/180B 3.2SN DR BX	L.73
1147440000	SL 5.08HC/12/180F 3.2SN DR BX	L.74
1147450000	SL 5.08HC/08/90G 3.2SN DR BX	L.69
1147470000	SL 5.08HC/07/180B 3.2SN DR BX	L.73
1147490000	SL 5.08HC/09/90G 3.2SN DR BX	L.69
1147510000	SL 5.08HC/08/180B 3.2SN DR BX	L.73
1147530000	SL 5.08HC/10/90G 3.2SN DR BX	L.69
1147540000	SL 5.08HC/09/180B 3.2SN DR BX	L.73
1147550000	SL 5.08HC/11/90G 3.2SN DR BX	L.69
1147580000	SL 5.08HC/10/180B 3.2SN DR BX	L.73
1147600000	SL 5.08HC/12/90G 3.2SN DR BX	L.69
1147610000	SL 5.08HC/11/180B 3.2SN DR BX	L.73

Order No.	Type	Page
116000000		
1164670000	CH20M22 B LGV/BK 2018	T.26
1164680000	CH20M22 F LFGY 2018	T.26
1164690000	CH20M22 S PPSC LGY 2018	T.27
1164710000	CH20M45 B GGY/BK 2019	T.28
1164720000	CH20M45 F GGY 2019	T.28
1164730000	CH20M45 FC GGY 2019	T.28
1164740000	CH20M45 S 2PSC/2PSC GGY 2019	T.29
1164750000	CH20M45 B LGV/BK 2018	T.28
1164770000	CH20M45 F LFGY 2018	T.28
1164780000	CH20M45 FC LGY 2018	T.28
1164790000	CH20M45 S 2PSC/2PSC LGY 2018	T.29
1164800000	CH20M45 FC BK 2010	T.28
1164960000	BLZ 7.62HP/06/180LR SN BK BX	P.131
1164970000	BLZ 7.62HP/07/180LR SN BK BX	P.131
1164980000	BLZ 7.62HP/08/180LR SN BK BX	P.131
1164990000	BLZ 7.62HP/09/180LR SN BK BX	P.131
1165000000	BLZ 7.62HP/10/180LR SN BK BX	P.131
1165010000	BLZ 7.62HP/11/180LR SN BK BX	P.131
1165020000	BLZ 7.62HP/12/180LR SN BK BX	P.131
1166180000	CH20M45 S P2SC/2PSC BK 2010	T.29
1167190000	SK S-KIT -CH20M12	T.13
1167190000	SK S-KIT -CH20M12	T.22
1167200000	SK DEMO CH20M17	T.13
1167200000	SK DEMO CH20M17	T.24
1168970000	MTA 30 BK	T.56

Order No.	Type	Page
117000000		
1171090000	SAMPLE LP CH20M6	T.13
1173490000	BLZ 7.62IT/02/180MF2 SN BK BX	P.66
1173500000	BLZ 7.62IT/03/180MF2 SN BK BX	P.66
1173510000	BLZ 7.62IT/03/180MF3 SN BK BX	P.67
1173520000	BLZ 7.62IT/04/180MF2 SN BK BX	P.66
1173530000	BLZ 7.62IT/04/180MF4 SN BK BX	P.67
1173610000	SL 7.62IT/02/90MF2 3.2SN BK BX S0	P.64
1173640000	SL 7.62IT/03/90MF2 3.2SN BK BX	P.64
1173690000	SL 7.62IT/03/90MF3 3.2SN BK BX	P.65
1173730000	SL 7.62IT/04/90MF2 3.2SN BK BX	P.64
1173770000	SL 7.62IT/04/90MF4 3.2SN BK BX	P.65
1174280000	CH20M12 S PPP BK 2010	T.23
1174720000	LX 15.00/03/90 4.5SN BK BX	O.22
1176980000	CH20M12 B BUS BK/OR 2010	T.22
1176990000	CH20M12 B FE BK/OR 2010	T.22
1177000000	CH20M22 B BUS BK/OR 2010	T.26
1177010000	CH20M22 B FE BK/OR 2010	T.26
1177020000	CH20M45 B BUS BK/OR 2010	T.28
1177030000	CH20M45 B FE BK/OR 2010	T.28

Order No.	Type	Page
118000000		
1185060000	AP 100 DR 1665	T.54
1185160000	AP 100 D OR	T.54
1185260000	AP 110 DR	T.54
1185360000	AP 110 D OR	T.54
1185460000	AP 111 OR	T.54
1185560000	AP 111 D OR	T.54
1189370000	CH20M FE 12-67 1.5SN RL	T.39

Order No.	Type	Page
119000000		
1193160000	CH20M BUS-AP LI TS 35X7.5 & 15	T.40
1193170000	CH20M BUS-AP RE TS 35X7.5 & 15	T.40

Order No.	Type	Page
120000000		
1203290000	SK S-KIT CH20M6	T.13
1203290000	SK S-KIT CH20M6	T.20
1203310000	SK DEMO CH20M6	T.13
1203310000	SK DEMO CH20M6	T.20
1203350000	SK S-KIT CH20M45	T.13
1203350000	SK S-KIT CH20M45	T.28
1206870000	CH20M22 B RD/BK 2014	T.26
1206880000	CH20M22 FC RD 2014	T.26
1206890000	CH20M22 S PPSC RD 2014	T.27
1206910000	CH20M45 B RD/BK 2014	T.28
1206920000	CH20M45 FC RD 2014	T.28
1206930000	CH20M45 S 2PSC/2PSC RD 2014	T.29
1209350000	CH20M22 FC BK 2010	T.26
1209360000	CH20M22 FC GGY 2019	T.28
1209370000	CH20M22 FC LGY 2018	T.26
1209380000	CH20M22 F RD 2014	T.26
1209390000	CH20M45 F RD 2014	T.28

Order No.	Type	Page
122000000		
1221520000	ESG 6.6/20 BHZ 5.00 SDR	T.37
1222620000	LU 10.16/04/90 4.5SN BK BX	O.18
1222630000	LU 10.16/05/90 4.5SN BK BX	O.18
1222640000	LU 10.16/06/90 4.5SN BK BX	O.18
1222650000	LU 10.16/07/90 4.5SN BK BX	O.18
1222660000	LU 10.16/08/90 4.5SN BK BX	O.18
1222670000	LU 10.16/09/90 4.5SN BK BX	O.18
1222680000	LU 10.16/10/90 4.5SN BK BX	O.18
1222690000	LU 15.00/01/90 4.5SN BK BX	O.22
1222700000	LU 15.00/02/90 4.5SN BK BX	O.22
1226480000	LX 15.00/04/90 4.5SN BK BX	O.22
1226490000	LX 15.00/05/90 4.5SN BK BX	O.22

Order No.	Type	Page
122650000		
1226500000	LX 15.00/06/90 4.5SN BK BX	O.22
1226510000	LX 15.00/07/90 4.5SN BK BX	O.22
1226520000	LXB 15.00/02/90 4.5SN BK BX	O.23
1226530000	LXB 15.00/03/90 4.5SN BK BX	O.23
1226540000	LXB 15.00/04/90 4.5SN BK BX	O.23
1226550000	LXB 15.00/05/90 4.5SN BK BX	O.23
1226560000	LXB 15.00/06/90 4.5SN BK BX	O.23
1226570000	LXB 15.00/07/90 4.5SN BK BX	O.23
1226580000	LXB 15.00/08/90 4.5SN BK BX	O.23
1226590000	LXBL 15.00/01/90 4.5SN BK BX	O.23
1227340000	BLF 7.62HP/06/180 SN BK BX	P.132
1227350000	BLF 7.62HP/07/180 SN BK BX	P.132
1227360000	BLF 7.62HP/08/180 SN BK BX	P.132
1227370000	BLF 7.62HP/09/180 SN BK BX	P.132
1227380000	BLF 7.62HP/10/180 SN BK BX	P.132
1227390000	BLF 7.62HP/11/180 SN BK BX	P.132
1227400000	BLF 7.62HP/12/180 SN BK BX	P.132
1227420000	BLF 7.62HP/06/180LR SN BK BX	P.133
1227430000	BLF 7.62HP/07/180LR SN BK BX	P.133
1227440000	BLF 7.62HP/08/180LR SN BK BX	P.133
1227450000	BLF 7.62HP/09/180LR SN BK BX	P.133
1227460000	BLF 7.62HP/10/180LR SN BK BX	P.133
1227490000	BLF 7.62HP/06/180F SN BK BX	P.133
1227510000	BLF 7.62HP/07/180F SN BK BX	P.133
1227520000	BLF 7.62HP/08/180F SN BK BX	P.133
1227530000	BLF 7.62HP/09/180F SN BK BX	P.133
1227540000	BLF 7.62HP/10/180F SN BK BX	P.133

Order No.	Type	Page
123000000		
1234230000	LM 5.00/04/180 3.5SN OR BX	G.25
1234240000	LM 5.00/05/180 3.5SN OR BX	G.25
1234250000	LM 5.00/06/180 3.5SN OR BX	G.25
1234270000	LM 5.00/07/180 3.5SN OR BX	G.25
1234280000	LM 5.00/08/180 3.5SN OR BX	G.25
1234290000	LM 5.00/09/180 3.5SN OR BX	G.25
1234310000	LM 5.00/10/180 3.5SN OR BX	G.25
1234320000	LM 5.00/11/180 3.5SN OR BX	G.25
1234330000	LM 5.00/12/180 3.5SN OR BX	G.25
1234450000	PM 5.08/04/90 3.5SN OR BX	G.45
1234570000	PM 5.08/05/90 3.5SN OR BX	G.45
1234580000	PM 5.08/06/90 3.5SN OR BX	G.45
1234590000	PM 5.08/07/90 3.5SN OR BX	G.45
1234600000	PM 5.08/08/90 3.5SN OR BX	G.45
1234610000	PM 5.08/09/90 3.5SN OR BX	G.45
1234620000	PM 5.08/10/90 3.5SN OR BX	G.45
1234630000	PM 5.08/11/90 3.5SN OR BX	G.45
1234640000	PM 5.08/12/90 3.5SN OR BX	G.45
1234650000	PM 5.00/04/90 3.5SN OR BX	G.44
1234670000	PM 5.00/05/90 3.5SN OR BX	G.44
1234680000	PM 5.00/06/90 3.5SN OR BX	G.44
1234690000	PM 5.00/07/90 3.5SN OR BX	G.44
1234700000	PM 5.00/08/90 3.5SN OR BX	G.44
1234710000	PM 5.00/09/90 3.5SN OR BX	G.44
1234720000	PM 5.00/10/90 3.5SN OR BX	G.44
1234730000	PM 5.00/11/90 3.5SN OR BX	G.44
1234740000	PM 5.00/12/90 3.5SN OR BX	G.44
1235250000	CH20M67 B BK/OR 2010	T.30
1235270000	CH20M67 B BK/BL 2010	T.30
1235310000	CH20M67 FC BK 2010	T.30
1235320000	CH20M67 S 2PSC/2PSC/2PSC BK 2010	T.31
1235790000	BCF 3.81/05/180ZE SN OR BX	K.56
1235800000	BCF 3.81/06/180ZE SN OR BX	K.56
1235810000	BCF 3.81/07/180ZE SN OR BX	K.56
1235820000	BCF 3.81/08/180ZE SN OR BX	K.56
1235830000	BCF 3.81/09/180ZE SN OR BX	K.56
1235840000	BCF 3.81/10/180ZE SN OR BX	K.56
1235870000	BCF 3.81/11/180ZE SN OR BX	K.56
1235880000	BCF 3.81/12/180ZE SN OR BX	K.56
1235970000	BCF 3.81/05/180FZE SN OR BX	K.57
1235980000	BCF 3.81/06/180FZE SN OR BX	K.57
1235990000	BCF 3.81/07/180FZE SN OR BX	K.57
1236000000	BCF 3.81/08/180FZE SN OR BX	K.57
1236010000	BCF 3.81/09/180FZE SN OR BX	K.57
1236020000	BCF 3.81/10/180FZE SN OR BX	K.57
1236030000	BCF 3.81/11/180FZE SN OR BX	K.57
1236040000	BCF 3.81/12/180FZE SN OR BX	K.57
1236270000	BCZ 3.81/05/180ZE SN OR BX	K.50
1236280000	BCZ 3.81/06/180ZE SN OR BX	K.50
1236290000	BCZ 3.81/07/180ZE SN OR BX	K.50
1236300000	BCZ 3.81/08/180ZE SN OR BX	K.50
1236310000	BCZ 3.81/09/180ZE SN OR BX	K.50
1236320000	BCZ 3.81/10/180ZE SN OR BX	K.50
1236330000	BCZ 3.81/11/180ZE SN OR BX	K.50
1236340000	BCZ 3.81/12/180ZE SN OR BX	K.50
1236370000	BCZ 3.81/12/180ZE SN OR BX	K.50
1236530000	BCZ 3.81/05/180FZE SN OR BX	K.51
1236540000	BCZ 3.81/06/180FZE SN OR BX	K.51
1236570000	BCZ 3.81/07/180FZE SN OR BX	K.51
1236590000	BCZ 3.81/08/180FZE SN OR BX	K.51
1236600000	BCZ 3.81/09/180FZE SN OR BX	K.51
1236610000	BCZ 3.81/10/180FZE SN OR BX	K.51
1236620000	BCZ 3.81/11/180FZE SN OR BX	K.51
1236630000	BCZ 3.81/12/180FZE SN OR BX	K.51
1237000000	SCZ 3.81/04/180GZE SN OR BX	K.46
1237010000	SCZ 3.81/05/180GZE SN OR BX	K.46
1237020000	SCZ 3.81/06/180GZE SN OR BX	K.46
1237030000	SCZ 3.81/07/180GZE SN OR BX	K.46
1237040000	SCZ 3.81/08/180GZE SN OR BX	K.46
1237070000	SCZ 3.81/09/180GZE SN OR BX	K.46

Order No.	Type	Page
123708000		
1237080000	SCZ 3.81/10/180GZE SN OR BX	K.46
1237090000	SCZ 3.81/11/180GZE SN OR BX	K.46
1237100000	SCZ 3.81/12/180GZE SN OR BX	K.46
1237120000	SCZ 3.81/04/180FZE SN OR BX	K.47
1237130000	SCZ 3.81/05/180FZE SN OR BX	K.47
1237140000	SCZ 3.81/06/180FZE SN OR BX	K.47
1237170000	SCZ 3.81/07/180FZE SN OR BX	K.47
1237180000	SCZ 3.81/08/180FZE SN OR BX	K.47
1237190000	SCZ 3.81/09/180FZE SN OR BX	K.47
1237200000	SCZ 3.81/10/180FZE SN OR BX	K.47
1237210000	SCZ 3.81/11/180FZE SN OR BX	K.47
1237220000	SCZ 3.81/12/180FZE SN OR BX	K.47
1237550000	SCZ 3.81/04/180FIZE SN OR BX	K.47
1237560000	SCZ 3.81/05/180FIZE SN OR BX	K.47
1237570000	SCZ 3.81/06/180FIZE SN OR BX	K.47
1237580000	SCZ 3.81/07/180FIZE SN OR BX	K.47
1237590000	SCZ 3.81/08/180FIZE SN OR BX	K.47
1237610000	SCZ 3.81/09/180FIZE SN OR BX	K.47
1237620000	SCZ 3.81/10/180FIZE SN OR BX	K.47
1237630000	SCZ 3.81/11/180FIZE SN OR BX	K.47
1237640000	SCZ 3.81/12/180FIZE SN OR BX	K.47

Order No.	Type	Page
124000000		
1243030000	CH20M22 B BUS BK/BK 2010	T.26
1247240000	CH20M67 B BUS BK/OR 2010	

Order No.	Type	Page
1312680000	CH20M12 S PSCC LGY 2018	T.23
1312730000	BVZ 7.621T/04/180MFC3 SN BK BX	P.77
1317200000	SAMPLE LP CH20M PPP	T.13

1320000000

1324260000	AP 80 OR	T.52
1324360000	AP 80 D OR	T.52
1324460000	RF 180 OR 1665	T.52
1324460000	RF 180 OR 1665	T.53
1324460000	RF 180 OR 1665	T.54
1327040000	SK S-KIT IN-RAIL BUS CH20M 12-67	T.13
1327990000	CH20M45 S2PSC/2PSC TYL 2083	T.29

1330000000

1330180000	LMF 5.00/02/180 3.5SN OR BX	G.89
1330190000	LMF 5.00/03/180 3.5SN OR BX	G.89
1330200000	LMF 5.00/04/180 3.5SN OR BX	G.89
1330210000	LMF 5.00/05/180 3.5SN OR BX	G.89
1330220000	LMF 5.00/06/180 3.5SN OR BX	G.89
1330230000	LMF 5.00/07/180 3.5SN OR BX	G.89
1330240000	LMF 5.00/08/180 3.5SN OR BX	G.89
1330250000	LMF 5.00/09/180 3.5SN OR BX	G.89
1330270000	LMF 5.00/10/180 3.5SN OR BX	G.89
1330280000	LMF 5.00/11/180 3.5SN OR BX	G.89
1330290000	LMF 5.00/12/180 3.5SN OR BX	G.89
1330430000	LMFS 5.00/02/180 3.5SN OR BX	G.89
1330440000	LMFS 5.00/03/180 3.5SN OR BX	G.89
1330450000	LMFS 5.00/04/180 3.5SN OR BX	G.89
1330470000	LMFS 5.00/05/180 3.5SN OR BX	G.89
1330490000	LMFS 5.00/06/180 3.5SN OR BX	G.89
1330500000	LMFS 5.00/07/180 3.5SN OR BX	G.89
1330510000	LMFS 5.00/08/180 3.5SN OR BX	G.89
1330520000	LMFS 5.00/09/180 3.5SN OR BX	G.89
1330530000	LMFS 5.00/10/180 3.5SN OR BX	G.89
1330540000	LMFS 5.00/11/180 3.5SN OR BX	G.89
1330550000	LMFS 5.00/12/180 3.5SN OR BX	G.89
1330710000	LMF 5.08/02/90 3.5SN OR BX	G.90
1330720000	LMF 5.08/03/90 3.5SN OR BX	G.90
1330730000	LMF 5.08/04/90 3.5SN OR BX	G.90
1330740000	LMF 5.08/05/90 3.5SN OR BX	G.90
1330750000	LMF 5.08/06/90 3.5SN OR BX	G.90
1330770000	LMF 5.08/07/90 3.5SN OR BX	G.90
1330780000	LMF 5.08/08/90 3.5SN OR BX	G.90
1330790000	LMF 5.08/09/90 3.5SN OR BX	G.90
1330800000	LMF 5.08/10/90 3.5SN OR BX	G.90
1330810000	LMF 5.08/11/90 3.5SN OR BX	G.90
1330820000	LMF 5.08/12/90 3.5SN OR BX	G.90
1330960000	LMFS 5.08/02/90 3.5SN OR BX	G.91
1330970000	LMFS 5.08/03/90 3.5SN OR BX	G.91
1330980000	LMFS 5.08/04/90 3.5SN OR BX	G.91
1330990000	LMFS 5.08/05/90 3.5SN OR BX	G.91
1331000000	LMFS 5.08/06/90 3.5SN OR BX	G.91
1331010000	LMFS 5.08/07/90 3.5SN OR BX	G.91
1331020000	LMFS 5.08/08/90 3.5SN OR BX	G.91
1331030000	LMFS 5.08/09/90 3.5SN OR BX	G.91
1331040000	LMFS 5.08/10/90 3.5SN OR BX	G.91
1331050000	LMFS 5.08/11/90 3.5SN OR BX	G.91
1331060000	LMFS 5.08/12/90 3.5SN OR BX	G.91
1331080000	LMF 5.08/02/180 3.5SN OR BX	G.91
1331100000	LMF 5.08/03/180 3.5SN OR BX	G.91
1331120000	LMF 5.08/04/180 3.5SN OR BX	G.91
1331140000	LMF 5.08/05/180 3.5SN OR BX	G.91
1331160000	LMF 5.08/06/180 3.5SN OR BX	G.91
1331180000	LMF 5.08/07/180 3.5SN OR BX	G.91
1331200000	LMF 5.08/08/180 3.5SN OR BX	G.91
1331220000	LMF 5.08/09/180 3.5SN OR BX	G.91
1331240000	LMF 5.08/10/180 3.5SN OR BX	G.91
1331260000	LMF 5.08/11/180 3.5SN OR BX	G.91
1331280000	LMF 5.08/12/180 3.5SN OR BX	G.91
1331330000	LMFS 5.08/02/180 3.5SN OR BX	G.91
13313440000	LMFS 5.08/03/180 3.5SN OR BX	G.91
13313450000	LMFS 5.08/04/180 3.5SN OR BX	G.91
13313470000	LMFS 5.08/05/180 3.5SN OR BX	G.91
13313480000	LMFS 5.08/06/180 3.5SN OR BX	G.91
13313490000	LMFS 5.08/07/180 3.5SN OR BX	G.91
13313500000	LMFS 5.08/08/180 3.5SN OR BX	G.91
13313510000	LMFS 5.08/09/180 3.5SN OR BX	G.91
13313520000	LMFS 5.08/10/180 3.5SN OR BX	G.91
13313530000	LMFS 5.08/11/180 3.5SN OR BX	G.91
13313540000	LMFS 5.08/12/180 3.5SN OR BX	G.91
1331700000	LMF 5.00/02/90 3.5SN OR BX	G.88
1331710000	LMF 5.00/03/90 3.5SN OR BX	G.88
1331720000	LMF 5.00/04/90 3.5SN OR BX	G.88
1331730000	LMF 5.00/05/90 3.5SN OR BX	G.88
1331740000	LMF 5.00/06/90 3.5SN OR BX	G.88
1331750000	LMF 5.00/07/90 3.5SN OR BX	G.88
1331770000	LMF 5.00/08/90 3.5SN OR BX	G.88
1331780000	LMF 5.00/09/90 3.5SN OR BX	G.88
1331790000	LMF 5.00/10/90 3.5SN OR BX	G.88
1331800000	LMF 5.00/11/90 3.5SN OR BX	G.88
1331810000	LMF 5.00/12/90 3.5SN OR BX	G.88
1331960000	LMFS 5.00/02/90 3.5SN OR BX	G.89
1331970000	LMFS 5.00/03/90 3.5SN OR BX	G.89
1331980000	LMFS 5.00/04/90 3.5SN OR BX	G.89
1331990000	LMFS 5.00/05/90 3.5SN OR BX	G.89
1332010000	LMFS 5.00/06/90 3.5SN OR BX	G.89
1332020000	LMFS 5.00/07/90 3.5SN OR BX	G.89

Order No.	Type	Page
1332030000	LMFS 5.00/08/90 3.5SN OR BX	G.89
1332040000	LMFS 5.00/09/90 3.5SN OR BX	G.89
1332050000	LMFS 5.00/10/90 3.5SN OR BX	G.89
1332060000	LMFS 5.00/11/90 3.5SN OR BX	G.89
1332070000	LMFS 5.00/12/90 3.5SN OR BX	G.89
1333100000	H2.5/14DS BL	L.46
1333100000	H2.5/14DS BL	L.48
1333100000	H2.5/14DS BL	L.84
1333100000	H2.5/14DS BL	L.88
1333100000	H2.5/14DS BL	L.94
1333100000	H2.5/14DS BL	L.108
1333100000	H2.5/14DS BL	L.110
1333100000	H2.5/14DS BL	L.112
1333100000	H2.5/14DS BL	L.114
1335140000	SET CH20M BUS 250MM TS 35X7.5	T.41
1335150000	SET CH20M BUS 250MM TS 35X15	T.41
1335330000	SLF 5.08/02/180 SN OR BX	L.94
1335340000	SLF 5.08/03/180 SN OR BX	L.94
1335350000	SLF 5.08/04/180 SN OR BX	L.94
1335360000	SLF 5.08/05/180 SN OR BX	L.94
1335370000	SLF 5.08/06/180 SN OR BX	L.94
1335380000	SLF 5.08/07/180 SN OR BX	L.94
1335390000	SLF 5.08/08/180 SN OR BX	L.94
1335400000	SLF 5.08/09/180 SN OR BX	L.94
1335410000	SLF 5.08/10/180 SN OR BX	L.94
1335420000	SLF 5.08/11/180 SN OR BX	L.94
1335430000	SLF 5.08/12/180 SN OR BX	L.94
1335440000	SLF 5.08/02/180 SN OR BX	L.95
1335450000	SLF 5.08/03/180 SN OR BX	L.95
1335460000	SLF 5.08/04/180 SN OR BX	L.95
1335470000	SLF 5.08/05/180 SN OR BX	L.95
1335480000	SLF 5.08/06/180 SN OR BX	L.95
1335490000	SLF 5.08/07/180 SN OR BX	L.95
1335510000	SLF 5.08/08/180 SN OR BX	L.95
1335520000	SLF 5.08/09/180 SN OR BX	L.95
1335530000	SLF 5.08/10/180 SN OR BX	L.95
1335540000	SLF 5.08/11/180 SN OR BX	L.95
1335550000	SLF 5.08/12/180 SN OR BX	L.95
1335590000	SLF 5.08/02/180F SN OR BX	L.95
1335620000	SLF 5.08/03/180F SN OR BX	L.95
1335640000	SLF 5.08/04/180F SN OR BX	L.95
1335650000	SLF 5.08/05/180F SN OR BX	L.95
1335660000	SLF 5.08/06/180F SN OR BX	L.95
1335670000	SLF 5.08/07/180F SN OR BX	L.95
1335680000	SLF 5.08/08/180F SN OR BX	L.95
1335690000	SLF 5.08/09/180F SN OR BX	L.95
1335700000	SLF 5.08/10/180F SN OR BX	L.95
1335710000	SLF 5.08/11/180F SN OR BX	L.95
1335720000	SLF 5.08/12/180F SN OR BX	L.95
1336400000	SLF 5.08/02/180F SN OR BX	L.95
1336410000	SLF 5.08/03/180F SN OR BX	L.95
1336420000	SLF 5.08/04/180F SN OR BX	L.95
1336430000	SLF 5.08/05/180F SN OR BX	L.95
1336440000	SLF 5.08/06/180F SN OR BX	L.95
1336450000	SLF 5.08/07/180F SN OR BX	L.95
1336470000	SLF 5.08/08/180F SN OR BX	L.95
1336480000	SLF 5.08/09/180F SN OR BX	L.95
1336490000	SLF 5.08/10/180F SN OR BX	L.95
1336510000	SLF 5.08/11/180F SN OR BX	L.95
1337640000	CH20M45 F TYL 2083	T.28

1340000000

1341270000	BUL 1.0.16HP/03/180 4.5AG BK BX SO	P.248
1346320000	ESG 6.6/15 BHZ 5.00 SDR	T.37
1346330000	ESG 6.6/11 BHZ 5.00 SDR	T.37

1350000000

1350230000	CH20M22 F TYL 2083	T.26
1351330000	BLT 5.08HC/02/180DF SN OR BX	L.86
1351340000	BLT 5.08HC/03/180DF SN OR BX	L.86
1351350000	BLT 5.08HC/04/180DF SN OR BX	L.86
1351370000	BLT 5.08HC/05/180DF SN OR BX	L.86
1351380000	BLT 5.08HC/06/180DF SN OR BX	L.86
1351390000	BLT 5.08HC/07/180DF SN OR BX	L.86
1351320000	BLT 5.08HC/08/180DF SN OR BX	L.86
1353220000	BLT 5.08HC/09/180DF SN OR BX	L.86
1353230000	BLT 5.08HC/10/180DF SN OR BX	L.86
1353240000	BLF 5.08HC/02/180DF SN OR BX	L.88
1353250000	BLF 5.08HC/03/180DF SN OR BX	L.88
1353270000	BLF 5.08HC/04/180DF SN OR BX	L.88
1353280000	BLF 5.08HC/05/180DF SN OR BX	L.88
1353290000	BLF 5.08HC/07/180DF SN OR BX	L.88
1353300000	BLF 5.08HC/08/180DF SN OR BX	L.88
1353320000	BLF 5.08HC/09/180DF SN OR BX	L.88
1353330000	BLF 5.08HC/10/180DF SN OR BX	L.88
1353340000	BLF 5.08HC/06/180DF SN OR BX	L.88
1353470000	SLS 5.08/02/180DF SN OR BX	L.82
1353480000	SLS 5.08/03/180DF SN OR BX	L.82
1353490000	SLS 5.08/04/180DF SN OR BX	L.82
1353500000	SLS 5.08/05/180DF SN OR BX	L.82
1353510000	SLS 5.08/06/180DF SN OR BX	L.82
1353520000	SLS 5.08/07/180DF SN OR BX	L.82
1353530000	SLS 5.08/08/180DF SN OR BX	L.82
1353540000	SLS 5.08/09/180DF SN OR BX	L.82
1353550000	SLS 5.08/10/180DF SN OR BX	L.82
1353560000	SLS 5.08/11/180DF SN OR BX	L.82
1353570000	SLS 5.08/12/180DF SN OR BX	L.82
1353580000	SLF 5.08/02/180DF SN OR BX	L.84

Order No.	Type	Page
1353590000	SLF 5.08/03/180DF SN OR BX	L.84
1353600000	SLF 5.08/04/180DF SN OR BX	L.84
1353620000	SLF 5.08/05/180DF SN OR BX	L.84
1353630000	SLF 5.08/06/180DF SN OR BX	L.84
1353640000	SLF 5.08/07/180DF SN OR BX	L.84
1353650000	SLF 5.08/08/180DF SN OR BX	L.84
1353670000	SLF 5.08/09/180DF SN OR BX	L.84
1353680000	SLF 5.08/10/180DF SN OR BX	L.84
1356830000	LL 6.35/02/90V 5.0SN BK BX	0.16
1356840000	LL 6.35/03/90V 5.0SN BK BX	0.16
1356850000	LL 6.35/04/90V 5.0SN BK BX	0.16
1356870000	LL 6.35/05/90V 5.0SN BK BX	0.16
1356880000	LL 6.35/06/90V 5.0SN BK BX	0.16
1356890000	LL 6.35/07/90V 5.0SN BK BX	0.16
1356900000	LL 6.35/08/90V 5.0SN BK BX	0.16
1356920000	LL 6.35/09/90V 5.0SN BK BX	0.16
1356930000	LL 6.35/10/90V 5.0SN BK BX	0.16
1356940000	LL 6.35/11/90V 5.0SN BK BX	0.16
1356950000	LL 6.35/12/90V 5.0SN BK BX	0.16
1357900000	S2CD-THR 3.50/08/90G 3.2SN BK BX	J.10
1357800		

Order No.	Type	Page
1426800000	CB1,6R18-16 AU,75 I2,5	M.16
1426900000	CB1,6E18-16 AU,75 I2,5	M.16
1427220000	SVF 7.62HP/02/180SFMF2 SN BK BX	P.180
1427230000	SVF 7.62HP/03/180SFMF2 SN BK BX	P.180
1427240000	SVF 7.62HP/03/180SFMF3 SN BK BX	P.181
1427250000	SVF 7.62HP/04/180SFMF2 SN BK BX	P.180
1427260000	SVF 7.62HP/04/180SFMF3 SN BK BX	P.181
1427270000	SVF 7.62HP/04/180SFMF4 SN BK BX	P.181
1427500000	CS1,6R18-16 SN I2,5	M.16
1427600000	CS1,6E18-16 SN I2,5	M.16
1427700000	CSL1,6E18-16 SN I2,5	M.16
1427800000	CB1,6R18-16 SN I2,5	M.16
1427900000	CB1,6E18-16 SN I2,5	M.16
1428500000	CS1,6R14-12 AU,75 I3,5	M.16
1428600000	CS1,6E14-12 AU,75 I3,5	M.16
1428700000	CSL1,6E14-12 AU,75 I3,5	M.16
1428800000	CB1,6R14-12 AU,75 I3,5	M.16
1428900000	CB1,6E14-12 AU,75 I3,5	M.16
1429500000	CS1,6R14-12 SN I3,5	M.16
1429600000	CS1,6E14-12 SN I3,5	M.16
1429700000	CSL1,6E14-12 SN I3,5	M.16
1429800000	CB1,6R14-12 SN I3,5	M.16
1429900000	CB1,6E14-12 SN I3,5	M.16
1429920000	SVF 7.62HP/02/180SFBMF2 SN BK BX	P.182
1429930000	SVF 7.62HP/03/180SFBMF2 SN BK BX	P.182
1429940000	SVF 7.62HP/03/180SFBMF3 SN BK BX	P.183
1429950000	SVF 7.62HP/04/180SFBMF2 SN BK BX	P.182
1429960000	SVF 7.62HP/04/180SFBMF3 SN BK BX	P.183
1429970000	SVF 7.62HP/04/180SFBMF4 SN BK BX	P.183

1430000000

1430010000	SVF 7.62HP/04/180MF2 SN BK BX	P.176
1430020000	SVF 7.62HP/05/180MF2 SN BK BX	P.176
1430030000	SVF 7.62HP/04/180MF4 SN BK BX	P.177
1430060000	SVF 7.62HP/04/180MF2 SN BK BX	P.178
1430070000	SVF 7.62HP/05/180MF2 SN BK BX	P.178
1430080000	SVF 7.62HP/04/180MF4 SN BK BX	P.179
1430090000	BVF 7.62HP/04/180MF2 SN BK BX	P.198
1430100000	BVF 7.62HP/05/180MF2 SN BK BX	P.198
1430110000	BVF 7.62HP/04/180MF4 SN BK BX	P.199
1430120000	BVF 7.62HP/04/180MF2 SN BK BX	P.196
1430130000	BVF 7.62HP/05/180MF2 SN BK BX	P.196
1430140000	BVF 7.62HP/04/180MF4 SN BK BX	P.197
1432860000	CH20M22 S PSCSC LGY 2018	T.27
1433800000	RJ45C5 T1D 3.2N4N TY	D.20
1433810000	RJ45C5 T1V 3.2N4N TY	D.19
1433890000	RJ45C5 S1D 2.7N4N RL	D.9
1433900000	RJ45C5 S1V 2.7N4N RL	D.6
1433910000	RJ45C6 T1U 2.7N4N TY	D.22

1440000000

1440200000	RSV1,6 LB4 GR 3,2 AU	M.12
1440300000	RSV1,6 LB4 GR 3,2 SN	M.8
1440400000	RSV1,6 LS4 GR 3,2 AU	M.10
1440500000	RSV1,6 LS4 GR 3,2 SN	M.6
1440600000	RSV1,6 LB4 GR 3,2 AU	M.13
1440700000	RSV1,6 LB4 GR 3,2 SN	M.9
1440800000	RSV1,6 LS4 GR 3,2 AU	M.11
1440850000	SVF/BVF 7.62HP COUPLE SET	P.180
1440850000	SVF/BVF 7.62HP COUPLE SET	P.182
1440850000	SVF/BVF 7.62HP COUPLE SET	P.196
1440850000	SVF/BVF 7.62HP COUPLE SET	P.198
1440850000	SVF/BVF 7.62HP COUPLE SET	P.202
1440850000	SVF/BVF 7.62HP COUPLE SET	S.2
1440900000	RSV1,6 LS4 GR 3,2 SN	M.7
1441200000	RSV1,6 LB6 GR 3,2 AU	M.12
1441300000	RSV1,6 LB6 GR 3,2 SN	M.8
1441400000	RSV1,6 LS6 GR 3,2 AU	M.10
1441500000	RSV1,6 LS6 GR 3,2 SN	M.6
1441600000	RSV1,6 LB6 GR 3,2 AU	M.13
1441700000	RSV1,6 LB6 GR 3,2 SN	M.9
1441800000	RSV1,6 LS6 GR 3,2 AU	M.11
1441900000	RSV1,6 LS6 GR 3,2 SN	M.7
1442000000	RSV1,6 LB9 GR 3,2 AU	M.12
1442300000	RSV1,6 LB9 GR 3,2 SN	M.8
1442400000	RSV1,6 LS9 GR 3,2 AU	M.10
1442500000	RSV1,6 LS9 GR 3,2 SN	M.6
1442600000	RSV1,6 LB9 GR 3,2 AU	M.13
1442700000	RSV1,6 LB9 GR 3,2 SN	M.9
1442800000	RSV1,6 LS9 GR 3,2 AU	M.11
1442900000	RSV1,6 LS9 GR 3,2 SN	M.7
1443000000	RSV1,6 LB12 GR 3,2 AU	M.12
1443300000	RSV1,6 LB12 GR 3,2 SN	M.8
1443400000	RSV1,6 LS12 GR 3,2 AU	M.10
1443500000	RSV1,6 LS12 GR 3,2 SN	M.6
1443600000	RSV1,6 LB12 GR 3,2 AU	M.13
1443700000	RSV1,6 LB12 GR 3,2 SN	M.9
1443800000	RSV1,6 LS12 GR 3,2 AU	M.11
1443900000	RSV1,6 LS12 GR 3,2 SN	M.7
1444200000	RSV1,6 LB18 GR 3,2 AU	M.12
1444300000	RSV1,6 LB18 GR 3,2 SN	M.8
1444330000	CH20M45 S 3P/3P LGY 2018	T.29
1444400000	RSV1,6 LS18 GR 3,2 AU	M.10
1444500000	RSV1,6 LS18 GR 3,2 SN	M.6
1444600000	RSV1,6 LB18 GR 3,2 AU	M.13
1444700000	RSV1,6 LB18 GR 3,2 SN	M.9
1444800000	RSV1,6 LS18 GR 3,2 AU	M.11

Order No.	Type	Page
1444900000	RSV1,6 LSF18 GR 3,2 SN	M.7
1445200000	RSV1,6 LB24 GR 3,2 AU	M.12
1445300000	RSV1,6 LB24 GR 3,2 SN	M.8
1445400000	RSV1,6 LS24 GR 3,2 AU	M.10
1445500000	RSV1,6 LS24 GR 3,2 SN	M.6
1445600000	RSV1,6 LB24 GR 3,2 AU	M.13
1445700000	RSV1,6 LBF24 GR 3,2 SN	M.9
1445800000	RSV1,6 LSF24 GR 3,2 AU	M.11
1445900000	RSV1,6 LSF24 GR 3,2 SN	M.7
1446060000	SLA B88 RH OR	L.92
1446060000	SLA B88 RH OR	L.93
1446200000	RSV1,6 LB36 GR 3,2 AU	M.12
1446300000	RSV1,6 LB36 GR 3,2 SN	M.8
1446400000	RSV1,6 LS36 GR 3,2 AU	M.10
1446500000	RSV1,6 LS36 GR 3,2 SN	M.6
1446600000	RSV1,6 LBF36 GR 3,2 AU	M.13
1446700000	RSV1,6 LBF36 GR 3,2 SN	M.9
1446800000	RSV1,6 LSF36 GR 3,2 AU	M.11
1446900000	RSV1,6 LSF36 GR 3,2 SN	M.7

1450000000

1451120000	CH20M22 S PSCSC GGY 2019	T.27
1455220000	RJ45C5 S1U 0.9N4N RL	D.10
1455240000	RJ45C5 T1U 2.8N4N TY	D.23
1455700000	CH20M67 S 3P/3P/3P GGY 2019	T.31

1460000000

1464270000	SV 7.62HP/04/90MF2 3.5SN BK BX	P.160
1464280000	SV 7.62HP/05/90MF2 3.5SN BK BX	P.160
1464290000	SV 7.62HP/04/90MF4 3.5SN BK BX	P.161
1464310000	SV 7.62HP/04/180MF2 3.5SN BK BX	P.164
1464320000	SV 7.62HP/05/180MF2 3.5SN BK BX	P.164
1464330000	SV 7.62HP/04/180MF4 3.5SN BK BX	P.165
1464340000	SV 7.62HP/04/270MF2 3.5SN BK BX	P.168
1464350000	SV 7.62HP/05/270MF2 3.5SN BK BX	P.168
1464360000	SV 7.62HP/04/270MF4 3.5SN BK BX	P.169

1470000000

1470700000	CH20M22 S RPP LGY 2018	T.27
1472240000	SL 7.62HP/02/270G 3.2SN BK BX	P.122
1472250000	SL 7.62HP/03/270G 3.2SN BK BX	P.122
1472260000	SL 7.62HP/04/270G 3.2SN BK BX	P.122
1472270000	SL 7.62HP/05/270G 3.2SN BK BX	P.122
1472280000	SL 7.62HP/06/270G 3.2SN BK BX	P.122
1472290000	SL 7.62HP/07/270G 3.2SN BK BX	P.122
1472310000	SL 7.62HP/08/270G 3.2SN BK BX	P.122
1472320000	SL 7.62HP/09/270G 3.2SN BK BX	P.122
1472330000	SL 7.62HP/10/270G 3.2SN BK BX	P.122
1472340000	SL 7.62HP/11/270G 3.2SN BK BX	P.122
1472350000	SL 7.62HP/12/270G 3.2SN BK BX	P.122
1472360000	SL 7.62HP/02/270F 3.2SN BK BX	P.123
1472370000	SL 7.62HP/03/270F 3.2SN BK BX	P.123
1472380000	SL 7.62HP/04/270F 3.2SN BK BX	P.123
1472390000	SL 7.62HP/05/270F 3.2SN BK BX	P.123
1472410000	SL 7.62HP/06/270F 3.2SN BK BX	P.123
1472420000	SL 7.62HP/07/270F 3.2SN BK BX	P.123
1472430000	SL 7.62HP/08/270F 3.2SN BK BX	P.123
1472440000	SL 7.62HP/09/270F 3.2SN BK BX	P.123
1472450000	SL 7.62HP/10/270F 3.2SN BK BX	P.123
1472460000	SL 7.62HP/11/270F 3.2SN BK BX	P.123
1472470000	SL 7.62HP/12/270F 3.2SN BK BX	P.123
1472800000	CH20M22 B FE AGY/BK 3747	T.26
1472810000	CH20M22 FE AGY 3747	T.26
1472820000	CH20M22 S RPP AGY 3747	T.27
1473310000	LSF-SMD 3.50/02/135 SN BK RL	G.83
1473320000	LSF-SMD 3.50/03/135 SN BK RL	G.83
1473330000	LSF-SMD 3.50/04/135 SN BK RL	G.83
1473340000	LSF-SMD 3.50/05/135 SN BK RL	G.83
1473350000	LSF-SMD 3.50/06/135 SN BK RL	G.83
1473370000	LSF-SMD 3.50/07/135 SN BK RL	G.83
1473380000	LSF-SMD 3.50/08/135 SN BK RL	G.83
1473390000	LSF-SMD 3.50/09/135 SN BK RL	G.83
1473410000	LSF-SMD 3.50/10/135 SN BK RL	G.83
1473420000	LSF-SMD 3.50/11/135 SN BK RL	G.83
1473430000	LSF-SMD 3.50/12/135 SN BK RL	G.83
1473510000	LSF-SMD 3.50/04/90 SN BK RL	G.82
1473520000	LSF-SMD 3.50/05/90 SN BK RL	G.82
1473530000	LSF-SMD 3.50/06/90 SN BK RL	G.82
1473540000	LSF-SMD 3.50/07/90 SN BK RL	G.82
1473550000	LSF-SMD 3.50/08/90 SN BK RL	G.82
1473560000	LSF-SMD 5.00/02/180 SN BK RL	G.85
1473570000	LSF-SMD 3.50/09/90 SN BK RL	G.82
1473580000	LSF-SMD 5.00/03/180 SN BK RL	G.85
1473590000	LSF-SMD 3.50/10/90 SN BK RL	G.82
1473610000	LSF-SMD 5.00/04/180 SN BK RL	G.85
1473620000	LSF-SMD 3.50/11/90 SN BK RL	G.82
1473640000	LSF-SMD 5.00/05/180 SN BK RL	G.85
1473650000	LSF-SMD 3.50/12/90 SN BK RL	G.82
1473660000	LSF-SMD 5.00/06/180 SN BK RL	G.85
1473670000	LSF-SMD 5.00/07/180 SN BK RL	G.85
1473680000	LSF-SMD 5.00/08/180 SN BK RL	G.85
1473690000	LSF-SMD 5.00/02/135 SN BK RL	G.85
1473700000	LSF-SMD 5.00/03/135 SN BK RL	G.85
1473710000	LSF-SMD 5.00/04/135 SN BK RL	G.85
1473720000	LSF-SMD 5.00/05/135 SN BK RL	G.85
1473740000	LSF-SMD 5.00/06/135 SN BK RL	G.85

Order No.	Type	Page
1473750000	LSF-SMD 5.00/07/135 SN BK RL	G.85
1473760000	LSF-SMD 5.00/08/135 SN BK RL	G.85
1473770000	LSF-SMD 5.00/02/90 SN BK RL	G.84
1473780000	LSF-SMD 5.00/03/90 SN BK RL	G.84
1473790000	LSF-SMD 5.00/04/90 SN BK RL	G.84
1473800000	LSF-SMD 5.00/05/90 SN BK RL	G.84
1473810000	LSF-SMD 5.00/06/90 SN BK RL	G.84
1473820000	LSF-SMD 5.00/07/90 SN BK RL	G.84
1473830000	LSF-SMD 5.00/08/90 SN BK RL	G.84
1473840000	LSF-SMD 7.50/02/180 SN BK RL	G.87
1473850000	LSF-SMD 7.50/03/180 SN BK RL	G.87
1473860000	LSF-SMD 7.50/04/180 SN BK RL	G.87
1473870000	LSF-SMD 7.50/05/180 SN BK RL	G.87
1473880000	LSF-SMD 7.50/06/180 SN BK RL	G.87
1473890000	LSF-SMD 7.50/02/135 SN BK RL	G.87
1473900000	LSF-SMD 7.50/03/135 SN BK RL	G.87
1473910000	LSF-SMD 7.50/04/135 SN BK RL	G.87
1473920000	LSF-SMD 7.50/05/135 SN BK RL	G.87
1473930000	LSF-SMD 7.50/06/135 SN BK RL	G.87
1473940000	LSF-SMD 7.50/02/90 SN BK RL	G.86
1473950000	LSF-SMD 7.50/03/90 SN BK RL	G.86
1473960000	LSF-SMD 7.50/04/90 SN BK RL	G.86
1473970000	LSF-SMD 7.50/05/90 SN BK RL	G.86
1473980000	LSF-SMD 7.50/06/90 SN BK RL	G.86
1476000000	CH20M45 B BUS BK/BK 2010	T.28
1476910000	CH20M45 S 2PSC/2PSC BL 2013	T.29

1480000000

1480000000	DFFC 0.5-1.0 SN 3000	L.116
1480100000	DFFC 1.5-2.5 SN 2500	L.116
1482830000	CH20M45 S 3P/3P TYL 2083	T.29

1490000000

1490820000	CH20M67 B BUS BK/BK 2010	T.30
1497500000	BHF 5.00/04/180LBK/BK	T.37
1497670000	BHF 5.00/03/180LBK/BK	T.37
1497740000	BHF 5.00/02/180LBK/BK	T.37
1499560000	BLT 5.08HC/02/180 SN DR BX	L.104
1499660000	BLT 5.08HC/03/180 SN DR BX	L.104
1499760000	BLT 5.08HC/04/180 SN DR BX	L.104
1499860000	BLT 5.08HC/05/180 SN DR BX	L.104
1499960000	BLT 5.08HC/06/180 SN DR BX	L.104

1500000000

1500040000	CH20M45 S RPSC/2PSC BK 2010	T.29
1500050000	CH20M45 S 2PSC/RUSC BK 2010	T.29
1500060000	BLT 5	

Order No.	Type	Page
1609801044	DEK 5/5 MC NE WS	R.24
1609801044	DEK 5/5 MC NE WS	R.12
1609801044	DEK 5/5 MC NE WS	R.14
1609801044	DEK 5/5 MC NE WS	R.16
1609801044	DEK 5/5 MC NE WS	R.18
1609801044	DEK 5/5 MC NE WS	R.20
1609801044	DEK 5/5 MC NE WS	R.22
1609801044	DEK 5/5 MC NE WS	R.24
1609820000	DEK 5/6 MC NE WS	R.12
1609820000	DEK 5/6 MC NE WS	R.14
1609820000	DEK 5/6 MC NE WS	R.16
1609820000	DEK 5/6 MC NE WS	R.18
1609820000	DEK 5/6 MC NE WS	R.20
1609820000	DEK 5/6 MC NE WS	R.22
1609820000	DEK 5/6 MC NE WS	R.24
1609860000	WS 12/5 MC NE WS	T.56

161000000

1610100000	BL SL 3.5 KO SW	J.30
1610100000	BL SL 3.5 KO SW	J.32
1610100000	BL SL 3.5 KO SW	J.34
1610100000	BL SL 3.5 KO SW	J.36
1610100000	BL SL 3.5 KO SW	J.38
1610100000	BL SL 3.5 KO SW	J.40
1610100000	BL SL 3.5 KO SW	J.41
1610100000	BL SL 3.5 KO SW	J.42
1610100000	BL SL 3.5 KO SW	J.44
1610100000	BL SL 3.5 KO SW	J.46
1610100000	BL SL 3.5 KO SW	J.48
1610100000	BL SL 3.5 KO SW	J.50
1610100000	BL SL 3.5 KO SW	J.52
1610100000	BL SL 3.5 KO SW	J.54
1610100000	BL SL 3.5 KO SW	J.56
1610100000	BL SL 3.5 KO SW	J.58
1610100000	BL SL 3.5 KO SW	J.60
1610100000	BL SL 3.5 KO SW	N.10

1610490000	BLC 5.08/02/180R DR BX	L.116
1610500000	BLC 5.08/03/180R DR BX	L.116
1610510000	BLC 5.08/04/180R DR BX	L.116
1610520000	BLC 5.08/05/180R DR BX	L.116
1610530000	BLC 5.08/06/180R DR BX	L.116
1610540000	BLC 5.08/07/180R DR BX	L.116
1610550000	BLC 5.08/08/180R DR BX	L.116
1610560000	BLC 5.08/09/180R DR BX	L.116
1610570000	BLC 5.08/10/180R DR BX	L.116
1610580000	BLC 5.08/11/180R DR BX	L.116
1610590000	BLC 5.08/12/180R DR BX	L.116
1610740000	PTSC KA 2 2X4.5 WN1412	J.16
1610740000	PTSC KA 2 2X4.5 WN1412	J.30
1610740000	PTSC KA 2 2X4.5 WN1412	J.36
1610740000	PTSC KA 2 2X4.5 WN1412	J.38
1610740000	PTSC KA 2 2X4.5 WN1412	K.18
1610740000	PTSC KA 2 2X4.5 WN1412	K.24
1610740000	PTSC KA 2 2X4.5 WN1412	K.28
1610740000	PTSC KA 2 2X4.5 WN1412	K.36
1610740000	PTSC KA 2 2X4.5 WN1412	K.42
1614350000	SLD 5.00/04/90G 3.2 SN DR BX	L.38
1614360000	SLD 5.00/06/90G 3.2 SN DR BX	L.38
1614370000	SLD 5.00/08/90G 3.2 SN DR BX	L.38
1614380000	SLD 5.00/10/90G 3.2 SN DR BX	L.38
1614390000	SLD 5.00/12/90G 3.2 SN DR BX	L.38
1614400000	SLD 5.00/14/90G 3.2 SN DR BX	L.38
1614410000	SLD 5.00/16/90G 3.2 SN DR BX	L.38
1614420000	SLD 5.00/18/90G 3.2 SN DR BX	L.38
1614430000	SLD 5.00/20/90G 3.2 SN DR BX	L.38
1614440000	SLD 5.00/22/90G 3.2 SN DR BX	L.38
1614450000	SLD 5.00/24/90G 3.2 SN DR BX	L.38
1614810000	SLD 5.00/04/180G 3.2 SN DR BX	L.39
1614820000	SLD 5.00/06/180G 3.2 SN DR BX	L.39
1614830000	SLD 5.00/08/180G 3.2 SN DR BX	L.39
1614840000	SLD 5.00/10/180G 3.2 SN DR BX	L.39
1614850000	SLD 5.00/12/180G 3.2 SN DR BX	L.39
1614860000	SLD 5.00/14/180G 3.2 SN DR BX	L.39
1614870000	SLD 5.00/16/180G 3.2 SN DR BX	L.39
1614880000	SLD 5.00/18/180G 3.2 SN DR BX	L.39
1614890000	SLD 5.00/20/180G 3.2 SN DR BX	L.39
1614900000	SLD 5.00/22/180G 3.2 SN DR BX	L.39
1614910000	SLD 5.00/24/180G 3.2 SN DR BX	L.39

162000000

1622940000	BLL 5.08/02/90 3.2 SN DR BX	L.118
1622950000	BLL 5.08/03/90 3.2 SN DR BX	L.118
1622960000	BLL 5.08/04/90 3.2 SN DR BX	L.118
1622970000	BLL 5.08/05/90 3.2 SN DR BX	L.118
1622980000	BLL 5.08/06/90 3.2 SN DR BX	L.118
1622990000	BLL 5.08/07/90 3.2 SN DR BX	L.118
1623000000	BLL 5.08/08/90 3.2 SN DR BX	L.118
1623010000	BLL 5.08/09/90 3.2 SN DR BX	L.118
1623020000	BLL 5.08/10/90 3.2 SN DR BX	L.118
1623030000	BLL 5.08/11/90 3.2 SN DR BX	L.118
1623040000	BLL 5.08/12/90 3.2 SN DR BX	L.118
1626880000	SLA BB12R SW	N.6
1627090000	SLS 5.08/02/180 SN DR BX	L.90
1627100000	SLS 5.08/03/180 SN DR BX	L.90
1627110000	SLS 5.08/04/180 SN DR BX	L.90
1627120000	SLS 5.08/05/180 SN DR BX	L.90

Order No.	Type	Page
1627130000	SLS 5.08/06/180 SN DR BX	L.90
1627140000	SLS 5.08/07/180 SN DR BX	L.90
1627150000	SLS 5.08/08/180 SN DR BX	L.90
1627160000	SLS 5.08/09/180 SN DR BX	L.90
1627170000	SLS 5.08/10/180 SN DR BX	L.90
1627180000	SLS 5.08/11/180 SN DR BX	L.90
1627190000	SLS 5.08/12/180 SN DR BX	L.90
1627240000	SLS 5.08/02/180B SN DR BX	L.91
1627250000	SLS 5.08/03/180B SN DR BX	L.91
1627260000	SLS 5.08/04/180B SN DR BX	L.91
1627270000	SLS 5.08/05/180B SN DR BX	L.91
1627280000	SLS 5.08/06/180B SN DR BX	L.91
1627290000	SLS 5.08/07/180B SN DR BX	L.91
1627300000	SLS 5.08/08/180B SN DR BX	L.91
1627310000	SLS 5.08/09/180B SN DR BX	L.91
1627320000	SLS 5.08/10/180B SN DR BX	L.91
1627330000	SLS 5.08/11/180B SN DR BX	L.91
1627340000	SLS 5.08/12/180B SN DR BX	L.91
1627820000	BL 3.50 ZE03 BK BX	J.12
1627820000	BL 3.50 ZE03 BK BX	J.48
1627820000	BL 3.50 ZE03 BK BX	N.2
1627830000	BL 3.50 ZE08 BK BX	N.2
1629680000	BL 3.50 ZE03 DR BX	J.12
1629680000	BL 3.50 ZE03 DR BX	J.48
1629680000	BL 3.50 ZE03 DR BX	N.2
1629690000	BL 3.50 ZE08 DR BX	J.12
1629690000	BL 3.50 ZE08 DR BX	J.48
1629690000	BL 3.50 ZE08 DR BX	N.2
1629900000	KSX 2.5 < 50MM SDR	N.13
1629910000	KSX 4 < 50MM SDR	N.13
1629920000	KSX 2.5 < 100MM SONDR	N.13
1629930000	KSX 4 < 100MM SDR	N.13
1629940000	KSX 2.5 < 150MM SONDR	N.13
1629950000	KSX 4 < 150MM SONDR	N.13

163000000

1630100000	KSX 2.5 8/5,08 1-8	N.13
1630150000	KSX 4 16/3,5 1-16	N.13
1630160000	KSX 4 16/5,08 1-16	N.13
1630180000	KSX 4 24/5,08 1-24	N.13
1630200000	KSX 4 8/5,08 1-8	N.13
1630250000	SL 5.00/02/135 3.2SN DR BX	L.36
1630260000	SL 5.00/03/135 3.2SN DR BX	L.36
1630270000	SL 5.00/04/135 3.2SN DR BX	L.36
1630280000	SL 5.00/05/135 3.2SN DR BX	L.36
1630290000	SL 5.00/06/135 3.2SN DR BX	L.36
1630300000	SL 5.00/07/135 3.2SN DR BX	L.36
1630310000	SL 5.00/08/135 3.2SN DR BX	L.36
1630320000	SL 5.00/09/135 3.2SN DR BX	L.36
1630330000	SL 5.00/10/135 3.2SN DR BX	L.36
1630340000	SL 5.00/11/135 3.2SN DR BX	L.36
1630350000	SL 5.00/12/135 3.2SN DR BX	L.36
1630480000	SL 5.00/02/135G 3.2SN DR BX	L.37
1630490000	SL 5.00/03/135G 3.2SN DR BX	L.37
1630500000	SL 5.00/04/135G 3.2SN DR BX	L.37
1630510000	SL 5.00/05/135G 3.2SN DR BX	L.37
1630520000	SL 5.00/06/135G 3.2SN DR BX	L.37
1630530000	SL 5.00/07/135G 3.2SN DR BX	L.37
1630540000	SL 5.00/08/135G 3.2SN DR BX	L.37
1630550000	SL 5.00/09/135G 3.2SN DR BX	L.37
1630560000	SL 5.00/10/135G 3.2SN DR BX	L.37
1630570000	SL 5.00/11/135G 3.2SN DR BX	L.37
1630580000	SL 5.00/12/135G 3.2SN DR BX	L.37
1630710000	BLL 5.08/02/180 3.2 SN DR BX	L.120
1630720000	BLL 5.08/03/180 3.2 SN DR BX	L.120
1630730000	BLL 5.08/04/180 3.2 SN DR BX	L.120
1630740000	BLL 5.08/05/180 3.2 SN DR BX	L.120
1630750000	BLL 5.08/06/180 3.2 SN DR BX	L.120
1630760000	BLL 5.08/07/180 3.2 SN DR BX	L.120
1630770000	BLL 5.08/08/180 3.2 SN DR BX	L.120
1630780000	BLL 5.08/09/180 3.2 SN DR BX	L.120
1630790000	BLL 5.08/10/180 3.2 SN DR BX	L.120
1630800000	BLL 5.08/11/180 3.2 SN DR BX	L.120
1630810000	BLL 5.08/12/180 3.2 SN DR BX	L.120
1633560000	SLD 3.50/04/90G 3.2SN DR BX	J.42
1633580000	SLD 3.50/06/90G 3.2SN DR BX	J.42
1633590000	SLD 3.50/08/90G 3.2SN DR BX	J.42
1633600000	SLD 3.50/10/90G 3.2SN DR BX	J.42
1633610000	SLD 3.50/12/90G 3.2SN DR BX	J.42
1633620000	SLD 3.50/14/90G 3.2SN DR BX	J.42
1633630000	SLD 3.50/16/90G 3.2SN DR BX	J.42
1633640000	SLD 3.50/18/90G 3.2SN DR BX	J.42
1633650000	SLD 3.50/20/90G 3.2SN DR BX	J.42
1633660000	SLD 3.50/22/90G 3.2SN DR BX	J.42
1633670000	SLD 3.50/24/90G 3.2SN DR BX	J.42
1633810000	SLD 3.50/04/90F 3.2SN DR BX	J.43
1633820000	SLD 3.50/06/90F 3.2SN DR BX	J.43
1633830000	SLD 3.50/08/90F 3.2SN DR BX	J.43
1633840000	SLD 3.50/10/90F 3.2SN DR BX	J.43
1633850000	SLD 3.50/12/90F 3.2SN DR BX	J.43
1633860000	SLD 3.50/14/90F 3.2SN DR BX	J.43
1633870000	SLD 3.50/16/90F 3.2SN DR BX	J.43
1633880000	SLD 3.50/18/90F 3.2SN DR BX	J.43
1633890000	SLD 3.50/20/90F 3.2SN DR BX	J.43
1633900000	SLD 3.50/22/90F 3.2SN DR BX	J.43
1633910000	SLD 3.50/24/90F 3.2SN DR BX	J.43
1635000000	WS 10/5 MC NE WS	T.56
1636370000	SL 135 BB15R SW	L.36

Order No.	Type	Page
1636370000	SL 135 BB15R SW	N.6
1636670000	SL FLA 2,3/1	L.22
1636670000	SL FLA 2,3/1	L.24
1636670000	SL FLA 2,3/1	L.32
1636670000	SL FLA 2,3/1	L.50
1636670000	SL FLA 2,3/1	L.52
1636670000	SL FLA 2,3/1	L.54
1636670000	SL FLA 2,3/1	L.68
1636670000	SL FLA 2,3/1	L.70
1636670000	SL FLA 2,3/1	N.9
1636680000	SL FLA 2,3/24	L.22
1636680000	SL FLA 2,3/24	L.24
1636680000	SL FLA 2,3/24	L.32
1636680000	SL FLA 2,3/24	L.50
1636680000	SL FLA 2,3/24	L.52
1636680000	SL FLA 2,3/24	L.54
1636680000	SL FLA 2,3/24	L.68
1636680000	SL FLA 2,3/24	L.70
1636680000	SL FLA 2,3/24	N.9
1638550000	BL 3.50/02/90 SN DR BX	J.50
1638560000	BL 3.50/03/90 SN DR BX	J.50
1638570000	BL 3.50/04/90 SN DR BX	J.50
1638580000	BL 3.50/05/90 SN DR BX	J.50
1638590000	BL 3.50/06/90 SN DR BX	J.50
1638600000	BL 3.50/07/90 SN DR BX	J.50
1638610000	BL 3.50/08/90 SN DR BX	J.50
1638620000	BL 3.50/09/90 SN DR BX	J.50
1638630000	BL 3.50/10/90 SN DR BX	J.50
1638640000	BL 3.50/11/90 SN DR BX	J.50
1638650000	BL 3.50/12/90 SN DR BX	J.50
1639010000	BL 3.50/02/90F SN DR BX	J.51
1639020000	BL 3.50/03/90F SN DR BX	J.51
1639030000	BL 3.50/04/90F SN DR BX	J.51
1639040000	BL 3.50/05/90F SN DR BX	J.51
1639050000	BL 3.50/06/90F SN DR BX	J.51
1639060000	BL 3.50/07/90F SN DR BX	J.51
1639070000	BL 3.50/08/90F SN DR BX	J.51
1639080000	BL 3.50/09/90F SN DR BX	J.51
1639090000	BL 3.50/10/90F SN DR BX	J.51
1639100000	BL 3.50/11/90F SN DR BX	J.51
1639110000	BL 3.50/12/90F SN DR BX	J.51
1639470000	BL 3.50/02/270 SN DR BX	J.51
1639480000	BL 3.50/03/270 SN DR BX	J.51
1639490000	BL 3.50/04/270 SN DR BX	J.51
1639500000	BL 3.50/05/270 SN DR BX	J.51
1639510000	BL 3.50/06/270 SN DR BX	J.51
1639520000	BL 3.50/07/270 SN DR BX	J.51
1639530000	BL 3.50/08/270 SN DR BX	J.51
1639540000	BL 3.50/09/270 SN DR BX	J.51
1639550000	BL 3.50/10/270 SN DR BX	J.51
1639560000	BL 3.50/11/270 SN DR BX	J.51
1639570000	BL 3.50/12/270 SN DR BX	J.51
1639930000	BL 3.50/02/270F SN DR BX	J.51
1639940000		

Order No.	Type	Page
1692340000	SLA BB11R SW	L.32
1692340000	SLA BB11R SW	L.34
1692340000	SLA BB11R SW	L.68
1692340000	SLA BB11R SW	L.72
1692340000	SLA BB11R SW	L.90
1692340000	SLA BB11R SW	L.118
1692340000	SLA BB11R SW	L.120
1692340000	SLA BB11R SW	N.6
1693430000	BL SL 3.5 KO DR	J.30
1693430000	BL SL 3.5 KO DR	J.32
1693430000	BL SL 3.5 KO DR	J.34
1693430000	BL SL 3.5 KO DR	J.36
1693430000	BL SL 3.5 KO DR	J.38
1693430000	BL SL 3.5 KO DR	J.40
1693430000	BL SL 3.5 KO DR	J.41
1693430000	BL SL 3.5 KO DR	J.42
1693430000	BL SL 3.5 KO DR	J.44
1693430000	BL SL 3.5 KO DR	J.46
1693430000	BL SL 3.5 KO DR	J.48
1693430000	BL SL 3.5 KO DR	J.50
1693430000	BL SL 3.5 KO DR	J.52
1693430000	BL SL 3.5 KO DR	J.54
1693430000	BL SL 3.5 KO DR	J.56
1693430000	BL SL 3.5 KO DR	J.58
1693430000	BL SL 3.5 KO DR	J.60
1693430000	BL SL 3.5 KO DR	N.10
1699580000	S2L/S2C 3.5 FLA 20/10	J.14
1699580000	S2L/S2C 3.5 FLA 20/10	N.8
1699800000	SCT 4.6/127 C	P.40
1699800000	SCT 4.6/127 C	P.42
1699800000	SCT 4.6/127 C	P.46

1700000000

1703700000	LM2N 3.50/04/90 3.2SN DR BX	G.21
1703710000	LM2N 3.50/06/90 3.2SN DR BX	G.21
1703720000	LM2N 3.50/08/90 3.2SN DR BX	G.21
1703730000	LM2N 3.50/10/90 3.2SN DR BX	G.21
1703740000	LM2N 3.50/12/90 3.2SN DR BX	G.21
1703750000	LM2N 3.50/14/90 3.2SN DR BX	G.21
1703760000	LM2N 3.50/16/90 3.2SN DR BX	G.21
1703770000	LM2N 3.50/18/90 3.2SN DR BX	G.21
1703780000	LM2N 3.50/20/90 3.2SN DR BX	G.21
1703790000	LM2N 3.50/22/90 3.2SN DR BX	G.21
1703800000	LM2N 3.50/24/90 3.2SN DR BX	G.21

1710000000

1713970001	KSW 2.5 16/5.08 W 1.16	N.13
1714980000	LM 3.50/02/135 3.2SN DR BX	G.19
1715020000	LM 3.50/03/135 3.2SN DR BX	G.19
1715310000	LM 5.00/02/90 3.5SN DR BX	G.24
1715320000	LM 5.00/03/90 3.5SN DR BX	G.24
1715330000	LM 5.00/02/180 3.5SN DR BX	G.25
1715340000	LM 5.00/03/180 3.5SN DR BX	G.25
1715350000	LM 5.00/02/135 3.5SN DR BX	G.25
1715360000	LM 5.00/03/135 3.5SN DR BX	G.25
1716080000	LM 5.08/02/90 3.5SN DR BX	G.26
1716090000	LM 5.08/03/90 3.5SN DR BX	G.26
1716100000	LM 5.08/02/180 3.5SN DR BX	G.27
1716110000	LM 5.08/03/180 3.5SN DR BX	G.27
1716120000	LM 5.08/02/135 3.5SN DR BX	G.27
1716130000	LM 5.08/03/135 3.5SN DR BX	G.27
1716710000	LM1N 3.50/02/90 3.2SN DR BX	G.20
1716720000	LM1N 3.50/03/90 3.2SN DR BX	G.20

1720000000

1720250000	LM 3.50/05/90 3.2SN DR BX	G.18
1723430000	SLA BB1R OR	N.6
1723440000	SLA BB2R OR	N.6
1723480000	SLA BB1R SW	N.6
1723490000	SLA BB2R SW	N.6
1724680000	LL 9.52/02/90 5.0SN DR BX	G.38
1724690000	LL 9.52/03/90 5.0SN DR BX	G.38
1725170000	SLD 5.08V/04/90 3.2 SN DR BX	L.76
1725180000	SLD 5.08V/06/90 3.2 SN DR BX	L.76
1725190000	SLD 5.08V/08/90 3.2 SN DR BX	L.76
1725200000	SLD 5.08V/10/90 3.2 SN DR BX	L.76
1725210000	SLD 5.08V/12/90 3.2 SN DR BX	L.76
1725220000	SLD 5.08V/14/90 3.2 SN DR BX	L.76
1725230000	SLD 5.08V/16/90 3.2 SN DR BX	L.76
1725240000	SLD 5.08V/18/90 3.2 SN DR BX	L.76
1725250000	SLD 5.08V/20/90 3.2 SN DR BX	L.76
1725260000	SLD 5.08V/22/90 3.2 SN DR BX	L.76
1725270000	SLD 5.08V/24/90 3.2 SN DR BX	L.76
1725650000	SLD 5.08V/04/180 3.2SN DR BX	L.77
1725660000	SLD 5.08V/06/180 3.2SN DR BX	L.77
1725670000	SLD 5.08V/08/180 3.2SN DR BX	L.77
1725680000	SLD 5.08V/10/180 3.2SN DR BX	L.77
1725690000	SLD 5.08V/12/180 3.2SN DR BX	L.77
1725700000	SLD 5.08V/14/180 3.2SN DR BX	L.77
1725710000	SLD 5.08V/16/180 3.2SN DR BX	L.77
1725720000	SLD 5.08V/18/180 3.2SN DR BX	L.77
1725730000	SLD 5.08V/20/180 3.2SN DR BX	L.77
1725740000	SLD 5.08V/22/180 3.2SN DR BX	L.77
1725750000	SLD 5.08V/24/180 3.2SN DR BX	L.77
1727830000	S2L 3.50/06/90G 3.5SN DR BX	J.14
1727840000	S2L 3.50/08/90G 3.5SN DR BX	J.14

Order No.	Type	Page
1727850000	S2L 3.50/10/90G 3.5SN DR BX	J.14
1727860000	S2L 3.50/12/90G 3.5SN DR BX	J.14
1727870000	S2L 3.50/14/90G 3.5SN DR BX	J.14
1727880000	S2L 3.50/16/90G 3.5SN DR BX	J.14
1727890000	S2L 3.50/18/90G 3.5SN DR BX	J.14
1727900000	S2L 3.50/20/90G 3.5SN DR BX	J.14
1727910000	S2L 3.50/22/90G 3.5SN DR BX	J.14
1727920000	S2L 3.50/24/90G 3.5SN DR BX	J.14
1728470000	S2L 3.50/06/90F 3.5SN DR BX	J.15
1728480000	S2L 3.50/08/90F 3.5SN DR BX	J.15
1728490000	S2L 3.50/10/90F 3.5SN DR BX	J.15
1728500000	S2L 3.50/12/90F 3.5SN DR BX	J.15
1728510000	S2L 3.50/14/90F 3.5SN DR BX	J.15
1728520000	S2L 3.50/16/90F 3.5SN DR BX	J.15
1728530000	S2L 3.50/18/90F 3.5SN DR BX	J.15
1728540000	S2L 3.50/20/90F 3.5SN DR BX	J.15
1728550000	S2L 3.50/22/90F 3.5SN DR BX	J.15
1728560000	S2L 3.50/24/90F 3.5SN DR BX	J.15
1728790000	S2L 3.50/06/180G 3.5SN DR BX	J.16
1728800000	S2L 3.50/08/180G 3.5SN DR BX	J.16
1728810000	S2L 3.50/10/180G 3.5SN DR BX	J.16
1728820000	S2L 3.50/12/180G 3.5SN DR BX	J.16
1728830000	S2L 3.50/14/180G 3.5SN DR BX	J.16
1728840000	S2L 3.50/16/180G 3.5SN DR BX	J.16
1728850000	S2L 3.50/18/180G 3.5SN DR BX	J.16
1728860000	S2L 3.50/20/180G 3.5SN DR BX	J.16
1728870000	S2L 3.50/22/180G 3.5SN DR BX	J.16
1728880000	S2L 3.50/24/180G 3.5SN DR BX	J.16
1729430000	S2L 3.50/06/180F 3.5SN DR BX	J.17
1729440000	S2L 3.50/08/180F 3.5SN DR BX	J.17
1729450000	S2L 3.50/10/180F 3.5SN DR BX	J.17
1729460000	S2L 3.50/12/180F 3.5SN DR BX	J.17
1729470000	S2L 3.50/14/180F 3.5SN DR BX	J.17
1729480000	S2L 3.50/16/180F 3.5SN DR BX	J.17
1729490000	S2L 3.50/18/180F 3.5SN DR BX	J.17
1729500000	S2L 3.50/20/180F 3.5SN DR BX	J.17
1729510000	S2L 3.50/22/180F 3.5SN DR BX	J.17
1729520000	S2L 3.50/24/180F 3.5SN DR BX	J.17

1740000000

1745580000	BL 3.50 AH03 BK BX	J.48
1745590000	BL 3.50 AH03 BK BX	N.4
1745590000	BL 3.50 AH04 BK BX	J.48
1745600000	BL 3.50 AH05 BK BX	J.48
1745600000	BL 3.50 AH05 BK BX	N.4
1745610000	BL 3.50 AH06 BK BX	J.48
1745610000	BL 3.50 AH06 BK BX	N.4
1745620000	BL 3.50 AH07 BK BX	J.48
1745620000	BL 3.50 AH07 BK BX	N.4
1745630000	BL 3.50 AH08 BK BX	J.48
1745630000	BL 3.50 AH08 BK BX	N.4
1745640000	BL 3.50 AH09 BK BX	J.48
1745640000	BL 3.50 AH09 BK BX	N.4
1745650000	BL 3.50 AH10 BK BX	J.48
1745650000	BL 3.50 AH10 BK BX	N.4
1745660000	BL 3.50 AH11 BK BX	J.48
1745660000	BL 3.50 AH11 BK BX	N.4
1745670000	BL 3.50 AH12 BK BX	J.48
1745670000	BL 3.50 AH12 BK BX	N.4
1745680000	BL 3.50 AH13 BK BX	J.48
1745690000	BL 3.50 AH14 BK BX	J.48
1745700000	BL 3.50 AH15 BK BX	J.48
1745710000	BL 3.50 AH16 BK BX	J.48
1747530000	LPBB MU DR	N.7
1747540000	LPBB OR	N.7

1750000000

1752984002	SL-SMT 3.50/02/180G 1.5SN BK RL	J.35
1752994002	SL-SMT 3.50/03/180G 1.5SN BK RL	J.35
1753004002	SL-SMT 3.50/04/180G 1.5SN BK RL	J.35
1753014002	SL-SMT 3.50/05/180G 1.5SN BK RL	J.35
1753024001	SL-SMT 3.50/06/180G 1.5SN BK RL	J.35
1753034001	SL-SMT 3.50/07/180G 1.5SN BK RL	J.35
1753044001	SL-SMT 3.50/08/180G 1.5SN BK RL	J.35
1753054001	SL-SMT 3.50/09/180G 1.5SN BK RL	J.35
1753064001	SL-SMT 3.50/10/180G 1.5SN BK RL	J.35
1753074001	SL-SMT 3.50/11/180G 1.5SN BK RL	J.35
1758020000	LM2NZF 5.08/20/135 3.5SN DR BX	G.104
1758030000	LM3RFZ 5.08/30/135 3.5SN DR BX	G.105
1758040000	LM3RFZ 5.08/21/135 3.5SN DR BX	G.105

1760000000

1760490000	PM 5.08/02/90 3.5SN DR BX	G.45
1760500000	PM 5.08/03/90 3.5SN DR BX	G.45
1761544002	SL-SMT 3.50/02/90G 1.5SN BK RL	J.31
1761554002	SL-SMT 3.50/03/90G 1.5SN BK RL	J.31
1761564001	SL-SMT 3.50/04/90G 1.5SN BK RL	J.31
1761574002	SL-SMT 3.50/05/90G 1.5SN BK RL	J.31
1761584001	SL-SMT 3.50/06/90G 1.5SN BK RL	J.31
1761594001	SL-SMT 3.50/07/90G 1.5SN BK RL	J.31
1761604001	SL-SMT 3.50/08/90G 1.5SN BK RL	J.31
1761614001	SL-SMT 3.50/09/90G 1.5SN BK RL	J.31
1761624001	SL-SMT 3.50/10/90G 1.5SN BK RL	J.31
1761634001	SL-SMT 3.50/11/90G 1.5SN BK RL	J.31
1764810000	LM2NZF 5.08/04/135 3.5SN DR BX	G.104

Order No.	Type	Page
1764820000	LM2NZF 5.08/06/135 3.5SN DR BX	G.104
1764830000	LM2NZF 5.08/08/135 3.5SN DR BX	G.104
1764840000	LM2NZF 5.08/10/135 3.5SN DR BX	G.104
1764850000	LM2NZF 5.08/12/135 3.5SN DR BX	G.104
1764860000	LM2NZF 5.08/14/135 3.5SN DR BX	G.104
1764870000	LM2NZF 5.08/16/135 3.5SN DR BX	G.104
1764880000	LM2NZF 5.08/18/135 3.5SN DR BX	G.104
1764890000	LM2NZF 5.08/22/135 3.5SN DR BX	G.104
1764900000	LM2NZF 5.08/24/135 3.5SN DR BX	G.104
1764910000	LM3RFZ 5.08/06/135 3.5SN DR BX	G.105
1764920000	LM3RFZ 5.08/08/135 3.5SN DR BX	G.105
1764930000	LM3RFZ 5.08/12/135 3.5SN DR BX	G.105
1764940000	LM3RFZ 5.08/15/135 3.5SN DR BX	G.105
1764950000	LM3RFZ 5.08/18/135 3.5SN DR BX	G.105
1764960000	LM3RFZ 5.08/24/135 3.5SN DR BX	G.105
1764970000	LM3RFZ 5.08/27/135 3.5SN DR BX	G.105
1764980000	LM3RFZ 5.08/33/135 3.5SN DR BX	G.105
1764990000	LM3RFZ 5.08/36/135 3.5SN DR BX	G.105
1766300000	LM1N 5.08/02/90 3.5SN DR BX	G.28
1766310000	LM1N 5.08/03/90 3.5SN DR BX	G.28
1766360000	LM1H 5.08/02/90 3.5SN DR BX	G.29
1766370000	LM1H 5.08/03/90 3.5SN DR BX	G.29
1768500000	LM2N 5.08/04/90 3.5SN DR BX	G.30
1768600000	LM2N 5.08/06/90 3.5SN DR BX	G.30
1768670000	LM2N 5.08/08/90 3.5SN DR BX	G.30
1768680000	LM2N 5.08/10/90 3.5SN DR BX	G.30
1768690000	LM2N 5.08/12/90 3.5SN DR BX	G.30
1768690000	LM2N 5.08/14/90 3.5SN DR BX	G.30
1768910000	LM2N 5.08/16/90 3.5SN DR BX	G.30
1768920000	LM2N 5.08/18/90 3.5SN DR BX	G.30
1768930000	LM2N 5.08/20/90 3.5SN DR BX	G.30
1768940000	LM2N 5.08/22/90 3.5SN DR BX	G.30
1768950000	LM2N 5.08/24/90 3.5SN DR BX	G.30
1768960000	LM2H 5.08/04/90 3.5SN DR BX	G.31
1768970000	LM2H 5.08/06/90 3.5SN DR BX	G.31
1768980000	LM2H 5.08/08/90 3.5SN DR BX	G.31
1768990000	LM2H 5.08/10/90 3.5SN DR BX	G.31
1769280000	LM2H 5.08/12/90 3.5SN DR BX	G.31
1769290000	LM2H 5.08/14/90 3.5SN DR BX	G.31
1769300000	LM2H 5.08/16/90 3.5SN DR BX	G.31
1769310000	LM2H 5.08/18/90 3.5SN DR BX	G.31
1769320000	LM2H 5.08/20/90 3.5SN DR BX	G.31
1769330000	LM2H 5.08/22/90 3.5SN DR BX	G.31
1769340000	LM2H 5.08/24/90 3.5SN DR BX	G.31
1769350000	LM3R 5.08/06/90 3.5SN DR BX	G.31
1769630000	LM3R 5.08/09/90 3.5SN DR BX	G.31

Table with columns: Order No., Type, Page. Contains a list of order numbers and their corresponding page numbers.

Table with columns: Order No., Type, Page. Contains a list of order numbers and their corresponding page numbers.

Table with columns: Order No., Type, Page. Contains a list of order numbers and their corresponding page numbers.

Table with columns: Order No., Type, Page. Contains a list of order numbers and their corresponding page numbers.

186000000

187000000

185000000

Table with columns: Order No., Type, Page. Contains a list of order numbers and types such as LSF-SMT 3.50/05/135 3.5SN BK RL.

Table with columns: Order No., Type, Page. Contains a list of order numbers and types such as SLD 3.50 V/10/180F 3.2 SN OR BX.

191000000

Table with columns: Order No., Type, Page. Contains a list of order numbers and types such as LL2N 9.52/16/90 5.0SN OR BX.

193000000

Table with columns: Order No., Type, Page. Contains a list of order numbers and types such as BVZ 7.62HP/05/180SF SN BK BX.

189000000

Order No.	Type	Page
193151000	SV 7.62HP/05/270SF 3.5SN BK BX	P167
193152000	SV 7.62HP/06/270SF 3.5SN BK BX	P167
193153000	SV 7.62HP/07/270SF 3.5SN BK BX	P167
193154000	SV 7.62HP/08/270SF 3.5SN BK BX	P167
193155000	SV 7.62HP/09/270SF 3.5SN BK BX	P167
193157000	SV 7.62HP/10/270SF 3.5SN BK BX	P167
193158000	SV 7.62HP/11/270SF 3.5SN BK BX	P167
193159000	SV 7.62HP/12/270SF 3.5SN BK BX	P167
193334000	BVZ 7.62HP/03/180RSH180 SN BK BX	P191
193335000	BVZ 7.62HP/04/180RSH180 SN BK BX	P191
193336000	BVZ 7.62HP/05/180RSH180 SN BK BX	P191
193337000	BVZ 7.62HP/06/180RSH180 SN BK BX	P191
193338000	BVZ 7.62HP/03/180SH180C SN BK BX	P193
193339000	BVZ 7.62HP/04/180SH180C SN BK BX	P193
193340000	BVZ 7.62HP/05/180SH180C SN BK BX	P193
193341000	BVZ 7.62HP/06/180SH180C SN BK BX	P193
193343000	BVZ 7.62HP/03/180SH210 SN BK BX	P191
193344000	BVZ 7.62HP/04/180SH210 SN BK BX	P191
193345000	BVZ 7.62HP/05/180SH210 SN BK BX	P191
193346000	BVZ 7.62HP/06/180SH210 SN BK BX	P191
193347000	BVZ 7.62HP/03/180SH210C SN BK BX	P193
193348000	BVZ 7.62HP/04/180SH210C SN BK BX	P193
193349000	BVZ 7.62HP/05/180SH210C SN BK BX	P193
193350000	BVZ 7.62HP/06/180SH210C SN BK BX	P193
1934050000	WGKV 4 GY BX	R.13
1934140000	LU 10.16/02/90 4.5SN BK BX	O.18
1934250000	LL 5.08/02/90 3.2SN DR BX	G.33
1934260000	LL 5.08/03/90 3.2SN DR BX	G.33
1934270000	LL 5.00/02/90 3.2SN DR BX	G.32
1934280000	LL 5.00/03/90 3.2SN DR BX	G.32
1934310000	LL2N 5.00/04/90 3.2SN DR BX	G.35
1934340000	LL3R 5.08/06/90 3.2SN DR BX	G.37
1934360000	LL3R 5.00/06/90 3.2SN DR BX	G.35
1936340000	SL-SMT 3.50/10/180LF 1.5SN BK RL	J.35
1936430000	DP VWGK 4 GY BX	R.12
1936450000	DP WGK 4 GY BX	R.12
1936480000	VWGK 4 GN/YE BX	R.13
1936490000	VWGK 4 GY BX	R.13
1936540000	WGK 4 GN/YE BX	R.12
1936550000	WGK 4 GY BX	R.12
1936560000	WGK 4/2 GN/YE BX	R.12
1936570000	WGK 4/2 GY BX	R.12
1936610000	WGKV 4 GN/YE BX	R.13
1936620000	WGKV 4/2 GN/YE BX	R.13
1936630000	WGKV 4/2 GY BX	R.13
1936700000	DP WGK 16 GY BX	R.18
1936710000	DP WGK 25 GY BX	R.20
1937020000	DP WGK 95 GY BX	R.24
1937030000	DP WGK 50	R.22
1937120000	WGK 95F VP GN/YE BX	R.25
1937130000	WGK 95F VP GY BX	R.25
1937140000	WGK 95F VP Z GY BX	R.25
1937360000	WGK 95F VP/Z GN/YE BX	R.25
1937370000	WGK 95 GN/YE BX	R.24
1937380000	WGK 95 GY BX	R.24
1937390000	WGK 95/Z GN/YE BX	R.24
1937400000	WGK 95/Z GY BX	R.24
1937550000	BV/SV 7.62HP/02 ZE GR	P.76
1937560000	BV/SV 7.62HP/02 ZE GR	P188
1937570000	BV/SV 7.62HP/02 ZE GR	S.2
1937580000	BV/SV 7.62HP/04 ZE GR	P.76
1937580000	BV/SV 7.62HP/04 ZE GR	P188
1937580000	BV/SV 7.62HP/04 ZE GR	S.2
1937590000	BV/SV 7.62HP KO	P.12
1937590000	BV/SV 7.62HP KO	P14
1937590000	BV/SV 7.62HP KO	P16
1937590000	BV/SV 7.62HP KO	P18
1937590000	BV/SV 7.62HP KO	P.20
1937590000	BV/SV 7.62HP KO	P.22
1937590000	BV/SV 7.62HP KO	P.24
1937590000	BV/SV 7.62HP KO	P.26
1937590000	BV/SV 7.62HP KO	P.28
1937590000	BV/SV 7.62HP KO	P.30
1937590000	BV/SV 7.62HP KO	P.32
1937590000	BV/SV 7.62HP KO	P.34
1937590000	BV/SV 7.62HP KO	P.36
1937590000	BV/SV 7.62HP KO	P.38
1937590000	BV/SV 7.62HP KO	P.40
1937590000	BV/SV 7.62HP KO	P.42
1937590000	BV/SV 7.62HP KO	P.44
1937590000	BV/SV 7.62HP KO	P.46
1937590000	BV/SV 7.62HP KO	P.50
1937590000	BV/SV 7.62HP KO	P.52
1937590000	BV/SV 7.62HP KO	P.68
1937590000	BV/SV 7.62HP KO	P.70
1937590000	BV/SV 7.62HP KO	P.72
1937590000	BV/SV 7.62HP KO	P.74
1937590000	BV/SV 7.62HP KO	P.76
1937590000	BV/SV 7.62HP KO	P124
1937590000	BV/SV 7.62HP KO	P126
1937590000	BV/SV 7.62HP KO	P128
1937590000	BV/SV 7.62HP KO	P150
1937590000	BV/SV 7.62HP KO	P152
1937590000	BV/SV 7.62HP KO	P.154
1937590000	BV/SV 7.62HP KO	P.156
1937590000	BV/SV 7.62HP KO	P158
1937590000	BV/SV 7.62HP KO	P160
1937590000	BV/SV 7.62HP KO	P162

Order No.	Type	Page
1937590000	BV/SV 7.62HP KO	P164
1937590000	BV/SV 7.62HP KO	P166
1937590000	BV/SV 7.62HP KO	P168
1937590000	BV/SV 7.62HP KO	P170
1937590000	BV/SV 7.62HP KO	P172
1937590000	BV/SV 7.62HP KO	P174
1937590000	BV/SV 7.62HP KO	P176
1937590000	BV/SV 7.62HP KO	P178
1937590000	BV/SV 7.62HP KO	P180
1937590000	BV/SV 7.62HP KO	P182
1937590000	BV/SV 7.62HP KO	P184
1937590000	BV/SV 7.62HP KO	P186
1937590000	BV/SV 7.62HP KO	P188
1937590000	BV/SV 7.62HP KO	P190
1937590000	BV/SV 7.62HP KO	P192
1937590000	BV/SV 7.62HP KO	P194
1937590000	BV/SV 7.62HP KO	P196
1937590000	BV/SV 7.62HP KO	P198
1937590000	BV/SV 7.62HP KO	P.200
1937590000	BV/SV 7.62HP KO	P.202
1937590000	BV/SV 7.62HP KO	P.204
1937590000	BV/SV 7.62HP KO	P.206
1937590000	BV/SV 7.62HP KO	P.208
1937590000	BV/SV 7.62HP KO	P.210
1937590000	BV/SV 7.62HP KO	S.4
1938010000	BL1/0 3.50/10F NPN LED SN BK BX	J.56
1938020000	BL1/0 3.50/30F NPN LED SN BK BX	J.57
1939820000	BCZ 3.81/02/90 SN DR BX	K.52
1939830000	BCZ 3.81/03/90 SN DR BX	K.52
1939840000	BCZ 3.81/04/90 SN DR BX	K.52
1939860000	BCZ 3.81/05/90 SN DR BX	K.52
1939870000	BCZ 3.81/06/90 SN DR BX	K.52
1939880000	BCZ 3.81/07/90 SN DR BX	K.52
1939890000	BCZ 3.81/08/90 SN DR BX	K.52
1939900000	BCZ 3.81/09/90 SN DR BX	K.52
1939910000	BCZ 3.81/10/90 SN DR BX	K.52
1939920000	BCZ 3.81/11/90 SN DR BX	K.52
1939930000	BCZ 3.81/12/90 SN DR BX	K.52
1939980000	BCZ 3.81/02/90F SN DR BX	K.53
1939990000	BCZ 3.81/03/90F SN DR BX	K.53

1940000000

1940000000	BCZ 3.81/04/90F SN DR BX	K.53
1940100000	BCZ 3.81/05/90F SN DR BX	K.53
1940200000	BCZ 3.81/06/90F SN DR BX	K.53
1940300000	BCZ 3.81/07/90F SN DR BX	K.53
1940400000	BCZ 3.81/08/90F SN DR BX	K.53
1940500000	BCZ 3.81/09/90F SN DR BX	K.53
1940600000	BCZ 3.81/10/90F SN DR BX	K.53
1940700000	BCZ 3.81/11/90F SN DR BX	K.53
1940800000	BCZ 3.81/12/90F SN DR BX	K.53
1940900000	BCZ 3.81/02/270 SN DR BX	K.53
1941000000	BCZ 3.81/03/270 SN DR BX	K.53
1941100000	BCZ 3.81/04/270 SN DR BX	K.53
1941200000	BCZ 3.81/05/270 SN DR BX	K.53
1941300000	BCZ 3.81/06/270 SN DR BX	K.53
1941400000	BCZ 3.81/07/270 SN DR BX	K.53
1941500000	BCZ 3.81/08/270 SN DR BX	K.53
1941600000	BCZ 3.81/09/270 SN DR BX	K.53
1941700000	BCZ 3.81/10/270 SN DR BX	K.53
1941800000	BCZ 3.81/11/270 SN DR BX	K.53
1941900000	BCZ 3.81/12/270 SN DR BX	K.53
1942000000	BCZ 3.81/02/270F SN DR BX	K.53
1942100000	BCZ 3.81/03/270F SN DR BX	K.53
1942200000	BCZ 3.81/04/270F SN DR BX	K.53
1942300000	BCZ 3.81/05/270F SN DR BX	K.53
1942400000	BCZ 3.81/06/270F SN DR BX	K.53
1942500000	BCZ 3.81/07/270F SN DR BX	K.53
1942600000	BCZ 3.81/08/270F SN DR BX	K.53
1942700000	BCZ 3.81/09/270F SN DR BX	K.53
1942800000	BCZ 3.81/10/270F SN DR BX	K.53
1942900000	BCZ 3.81/11/270F SN DR BX	K.53
1943000000	BCZ 3.81/12/270F SN DR BX	K.53
1943100000	BCZ 3.81/02/180 SN DR BX	K.48
1943200000	BCZ 3.81/03/180 SN DR BX	K.48
1943300000	BCZ 3.81/04/180 SN DR BX	K.48
1943400000	BCZ 3.81/05/180 SN DR BX	K.48
1943500000	BCZ 3.81/06/180 SN DR BX	K.48
1943600000	BCZ 3.81/07/180 SN DR BX	K.48
1943700000	BCZ 3.81/08/180 SN DR BX	K.48
1943800000	BCZ 3.81/09/180 SN DR BX	K.48
1943900000	BCZ 3.81/10/180 SN DR BX	K.48
1944000000	BCZ 3.81/11/180 SN DR BX	K.48
1944100000	BCZ 3.81/12/180 SN DR BX	K.48
1944200000	BCZ 3.81/02/180F SN DR BX	K.49
1944300000	BCZ 3.81/03/180F SN DR BX	K.49
1944400000	BCZ 3.81/04/180F SN DR BX	K.49
1944500000	BCZ 3.81/05/180F SN DR BX	K.49
1944600000	BCZ 3.81/06/180F SN DR BX	K.49
1944700000	BCZ 3.81/07/180F SN DR BX	K.49
1944800000	BCZ 3.81/08/180F SN DR BX	K.49
1944900000	BCZ 3.81/09/180F SN DR BX	K.49
1945000000	BCZ 3.81/10/180F SN DR BX	K.49
1945100000	BCZ 3.81/11/180F SN DR BX	K.49
1945200000	BCZ 3.81/12/180F SN DR BX	K.49
1945300000	SC 3.81/02/90G 3.2SN DR BX	K.26
1945400000	SC 3.81/03/90G 3.2SN DR BX	K.26
1945500000	SC 3.81/04/90G 3.2SN DR BX	K.26

Order No.	Type	Page
1942090000	SC 3.81/05/90G 3.2SN DR BX	K.26
1942100000	SC 3.81/06/90G 3.2SN DR BX	K.26
1942120000	SC 3.81/07/90G 3.2SN DR BX	K.26
1942130000	SC 3.81/08/90G 3.2SN DR BX	K.26
1942140000	SC 3.81/09/90G 3.2SN DR BX	K.26
1942150000	SC 3.81/10/90G 3.2SN DR BX	K.26
1942160000	SC 3.81/11/90G 3.2SN DR BX	K.26
1942170000	SC 3.81/12/90G 3.2SN DR BX	K.26
1942450000	SC 3.81/02/90F 3.2SN DR BX	K.27
1942460000	SC 3.81/03/90F 3.2SN DR BX	K.27
1942470000	SC 3.81/04/90F 3.2SN DR BX	K.27
1942480000	SC 3.81/05/90F 3.2SN DR BX	K.27
1942490000	SC 3.81/06/90F 3.2SN DR BX	K.27
1942500000	SC 3.81/07/90F 3.2SN DR BX	K.27
1942510000	SC 3.81/08/90F 3.2SN DR BX	K.27
1942520000	SC 3.81/09/90F 3.2SN DR BX	K.27
1942530000	SC 3.81/10/90F 3.2SN DR BX	K.27
1942540000	SC 3.81/11/90F 3.2SN DR BX	K.27
1942550000	SC 3.81/12/90F 3.2SN DR BX	K.27
1942840000	SC 3.81/02/180G 3.2SN DR BX	K.28
1942850000	SC 3.81/03/180G 3.2SN DR BX	K.28
1942860000	SC 3.81/04/180G 3.2SN DR BX	K.28
1942870000	SC 3.81/05/180G 3.2SN DR BX	K.28
1942880000	SC 3.81/06/180G 3.2SN DR BX	K.28
1942890000	SC 3.81/07/180G 3.2SN DR BX	K.28
1942900000	SC 3.81/08/180G 3.2SN DR BX	K.28
1942910000	SC 3.81/09/180G 3.2SN DR BX	K.28
1942920000	SC 3.81/10/180G 3.2SN DR BX	K.28
1942930000	SC 3.81/11/180G 3.2SN DR BX	K.28
1942940000	SC 3.81/12/180G 3.2SN DR BX	K.28
1943180000	SC 3.81/02/180F 3.2SN DR BX	K.29
1943190000	SC 3.81/03/180F 3.2SN DR BX	K.29
1943200000	SC 3.81/04/180F 3.2SN DR BX	K.29
1943210000	SC 3.81/05/180F 3.2SN DR BX	K.29
1943220000	SC 3.81/06/180F 3.2SN DR BX	K.29
1943230000	SC 3.81/07/180F 3.2SN DR BX	K.29
1943240000	SC 3.81/08/180F 3.2SN DR BX	K.29
1943250000	SC 3.81/09/180F 3.2SN DR BX	K.29
1943260000	SC 3.81/10/180F 3.2SN DR BX	K.29
1943270000	SC 3.81/11/180F 3.2SN DR BX	K.29
1943280000	SC 3.81/12/180F 3.2SN DR BX	K.29
1943580000	BLZP 5.08HC/02/180 SN DR BX	L.96
1943590000	BLZP 5.08HC/03/180 SN DR BX	L.96
1943600000	BLZP 5.08HC/04/180 SN DR BX	L.96
1943610000	BLZP 5.08HC/05/180 SN DR BX	L.96
1943620000	BLZP 5.08HC/06/180 SN DR BX	L.96
1943630000	BLZP 5.08HC/07/180 SN DR BX	L.96
1943640000	BLZP 5.08HC/08/180 SN DR BX	L.96
1943650000	BLZP 5.08HC/09/180 SN DR BX	L.96
1943660000	BLZP 5.08HC/10/180 SN DR BX	L.96
1943670000	BLZP 5.08HC/11/180 SN DR BX	L.96
1943680000	BLZP 5.08HC/12/180 SN DR BX	

Order No.	Type	Page
248000000		
248480000	VWVK 6 GN/YE R.14	
248480000	VWVK 6 GY/BK R.14	
248481000	VWVK 6 BK BX R.14	
248537000	RJ45G1 R12D 3.2N4YG/YG R.35	

Order No.	Type	Page
249000000		
249111000	LLFS 7.50/01/180V 5.0SN BK BX 0.30	
249162000	LLFS 7.50/02/180V 5.0SN BK BX 0.31	
249163000	LLFS 7.50/03/180V 5.0SN BK BX 0.31	
249164000	LLFS 7.50/04/180V 5.0SN BK BX 0.31	
249165000	LLFS 7.50/05/180V 5.0SN BK BX 0.31	
249166000	LLFS 7.50/06/180V 5.0SN BK BX 0.31	
249167000	LLFS 7.50/07/180V 5.0SN BK BX 0.31	
249168000	LLFS 7.50/08/180V 5.0SN BK BX 0.31	
249169000	LLFS 7.50/09/180V 5.0SN BK BX 0.31	
249170000	LLFS 7.50/10/180V 5.0SN BK BX 0.31	
249171000	LLFS 7.50/11/180V 5.0SN BK BX 0.31	
249172000	LLFS 7.50/12/180V 5.0SN BK BX 0.31	
249180000	LUF 15.00/02/90V 5.0SN BK BX 0.38	
249181000	LUF 15.00/01/180V 5.0SN BK BX 0.36	
249182000	LUF 15.00/02/180V 5.0SN BK BX 0.41	
249190000	LUF 15.00/03/90V 5.0SN BK BX 0.38	
249191000	LUF 15.00/04/90V 5.0SN BK BX 0.38	
249192000	LUF 15.00/05/90V 5.0SN BK BX 0.38	
249193000	LUF 15.00/06/90V 5.0SN BK BX 0.38	
249194000	LUF 15.00/07/90V 5.0SN BK BX 0.38	
249195000	LUF 15.00/08/90V 5.0SN BK BX 0.38	
249200000	LUF 15.00/02/90V 5.0SN BK BX 0.39	
249201000	LUF 15.00/03/90V 5.0SN BK BX 0.39	
249202000	LUF 15.00/04/90V 5.0SN BK BX 0.39	
249203000	LUF 15.00/05/90V 5.0SN BK BX 0.39	
249204000	LUF 15.00/06/90V 5.0SN BK BX 0.39	
249205000	LUF 15.00/07/90V 5.0SN BK BX 0.39	
249206000	LUF 15.00/08/90V 5.0SN BK BX 0.39	
249211000	LUF 15.00/02/180V 5.0SN BK BX 0.37	
249212000	LUF 15.00/03/180V 5.0SN BK BX 0.37	
249213000	LUF 15.00/04/180V 5.0SN BK BX 0.37	
249214000	LUF 15.00/05/180V 5.0SN BK BX 0.37	
249215000	LUF 15.00/06/180V 5.0SN BK BX 0.37	
249216000	LUF 15.00/07/180V 5.0SN BK BX 0.37	
249217000	LUF 15.00/08/180V 5.0SN BK BX 0.37	
249218000	LUF 15.00/09/180V 5.0SN BK BX 0.37	
249219000	LUF 15.00/10/180V 5.0SN BK BX 0.37	
249220000	LUF 15.00/11/180V 5.0SN BK BX 0.37	
249221000	LUF 15.00/12/180V 5.0SN BK BX 0.37	
249222000	LUF 15.00/03/180V 5.0SN BK BX 0.41	
249223000	LUF 15.00/04/180V 5.0SN BK BX 0.41	
249224000	LUF 15.00/05/180V 5.0SN BK BX 0.41	
249225000	LUF 15.00/06/180V 5.0SN BK BX 0.41	
249226000	LUF 15.00/07/180V 5.0SN BK BX 0.41	
249227000	LUF 15.00/08/180V 5.0SN BK BX 0.41	
249316000	BUF 10.161T/02/180M F2 AG BK BX P.108	
249317000	BUF 10.161T/02/180 AG BK BX P.246	
249318000	BUF 10.161T/03/180M F2 AG BK BX P.108	
249319000	BUF 10.161T/03/180M F3 AG BK BX P.108	
249320000	BUF 10.161T/04/180M F2 AG BK BX P.109	
249321000	BUF 10.161T/04/180M F3 AG BK BX P.109	
249323000	BUF 10.161T/02/180M F2 AG BK BX P.110	
249324000	BUF 10.161T/03/180M F2 AG BK BX P.110	
249325000	BUF 10.161T/03/180M F3 AG BK BX P.111	
249326000	BUF 10.161T/04/180M F2 AG BK BX P.110	
249327000	BUF 10.161T/04/180M F3 AG BK BX P.111	
249328000	BUF 10.161T/04/180M F4 AG BK BX P.111	
249330000	BUF 10.161T/02/180F AG BK BX P.247	
249331000	BUF 10.161T/03/180F AG BK BX P.247	
249332000	BUF 10.161T/04/180F AG BK BX P.247	
249333000	BUF 10.161T/05/180F AG BK BX P.247	
249334000	BUF 10.161T/02/180SF AG BK BX P.247	
249335000	BUF 10.161T/03/180SF AG BK BX P.247	
249336000	BUF 10.161T/04/180SF AG BK BX P.247	
249337000	BUF 10.161T/05/180SF AG BK BX P.247	
249340000	BUF 10.161T/03/180 AG BK BX P.246	
249341000	BUF 10.161T/04/180 AG BK BX P.246	
249342000	BUF 10.161T/05/180 AG BK BX P.246	
249880000	SV-SMT 7.62HP/02/270M F2 3.5SN BK BX P.70	
249901000	SV-SMT 7.62IT/03/270M F2 3.5SN BK BX P.70	
249902000	SV-SMT 7.62IT/04/270M F2 3.5SN BK BX P.71	
249903000	SV-SMT 7.62IT/04/270M F2 3.5SN BK BX P.71	
249904000	SV-SMT 7.62IT/04/270M F3 3.5SN BK BX P.71	
249905000	SV-SMT 7.62IT/04/270M F3 3.5SN BK BX P.71	
249922000	SV-SMT 7.62HP/02/90G 2.6SN BK BX P.150	
249930000	SV-SMT 7.62HP/02/270G 2.6SN BK BX P.150	
249934000	SV-SMT 7.62HP/03/270G 2.6SN BK BX P.154	
249935000	SV-SMT 7.62HP/04/270G 2.6SN BK BX P.154	
249936000	SV-SMT 7.62HP/05/270G 2.6SN BK BX P.154	
249940000	LUF 15.00/02/90V 5.0SN BK BX 0.35	
249944000	LUF 15.00/02/90V 5.0SN BK BX 0.40	
249950000	SV-SMT 7.62HP/03/90G 2.6SN BK BX P.150	
249952000	SV-SMT 7.62HP/02/90F 2.6SN BK BX P.151	
249953000	SV-SMT 7.62IT/02/90M F2 2.6SN BK BX P.68	
249954000	SV-SMT 7.62HP/02/270F 2.6SN BK BX P.150	
249955000	SV-SMT 7.62HP/04/90G 2.6SN BK BX P.155	
249956000	SV-SMT 7.62HP/05/90G 2.6SN BK BX P.155	
249957000	SV-SMT 7.62HP/03/90F 2.6SN BK BX P.150	
249958000	SV-SMT 7.62HP/04/90F 2.6SN BK BX P.151	
249959000	SV-SMT 7.62HP/05/90F 2.6SN BK BX P.151	

Order No.	Type	Page
249960000	SV-SMT 7.62HP/02/90SF 2.6SN BK BX P.151	
249961000	SV-SMT 7.62HP/03/90SF 2.6SN BK BX P.151	
249962000	SV-SMT 7.62HP/04/90SF 2.6SN BK BX P.151	
249963000	SV-SMT 7.62HP/05/90SF 2.6SN BK BX P.151	
249964000	SV-SMT 7.62HP/02/90LF 2.6SN BK BX P.153	
249965000	SV-SMT 7.62HP/03/90LF 2.6SN BK BX P.153	
249966000	SV-SMT 7.62HP/04/90LF 2.6SN BK BX P.153	
249967000	SV-SMT 7.62HP/05/90LF 2.6SN BK BX P.153	
249968000	SV-SMT 7.62HP/02/90LF 2.6SN BK BX P.153	
249969000	SV-SMT 7.62HP/03/90LF 2.6SN BK BX P.153	
249970000	SV-SMT 7.62HP/04/90LF 2.6SN BK BX P.153	
249971000	SV-SMT 7.62HP/05/90LF 2.6SN BK BX P.153	
249972000	SV-SMT 7.62IT/03/90M F2 2.6SN BK BX P.68	
249973000	SV-SMT 7.62IT/03/90M F2 2.6SN BK BX P.68	
249974000	SV-SMT 7.62IT/04/90M F2 2.6SN BK BX P.68	
249975000	SV-SMT 7.62IT/04/90M F3 2.6SN BK BX P.68	
249976000	SV-SMT 7.62IT/05/90M F2 2.6SN BK BX P.68	
249977000	SV-SMT 7.62IT/05/90M F3 2.6SN BK BX P.68	
249978000	SV-SMT 7.62IT/05/90M F4 2.6SN BK BX P.68	
249991000	SV-SMT 7.62HP/03/270F 2.6SN BK BX P.155	
249992000	SV-SMT 7.62HP/04/270F 2.6SN BK BX P.155	
249993000	SV-SMT 7.62HP/05/270F 2.6SN BK BX P.155	
249994000	SV-SMT 7.62HP/02/270F 2.6SN BK BX P.155	
249995000	SV-SMT 7.62HP/03/270F 2.6SN BK BX P.155	
249996000	SV-SMT 7.62HP/04/270F 2.6SN BK BX P.155	
249997000	SV-SMT 7.62HP/05/270F 2.6SN BK BX P.155	

Order No.	Type	Page
250000000		
250046000	LUF 15.00/03/90V 5.0SN BK BX 0.35	
250047000	LUF 15.00/04/90V 5.0SN BK BX 0.35	
250048000	LUF 15.00/05/90V 5.0SN BK BX 0.35	
250049000	LUF 15.00/06/90V 5.0SN BK BX 0.35	
250050000	LUF 15.00/07/90V 5.0SN BK BX 0.35	
250051000	LUF 15.00/08/90V 5.0SN BK BX 0.35	
250052000	LUF 15.00/09/90V 5.0SN BK BX 0.35	
250053000	LUF 15.00/10/90V 5.0SN BK BX 0.35	
250054000	LUF 15.00/11/90V 5.0SN BK BX 0.35	
250055000	LUF 15.00/12/90V 5.0SN BK BX 0.35	
250056000	LUF 15.00/01/90V 5.0SN BK BX 0.34	
250057000	LUF 15.00/02/90V 5.0SN BK BX 0.40	
250058000	LUF 15.00/04/90V 5.0SN BK BX 0.40	
250059000	LUF 15.00/05/90V 5.0SN BK BX 0.40	
250060000	LUF 15.00/07/90V 5.0SN BK BX 0.40	
250061000	LUF 15.00/08/90V 5.0SN BK BX 0.40	
250062000	LUF 15.00/06/90V 5.0SN BK BX 0.40	

Order No.	Type	Page
251000000		
251460000	RJ45C5 S1V 2.7E4N RL D.7	
251638000	RJ45C5 R1V 3.2N4G/Y TY D.12	

Order No.	Type	Page
252000000		
252895000	SV-SMT 7.62HP/02/90G SC/4 2.6SN BK P.10	
252897000	SV-SMT 7.62HP/02/270G SC/4 2.6SN BK P.16	
252900000	SV-SMT 7.62HP/02/90M F2 SC/4 2.6SN BK P.12	
252901000	SV-SMT 7.62HP/02/270M F2 SC/4 2.6SN BK P.18	
252903000	SV-SMT 7.62HP/02/90G SC/6 2.6SN BK P.10	
252904000	SV-SMT 7.62HP/02/90G SC/8 2.6SN BK P.10	
252905000	SV-SMT 7.62HP/03/90G SC/4 2.6SN BK P.10	
252906000	SV-SMT 7.62HP/03/90G SC/6 2.6SN BK P.10	
252907000	SV-SMT 7.62HP/03/90G SC/8 2.6SN BK P.10	
252908000	SV-SMT 7.62HP/04/90G SC/4 2.6SN BK P.10	
252909000	SV-SMT 7.62HP/04/90G SC/6 2.6SN BK P.10	
252910000	SV-SMT 7.62HP/04/90G SC/8 2.6SN BK P.10	
252911000	SV-SMT 7.62HP/05/90G SC/4 2.6SN BK P.10	
252912000	SV-SMT 7.62HP/05/90G SC/6 2.6SN BK P.10	
252913000	SV-SMT 7.62HP/05/90G SC/8 2.6SN BK P.10	
252926000	SV-SMT 7.62HP/02/270G SC/6 2.6SN BK P.16	
252927000	SV-SMT 7.62HP/02/270G SC/8 2.6SN BK P.16	
252928000	SV-SMT 7.62HP/03/270G SC/4 2.6SN BK P.16	
252929000	SV-SMT 7.62HP/03/270G SC/6 2.6SN BK P.16	
252930000	SV-SMT 7.62HP/03/270G SC/8 2.6SN BK P.16	
252931000	SV-SMT 7.62HP/04/270G SC/4 2.6SN BK P.16	
252932000	SV-SMT 7.62HP/04/270G SC/6 2.6SN BK P.16	
252933000	SV-SMT 7.62HP/04/270G SC/8 2.6SN BK P.16	
252934000	SV-SMT 7.62HP/05/270G SC/4 2.6SN BK P.16	
252935000	SV-SMT 7.62HP/05/270G SC/6 2.6SN BK P.16	
252936000	SV-SMT 7.62HP/05/270G SC/8 2.6SN BK P.16	
252937000	SV-SMT 7.62HP/02/270M F2 SC/6 2.6SN BK P.18	
252938000	SV-SMT 7.62HP/02/270M F2 SC/8 2.6SN BK P.18	
252939000	SV-SMT 7.62HP/03/270M F2 SC/6 2.6SN BK P.18	
252940000	SV-SMT 7.62HP/03/270M F2 SC/8 2.6SN BK P.18	
252941000	SV-SMT 7.62HP/03/270M F3 SC/6 2.6SN BK P.18	
252942000	SV-SMT 7.62HP/03/270M F3 SC/8 2.6SN BK P.18	
252943000	SV-SMT 7.62HP/03/270M F3 SC/8 2.6SN BK P.18	
252944000	SV-SMT 7.62HP/04/270M F4 SC/6 2.6SN BK P.18	
252945000	SV-SMT 7.62HP/04/270M F4 SC/8 2.6SN BK P.18	
252946000	SV-SMT 7.62HP/04/270M F4 SC/8 2.6SN BK P.18	
252947000	SV-SMT 7.62HP/04/270M F4 SC/8 2.6SN BK P.18	
252948000	SV-SMT 7.62HP/05/270M F4 SC/6 2.6SN BK P.18	
252949000	SV-SMT 7.62HP/05/270M F4 SC/8 2.6SN BK P.18	
252950000	SV-SMT 7.62HP/02/270M F2 SC/4 2.6SN BK P.20	
252951000	SV-SMT 7.62HP/02/270M F2 SC/6 2.6SN BK P.20	

Order No.	Type	Page
252956000	SV-SMT 7.62HP/02/270M F2 SC/8 2.6SN BK P.20	
252957000	SV-SMT 7.62HP/03/270M F2 SC/4 2.6SN BK P.20	
252958000	SV-SMT 7.62HP/03/270M F2 SC/6 2.6SN BK P.20	
252959000	SV-SMT 7.62HP/03/270M F2 SC/8 2.6SN BK P.20	
252960000	SV-SMT 7.62HP/03/270M F3 SC/4 2.6SN BK P.21	
252961000	SV-SMT 7.62HP/03/270M F3 SC/6 2.6SN BK P.21	
252962000	SV-SMT 7.62HP/03/270M F3 SC/8 2.6SN BK P.21	
252963000	SV-SMT 7.62HP/04/270M F4 SC/4 2.6SN BK P.21	
252964000	SV-SMT 7.62HP/04/270M F4 SC/6 2.6SN BK P.21	
252965000	SV-SMT 7.62HP/04/270M F4 SC/8 2.6SN BK P.21	
252966000	SV-SMT 7.62HP/05/270M F3 SC/4 2.6SN BK P.21	

Order No.	Type	Page
2586770000	BUF 10.161T/06/180MF2 AG BK BX	P.108
2586780000	BUF 10.161T/06/180MF3 AG BK BX	P.109
2586790000	BUF 10.161T/06/180MF4 AG BK BX	P.109
2586820000	BUF 10.161T/06/180MF5 AG BK BX	P.110
2586830000	BUF 10.161T/06/180MF3 AG BK BX	P.111
2586840000	BUF 10.161T/06/180MF4 AG BK BX	P.111

259000000

2592600000	K0 BU/SU10.16HP WT	P.78
2592600000	K0 BU/SU10.16HP WT	P.80
2592600000	K0 BU/SU10.16HP WT	P.82
2592600000	K0 BU/SU10.16HP WT	P.84
2592600000	K0 BU/SU10.16HP WT	P.86
2592600000	K0 BU/SU10.16HP WT	P.88
2592600000	K0 BU/SU10.16HP WT	P.90
2592600000	K0 BU/SU10.16HP WT	P.92
2592600000	K0 BU/SU10.16HP WT	P.94
2592600000	K0 BU/SU10.16HP WT	P.96
2592600000	K0 BU/SU10.16HP WT	P.98
2592600000	K0 BU/SU10.16HP WT	P.100
2592600000	K0 BU/SU10.16HP WT	P.102
2592600000	K0 BU/SU10.16HP WT	P.104
2592600000	K0 BU/SU10.16HP WT	P.106
2592600000	K0 BU/SU10.16HP WT	P.108
2592600000	K0 BU/SU10.16HP WT	P.110
2592600000	K0 BU/SU10.16HP WT	P.220
2592600000	K0 BU/SU10.16HP WT	P.222
2592600000	K0 BU/SU10.16HP WT	P.224
2592600000	K0 BU/SU10.16HP WT	P.226
2592600000	K0 BU/SU10.16HP WT	P.228
2592600000	K0 BU/SU10.16HP WT	P.230
2592600000	K0 BU/SU10.16HP WT	P.232
2592600000	K0 BU/SU10.16HP WT	P.234
2592600000	K0 BU/SU10.16HP WT	P.236
2592600000	K0 BU/SU10.16HP WT	P.238
2592600000	K0 BU/SU10.16HP WT	P.240
2592600000	K0 BU/SU10.16HP WT	P.242
2592600000	K0 BU/SU10.16HP WT	P.244
2592600000	K0 BU/SU10.16HP WT	P.246
2592600000	K0 BU/SU10.16HP WT	P.248
2594720000	PB-C0N 160 S/02/90RFSF AG BK BX	Q.4
2594950000	PB-FEED 160 50/02RF AG BK BX	Q.5
2594960000	PB-LINK 160 100/02RF AG BK BX	Q.4
2594970000	PB-NDPCAP 160 02RF BK BX	Q.5
2595180000	PB-FEED 160 100/02RF AG BK BX	Q.5
2595440000	PB-LINK 160 50/02RF AG BK BX	Q.5
2595720000	SU 10.16HP/05/90MF2 3.5AG BK BX	P.222
2597110000	SU 10.16HP/06/90MF2 3.5AG BK BX	P.222
2597220000	SU 10.16HP/05/90MF3 3.5AG BK BX	P.223
2597230000	SU 10.16HP/06/90MF3 3.5AG BK BX	P.223
2597240000	SU 10.16HP/05/90MF4 3.5AG BK BX	P.223
2597250000	SU 10.16HP/06/90MF4 3.5AG BK BX	P.223
2597290000	SU 10.16HP/05/270MF2 3.5AG BK BX	P.228
2597300000	SU 10.16HP/06/270MF2 3.5AG BK BX	P.228
2597310000	SU 10.16HP/05/270MF3 3.5AG BK BX	P.229
2597320000	SU 10.16HP/06/270MF3 3.5AG BK BX	P.229
2597330000	SU 10.16HP/05/270MF4 3.5AG BK BX	P.229
2597340000	SU 10.16HP/06/270MF4 3.5AG BK BX	P.229

261000000

2613340000	LL 10.00/03/90 3.25N OR BX	G.40
2613390000	LL 10.00/02/90 3.25N OR BX	G.40
2614400000	BVF 7.62HP/4/180MSF4 BCF/4 SBNKBX SP90	P.42
2614140000	SLF 7.62HP/04/180RSH180 SN BK BX	P.125
2614190000	SLF 7.62HP/04/180LRSH180 SN BK BX	P.127

262000000

2624760000	CH20M45 3 SP/3P BL 2013	T.29
2626050000	RJ45C6 TV 3.0N4N TY	D.18
2626800000	SV-SMT 7.62HP/04/90MF2 SC/4 2.6SN BX	P.12
2626850000	SV-SMT 7.62HP/04/90MF2 SC/6 2.6SN BX	P.12
2626860000	SV-SMT 7.62HP/04/90MF2 SC/8 2.6SN BX	P.12
2626870000	SV-SMT 7.62HP/05/90MF2 SC/4 2.6SN BX	P.12
2626880000	SV-SMT 7.62HP/05/90MF2 SC/6 2.6SN BX	P.12
2626890000	SV-SMT 7.62HP/05/90MF2 SC/8 2.6SN BX	P.12
2626900000	SV-SMT 7.62HP/04/90MF3 SC/4 2.6SN BX	P.13
2626910000	SV-SMT 7.62HP/04/90MF3 SC/6 2.6SN BX	P.13
2626920000	SV-SMT 7.62HP/04/90MF3 SC/8 2.6SN BX	P.13
2626930000	SV-SMT 7.62HP/04/90MF2 SC/4 2.6SN BX	P.14
2626940000	SV-SMT 7.62HP/04/90MF2 SC/6 2.6SN BX	P.14
2626950000	SV-SMT 7.62HP/04/90MF2 SC/8 2.6SN BX	P.14
2626960000	SV-SMT 7.62HP/05/90MF2 SC/4 2.6SN BX	P.14
2626970000	SV-SMT 7.62HP/05/90MF2 SC/6 2.6SN BX	P.14
2626980000	SV-SMT 7.62HP/05/90MF2 SC/8 2.6SN BX	P.14
2626990000	SV-SMT 7.62HP/04/90MF3 SC/4 2.6SN BX	P.15
2627000000	SV-SMT 7.62HP/04/90MF3 SC/6 2.6SN BX	P.15
2627050000	SV-SMT 7.62HP/04/90MF3 SC/8 2.6SN BX	P.15
2627060000	SV-SMT 7.62HP/04/270MF2 SC/4 2.6SN BX	P.18
2627090000	SV-SMT 7.62HP/04/270MF2 SC/6 2.6SN BX	P.18
2627100000	SV-SMT 7.62HP/04/270MF2 SC/8 2.6SN BX	P.18
2627110000	SV-SMT 7.62HP/05/270MF2 SC/4 2.6SN BX	P.18
2627120000	SV-SMT 7.62HP/05/270MF2 SC/6 2.6SN BX	P.18
2627130000	SV-SMT 7.62HP/05/270MF2 SC/8 2.6SN BX	P.18
2627140000	SV-SMT 7.62HP/04/270MF3 SC/4 2.6SN BX	P.19
2627150000	SV-SMT 7.62HP/04/270MF3 SC/6 2.6SN BX	P.19
2627160000	SV-SMT 7.62HP/04/270MF3 SC/8 2.6SN BX	P.19

2627170000	SV-SMT 7.62HP/04/270MF2 SC/4 2.6SN BX	P.20
2627180000	SV-SMT 7.62HP/04/270MF2 SC/6 2.6SN BX	P.20
2627190000	SV-SMT 7.62HP/04/270MF2 SC/8 2.6SN BX	P.20
2627200000	SV-SMT 7.62HP/05/270MF2 SC/4 2.6SN BX	P.20
2627210000	SV-SMT 7.62HP/05/270MF2 SC/6 2.6SN BX	P.20
2627220000	SV-SMT 7.62HP/05/270MF2 SC/8 2.6SN BX	P.20
2627230000	SV-SMT 7.62HP/04/270MF3 SC/4 2.6SN BX	P.21
2627240000	SV-SMT 7.62HP/04/270MF3 SC/6 2.6SN BX	P.21
2627250000	SV-SMT 7.62HP/04/270MF3 SC/8 2.6SN BX	P.21
2627260000	BUF 10.161T/03/180MF2SH160 AG BK BX	P.96
2627260000	BUF 10.161T/03/180MF2SH160 AG BK BX	P.234
2627330000	BUZ 10.161T/03/180MF2SH160 AG BK BX	P.82
2627340000	BUZ 10.161T/04/180MF2SH160 AG BK BX	P.82
2627350000	BUZ 10.161T/03/180MF3SH160 AG BK BX	P.84
2627360000	BUZ 10.161T/04/180MF3SH160 AG BK BX	P.84
2627370000	BUZ 10.161T/04/180MF4SH160 AG BK BX	P.86
2627380000	BUZ 10.161T/03/180MF2SH180 AG BK BX	P.83
2627390000	BUZ 10.161T/04/180MF2SH180 AG BK BX	P.83
2627400000	BUZ 10.161T/03/180MF3SH180 AG BK BX	P.85
2627410000	BUZ 10.161T/04/180MF3SH180 AG BK BX	P.85
2627420000	BUZ 10.161T/04/180MF4SH180 AG BK BX	P.87
2627430000	BUZ 10.161T/03/180MF2SH200 AG BK BX	P.83
2627440000	BUZ 10.161T/04/180MF2SH200 AG BK BX	P.83
2627450000	BUZ 10.161T/03/180MF3SH200 AG BK BX	P.85
2627460000	BUZ 10.161T/04/180MF3SH200 AG BK BX	P.85
2627470000	BUZ 10.161T/04/180MF4SH200 AG BK BX	P.87
2627480000	BUZ 10.161T/03/180MF2SH160 AG BK BX	P.88
2627490000	BUZ 10.161T/04/180MF2SH160 AG BK BX	P.88
2627500000	BUZ 10.161T/03/180MF3SH160 AG BK BX	P.90
2627510000	BUZ 10.161T/04/180MF2SH180 AG BK BX	P.90
2627520000	BUZ 10.161T/04/180MF3SH180 AG BK BX	P.92
2627530000	BUZ 10.161T/03/180MF2SH180 AG BK BX	P.89
2627540000	BUZ 10.161T/04/180MF3SH180 AG BK BX	P.89
2627550000	BUZ 10.161T/03/180MF3SH180 AG BK BX	P.91
2627560000	BUZ 10.161T/04/180MF4SH180 AG BK BX	P.91
2627570000	BUZ 10.161T/04/180MF4SH180 AG BK BX	P.93
2627580000	BUZ 10.161T/03/180MF2SH200 AG BK BX	P.89
2627590000	BUZ 10.161T/04/180MF3SH200 AG BK BX	P.89
2627600000	BUZ 10.161T/03/180MF3SH200 AG BK BX	P.91
2627610000	BUZ 10.161T/04/180MF3SH200 AG BK BX	P.91
2627620000	BUZ 10.161T/04/180MF4SH200 AG BK BX	P.93
2627630000	SV 7.62HP/04/90MF2 SC/4R SN BK BX	P.24
2627680000	BUF 10.161T/04/180MF2SH160 AG BK BX	P.96
2627690000	BUF 10.161T/04/180MF2SH160 AG BK BX	P.234
2627690000	BUF 10.161T/03/180MF3SH160 AG BK BX	P.98
2627690000	BUF 10.161T/03/180MF3SH160 AG BK BX	P.236
2627700000	BUF 10.161T/04/180MF3SH160 AG BK BX	P.98
2627700000	BUF 10.161T/04/180MF3SH160 AG BK BX	P.236
2627710000	BUF 10.161T/03/180MF2SH180 AG BK BX	P.97
2627710000	BUF 10.161T/03/180MF2SH180 AG BK BX	P.235
2627720000	BUF 10.161T/04/180MF2SH180 AG BK BX	P.97
2627720000	BUF 10.161T/04/180MF3SH180 AG BK BX	P.235
2627730000	BUF 10.161T/03/180MF3SH180 AG BK BX	P.99
2627730000	BUF 10.161T/03/180MF3SH180 AG BK BX	P.237
2627740000	BUF 10.161T/04/180MF3SH180 AG BK BX	P.99
2627740000	BUF 10.161T/04/180MF3SH180 AG BK BX	P.237
2627750000	BUF 10.161T/04/180MF3SH180 AG BK BX	P.101
2627750000	BUF 10.161T/04/180MF4SH180 AG BK BX	P.239
2627760000	BUF 10.161T/03/180MF2SH200 AG BK BX	P.97
2627760000	BUF 10.161T/03/180MF2SH200 AG BK BX	P.235
2627770000	BUF 10.161T/04/180MF2SH200 AG BK BX	P.97
2627770000	BUF 10.161T/04/180MF2SH200 AG BK BX	P.235
2627780000	BUF 10.161T/03/180MF3SH200 AG BK BX	P.99
2627780000	BUF 10.161T/03/180MF3SH200 AG BK BX	P.237
2627790000	BUF 10.161T/04/180MF3SH200 AG BK BX	P.99
2627790000	BUF 10.161T/04/180MF3SH200 AG BK BX	P.237
2627800000	BUF 10.161T/04/180MF4SH200 AG BK BX	P.101
2627800000	BUF 10.161T/04/180MF4SH200 AG BK BX	P.239
2627810000	BUF 10.161T/03/180MF2SH160 AG BK BX	P.102
2627810000	BUF 10.161T/03/180MF2SH160 AG BK BX	P.240
2627820000	BUF 10.161T/04/180MF2SH160 AG BK BX	P.102
2627820000	BUF 10.161T/04/180MF2SH160 AG BK BX	P.240
2627830000	BUF 10.161T/03/180MF3SH160 AG BK BX	P.104
2627830000	BUF 10.161T/03/180MF3SH160 AG BK BX	P.242
2627840000	BUF 10.161T/04/180MF3SH160 AG BK BX	P.104
2627840000	BUF 10.161T/04/180MF3SH160 AG BK BX	P.242
2627850000	BUF 10.161T/04/180MF4SH160 AG BK BX	P.106
2627850000	BUF 10.161T/04/180MF4SH160 AG BK BX	P.244
2627860000	BUF 10.161T/03/180MF2SH180 AG BK BX	P.103
2627860000	BUF 10.161T/03/180MF2SH180 AG BK BX	P.241
2627870000	BUF 10.161T/04/180MF2SH180 AG BK BX	P.103
2627870000	BUF 10.161T/04/180MF2SH180 AG BK BX	P.241
2627880000	BUF 10.161T/03/180MF3SH180 AG BK BX	P.105
2627880000	BUF 10.161T/03/180MF3SH180 AG BK BX	P.243
2627890000	BUF 10.161T/04/180MF3SH180 AG BK BX	P.105
2627890000	BUF 10.161T/04/180MF3SH180 AG BK BX	P.243
2627900000	BUF 10.161T/04/180MF4SH180 AG BK BX	P.107
2627900000	BUF 10.161T/04/180MF4SH180 AG BK BX	P.245
2627910000	BUF 10.161T/03/180MF2SH200 AG BK BX	P.103
2627910000	BUF 10.161T/03/180MF2SH200 AG BK BX	P.241
2627920000	BUF 10.161T/04/180MF2SH200 AG BK BX	P.103
2627920000	BUF 10.161T/04/180MF2SH200 AG BK BX	P.241
2627930000	BUF 10.161T/03/180MF3SH200 AG BK BX	P.105
2627930000	BUF 10.161T/03/180MF3SH200 AG BK BX	P.243
2627940000	BUF 10.161T/04/180MF3SH200 AG BK BX	P.105
2627940000	BUF 10.161T/04/180MF3SH200 AG BK BX	P.243
2627950000	BUF 10.161T/04/180MF4SH200 AG BK BX	P.107
2627950000	BUF 10.161T/04/180MF4SH200 AG BK BX	P.245
2627960000	SV 7.62HP/04/270MF2 SC/04R SN BK BX	P.30

2627970000	SV 7.62HP/04/270MF2 SC/06R SN BK BX	P.30
2627980000	SV 7.62HP/04/270MF2 SC/08R SN BK BX	P.30
2627990000	SV 7.62HP/05/270MF2 SC/04R SN BK BX	P.30
2628000000	SV 7.62HP/05/270MF2 SC/06R SN BK BX	P.30
2628010000	SV 7.62HP/05/270MF2 SC/08R SN BK BX	P.30
2628020000	SV 7.62HP/04/270MF3 SC/04R SN BK BX	P.31
2628030000	SV 7.62HP/04/270MF3 SC/06R SN BK BX	P.31
2628040000	SV 7.62HP/04/270MF3 SC/08R SN BK BX	P.31
2628050000	SV 7.62HP/04/270MF2 SC/04R SN BK BX	P.32
2628060000	SV 7.62HP/04/270MF2 SC/06R SN BK BX	P.32
2628070000	SV 7.62HP/04/270MF2 SC/08R SN BK BX	P.32
2628080000	SV 7.62HP/05/270MF2 SC/04R SN BK BX	P.32
2628090000	SV 7.62HP/05/270MF2 SC/06R SN BK BX	P.32
2628100000	SV 7.62HP/05/270MF2 SC/08R SN BK BX	P.32
2628110000	SV 7.62HP/04/270MF3 SC/04R SN BK BX	P.33
2628120000	SV 7.62HP/04/270MF3 SC/06R SN BK BX	P.33
2628130000	SV 7.62HP/04/270MF3 SC/08R SN BK BX	P.33
2628150000	SV 7.62HP/04/90MF2 SC/06R SN BK BX	P.24
2628160000	SV 7.62HP/04/90MF2 SC/08R SN BK BX	P.24
2628170000	SV 7.62HP/05/90MF2 SC/04R SN BK BX	P.24
2628180000	SV 7.62HP/05/90MF2 SC/06R SN BK BX	P.24
2628190000	SV 7.62HP/05/90MF2 SC/08R SN BK BX	P.24
2628200000	SV 7.62HP/04/90MF3 SC/04R SN BK BX	P.25
2628210000	SV 7.62HP/04/90MF3 SC/06R SN BK BX	P.25
2628220000	SV 7.62HP/04/90MF3 SC/08R SN BK BX	P.25
2628230000	SV 7.62HP/04/90MF2 SC/04R SN BK BX	P.26
2628240000	SV 7.62HP/04/90MF2 SC/06R SN BK BX	P.26
2628250000	SV 7.62HP/04/90MF2 SC/08R SN BK BX	P.26
2628260000	SV 7.62HP/05/90MF2 SC/04R SN BK BX	P.26
2628270000	SV 7.6	

Order No.	Type	Page
2707220000	D-SUB F6.3 T25VB 3.2B4 TY BK	F.12
2707230000	D-SUB M6.3 T09VB 3.2B4 TY BK	F.13
2707240000	D-SUB M6.3 T15VB 3.2B4 TY BK	F.13
2707250000	D-SUB M6.3 T25VB 3.2B4 TY BK	F.13
2708610000	PB-CON IKSC M4X4 A2	Q.4
2708620000	PB-CON SF DELTA PT 40X12	Q.4

2710000000

2719370000	BVDF 7.62HP/02/180SN BK BX	P.204
2719380000	BVDF 7.62HP/02/180SF SN BK BX	P.205

2720000000

2720430000	BVDF 7.62HP/03/180SN BK BX	P.204
2720440000	BVDF 7.62HP/04/180SN BK BX	P.204
2720450000	BVDF 7.62HP/05/180SN BK BX	P.204
2720460000	BVDF 7.62HP/06/180SN BK BX	P.204
2720470000	BVDF 7.62HP/07/180SN BK BX	P.204
2720480000	BVDF 7.62HP/08/180SN BK BX	P.204
2720490000	BVDF 7.62HP/03/180SF SN BK BX	P.205
2720500000	BVDF 7.62HP/04/180SF SN BK BX	P.205
2720510000	BVDF 7.62HP/05/180SF SN BK BX	P.205
2720520000	BVDF 7.62HP/06/180SF SN BK BX	P.205
2720530000	BVDF 7.62HP/07/180SF SN BK BX	P.205
2720540000	BVDF 7.62HP/08/180SF SN BK BX	P.205
2720560000	BVDF 7.62HP/02/180MSF2 SN BK BX	P.205
2720570000	BVDF 7.62HP/03/180MSF3 SN BK BX	P.205
2720580000	BVDF 7.62HP/04/180MSF3 SN BK BX	P.205
2720590000	BVDF 7.62HP/05/180MSF4 SN BK BX	P.205
2720600000	BVDF 7.62HP/06/180MSF3 SN BK BX	P.205
2720610000	BVDF 7.62HP/07/180MSF2 SN BK BX	P.205
2720620000	BVDF 7.62HP/08/180MSF3 SN BK BX	P.205
2724020000	D-SUB F6.3 T25HU 3.2B4 TY BK	F.6
2724030000	D-SUB M6.3 T09HU 3.2B4 TY BK	F.7
2724060000	D-SUB M6.3 T15HU 3.2B4 TY BK	F.7
2724070000	D-SUB M6.3 T25HU 3.2B4 TY BK	F.7
2725850010	IE-S1DS2VE0010T0101-E	C.8
2725850010	IE-S1DS2VE0010T0101-E	C.10
2725850020	IE-S1DS2VE0020T0101-E	C.8
2725850020	IE-S1DS2VE0020T0101-E	C.10
2725850030	IE-S1DS2VE0030T0101-E	C.8
2725850030	IE-S1DS2VE0030T0101-E	C.10
2725850050	IE-S1DS2VE0050T0101-E	C.8
2725850050	IE-S1DS2VE0050T0101-E	C.10
2725850100	IE-S1DS2VE0100T0101-E	C.8
2725850100	IE-S1DS2VE0100T0101-E	C.10
2725850150	IE-S1DS2VE0150T0101-E	C.8
2725850150	IE-S1DS2VE0150T0101-E	C.10
2725850400	IE-S1DS2VE0400T0101-E	C.8
2725850400	IE-S1DS2VE0400T0101-E	C.10
2726010000	IE-PCB-SPD-P-90V-THR	C.9
2726010000	IE-PCB-SPD-P-90V-THR	C.14
2726020000	IE-BHD-SPE-M8-OT-PP	C.9
2726020000	IE-BHD-SPE-M8-OT-PP	C.16
2726030000	IE-BHD-SPE-M8-OT-PP	C.9
2726030000	IE-BHD-SPE-M8-OT-PP	C.16
2726040000	IE-PS-SPD-S-FH-180	C.9
2726040000	IE-PS-SPD-S-FH-180	C.13
2726050020	IE-S1DS2VE0020T01M1M1-E	C.8
2726050020	IE-S1DS2VE0020T01M1M1-E	C.11
2726050050	IE-S1DS2VE0050T01M1M1-E	C.8
2726050050	IE-S1DS2VE0050T01M1M1-E	C.11
2726050100	IE-S1DS2VE0100T01M1M1-E	C.8
2726050100	IE-S1DS2VE0100T01M1M1-E	C.11
2726050150	IE-S1DS2VE0150T01M1M1-E	C.8
2726050150	IE-S1DS2VE0150T01M1M1-E	C.11
2726050200	IE-S1DS2VE0200T01M1M1-E	C.8
2726050200	IE-S1DS2VE0200T01M1M1-E	C.11
2726050400	IE-S1DS2VE0400T01M1M1-E	C.8
2726050400	IE-S1DS2VE0400T01M1M1-E	C.11
2726060020	IE-S1DS2VE0020T01M2M2-E	C.8
2726060020	IE-S1DS2VE0020T01M2M2-E	C.11
2726070020	IE-S1DS2VE0020T02M2M2-E	C.8
2726070020	IE-S1DS2VE0020T02M2M2-E	C.12

2730000000

2735920000	IE-PCB-SPM-P-180-THR	C.9
2735920000	IE-PCB-SPM-P-180-THR	C.17
2738670000	CH20M45 B SIM BK/BK 2010	T.28
2739640000	IE-BHD-SPE-FP-CN-M10X0.75	C.9
2739640000	IE-BHD-SPE-FP-CN-M10X0.75	C.16

2740000000

2741400000	MHS 5/02 H T3 B T	B.10
2741420000	MHS 5/03 H T3 B T	B.10
2741430000	MHS 5/04 H T3 B T	B.10
2741440000	MHS 5/05 H T3 B T	B.10
2741450000	MHS 5/06 H T3 B T	B.10
2741460000	MHS 5/07 H T3 B T	B.10
2741470000	MHS 5/08 H T3 B T	B.10
2741480000	MHS 5/09 H T3 B T	B.10
2741490000	MHS 5/10 H T3 B T	B.10
2741500000	MHS 5/11 H T3 B T	B.10
2741510000	MHS 5/12 H T3 B T	B.10
2741520000	MHS 5/03 D11 H T3 B T	B.22
2741530000	MHS 5/04 D11 H T3 B T	B.22

Order No.	Type	Page
2741540000	MHS 5/05 D11 H T3 B T	B.22
2741550000	MHS 5/06 D11 H T3 B T	B.22
2741560000	MPS 5/02 S TN B B	B.13
2741570000	MPS 5/03 S TN B B	B.13
2741580000	MPS 5/04 S TN B B	B.13
2741590000	MPS 5/05 S TN B B	B.13
2741600000	MPS 5/06 S TN B B	B.13
2741610000	MPS 5/07 S TN B B	B.13
2741620000	MPS 5/08 S TN B B	B.13
2741630000	MPS 5/09 S TN B B	B.13
2741640000	MPS 5/10 S TN B B	B.13
2741650000	MPS 5/11 S TN B B	B.13
2741660000	MPS 5/12 S TN B B	B.13
2741670000	MPS 5/02 S F1 TN B B	B.14
2741680000	MPS 5/03 S F2 TN B B	B.14
2741690000	MPS 5/04 S F2 TN B B	B.14
2741700000	MPS 5/05 S F3 TN B B	B.14
2741710000	MPS 5/06 S F3 TN B B	B.14
2741720000	MPS 5/07 S F4 TN B B	B.14
2741730000	MPS 5/08 S F4 TN B B	B.14
2741740000	MPS 5/09 S F5 TN B B	B.14
2741750000	MPS 5/10 S F5 TN B B	B.14
2741760000	MPS 5/11 S F6 TN B B	B.14
2741770000	MPS 5/12 S F6 TN B B	B.14
2741780000	MPS 5/03 D11 S TN B B	B.23
2741790000	MPS 5/04 D11 S TN B B	B.23
2741800000	MPS 5/05 D11 S TN B B	B.23
2741810000	MPS 5/06 D11 S TN B B	B.23
2741890000	MPS 5/03 D11 S F2 TN B B	B.24
2741900000	MPS 5/04 D11 S F2 TN B B	B.24
2741910000	MPS 5/05 D11 S F3 TN B B	B.24
2741920000	MPS 5/06 D11 S F3 TN B B	B.24
2745200000	CH20M67 B ZFE BK/OR	T.30
2746980000	FMH1 S1/12V F1 B RL	H.8
2746990000	FMH1 S1/16V F1 B RL	H.8
2747000000	FMH1 S1/20V F1 B RL	H.8
2747010000	FMH1 S1/26V F1 B RL	H.8
2747020000	FMH1 S1/32V F1 B RL	H.8
2747030000	FMH1 S1/40V F1 B RL	H.8
2747040000	FMH1 S1/50V F1 B RL	H.8
2747050000	FMH1 S1/68V F1 B RL	H.8
2747060000	FMH1 S1/80V F1 B RL	H.8
2747070000	FMH3 S1/12V F1 B RL	H.10
2747080000	FMH3 S1/16V F1 B RL	H.10
2747090000	FMH3 S1/20V F1 B RL	H.10
2747100000	FMH3 S1/26V F1 B RL	H.10
2747110000	FMH3 S1/32V F1 B RL	H.10
2747120000	FMH3 S1/40V F1 B RL	H.10
2747130000	FMH3 S1/50V F1 B RL	H.10
2747140000	FMH3 S1/68V F1 B RL	H.10
2747150000	FMH3 S1/80V F1 B RL	H.10
2747160000	FMH S1/12H F1 B RL	H.6
2747170000	FMH S1/16H F1 B RL	H.6
2747180000	FMH S1/20H F1 B RL	H.6
2747190000	FMH S1/26H F1 B RL	H.6
2747200000	FMH S1/32H F1 B RL	H.6
2747210000	FMH S1/40H F1 B RL	H.6
2747220000	FMH S1/50H F1 B RL	H.6
2747230000	FMH S1/68H F1 B RL	H.6
2747240000	FMH S1/80H F1 B RL	H.6
2747250000	FFH6 S1/12V F1 B RL	H.12
2747260000	FFH6 S1/16V F1 B RL	H.12
2747270000	FFH6 S1/20V F1 B RL	H.12
2747280000	FFH6 S1/26V F1 B RL	H.12
2747290000	FFH6 S1/32V F1 B RL	H.12
2747300000	FFH6 S1/40V F1 B RL	H.12
2747310000	FFH6 S1/50V F1 B RL	H.12
2747320000	FFH6 S1/68V F1 B RL	H.12
2747330000	FFH6 S1/80V F1 B RL	H.12
2747340000	FFH9 S1/12V F1 B RL	H.16
2747350000	FFH9 S1/16V F1 B RL	H.16
2747360000	FFH9 S1/20V F1 B RL	H.16
2747370000	FFH9 S1/26V F1 B RL	H.16
2747380000	FFH9 S1/32V F1 B RL	H.16
2747390000	FFH9 S1/40V F1 B RL	H.16
2747400000	FFH9 S1/50V F1 B RL	H.16
2747410000	FFH9 S1/68V F1 B RL	H.16
2747420000	FFH9 S1/80V F1 B RL	H.16
2747440000	FFH S1/16H F1 B RL	H.12
2747450000	FFH S1/20H F1 B RL	H.12
2747460000	FFH S1/26H F1 B RL	H.12
2747470000	FFH S1/32H F1 B RL	H.12
2747480000	FFH S1/40H F1 B RL	H.12
2747490000	FFH S1/50H F1 B RL	H.12
2747500000	FFH S1/68H F1 B RL	H.12
2747510000	FFH S1/80H F1 B RL	H.12
2747520000	FFP D1/12H S1 B TY	H.18
2747530000	FFP D1/16H S1 B TY	H.18
2747540000	FFP D1/20H S1 B TY	H.18
2747550000	FFP D1/26H S1 B TY	H.18
2747560000	FFP D1/32H S1 B TY	H.18
2747570000	FFP D1/40H S1 B TY	H.18
2747580000	FFP D1/50H S1 B TY	H.18
2747590000	FFP D1/68H S1 B TY	H.18
2747600000	FFP D1/80H S1 B TY	H.18
2749320000	SDS 0.4X2.5X75	G.19
2749330000	SDS 0.4X2.5X75	G.20
2749320000	SDS 0.4X2.5X75	G.21

Order No.	Type	Page
2749320000	SDS 0.4X2.5X75	G.46
2749320000	SDS 0.4X2.5X75	G.48
2749320000	SDS 0.4X2.5X75	G.50
2749320000	SDS 0.4X2.5X75	G.52
2749320000	SDS 0.4X2.5X75	G.54
2749320000	SDS 0.4X2.5X75	G.56
2749320000	SDS 0.4X2.5X75	G.58
2749320000	SDS 0.4X2.5X75	G.60
2749320000	SDS 0.4X2.5X75	G.62
2749320000	SDS 0.4X2.5X75	G.64
2749320000	SDS 0.4X2.5X75	G.66
2749320000	SDS 0.4X2.5X75	G.68
2749320000	SDS 0.4X2.5X75	G.70
2749320000	SDS 0.4X2.5X75	G.72
2749320000	SDS 0.4X2.5X75	G.74
2749320000	SDS 0.4X2.5X75	G.76
2749320000	SDS 0.4X2.5X75	G.78
2749320000	SDS 0.4X2.5X75	G.80
2749320000	SDS 0.4X2.5X75	G.82
2749320000	SDS 0.4X2.5X75	G.84
2749320000	SDS 0.4X2.5X75	G.86
2749320000	SDS 0.4X2.5X75	G.92
2749320000	SDS 0.4X2.5X75	G.96
2749320000	SDS 0.4X2.5X75	J.18
2749320000	SDS 0.4X2.5X75	J.48
2749320000	SDS 0.4X2.5X75	J.50
2749320000	SDS 0.4X2.5X75	J.52
2749320000	SDS 0.4X2.5X75	J.54
2749320000	SDS 0.4X2.5X75	J.56
2749320000	SDS 0.4X2.5X75	J.58
2749320000	SDS 0.4X2.5X75	J.60
2749320000	SDS 0.4X2.5X75	K.46
2749320000	SDS 0.4X2.5X75	K.48
2749320000	SDS 0.4X2.5X75	K.50
2749320000	SDS 0.4X2.5X75	K.52
2749320000	SDS 0.4X2.5X75	K.54
2749320000	SDS 0.4X2.5X75	K.56
2749320000	SDS 0.4X2.5X75	N.16
2749320000	SDS 0.4X2.5X75	R.10
2749320000	SDS 0.4X2.5X75	S.5
2749320000	SDS 0.4X2.5X75	T.57
2		

Order No.	Type	Page	Order No.	Type	Page	Order No.	Type	Page	Order No.	Type	Page
2749440000	SDK PZ1 X 80	L.96	2749810000	SDIS 0.6X3.5X100	L.86	2771160000	CH20M6 BC 4P-4P BK 1 1261494	T.21	2826890000	FC20 PN/12A S1 B BX	H.21
2749440000	SDK PZ1 X 80	L.98	2749810000	SDIS 0.6X3.5X100	L.88	2771170000	CH20M6 BC 4P-4P BUS TGY 1 1293806	T.21	2826900000	FC50 PN/12A S1 B BX	H.21
2749440000	SDK PZ1 X 80	L.100	2749810000	SDIS 0.6X3.5X100	L.90	2771180000	CH20M6 BC 4P-4P GY 1 1261516	T.21	2826910000	FC10 TN/12A S1 B BX	H.23
2749440000	SDK PZ1 X 80	L.102	2749810000	SDIS 0.6X3.5X100	L.92	2771190000	CH20M6 BC 4P-4P RD 1 1261515	T.21	2826920000	FC20 TN/12A S1 B BX	H.23
2749440000	SDK PZ1 X 80	N.16	2749810000	SDIS 0.6X3.5X100	L.93	2771200000	CH20M6 BC 4P-4P TGY 1 1293806	T.21	2826930000	FC50 TN/12A S1 B BX	H.23
2749440000	SDK PZ1 X 80	Q.16	2749810000	SDIS 0.6X3.5X100	L.94	2771210000	CH20M6 BC 4P-4P AGY 1 1293807	T.21	2826940000	FC10 PN/16A S1 B BX	H.21
2749440000	SDK PZ1 X 80	S.5	2749810000	SDIS 0.6X3.5X100	L.96	2771220000	CH20M6 BC 4P-4P BUS AGY 1 1293807	T.21	2826950000	FC20 PN/16A S1 B BX	H.21
2749440000	SDK PZ1 X 80	T.57	2749810000	SDIS 0.6X3.5X100	L.98	2771400000	CH20M6 BP 4P-4P BUS TGY LF 1 1293806	T.20	2826960000	FC50 PN/16A S1 B BX	H.21
2749450000	SDK PZ2 X 100	N.16	2749810000	SDIS 0.6X3.5X100	L.100	2771410000	CH20M6 BP 4P-4P GY LF 1 1261515	T.20	2826970000	FC10 TN/16A S1 B BX	H.23
2749450000	SDK PZ2 X 100	Q.18	2749810000	SDIS 0.6X3.5X100	L.102	2771420000	CH20M6 BP 4P-4P BUS AGY LF 1 1293807	T.20	2826980000	FC20 TN/16A S1 B BX	H.23
2749450000	SDK PZ2 X 100	Q.19	2749810000	SDIS 0.6X3.5X100	L.104	2771430000	CH20M6 BP 4P-4P BUS BK LF 1 1261494	T.20	2826990000	FC50 TN/16A S1 B BX	H.23
2749450000	SDK PZ2 X 100	Q.20	2749810000	SDIS 0.6X3.5X100	L.106	2771440000	CH20M6 BP 4P-4P BUS GY LF 1 1261516	T.20	2827000000	FC10 PN/20A S1 B BX	H.21
2749450000	SDK PZ2 X 100	Q.21	2749810000	SDIS 0.6X3.5X100	L.108	2771450000	CH20M6 BP 4P-4P AGY LF 1 1293807	T.20	2827010000	FC20 PN/20A S1 B BX	H.21
2749450000	SDK PZ2 X 100	Q.22	2749810000	SDIS 0.6X3.5X100	L.110	2771460000	CH20M6 BP 4P-4P GY LF 1 1261516	T.20	2827020000	FC50 PN/20A S1 B BX	H.21
2749450000	SDK PZ2 X 100	Q.24	2749810000	SDIS 0.6X3.5X100	L.112	2771470000	CH20M6 BP 4P-4P GY LF 1 1261494	T.20	2827030000	FC10 TN/20A S1 B BX	H.23
2749450000	SDK PZ2 X 100	P.82	2749810000	SDIS 0.6X3.5X100	L.114	2771480000	CH20M6 BP 4P-4P TGY LF 1 1293806	T.20	2827040000	FC20 TN/20A S1 B BX	H.23
2749450000	SDK PZ2 X 100	P.84	2749810000	SDIS 0.6X3.5X100	N.16	2771490000	CH20M6 BP 4P-4P RD LF 1 1261515	T.20	2827050000	FC50 TN/20A S1 B BX	H.23
2749450000	SDK PZ2 X 100	P.86	2749810000	SDIS 0.6X3.5X100	P.66	2774540000	LMF 7.50/02/180 3.5SN OR BX	G.93	2827060000	FC10 PN/26A S1 B BX	H.21
2749450000	SDK PZ2 X 100	P.88	2749810000	SDIS 0.6X3.5X100	P.124	2774550000	LMF 7.50/03/180 3.5SN OR BX	G.93	2827070000	FC20 PN/26A S1 B BX	H.21
2749450000	SDK PZ2 X 100	P.90	2749810000	SDIS 0.6X3.5X100	P.126	2774560000	LMF 7.50/04/180 3.5SN OR BX	G.93	2827080000	FC50 PN/26A S1 B BX	H.21
2749450000	SDK PZ2 X 100	P.92	2749810000	SDIS 0.6X3.5X100	P.128	2774570000	LMF 7.50/05/180 3.5SN OR BX	G.93	2827090000	FC10 TN/26A S1 B BX	H.23
2749450000	SDK PZ2 X 100	P.94	2749810000	SDIS 0.6X3.5X100	P.130	2774580000	LMF 7.50/06/180 3.5SN OR BX	G.93	2827100000	FC20 TN/26A S1 B BX	H.23
2749450000	SDK PZ2 X 100	P.230	2749810000	SDIS 0.6X3.5X100	P.178	2774590000	LMF 7.50/07/180 3.5SN OR BX	G.93	2827110000	FC50 TN/26A S1 B BX	H.23
2749450000	SDK PZ2 X 100	P.232	2749810000	SDIS 0.6X3.5X100	R.12	2774600000	LMF 7.50/08/180 3.5SN OR BX	G.93	2827120000	FC10 PN/32A S1 B BX	H.21
2749450000	SDK PZ2 X 100	S.5	2749810000	SDIS 0.6X3.5X100	S.5	2774610000	LMF 7.50/09/180 3.5SN OR BX	G.93	2827130000	FC20 PN/32A S1 B BX	H.21
2749450000	SDK PZ2 X 100	T.57	2749810000	SDIS 0.6X3.5X100	T.57	2774620000	LMF 7.50/10/180 3.5SN OR BX	G.93	2827140000	FC50 PN/32A S1 B BX	H.21
2749460000	SDK PZ3 X 150	N.16	2749820000	SDIS 0.8X4.0X100	G.38	2774630000	LMF 7.50/11/180 3.5SN OR BX	G.93	2827150000	FC10 TN/32A S1 B BX	H.23
2749460000	SDK PZ3 X 150	S.5	2749820000	SDIS 0.8X4.0X100	G.39	2774640000	LMF 7.50/12/180 3.5SN OR BX	G.93	2827160000	FC20 TN/32A S1 B BX	H.23
2749460000	SDK PZ3 X 150	T.57	2749820000	SDIS 0.8X4.0X100	N.16	2774650000	LMFS 7.50/02/180 3.5SN OR BX	G.93	2827170000	FC50 TN/32A S1 B BX	H.23
2749790000	SDIS 0.4X2.5X75	G.18	2749820000	SDIS 0.8X4.0X100	N.16	2774770000	LMFS 7.50/03/180 3.5SN OR BX	G.93	2827180000	FC10 PN/40A S1 B BX	H.21
2749790000	SDIS 0.4X2.5X75	G.19	2749820000	SDIS 0.8X4.0X100	Q.28	2774780000	LMFS 7.50/04/180 3.5SN OR BX	G.93	2827190000	FC20 PN/40A S1 B BX	H.21
2749790000	SDIS 0.4X2.5X75	G.20	2749820000	SDIS 0.8X4.0X100	Q.29	2774790000	LMFS 7.50/05/180 3.5SN OR BX	G.93	2827200000	FC50 PN/40A S1 B BX	H.21
2749790000	SDIS 0.4X2.5X75	G.21	2749820000	SDIS 0.8X4.0X100	Q.30	2774800000	LMFS 7.50/06/180 3.5SN OR BX	G.93	2827210000	FC10 TN/40A S1 B BX	H.23
2749790000	SDIS 0.4X2.5X75	G.46	2749820000	SDIS 0.8X4.0X100	Q.31	2774810000	LMFS 7.50/07/180 3.5SN OR BX	G.93	2827220000	FC20 TN/40A S1 B BX	H.23
2749790000	SDIS 0.4X2.5X75	G.48	2749820000	SDIS 0.8X4.0X100	Q.32	2774820000	LMFS 7.50/08/180 3.5SN OR BX	G.93	2827230000	FC50 TN/40A S1 B BX	H.23
2749790000	SDIS 0.4X2.5X75	G.50	2749820000	SDIS 0.8X4.0X100	Q.33	2774830000	LMFS 7.50/09/180 3.5SN OR BX	G.93	2827240000	FC10 PN/50A S1 B BX	H.21
2749790000	SDIS 0.4X2.5X75	G.52	2749820000	SDIS 0.8X4.0X100	Q.34	2774840000	LMFS 7.50/10/180 3.5SN OR BX	G.93	2827250000	FC20 PN/50A S1 B BX	H.21
2749790000	SDIS 0.4X2.5X75	G.54	2749820000	SDIS 0.8X4.0X100	Q.35	2774850000	LMFS 7.50/11/180 3.5SN OR BX	G.93	2827260000	FC50 PN/50A S1 B BX	H.21
2749790000	SDIS 0.4X2.5X75	G.56	2749820000	SDIS 0.8X4.0X100	Q.36	2774860000	LMFS 7.50/12/180 3.5SN OR BX	G.93	2827270000	FC10 TN/50A S1 B BX	H.23
2749790000	SDIS 0.4X2.5X75	G.58	2749820000	SDIS 0.8X4.0X100	Q.37				2827280000	FC20 TN/50A S1 B BX	H.23
2749790000	SDIS 0.4X2.5X75	G.60	2749820000	SDIS 0.8X4.0X100	Q.38				2827290000	FC50 TN/50A S1 B BX	H.23
2749790000	SDIS 0.4X2.5X75	G.62	2749820000	SDIS 0.8X4.0X100	Q.39				2827300000	FC10 PN/68A S1 B BX	H.21
2749790000	SDIS 0.4X2.5X75	G.64	2749820000	SDIS 0.8X4.0X100	Q.40	2786530000	LMFV 5.00/02/90 3.5SN OR BX	G.94	2827310000	FC20 PN/68A S1 B BX	H.21
2749790000	SDIS 0.4X2.5X75	G.66	2749820000	SDIS 0.8X4.0X100	Q.41	2786540000	LMFV 5.00/03/90 3.5SN OR BX	G.94	2827320000	FC50 PN/68A S1 B BX	H.21
2749790000	SDIS 0.4X2.5X75	G.68	2749820000	SDIS 0.8X4.0X100	R.14	2786550000	LMFV 5.00/04/90 3.5SN OR BX	G.94	2827330000	FC10 TN/68A S1 B BX	H.23
2749790000	SDIS 0.4X2.5X75	G.70	2749820000	SDIS 0.8X4.0X100	R.16	2786560000	LMFV 5.00/05/90 3.5SN OR BX	G.94	2827340000	FC20 TN/68A S1 B BX	H.23
2749790000	SDIS 0.4X2.5X75	G.72	2749820000	SDIS 0.8X4.0X100	S.5	2786570000	LMFV 5.00/06/90 3.5SN OR BX	G.94	2827350000	FC50 TN/68A S1 B BX	H.23
2749790000	SDIS 0.4X2.5X75	G.74	2749820000	SDIS 0.8X4.0X100	T.57	2786580000	LMFV 5.00/07/90 3.5SN OR BX	G.94	2827360000	FC10 PN/80A S1 B BX	H.21
2749790000	SDIS 0.4X2.5X75	G.76	2749830000	SDIS 1.0X4.5X125	N.16	2786590000	LMFV 5.00/08/90 3.5SN OR BX	G.94	2827370000	FC20 PN/80A S1 B BX	H.21
2749790000	SDIS 0.4X2.5X75	G.78	2749830000	SDIS 1.0X4.5X125	S.5	2786600000	LMFV 5.00/09/90 3.5SN OR BX	G.94	2827380000	FC50 PN/80A S1 B BX	H.21
2749790000	SDIS 0.4X2.5X75	G.80	2749830000	SDIS 1.0X4.5X125	T.57	2786620000	LMFV 5.00/10/90 3.5SN OR BX	G.94	2827390000	FC10 TN/80A S1 B BX	H.23
2749790000	SDIS 0.4X2.5X75	G.82	2749850000	SDIS 1.0X5.5X125	N.16	2786630000	LMFV 5.00/11/90 3.5SN OR BX	G.94	2827400000	FC20 TN/80A S1 B BX	H.23
2749790000	SDIS 0.4X2.5X75	G.84	2749850000	SDIS 1.0X5.5X125	Q.18	2786640000	LMFV 5.00/12/90 3.5SN OR BX	G.94	2827410000	FC50 TN/80A S1 B BX	H.23
2749790000	SDIS 0.4X2.5X75	G.86	2749850000	SDIS 1.0X5.5X125	Q.19	2786690000	LMFV 5.00/16/90 3.5SN OR BX	G.94			
2749790000	SDIS 0.4X2.5X75	G.88	2749850000	SDIS 1.0X5.5X125	Q.20	2787570000	LMFV 7.50/02/90 3.5SN OR BX	G.95			
2749790000	SDIS 0.4X2.5X75	J.48	2749850000	SDIS 1.0X5.5X125	Q.21	2787580000	LMFV 7.50/03/90 3.5SN OR BX	G.95			
2749790000	SDIS 0.4X2.5X75	J.50	2749850000	SDIS 1.0X5.5X125	P.82	2787590000	LMFV 7.50/04/90 3.5SN OR BX	G.95			
2749790000	SDIS 0.4X2.5X75	J.52	2749850000	SDIS 1.0X5.5X125	P.84	2787600000	LMFV 7.50/05/90 3.5SN OR BX	G.95			
2749790000	SDIS 0.4X2.5X75	J.54	2749850000	SDIS 1.0X5.5X125	P.86	2787610000	LMFV 7.50/06/90 3.5SN OR BX	G.95			
2749790000	SDIS 0.4X2.5X75	J.56	2749850000	SDIS 1.0X5.5X125	P.88	2787620000	LMFV 7.50/07/90 3.5SN OR BX	G.95			
2749790000	SDIS 0.4X2.5X75	J.58	2749850000	SDIS 1.0X5.5X125	P.90	2787630000	LMFV 7.50/08/90 3.5SN OR BX	G.95			
2749790000	SDIS 0.4X2.5X75	K.44	2749850000	SDIS 1.0X5.5X125	P.92	2787640000	LMFV 7.50/09/90 3.5SN OR BX	G.95			
2749790000	SDIS 0.4X2.5X75	K.46	2749850000	SDIS 1.0X5.5X125	P.94	2787650000	LMFV 7.50/10/90 3.5SN OR BX	G.95			
2749790000	SDIS 0.4X2.5X75	K.48	2749850000	SDIS 1.0X5.5X125	P.230	2787660000	LMFV 7.50/11/90 3.5SN OR BX	G.95			
2749790000	SDIS 0.4X2.5X75	K.50	2749850000	SDIS 1.0X5.5X125	P.232	2787670000	LMFV 7.50/12/90 3.5SN OR BX	G.95			
2749790000	SDIS 0.4X2.5X75	K.52	2749850000	SDIS 1.0X5.5X125	R.18						
2749790000	SDIS 0.4X2.5X75	K.54	2749850000	SDIS 1.0X5.5X125	S.5						
2749790000	SDIS 0.4X2.5X75	K.56	2749850000	SDIS 1.0X5.5X125	T.57						
2749790000	SDIS 0.4X2.5X75	N.16	2749860000	SDIS 1.2X6.5X150	N.16	2795100000	IE-PCB-SPM-P-90-THR	C.9			
2749790000	SDIS 0.4X2.5X75	S.5	2749860000	SDIS 1.2X6.5X150	Q.22	2795100000	IE-PCB-SPM-P-90-THR	C.9			
2749790000	SDIS 0.4X2.5X75	T.57	2749860000	SDIS 1.2X6.5X150	Q.24	2795110000	IE-PCB-SPM-P-180-SMD	C.17			
2749800000	SDIS 0.5X3.0X100	N.16	2749860000	SDIS 1.2X6.5X150	R.20	2795110000	IE-PCB-SPM-P-180-SMD	C.17			
2749800000	SDIS 0.5X3.0X100	Q.26	2749860000	SDIS 1.2X6.5X150	R.22	2795120000	IE-PCB-SPD-P-90V-THR-YG/YG	C.9			
2749800000	SDIS 0.5X3.0X100	Q.27	2749860000	SDIS 1.2X6.5X150	S.5	2795120000	IE-PCB-SPD-P-90V-THR-YG/YG	C.14			

Order No.	Type	Page
-----------	------	------

4340000000

4340430000	PF RS 45 OR 2000MM	T.50
------------	--------------------	------

8000000000

8000072425	MHS 5/02 V T3 B T	B.11
8000072430	MHS 5/03 V T3 B T	B.11
8000072431	MHS 5/04 V T3 B T	B.11
8000072435	MHS 5/05 V T3 B T	B.11
8000072438	MHS 5/06 V T3 B T	B.11
8000072450	MHS 5/07 V T3 B T	B.11
8000072453	MHS 5/08 V T3 B T	B.11
8000072454	MHS 5/09 V T3 B T	B.11
8000072456	MHS 5/10 V T3 B T	B.11
8000072461	MHS 5/11 V T3 B T	B.11
8000072470	MHS 5/12 V T3 B T	B.11
8000072497	MHS 5/02 W T3 B T	B.12
8000072503	MHS 5/03 W T3 B T	B.12
8000072506	MHS 5/04 W T3 B T	B.12
8000072508	MHS 5/05 W T3 B T	B.12
8000072509	MHS 5/06 W T3 B T	B.12
8000072510	MHS 5/07 W T3 B T	B.12
8000072511	MHS 5/08 W T3 B T	B.12
8000072512	MHS 5/09 W T3 B T	B.12
8000072513	MHS 5/10 W T3 B T	B.12
8000072514	MHS 5/11 W T3 B T	B.12
8000072515	MHS 5/12 W T3 B T	B.12
8000078306	MHS 7S/02 H T3 B T	B.15
8000078308	MHS 7S/03 H T3 B T	B.15
8000078309	MHS 7S/04 H T3 B T	B.15
8000078310	MHS 7S/05 H T3 B T	B.15
8000078311	MHS 7S/06 H T3 B T	B.15
8000078312	MHS 7S/07 H T3 B T	B.15
8000078313	MHS 7S/08 H T3 B T	B.15
8000078314	MHS 7S/02 V T3 B T	B.16
8000078315	MHS 7S/03 V T3 B T	B.16
8000078316	MHS 7S/04 V T3 B T	B.16
8000078317	MHS 7S/05 V T3 B T	B.16
8000078318	MHS 7S/06 V T3 B T	B.16
8000078319	MHS 7S/07 V T3 B T	B.16
8000078320	MHS 7S/08 V T3 B T	B.16
8000078321	MHS 7S/02 W T3 B T	B.17
8000078322	MHS 7S/03 W T3 B T	B.17
8000078323	MHS 7S/04 W T3 B T	B.17
8000078324	MHS 7S/05 W T3 B T	B.17
8000078325	MHS 7S/06 W T3 B T	B.17
8000078326	MHS 7S/07 W T3 B T	B.17
8000078327	MHS 7S/08 W T3 B T	B.17
8000078328	MPS 7S/02 S TN B B	B.18
8000078329	MPS 7S/03 S TN B B	B.18
8000078330	MPS 7S/04 S TN B B	B.18
8000078331	MPS 7S/05 S TN B B	B.18
8000078332	MPS 7S/06 S TN B B	B.18
8000078333	MPS 7S/07 S TN B B	B.18
8000078334	MPS 7S/08 S TN B B	B.18
8000078335	MHS 7S/02-5/02 H	B.20
8000078336	MHS 7S/03-5/02 H	B.20
8000078337	MHS 7S/04-5/02 H	B.20
8000078338	MHS 7S/02-5/03 H	B.20
8000078339	MHS 7S/03-5/03 H	B.20
8000078340	MHS 7S/04-5/03 H	B.20
8000078341	MHS 7S/02-5/04 H	B.20
8000078342	MHS 7S/03-5/04 H	B.20
8000078343	MHS 7S/04-5/04 H	B.20
8000078344	MPS 7S/02-5/02	B.21
8000078345	MPS 7S/03-5/02	B.21
8000078346	MPS 7S/04-5/02	B.21
8000078347	MPS 7S/02-5/03	B.21
8000078348	MPS 7S/03-5/03	B.21
8000078349	MPS 7S/04-5/03	B.21
8000078350	MPS 7S/02-5/04	B.21
8000078351	MPS 7S/03-5/04	B.21
8000078352	MPS 7S/04-5/04	B.21
8000078353	MPS 7S/02 S F1 TN B B	B.19
8000078354	MPS 7S/03 S F2 TN B B	B.19
8000078355	MPS 7S/04 S F2 TN B B	B.19
8000078356	MPS 7S/05 S F3 TN B B	B.19
8000078357	MPS 7S/06 S F3 TN B B	B.19
8000078358	MPS 7S/07 S F4 TN B B	B.19
8000078359	MPS 7S/08 S F4 TN B B	B.19
8000085192	MHS 7S/03-5/02 D11 H T3 B T	B.25
8000085260	MHS 7S/04-5/02 D11 H T3 B T	B.25
8000085261	MHS 7S/03-5/04 D11 H T3 B T	B.25
8000085263	MHS 7S/04-5/04 D11 H T3 B T	B.25
8000085268	MPS 7S/03-5/02 D11 S TN B B	B.26
8000085269	MPS 7S/04-5/02 D11 S TN B B	B.26
8000085270	MPS 7S/03-5/04 D11 S TN B B	B.26
8000085271	MPS 7S/04-5/04 D11 S TN B B	B.26

8140000000

8140860000	AP 45/RE DI GR	T.50
8140870000	AP 45/LI DI GR	T.50
8140880000	PF RS 45 GR 1000MM	T.50
8143900000	AP 45/RE GR 2025	T.50
8143910000	AP 45/LI GR 2025	T.50

Order No.	Type	Page
-----------	------	------

8150000000

8156200000	AP RF 80 RE 2025	T.52
8156210000	AP RF 80 LI 2025	T.52

8320000000

8320300000	AP 80 GR	T.52
------------	----------	------

8380000000

8389030000	AP MCZ1.5 1674	T.45
------------	----------------	------

8850000000

8857560000	MCZ 5	T.45
------------	-------	------

9000000000

9004530000	DW RSV 1.6	M.14
9004530000	DW RSV 1.6	N.15
9004590000	HO.5/14S W	L.46
9004590000	HO.5/14S W	L.48
9004590000	HO.5/14S W	L.84
9004590000	HO.5/14S W	L.88
9004590000	HO.5/14S W	L.94
9004590000	HO.5/14S W	L.108
9004590000	HO.5/14S W	L.110
9004590000	HO.5/14S W	L.112
9004590000	HO.5/14S W	L.114
9005990000	PZ 1.5	J.12
9005990000	PZ 1.5	J.18
9005990000	PZ 1.5	J.52
9005990000	PZ 1.5	J.54
9005990000	PZ 1.5	J.56
9005990000	PZ 1.5	J.58
9005990000	PZ 1.5	K.54
9005990000	PZ 1.5	K.56

9010000000

9011460000	PZ 6/5	J.12
9011460000	PZ 6/5	J.18
9011460000	PZ 6/5	J.52
9011460000	PZ 6/5	J.54
9011460000	PZ 6/5	J.56
9011460000	PZ 6/5	J.58
9011460000	PZ 6/5	K.54
9011460000	PZ 6/5	K.56
9011460000	PZ 6/5	P.34
9011460000	PZ 6/5	P.36
9011460000	PZ 6/5	P.38
9011460000	PZ 6/5	P.40
9011460000	PZ 6/5	P.42
9011460000	PZ 6/5	P.44
9011460000	PZ 6/5	P.46
9011460000	PZ 6/5	P.50
9011460000	PZ 6/5	P.52
9011460000	PZ 6/5	P.132
9011460000	PZ 6/5	P.172
9011460000	PZ 6/5	P.174
9011460000	PZ 6/5	P.176
9011460000	PZ 6/5	P.178
9011460000	PZ 6/5	P.180
9011460000	PZ 6/5	P.182
9011460000	PZ 6/5	P.184
9011460000	PZ 6/5	P.186
9011460000	PZ 6/5	P.194
9011460000	PZ 6/5	P.196
9011460000	PZ 6/5	P.198
9011460000	PZ 6/5	P.200
9011460000	PZ 6/5	P.202
9011460000	PZ 6/5	P.204
9011460000	PZ 6/5	R.10
9013090000	HTF 28	N.14
9013400000	HTF 63	N.14
9013550000	HTF RSV 12	N.14
9013560000	HTF RSV 16	N.14
9013560000	HTF RSV 16	N.14
9014140000	HTF OFF	L.116
9014140000	HTF OFF	N.14
9018560000	H1.0/14S R	L.46
9018560000	H1.0/14S R	L.48
9018560000	H1.0/14S R	L.94
9018560000	H1.0/14S R	L.108
9018560000	H1.0/14S R	L.110
9018560000	H1.0/14S R	L.112
9018560000	H1.0/14S R	L.114

9020000000

9025240000	H1.5/14DS SW	L.46
9025240000	H1.5/14DS SW	L.48
9025240000	H1.5/14DS SW	L.84
9025240000	H1.5/14DS SW	L.88
9025240000	H1.5/14DS SW	L.94
9025240000	H1.5/14DS SW	L.108
9025240000	H1.5/14DS SW	L.110
9025240000	H1.5/14DS SW	L.112

Order No.	Type	Page
-----------	------	------

9025240000	H1.5/14DS SW	L.114
------------	--------------	-------

9990000000

9994130000	LM 5.08/04/90 3.5SN OR BX	G.26
9994140000	LM 5.08/05/90 3.5SN OR BX	G.26
9994150000	LM 5.08/06/90 3.5SN OR BX	G.26
9994160000	LM 5.08/07/90 3.5SN OR BX	G.26
9994170000	LM 5.08/08/90 3.5SN OR BX	G.26
9994180000	LM 5.08/09/90 3.5SN OR BX	G.26
9994190000	LM 5.08/10/90 3.5SN OR BX	G.26
9994200000	LM 5.08/11/90 3.5SN OR BX	G.26
9994210000	LM 5.08/12/90 3.5SN OR BX	G.26
9994560000	LM 5.08/04/135 3.5SN OR BX	G.27
9994560000	LM 5.08/05/135 3.5SN OR BX	G.27
9994570000	LM 5.08/06/135 3.5SN OR BX	G.27
9994580000	LM 5.08/07/135 3.5SN OR BX	G.27
9994590000	LM 5.08/08/135 3.5SN OR BX	G.27
9994600000	LM 5.08/09/135 3.5SN OR BX	G.27
9994610000	LM 5.08/10/135 3.5SN OR BX	G.27
9994620000	LM 5.08/11/135 3.5SN OR BX	G.27
9994630000	LM 5.08/12/135 3.5SN OR BX	G.27
9994970000	LM 5.08/04/180 3.5SN OR BX	G.27
9994980000	LM 5.08/05/180 3.5SN OR BX	G.27
9994990000	LM 5.08/06/180 3.5SN OR BX	G.27
9995000000	LM 5.08/07/180 3.5SN OR BX	G.27
9995010000	LM 5.08/08/180 3.5SN OR BX	G.27
9995020000	LM 5.08/09/180 3.5SN OR BX	G.27
9995030000	LM 5.08/10/180 3.5SN OR BX	G.27
9995040000	LM 5.08/11/180 3.5SN OR BX	G.27
9995050000	LM 5.08/12/180 3.5SN OR BX	G.27

Addresses worldwide

Let's connect.

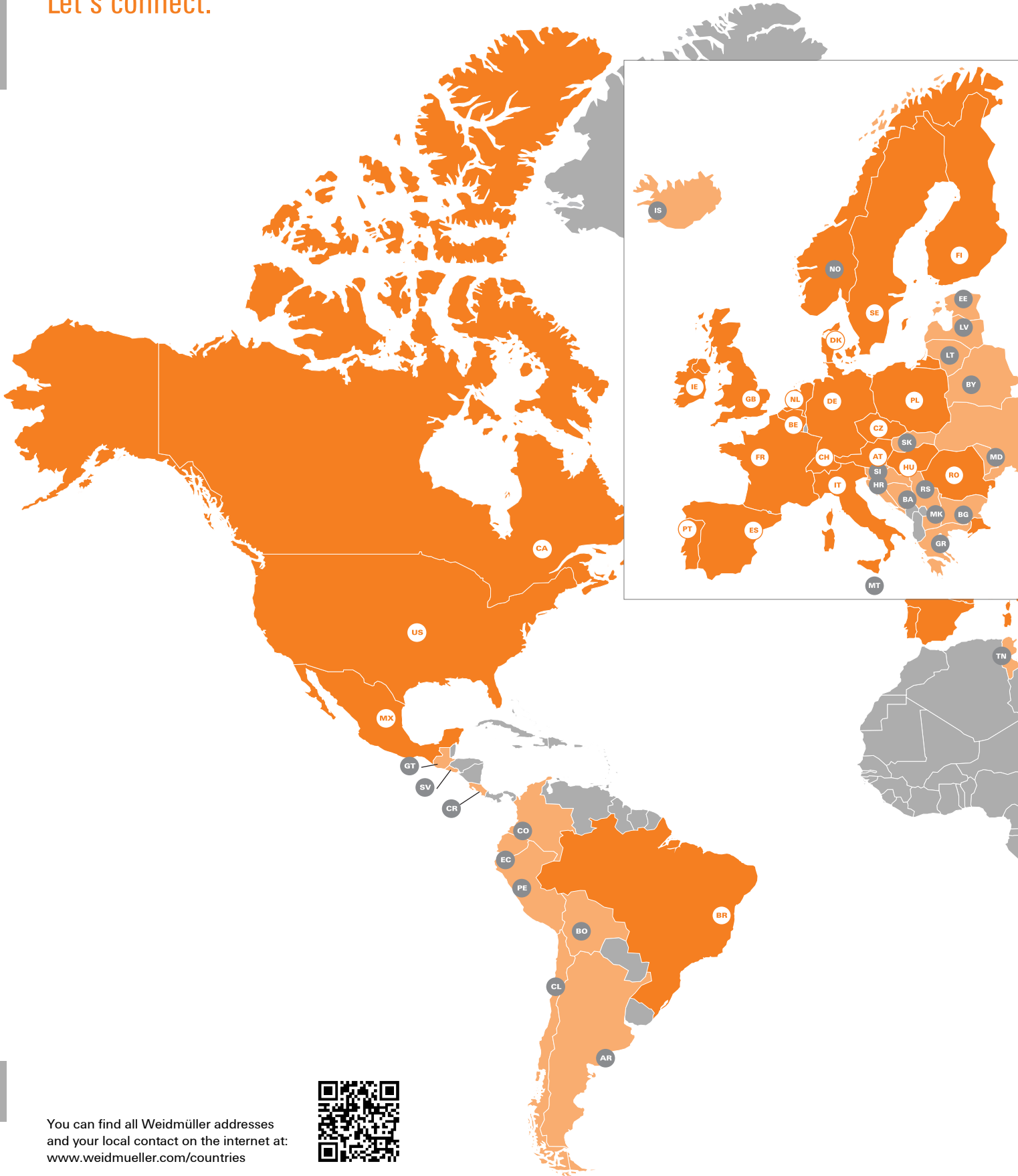

X

You can find all Weidmüller addresses and your local contact on the internet at: www.weidmueller.com/countries



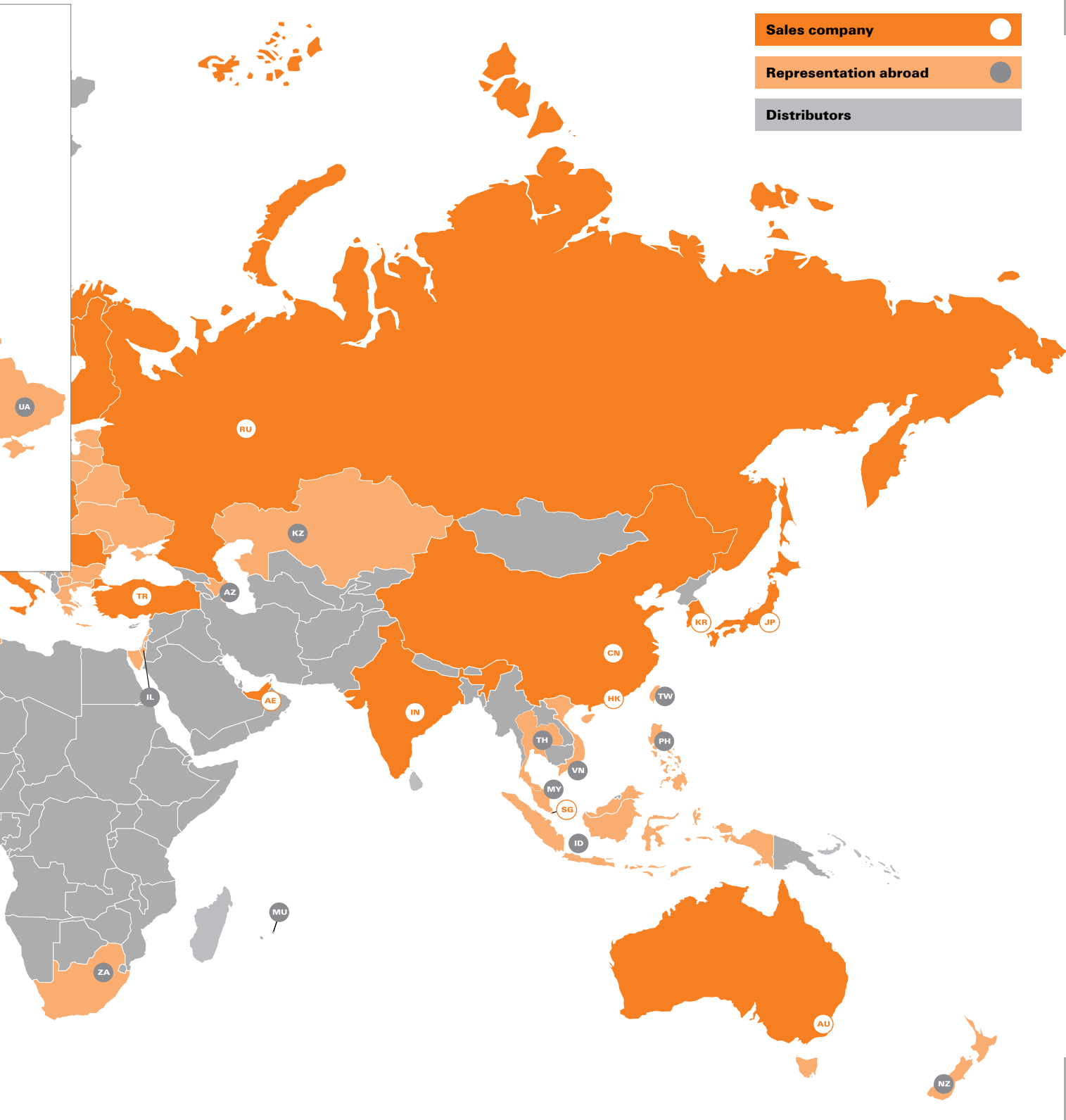

We cannot guarantee that there are no mistakes in the publications or software provided by us to the customer for the purpose of making orders. We try our best to quickly correct errors in our printed media.

X

All orders are based on our general terms of delivery, which can be reviewed on the websites of our group companies where you place your order. On demand we can also send the general terms of delivery to you.

Weidmüller – Your partner in Industrial Connectivity

As experienced experts we support our customers and partners around the world with products, solutions and services in the industrial environment of power, signal and data. We are at home in their industries and markets and know the technological challenges of tomorrow. We are therefore continuously developing innovative, sustainable and useful solutions for their individual needs. Together we set standards in Industrial Connectivity.

Weidmüller Interface GmbH & Co. KG
Klingenbergstraße 26
32758 Detmold, Germany
T +49 5231 14-0
F +49 5231 14-292083
www.weidmueller.com

Personal support can
be found on our website:
www.weidmueller.com/contact

Made in Germany



Order number: 2833820000/04/2022/SMD