

Lightning and surge protection

Version 2024



Weidmüller 

TN-C systems

Neutral conductor and protective earth conductor functions are combined throughout the network in a single conductor, the PEN conductor (4-conductor-system).

Position	LPL	Type	Order No.	Page
1	I/II	VPU AC I 3 275/25 LCF S	2726740000	A.17
	III/IV	VPU AC I 3 300/12.5 LCF	2636970000	A.25
2		VPU AC II 3 300/50	2591160000	A.58
3		VPU AC II+III 3 275/20 S	2907870000	A.99

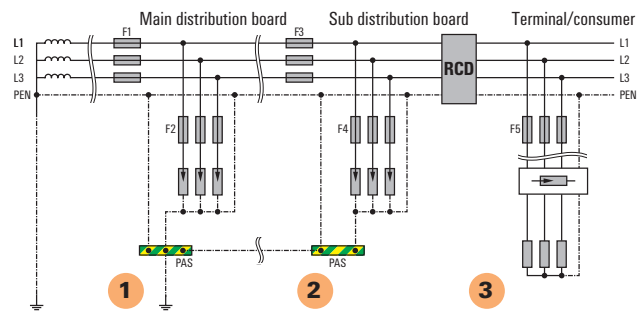

TN-C-S systems

Neutral conductor, PEN conductor and equipotential bonding system are connected once at the main distribution board or after the incoming supply to the building. Therefore, a TN-C system becomes a TN-S system (TN-C-S system) from this point onwards.

Position	LPL	Type	Order No.	Page
1	I/II	VPU AC I 3 275/25 LCF S	2726740000	A.17
	III/IV	VPU AC I 3 300/12.5 LCF	2636970000	A.25
2		VPU AC II 4 300/50	2591140000	A.59
		VPU AC II 3+1 300/50	2591080000	A.59
3		VPU III R 230 V/6 KV AC	1351650000	A.110

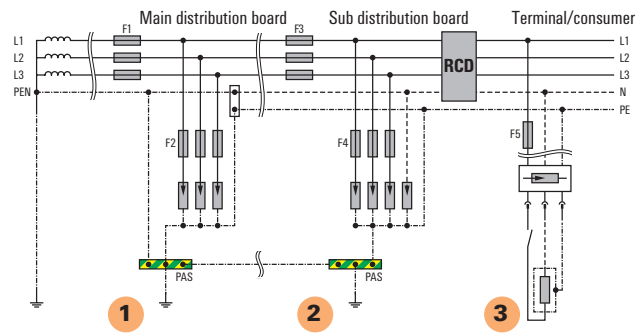

TN-S systems

Neutral conductor and protective earth conductor are separated throughout the network.

Position	LPL	Type	Order No.	Page
1	I/II	VPU AC I 3+1 275/25 LCF S 2PE	2726760000	A.18
	III/IV	VPU AC I 3+1 300/12.5 LCF	2636910000	A.25
2		VPU AC II 3+1 300/50	2591080000	A.59
		VPU AC II 3+1 300/50	2591080000	A.59
3		VPU AC II 4 300/50	2591140000	A.59

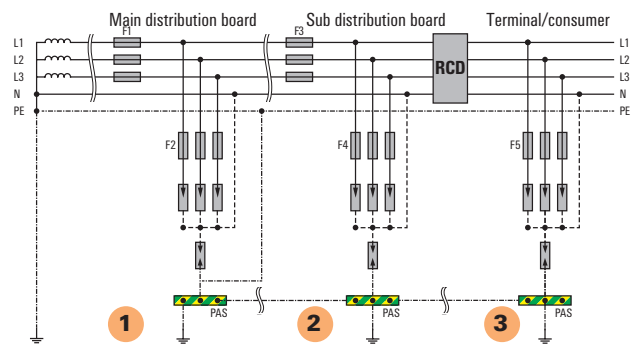

TT systems

One point is earthed directly (operational earth). The exposed conductive parts of the electrical installation are connected to earth lines separate from the operational earth.

Position	LPL	Type	Order No.	Page
1	I/II	VPU AC I 3+1 275/25 LCF S 2PE	2726760000	A.18
	III/IV	VPU AC I 3+1 300/12.5 LCF	2636910000	A.25
2		VPU AC II 3+1 300/50	2591080000	A.59
		VPU AC II 3+1 300/50	2591080000	A.59

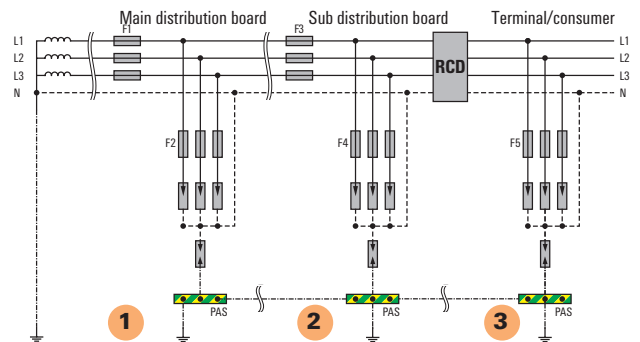

IT systems

There is no direct connection between active conductors and earthed parts. The exposed conductive parts of the electrical installation are earthed. The system is equipped with an insulation measuring device. Only for IT network systems in which the ground on the distribution transformer is connected to the ground on the customer side. (RE=RA in Figure 44 A1 of IEC 60634-4-44:2018)

Position	LPL	Type	Order No.	Page
1	I/II	VPU AC I 3 440/25 LCF	2619160000	A.40
	III/IV	VPU AC I 3 480/10	2591530000	A.30
2		VPU AC II 3 480/50	2591250000	A.67
		VPU AC II+III 3 440/20 S	2908460000	A.102

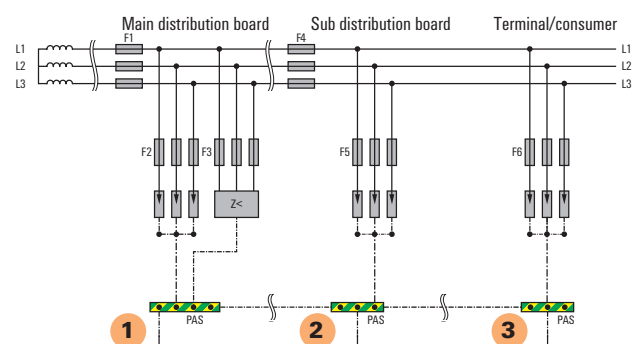

Begriffe

SPD = Surge Protection Device

Classification of surge arresters

1. Power lines

- Type 1, Type 1, Class I (lightning arrester)
- Type 2, Type 2, Class II (surge protection)
- Type 3, Type 3, Class III (surge protection for end devices)

2. Measurement/control cables and data cables

- Class D1 (lightning arrester)
- Class C2 (surge protection)
- Class C1 (surge protection for end devices)

Surge voltage category (EN 60664-1)

Rated impulse voltage

- IV = 6 kV (before the meter)
- III = 4 kV (after the meter, HV + UV, fixed installation)
- II = 2.5 kV (outlet/end device)
- I = 1.5 kV (in end device)

LPZ = Lightning Protection Zone

- External lightning protection LPZ 0 / 0A / 0B
- Internal lightning protection LPZ 1, 2, 3

LPL = Lightning Protection Level

- I = 200 kA
- II = 150 kA
- III + IV = 100 kA

LPS = Lightning Protection System

Lightning protection system

SPM = Surge Protection Measures

International standards

- Application standard: IEC 62305 – Application of lightning and surge protection with 4 chapters: General overview, Risk analysis, Internal and external lightning protection
- IEC 61643-12 – Usage for energy protection
- IEC 61643-22 – Usage for measurement and control signals
- IEC 61643-32 – Photovoltaic application

Testing pulse for surge arrester

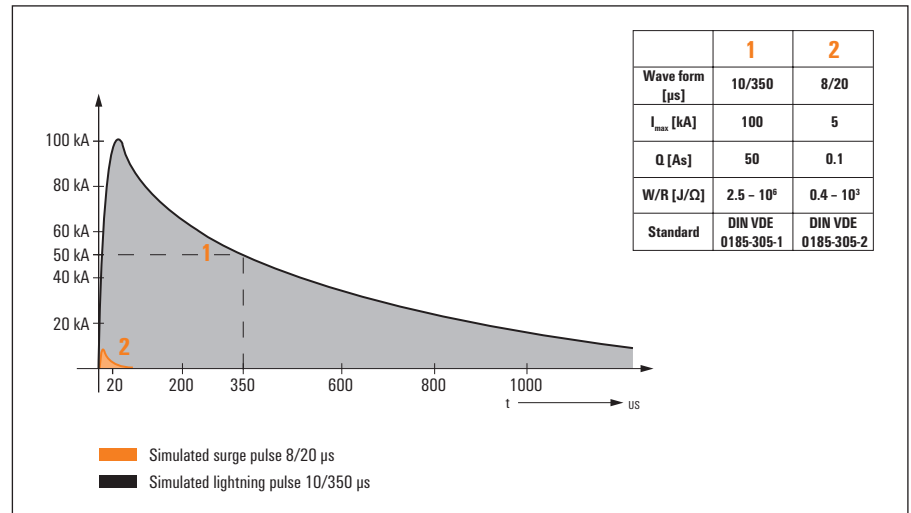

EMC lightning protection - zone concept in accordance with IEC 62305-4

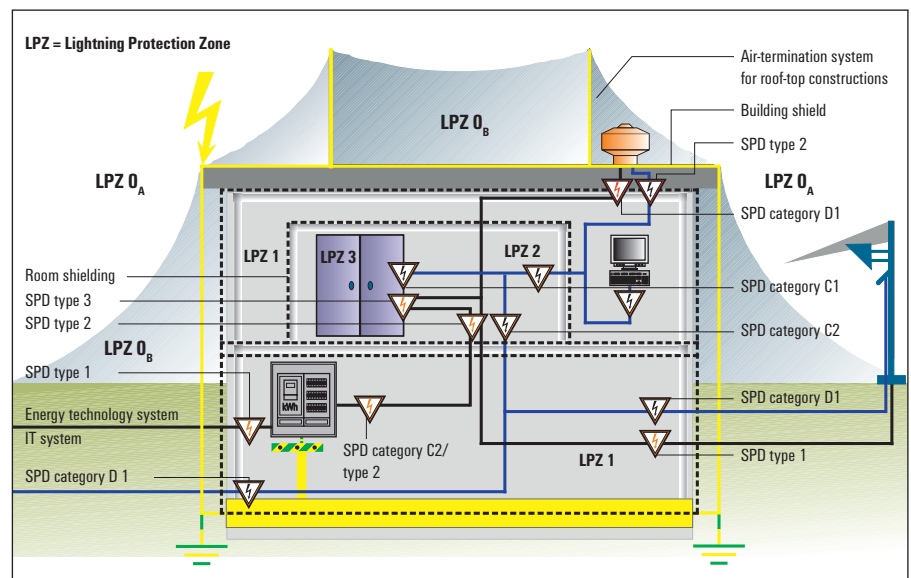

- LPZ 0_A** Direct impact is possible and full electromagnetic field
- LPZ 0_B** No direct impact is possible but full electromagnetic field
- LPZ 1** Pulse currents are further limited by current distribution; the lightning field is attenuated by room shielding
- LPZ 2...n** Pulse currents further limited; reduction of the field by room shielding

Lightning and surge protection

Catalogue 4.4

Lightning and surge protection



Lightning and surge protection for low voltage supply (AC)



Lightning and surge protection for photovoltaic (PV)



Lightning and surge protection for instrumentation and control (I & C)



Lightning and surge protection for data interfaces



Mains filter



Accessories

Appendix

Service and support



The basics of lightning and surge protection

Index

Search according to type or order number

Lightning and surge protection for low voltage supply (AC)

VPU AC S-Line
Page A.14



Compact lightning and surge protection type I/II for LPL I,II,III,IV for installation upstream/downstream of the electrical meter

VPU AC I F series
Page A.20



Type I/II lightning and surge protection for LPL I,II,III,IV for installation downstream with integrated fuse

VPU AC I 12,5 kA series
Page A.24



Type I/II lightning and surge protection for LPL III, IV for installation before/downstream of the electrical meter

VPU AC I 25 kA Monobloc
Page A.34



Type I/II lightning and surge protection for the LPL I, II, III, IV for installation before upstream/downstream of the electrical meter

VPU AC I 12,5 kA Monoblock
Page A.42



Lightning and surge protection type I/II, not pluggable, for LPL III,IV for installation in the 230/400 V upstream/downstream of the electrical meter

VPU ZPA S series
Page A.44



Lightning and surge protection type I/II for 40 mm busbar

VPU AC II series
Page A.50



Surge protection Type II for installation in main and sub-distribution boards with different nominal voltages, suitable for IEC/EN and UL networks

VPU AC II F series
Page A.72



Type II surge protection for installation in the main and sub-distribution with integrated fuse

VPU AC II US-series
Page A.78



Type II surge protection for installation in application according to NFPA 79

Lightning and surge protection for low voltage supply (AC)

VPU AC II+III series
Page A.96



Surge protection type II/III for installation in 230/400V main- and sub-distribution

VPU III series
Page A.104



Type III surge protection for installation before the end device to be protected

VPU IOT AC II
Page A.112



The VPU IoT AC is a Type II surge protector and additionally monitors important functions such as ageing

Lightning and surge protection for photovoltaic (PV)

VPU PV I+II and II series
Page B.4



Type I and type II/III lightning and surge protection for installation in DC photovoltaic applications

VPCB Base Photovoltaic
Page B.13



Solderable base for VPU PV I+II and II series

PV Protect
Page B.18



Lightning and surge protection type I/II for installation in photovoltaic applications in the DC area.

Lightning and surge protection for instrumentation and control (I & C)

VARITECTOR SPC

Page C.8



Pluggable surge protection for C&I circuits (IEC 61643-21)

VARITECTOR SSC 6AN

Page C.58



2-stage surge protection with 6 screw connection for C&I circuits (IEC 61643-21)

VARITECTOR SSC 4AN

Page C.88



Pluggable lightning and surge protection with four screw connections for measurement and control technology according to IEC 61643-21

MCZ-OVP series

Page C.102

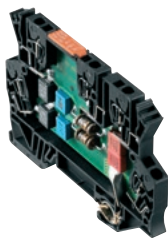

3-stage lightning and surge protection for measurement and control systems, with tension-clamp connection

VARITECTOR SPC EX

Page C.126



Plug-in lightning and surge protection for intrinsically safe circuits in gas and dust atmospheres up to Zone 0

VARITECTOR SSC EX

Page C.146



2-stage lightning and surge protection with screw connections: for intrinsically safe circuits in gas and dust atmospheres up to Zone 0

VARITECTOR Cable Gland (VCG)

Page C.162



VARITECTOR Cable Gland (VCG) protect intrinsically safe circuits in IP67 applications

Lightning and surge protection for data interfaces

VARITECTOR SPC

Page D.4



Plug-in lightning and surge protection certified according to IEC 61643-21: for data ports (e.g. RS485) or high frequency (HF) signals

V DATA

Page D.12



Surge protection for 8 wires with RJ45 socket

VARITECTOR SSC 6AN

Page D.14

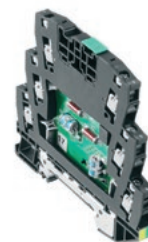

2-stage lightning and surge protector with six screw connections: for data ports (e.g. RS485 and RS232)

Mains filter

Wavefilter

Page E.2



Mains filter, 3 A/6 A/10 A, with screw connection for 230 V devices or voltage supplies

Accessories

V-TEST II

Page F.4



Test device for the VPU AC I and II series

Lightning and surge protection for low voltage supply (AC)

Lightning and surge protection for low voltage supply (AC)	Lightning and surge protection for energy systems	A.2
	Quick selection guide	A.4
	Lightning and surge protection Type I and II - VPU AC I series	A.10
	Lightning and surge protection Type I and II - VPU AC I LCF MB series	A.34
	Lightning and surge protection Type I and II - VPU ZPA S series	A.44
	Surge protection Type II - VPU AC II series	A.50
	Surge protection Type II - VPU AC II F series	A.72
	Surge protection Type II - VPU AC II US series	A.78
	Surge protection Type II+III - VPU AC II+III series	A.96
	Surge protection for end devices Type III - VPU III series	A.104
	Surge protection Type II - VPU IoT AC series	A.112



Lightning and surge protection for energy systems

Overview VPU AC series

Weidmüller VPU I, VPU II and VPU III surge protection products effectively reduce the interference coupling that can occur from transient surge voltages, even significantly below the limits prescribed by insulation co-ordination according to EN 60664-3 / DIN VDE 0110-3. This means that the entire system is exposed to less malfunction.

The co-ordination of the arresters is achieved by technical means. This means that decoupling between types I, II and III is not necessary. The arresters are tested according to product standard IEC 61643-11:2012 / DIN EN 61643-11:2012 and can be installed in systems according to IEC 61643-12 / VDE V0675-6-12 and IEC 62305-4 / VDE 0185-4. This lightning and surge protection device is suited for installation in power supply systems. Weidmüller offers different products for different mains types and voltage levels.

Your special advantages:

- Tested according to valid IEC/EN 61643-11
- VDE certification
- UL 1449 certified

TYPE I

Lightning and surge protection

- Combined type I+II SPDs
- Installation in LPL I, II or III/IV
- Versions with integrated fuse
- LCF versions for installation in the pre-metering area
- Installation on DIN rail TS 35 or 40 mm busbar
- Formerly named: class B / B arrester / coarse protection



TYPE II

Surge protection

- Combined type II+III SPDs
- Variants with pre-warning indication
- Special cULus series for NFPA 79 applications
- Variants with integrated fuse
- Formerly named: class C / C arrester / medium protection



TYPE III

Surge protection

- Installation on DIN rail TS 35
- Installation behind the power socket
- Formerly named: class D / D arrester / end protection





The VARITECTOR PU AC series offers sophisticated advantages that make operation safer and easier:



5 year warranty

for all VARITECTOR PU and VSPC products!
The identification can be found in the product catalogue.



Integrated fuse

The integrated fuse allows a faster and more efficient installation. No additional circuit breaker or fuse holder for auxiliary applications is required.



Safe operation up to 4,000 m

Systems in high-elevation regions are reliably protected. An additional risk analysis of deratings is not required for extraordinary locations.

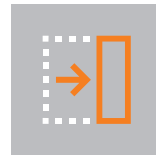

Space saving

The reduction in installed width for the VPU AC I S-line from 2 subunits to 1 subunit per pole with 25 kA discharge current means they require 50 % less space.



Plug-in inserts

Plug-in modules simplify arrester replacements. The optimised mounting rail clip enables easy and quick assembly and removal, without tools.



HAD technology

The innovative HAD technology is extremely compact, and uses a voltage switching technology with a very low residual voltage.



Worldwide usage

Certifications according to international IEC/EN standards, as well as the latest UL 1449 standard, guarantee they can be used for every application in conformity with applicable regulations.



Full status control

Variants with a pre-warning display enable uninterrupted protection, since the remote signalling contact indicates the pre-warning status to external monitoring systems.

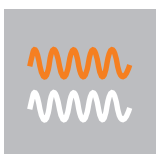

Vibration-resistant

Thanks to the use of a locking clip, the VARITECTOR PU series fulfils high vibration requirements. A tool is required to disconnect the base and the arrester.



Busbars

Quick installation without tools on 40 mm busbars in the pre-counter area according to application rule VDE-AR-N 4100.

Product quick selection, power supply

Type I

Product	Version	Rated voltage U _c (AC)	Lightning test current I _{imp} (10/350 μs)	Discharge current I _n (8/20 μs)	Discharge current I _{max} (8/20 μs)	Protection level U _p	Max. backup fuse	Signalling contact	Overall width	Order No.
Type I - leakage current free 25 kA / 275 V										
VPU AC I 1 275/25 LCF S	1-pole, pluggable	275 V	25 kA	25 kA	65 kA	1.5 kV	315 A		1 TE	2726620000
VPU AC I 1 R 275/25 LCF S	1-pole, pluggable	275 V	25 kA	25 kA	65 kA	1.5 kV	315 A	1 CO	1 TE	2726660000
VPU AC I 1+1 275/25 LCF S	2-pole, pluggable	275 V	25 kA	25 kA	65 kA	1.5 kV	315 A		2 TE	2726680000
VPU AC I 1+1 R 275/25 LCF S	2-pole, pluggable	275 V	25 kA	25 kA	65 kA	1.5 kV	315 A	1 CO	2 TE	2726700000
VPU AC I 2 275/25 LCF S	2-pole, pluggable	275 V	25 kA	25 kA	65 kA	1.5 kV	315 A		2 TE	2726720000
VPU AC I 2 R 275/25 LCF S	2-pole, pluggable	275 V	25 kA	25 kA	65 kA	1.5 kV	315 A	1 CO	2 TE	2726730000
VPU AC I 3 275/25 LCF S	3-pole, pluggable	275 V	25 kA	25 kA	65 kA	1.5 kV	315 A		3 TE	2726740000
VPU AC I 3 R 275/25 LCF S	3-pole, pluggable	275 V	25 kA	25 kA	65 kA	1.5 kV	315 A	1 CO	3 TE	2726750000
VPU AC I 3+1 275/25 LCF S 2PE	4-pole, pluggable	275 V	25 kA	25 kA	65 kA	1.7 kV	315 A		4 TE	2726760000
VPU AC I 3+1 R 275/25 LCF S 2PE	4-pole, pluggable	275 V	25 kA	25 kA	65 kA	1.7 kV	315 A	1 CO	4 TE	2726770000
VPU AC I 3+1 275/25 LCF S 2N	4-pole, pluggable	275 V	25 kA	25 kA	65 kA	1.5 kV	315 A		4 TE	2730280000
VPU AC I 3+1 R 275/25 LCF S 2N	4-pole, pluggable	275 V	25 kA	25 kA	65 kA	1.5 kV	315 A	1 CO	4 TE	2730290000
VPU AC I 4 275/25 LCF S	4-pole, pluggable	275 V	25 kA	25 kA	65 kA	1.5 kV	315 A		4 TE	2726780000
VPU AC I 4 R 275/25 LCF S	4-pole, pluggable	275 V	25 kA	25 kA	65 kA	1.5 kV	315 A	1 CO	4 TE	2726790000
Type I - Integrated fuse 25 kA / 275 V										
VPU AC I F 1 275/25	1-pole, pluggable	275 V	25 kA	25 kA	65 kA	1.5 kV	built-in		2 TE	2859330000
VPU AC I F 1 R 275/25	1-pole, pluggable	275 V	25 kA	25 kA	65 kA	1.5 kV	built-in	1 CO	2 TE	2859340000
VPU AC I F 3 275/25	3-pole, pluggable	275 V	25 kA	25 kA	65 kA	1.5 kV	built-in		6 TE	3022890000
VPU AC I F 3 R 275/25	3-pole, pluggable	275 V	25 kA	25 kA	65 kA	1.5 kV	built-in	1 CO	6 TE	3022900000
VPU AC I F 3+1 275/25	4-pole, pluggable	275 V	25 kA	25 kA	65 kA	1.5 kV	built-in		8 TE	3022910000
VPU AC I F 3+1 R 275/25	4-pole, pluggable	275 V	25 kA	25 kA	65 kA	1.5 kV	built-in	1 CO	8 TE	3022920000
Type I - leakage current free 12.5 kA / 300 V										
VPU AC I 1 300/12.5 LCF	1-pole, pluggable	300 V	12.5 kA	20 kA	65 kA	1.5 kV	315 A		1 TE	2636950000
VPU AC I 1 R 300/12.5 LCF	1-pole, pluggable	300 V	12.5 kA	20 kA	65 kA	1.5 kV	315 A	1 CO	1 TE	2636960000
VPU AC I 1+1 300/12.5 LCF	2-pole, pluggable	300 V	12.5 kA	20 kA	65 kA	1.5 kV	315 A		2 TE	2636930000
VPU AC I 1+1 R 300/12.5 LCF	2-pole, pluggable	300 V	12.5 kA	20 kA	65 kA	1.5 kV	315 A	1 CO	2 TE	2636940000
VPU AC I 3 300/12.5 LCF	3-pole, pluggable	300 V	12.5 kA	20 kA	65 kA	1.5 kV	315 A		3 TE	2636970000
VPU AC I 3 R 300/12.5 LCF	3-pole, pluggable	300 V	12.5 kA	20 kA	65 kA	1.5 kV	315 A	1 CO	3 TE	2636980000
VPU AC I 3+1 300/12.5 LCF	4-pole, pluggable	300 V	12.5 kA	20 kA	65 kA	1.5 kV	315 A		4 TE	2636910000
VPU AC I 3+1 R 300/12.5 LCF	4-pole, pluggable	300 V	12.5 kA	20 kA	65 kA	1.5 kV	315 A	1 CO	4 TE	2636920000
Type I - 12.5 kA / 300 V										
VPU AC I 1 300/12.5 LH	1-pole, pluggable	300 V	12.5 kA	20 kA	50 kA	1.5 kV	250 A		1 TE	2983420000
VPU AC I 1 R 300/12.5 LH	1-pole, pluggable	300 V	12.5 kA	20 kA	50 kA	1.5 kV	250 A	1 CO	1 TE	2983510000
VPU AC I 1+1 300/12.5 LH	2-pole, pluggable	300 V	12.5 kA	20 kA	50 kA	1.5 kV	250 A		2 TE	2983520000
VPU AC I 1+1 R 300/12.5 LH	2-pole, pluggable	300 V	12.5 kA	20 kA	50 kA	1.5 kV	250 A	1 CO	2 TE	2983530000
VPU AC I 2 300/12.5 LH	2-pole, pluggable	300 V	12.5 kA	20 kA	50 kA	1.5 kV	250 A		2 TE	2983540000
VPU AC I 2 R 300/12.5 LH	2-pole, pluggable	300 V	12.5 kA	20 kA	50 kA	1.5 kV	250 A	1 CO	2 TE	2983550000
VPU AC I 3 300/12.5 LH	3-pole, pluggable	300 V	12.5 kA	20 kA	50 kA	1.5 kV	250 A		3 TE	2983570000
VPU AC I 3 R 300/12.5 LH	3-pole, pluggable	300 V	12.5 kA	20 kA	50 kA	1.5 kV	250 A	1 CO	3 TE	2983560000
VPU AC I 3+1 300/12.5 LH	4-pole, pluggable	300 V	12.5 kA	20 kA	50 kA	1.5 kV	250 A		4 TE	2983580000
VPU AC I 3+1 R 300/12.5 LH	4-pole, pluggable	300 V	12.5 kA	20 kA	50 kA	1.5 kV	250 A	1 CO	4 TE	2983590000
VPU AC I 4 300/12.5 LH	4-pole, pluggable	300 V	12.5 kA	20 kA	50 kA	1.5 kV	250 A		4 TE	2983600000
VPU AC I 4 R 300/12.5 LH	4-pole, pluggable	300 V	12.5 kA	20 kA	50 kA	1.5 kV	250 A	1 CO	4 TE	2983610000
Type I - 12.5 kA / 950 V										
VPU AC I 3+MOV R 950/12.5	4-pole, pluggable	950 V	12.5 kA	20 kA	50 kA	4 kV	160 A	1 CO	4 TE	2845570000
Type I - 10 kA / 480 V										
VPU AC I 1 480/10	1-pole, pluggable	480 V	10 kA	20 kA	50 kA	2.1 kV	315 A		1 TE	2591510000
VPU AC I 1 R 480/10	1-pole, pluggable	480 V	10 kA	20 kA	50 kA	2.1 kV	315 A	1 CO	1 TE	2591520000
VPU AC I 3 480/10	3-pole, pluggable	480 V	10 kA	20 kA	50 kA	2.1 kV	315 A		3 TE	2591530000
VPU AC I 3 R 480/10	3-pole, pluggable	480 V	10 kA	20 kA	50 kA	2.1 kV	315 A	1 CO	3 TE	2591540000
VPU AC I 4 480/10	4-pole, pluggable	480 V	10 kA	20 kA	50 kA	2.1 kV	315 A		4 TE	2591550000
VPU AC I 4 R 480/10	4-pole, pluggable	480 V	10 kA	20 kA	50 kA	2.1 kV	315 A	1 CO	4 TE	2591560000



Type I

Product	Version	Rated voltage Uc (AC)	Lightning test current I _{imp} (10/350 μs)	Discharge current I _n (8/20 μs)	Discharge current I _{max} (8/20 μs)	Protection level U _p	Max. backup fuse	Signalling contact	Overall width	Order No.
Type I - N-PE										
VPU AC I 1 N-PE 305/100 S	1-pole, pluggable	305 V	100 kA	25 kA	150 kA	1.5 kV	-		1 TE	2726800000
VPU AC I 1 N-PE 305/50	1-pole, pluggable	305 V	50 kA	50 kA	100 kA	1.5 kV	-		1 TE	2591570000
VPU AC I 1 N-PE 305/50 LH	1-pole, pluggable	305 V	50 kA	50 kA	100 kA	1.5 kV	-		1 TE	3037010000
Type I - leakage current free 25 kA / 275 V										
VPU AC I 1 R 275/25 LCF MB	1-pole, non-pluggable	275 V	25 kA	25 kA	100 kA	1.5 kV	250 A	1 CO	2 TE	2774940000
VPU AC I 1+1 R 275/25 LCF MB	2-pole, non-pluggable	275 V	25 kA	25 kA	100 kA	1.5 kV	250 A	1 CO	4 TE	2775000000
VPU AC I 2 R 275/25 LCF MB	2-pole, non-pluggable	275 V	25 kA	25 kA	100 kA	1.5 kV	250 A	1 CO	4 TE	2774950000
VPU AC I 3 R 275/25 LCF MB	3-pole, non-pluggable	275 V	25 kA	25 kA	100 kA	1.5 kV	250 A	1 CO	6 TE	2774960000
VPU AC I 3+1 R 275/25 LCF MB	4-pole, non-pluggable	275 V	25 kA	25 kA	100 kA	1.5 kV	250 A	1 CO	8 TE	2638070000
VPU AC I 4 R 275/25 LCF MB	4-pole, non-pluggable	275 V	25 kA	25 kA	100 kA	1.5 kV	250 A	1 CO	8 TE	2774990000
Type I - leakage current free 25 kA / 440 V										
VPU AC I 1 440/25 LCF	1-pole, non-pluggable	440 V	25 kA	25 kA	100 kA	2.5 kV	250 A		2TE	2619100000
VPU AC I 1 R 440/25 LCF	1-pole, non-pluggable	440 V	25 kA	25 kA	100 kA	2.5 kV	250 A	1 CO	2TE	2619120000
VPU AC I 1+1 440/25 LCF	2-pole, non-pluggable	440 V	25 kA	25 kA	100 kA	2.5 kV	250 A		4TE	2619210000
VPU AC I 1+1 R 440/25 LCF	2-pole, non-pluggable	440 V	25 kA	25 kA	100 kA	2.5 kV	250 A	1 CO	4TE	2619220000
VPU AC I 2 440/25 LCF	2-pole, non-pluggable	440 V	25 kA	25 kA	100 kA	2.5 kV	250 A		4TE	2619130000
VPU AC I 2 R 440/25 LCF	2-pole, non-pluggable	440 V	25 kA	25 kA	100 kA	2.5 kV	250 A	1 CO	4TE	2619140000
VPU AC I 3 440/25 LCF	3-pole, non-pluggable	440 V	25 kA	25 kA	100 kA	2.5 kV	250 A		6TE	2619160000
VPU AC I 3 R 440/25 LCF	3-pole, non-pluggable	440 V	25 kA	25 kA	100 kA	2.5 kV	250 A	1 CO	6TE	2619170000
VPU AC I 3+1 440/25 LCF	4-pole, non-pluggable	440 V	25 kA	25 kA	100 kA	2.5 kV	250 A		8TE	2619240000
VPU AC I 3+1 R 440/25 LCF	4-pole, non-pluggable	440 V	25 kA	25 kA	100 kA	2.5 kV	250 A	1 CO	8TE	2619260000
VPU AC I 4 440/25 LCF	4-pole, non-pluggable	440 V	25 kA	25 kA	100 kA	2.5 kV	250 A		8TE	2619190000
VPU AC I 4 R 440/25 LCF	4-pole, non-pluggable	440 V	25 kA	25 kA	100 kA	2.5 kV	250 A	1 CO	8TE	2619200000
Type I - leakage current free 12.5 kA / 255 V										
VPU AC I 1+1 255/12.5 LCF MB	2-pole, non-pluggable	255 V	12.5 kA	20 kA	50 kA	1.5 kV	250 A		2 TE	2976580000
VPU AC I 1+1 R 255/12.5 LCF MB	2-pole, non-pluggable	255 V	12.5 kA	20 kA	50 kA	1.5 kV	250 A	1 CO	2 TE	2976590000
VPU AC I 3 255/12.5 LCF MB	3-pole, non-pluggable	255 V	12.5 kA	20 kA	50 kA	1.5 kV	250 A		4 TE	2976600000
VPU AC I 3 R 255/12.5 LCF MB	3-pole, non-pluggable	255 V	12.5 kA	20 kA	50 kA	1.5 kV	250 A	1 CO	4 TE	2976610000
VPU AC I 3+1 255/12.5 LCF MB	4-pole, non-pluggable	255 V	12.5 kA	20 kA	50 kA	1.5 kV	250 A		4 TE	2976620000
VPU AC I 3+1 R 255/12.5 LCF MB	4-pole, non-pluggable	255 V	12.5 kA	20 kA	50 kA	1.5 kV	250 A	1 CO	4 TE	2976630000
VPU AC I 4 255/12.5 LCF MB	4-pole, non-pluggable	255 V	12.5 kA	20 kA	50 kA	1.5 kV	250 A		4 TE	2976640000
VPU AC I 4 R 255/12.5 LCF MB	4-pole, non-pluggable	255 V	12.5 kA	20 kA	50 kA	1.5 kV	250 A	1 CO	4 TE	2976650000
Type I - for busbars										
VPU ZPA S I 3 300/12,5	40 mm busbars	300 V	12.5 kA	20 kA	40 kA	1.5 kV	160 A		36 mm	2830870000
VPU ZPA S I 3 R 300/12,5	40 mm busbars	300 V	12.5 kA	20 kA	40 kA	1.5 kV	160 A	1 CO	36 mm	2830880000
VPU ZPA S I 3 RA 300/12,5	40 mm busbars	300 V	12.5 kA	20 kA	40 kA	1.5 kV	160 A	1 CO + Voltage tap	36 mm	2830890000
VPU ZPA S I 3+1 300/12,5	40 mm busbars	300 V	12.5 kA	20 kA	40 kA	1.5 kV	160 A		36 mm	2830900000
VPU ZPA S I 3+1 R 300/12,5	40 mm busbars	300 V	12.5 kA	20 kA	40 kA	1.5 kV	160 A	1 CO	36 mm	2830910000
VPU ZPA S I 3+1 RA 300/12,5	40 mm busbars	300 V	12.5 kA	20 kA	40 kA	1.5 kV	160 A	1 CO + Voltage tap	36 mm	2830920000
VPU ZPA S I 3 300/7,5	40 mm busbars	300 V	7.5 kA	20 kA	40 kA	1.5 kV	160 A		36 mm	2830930000
VPU ZPA S I 3 R 300/7,5	40 mm busbars	300 V	7.5 kA	20 kA	40 kA	1.5 kV	160 A	1 CO	36 mm	2830940000
VPU ZPA S I 3 RA 300/7,5	40 mm busbars	300 V	7.5 kA	20 kA	40 kA	1.5 kV	160 A	1 CO + Voltage tap	36 mm	2830950000
VPU ZPA S I 3+1 300/7,5	40 mm busbars	300 V	7.5 kA	20 kA	40 kA	1.5 kV	160 A		36 mm	2830960000
VPU ZPA S I 3+1 R 300/7,5	40 mm busbars	300 V	7.5 kA	20 kA	40 kA	1.5 kV	160 A	1 CO	36 mm	2830970000
VPU ZPA S I 3+1 RA 300/7,5	40 mm busbars	300 V	7.5 kA	20 kA	40 kA	1.5 kV	160 A	1 CO + Voltage tap	36 mm	2830980000
V-ZPA FUSE HOLDER E	40 mm busbar accessories								18,5 mm	3038720000
V-ZPA TERMINAL	40 mm busbar accessories								12,5 mm	2904470000

Product quick selection, power supply

Type II

Product	Version	Rated voltage U _c (AC)	Discharge current		Protection level U _p	Max. backup fuse	Signalling contact	Overall width	Order No.
			I _n (8/20μs)	I _{max} (8/20μs)					
Type II - 75 V / 50 kA									
VPU AC II 1 75/50	1-pole, pluggable	75 V	20 kA	50 kA	0.8 kV	315 A		1 TE	2636990000
VPU AC II 1 R 75/50	1-pole, pluggable	75 V	20 kA	50 kA	0.8 kV	315 A	1 CO	1 TE	2591620000
VPU AC II 2 75/50	2-pole, pluggable	75 V	20 kA	50 kA	0.8 kV	315 A		2 TE	2637000000
VPU AC II 2 R 75/50	2-pole, pluggable	75 V	20 kA	50 kA	0.8 kV	315 A	1 CO	2 TE	2591630000
Type II - 150 V / 50 kA									
VPU AC II 1 150/50	1-pole, pluggable	150 V	20 kA	50 kA	1.25 kV	315 A		1 TE	2591650000
VPU AC II 1 R 150/50	1-pole, pluggable	150 V	20 kA	50 kA	1.25 kV	315 A	1 CO	1 TE	2591660000
VPU AC II 2 150/50	2-pole, pluggable	150 V	20 kA	50 kA	1.25 kV	315 A		2 TE	2591670000
VPU AC II 2 R 150/50	2-pole, pluggable	150 V	20 kA	50 kA	1.25 kV	315 A	1 CO	2 TE	2591680000
VPU AC II 3 150/50	3-pole, pluggable	150 V	20 kA	50 kA	1.25 kV	315 A		3 TE	2591690000
VPU AC II 3 R 150/50	3-pole, pluggable	150 V	20 kA	50 kA	1.25 kV	315 A	1 CO	3 TE	2591700000
VPU AC II 4 150/50	4-pole, pluggable	150 V	20 kA	50 kA	1.25 kV	315 A		4 TE	2591710000
VPU AC II 4 R 150/50	4-pole, pluggable	150 V	20 kA	50 kA	1.25 kV	315 A	1 CO	4 TE	2591000000
Type II - 300 V / 50 kA									
VPU AC II 1 300/50	1-pole, pluggable	300 V	20 kA	50 kA	1.5 kV	315 A		1 TE	2591020000
VPU AC II 1 R 300/50	1-pole, pluggable	300 V	20 kA	50 kA	1.5 kV	315 A	1 CO	1 TE	2591030000
VPU AC II 1+1 300/50	2-pole, pluggable	300 V	20 kA	50 kA	1.5 kV	315 A		2 TE	2591060000
VPU AC II 1+1 R 300/50	2-pole, pluggable	300 V	20 kA	50 kA	1.5 kV	315 A	1 CO	2 TE	2591070000
VPU AC II 2 300/50	2-pole, pluggable	300 V	20 kA	50 kA	1.5 kV	315 A		2 TE	2591040000
VPU AC II 2 R 300/50	2-pole, pluggable	300 V	20 kA	50 kA	1.5 kV	315 A	1 CO	2 TE	2591050000
VPU AC II 3 300/50	3-pole, pluggable	300 V	20 kA	50 kA	1.5 kV	315 A		3 TE	2591160000
VPU AC II 3 R 300/50	3-pole, pluggable	300 V	20 kA	50 kA	1.5 kV	315 A	1 CO	3 TE	2591170000
VPU AC II 3+1 300/50	4-pole, pluggable	300 V	20 kA	50 kA	1.5 kV	315 A		4 TE	2591080000
VPU AC II 3+1 R 300/50	4-pole, pluggable	300 V	20 kA	50 kA	1.5 kV	315 A	1 CO	4 TE	2591090000
VPU AC II 4 300/50	4-pole, pluggable	300 V	20 kA	50 kA	1.5 kV	315 A		4 TE	2591140000
VPU AC II 4 R 300/50	4-pole, pluggable	300 V	20 kA	50 kA	1.5 kV	315 A	1 CO	4 TE	2591150000
Type II - 300 V / 50 kA (Status indicator red, yellow, green)									
VPU AC II 1 R 300/50 Y	1-pole, pluggable	300 V	20 kA	50 kA	1.4 kV	160 A	1 CO	1 TE	2639350000
VPU AC II 1+1 R 300/50 Y	2-pole, pluggable	300 V	20 kA	50 kA	1.4 kV	160 A	1 CO	2 TE	2639340000
VPU AC II 2 R 300/50 Y	2-pole, pluggable	300 V	20 kA	50 kA	1.4 kV	160 A	1 CO	2 TE	2639360000
VPU AC II 3 R 300/50 Y	3-pole, pluggable	300 V	20 kA	50 kA	1.4 kV	160 A	1 CO	3 TE	2639330000
VPU AC II 3+1 R 300/50 Y	4-pole, pluggable	300 V	20 kA	50 kA	1.4 kV	160 A	1 CO	4 TE	2639320000
VPU AC II 4 R 300/50 Y	4-pole, pluggable	300 V	20 kA	50 kA	1.4 kV	160 A	1 CO	4 TE	2639370000
Type II - 350 V / 50 kA									
VPU AC II 1 350/50	1-pole, pluggable	350 V	20 kA	50 kA	1.75 kV	315 A		1 TE	2591350000
VPU AC II 1 R 350/50	1-pole, pluggable	350 V	20 kA	50 kA	1.75 kV	315 A	1 CO	1 TE	2591360000
VPU AC II 1+1 350/50	2-pole, pluggable	350 V	20 kA	50 kA	1.75 kV	315 A		2 TE	2637030000
VPU AC II 1+1 R 350/50	2-pole, pluggable	350 V	20 kA	50 kA	1.75 kV	315 A	1 CO	2 TE	2637040000
VPU AC II 2 350/50	2-pole, pluggable	350 V	20 kA	50 kA	1.75 kV	315 A		2 TE	2637010000
VPU AC II 2 R 350/50	2-pole, pluggable	350 V	20 kA	50 kA	1.75 kV	315 A	1 CO	2 TE	2637020000
VPU AC II 3 350/50	3-pole, pluggable	350 V	20 kA	50 kA	1.75 kV	315 A		3 TE	2591100000
VPU AC II 3 R 350/50	3-pole, pluggable	350 V	20 kA	50 kA	1.75 kV	315 A	1 CO	3 TE	2591110000
VPU AC II 3+1 350/50	4-pole, pluggable	350 V	20 kA	50 kA	1.75 kV	315 A		4 TE	2637050000
VPU AC II 3+1 R 350/50	4-pole, pluggable	350 V	20 kA	50 kA	1.75 kV	315 A	1 CO	4 TE	2637060000
VPU AC II 4 350/50	4-pole, pluggable	350 V	20 kA	50 kA	1.75 kV	315 A		4 TE	2591120000
VPU AC II 4 R 350/50	4-pole, pluggable	350 V	20 kA	50 kA	1.75 kV	315 A	1 CO	4 TE	2591130000
Type II - 480 V / 50 kA									
VPU AC II 1 480/50	1-pole, pluggable	480 V	20 kA	50 kA	2.3 kV	315 A		1 TE	2591210000
VPU AC II 1 R 480/50	1-pole, pluggable	480 V	20 kA	50 kA	2.3 kV	315 A	1 CO	1 TE	2591220000
VPU AC II 2 480/50	2-pole, pluggable	480 V	20 kA	50 kA	2.3 kV	315 A		2 TE	2591230000
VPU AC II 2 R 480/50	2-pole, pluggable	480 V	20 kA	50 kA	2.3 kV	315 A	1 CO	2 TE	2591240000
VPU AC II 3 480/50	3-pole, pluggable	480 V	20 kA	50 kA	2.3 kV	315 A		3 TE	2591250000
VPU AC II 3 R 480/50	3-pole, pluggable	480 V	20 kA	50 kA	2.3 kV	315 A	1 CO	3 TE	2591260000
VPU AC II 4 480/50	4-pole, pluggable	480 V	20 kA	50 kA	2.3 kV	315 A		4 TE	2591270000
VPU AC II 4 R 480/50	4-pole, pluggable	480 V	20 kA	50 kA	2.3 kV	315 A	1 CO	4 TE	2591280000
Type II - 750 V / 35 kA									
VPU AC II 1 R 750/35	1-pole, pluggable	750 V	20 kA	35 kA	3.4 kV	315 A	1 CO	1 TE	2591300000
VPU AC II 2 R 750/35	2-pole, pluggable	750 V	20 kA	35 kA	3.4 kV	315 A	1 CO	2 TE	2591310000
VPU AC II 3 R 750/35	3-pole, pluggable	750 V	20 kA	35 kA	3.4 kV	315 A	1 CO	3 TE	2591320000



Type II

Product	Version	Rated voltage U _c (AC)	Discharge current		Protection level U _p	Max. backup fuse	Signalling contact	Overall width	Order No.
			I _n (8/20μs)	I _{max} (8/20μs)					
Type II - 1000 V / 40 kA									
VPU II 1 1000V/40kA AC	1-pole, pluggable	1000 V	20 kA	40 kA	3.8 kV	125 A		1 TE	1473440000
VPU II 1 R 1000V/40kA AC	1-pole, pluggable	1000 V	20 kA	40 kA	3.8 kV	125 A	1 CO	1 TE	2811930000
Type II - N-PE									
VPU AC II 1 N-PE 305/65	1-pole, pluggable	305 V	40 kA	65 kA	1.5 kV	-		1 TE	2591180000
VPU AC II US 1 N-PE 240/65	1-pole, pluggable	305 V	40 kA	65 kA	1.5 kA	-		1 TE	2730800000
Type II - Integrated fuse 300 V /40 kA									
VPU AC II F 1 300/40	1-pole, pluggable	300 V	20 kA	40 kA	1.5 kV	built-in		1 TE	2827580000
VPU AC II F 1 R 300/40	1-pole, pluggable	300 V	20 kA	40 kA	1.5 kV	built-in	1 CO	1 TE	2807390000
VPU AC II F 1+1 300/40	2-pole, pluggable	300 V	20 kA	40 kA	1.5 kV	built-in		2 TE	2827620000
VPU AC II F 1+1 R 300/40	2-pole, pluggable	300 V	20 kA	40 kA	1.5 kV	built-in	1 CO	2 TE	2807430000
VPU AC II F 2 300/40	2-pole, pluggable	300 V	20 kA	40 kA	1.5 kV	built-in		2 TE	2827590000
VPU AC II F 2 R 300/40	2-pole, pluggable	300 V	20 kA	40 kA	1.5 kV	built-in	1 CO	2 TE	2807400000
VPU AC II F 3 300/40	3-pole, pluggable	300 V	20 kA	40 kA	1.5 kV	built-in		3 TE	2827600000
VPU AC II F 3 R 300/40	3-pole, pluggable	300 V	20 kA	40 kA	1.5 kV	built-in	1 CO	3 TE	2807410000
VPU AC II F 3+1 300/40	4-pole, pluggable	300 V	20 kA	40 kA	1.5 kV	built-in		4 TE	2827630000
VPU AC II F 3+1 R 300/40	4-pole, pluggable	300 V	20 kA	40 kA	1.5 kV	built-in	1 CO	4 TE	2807440000
VPU AC II F 4 300/40	4-pole, pluggable	300 V	20 kA	40 kA	1.5 kV	built-in		4 TE	2827610000
VPU AC II F 4 R 300/40	4-pole, pluggable	300 V	20 kA	40 kA	1.5 kV	built-in	1 CO	4 TE	2807420000
Type II US - 60 V UL 1449 & NFPA 79									
VPU AC II US 1 60/50	1-pole, pluggable	75 V	20 kA	50 kA	0.8 kV	315 A		1 TE	2736210000
VPU AC II US 1 R 60/50	1-pole, pluggable	75 V	20 kA	50 kA	0.8 kV	315 A	1 CO	1 TE	2736270000
VPU AC II US 2 60/50	2-pole, pluggable	75 V	20 kA	50 kA	0.8 kV	315 A		2 TE	2736280000
VPU AC II US 2 R 60/50	2-pole, pluggable	75 V	20 kA	50 kA	0.8 kV	315 A	1 CO	2 TE	2730790000
Type II US-120 V UL 1449 & NFPA 79									
VPU AC II US 1 120/50	1-pole, pluggable	150 V	20 kA	50 kA	1.25 kV	315 A		1 TE	2730450000
VPU AC II US 1 R 120/50	1-pole, pluggable	150 V	20 kA	50 kA	1.25 kV	315 A	1 CO	1 TE	2730460000
VPU AC II US 2 120/50	2-pole, pluggable	150 V	20 kA	50 kA	1.25 kV	315 A		2 TE	2730470000
VPU AC II US 2 R 120/50	2-pole, pluggable	150 V	20 kA	50 kA	1.25 kV	315 A	1 CO	2 TE	2730480000
VPU AC II US 3 120/50	3-pole, pluggable	150 V	20 kA	50 kA	1.25 kV	315 A		3 TE	2730510000
VPU AC II US 3 R 120/50	3-pole, pluggable	150 V	20 kA	50 kA	1.25 kV	315 A	1 CO	3 TE	2730520000
VPU AC II US 4 120/50	4-pole, pluggable	150 V	20 kA	50 kA	1.25 kV	315 A		4 TE	2730490000
VPU AC II US 4 R 120/50	4-pole, pluggable	150 V	20 kA	50 kA	1.25 kV	315 A	1 CO	4 TE	2730500000
Type II US - 240 V UL 1449 & NFPA 79									
VPU AC II US 1 240/50	1-pole, pluggable	300 V	20 kA	50 kA	1.5 kV	315 A		1 TE	2736300000
VPU AC II US 1 R 240/50	1-pole, pluggable	300 V	20 kA	50 kA	1.5 kV	315 A	1 CO	1 TE	2736310000
VPU AC II US 1+1 240/50	2-pole, pluggable	300 V	20 kA	50 kA	1.5 kV	315 A		2 TE	2736340000
VPU AC II US 1+1 R 240/50	2-pole, pluggable	300 V	20 kA	50 kA	1.5 kV	315 A	1 CO	2 TE	2736350000
VPU AC II US 2 240/50	2-pole, pluggable	300 V	20 kA	50 kA	1.5 kV	315 A		2 TE	2736320000
VPU AC II US 2 R 240/50	2-pole, pluggable	300 V	20 kA	50 kA	1.5 kV	315 A	1 CO	2 TE	2736330000
VPU AC II US 3 240/50	3-pole, pluggable	300 V	20 kA	50 kA	1.5 kV	315 A		3 TE	2730540000
VPU AC II US 3 R 240/50	3-pole, pluggable	300 V	20 kA	50 kA	1.5 kV	315 A	1 CO	3 TE	2730550000
VPU AC II US 3+1 240/50	4-pole, pluggable	300 V	20 kA	50 kA	1.5 kV	315 A		4 TE	2736360000
VPU AC II US 3+1 R 240/50	4-pole, pluggable	300 V	20 kA	50 kA	1.5 kV	315 A	1 CO	4 TE	2736390000
VPU AC II US 4 240/50	4-pole, pluggable	300 V	20 kA	50 kA	1.5 kV	315 A		4 TE	2736400000
VPU AC II US 4 R 240/50	4-pole, pluggable	300 V	20 kA	50 kA	1.5 kV	315 A	1 CO	4 TE	2736410000
Type II US - 240 V UL 1449 4.Ed NFPA 79 (Status indicator red, yellow, green)									
VPU AC II US 1 R 240/50 Y	1-pole, pluggable	300 V	20 kA	50 kA	1.4 kV	160 A	1 CO	1 TE	2736470000
VPU AC II US 1+1 R 240/50 Y	2-pole, pluggable	300 V	20 kA	50 kA	1.4 kV	160 A	1 CO	2 TE	2736460000
VPU AC II US 2 R 240/50 Y	2-pole, pluggable	300 V	20 kA	50 kA	1.4 kV	160 A	1 CO	2 TE	2736480000
VPU AC II US 3 R 240/50 Y	3-pole, pluggable	300 V	20 kA	50 kA	1.4 kV	160 A	1 CO	3 TE	2736450000
VPU AC II US 3+1 R 240/50 Y	4-pole, pluggable	300 V	20 kA	50 kA	1.4 kV	160 A	1 CO	4 TE	2736440000
VPU AC II US 4 R 240/50 Y	4-pole, pluggable	300 V	20 kA	50 kA	1.4 kV	160 A	1 CO	4 TE	2736490000

Product quick selection, power supply

Type II

Product	Version	Rated voltage U _c (AC)	Discharge current		Protection level U _p	Max. backup fuse	Signalling contact	Overall width	Order No.
			I _n (8/20μs)	I _{max} (8/20μs)					
Type II US - 277 V UL 1449 & NFPA 79									
VPU AC II US 1 277/50	1-pole, pluggable	350 V	20 kA	50 kA	1.75 kV	315 A		1 TE	2730570000
VPU AC II US 1 R 277/50	1-pole, pluggable	350 V	20 kA	50 kA	1.75 kV	315 A	1 CO	1 TE	2730580000
VPU AC II US 1+1 277/50	2-pole, pluggable	350 V	20 kA	50 kA	1.75 kV	315 A		2 TE	2730650000
VPU AC II US 1+1 R 277/50	2-pole, pluggable	350 V	20 kA	50 kA	1.75 kV	315 A	1 CO	2 TE	2730660000
VPU AC II US 2 277/50	2-pole, pluggable	350 V	20 kA	50 kA	1.75 kV	315 A		2 TE	2730630000
VPU AC II US 2 R 277/50	2-pole, pluggable	350 V	20 kA	50 kA	1.75 kV	315 A	1 CO	2 TE	2730640000
VPU AC II US 3 277/50	3-pole, pluggable	350 V	20 kA	50 kA	1.75 kV	315 A		3 TE	2730590000
VPU AC II US 3 R 277/50	3-pole, pluggable	350 V	20 kA	50 kA	1.75 kV	315 A	1 CO	3 TE	2730600000
VPU AC II US 3+1 277/50	4-pole, pluggable	350 V	20 kA	50 kA	1.75 kV	315 A		4 TE	2730670000
VPU AC II US 3+1 R 277/50	4-pole, pluggable	350 V	20 kA	50 kA	1.75 kV	315 A	1 CO	4 TE	2730680000
VPU AC II US 4 277/50	4-pole, pluggable	350 V	20 kA	50 kA	1.75 kV	315 A		4 TE	2730610000
VPU AC II US 4 R 277/50	4-pole, pluggable	350 V	20 kA	50 kA	1.75 kV	315 A	1 CO	4 TE	2730620000
Type II US - 400 V UL 1449 & NFPA 79									
VPU AC II US 1 400/50	1-pole, pluggable	480 V	20 kA	50 kA	2.3 kV	315 A		1 TE	2730700000
VPU AC II US 1 R 400/50	1-pole, pluggable	480 V	20 kA	50 kA	2.3 kV	315 A	1 CO	1 TE	2730710000
VPU AC II US 3 400/50	3-pole, pluggable	480 V	20 kA	50 kA	2.3 kV	315 A		3 TE	2730720000
VPU AC II US 3 R 400/50	3-pole, pluggable	480 V	20 kA	50 kA	2.3 kV	315 A	1 CO	3 TE	2730730000
VPU AC II US 4 400/50	4-pole, pluggable	480 V	20 kA	50 kA	2.3 kV	315 A		4 TE	2730740000
VPU AC II US 4 R 400/50	4-pole, pluggable	480 V	20 kA	50 kA	2.3 kV	315 A	1 CO	4 TE	2730750000
Type II US - 600 V UL 1449 & NFPA 79									
VPU AC II US 1 R 600/35	1-pole, pluggable	750 V	20 kA	35 kA	3.4 kV	315 A	1 CO	1 TE	2736420000
VPU AC II US 2 R 600/35	2-pole, pluggable	750 V	20 kA	35 kA	3.4 kV	315 A	1 CO	2 TE	2736430000
VPU AC II US 3 R 600/35	3-pole, pluggable	750 V	20 kA	35 kA	3.4 kV	315 A	1 CO	3 TE	2730780000
Type II+III - 275 V / 20 kA									
VPU AC II+III 1+1 275/20 S	2-pole, pluggable	275 V	10 kA	20 kA	1.2 kV	100 A		1 TE	2907930000
VPU AC II+III 1+1 R 275/20 S	2-pole, pluggable	275 V	10 kA	20 kA	1.2 kV	100 A	1 CO	1 TE	2907940000
VPU AC II+III 2 275/20 S	2-pole, pluggable	275 V	10 kA	20 kA	1.2 kV	100 A		1 TE	2907830000
VPU AC II+III 2 R 275/20 S	2-pole, pluggable	275 V	10 kA	20 kA	1.2 kV	100 A	1 CO	1 TE	2907840000
VPU AC II+III 3 275/20 S	3-pole, pluggable	275 V	10 kA	20 kA	1.2 kV	100 A		2 TE	2907870000
VPU AC II+III 3 R 275/20 S	3-pole, pluggable	275 V	10 kA	20 kA	1.2 kV	100 A	1 CO	2 TE	2907880000
VPU AC II+III 3+1 275/20 S	4-pole, pluggable	275 V	10 kA	20 kA	1.2 kV	100 A		2 TE	2907950000
VPU AC II+III 3+1 R 275/20 S	4-pole, pluggable	275 V	10 kA	20 kA	1.2 kV	100 A	1 CO	2 TE	2907970000
VPU AC II+III 4 275/20 S	4-pole, pluggable	275 V	10 kA	20 kA	1.2 kV	100 A		2 TE	2907890000
VPU AC II+III 4 R 275/20 S	4-pole, pluggable	275 V	10 kA	20 kA	1.2 kV	100 A	1 CO	2 TE	2907920000
Type II+III - 440 V / 20 kA									
VPU AC II+III 1+1 440/20 S	2-pole, pluggable	440 V	10 kA	20 kA	1.7 kV	100 A		1 TE	2908500000
VPU AC II+III 1+1 R 440/20 S	2-pole, pluggable	440 V	10 kA	20 kA	1.7 kV	100 A	1 CO	1 TE	2908510000
VPU AC II+III 2 440/20 S	2-pole, pluggable	440 V	10 kA	20 kA	1.7 kV	100 A		1 TE	2908440000
VPU AC II+III 2 R 440/20 S	2-pole, pluggable	440 V	10 kA	20 kA	1.7 kV	100 A	1 CO	1 TE	2908450000
VPU AC II+III 3 440/20 S	3-pole, pluggable	440 V	10 kA	20 kA	1.7 kV	100 A		2 TE	2908460000
VPU AC II+III 3 R 440/20 S	3-pole, pluggable	440 V	10 kA	20 kA	1.7 kV	100 A	1 CO	2 TE	2908470000
VPU AC II+III 3+1 440/20 S	4-pole, pluggable	440 V	10 kA	20 kA	1.7 kV	100 A		2 TE	2908520000
VPU AC II+III 3+1 R 440/20 S	4-pole, pluggable	440 V	10 kA	20 kA	1.7 kV	100 A	1 CO	2 TE	2908530000
VPU AC II+III 4 440/20 S	4-pole, pluggable	440 V	10 kA	20 kA	1.7 kV	100 A		2 TE	2908480000
VPU AC II+III 4 R 440/20 S	4-pole, pluggable	440 V	10 kA	20 kA	1.7 kV	100 A	1 CO	2 TE	2908490000





Type III

Product	Version	Rated voltage	Discharge current		Protection level	Max. backup fuse	Signalling contact	Overall width	Order No.
		U _c	I _{in} (8/20 μs)	I _{max} (8/20 μs)	U _p				
Type III - TS 35									
VPU III R 12V/4kV AC/DC	1-pole, separable	20 V	2 kA		980 V	16 A	1 CO	1 TE	1351550000
VPU III R 24V/4kV AC/DC	1-pole, separable	32 V	2 kA		890 V	16 A	1 CO	1 TE	1351580000
VPU III R 48V/4kV AC/DC	1-pole, separable	50 V	2 kA		950 V	16 A	1 CO	1 TE	1351600000
VPU III R 120V/6kV AC/DC	1-pole, separable	150 V	3 kA		1750 V	16 A	1 CO	1 TE	1351630000
VPU III R 230V/6kV AC	1-pole, separable	300 V	3 kA		1800 V	16 A	1 CO	1 TE	1351650000
Type III - SO LD									
VPU III SO LD	1-pole	275 V	1,5 kA		1500 V	16 A	LED		1351680000
VPU III SO LD+A	1-pole	275 V	1,5 kA		1500 V	16 A	LED + acoustic signal		1351700000

VPU AC IoT

Product	Version	Rated voltage	Discharge current	Discharge current	Protection level	Max. backup fuse	Signalling contact	Overall width	Order No.
		U _c (DC)	I _{in} (8/20 μs)	I _{max} (8/20 μs)	U _p				
VPU IoT AC II 3+1 300/50	4-pole, pluggable	300 V	20 kA	50 kA	1.5 kV	315 A	yes, WiFi	6 TE	2735900000

VPU AC I lightning and surge protection

Maximum type I protection from lightning and surges

The current product and application standards underline the importance of reliable overvoltage protection. The combined lightning and overvoltage devices VARITECTOR PU AC I protect your systems from lightning and surges in accordance with Type I and Type II specifications. The varistor and spark gap technology (GDT) ensures the highest level of protection and, if necessary, ensures zero-leakage current for pre-meter applications.

The VPU I series offers products for mains voltages 230 / 400 V and 400 / 690 V with lightning currents of 12.5 kA or 25 kA.



Global applicable

Certification in accordance with international IEC/EN standards and the latest UL 1449 standard guarantees universal use in any application.



Best overview

The large, central, status window provides highly visible information on the status of the protective function.

Faster to assemble

The optimised mounting rail clip enables easy and quick assembly and removal, without the need for tools.



Rapid status messaging

The remote signaling contact with PUSH IN connection can be quickly connected and provides reliable information on the status of the protective function.

Securely locked

The arresters are secured in the socket with the aid of a locking clip. This ensures maximum vibration resistance, ensuring that for example the high requirements of the wind turbine manufacturers are met.



Lightning and surge protection VPU AC I

Type I / type II lightning and surge protection

Weidmüller's VPU AC I series offers combined lightning and surge protection (type I / type II) featuring varistor technology with a leakage current capacity of 12.5 kA to 35 kA (10/350 µs). The pluggable and self-monitoring surgevoltage arresters of up to 35 kA are optionally available as 1-, 2-, 3- or 4-pole versions – with or without a remote signalling contact.

The advantages for you:

- Suitable for various types of mains voltages (TN/TT)
- Tested in compliance with IEC 61643-11 and EN 61643-11
- Convenient installation in sub-distribution boards and electrical cabinets
- Designed for use in buildings according to lightning protective level III/IV for 12.5 kA and I/II for 25 kA
- Very low residual voltage, thus also suitable as Typ II / Typ III surge protection
- Remote signalling function

Lightning conductors with spark gap for lightning protection or equipotential bonding providing surge protection type I

According to the requirements of type I (DIN VDE 0675 part 6) and type I according to IEC 61643-11, the lightning arrester serves as lightning equipotential bonding at the transition from protection zone LPZ 0 to LPZ 1 (according to IEC 1312-1). In combination with several lightning arresters, surge protection is used in the mains forms TN, TT and IT. During lightning strikes, the sparkover gaps are used to establish the required equipotential bonding between the building's surge protection and the power supplier's earthing system.

VPU AC I LCF

Lightning and surge protection for installation before the electric meter in the highest lightning protection level (LPL)

The VPU I LCF family of leakage current free lightning and surge protectors for power are installed before the meter. The arrester protects low-voltage consumers and electronic devices from the direct influences of lightning and surge couplings.

VPU I LCF is approved as type I / type II according to the valid IEC/EN 61643-11.

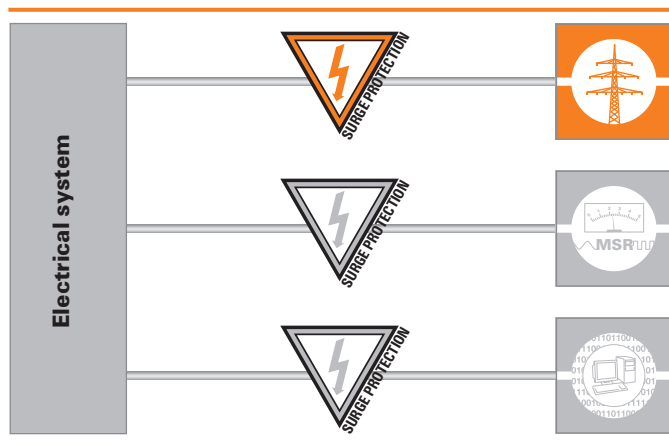



Electrical connection for building installation

The type I VPU AC I series lightning arrester is connected between the external conductors (L1, L2, L3) and N/PE. The N/PE spark gap is produced with the VPU I LCF N-PE 50 kA or 100 kA. Cables as short as possible should be used. Decoupling to downstream type II arresters is not necessary. Please note the installation instructions.

Energy co-ordination

All lightning and surge protection products of the VARITECTOR series are energetically coordinated with each other. No additional downstream components are required for decoupling.

Checking operation, maintenance and approvals

All arresters have large status windows. If the status window is red, the corresponding arrester must be changed.

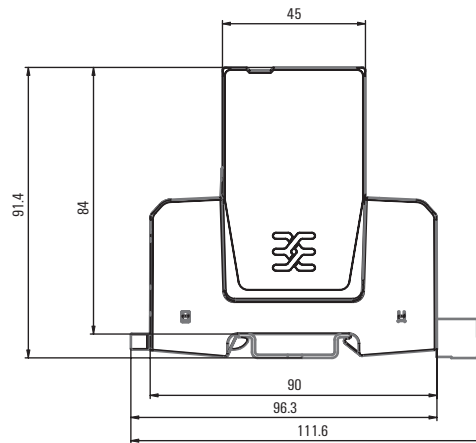

Dimensional drawing VPU AC I

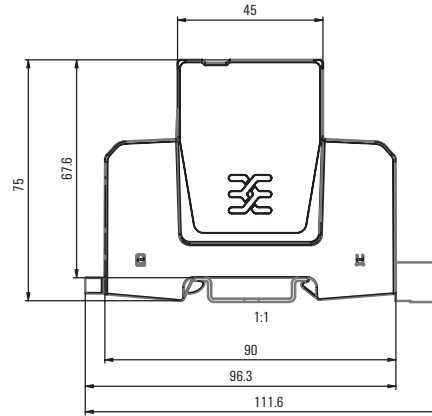

Dimensional drawing VPU AC I LH



Accessories: Remote signalling contact and locking clip

Type			
	Remote signalling contact	PLUG VPU AC	2855300000
	Locking clip	VPU Locking Clip S	2735080000
	Locking clip	VPU Locking Clip L	2735070000

The new benchmark in surge protection VARITECTOR PU AC S

With increasing digitalisation, the infrastructure of intelligent devices and systems is becoming more and more sensitive to interferences. Besides, cost and competition are forcing manufacturers to improve compactness and efficiency of their products.

The innovative HAD-technology (Homogenous Arc Distribution) of the VARITECTOR PU AC S-Line enables a powerful and standard-compliant lightning and surge protection with 25 kA leakage current in a width of just 18 mm. The pluggable product concept minimizes operating and service costs.

Technology highlight:

Weidmüller's VPU AC S-Line was developed to combine the best features of voltage switching and voltage limiting protection technologies to create an ideal Type I surge protection. The innovative HAD technology is extremely compact and uses a voltage switching technology with a very low residual voltage. As a result, the products achieve a market-leading low follow-on current so that even 16 A fuses do not trip.

Your special advantages:

- Narrowest pluggable type I arrester with 25 kA discharge capacity
- Powerful – fuseless operation up to 315 A
- Energetic coordination as type I, II and III enables reliable protection



HAD technology (Homogenous Arc Distribution)

50%
SPACE
SAVING

More efficient installation
The reduction of the components from 2 TE to 1 TE per pole with 25 kA discharge capacity allows a 50 % smaller space requirement. The pluggability of the modules accelerates the replacement of arresters.



Powerful protection
The specially developed disconnection mechanism enables safe operation with high fuse ratings up to 315 A.

Energetic coordination
With a protection level of 1,500 V, the VPU AC S line is coordinated as an arrester of type I, II and III. Additional protection is therefore only required only for wiring distances of more than 10 m to the next electrical consumer monitoring systems.



Type I - Leakage current free 25 kA / 275 V

- No-leakage-current version suitable for use upstream of the electrical meter
- Suitable with 25 kA (10/350 μs) for protective level I, II, III and IV (LPL I/II/III/IV)
- Tested according to IEC 61643-11 for Type I and II surge protection
- Can also be used as Type II surge protection

VPU AC I 1 (R) 275/25 LCF S

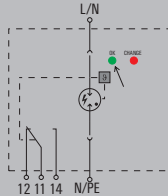

VPU AC I 1+1 (R) 275/25 LCF S

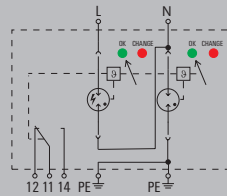

Technical data

Requirements category acc. to IEC/EN 61643-11
 Energy coordination (≤10 m)
 Rated voltage (AC)
 Max. continuous voltage, U_c (L-N / N-PE)
 Low voltage network
 Lightning test current I_{imp} (10/350 μs) (L-PE / N-PE)
 Discharge current I_n (8/20 μs) (Ader-PE / N-PE)
 Discharge current I_{max} (8/20 μs) (Ader-PE / N-PE)
 Protection level U_p at I_n (L/N-PE)
 Protection level U_p at I_n (N-PE)
 Fuse
 Short-circuit current rating I_{scCR}
 Temporary surge voltage (over-voltage) - TOV
 Response time
 Optical function display
 Design
 Ambient temperature (operational)
 Operating altitude

Connection data

Solid
 Stranded
 Stripping length
 Tightening torque

Approvals

Approvals
 Standards

Type I, Type II / T1, T2
 Type I, Type II, Type III
 230 V
 275 V /
 Single-phase, TN
 25 kA /
 25 kA /
 65 kA /
 ≤ 1.5 kV

No Fuse necessary ≤315 A gL

50 kA
 442 V
 <100 ns
 green = OK; red = arrester is defective - replace
 Installation housing; 1TE, Insta IP 20
 -40 °C...85 °C
 ≤ 2000 m

1.5...16 mm²
 2.5...35 mm²
 18 mm
 3...4.5 Nm

CE; VDE
 IEC 61643-11, EN 61643-11

Type I, Type II / T1, T2
 Type I, Type II, Type III
 230 V
 275 V / 305 V
 Single-phase, TN, TT, IT with N, IT without N
 25 kA / 100 kA
 25 kA / 100 kA
 65 kA / 150 kA
 ≤ 1.5 kV
 ≤ 1.5 kV

No Fuse necessary ≤315 A gL

50 kA
 442 V
 <100 ns
 green = OK; red = arrester is defective - replace
 Installation housing; 2TE, Insta IP 20
 -40 °C...85 °C
 ≤ 2000 m

1.5...16 mm²
 2.5...35 mm²
 18 mm
 3...4.5 Nm

CE; VDE
 IEC 61643-11, EN 61643-11

Dimensions / Remote signalling contact info

Clamping range (nominal / min. / max.) mm²
 Height x width x depth mm
 Signalling contact

Note

no remote sig. contact with remote signalling (R)

16 / 1.5 / 35 16 / 1.5 / 35
 90 / 18 / 91 104.5 / 18 / 91
 No 250 V 1A 1CO

Wire-end ferrules must be used when connecting finely stranded wire.

no remote sig. contact with remote signalling (R)

16 / 1.5 / 35 16 / 1.5 / 35
 90 / 36 / 91 104.5 / 36 / 91
 No 250 V 1A 1CO

Wire-end ferrules must be used when connecting finely stranded wire.

Ordering data

without remote signalling contact
 with remote signalling contact (R)

Type	Qty.	Order No.
VPU AC I 1 275/25 LCF S	1	2726620000
VPU AC I 1 R 275/25 LCF S	1	2726660000

Type	Qty.	Order No.
VPU AC I 1+1 275/25 LCF S	1	2726680000
VPU AC I 1+1 R 275/25 LCF S	1	2726700000

Note

Only for IT networks where the earth at the distribution transformer is connected to the earth on the customer side.

Accessories

Note

Pluggable spare arrester L-N: VPU AC I 0 275/25 LCF S - 2730860000

Pluggable spare arrester L-N: VPU AC I 0 275/25 LCF S - 2730860000;
 N-PE: VPU AC I 0 N-PE 305/100 S - 2730850000



Type I - Leakage current free 25 kA / 275 V

- No-leakage-current version suitable for use upstream of the electrical meter
- Suitable with 25 kA (10/350 μs) for protective level I, II, III and IV (LPL I/II/III/IV)
- Tested according to IEC 61643-11 for Type I and II surge protection
- Can also be used as Type II surge protection

VPU AC I 2 (R) 275/25 LCF S

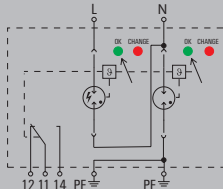

VPU AC I 3 (R) 275/25 LCF S

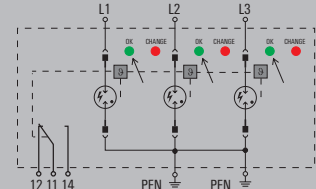

Technical data

Requirements category acc. to IEC/EN 61643-11
 Energy coordination (≤10 m)
 Rated voltage (AC)
 Max. continuous voltage, U_c (L-N / N-PE)
 Low voltage network
 Lightning test current I_{imp} (10/350 μs) (L-PE / N-PE)
 Discharge current I_n (8/20μs) (Ader-PE / N-PE)
 Discharge current I_{max} (8/20μs) (Ader-PE / N-PE)
 Protection level U_p at I_n (L/N-PE)
 Protection level U_p at I_n (N-PE)
 Fuse
 Short-circuit current rating I_{SCCR}
 Temporary surge voltage (over-voltage) - TOV
 Response time
 Optical function display
 Design
 Ambient temperature (operational)
 Operating altitude

Connection data

Solid
 Stranded
 Stripping length
 Tightening torque

Approvals

Approvals
 Standards

Type I, Type II / T1, T2
 Type I, Type II, Type III
 230 V
 275 V /
 Single-phase, TN-S
 25 kA /
 25 kA /
 65 kA /
 ≤ 1.5 kV

No Fuse necessary ≤315 A gL
 50 kA
 442 V
 <100 ns
 green = OK; red = arrester is defective - replace
 Installation housing; 2TE, Insta IP 20
 -40 °C...85 °C
 ≤ 2000 m

1.5...16 mm²
 2.5...35 mm²
 18 mm
 3...4.5 Nm

CE; VDE
 IEC 61643-11, EN 61643-11

Type I, Type II / T1, T2
 Type I, Type II, Type III
 230 V
 275 V /
 TN-C
 25 kA /
 25 kA /
 65 kA /
 ≤ 1.5 kV

No Fuse necessary ≤315 A gL
 50 kA
 442 V
 <100 ns
 green = OK; red = arrester is defective - replace
 Installation housing; 3TE, Insta IP 20
 -40 °C...85 °C
 ≤ 2000 m

1.5...16 mm²
 2.5...35 mm²
 18 mm
 3...4.5 Nm

CE; VDE
 IEC 61643-11, EN 61643-11

Dimensions / Remote signalling contact info

Clamping range (nominal / min. / max.) mm²
 Height x width x depth mm
 Signalling contact

Note

no remote sig. contact with remote signalling (R)

16 / 1.5 / 35 16 / 1.5 / 35
 90 / 36 / 91 104.5 / 36 / 91
 No 250 V 1A 1CO

Wire-end ferrules must be used when connecting finely stranded wire.

no remote sig. contact with remote signalling (R)

16 / 1.5 / 35 16 / 1.5 / 35
 90 / 54 / 91 104.5 / 54 / 91
 No 250 V 1A 1CO

Wire-end ferrules must be used when connecting finely stranded wire.

Ordering data

without remote signalling contact
 with remote signalling contact (R)

Type	Qty.	Order No.
VPU AC I 2 275/25 LCF S	1	2726720000
VPU AC I 2 R 275/25 LCF S	1	2726730000

Type	Qty.	Order No.
VPU AC I 3 275/25 LCF S	1	2726740000
VPU AC I 3 R 275/25 LCF S	1	2726750000

Note

Accessories

Note

Pluggable spare arrester L-N: VPU AC I 0 275/25 LCF S - 2730860000

Pluggable spare arrester L-N: VPU AC I 0 275/25 LCF S - 2730860000

Type I - Leakage current free 25 kA / 275 V

- No-leakage-current version suitable for use upstream of the electrical meter
- Suitable with 25 kA (10/350 μs) for protective level I, II, III and IV (LPL I/II/III/IV)
- Tested according to IEC 61643-11 for Type I and II surge protection
- Can also be used as Type II surge protection

VPU AC I 3+1 (R) 275/25 LCF S 2PE

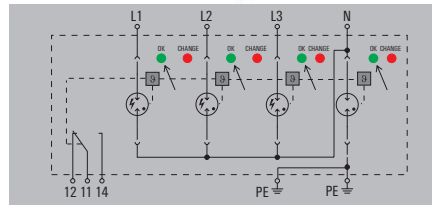

VPU AC I 3+1 (R) 275/25 LCF S 2N

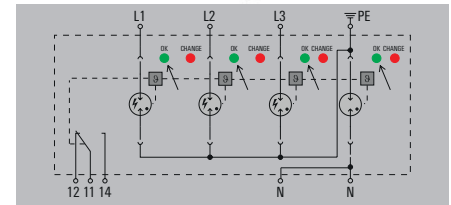

Technical data

Requirements category acc. to IEC/EN 61643-11
Energy coordination (≤10 m)
Rated voltage (AC)
Max. continuous voltage, U _c (L-N / N-PE)
Low voltage network
Lightning test current I _{imp} (10/350 μs) (L-PE / N-PE)
Discharge current I _n (8/20μs) (Ader-PE / N-PE)
Discharge current I _{max} (8/20μs) (Ader-PE / N-PE)
Protection level U _p at I _n (L/N-PE)
Protection level U _p at I _{max} (N-PE)
Fuse
Short-circuit current rating I _{scCR}
Temporary surge voltage (over-voltage) - TOV
Response time
Optical function display
Design
Ambient temperature (operational)
Operating altitude
Connection data
Solid
Stranded
Stripping length
Tightening torque
Approvals
Approvals
Standards

Type I, Type II / T1, T2
Type I, Type II, Type III
230 V
275 V / 305 V
TN-C-S, TN-S, TT, IT with N, IT without N
25 kA / 100 kA
25 kA / 100 kA
65 kA / 150 kA
≤ 1.7 kV
≤ 1.5 kV
No Fuse necessary ≤315 A gL
50 kA
442 V
<100 ns
green = OK; red = arrester is defective - replace
Installation housing; 4TE, Insta IP 20
-40 °C...85 °C
≤ 2000 m
1.5...16 mm ²
2.5...35 mm ²
18 mm
3...4.5 Nm
CE; VDE
IEC 61643-11, EN 61643-11

Type I, Type II / T1, T2
Type I, Type II, Type III
230 V
275 V / 305 V
TN-C-S, TN-S, TT, IT with N, IT without N
25 kA / 100 kA
25 kA / 100 kA
65 kA / 150 kA
≤ 1.5 kV
≤ 1.5 kV
No Fuse necessary ≤315 A gL
50 kA
442 V
<100 ns
green = OK; red = arrester is defective - replace
Installation housing; 4TE, Insta IP 20
-40 °C...85 °C
≤ 2000 m
1.5...16 mm ²
2.5...35 mm ²
18 mm
3...4.5 Nm
CE; VDE
IEC 61643-11, EN 61643-11

Dimensions / Remote signalling contact info	
Clamping range (nominal / min. / max.)	mm ²
Height x width x depth	mm
Signalling contact	
Note	

no remote sig. contact	with remote signalling (R)
16 / 1.5 / 35	16 / 1.5 / 35
90 / 72 / 91	104.5 / 72 / 91
No	250 V 1A 1CO
Wire-end ferrules must be used when connecting finely stranded wire.	

no remote sig. contact	with remote signalling (R)
16 / 1.5 / 35	16 / 1.5 / 35
90 / 72 / 91	104.5 / 72 / 91
No	250 V 1A 1CO
Wire-end ferrules must be used when connecting finely stranded wire.	

Ordering data

without remote signalling contact
with remote signalling contact (R)

Type	Qty.	Order No.
VPU AC I 3+1 275/25 LCF S 2PE	1	2726760000
VPU AC I 3+1 R 275/25 LCF S 2PE	1	2726770000

Type	Qty.	Order No.
VPU AC I 3+1 275/25 LCF S 2N	1	2730280000
VPU AC I 3+1 R 275/25 LCF S 2N	1	2730290000

Note

Only for IT networks where the earth at the distribution transformer is connected to the earth on the customer side.

Only for IT networks where the earth at the distribution transformer is connected to the earth on the customer side.

Accessories

Note

Pluggable spare arrester L-N: VPU AC I 0 275/25 LCF S - 2730860000;
N-PE: VPU AC I 0 N-PE 305/100 S - 2730850000

Pluggable spare arrester L-N: VPU AC I 0 275/25 LCF S - 2730860000;
N-PE: VPU AC I 0 N-PE 305/100 S - 2730850000



Type I - Leakage current free 25 kA / 275 V

- No-leakage-current version suitable for use upstream of the electrical meter
- Suitable with 25 kA (10/350 μs) for protective level I, II, III and IV (LPL I/II/III/IV)
- Tested according to IEC 61643-11 for Type I and II surge protection
- Can also be used as Type II surge protection

VPU AC I 4 (R) 275/25 LCF S

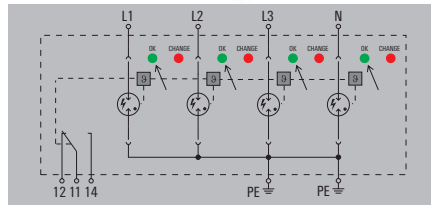

Technical data

Requirements category acc. to IEC/EN 61643-11
 Energy coordination (≤10 m)
 Rated voltage (AC)
 Max. continuous voltage, U_c (L-N / N-PE)
 Low voltage network
 Lightning test current I_{imp} (10/350 μs) (L-PE / N-PE)
 Discharge current I_n (8/20 μs) (Ader-PE / N-PE)
 Discharge current I_{max} (8/20 μs) (Ader-PE / N-PE)
 Protection level U_p at I_n (L/N-PE)
 Protection level U_p at I_n (N-PE)
 Fuse
 Short-circuit current rating I_{scCR}
 Temporary surge voltage (over-voltage) - TOV
 Response time
 Optical function display
 Design
 Ambient temperature (operational)
 Operating altitude

Connection data

Solid
 Stranded
 Stripping length
 Tightening torque

Approvals

Approvals
 Standards

Type I, Type II / T1, T2

Type I, Type II, Type III

230 V

275 V /

TN-C-S, TN-S

25 kA /

25 kA /

65 kA /

≤ 1.5 kV

No Fuse necessary ≤315 A gL

50 kA

442 V

<100 ns

green = OK; red = arrester is defective - replace

Installation housing: 4TE, Insta IP 20

-40 °C...85 °C

≤ 2000 m

1.5...16 mm²

2.5...35 mm²

18 mm

3...4.5 Nm

CE: VDE

IEC 61643-11, EN 61643-11

Dimensions / Remote signalling contact info

Clamping range (nominal / min. / max.) mm²
 Height x width x depth mm
 Signalling contact

Note

no remote sig. contact

16 / 1.5 / 35
 90 / 72 / 91
 No

with remote signalling (R)

16 / 1.5 / 35
 104.5 / 72 / 91
 250 V 1A 1CO

Wire-end ferrules must be used when connecting finely stranded wire.

Ordering data

without remote signalling contact
 with remote signalling contact (R)

Type	Qty.	Order No.
VPU AC I 4 275/25 LCF S	1	2726780000
VPU AC I 4 R 275/25 LCF S	1	2726790000

Note

Accessories

Note

Pluggable spare arrester L-N: VPU AC I 0 275/25 LCF S - 2730860000

Combine operational safety and efficiency VARITECTOR PU AC I with integrated fuse

The demands on system availability in industrial plants, buildings, and power generation plants are growing. Highperformance lightning and surge protection prevents cost-intensive failures and is already mandatory in many areas.

The proven surge protection devices of the VPU series are now also available in variants with integrated type I backup fuse with 25 kA. This eliminates the need for an additional back-up fuse upstream of the surge protection device. The combined type I+II surge protection devices have one back-up fuse per protective path and can be used universally in power distribution systems. Preconfigured product variants simplify application-specific product configurations for use in different network forms.

Your special advantages:

- Perfect protection due to integrated fuse and high discharge currents
- More efficient wiring by omission of back-up fuses
- Flexible use in all power distribution systems
- Convenient installation and maintenance due to pluggable modules
- Particularly compact, space-saving design
- Innovative leakage current-free protection technology
- Cross-connections for free configuration of different network forms



HAD-technology

The innovative HAD technology (Homogenous Arc Distribution) is extremely compact and uses a voltage switching technology with a very low residual voltage. This enables the products to achieve a low follow current strength, which means that even a 16 A fuses will not trip.



Universal use

The dimensioning is independent of the main fuse rating, so that no additional back-up fuse is required even above 315 A. This minimises the wiring effort for all power distributions. Application-specific product configuration for use in different types of network.

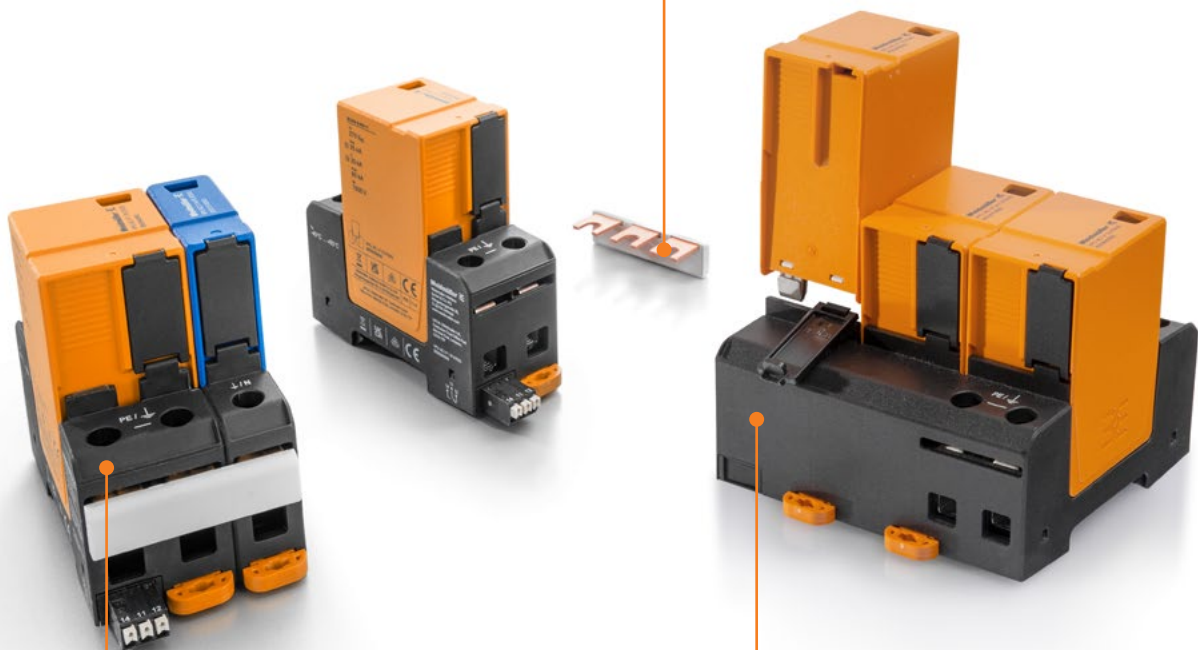

Compact design

The modules have a width of only 35.6 mm per protective path and can be used in small spaces. In addition, they are pluggable and particularly easy to maintain.

Maximum protection

The new surge protection devices with integrated back-up fuse offer optimum protection for power feeds due to 25 kA rated leakage current and fuse monitoring.

Typ I - Integrated fuse 25 kA / 275 V

- Version with integrated fuse
- Suitable with 25 kA (10/350µs) leakage current for protection levels I, II, III, IV (LPL I/II/III/IV)
- Tested according to IEC 61643-11 as type I and II surge protection
- Can also be used as type II surge protection

VPU AC I F 1 (R) 275/25

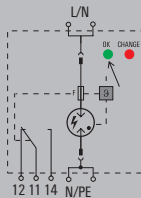

VPU AC I F 3 (R) 275/25

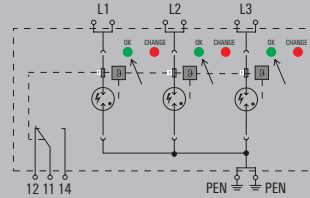

Technical data

Requirements category acc. to IEC/EN 61643-11
Energy coordination (≤10 m)
Rated voltage (AC)
Max. continuous voltage, U_c (L-N / N-PE)
Low voltage network
Lightning test current I_{imp} (10/350 µs) (L-PE / N-PE)
Discharge current I_n (8/20µs) (Ader-PE / N-PE)
Discharge current I_{max} (8/20µs) (Ader-PE / N-PE)
Protection level U_p at I_n (L/N-PE)
Protection level U_p at I_n (N-PE)
Fuse
Short-circuit current rating I_{scCR}
Temporary surge voltage (over-voltage) - TOV
Response time
Optical function display
Design
Ambient temperature (operational)
Operating altitude
Connection data
Solid
Stranded
Stripping length
Tightening torque
Approvals
Approvals
Standards

Type I, Type II / T1, T2
Type I, Type II, Type III
230 V
275 V /
Single-phase, TN
25 kA /
25 kA /
65 kA /
≤ 1.5 kV
Not required, internally available
75 kA
442 V
<100 ns
green = OK; red = arrester is defective - replace
Installation housing; 2TE, Insta IP 20
-40 °C...85 °C
≤ 2000 m
1.5...16 mm ²
1.5...35 mm ²
18 mm
3...4.5 Nm
CE; VDE
IEC 61643-11, EN 61643-11

Type I, Type II, Type III / T1, T2, T3
Type I, Type II, Type III
230 V
275 V /
TN-C
25 kA /
25 kA /
65 kA /
≤ 2.1 kV
Not required, internally available
100 kA
442 V
<100 ns
green = OK; red = arrester is defective - replace
Installation housing; 6 TE, Insta IP 20
-40 °C...85 °C
≤ 2000 m
1.5...16 mm ²
1.5...35 mm ²
18 mm
3...4.5 Nm
CE
IEC 61643-11, EN 61643-11

Dimensions / Remote signalling contact info
Clamping range (nominal / min. / max.)
Height x width x depth
Signalling contact
Note

no remote sig. contact	with remote signalling (R)
16 / 1.5 / 35	16 / 1.5 / 35
90 / 36 / 86	105 / 36 / 86
No	250 V 1A 1CO
Wire-end ferrules must be used when connecting finely stranded wire.	

no remote sig. contact	with remote signalling (R)
16 / 1.5 / 35	16 / 1.5 / 35
90 / 108 / 86	105 / 108 / 86
No	250 V 1A 1CO
Wire-end ferrules must be used when connecting finely stranded wire.	

Ordering data

without remote signalling contact
with remote signalling contact (R)

Type	Qty.	Order No.
VPU AC I F 1 275/25	1	2859330000
VPU AC I F 1 R 275/25	1	2859340000

Type	Qty.	Order No.
VPU AC I F 3 275/25	1	3022890000
VPU AC I F 3 R 275/25	1	3022900000

Note

Accessories

Note

Pluggable spare arrester L-N: VPU AC I F 0 275/25 - 2859350000

Pluggable spare arrester L-N: VPU AC I F 0 275/25 MP - 3056190000



Typ I - Integrated fuse 25 kA / 275 V

- Version with integrated fuse
- Suitable with 25 kA (10/350µs) leakage current for protection levels I, II, III, IV (LPL I/II/III/IV)
- Tested according to IEC 61643-11 as type I and II surge protection
- Can also be used as type II surge protection

VPU AC I F 3+1 (R) 275/25

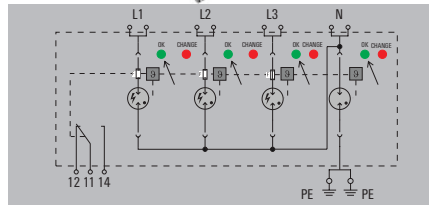

Technical data

Requirements category acc. to IEC/EN 61643-11
 Energy coordination (≤10 m)
 Rated voltage (AC)
 Max. continuous voltage, U_c (L-N / N-PE)
 Low voltage network
 Lightning test current I_{imp} (10/350 µs) (L-PE / N-PE)
 Discharge current I_n (8/20µs) (Ader-PE / N-PE)
 Discharge current I_{max} (8/20µs) (Ader-PE / N-PE)
 Protection level U_p at I_n (L/N-PE)
 Protection level U_p at I_n (N-PE)
 Fuse
 Short-circuit current rating I_{scCR}
 Temporary surge voltage (over-voltage) - TOV
 Response time
 Optical function display
 Design
 Ambient temperature (operational)
 Operating altitude

Connection data

Solid
 Stranded
 Stripping length
 Tightening torque

Approvals

Approvals
 Standards

Type I, Type II, Type III / T1, T2, T3

Type I, Type II, Type III

230 V

275 V / 305 V

TN-S, TT

25 kA / 100 kA

25 kA / 100 kA

65 kA /

≤ 2.1 kV

≤ 1.5 kV

Not required, internally available

100 kA

442 V

<100 ns

green = OK; red = arrester is defective - replace

Installation housing: 8 TE, Insta IP 20

-40 °C...85 °C

≤ 2000 m

1.5...16 mm²

1.5...35 mm²

18 mm

3...4.5 Nm

CE

IEC 61643-11, EN 61643-11

Dimensions / Remote signalling contact info

Clamping range (nominal / min. / max.) mm²
 Height x width x depth mm
 Signalling contact

Note

no remote sig. contact

16 / 1.5 / 35
 90 / 144 / 86
 No

with remote signalling (R)

16 / 1.5 / 35
 105 / 144 / 86
 250 V 1A 1CO

Wire-end ferrules must be used when connecting finely stranded wire.

Ordering data

without remote signalling contact
 with remote signalling contact (R)

Type	Qty.	Order No.
VPU AC I F 3+1 275/25	1	3022910000
VPU AC I F 3+1 R 275/25	1	3022920000

Note

Only for IT networks where the earth at the distribution transformer is connected to the earth on the customer side.

Accessories

Note

Pluggable spare arrester L-N: VPU AC I F 0 275/25 MP - 3056190000; N-PE: VPU AC I F 0 N-PE 275/25 - 3022930000



- Leakage current-free design suitable for use in the pre-metering area
- Back-up fuse not necessary up to 315 A
- Pluggable arrester
- Suitable with 12.5 kA for LPL III/IV
- Tested according to IEC/EN61643-11 as type I and II

VPU AC I 1 (R) 300/12.5 LCF

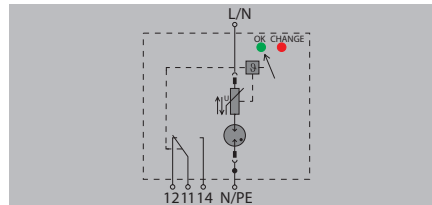

VPU AC I 1+1 (R) 300/12.5 LCF

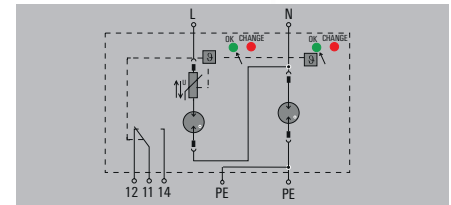

Technical data

Requirements category acc. to IEC/EN 61643-11
Energy coordination (≤10 m)
Rated voltage (AC)
Max. continuous voltage, U_c (L-N / N-PE)
Low voltage network
Lightning test current I_{imp} (10/350 μs) (L-PE / N-PE)
Discharge current I_n (8/20 μs) (Ader-PE / N-PE)
Discharge current I_{max} (8/20 μs) (Ader-PE / N-PE)
Protection level U_p at I_n (L/N-PE)
Protection level U_p at I_n (N-PE)
Fuse
Short-circuit current rating I_{scCR}
Temporary surge voltage (over-voltage) - TOV
Response time
Optical function display
Design
Ambient temperature (operational)
Operating altitude
Connection data
Solid
Stranded
Stripping length
Tightening torque
Approvals
Approvals
Standards

Type I, Type II / T1, T2
Type I, Type II, Type III
230 V
300 V /
Single-phase, TN
12.5 kA /
20 kA /
65 kA /
≤ 1.5 kV
No Fuse necessary ≤315 A gG, 250 A gG @50 kA Isccr, 315 A gG @25 kA Isccr
50 kA
442 V
≤ 25 ns
green = OK; red = arrester is defective - replace
Installation housing; 1TE, Insta IP 20
-40 °C...85 °C
≤ 4000 m
1.5...16 mm ²
1.5...35 mm ²
18 mm
3...4.5 Nm
CE; cURus; VDE
IEC 61643-11, EN 61643-11, UL 1449

Type I, Type II / T1, T2
Type I, Type II, Type III
230 V
300 V / 305 V
Single-phase, TN, TT, IT with N, IT without N
12.5 kA / 50 kA
20 kA / 50 kA
65 kA / 50 kA
≤ 1.5 kV
≤ 1.5 kV
No Fuse necessary ≤315 A gG, 250 A gG @50 kA Isccr, 315 A gG @25 kA Isccr
50 kA
442 V
≤ 25 ns
green = OK; red = arrester is defective - replace
Installation housing; 2TE, Insta IP 20
-40 °C...85 °C
≤ 4000 m
1.5...16 mm ²
1.5...35 mm ²
18 mm
3...4.5 Nm
CE; cURus; VDE
IEC 61643-11, EN 61643-11, UL 1449

Dimensions / Remote signalling contact info	
Clamping range (nominal / min. / max.)	mm ²
Height x width x depth	mm
Signalling contact	
Note	

no remote sig. contact	with remote signalling (R)
16 / 1.5 / 35	16 / 1.5 / 35
90 / 18 / 91	104.5 / 18 / 91
No	250 V 1A 1CO
Wire-end ferrules must be used when connecting finely stranded wire.	

no remote sig. contact	with remote signalling (R)
16 / 1.5 / 35	16 / 1.5 / 35
90 / 36 / 91	104.5 / 36 / 91
No	250 V 1A 1CO
Wire-end ferrules must be used when connecting finely stranded wire.	

Ordering data

	without remote signalling contact
	with remote signalling contact (R)

Type	Qty.	Order No.
VPU AC I 1 300/12.5 LCF	1	2636950000
VPU AC I 1 R 300/12.5 LCF	1	2636960000

Type	Qty.	Order No.
VPU AC I 1+1 300/12.5 LCF	1	2636930000
VPU AC I 1+1 R 300/12.5 LCF	1	2636940000

Note

Only for IT networks where the earth at the distribution transformer is connected to the earth on the customer side.

Accessories

Note

Pluggable spare arrester L-N: VPU AC I 0 300/12.5 LCF - 263900000

Pluggable spare arrester L-N: VPU AC I 0 300/12.5 LCF - 263900000; N-PE: VPU I 0 N-PE 260V/50KA LCF - 2668450000



- Leakage current-free design suitable for use in the pre-metering area
- Back-up fuse not necessary up to 315 A
- Pluggable arrester
- Suitable with 12.5 kA for LPL III/IV
- Tested according to IEC/EN61643-11 as type I and II

VPU AC I 3 (R) 300/12.5 LCF

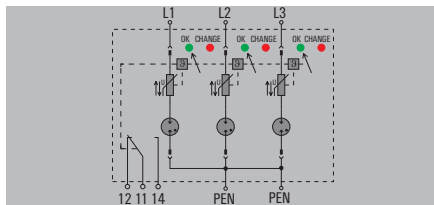

VPU AC I 3+1 (R) 300/12.5 LCF

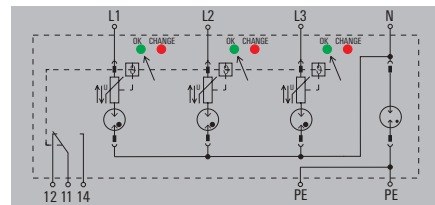

Technical data

Requirements category acc. to IEC/EN 61643-11
 Energy coordination (≤ 10 m)
 Rated voltage (AC)
 Max. continuous voltage, U_c (L-N / N-PE)
 Low voltage network
 Lightning test current I_{imp} (10/350 μ s) (L-PE / N-PE)
 Discharge current I_n (8/20 μ s) (Ader-PE / N-PE)
 Discharge current I_{max} (8/20 μ s) (Ader-PE / N-PE)
 Protection level U_p at I_n (L/N-PE)
 Protection level U_p at I_n (N-PE)
 Fuse

Short-circuit current rating I_{SCCR}
 Temporary surge voltage (over-voltage) - TOV
 Response time
 Optical function display
 Design
 Ambient temperature (operational)
 Operating altitude

Connection data

Solid
 Stranded
 Stripping length
 Tightening torque

Approvals

Approvals
 Standards

Type I, Type II / T1, T2
Type I, Type II, Type III
230 V
300 V /
TN-C
12.5 kA /
20 kA /
65 kA /
≤ 1.5 kV

No Fuse necessary ≤ 315 A gG, 250 A gG @50 kA I_{SCCR} , 315 A gG @25 kA I_{SCCR}
 50 kA
 442 V
 ≤ 25 ns
 green = OK; red = arrester is defective - replace
 Installation housing; 3TE, Insta IP 20
 -40 °C...85 °C
 ≤ 4000 m

1.5...16 mm ²
1.5...35 mm ²
18 mm
3...4.5 Nm

CE; cURus; VDE
 IEC 61643-11, EN 61643-11, UL 1449

Type I, Type II / T1, T2
Type I, Type II, Type III
230 V
300 V / 305 V
TN-C-S, TN-S, TT, IT with N, IT without N
12.5 kA / 50 kA
20 kA / 50 kA
65 kA / 50 kA
≤ 1.5 kV
≤ 1.5 kV

No Fuse necessary ≤ 315 A gG, 250 A gG @50 kA I_{SCCR} , 315 A gG @25 kA I_{SCCR}
 50 kA
 442 V
 ≤ 25 ns
 green = OK; red = arrester is defective - replace
 Installation housing; 4TE, Insta IP 20
 -40 °C...85 °C
 ≤ 4000 m

1.5...16 mm ²
1.5...35 mm ²
18 mm
3...4.5 Nm

CE; cURus; VDE
 IEC 61643-11, EN 61643-11, UL 1449

Dimensions / Remote signalling contact info

Clamping range (nominal / min. / max.)	mm ²
Height x width x depth	mm
Signalling contact	

Note

no remote sig. contact	with remote signalling (R)
16 / 1.5 / 35	16 / 1.5 / 35
90 / 54 / 91	104.5 / 54 / 91
No	250 V 1A 1CO

Wire-end ferrules must be used when connecting finely stranded wire.

no remote sig. contact	with remote signalling (R)
16 / 1.5 / 35	16 / 1.5 / 35
90 / 72 / 91	104.5 / 72 / 91
No	250 V 1A 1CO

Wire-end ferrules must be used when connecting finely stranded wire.

Ordering data

without remote signalling contact
 with remote signalling contact (R)

Type	Qty.	Order No.
VPU AC I 3 300/12.5 LCF	1	2636970000
VPU AC I 3 R 300/12.5 LCF	1	2636980000

Type	Qty.	Order No.
VPU AC I 3+1 300/12.5 LCF	1	2636910000
VPU AC I 3+1 R 300/12.5 LCF	1	2636920000

Note

Only for IT networks where the earth at the distribution transformer is connected to the earth on the customer side.

Accessories

Note

Pluggable spare arrester L-N: VPU AC I 0 300/12.5 LCF - 263900000

Pluggable spare arrester L-N: VPU AC I 0 300/12.5 LCF - 263900000

Type I - 12.5 kA / 300 V

- Back-up fuse not necessary up to 250 A
- Pluggable arrester
- Suitable with 12.5 kA for LPL III/IV
- Tested according to IEC/EN61643-11 as Type I and Type II

VPU AC I 1 (R) 300/12.5 LH

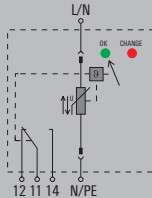

VPU AC I 1+1 (R) 300/12.5 LH

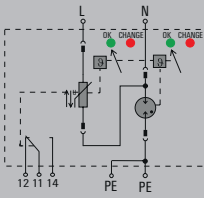

Technical data

Requirements category acc. to IEC/EN 61643-11
 Energy coordination (≤ 10 m)
 Rated voltage (AC)
 Max. continuous voltage, U_c (L-N / N-PE)
 Low voltage network
 Lightning test current I_{imp} (10/350 μ s) (L-PE / N-PE)
 Discharge current I_n (8/20 μ s) (Ader-PE / N-PE)
 Discharge current I_{max} (8/20 μ s) (Ader-PE / N-PE)
 Protection level U_p at I_n (L/N-PE)
 Protection level U_p at I_n (N-PE)
 Fuse

Short-circuit current rating I_{SCCR}
 Temporary surge voltage (over-voltage) - TOV
 Response time
 Optical function display
 Design
 Ambient temperature (operational)
 Operating altitude

UL values

Category
 Rated Voltage U_n
 Max. continuous voltage MCOV (L-L / L-N / L-G / N-G)
 UL Energy Networks

Connection data

Solid
 Stranded
 Stripping length
 Tightening torque

Approvals

Approvals
 Standards

Dimensions / Remote signalling contact info

Clamping range (nominal / min. / max.) mm²
 Height x width x depth mm
 Signalling contact

Note

Ordering data

without remote signalling contact
 with remote signalling contact (R)

Note

Accessories

Note

Type I, Type II / T1, T2
 Type I, Type II, Type III
 230 V
 300 V /
 Single-phase, TN
 12.5 kA / 50 kA
 20 kA / 50 kA
 50 kA / 50 kA
 ≤ 1.5 kV

No Fuse necessary ≤ 315 A gG, 250 A gG @50 kA Isccr, 315 A gG @25 kA Isccr

50 kA
 337 V
 ≤ 25 ns
 green = OK; red = arrester is defective - replace
 Installation housing; 1TE, Insta IP 20
 -40 °C...85 °C
 ≤ 4000 m

SPD TYPE 4CA

240 V
 / / 300 V / 305 V
 Split-Phase

1.5...16 mm²
 1.5...35 mm²
 18 mm
 3...4.5 Nm

CE; VDE; cURus
 IEC 61643-11, EN 61643-11, UL 1449

no remote sig. contact with remote signalling (R)

16 / 1.5 / 35	16 / 1.5 / 35
90 / 18 / 70	105 / 18 / 70
No	250 V 1A 1CO

Wire-end ferrules must be used when connecting finely stranded wire.

Type	Qty.	Order No.
VPU AC I 1 300/12.5 LH	1	2983420000
VPU AC I 1 R 300/12.5 LH	1	2983510000

Pluggable spare arrester L-N: VPU AC I 0 300/12.5 LH - 2983620000

Type I, Type II / T1, T2
 Type I, Type II, Type III
 230 V
 300 V /
 Single-phase, TN, TT, IT with N, IT without N
 12.5 kA / 50 kA
 20 kA / 50 kA
 50 kA / 100 kA
 ≤ 1.5 kV
 ≤ 1.5 kV

No Fuse necessary ≤ 315 A gG, 250 A gG @50 kA Isccr, 315 A gG @25 kA Isccr

50 kA
 337 V
 ≤ 25 ns
 green = OK; red = arrester is defective - replace
 Installation housing; 2TE, Insta IP 20
 -40 °C...85 °C
 ≤ 4000 m

SPD TYPE 4CA

240 V
 / 300 V / 600 V / 305 V
 Split-Phase

1.5...16 mm²
 1.5...35 mm²
 18 mm
 3...4.5 Nm

CE; VDE; cURus
 IEC 61643-11, EN 61643-11, UL 1449

no remote sig. contact with remote signalling (R)

16 / 1.5 / 35	16 / 1.5 / 35
90 / 36 / 70	105 / 36 / 70
No	250 V 1A 1CO

Wire-end ferrules must be used when connecting finely stranded wire.

Type	Qty.	Order No.
VPU AC I 1+1 300/12.5 LH	1	2983520000
VPU AC I 1+1 R 300/12.5 LH	1	2983530000

Only for IT networks where the earth at the distribution transformer is connected to the earth on the customer side.

Pluggable spare arrester L-N: VPU AC I 0 300/12.5 LH - 2983620000; N-PE: VPU AC I 0 N-PE 305/50 LH - 2983630000





Type I - 12.5 kA / 300 V

- Back-up fuse not necessary up to 250 A
- Pluggable arrester
- Suitable with 12.5 kA for LPL III/IV
- Tested according to IEC/EN61643-11 as Type I and Type II

VPU AC I 2 (R) 300/12.5 LH

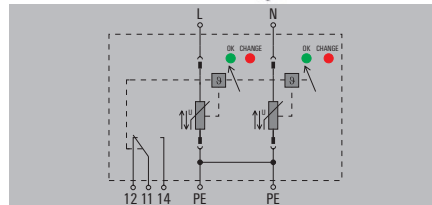

VPU AC I 3 (R) 300/12.5 LH

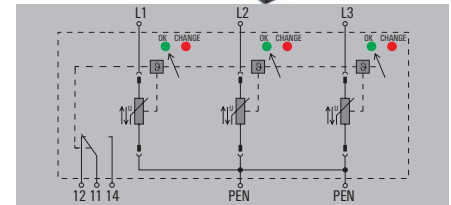

Technical data

Requirements category acc. to IEC/EN 61643-11
 Energy coordination (≤10 m)
 Rated voltage (AC)
 Max. continuous voltage, U_c (L-N / N-PE)
 Low voltage network
 Lightning test current I_{imp} (10/350 μ s) (L-PE / N-PE)
 Discharge current I_n (8/20 μ s) (Ader-PE / N-PE)
 Discharge current I_{max} (8/20 μ s) (Ader-PE / N-PE)
 Protection level U_p at I_n (L/N-PE)
 Protection level U_p at I_n (N-PE)
 Fuse

Short-circuit current rating I_{SCCR}
 Temporary surge voltage (over-voltage) - TOV
 Response time
 Optical function display
 Design
 Ambient temperature (operational)
 Operating altitude

UL values

Category
 Rated Voltage U_n
 Max. continuous voltage MCOV (L-L / L-N / L-G / N-G)
 UL Energy Networks

Connection data

Solid
 Stranded
 Stripping length
 Tightening torque

Approvals

Approvals
 Standards

Dimensions / Remote signalling contact info

Clamping range (nominal / min. / max.) mm²
 Height x width x depth mm
 Signalling contact

Note

Ordering data

without remote signalling contact
 with remote signalling contact (R)

Note

Accessories

Note

Type I, Type II / T1, T2
 Type I, Type II, Type III
 230 V
 300 V /
 Single-phase, TN-S
 12.5 kA /
 20 kA /
 50 kA /
 ≤ 1.5 kV

No Fuse necessary ≤315 A gG, 250 A gG @50 kA Isccr, 315 A gG @25 kA Isccr
 50 kA
 337 V
 ≤ 25 ns
 green = OK; red = arrester is defective - replace
 Installation housing; 2TE, Insta IP 20
 -40 °C...85 °C
 ≤ 4000 m

SPD TYPE 4CA

240 V
 600 V / 300 V / / 300 V
 Split-Phase

1.5...16 mm²
 1.5...35 mm²
 18 mm
 3...4.5 Nm

CE; VDE; cURus
 IEC 61643-11, EN 61643-11, UL 1449

no remote sig. contact	with remote signalling (R)
16 / 1.5 / 35	16 / 1.5 / 35
90 / 36 / 70	105 / 36 / 70
No	250 V 1A 1C0

Wire-end ferrules must be used when connecting finely stranded wire.

Type	Qty.	Order No.
VPU AC I 2 300/12.5 LH	1	2983540000
VPU AC I 2 R 300/12.5 LH	1	2983550000

Pluggable spare arrester L-N: VPU AC I 0 300/12.5 LH - 2983620000

Type I, Type II / T1, T2
 Type I, Type II, Type III
 230 V
 300 V /
 TN-C
 12.5 kA /
 20 kA /
 50 kA /
 ≤ 1.5 kV

No Fuse necessary ≤315 A gG, 250 A gG @50 kA Isccr, 315 A gG @25 kA Isccr
 50 kA
 337 V
 ≤ 25 ns
 green = OK; red = arrester is defective - replace
 Installation housing; 3TE, Insta IP 20
 -40 °C...85 °C
 ≤ 4000 m

SPD TYPE 4CA

240 V
 600 V / / 300 V /
 Delta System

1.5...16 mm²
 1.5...35 mm²
 18 mm
 3...4.5 Nm

CE; VDE; cURus
 IEC 61643-11, EN 61643-11, UL 1449

no remote sig. contact	with remote signalling (R)
16 / 1.5 / 35	16 / 1.5 / 35
90 / 54 / 70	105 / 54 / 70
No	250 V 1A 1C0

Wire-end ferrules must be used when connecting finely stranded wire.

Type	Qty.	Order No.
VPU AC I 3 300/12.5 LH	1	2983570000
VPU AC I 3 R 300/12.5 LH	1	2983560000

Pluggable spare arrester L-N: VPU AC I 0 300/12.5 LH - 2983620000

Type I - 12.5 kA / 300 V

- Back-up fuse not necessary up to 250 A
- Pluggable arrester
- Suitable with 12.5 kA for LPL III/IV
- Tested according to IEC/EN61643-11 as Type I and Type II

VPU AC I 3+1 (R) 300/12.5 LH

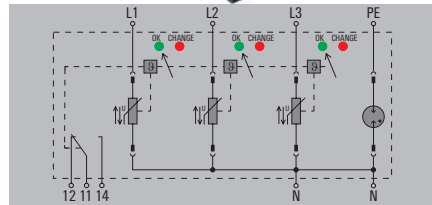

VPU AC I 4 (R) 300/12.5 LH

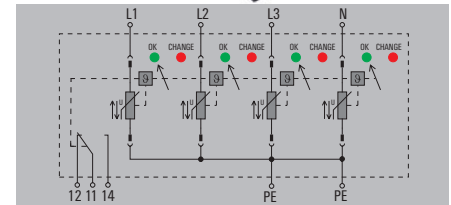

Technical data

Requirements category acc. to IEC/EN 61643-11
 Energy coordination (≤ 10 m)
 Rated voltage (AC)
 Max. continuous voltage, U_c (L-N / N-PE)
 Low voltage network
 Lightning test current I_{imp} (10/350 μ s) (L-PE / N-PE)
 Discharge current I_n (8/20 μ s) (Ader-PE / N-PE)
 Discharge current I_{max} (8/20 μ s) (Ader-PE / N-PE)
 Protection level U_p at I_n (L/N-PE)
 Protection level U_p at I_n (N-PE)
 Fuse

Short-circuit current rating I_{scCR}
 Temporary surge voltage (over-voltage) - TOV
 Response time
 Optical function display
 Design
 Ambient temperature (operational)
 Operating altitude

UL values

Category
 Rated Voltage U_n
 Max. continuous voltage MCOV (L-L / L-N / L-G / N-G)
 UL Energy Networks

Connection data

Solid
 Stranded
 Stripping length
 Tightening torque

Approvals

Approvals
 Standards

Dimensions / Remote signalling contact info

Clamping range (nominal / min. / max.) mm²
 Height x width x depth mm
 Signalling contact

Note

Ordering data

without remote signalling contact
 with remote signalling contact (R)

Note

Accessories

Note

Type I, Type II / T1, T2
 Type I, Type II, Type III
 230 V
 305 V /
 TN-C, TN-S, TT, IT with N, IT without N
 12.5 kA / 50 kA
 20 kA / 50 kA
 50 kA / 100 kA
 ≤ 1.5 kV
 ≤ 1.5 kV

No Fuse necessary ≤ 315 A gG, 250 A gG @50 kA Isccr, 315 A gG @25 kA Isccr

50 kA

337 V

≤ 25 ns

green = OK; red = arrester is defective - replace

Installation housing; 4TE, Insta IP 20

-40 °C...85 °C

≤ 4000 m

SPD TYPE 4CA

240 V

600 V / 300 V / 600 V / 305 V

3-phase WYE

1.5...16 mm²

1.5...35 mm²

18 mm

3...4.5 Nm

CE; VDE; cURus

IEC 61643-11, EN 61643-11, UL 1449

no remote sig. contact

16 / 1.5 / 35

90 / 72 / 70

No

Wire-end ferrules must be used when connecting finely stranded wire.

with remote signalling (R)

16 / 1.5 / 35

105 / 72 / 70

250 V 1A 1CO

Type	Qty.	Order No.
VPU AC I 3+1 300/12.5 LH	1	2983580000
VPU AC I 3+1 R 300/12.5 LH	1	2983590000

Only for IT networks where the earth at the distribution transformer is connected to the earth on the customer side.

Pluggable spare arrester L-N: VPU AC I 0 300/12.5 LH - 2983620000; N-PE: VPU AC I 0 N-PE 305/50 LH - 2983630000

Type I, Type II / T1, T2
 Type I, Type II, Type III
 230 V
 300 V /
 TN-CS, TN-S
 12.5 kA /
 20 kA /
 50 kA /
 ≤ 1.5 kV

No Fuse necessary ≤ 315 A gG, 250 A gG @50 kA Isccr, 315 A gG @25 kA Isccr

50 kA

337 V

≤ 25 ns

green = OK; red = arrester is defective - replace

Installation housing; 4TE, Insta IP 20

-40 °C...85 °C

≤ 4000 m

SPD TYPE 4CA

240 V

600 V / 600 V / 300 V / 300 V

3-phase WYE

1.5...16 mm²

1.5...35 mm²

18 mm

3...4.5 Nm

CE; VDE; cURus

IEC 61643-11, EN 61643-11, UL 1449

no remote sig. contact

16 / 1.5 / 35

90 / 72 / 70

No

Wire-end ferrules must be used when connecting finely stranded wire.

with remote signalling (R)

16 / 1.5 / 35

105 / 72 / 70

250 V 1A 1CO

Type	Qty.	Order No.
VPU AC I 4 300/12.5 LH	1	2983600000
VPU AC I 4 R 300/12.5 LH	1	2983610000

Pluggable spare arrester L-N: VPU AC I 0 300/12.5 LH - 2983620000



Type I - 12.5 kA / 950 V

- Pluggable arrester
- Suitable with 12.5 kA for LPL III/IV
- Tested according to IEC/EN61643-11 as type I and II

VPU AC I 3+MOV R 950/12.5

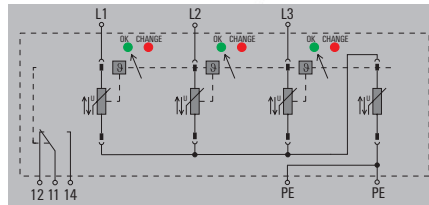

Technical data

Requirements category acc. to IEC/EN 61643-11
 Energy coordination (≤ 10 m)
 Rated voltage (AC)
 Max. continuous voltage, U_c (L-N / N-PE)
 Low voltage network
 Lightning test current I_{imp} (10/350 μ s) (L-PE / N-PE)
 Discharge current I_n (8/20 μ s) (Ader-PE / N-PE)
 Discharge current I_{max} (8/20 μ s) (Ader-PE / N-PE)
 Protection level U_p at I_n (L/N-PE)
 Protection level U_p at I_n (N-PE)
 Fuse

Short-circuit current rating I_{SCCR}
 Temporary surge voltage (over-voltage) - TOV
 Response time
 Optical function display
 Design
 Ambient temperature (operational)
 Operating altitude

Connection data

Solid
 Stranded
 Stripping length
 Tightening torque

Approvals

Approvals
 Standards

Type I, Type II / T1, T2
Type I, Type II, Type III
800 V
950 V /
TN-C, IT without N
12.5 kA /
20 kA /
50 kA /
≤ 4 kV
160 A gG
25 kA
≤ 25 ns
green = OK; red = arrester is defective - replace
Installation housing; 4TE, Insta IP 20
-40 °C...85 °C
≤ 2000 m
6...16 mm ²
2.5...35 mm ²
18 mm
3...4.5 Nm
CE
IEC 61643-11, EN 61643-11

Dimensions / Remote signalling contact info

Clamping range (nominal / min. / max.) mm²
 Height x width x depth mm
 Signalling contact

Note

with remote signalling (R)

16 / 6 / 35
 90 / 54 / 91
 250 V 1A 1CO
 Wire-end ferrules must be used when connecting finely stranded wire.

Ordering data

with remote signalling contact (R)

Type	Qty.	Order No.
VPU AC I 3+MOV R 950/12.5	1	2845570000

Note

Accessories

Note

Pluggable spare arrester L-N: VPU AC I 0 950/12.5 - 2855240000; VPU AC I 0 MOV 950/12.5 - 2855250000

Type I - 10 kA / 480 V

- Back-up fuse not necessary up to 315 A
- Pluggable arrester
- Tested according to IEC/EN61643-11 as Type I and Type II

VPU AC I 1 (R) 480/10

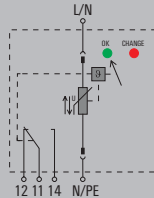

VPU AC I 3 (R) 480/10

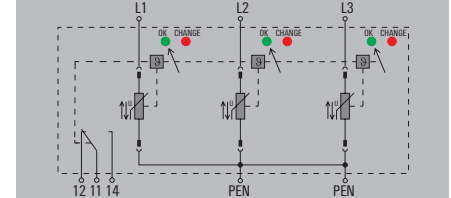

Technical data

Requirements category acc. to IEC/EN 61643-11
 Energy coordination (≤ 10 m)
 Rated voltage (AC)
 Max. continuous voltage, U_c (L-N / N-PE)
 Low voltage network
 Lightning test current I_{imp} (10/350 μ s) (L-PE / N-PE)
 Discharge current I_n (8/20 μ s) (Ader-PE / N-PE)
 Discharge current I_{max} (8/20 μ s) (Ader-PE / N-PE)
 Protection level U_p at I_n (L/N-PE)
 Protection level U_p at I_n (N-PE)
 Fuse

Short-circuit current rating I_{scCR}
 Temporary surge voltage (over-voltage) - TOV
 Response time
 Optical function display
 Design
 Ambient temperature (operational)
 Operating altitude

Connection data

Solid
 Stranded
 Stripping length
 Tightening torque

Approvals

Approvals
 Standards

Type I, Type II / T1, T2
 Type I, Type II, Type III
 400 V
 480 V /
 Single-phase, TN
 10 kA /
 20 kA /
 50 kA /
 ≤ 2.1 kV

No Fuse necessary ≤ 315 A gG, 250 A gG @50 kA Isccr, 315 A gG @25 kA Isccr
 50 kA
 762 V
 ≤ 25 ns
 green = OK; red = arrester is defective - replace
 Installation housing; 1TE, Insta IP 20
 -40 °C...85 °C
 ≤ 4000 m

1.5...16 mm²
 1.5...35 mm²
 18 mm
 3...4.5 Nm

CE; cURus; VDE
 IEC 61643-11, EN 61643-11, UL 1449

Type I, Type II / T1, T2
 Type I, Type II, Type III
 400 V
 480 V /
 TN-C
 10 kA /
 20 kA /
 50 kA /
 ≤ 2.1 kV

No Fuse necessary ≤ 315 A gG, 250 A gG @50 kA Isccr, 315 A gG @25 kA Isccr
 50 kA
 762 V
 ≤ 25 ns
 green = OK; red = arrester is defective - replace
 Installation housing; 3TE, Insta IP 20
 -40 °C...85 °C
 ≤ 4000 m

1.5...16 mm²
 1.5...35 mm²
 18 mm
 3...4.5 Nm

CE; cURus; VDE
 IEC 61643-11, EN 61643-11, UL 1449

Dimensions / Remote signalling contact info

Clamping range (nominal / min. / max.) mm²
 Height x width x depth mm
 Signalling contact

Note

no remote sig. contact with remote signalling (R)

16 / 1.5 / 35 16 / 1.5 / 35
 90 / 18 / 91 104.5 / 18 / 91
 No 250 V 1A 1CO

Wire-end ferrules must be used when connecting finely stranded wire.

no remote sig. contact with remote signalling (R)

16 / 1.5 / 35 16 / 1.5 / 35
 90 / 54 / 91 104.5 / 54 / 91
 No 250 V 1A 1CO

Wire-end ferrules must be used when connecting finely stranded wire.

Ordering data

without remote signalling contact
 with remote signalling contact (R)

Type	Qty.	Order No.
VPU AC I 1 480/10	1	2591510000
VPU AC I 1 R 480/10	1	2591520000

Type	Qty.	Order No.
VPU AC I 3 480/10	1	2591530000
VPU AC I 3 R 480/10	1	2591540000

Note

Accessories

Note

Pluggable spare arrester L-N: VPU AC I 0 480/10 - 2591500000

Pluggable spare arrester L-N: VPU AC I 0 480/10 - 2591500000





Type I - 10 kA / 480 V

- Back-up fuse not necessary up to 315 A
- Pluggable arrester
- Tested according to IEC/EN61643-11 as Type I and Type II

VPU AC I 4 (R) 480/10

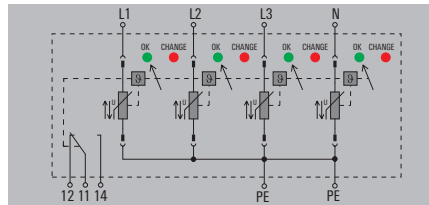

Technical data

Requirements category acc. to IEC/EN 61643-11
 Energy coordination (≤ 10 m)
 Rated voltage (AC)
 Max. continuous voltage, U_c (L-N / N-PE)
 Low voltage network
 Lightning test current I_{imp} (10/350 μ s) (L-PE / N-PE)
 Discharge current I_n (8/20 μ s) (Ader-PE / N-PE)
 Discharge current I_{max} (8/20 μ s) (Ader-PE / N-PE)
 Protection level U_p at I_n (L/N-PE)
 Protection level U_p at I_n (N-PE)
 Fuse

Short-circuit current rating I_{scCR}
 Temporary surge voltage (over-voltage) - TOV
 Response time
 Optical function display
 Design
 Ambient temperature (operational)
 Operating altitude

Connection data

Solid
 Stranded
 Stripping length
 Tightening torque

Approvals

Approvals
 Standards

Type I, Type II / T1, T2
 Type I, Type II, Type III
 400 V
 480 V /
 TN-C-S, TN-S
 10 kA /
 20 kA /
 50 kA /
 ≤ 2.1 kV

No Fuse necessary ≤ 315 A gG, 250 A gG @50 kA I_{scCR} , 315 A gG @25 kA I_{scCR}
 50 kA
 762 V
 ≤ 25 ns
 green = OK; red = arrester is defective - replace
 Installation housing; 4TE, Insta IP 20
 -40 °C...85 °C
 ≤ 4000 m

1.5...16 mm²
 1.5...35 mm²
 18 mm
 3...4.5 Nm

CE; cURus; VDE
 IEC 61643-11, EN 61643-11, UL 1449

Dimensions / Remote signalling contact info

Clamping range (nominal / min. / max.) mm²
 Height x width x depth mm
 Signalling contact

Note

no remote sig. contact	with remote signalling (R)
16 / 1.5 / 35	16 / 1.5 / 35
90 / 72 / 91	104.5 / 72 / 91
No	250 V 1A 1CO

Wire-end ferrules must be used when connecting finely stranded wire.

Ordering data

without remote signalling contact
 with remote signalling contact (R)

Type	Qty.	Order No.
VPU AC I 4 480/10	1	2591550000
VPU AC I 4 R 480/10	1	2591560000

Note

Accessories

Note

Pluggable spare arrester L-N: VPU AC I 0 480/10 - 2591500000



Type I - N-PE

- Pluggable arrester
- Tested according to IEC 61643-11 for Type I and II surge protection
- Can also be used as Type II surge protection

VPU AC I 1 N-PE 305/100 S

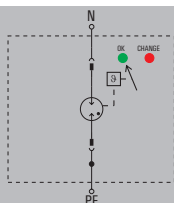

Technical data

Requirements category acc. to IEC/EN 61643-11
 Energy coordination (≤ 10 m)
 Rated voltage (AC)
 Max. continuous voltage, U_c (L-N / N-PE)
 Low voltage network
 Lightning test current I_{imp} (10/350 μ s) (L-PE / N-PE)
 Discharge current I_n (8/20 μ s) (Ader-PE / N-PE)
 Discharge current I_{max} (8/20 μ s) (Ader-PE / N-PE)
 Protection level U_p at I_n (L/N-PE)
 Protection level U_p at I_n (N-PE)
 Fuse
 Short-circuit current rating I_{scCR}
 Temporary surge voltage (over-voltage) - TOV
 Response time
 Optical function display
 Design
 Ambient temperature (operational)
 Operating altitude

Connection data

Solid
 Stranded
 Stripping length
 Tightening torque

Approvals

Approvals
 Standards

Type I, Type II / T1, T2
 Type I, Type II, Type III
 240 V
 / 305 V
 Single-phase, TN, TT nur für N-PE
 / 100 kA
 / 100 kA
 / 150 kA
 ≤ 1.5 kV
 Not required
 0.1 kA
 1200 V
 ≤ 100 ns
 green = OK; red = arrester is defective - replace
 Installation housing; 1TE, Insta IP 20
 -40 °C...85 °C
 ≤ 2000 m

1.5...16 mm²
 1.5...35 mm²
 18 mm
 3...4.5 Nm

CE: VDE
 IEC 61643-11, EN 61643-11, UL 1449

Dimensions / Remote signalling contact info

Clamping range (nominal / min. / max.) mm²
 Height x width x depth mm
 Signalling contact

Note

no remote sig. contact

16 / 1.5 / 35
 90 / 18 / 91
 No

Wire-end ferrules must be used when connecting finely stranded wire.

Ordering data

without remote signalling contact

Type	Qty.	Order No.
VPU AC I 1 N-PE 305/100 S	1	2726800000

Note

Accessories

Note

Pluggable spare arrester N-PE: VPU AC I 0 N-PE 305/100 S 2730850000



Type I - N-PE

- Pluggable arrester
- Tested according to IEC 61643-11 as type I and II surge protection
- Can also be used as type II surge protection

VPU AC I 1 N-PE 305 / 50

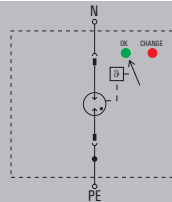

VPU AC I 1 N-PE 305/50 LH

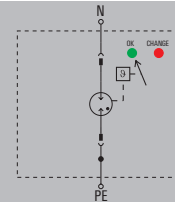

Technical data

Requirements category acc. to IEC/EN 61643-11
Energy coordination (≤10 m)
Rated voltage (AC)
Max. continuous voltage, U_c (L-N / N-PE)
Low voltage network
Lightning test current I_{imp} (10/350 μ s) (L-PE / N-PE)
Discharge current I_n (8/20 μ s) (Ader-PE / N-PE)
Discharge current I_{max} (8/20 μ s) (Ader-PE / N-PE)
Protection level U_p at I_n (L/N-PE)
Protection level U_p at I_n (N-PE)
Rated load current I_L
Fuse
Short-circuit current rating I_{SCCR}
Temporary surge voltage (over-voltage) - TOV
Response time
Optical function display
Design
Ambient temperature (operational)
Operating altitude
Connection data
Solid
Stranded
Stripping length
Tightening torque
Approvals
Approvals
Standards

Type I, Type II / T1, T2
Type I, Type II, Type III
230 V
/ 305 V
Single-phase, TN, TT nur für N-PE
/ 50 kA
/ 50 kA
/ 100 kA
≤ 1.5 kV
100 A
Not required
0.1 kA
1200 V
≤ 100 ns
green = OK; red = arrester is defective - replace
Installation housing; 1TE, Insta IP 20
-40 °C...85 °C
≤ 4000 m
1.5...16 mm ²
1.5...35 mm ²
18 mm
3...4.5 Nm
CE; cURus; VDE
IEC 61643-11, EN 61643-11, UL 1449

Type I, Type II / T1, T2
Type I, Type II, Type III
240 V
/ 305 V
Single-phase, TN, TT nur für N-PE
/ 100 kA
/ 50 kA
/ 100 kA
≤ 1.5 kV
100 A
Not required
0.1 kA
442 V
≤ 100 ns
green = OK; red = arrester is defective - replace
-40 °C...85 °C
≤ 4000 m
1.5...16 mm ²
1.5...35 mm ²
18 mm
3...4.5 Nm
CE; VDE; cURus
IEC 61643-11, EN 61643-11, UL 1449

Dimensions / Remote signalling contact info
Clamping range (nominal / min. / max.)
Height x width x depth
Signalling contact
Note

no remote sig. contact
16 / 1.5 / 35
90 / 18 / 91
No
Wire-end ferrules must be used when connecting finely stranded wire.

no remote sig. contact
16 / 1.5 / 35
90 / 18 / 70
No
Wire-end ferrules must be used when connecting finely stranded wire.

Ordering data

without remote signalling contact

Type	Qty.	Order No.
VPU AC I 1 N-PE 305/50	1	2591570000

Type	Qty.	Order No.
VPU AC I 1 N-PE 305/50 LH	1	3037010000

Note

Accessories

Note

Pluggable spare arrester N-PE: VPU AC I 0 N-PE 305/50 - 2591590000

Pluggable spare arrester N-PE: VPU AC I 0 N-PE 305/50 LH - 2983630000

Protect power grids safely and efficiently against overvoltages

VPU AC type I+II lightning and surge protection for 230/400 V-systems

The growing number of vulnerable devices requires increasingly reliable lightning and surge protection for the power feed-in. For example, in industrial plants, private and public buildings, or in regenerative power plants.

VARIRECTOR PU AC type I+II lightning and surge protection devices are leakage current-free. They can be used in the pre-metering and post-metering range in accordance with VDE-AR-N 4100 and meet the requirements for Type I and II. All devices are energy-coordinated and meet the performance classes T1+T2+T3 according to IEC/EN 61643-11 and VDE 0675-11 with a protection level up to ≤ 1.5 kV. Application-oriented product configurations for different network types are available.

Your special advantages:

- Combined type I+II arrester for a wide range of applications
- Status display and fault signalling for easy maintenance
- High discharge current for universal use in all lightning protection classes

The VPU Monobloc series offers products for the following rated voltages UC (AC):

- 255 V
- 275 V
- 440 V





Variable installation

Thanks to the leakage current-free technology, the arrester can be installed both upstream and downstream of the electricity meter in accordance with VDE-AR-N 4100.

Universally applicable

The high lightning impulse current (10/350 μ s) up to 25 kA enables universal use in all lightning protection classes – from LPL I to LPL IV.



Comprehensively tested

The combined arresters type I+II are tested as lightning protection (test pulse 10/350 μ s) as well as surge protection (test pulse 8/20 μ s).

Status display and fault signalling

Equipped with a clearly visible status window for error signalling directly on the unit as well as with a pluggable remote signalling contact for error signalling to the higher-level control system.



Type I - Leakage current free 25 kA / 275 V

- No-leakage-current version suitable for use upstream of the electrical meter
- Non-pluggable arrester
- Suitable with 25 kA (10/350 μs) for protection levels I, II, III and IV (LPL I/II/III/IV)
- Tested according to IEC 61643-11 for Type I and II surge protection
- Can also be used for Type II surge protection

VPU AC I 1 R 275/25 LCF MB

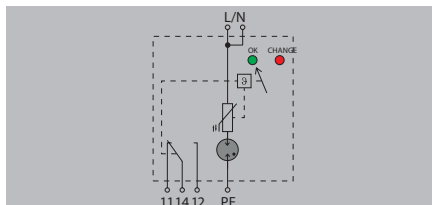

VPU AC I 1+1 R 275/25 LCF MB

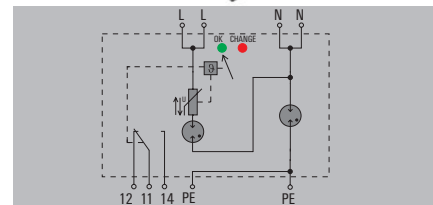

Technical data

Requirements category acc. to IEC/EN 61643-11
Energy coordination (<=10 m)
Rated voltage (AC)
Max. continuous voltage, U _c (L-N / N-PE)
Low voltage network
Lightning test current I _{imp} (10/350 μs) (L-PE / N-PE)
Discharge current I _n (8/20μs) (Ader-PE / N-PE)
Discharge current I _{max} (8/20μs) (Ader-PE / N-PE)
Protection level U _p at I _n (L/N-PE)
Protection level U _p at I _n (N-PE)
Rated load current I _L
Fuse
Short-circuit current rating I _{scCR}
Temporary surge voltage (over-voltage) - TOV
Response time
Optical function display
Design
Ambient temperature (operational)
Operating altitude
Connection data
Solid
Stranded
Stripping length
Tightening torque
Approvals
Approvals
Standards

Type I, Type II / T1, T2
Type I, Type II, Type III
230 V
275 V /
Single-phase, TN
25 kA /
25 kA /
100 kA /
<= 1.5 kV
100 A
No Fuse necessary <=250 A gG, 250 A gL (if main fuse > 250 A)
50 kA
438 V
<= 25 ns
green = OK; red = arrester is defective - replace
Installation housing; 2TE, Insta IP 20
-40 °C...85 °C
<= 2000 m
1.5...16 mm ²
1.5...35 mm ²
18 mm
3...4.5 Nm
CE
IEC 61643-11, EN 61643-11

Type I, Type II / T1, T2
Type I, Type II, Type III
230 V
275 V / 255 V
Single-phase, TN, TT, IT with N, IT without N
25 kA / 50 kA
25 kA / 50 kA
100 kA / 100 kA
<= 1.5 kV
<= 1.5 kV
100 A
No Fuse necessary <=250 A gG, 250 A gL (if main fuse > 250 A)
50 kA
438 V
<= 25 ns
green = OK; red = arrester is defective - replace
Installation housing; 4TE, Insta IP 20
-40 °C...85 °C
<= 2000 m
1.5...16 mm ²
1.5...35 mm ²
18 mm
3...4.5 Nm
CE
IEC 61643-11, EN 61643-11

Dimensions / Remote signalling contact info
Clamping range (nominal / min. / max.)
Height x width x depth
Signalling contact
Note

with remote signalling (R)
16 / 1.5 / 35
99 / 35 / 71
250 V 1A 1CO
Wire-end ferrules must be used when connecting finely stranded wire.

with remote signalling (R)
16 / 1.5 / 35
99 / 70 / 71
250 V 1A 1CO
Wire-end ferrules must be used when connecting finely stranded wire.

Ordering data

with remote signalling contact (R)

Type	Qty.	Order No.
VPU AC I 1 R 275/25 LCF MB	1	2774940000

Type	Qty.	Order No.
VPU AC I 1+1 R 275/25 LCF MB	1	2775000000

Note

Only for IT networks where the earth at the distribution transformer is connected to the earth on the customer side.

Accessories

Note

--



Type I - Leakage current free 25 kA / 275 V

- No-leakage-current version suitable for use upstream of the electrical meter
- Non-pluggable arrester
- Suitable with 25 kA (10/350 μs) for protection levels I, II, III and IV (LPL I/II/III/IV)
- Tested according to IEC 61643-11 for Type I and II surge protection
- Can also be used for Type II surge protection

VPU AC I 2 R 275/25 LCF MB

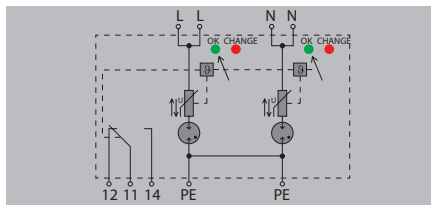

VPU AC I 3 R 275/25 LCF MB

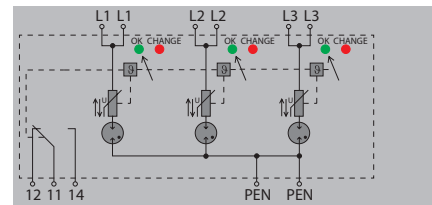

Technical data

Requirements category acc. to IEC/EN 61643-11
 Energy coordination (≤10 m)
 Rated voltage (AC)
 Max. continuous voltage, U_c (L-N / N-PE)
 Low voltage network
 Lightning test current I_{imp} (10/350 μs) (L-PE / N-PE)
 Discharge current I_n (8/20 μs) (Ader-PE / N-PE)
 Discharge current I_{max} (8/20 μs) (Ader-PE / N-PE)
 Protection level U_p at I_n (L/N-PE)
 Protection level U_p at I_n (N-PE)
 Rated load current I_L
 Fuse

Short-circuit current rating I_{scCR}
 Temporary surge voltage (over-voltage) - TOV
 Response time
 Optical function display
 Design
 Ambient temperature (operational)
 Operating altitude

Connection data

Solid
 Stranded
 Stripping length
 Tightening torque

Approvals

Approvals
 Standards

Type I, Type II / T1, T2
 Type I, Type II, Type III
 230 V
 275 V /
 Single-phase, TN-S
 25 kA /
 25 kA /
 100 kA /
 ≤ 1.5 kV

100 A
 No Fuse necessary ≤250 A gG, 250 A gL (if main fuse > 250 A)

50 kA
 438 V
 ≤ 25 ns
 green = OK; red = arrester is defective - replace
 Installation housing: 4TE, Insta IP 20
 -40 °C...85 °C
 ≤ 2000 m

1.5...16 mm²
 1.5...35 mm²
 18 mm
 3...4.5 Nm

CE
 IEC 61643-11, EN 61643-11

Type I, Type II / T1, T2
 Type I, Type II, Type III
 230 V
 275 V /
 TN-C
 25 kA /
 25 kA /
 100 kA /
 ≤ 1.5 kV

100 A
 No Fuse necessary ≤250 A gG, 250 A gL (if main fuse > 250 A)

50 kA
 438 V
 ≤ 25 ns
 green = OK; red = arrester is defective - replace
 Installation housing: 6 TE, Insta IP 20
 -40 °C...85 °C
 ≤ 2000 m

1.5...16 mm²
 1.5...35 mm²
 18 mm
 3...4.5 Nm

CE
 IEC 61643-11, EN 61643-11

Dimensions / Remote signalling contact info

Clamping range (nominal / min. / max.) mm²
 Height x width x depth mm
 Signalling contact

Note

with remote signalling (R)

16 / 1.5 / 35
 99 / 70 / 71
 250 V 1A 1CO

Wire-end ferrules must be used when connecting finely stranded wire.

with remote signalling (R)

16 / 1.5 / 35
 99 / 105 / 71
 250 V 1A 1CO

Wire-end ferrules must be used when connecting finely stranded wire.

Ordering data

with remote signalling contact (R)

Type	Qty.	Order No.
VPU AC I 2 R 275/25 LCF MB	1	2774950000

Type	Qty.	Order No.
VPU AC I 3 R 275/25 LCF MB	1	2774960000

Note

Accessories

Note

Type I - Leakage current free 25 kA / 275 V

- No-leakage-current version suitable for use upstream of the electrical meter
- Non-pluggable arrester
- Suitable with 25 kA (10/350 μs) for protection levels I, II, III and IV (LPL I/II/III/IV)
- Tested according to IEC 61643-11 for Type I and II surge protection
- Can also be used for Type II surge protection

VPU AC I 3+1 R 275/25 LCF MB

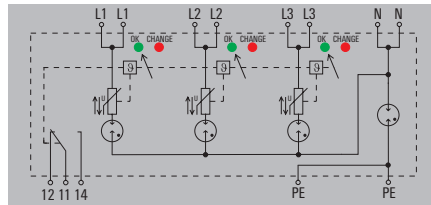

VPU AC I 4 R 275/25 LCF MB

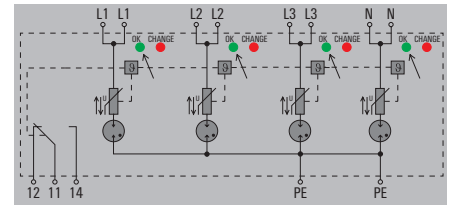

Technical data

Requirements category acc. to IEC/EN 61643-11
 Energy coordination (≤10 m)
 Rated voltage (AC)
 Max. continuous voltage, U_c (L-N / N-PE)
 Low voltage network
 Lightning test current I_{imp} (10/350 μs) (L-PE / N-PE)
 Discharge current I_n (8/20 μs) (Ader-PE / N-PE)
 Discharge current I_{max} (8/20 μs) (Ader-PE / N-PE)
 Protection level U_p at I_n (L/N-PE)
 Protection level U_p at I_n (N-PE)
 Rated load current I_L
 Fuse

Short-circuit current rating I_{scCR}
 Temporary surge voltage (over-voltage) - TOV
 Response time
 Optical function display
 Design
 Ambient temperature (operational)
 Operating altitude

Connection data

Solid
 Stranded
 Stripping length
 Tightening torque

Approvals

Approvals
 Standards

Type I, Type II / T1, T2
 Type I, Type II, Type III
 230 V
 275 V / 255 V
 TN-C-S, TN-S, TT, IT with N, IT without N
 25 kA / 100 kA
 25 kA / 100 kA
 100 kA / 100 kA
 ≤ 1.5 kV
 ≤ 1.5 kV
 100 A
 No Fuse necessary ≤250 A gG, 250 A gL (if main fuse > 250 A)

50 kA
 438 V
 ≤ 25 ns
 green = OK; red = arrester is defective - replace
 Installation housing: 8 TE, Insta IP 20
 -40 °C...85 °C
 ≤ 2000 m

1.5...16 mm²
 1.5...35 mm²
 18 mm
 3...4.5 Nm

CE
 IEC 61643-11, EN 61643-11

Type I, Type II / T1, T2
 Type I, Type II, Type III
 230 V
 275 V /
 TN-C-S, TN-S
 25 kA /
 25 kA /
 100 kA /
 ≤ 1.5 kV
 100 A
 No Fuse necessary ≤250 A gG, 250 A gL (if main fuse > 250 A)

50 kA
 438 V
 ≤ 25 ns
 green = OK; red = arrester is defective - replace
 Installation housing: 8 TE, Insta IP 20
 -40 °C...85 °C
 ≤ 2000 m

1.5...16 mm²
 1.5...35 mm²
 18 mm
 3...4.5 Nm

CE
 IEC 61643-11, EN 61643-11

Dimensions / Remote signalling contact info

Clamping range (nominal / min. / max.) mm²
 Height x width x depth mm
 Signalling contact

Note

with remote signalling (R)

16 / 1.5 / 35
 99 / 144 / 71
 250 V 1A 1CO
 Wire-end ferrules must be used when connecting finely stranded wire.

with remote signalling (R)

16 / 1.5 / 35
 99 / 144 / 71
 250 V 1A 1CO
 Wire-end ferrules must be used when connecting finely stranded wire.

Ordering data

with remote signalling contact (R)

Type	Qty.	Order No.
VPU AC I 3+1 R 275/25 LCF MB	1	2638070000

Type	Qty.	Order No.
VPU AC I 4 R 275/25 LCF MB	1	2774990000

Note

Only for IT networks where the earth at the distribution transformer is connected to the earth on the customer side.

Accessories

Note



Type I - Leakage current free 25 kA / 440 V

- Back-up fuse not necessary up to 250 A
- Leakage current-free design suitable for use in the pre-metering area
- Non-pluggable arrester
- Suitable with 25 kA (10/350µs) for protection levels I, II, III and IV (LPL I/II/III/IV)
- Tested according to IEC/EN61643-11 as Type I and Type II

VPU AC I 1 (R) 440/25 LCF

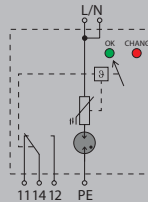

VPU AC I 1+1 (R) 440/25 LCF

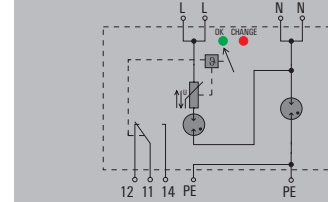

Technical data

Requirements category acc. to IEC/EN 61643-11
 Energy coordination (≤10 m)
 Rated voltage (AC)
 Max. continuous voltage, U_c (L-N / N-PE)
 Low voltage network
 Lightning test current I_{imp} (10/350 µs) (L-PE / N-PE)
 Discharge current I_n (8/20µs) (Ader-PE / N-PE)
 Discharge current I_{max} (8/20µs) (Ader-PE / N-PE)
 Protection level U_p at I_n (L/N-PE)
 Protection level U_p at I_n (N-PE)
 Rated load current I_L
 Fuse

Short-circuit current rating I_{SCCR}
 Temporary surge voltage (over-voltage) - TOV
 Response time
 Optical function display
 Design
 Ambient temperature (operational)
 Operating altitude

Connection data

Solid
 Stranded
 Stripping length
 Tightening torque

Approvals

Approvals
 Standards

Type I, Type II / T1, T2
 Type I, Type II, Type III
 400 V
 440 V /
 Single-phase, TN
 25 kA /
 25 kA /
 100 kA /
 ≤ 2.5 kV
 100 A
 250 A gL (if main fuse > 250 A)

50 kA
 762 V
 ≤ 25 ns
 green = OK; red = arrester is defective - replace
 Installation housing; 2TE, Insta IP 20
 -40 °C...85 °C
 ≤ 2000 m

6...16 mm²
 6...35 mm²
 13 mm
 2...3 Nm

CE
 IEC 61643-11, EN 61643-11

Type I, Type II / T1, T2
 Type I, Type II, Type III
 400 V
 440 V / 440 V
 Single-phase, TN, TT, IT with N, IT without N
 25 kA / 100 kA
 25 kA / 100 kA
 100 kA / 100 kA
 ≤ 2.5 kV
 ≤ 2.5 kV
 100 A
 250 A gL (if main fuse > 250 A)

50 kA
 762 V
 ≤ 25 ns
 green = OK; red = arrester is defective - replace
 Installation housing; 4TE, Insta IP 20
 -40 °C...85 °C
 ≤ 2000 m

6...16 mm²
 6...35 mm²
 13 mm
 2...3 Nm

CE
 IEC 61643-11, EN 61643-11

Dimensions / Remote signalling contact info

Clamping range (nominal / min. / max.) mm²
 Height x width x depth mm
 Signalling contact

Note

no remote sig. contact with remote signalling (R)

16 / 6 / 35 16 / 6 / 35
 90 / 36 / 93 104.5 / 36 / 93
 No 250 V 1A 1CO

Wire-end ferrules must be used when connecting finely stranded wire.

no remote sig. contact with remote signalling (R)

16 / 6 / 35 16 / 6 / 35
 90 / 72 / 93 104.5 / 72 / 93
 No 250 V 1A 1CO

Wire-end ferrules must be used when connecting finely stranded wire.

Ordering data

without remote signalling contact
 with remote signalling contact (R)

Type	Qty.	Order No.
VPU AC I 1 440/25 LCF	1	2619100000
VPU AC I 1 R 440/25 LCF	1	2619120000

Type	Qty.	Order No.
VPU AC I 1+1 440/25 LCF	1	2619210000
VPU AC I 1+1 R 440/25 LCF	1	2619220000

Note

Only for IT networks where the earth at the distribution transformer is connected to the earth on the customer side.

Accessories

Note



Type I - Leakage current free 25 kA / 440 V

- Back-up fuse not necessary up to 250 A
- Leakage current-free design suitable for use in the pre-metering area
- Non-pluggable arrester
- Suitable with 25 kA (10/350µs) for protection levels I, II, III and IV (LPL I/II/III/IV)
- Tested according to IEC/EN61643-11 as Type I and Type II

VPU AC I 2 (R) 440/25 LCF

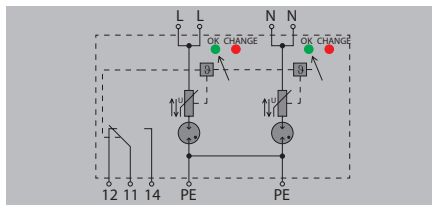

VPU AC I 3 (R) 440/25 LCF

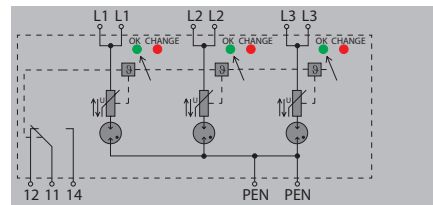

Technical data

Requirements category acc. to IEC/EN 61643-11
 Energy coordination (≤10 m)
 Rated voltage (AC)
 Max. continuous voltage, U_c (L-N / N-PE)
 Low voltage network
 Lightning test current I_{imp} (10/350 µs) (L-PE / N-PE)
 Discharge current I_n (8/20µs) (Ader-PE / N-PE)
 Discharge current I_{max} (8/20µs) (Ader-PE / N-PE)
 Protection level U_p at I_n (L/N-PE)
 Protection level U_p at I_n (N-PE)
 Rated load current I_L
 Fuse

Short-circuit current rating I_{scCR}
 Temporary surge voltage (over-voltage) - TOV
 Response time
 Optical function display
 Design
 Ambient temperature (operational)
 Operating altitude

Connection data

Solid
 Stranded
 Stripping length
 Tightening torque

Approvals

Approvals
 Standards

Type I, Type II / T1, T2
 Type I, Type II, Type III
 400 V
 440 V /
 Single-phase, TN-S
 25 kA /
 25 kA /
 100 kA /
 ≤ 2.5 kV

100 A
 250 A gL (if main fuse > 250 A)

50 kA
 762 V
 ≤ 25 ns
 green = OK; red = arrester is defective - replace
 Installation housing: 4TE, Insta IP 20
 -40 °C...85 °C
 ≤ 2000 m

6...16 mm²
 6...35 mm²
 13 mm
 2...3 Nm

CE
 IEC 61643-11, EN 61643-11

Type I, Type II / T1, T2
 Type I, Type II, Type III
 400 V
 440 V /
 TN-C
 25 kA /
 25 kA /
 100 kA /
 ≤ 2.5 kV

100 A
 250 A gL (if main fuse > 250 A)

50 kA
 762 V
 ≤ 25 ns
 green = OK; red = arrester is defective - replace
 Installation housing: 6 TE, Insta IP 20
 -40 °C...85 °C
 ≤ 2000 m

6...16 mm²
 6...35 mm²
 13 mm
 2...3 Nm

CE
 IEC 61643-11, EN 61643-11

Dimensions / Remote signalling contact info

Clamping range (nominal / min. / max.) mm²
 Height x width x depth mm
 Signalling contact

Note

no remote sig. contact with remote signalling (R)

16 / 6 / 35 16 / 6 / 35
 90 / 72 / 93 104.5 / 72 / 93
 No 250 V 1A 1CO

Wire-end ferrules must be used when connecting finely stranded wire.

no remote sig. contact with remote signalling (R)

16 / 6 / 35 16 / 6 / 35
 90 / 108 / 93 104.5 / 108 / 93
 No 250 V 1A 1CO

Wire-end ferrules must be used when connecting finely stranded wire.

Ordering data

without remote signalling contact
 with remote signalling contact (R)

Type	Qty.	Order No.
VPU AC I 2 440/25 LCF	1	2619130000
VPU AC I 2 R 440/25 LCF	1	2619140000

Type	Qty.	Order No.
VPU AC I 3 440/25 LCF	1	2619160000
VPU AC I 3 R 440/25 LCF	1	2619170000

Note

Accessories

Note



Type I - Leakage current free 25 kA / 440 V

- Back-up fuse not necessary up to 250 A
- Leakage current-free design suitable for use in the pre-metering area
- Non-pluggable arrester
- Suitable with 25 kA (10/350µs) for protection levels I, II, III and IV (LPL I/II/III/IV)
- Tested according to IEC/EN61643-11 as Type I and Type II

VPU AC I 3+1 (R) 440/25 LCF

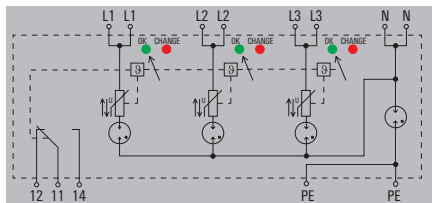

VPU AC I 4 (R) 440/25 LCF

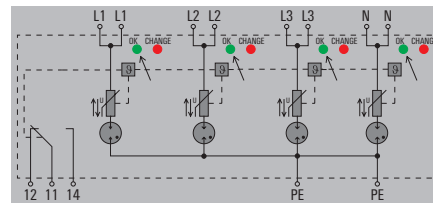

Technical data

Requirements category acc. to IEC/EN 61643-11
 Energy coordination (≤10 m)
 Rated voltage (AC)
 Max. continuous voltage, U_c (L-N / N-PE)
 Low voltage network
 Lightning test current I_{imp} (10/350 µs) (L-PE / N-PE)
 Discharge current I_n (8/20µs) (Ader-PE / N-PE)
 Discharge current I_{max} (8/20µs) (Ader-PE / N-PE)
 Protection level U_p at I_n (L/N-PE)
 Protection level U_p at I_n (N-PE)
 Rated load current I_L
 Fuse

Short-circuit current rating I_{scCR}
 Temporary surge voltage (over-voltage) - TOV
 Response time
 Optical function display
 Design
 Ambient temperature (operational)
 Operating altitude

Connection data

Solid
 Stranded
 Stripping length
 Tightening torque

Approvals

Approvals
 Standards

Type I, Type II / T1, T2
 Type I, Type II, Type III
 400 V
 440 V / 440 V
 TN-C-S, TN-S, TT, IT with N, IT without N
 25 kA / 100 kA
 25 kA / 100 kA
 100 kA / 100 kA
 ≤ 2.5 kV
 ≤ 2.5 kV
 100 A
 250 A gL (if main fuse > 250 A)

50 kA
 762 V
 ≤ 25 ns
 green = OK; red = arrester is defective - replace
 Installation housing: 8 TE, Insta IP 20
 -40 °C...85 °C
 ≤ 2000 m

6...16 mm²
 6...35 mm²
 13 mm
 2...3 Nm

CE
 IEC 61643-11, EN 61643-11

Type I, Type II / T1, T2
 Type I, Type II, Type III
 400 V
 440 V /
 TN-C-S, TN-S
 25 kA /
 25 kA /
 100 kA /
 ≤ 2.5 kV
 ≤ 2.5 kV
 100 A
 250 A gL (if main fuse > 250 A)

50 kA
 762 V
 ≤ 25 ns
 green = OK; red = arrester is defective - replace
 Installation housing: 8 TE, Insta IP 20
 -40 °C...85 °C
 ≤ 2000 m

6...16 mm²
 6...35 mm²
 13 mm
 2...3 Nm

CE
 IEC 61643-11, EN 61643-11

Dimensions / Remote signalling contact info

Clamping range (nominal / min. / max.) mm²
 Height x width x depth mm
 Signalling contact

Note

no remote sig. contact with remote signalling (R)

16 / 6 / 35 16 / 6 / 35
 90 / 144 / 93 104.5 / 144 / 93
 No 250 V 1A 1CO

Wire-end ferrules must be used when connecting finely stranded wire.

no remote sig. contact with remote signalling (R)

16 / 6 / 35 16 / 6 / 35
 90 / 144 / 93 104.5 / 144 / 93
 No 250 V 1A 1CO

Wire-end ferrules must be used when connecting finely stranded wire.

Ordering data

without remote signalling contact
 with remote signalling contact (R)

Type	Qty.	Order No.
VPU AC I 3+1 440/25 LCF	1	2619240000
VPU AC I 3+1 R 440/25 LCF	1	2619260000

Type	Qty.	Order No.
VPU AC I 4 440/25 LCF	1	2619190000
VPU AC I 4 R 440/25 LCF	1	2619200000

Note

Only for IT networks where the earth at the distribution transformer is connected to the earth on the customer side.

Accessories

Note

Type I - Leakage current free 12.5 kA / 255 V

- Back-up fuse not required up to 250 A
- Leakage current-free design suitable for use in the pre-metering area
- Non-pluggable arrester
- Suitable with 12.5 kA for LPL III/IV
- Tested according to IEC/EN61643-11 as type I, II and III
- Innovative spark gap technology

VPU AC I 1+1 (R) 255/12.5 LCF MB

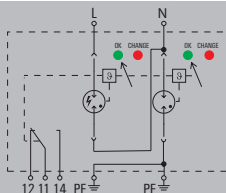

VPU AC I 3 (R) 255/12.5 LCF MB

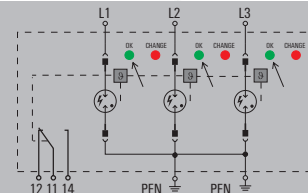

Technical data

Requirements category acc. to IEC/EN 61643-11
 Energy coordination (≤10 m)
 Rated voltage (AC)
 Max. continuous voltage, U_c (L-N / N-PE)
 Low voltage network
 Lightning test current I_{imp} (10/350 μ s) (L-PE / N-PE)
 Discharge current I_n (8/20 μ s) (Ader-PE / N-PE)
 Discharge current I_{max} (8/20 μ s) (Ader-PE / N-PE)
 Protection level U_p at I_n (L/N-PE)
 Protection level U_p at I_n (N-PE)
 Rated load current I_L
 Fuse

Short-circuit current rating I_{scCR}
 Temporary surge voltage (over-voltage) - TOV
 Response time
 Optical function display
 Design
 Ambient temperature (operational)
 Operating altitude

Connection data

Solid
 Stranded
 Stripping length
 Tightening torque

Approvals

Approvals
 Standards

Type I, Type II / T1, T2
 Type I, Type II, Type III
 230 V
 255 V / 305 V
 Single-phase, TN, TT, IT with N, IT without N
 12.5 kA / 50 kA
 20 kA /
 50 kA /
 ≤ 1.5 kV
 ≤ 1.5 kV

No Fuse necessary ≤250 A gG

25 kA
 442 V
 <100 ns
 green = OK; red = arrester is defective - replace
 Installation housing; 2TE, Insta IP 20
 -40 °C...85 °C
 ≤ 4000 m

1.5...16 mm²
 1.5...35 mm²
 18 mm
 3...4.5 Nm

CE; VDE
 IEC 61643-11, EN 61643-11

Type I, Type II / T1, T2
 Type I, Type II, Type III
 230 V
 255 V /
 TN-C
 12.5 kA /
 20 kA /
 50 kA /
 ≤ 1.5 kV

No Fuse necessary ≤250 A gG

25 kA
 442 V
 <100 ns
 green = OK; red = arrester is defective - replace
 Installation housing; 4TE, Insta IP 20
 -40 °C...85 °C
 ≤ 4000 m

1.5...16 mm²
 1.5...35 mm²
 18 mm
 3...4.5 Nm

CE; VDE
 IEC 61643-11, EN 61643-11

Dimensions / Remote signalling contact info

Clamping range (nominal / min. / max.) mm²
 Height x width x depth mm
 Signalling contact

Note

no remote sig. contact with remote signalling (R)

16 / 1.5 / 35 16 / 1.5 / 35
 90 / 36 / 65 105 / 36 / 65
 No 250 V 1A 1CO

Wire-end ferrules must be used when connecting finely stranded wire.

no remote sig. contact with remote signalling (R)

16 / 1.5 / 35 16 / 1.5 / 35
 90 / 72 / 65 105 / 72 / 65
 No 250 V 1A 1CO

Wire-end ferrules must be used when connecting finely stranded wire.

Ordering data

without remote signalling contact
 with remote signalling contact (R)

Type	Qty.	Order No.
VPU AC I 1+1 255/12.5 LCF MB	1	2976580000
VPU AC I 1+1 R 255/12.5 LCF MB	1	2976590000

Type	Qty.	Order No.
VPU AC I 3 255/12.5 LCF MB	1	2976600000
VPU AC I 3 R 255/12.5 LCF MB	1	2976610000

Note

Only for IT networks where the earth at the distribution transformer is connected to the earth on the customer side.

Accessories

Note



Type I - Leakage current free 12.5 kA / 255 V

- Back-up fuse not required up to 250 A
- Leakage current-free design suitable for use in the pre-metering area
- Non-pluggable arrester
- Suitable with 12.5 kA for LPL III/IV
- Tested according to IEC/EN61643-11 as type I, II and III
- Innovative spark gap technology

VPU AC I 3+1 (R) 255/12.5 LCF MB

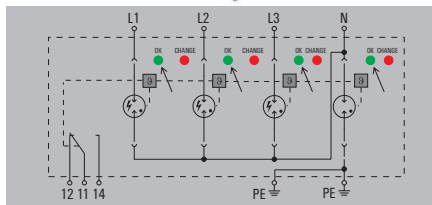

VPU AC I 4 (R) 255/12.5 LCF MB

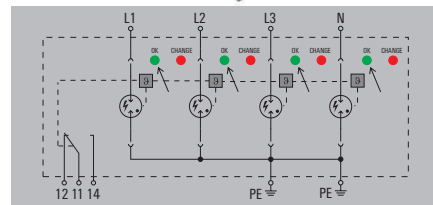

Technical data

Requirements category acc. to IEC/EN 61643-11
 Energy coordination (≤10 m)
 Rated voltage (AC)
 Max. continuous voltage, U_c (L-N / N-PE)
 Low voltage network
 Lightning test current I_{imp} (10/350 μ s) (L-PE / N-PE)
 Discharge current I_n (8/20 μ s) (Ader-PE / N-PE)
 Discharge current I_{max} (8/20 μ s) (Ader-PE / N-PE)
 Protection level U_p at I_n (L/N-PE)
 Protection level U_p at I_n (N-PE)
 Rated load current I_L
 Fuse

Short-circuit current rating I_{scCR}
 Temporary surge voltage (over-voltage) - TOV
 Response time
 Optical function display
 Design
 Ambient temperature (operational)
 Operating altitude

Connection data

Solid
 Stranded
 Stripping length
 Tightening torque

Approvals

Approvals
 Standards

Type I, Type II / T1, T2
 Type I, Type II, Type III
 230 V
 255 V / 305 V
 TN-C-S, TN-S, TT, IT with N, IT without N
 12.5 kA / 50 kA
 20 kA /
 50 kA /
 ≤ 1.5 kV
 ≤ 1.5 kV

No Fuse necessary ≤250 A gG

25 kA
 442 V
 <100 ns
 green = OK; red = arrester is defective - replace
 Installation housing: 4TE, Insta IP 20
 -40 °C...85 °C
 ≤ 4000 m

1.5...16 mm²
 1.5...35 mm²
 18 mm
 3...4.5 Nm

CE; VDE
 IEC 61643-11, EN 61643-11

Type I, Type II / T1, T2
 Type I, Type II, Type III
 230 V
 255 V /
 TN-C-S, TN-S
 12.5 kA /
 20 kA /
 50 kA /
 ≤ 1.5 kV
 ≤ 1.5 kV

No Fuse necessary ≤250 A gG

25 kA
 442 V
 <100 ns
 green = OK; red = arrester is defective - replace
 Installation housing: 4TE, Insta IP 20
 -40 °C...85 °C
 ≤ 4000 m

1.5...16 mm²
 1.5...35 mm²
 18 mm
 3...4.5 Nm

CE; VDE
 IEC 61643-11, EN 61643-11

Dimensions / Remote signalling contact info

Clamping range (nominal / min. / max.) mm²
 Height x width x depth mm
 Signalling contact

Note

no remote sig. contact with remote signalling (R)

16 / 1.5 / 35	16 / 1.5 / 35
90 / 72 / 65	105 / 72 / 65
No	250 V 1A 1CO

Wire-end ferrules must be used when connecting finely stranded wire.

no remote sig. contact with remote signalling (R)

16 / 1.5 / 35	16 / 1.5 / 35
90 / 72 / 65	105 / 72 / 65
No	250 V 1A 1CO

Wire-end ferrules must be used when connecting finely stranded wire.

Ordering data

without remote signalling contact
 with remote signalling contact (R)

Type	Qty.	Order No.
VPU AC I 3+1 255/12.5 LCF MB	1	2976620000
VPU AC I 3+1 R 255/12.5 LCF MB	1	2976630000

Type	Qty.	Order No.
VPU AC I 4 255/12.5 LCF MB	1	2976640000
VPU AC I 4 R 255/12.5 LCF MB	1	2976650000

Note

Only for IT networks where the earth at the distribution transformer is connected to the earth on the customer side.

Accessories

Note

VARITECTOR ZPA S Portfolio

Compact surge protection for 40 mm busbars

Surge protection is a mandatory component in all commercial and private real estate according to DIN VDE 0100-443 und -534. The space-saving installation on the 40 mm rail system guarantees the best protection with the smallest space requirement.

The VARITECTOR ZPA S provides optimum protection against lightning and surge voltage damage in a width of only 36 mm. It combines type I, II, and III arresters in one unit and can be integrated without screws on three-phase busbars with separate PE connection. Product variants with two fused voltage taps enable the accommodation of additional applications. An optional signal output reports the protection status.

Your special advantages:

- Space-saving design with a width of only 36 mm
- Available for network types TN-C, TN-S, TT or IT
- Variants with 12.5 kA and 7.5 kA discharge current
- Combined type I, II and III arrester in one product
- Installation in the pre-metering area according to application rule VDE-AR-N 4100

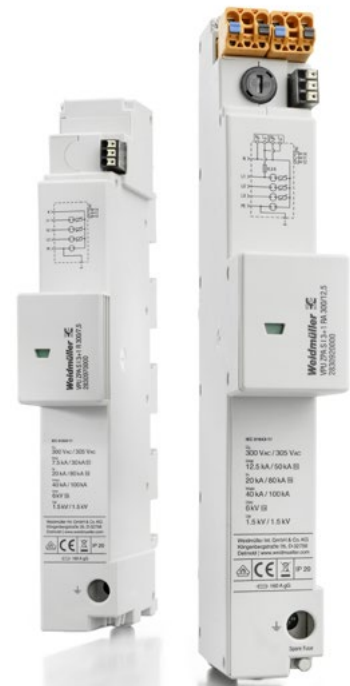

V-ZPA Terminal

Convenient feed-in for building installations

The five-pole V-ZPA Terminal feed-in adapters comply with all VDE-AR-N 4100 specifications. They simplify the feed-in in the lower connection compartment and can be installed on 40 mm busbars to save space. The ZPA S surge protection and the feed-in adapter can be easily installed in confined spaces - for example between two SLS switches.



V-ZPA Fuse Holder E

Optimal protection for smart metering systems

For simple protection of intelligent metering systems such as gateways, control boxes or control units for remote shutdowns, the fuse module V-ZPA Fuse Holder E provides two standard-compliant voltage taps.

They are installed according to the specifications of VDE-AR-N 4100 in the mains-side connection compartment. The devices complement the smart metering range and guarantee optimum protection with a small footprint.



Space-saving design

Due to its overall width, the ZPA S surge protection and the V-ZPA Terminal feed-in adapter can also be combined with 2 SLS switches. All requirements of VDE-AR-N 4100 are met.

Simple fuse protection

With the V-ZPA Fuse Holder E, two voltage taps can be used to devices from the smart metering sector can be fused and supplied with voltage.

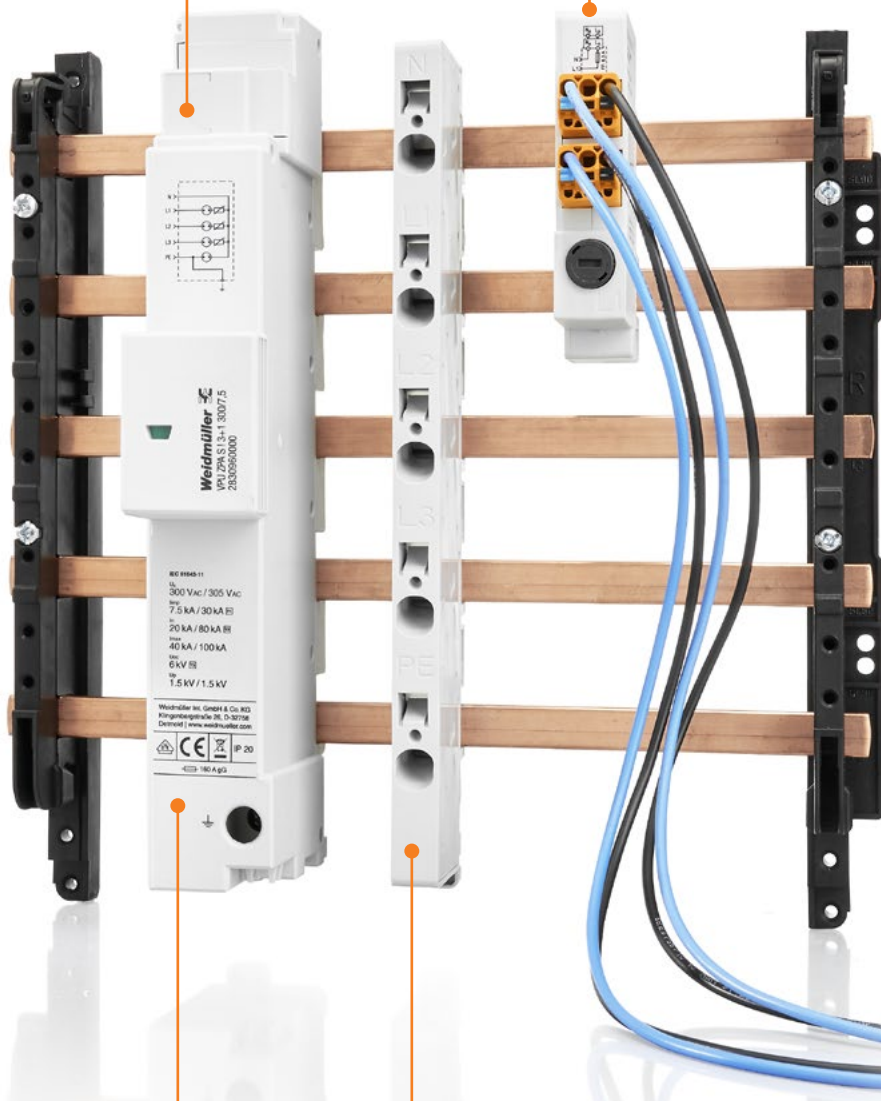

Quick installation

The modules are snapped onto the pre-meter area quickly, easily and without tools. Tool-free installation increases safety and efficiency.

High connection reliability

Due to the permanently secure connection, regular maintenance in the sealed area is unnecessary



Type I – for the busbar

- Simple and safe to use and install
- Compact and slim design
- Complete and permanent status control
- Leakage current-free surge protection
- Available with discharge capacity I_{imp} of 7.5 kA or 12.5 kA
- Optional with remote signalling function
- Optional with two fused voltage taps

VPU ZPA S I 3 (R/RA) 300/12,5

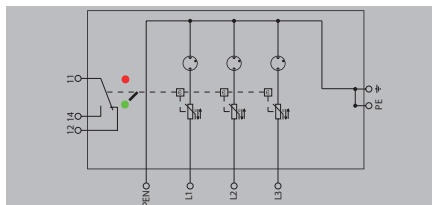

VPU ZPA S I 3+1 (R/RA) 300/12,5

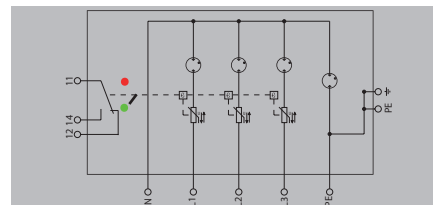

Technical data

Rated voltage (AC)
 Max. continuous voltage, U_c (AC)
 Lightning test current, I_{imp} (10/350 μ s) (N-PE)
 Lightning test current I_{imp} (10/350 μ s) (L-PE)
 Discharge current I_n (8/20 μ s) (wire-PE / N-PE)
 Discharge current I_{max} (8/20 μ s) (wire-PE / N-PE)
 Requirements class, acc. to EN 61643-11
 Short-circuit current rating I_{SCCR}
 Low voltage network
 Fuse
 Temporary surge voltage (over-voltage) - TOV
 Protection level U_p at I_{n1} (L/N-PE)
 Protection level U_p at I_{n2} (N-PE)
 Response time
 Optical function display
 Design
 Colour
 Ambient temperature (operational)

240 V
 300 V
 12.5 kA
 20 kA /
 40 kA /
 T1, T2, T3
 25 kA
 TN-C
 No Fuse necessary ≤ 160 A gG
 442 V
 ≤ 1.5 kV
 ≤ 100 ns
 green = OK; red = arrester is defective - replace
 for 40mm busbars
 grey
 -40 °C...85 °C

240 V
 300 V
 50 kA
 12.5 kA
 20 kA / 80 kA
 40 kA / 100 kA
 T1, T2, T3
 25 kA
 TN-C-S, TN-S, TT, IT with N
 No Fuse necessary ≤ 160 A gG
 442 V
 ≤ 1.5 kV
 ≤ 1.5 kV
 ≤ 100 ns
 green = OK; red = arrester is defective - replace
 for 40mm busbars
 grey
 -40 °C...85 °C

Connection data

Stranded
Approvals
 Approvals
 Standards

16...35 mm²
 CE; VDE
 IEC 61643-11, EN 61643-11

16...35 mm²
 CE; VDE
 IEC 61643-11, EN 61643-11

Dimensions

Clamping range (nominal / min. / max.) mm²
 Height x width x depth mm
 Signalling contact

no remote sig. contact

16 / 4 / 35
 230.6 / 36 / 101.6
 No

no remote sig. contact

16 / 4 / 35
 230.6 / 36 / 101.6
 No

Ordering data

without remote signalling contact
 with remote signalling contact (R)
 with auxiliary and remote signalling contact (RA)

Type	Qty.	Order No.
VPU ZPA S I 3 300/12,5	1	2830870000
VPU ZPA S I 3 R 300/12,5	1	2830880000
VPU ZPA S I 3 RA 300/12,5	1	2830890000

Type	Qty.	Order No.
VPU ZPA S I 3+1 300/12,5	1	2830900000
VPU ZPA S I 3+1 R 300/12,5	1	2830910000
VPU ZPA S I 3+1 RA 300/12,5	1	2830920000

Note
 A: Auxiliary contact, Push In, fused with 6.3 A (5x20 mm); R: Remote signalling function, 1CD 250 V / 1 A AC or 24 V / 0.5 A DC

Note
 A: Auxiliary contact, Push In, fused with 6.3 A (5x20 mm); R: Remote signalling function, 1CD 250 V / 1 A AC or 24 V / 0.5 A DC

Accessories

Note



Type I - for the busbar

- Simple and safe to use and install
- Compact and slim design
- Complete and permanent status control
- Leakage current-free surge protection
- Available with discharge capacity I_{imp} of 7.5 kA or 12.5 kA
- Optional with remote signalling function
- Optional with two fused voltage taps

VPU ZPA S I 3 (R/RA) 300/7,5

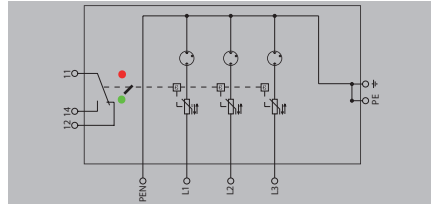

VPU ZPA S I 3+1 (R/RA) 300/7,5

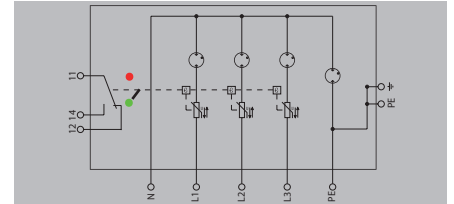

Technical data

Rated voltage (AC)
 Max. continuous voltage, U_c (AC)
 Lightning test current, I_{imp} (10/350 μ s) (N-PE)
 Lightning test current I_{imp} (10/350 μ s) (L-PE)
 Discharge current I_n (8/20 μ s) (wire-PE / N-PE)
 Discharge current I_{max} (8/20 μ s) (wire-PE / N-PE)
 Requirements class, acc. to EN 61643-11
 Short-circuit current rating I_{SCCR}
 Low voltage network
 Fuse
 Temporary surge voltage (over-voltage) - TOV
 Protection level U_p at I_{n1} (L/N-PE)
 Protection level U_p at I_{n2} (N-PE)
 Response time
 Optical function display
 Design
 Colour
 Ambient temperature (operational)

Connection data

Stranded

Approvals

Approvals
 Standards

240 V
 300 V
 7.5 kA
 20 kA /
 40 kA /
 T1, T2, T3
 25 kA
 TN-C
 No Fuse necessary ≤ 160 A gG
 442 V
 ≤ 1.5 kV
 ≤ 100 ns
 green = OK; red = arrester is defective - replace
 for 40mm busbars
 grey
 -40 °C...85 °C
 16...35 mm²
 CE; VDE
 IEC 61643-11, EN 61643-11

240 V
 300 V
 30 kA
 7.5 kA
 20 kA / 80 kA
 40 kA / 100 kA
 T1, T2, T3
 25 kA
 TN-C-S, TN-S, TT, IT with N
 No Fuse necessary ≤ 160 A gG
 442 V
 ≤ 1.5 kV
 ≤ 1.5 kV
 ≤ 100 ns
 green = OK; red = arrester is defective - replace
 for 40mm busbars
 grey
 -40 °C...85 °C
 16...35 mm²
 CE; VDE
 IEC 61643-11, EN 61643-11

Dimensions

Clamping range (nominal / min. / max.) mm²
 Height x width x depth mm
 Signalling contact

Note

no remote sig. contact

16 / 4 / 35
 230.6 / 36 / 101.6
 No

no remote sig. contact

16 / 4 / 35
 230.6 / 36 / 101.6
 No

Ordering data

without remote signalling contact
 with remote signalling contact (R)
 with auxiliary and remote signalling contact (RA)

Note

Type	Qty.	Order No.
VPU ZPA S I 3 300/7,5	1	2830930000
VPU ZPA S I 3 R 300/7,5	1	2830940000
VPU ZPA S I 3 RA 300/7,5	1	2830950000

A: Auxiliary contact, Push In, fused with 6.3 A (5x20 mm); R: Remote signalling function, 1CD 250 V / 1 A AC or 24 V / 0.5 A DC

Type	Qty.	Order No.
VPU ZPA S I 3+1 300/7,5	1	2830960000
VPU ZPA S I 3+1 R 300/7,5	1	2830970000
VPU ZPA S I 3+1 RA 300/7,5	1	2830980000

A: Auxiliary contact, Push In, fused with 6.3 A (5x20 mm); R: Remote signalling function, 1CD 250 V / 1 A AC or 24 V / 0.5 A DC

Accessories

Note



V-ZPA Zubehör für die Sammelschiene

- Fuse Holder for 40 mm busbar
- Power supply adapter for V-ZPS S series

V-ZPA FUSE HOLDER E



V-ZPA TERMINAL



Technical data

Rated voltage (AC)	240 V	240 V
Rated current I _n	6.3 A	101 A
Fuse	6.3 A	NH00, 100 A gG
Short-circuit current rating I _{scCR}	25 kA	
Optical function display	No	No
Design	Adapter plug	Adapter plug
Colour	grey	grey
Ambient temperature (operational)	-25 °C...55 °C	-25 °C...55 °C
Operating altitude	≤ 4000 m	≤ 2000 m
Connection data		
Solid	0.82...2.5 mm ²	1.5...25 mm ²
Stranded	0.82...2.5 mm ²	1.5...25 mm ²
Flexible	0.82...2.5 mm ²	1.5...25 mm ²
Stripping length	13 mm	18 mm
Approvals		
Approvals		VDE
Standards	IEC 61984	

Dimensions / Remote signalling contact info			
Clamping range (nominal / min. / max.)	mm ²	2.5 / 0.82 / 2.5	6 / 1.5 / 25
Height x width x depth	mm	92.2 / 18.5 / 65.5	220.4 / 12.5 / 54.3
Signalling contact		No	No
Note			

Ordering data

Type	Qty.	Order No.	Type	Qty.	Order No.
V-ZPA FUSE HOLDER E	1	3038720000	V-ZPA TERMINAL	1	2904470000

Note		
-------------	--	--

Accessories

Note	Wire accessories can be found on our website in the Smart Metering section.
-------------	-----------------------------------------------------------------------------



VPU AC II surge protection

VARITECTOR PU AC provides safety with efficient surge protection

With increasing digitalisation, an increasingly sensitive infrastructure of intelligent devices and systems is emerging. As a result, surge protection is becoming considerably more important in all application areas and industries.

Ever more efficient overvoltage protection solutions are required, especially in energy supply areas like renewable energy generation, process industry, and building infrastructure. They enable fuseless operation up to 315 A, are certified according to UL 1449 and convince with particularly efficient design.

The VPU AC II series offers products for the following nominal voltages (AC):

- 48 V
- 120 V
- 230 V
- 400 V
- 690 V
- 830 V



**Fuseless
operation
up to 315 A**

Global applicable

Certification in accordance with international IEC/EN standards and the latest UL 1449 standard guarantees universal use in any application.

Complete status control

All products of the VPU AC series have optical signaling. Variants with a pre-warning display enable uninterrupted protection. The remote signaling output indicates the pre-warning status.



High performance

The specially developed disconnection mechanism enables safe operation with high fuse ratings up to 315 A for type I and II products. UL classification as 1CA/2CA allows use in the most demanding application classes.

Extended N/PE protection

N/PE surge arresters in product variants VPU AC 3+1 and VPU AC 1+1 indicate the status of the protective element and transmit it via the remote signaling output.

Surge protection for low-voltage consumer installations and electronics

Surge protection of Type II

Weidmüller VPU AC II surge protection products protect low-voltage consumer installations and electronic devices against surge voltages that can occur as a result of atmospheric discharges (thunderstorms) or switching operations (transients).

The VPU AC II series satisfies the type II requirements of IEC 61643-11 and type 2 requirements of EN 61643-11.

Electrical connection

VPU AC II surge protection is connected with the shortest possible cables between the phase conductors (L1, L2, L3) or the neutral conductor (N) and the earthing of the consumer system.



Routing unprotected lines (e.g. lines to the meter) in parallel with protected lines must be avoided.

The universal „3+1“ circuit for the TN or TT network is available from the Weidmüller delivery programme.

The VPU AC II surge protection is available as a compact module with 1, 2, 3 or 4 poles, with the PE connections already internally connected within the module.

The following rated voltage variants are available:

U_n : 48 V AC = U_c : 75 V

U_n : 120/230 V AC = U_c : 150 V

U_n : 230/400 V AC = U_c : 300 V and 350 V

U_n : 400/690 V AC = U_c : 480 V

U_n : 750/1200 V AC = U_c : 750 V and 1.000 V

The VPU AC II series is selected according to voltage ($U_n \leq U_c$) and number of arresters due to different mains systems. National regulations and safety guidelines must be observed, see IEC 60364-5-53 and/or DIN VDE 0100 T.534

Function control, maintenance and approvals

The VPU AC II surge protection modules are visually inspected. Visual inspection is simple because the arrester is equipped with a thermal cut-off mechanism. If this has responded, i.e. no protection remains, the colour in the display window changes from green to red.



An arrester that is no longer functional can be replaced by a specialist without disconnecting the wiring. The pluggable varistor upper parts are voltage coded. So only the suitable replacement varistor can be plugged in.

Advanced Status Indication (ASI)

The VPU AC II Y series is equipped with ASI – Advanced Status Indication technology. The yellow status signal indicates that the product is approaching its performance limit due to frequent overvoltages. Your system is still protected because the arrester units are redundant with two varistors. If a varistor fails, full protection is still available. This status is signaled by means of a yellow display in the status window and at the remote signaling contact. Only when showing the red status the arrester is completely disconnected from the power grid.



Connection

The cross-section of the earth conductor is in accordance with the national requirements of the standards. The fuse protection for the VPU AC II modules is selected depending on the conductor cross-section and the type of installation. If the main fuse is smaller than 315 A, no additional back-up fuse is required before the surge protection.

VPU AC II series arresters from Weidmüller are suitable for the following cross-sections:

solid wire: 2.5...16 mm²

stranded wire: 2.5...35 mm²

flexible: 2.5...25 mm²

The operating temperature range is -40 °C...+85 °C.

Remote signalling contact (R)

All modules of the VPU AC II series are available with the option of a remote signalling contact which is integrated directly in the module.

This potential-free contact should be connected as a changeover contact using a PUSH IN plug connection.

Dimensional drawing VPU AC II series

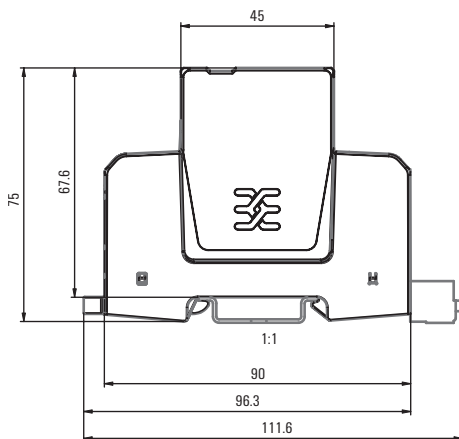

Overall width

VPU AC II, single-pole, 18 mm

VPU AC II, two-pole, 36 mm

VPU AC II, three-pole, 54 mm



VPU AC II, four-pole, 72 mm

Coordination with other arresters

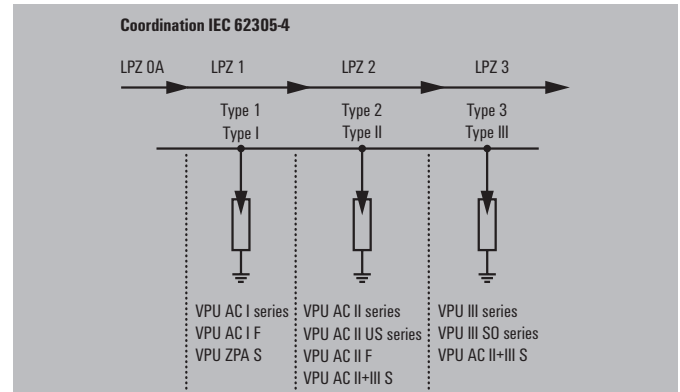
The VPU AC II series can be installed to the following Weidmüller surge protectors without decoupling.



Accessories: Remote signalling contact and locking clip

Type	Remote signalling contact	PLUG VPU AC	285530000
			
	Locking clip	VPU Locking Clip S	273508000



Surge protection Type II – VPU AC II series

Type II - 75 V / 50 kA

- Back-up fuse not necessary up to 315 A
- Pluggable, coded arrester
- High energy absorption with short response time
- No follow current
- Installation in the distribution board
- Co-ordination with VPU AC Typ I and Typ III

VPU AC II 1 (R) 75/50

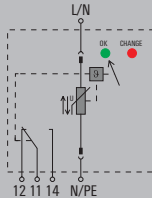

VPU AC II 2 (R) 75/50

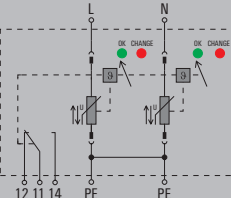

Technical data

Requirements category acc. to IEC/EN 61643-11
 Energy coordination (≤ 10 m)
 Rated voltage (AC)
 Max. continuous voltage, U_c (L-N / N-PE)
 Low voltage network
 Discharge current I_n (8/20 μ s) (Ader-PE / N-PE)
 Discharge current I_{max} (8/20 μ s) (Ader-PE / N-PE)
 Protection level U_p at I_n (L/N-PE)
 Protection level U_p at I_n (N-PE)
 Fuse

Short-circuit current rating I_{scCR}
 Temporary surge voltage (over-voltage) - TOV
 Response time
 Optical function display
 Design
 Ambient temperature (operational)
 Operating altitude

UL values

Category
 Rated Voltage U_n
 Max. continuous voltage MCOV (L-L / L-N / L-G / N-G)
 Protection level VPR (L-L / L-N / L-G / N-G)
 SCCR
 I_n
 UL Energy Networks

Connection data

Solid / Stranded
 Stripping length
 Tightening torque

Approvals

Approvals
 Standards

Dimensions / Remote signalling contact info

Clamping range (nominal / min. / max.) mm²
 Height x width x depth mm
 Signalling contact

Note

Type II, Type III / T2, T3

Type II, Type III

48 V

75 V /

Single-phase, TN

20 kA /

50 kA /

≤ 0.8 kV

No Fuse necessary ≤ 315 A gG, 250 A gG @50 kA Isccr, 315 A gG @25 kA Isccr

50 kA

114 V

≤ 25 ns

green = OK; red = arrester is defective - replace

Installation housing; 1TE, Insta IP 20

-40 °C...85 °C

≤ 4000 m

SPD TYPE 1CA

60 V

/ / 75 V /

/ / 330 V /

100 kA

20 kA

Split-Phase

1.5...16 mm² / 1.5...35 mm²

18 mm

3...4.5 Nm

CE; cURus; VDE

IEC 61643-11, EN 61643-11, UL 1449

no remote sig. contact

with remote signalling (R)

16 / 1.5 / 35

16 / 1.5 / 35

90 / 18 / 68

111 / 18 / 68

No

250 V 1A 1CO

Wire-end ferrules must be used when connecting finely stranded wire.

Type II, Type III / T2, T3

Type II, Type III

48 V

75 V /

Single-phase, TN-S

20 kA /

50 kA /

≤ 0.8 kV

No Fuse necessary ≤ 315 A gG, 250 A gG @50 kA Isccr, 315 A gG @25 kA Isccr

50 kA

114 V

≤ 25 ns

green = OK; red = arrester is defective - replace

Installation housing; 2TE, Insta IP 20

-40 °C...85 °C

≤ 4000 m

SPD TYPE 1CA

60 V

/ 150 V / 75 V / 75 V

/ 700 V / 330 V / 330 V

100 kA

20 kA

Split-Phase

1.5...16 mm² / 1.5...35 mm²

18 mm

3...4.5 Nm

CE; cURus; VDE

IEC 61643-11, EN 61643-11, UL 1449

no remote sig. contact

with remote signalling (R)

16 / 1.5 / 35

16 / 1.5 / 35

90 / 36 / 68

104.5 / 36 / 68

No

250 V 1A 1CO

Wire-end ferrules must be used when connecting finely stranded wire.

Ordering data

without remote signalling contact
 with remote signalling contact (R)

Type	Qty.	Order No.
VPU AC II 1 75/50	1	2636990000
VPU AC II 1 R 75/50	1	2591620000

Type	Qty.	Order No.
VPU AC II 2 75/50	1	2637000000
VPU AC II 2 R 75/50	1	2591630000

Note

Accessories

Note

Pluggable spare arrester L-N: VPU AC II 0 75/50 - 2591610000

Pluggable spare arrester L-N: VPU AC II 0 75/50 - 2591610000

**Type II - 150 V / 50 kA**

- Back-up fuse not necessary up to 315 A
- Pluggable, coded arrester
- High energy absorption with short response time
- No follow current
- Installation in the distribution board
- Co-ordination with VPU AC Typ I and Typ III

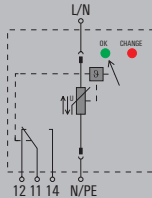
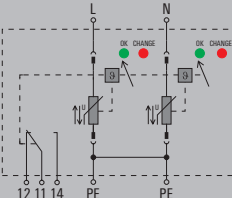
VPU AC II 1 (R) 150/50**VPU AC II 2 (R) 150/50****Technical data**

Requirements category acc. to IEC/EN 61643-11
Energy coordination (≤ 10 m)
Rated voltage (AC)
Max. continuous voltage, U_c (L-N / N-PE)
Low voltage network
Discharge current I_n (8/20 μ s) (Ader-PE / N-PE)
Discharge current I_{max} (8/20 μ s) (Ader-PE / N-PE)
Protection level U_p at I_n (L/N-PE)
Protection level U_p at I_n (N-PE)
Fuse

Short-circuit current rating I_{scCR}
Temporary surge voltage (over-voltage) - TOV
Response time
Optical function display
Design
Ambient temperature (operational)
Operating altitude

UL values

Category
Rated Voltage U_n
Max. continuous voltage MCOV (L-L / L-N / L-G / N-G)
Protection level VPR (L-L / L-N / L-G / N-G)
SCCR
 I_n
UL Energy Networks

Connection data

Solid / Stranded
Stripping length
Tightening torque

Approvals

Approvals
Standards

Dimensions / Remote signalling contact info

Clamping range (nominal / min. / max.) mm²
Height x width x depth mm
Signalling contact

Note

Type II, Type III / T2, T3

Type II, Type III

120 V

150 V /

Single-phase, TN

20 kA /

50 kA /

≤ 1.25 kV

No Fuse necessary ≤ 315 A gG, 250 A gG @50 kA I_{scCR} , 315 A gG @25 kA I_{scCR}

50 kA

229 V

≤ 25 ns

green = OK; red = arrester is defective - replace

Installation housing; 1TE, Insta IP 20

-40 °C...85 °C

≤ 4000 m

SPD TYPE 1CA

120 V

/ / 150 V /

/ / 600 V /

200 kA

20 kA

Split-Phase

1.5...16 mm² / 1.5...35 mm²

18 mm

3...4.5 Nm

CE; cURus; VDE

IEC 61643-11, EN 61643-11, UL 1449

no remote sig. contact

with remote signalling (R)

16 / 1.5 / 35

16 / 1.5 / 35

90 / 18 / 68

104.5 / 18 / 68

No

250 V 1A 1CO

Wire-end ferrules must be used when connecting finely stranded wire.

Type II, Type III / T2, T3

Type II, Type III

120 V

150 V /

Single-phase, TN-S

20 kA /

50 kA /

≤ 1.25 kV

No Fuse necessary ≤ 315 A gG, 250 A gG @50 kA I_{scCR} , 315 A gG @25 kA I_{scCR}

50 kA

229 V

≤ 25 ns

green = OK; red = arrester is defective - replace

Installation housing; 2TE, Insta IP 20

-40 °C...85 °C

≤ 4000 m

SPD TYPE 1CA

120 V

/ 300 V / 150 V / 150 V

/ 1000 V / 600 V / 600 V

200 kA

20 kA

Split-Phase

1.5...16 mm² / 1.5...35 mm²

18 mm

3...4.5 Nm

CE; cURus; VDE

IEC 61643-11, EN 61643-11, UL 1449

no remote sig. contact

with remote signalling (R)

16 / 1.5 / 35

16 / 1.5 / 35

90 / 36 / 68

104.5 / 36 / 68

No

250 V 1A 1CO

Wire-end ferrules must be used when connecting finely stranded wire.

Ordering data

without remote signalling contact
with remote signalling contact (R)

Type	Qty.	Order No.
VPU AC II 1 150/50	1	2591650000
VPU AC II 1 R 150/50	1	2591660000

Type	Qty.	Order No.
VPU AC II 2 150/50	1	2591670000
VPU AC II 2 R 150/50	1	2591680000

Note**Accessories****Note**

Pluggable spare arrester L-N: VPU AC II 0 150/50 - 2591640000

Pluggable spare arrester L-N: VPU AC II 0 150/50 - 2591640000

Surge protection Type II – VPU AC II series

Type II - 150 V / 50 kA

- Back-up fuse not necessary up to 315 A
- Pluggable, coded arrester
- High energy absorption with short response time
- No follow current
- Installation in the distribution board
- Co-ordination with VPU AC Typ I and Typ III

VPU AC II 3 (R) 150/50

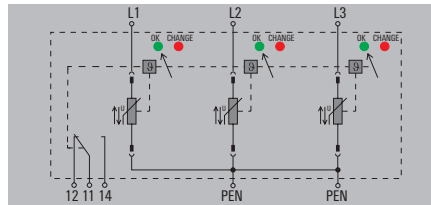

VPU AC II 4 (R) 150/50

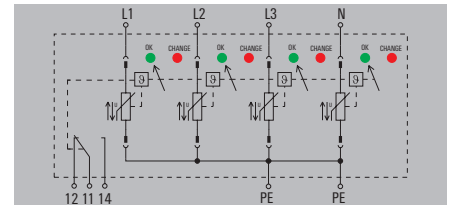

Technical data

Requirements category acc. to IEC/EN 61643-11
 Energy coordination (≤ 10 m)
 Rated voltage (AC)
 Max. continuous voltage, U_c (L-N / N-PE)
 Low voltage network
 Discharge current I_n (8/20 μ s) (Ader-PE / N-PE)
 Discharge current I_{max} (8/20 μ s) (Ader-PE / N-PE)
 Protection level U_p at I_n (L/N-PE)
 Protection level U_p at I_n (N-PE)
 Fuse

Short-circuit current rating I_{scCR}
 Temporary surge voltage (over-voltage) - TOV
 Response time
 Optical function display
 Design
 Ambient temperature (operational)
 Operating altitude

UL values

Category
 Rated Voltage U_n
 Max. continuous voltage MCOV (L-L / L-N / L-G / N-G)
 Protection level VPR (L-L / L-N / L-G / N-G)
 SCCR
 I_n
 UL Energy Networks

Connection data

Solid / Stranded
 Stripping length
 Tightening torque

Approvals

Approvals
 Standards

Dimensions / Remote signalling contact info

Clamping range (nominal / min. / max.) mm²
 Height x width x depth mm
 Signalling contact

Note

Ordering data

without remote signalling contact
 with remote signalling contact (R)

Note

Accessories

Note

Type II, Type III / T2, T3
 Type II, Type III
 120 V
 150 V /
 TN-C
 20 kA /
 50 kA /
 ≤ 1.25 kV

No Fuse necessary ≤ 315 A gG, 250 A gG @50 kA I_{scCR} , 315 A gG @25 kA I_{scCR}

50 kA
 229 V
 ≤ 25 ns
 green = OK; red = arrester is defective - replace
 Installation housing: 3TE, Insta IP 20
 -40 °C...85 °C
 ≤ 4000 m

SPD TYPE 1CA
 120 V
 300 V / / 150 V /
 1000 V / / 600 V /
 200 kA
 20 kA
 3-phase WYE

1.5...16 mm² / 1.5...35 mm²
 18 mm
 3...4.5 Nm

CE; cURus; VDE

no remote sig. contact	with remote signalling (R)
16 / 1.5 / 35	16 / 1.5 / 35
90 / 54 / 68	104.5 / 54 / 68
No	250 V 1A 1CO

Wire-end ferrules must be used when connecting finely stranded wire.

Type	Qty.	Order No.
VPU AC II 3 150/50	1	2591690000
VPU AC II 3 R 150/50	1	2591700000

Pluggable spare arrester L-N: VPU AC II 0 150/50 - 2591640000

Type II, Type III / T2, T3
 Type II, Type III
 120 V
 150 V /
 TN-CS, TN-S
 20 kA /
 50 kA /
 ≤ 1.25 kV

No Fuse necessary ≤ 315 A gG, 250 A gG @50 kA I_{scCR} , 315 A gG @25 kA I_{scCR}

50 kA
 229 V
 ≤ 25 ns
 green = OK; red = arrester is defective - replace
 Installation housing: 4TE, Insta IP 20
 -40 °C...85 °C
 ≤ 4000 m

SPD TYPE 1CA
 120 V
 300 V / 300 V / 150 V / 150 V
 1000 V / 1000 V / 600 V / 600 V
 200 kA
 20 kA
 3-phase WYE

1.5...16 mm² / 1.5...35 mm²
 18 mm
 3...4.5 Nm

CE; cURus; VDE
 IEC 61643-11, EN 61643-11, UL 1449

no remote sig. contact	with remote signalling (R)
16 / 1.5 / 35	16 / 1.5 / 35
90 / 72 / 68	104.5 / 72 / 68
No	250 V 1A 1CO

Wire-end ferrules must be used when connecting finely stranded wire.

Type	Qty.	Order No.
VPU AC II 4 150/50	1	2591710000
VPU AC II 4 R 150/50	1	2591000000

Pluggable spare arrester L-N: VPU AC II 0 150/50 - 2591640000



Type II - 300 V / 50 kA

- Back-up fuse not necessary up to 315 A
- Pluggable, coded arrester class II and III
- High energy absorption with short response time
- No follow current
- Installation in the distribution board
- Co-ordination with VPU AC Typ I and Typ III

VPU AC II 1 (R) 300/50

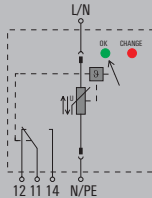

VPU AC II 1+1 (R) 300/50

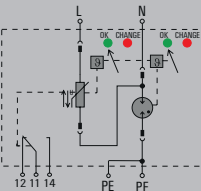

Technical data

Requirements category acc. to IEC/EN 61643-11
 Energy coordination (≤ 10 m)
 Rated voltage (AC)
 Max. continuous voltage, U_c (L-N / N-PE)
 Low voltage network
 Discharge current I_n (8/20 μ s) (Ader-PE / N-PE)
 Discharge current I_{max} (8/20 μ s) (Ader-PE / N-PE)
 Protection level U_p at I_n (L/N-PE)
 Protection level U_p at I_n (N-PE)
 Fuse

Short-circuit current rating I_{scCR}
 Temporary surge voltage (over-voltage) - TOV
 Response time
 Optical function display
 Design
 Ambient temperature (operational)
 Operating altitude

UL values

Category
 Rated Voltage U_n
 Max. continuous voltage MCOV (L-L / L-N / L-G / N-G)
 Protection level VPR (L-L / L-N / L-G / N-G)
 SCCR
 I_n
 UL Energy Networks

Connection data

Solid / Stranded
 Stripping length
 Tightening torque

Approvals

Approvals
 Standards

Dimensions / Remote signalling contact info

Clamping range (nominal / min. / max.) mm²
 Height x width x depth mm
 Signalling contact

Note

Ordering data

without remote signalling contact
 with remote signalling contact (R)

Note

Accessories

Note

Type II, Type III / T2, T3
 Type II, Type III
 230 V
 300 V /
 Single-phase, TN
 20 kA /
 50 kA /
 ≤ 1.5 kV

No Fuse necessary ≤ 315 A gG, 250 A gG @50 kA Isccr, 315 A gG @25 kA Isccr

50 kA
 337 V
 ≤ 25 ns
 green = OK; red = arrester is defective - replace
 Installation housing; 1TE, Insta IP 20
 -40 °C...85 °C
 ≤ 4000 m

SPD TYPE 1CA

240 V
 / / 300 V /
 / / 900 V /
 150 kA
 20 kA
 Split-Phase

1.5...16 mm² / 1.5...35 mm²
 15 mm
 2...4.5 Nm

CE; cURus; VDE
 IEC 61643-11, EN 61643-11, UL 1449

no remote sig. contact with remote signalling (R)

16 / 1.5 / 35	16 / 1.5 / 35
90 / 18 / 68	111 / 18 / 68
No	250 V 1A 1CO

Wire-end ferrules must be used when connecting finely stranded wire.

Type	Qty.	Order No.
VPU AC II 1 300/50	1	2591020000
VPU AC II 1 R 300/50	1	2591030000

Pluggable spare arrester L-N: VPU AC II 0 300/50 - 2591010000

Type II, Type III / T2, T3
 Type II, Type III
 230 V
 300 V / 305 V
 Single-phase, TN, TT, IT with N, IT without N
 20 kA / 40 kA
 50 kA / 65 kA
 ≤ 1.5 kV
 ≤ 1.5 kV

No Fuse necessary ≤ 315 A gG, 250 A gG @50 kA Isccr, 315 A gG @25 kA Isccr

50 kA
 337 V
 ≤ 25 ns
 green = OK; red = arrester is defective - replace
 Installation housing; 2TE, Insta IP 20
 -40 °C...85 °C
 ≤ 4000 m

SPD TYPE 1CA

240 V
 / 600 V / 300 V / 305 V
 / 900 V / 1000 V / 1000 V
 150 kA
 20 kA
 Split-Phase

1.5...16 mm² / 1.5...35 mm²
 15 mm
 2...4.5 Nm

CE; cURus; VDE
 IEC 61643-11, EN 61643-11, UL 1449

no remote sig. contact with remote signalling (R)

16 / 1.5 / 35	16 / 1.5 / 35
90 / 36 / 68	104.5 / 36 / 68
No	250 V 1A 1CO

Wire-end ferrules must be used when connecting finely stranded wire.

Type	Qty.	Order No.
VPU AC II 1+1 300/50	1	2591060000
VPU AC II 1+1 R 300/50	1	2591070000

Only for IT networks where the earth at the distribution transformer is connected to the earth on the customer side.

Pluggable spare arrester L-N: VPU AC II 0 300/50 - 2591010000;
 N-PE: VPU AC I 1 N-PE 305/50 - 2591570000

Surge protection Type II – VPU AC II series

Type II - 300 V / 50 kA

- Back-up fuse not necessary up to 315 A
- Pluggable, coded arrester class II and III
- High energy absorption with short response time
- No follow current
- Installation in the distribution board
- Co-ordination with VPU AC Typ I and Typ III

VPU AC II 2 (R) 300/50

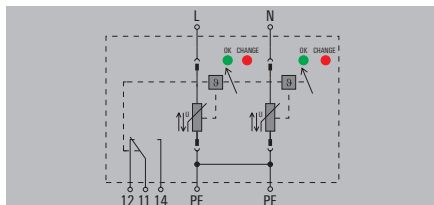

VPU AC II 3 (R) 300/50

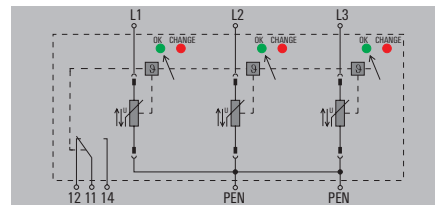

Technical data

Requirements category acc. to IEC/EN 61643-11
 Energy coordination (≤ 10 m)
 Rated voltage (AC)
 Max. continuous voltage, U_c (L-N / N-PE)
 Low voltage network
 Discharge current I_a (8/20 μ s) (Ader-PE / N-PE)
 Discharge current I_{max} (8/20 μ s) (Ader-PE / N-PE)
 Protection level U_p at I_a (L/N-PE)
 Protection level U_p at I_a (N-PE)
 Fuse

Short-circuit current rating I_{scCR}
 Temporary surge voltage (over-voltage) - TOV
 Response time
 Optical function display
 Design
 Ambient temperature (operational)
 Operating altitude

UL values

Category
 Rated Voltage U_n
 Max. continuous voltage MCOV (L-L / L-N / L-G / N-G)
 Protection level VPR (L-L / L-N / L-G / N-G)
 SCCR
 I_a
 UL Energy Networks

Connection data

Solid / Stranded
 Stripping length
 Tightening torque

Approvals

Approvals
 Standards

Dimensions / Remote signalling contact info

Clamping range (nominal / min. / max.) mm²
 Height x width x depth mm
 Signalling contact

Note

Ordering data

without remote signalling contact
 with remote signalling contact (R)

Note

Accessories

Note

Type II, Type III / T2, T3
 Type II, Type III
 230 V
 300 V /
 Single-phase, TN-S
 20 kA /
 50 kA /
 ≤ 1.5 kV

No Fuse necessary ≤ 315 A gG, 250 A gG @50 kA I_{scCR} , 315 A gG @25 kA I_{scCR}

50 kA
 337 V
 ≤ 25 ns
 green = OK; red = arrester is defective - replace
 Installation housing; 2TE, Insta IP 20
 -40 °C... 85 °C
 ≤ 4000 m

SPD TYPE 1CA
 240 V
 / 600 V / 300 V / 300 V
 / 1800 V / 900 V / 900 V

150 kA
 20 kA
 Split-Phase

1.5...16 mm² / 1.5...35 mm²
 15 mm
 2...4.5 Nm

CE; cURus; VDE
 IEC 61643-11, EN 61643-11, UL 1449

no remote sig. contact	with remote signalling (R)
16 / 1.5 / 35	16 / 1.5 / 35
90 / 36 / 68	104.5 / 36 / 68
No	250 V 1A 1CO

Wire-end ferrules must be used when connecting finely stranded wire.

Type	Qty.	Order No.
VPU AC II 2 300/50	1	2591040000
VPU AC II 2 R 300/50	1	2591050000

Pluggable spare arrester L-N: VPU AC II 0 300/50 - 2591010000

Type II, Type III / T2, T3
 Type II, Type III
 230 V
 300 V /
 TN-C
 20 kA /
 50 kA /
 ≤ 1.5 kV

No Fuse necessary ≤ 315 A gG, 250 A gG @50 kA I_{scCR} , 315 A gG @25 kA I_{scCR}

50 kA
 337 V
 ≤ 25 ns
 green = OK; red = arrester is defective - replace
 Installation housing; 3TE, Insta IP 20
 -40 °C... 85 °C
 ≤ 4000 m

SPD TYPE 1CA
 240 V
 600 V / / 300 V /
 1800 V / / 900 V /

150 kA
 20 kA
 3-phase WYE

1.5...16 mm² / 1.5...35 mm²
 15 mm
 2...4.5 Nm

CE; cURus; VDE
 IEC 61643-11, EN 61643-11, UL 1449

no remote sig. contact	with remote signalling (R)
16 / 1.5 / 35	16 / 1.5 / 35
90 / 54 / 68	104.5 / 54 / 68
No	250 V 1A 1CO

Wire-end ferrules must be used when connecting finely stranded wire.

Type	Qty.	Order No.
VPU AC II 3 300/50	1	2591160000
VPU AC II 3 R 300/50	1	2591170000

Pluggable spare arrester L-N: VPU AC II 0 300/50 - 2591010000



**Type II - 300 V / 50 kA**

- Back-up fuse not necessary up to 315 A
- Pluggable, coded arrester class II and III
- High energy absorption with short response time
- No follow current
- Installation in the distribution board
- Co-ordination with VPU AC Typ I and Typ III

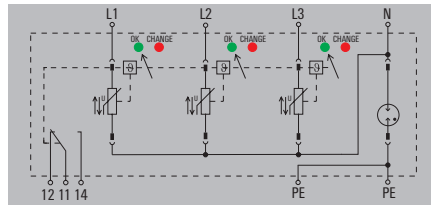
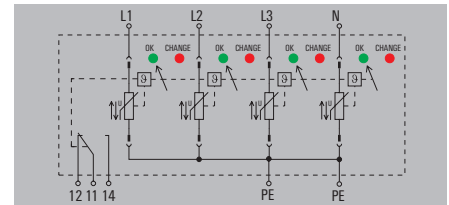
VPU AC II 3+1 (R) 300/50**VPU AC II 4 (R) 300/50****Technical data**

Requirements category acc. to IEC/EN 61643-11
Energy coordination (≤ 10 m)
Rated voltage (AC)
Max. continuous voltage, U_c (L-N / N-PE)
Low voltage network
Discharge current I_n (8/20 μ s) (Ader-PE / N-PE)
Discharge current I_{max} (8/20 μ s) (Ader-PE / N-PE)
Protection level U_p at I_n (L/N-PE)
Protection level U_p at I_n (N-PE)
Fuse

Short-circuit current rating I_{SCCR}
Temporary surge voltage (over-voltage) - TOV
Response time
Optical function display
Design
Ambient temperature (operational)
Operating altitude

UL values

Category
Rated Voltage U_n
Max. continuous voltage MCOV (L-L / L-N / L-G / N-G)
Protection level VPR (L-L / L-N / L-G / N-G)
SCCR
 I_n
UL Energy Networks

Connection data

Solid / Stranded
Stripping length
Tightening torque

Approvals

Approvals
Standards

Dimensions / Remote signalling contact info

Clamping range (nominal / min. / max.) mm²
Height x width x depth mm
Signalling contact

Note

Type II, Type III / T2, T3

Type II, Type III

230 V

300 V / 305 V

TN-C-S, TN-S, TT, IT with N, IT without N

20 kA / 40 kA

50 kA / 65 kA

≤ 1.5 kV

≤ 1.5 kV

No Fuse necessary ≤ 315 A gG, 250 A gG @50 kA I_{SCCR}, 315 A gG @25 kA I_{SCCR}

50 kA

337 V

≤ 25 ns

green = OK; red = arrester is defective - replace

Installation housing: 4TE, Insta IP 20

-40 °C...85 °C

≤ 4000 m

SPD TYPE 1CA

240 V

600 V / 600 V / 300 V / 305 V

1800 V / 900 V / 1000 V / 1000 V

150 kA

20 kA

3-phase WYE

1.5...16 mm² / 1.5...35 mm²

15 mm

2...4.5 Nm

CE; cURus; VDE

IEC 61643-11, EN 61643-11, UL 1449

no remote sig. contact

with remote signalling (R)

16 / 1.5 / 35

16 / 1.5 / 35

90 / 72 / 68

104.5 / 72 / 68

No

250 V 1A 1CO

Wire-end ferrules must be used when connecting finely stranded wire.

Type II, Type III / T2, T3

Type II, Type III

230 V

300 V /

TN-C-S, TN-S

20 kA /

50 kA /

≤ 1.5 kV

No Fuse necessary ≤ 315 A gG, 250 A gG @50 kA I_{SCCR}, 315 A gG @25 kA I_{SCCR}

50 kA

337 V

≤ 25 ns

green = OK; red = arrester is defective - replace

Installation housing: 4TE, Insta IP 20

-40 °C...85 °C

≤ 4000 m

SPD TYPE 1CA

240 V

600 V / 600 V / 300 V / 300 V

1800 V / 1800 V / 1000 V / 1000 V

150 kA

20 kA

3-phase WYE

1.5...16 mm² / 1.5...35 mm²

15 mm

2...4.5 Nm

CE; cURus; VDE

IEC 61643-11, EN 61643-11, UL 1449

no remote sig. contact

with remote signalling (R)

16 / 1.5 / 35

16 / 1.5 / 35

90 / 72 / 68

104.5 / 72 / 68

No

250 V 1A 1CO

Wire-end ferrules must be used when connecting finely stranded wire.

Ordering data

without remote signalling contact
with remote signalling contact (R)

Type	Qty.	Order No.
VPU AC II 3+1 300/50	1	2591080000
VPU AC II 3+1 R 300/50	1	2591090000

Type	Qty.	Order No.
VPU AC II 4 300/50	1	2591140000
VPU AC II 4 R 300/50	1	2591150000

Note

Only for IT networks where the earth at the distribution transformer is connected to the earth on the customer side.

Accessories**Note**

Pluggable spare arrester L-N: VPU AC II 0 300/50 - 2591010000;
N-PE: VPU AC I 1 N-PE 305/50 - 2591570000

Pluggable spare arrester L-N: VPU AC II 0 300/50 - 2591010000

Surge protection Type II – VPU AC II series

Type II - 300 V / 50 kA (status display red, yellow, green)

- Pluggable, coded arrester
- High energy absorption with short response time
- Installation in the distribution board
- ASI, advanced status indicator
- Co-ordination with VPU AC Typ I and Typ III

VPU AC II 1 R 300/50 Y

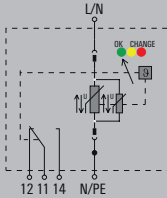

VPU AC II 1+1 R 300/50 Y

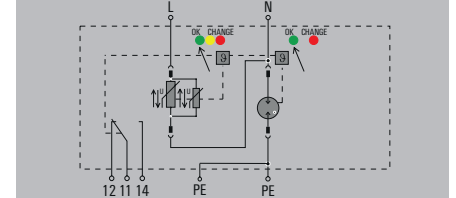

Technical data

Requirements category acc. to IEC/EN 61643-11
 Energy coordination (≤ 10 m)
 Rated voltage (AC)
 Max. continuous voltage, U_c (L-N / N-PE)
 Low voltage network
 Discharge current I_n (8/20 μ s) (Ader-PE / N-PE)
 Discharge current I_{max} (8/20 μ s) (Ader-PE / N-PE)
 Protection level U_p at I_n (L/N-PE)
 Protection level U_p at I_n (N-PE)
 Fuse
 Short-circuit current rating I_{SCCR}
 Temporary surge voltage (over-voltage) - TOV
 Response time
 Optical function display
 Design
 Ambient temperature (operational)
 Operating altitude

UL values

Category
 Rated Voltage U_n
 Max. continuous voltage MCOV (L-L / L-N / L-G / N-G)
 Protection level VPR (L-L / L-N / L-G / N-G)
 SCCR
 I_n
 UL Energy Networks

Connection data

Solid / Stranded
 Stripping length
 Tightening torque

Approvals

Approvals
 Standards

Dimensions / Remote signalling contact info

Clamping range (nominal / min. / max.) mm²
 Height x width x depth mm
 Signalling contact

Note

Ordering data

with remote signalling contact (R)

Note

Accessories

Note

Type II, Type III / T2, T3

Type II, Type III

230 V

300 V /

Single-phase, TN

20 kA /

50 kA /

≤ 1.3 kV

No Fuse necessary ≤ 160 A gG

50 kA

337 V

≤ 25 ns

green = ok, yellow = warning, red = arrester is defective - replace.

Installation housing; 1TE, Insta IP 20

-40 °C...85 °C

≤ 4000 m

SPD TYPE 1CA

240 V

/ / 300 V /

/ / 900 V /

150 kA

20 kA

Split-Phase

1.5...16 mm² / 1.5...35 mm²

18 mm

3...4.5 Nm

CE; cURus; VDE

IEC 61643-11, EN 61643-11, UL 1449

with remote signalling (R)

16 / 1.5 / 35

111 / 18 / 70

250 V 1A 1CO

Wire-end ferrules must be used when connecting finely stranded wire.

Type	Qty.	Order No.
VPU AC II 1 R 300/50 Y	1	2639350000

Type II, Type III / T2, T3

Type II, Type III

230 V

300 V / 305 V

Single-phase, TN, TT, IT with N, IT without N

20 kA / 40 kA

50 kA / 65 kA

≤ 1.3 kV

≤ 1.5 kV

No Fuse necessary ≤ 160 A gG

50 kA

337 V

≤ 25 ns

green = ok, yellow = warning, red = arrester is defective - replace.

Installation housing; 2TE, Insta IP 20

-40 °C...85 °C

≤ 4000 m

SPD TYPE 1CA

240 V

/ 300 V / 300 V / 305 V

/ 900 V / 900 V / 1000 V

150 kA

20 kA

Split-Phase

1.5...16 mm² / 1.5...35 mm²

18 mm

3...4.5 Nm

CE; cURus; VDE

IEC 61643-11, EN 61643-11, UL 1449

with remote signalling (R)

16 / 1.5 / 35

104.5 / 36 / 70

250 V 1A 1CO

Wire-end ferrules must be used when connecting finely stranded wire.

Type	Qty.	Order No.
VPU AC II 1+1 R 300/50 Y	1	2639340000

Only for IT networks where the earth at the distribution transformer is connected to the earth on the customer side.

Pluggable spare arrester L-N: VPU AC II 0 300/50 Y - 2659840000;
 N-PE: VPU AC II 0 N-PE 305/65 Y 2659950000

Type II - 300 V / 50 kA (status display red, yellow, green)

- Pluggable, coded arrester
- High energy absorption with short response time
- Installation in the distribution board
- ASI, advanced status indicator
- Co-ordination with VPU AC Typ I and Typ III

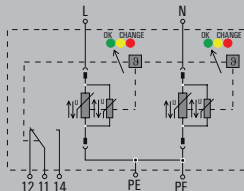
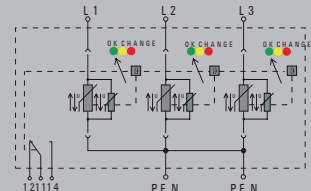
VPU AC II 2 R 300/50 Y**VPU AC II 3 R 300/50 Y****Technical data**

Requirements category acc. to IEC/EN 61643-11
 Energy coordination (≤ 10 m)
 Rated voltage (AC)
 Max. continuous voltage, U_c (L-N / N-PE)
 Low voltage network
 Discharge current I_n (8/20 μ s) (Ader-PE / N-PE)
 Discharge current I_{max} (8/20 μ s) (Ader-PE / N-PE)
 Protection level U_p at I_n (L/N-PE)
 Protection level U_p at I_n (N-PE)
 Fuse
 Short-circuit current rating I_{SCCR}
 Temporary surge voltage (over-voltage) - TOV
 Response time
 Optical function display
 Design
 Ambient temperature (operational)
 Operating altitude

UL values

Category
 Rated Voltage U_n
 Max. continuous voltage MCOV (L-L / L-N / L-G / N-G)
 Protection level VPR (L-L / L-N / L-G / N-G)
 SCCR
 I_n
 UL Energy Networks

Connection data

Solid / Stranded
 Stripping length
 Tightening torque

Approvals

Approvals
 Standards

Dimensions / Remote signalling contact info

Clamping range (nominal / min. / max.) mm²
 Height x width x depth mm
 Signalling contact

Note**Ordering data**

with remote signalling contact (R)

Note**Accessories****Note**

Type II, Type III / T2, T3

Type II, Type III

230 V

300 V /

Single-phase, TN-S

20 kA /

50 kA /

≤ 1.3 kV

No Fuse necessary ≤ 160 A gG

50 kA

337 V

≤ 25 ns

green = ok, yellow = warning, red = arrester is defective - replace.

Installation housing; 2TE, Insta IP 20

-40 °C...85 °C

≤ 4000 m

SPD TYPE 1CA

240 V

/ 600 V / 300 V / 300 V

/ 1800 V / 900 V / 900 V

150 kA

20 kA

Split-Phase

1.5...16 mm² / 1.5...35 mm²

18 mm

3...4.5 Nm

CE; cURus; VDE

IEC 61643-11, EN 61643-11, UL 1449

with remote signalling (R)

16 / 1.5 / 35

104.5 / 36 / 70

250 V 1A 1CO

Wire-end ferrules must be used when connecting finely stranded wire.

Type	Qty.	Order No.
VPU AC II 2 R 300/50 Y	1	2639360000

Type II, Type III / T2, T3

Type II, Type III

230 V

300 V /

TN-C

20 kA /

50 kA /

≤ 1.3 kV

No Fuse necessary ≤ 160 A gG

50 kA

337 V

≤ 25 ns

green = ok, yellow = warning, red = arrester is defective - replace.

Installation housing; 3TE, Insta IP 20

-40 °C...85 °C

≤ 4000 m

SPD TYPE 1CA

240 V

600 V / / 300 V /

1800 V / / 900 V /

150 kA

20 kA

1.5...16 mm² / 1.5...35 mm²

18 mm

3...4.5 Nm

CE; cURus; VDE

IEC 61643-11, EN 61643-11, UL 1449

with remote signalling (R)

16 / 1.5 / 35

104.5 / 54 / 70

250 V 1A 1CO

Wire-end ferrules must be used when connecting finely stranded wire.

Type	Qty.	Order No.
VPU AC II 3 R 300/50 Y	1	2639330000

Pluggable spare arrester L-N: VPU AC II 0 300/50 Y - 2659840000



Surge protection Type II – VPU AC II series

Type II - 300 V / 50 kA (status display red, yellow, green)

- Pluggable, coded arrester
- High energy absorption with short response time
- Installation in the distribution board
- ASI, advanced status indicator
- Co-ordination with VPU AC Typ I and Typ III

VPU AC II 3+1 R 300/50 Y

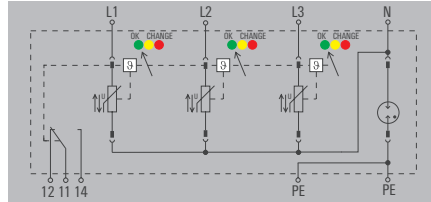

VPU AC II 4 R 300/50 Y

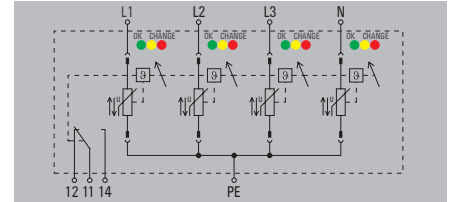

Technical data

Requirements category acc. to IEC/EN 61643-11
 Energy coordination (≤ 10 m)
 Rated voltage (AC)
 Max. continuous voltage, U_c (L-N / N-PE)
 Low voltage network
 Discharge current I_n (8/20 μ s) (Ader-PE / N-PE)
 Discharge current I_{max} (8/20 μ s) (Ader-PE / N-PE)
 Protection level U_p at I_n (L/N-PE)
 Protection level U_p at I_n (N-PE)
 Fuse
 Short-circuit current rating I_{SCCR}
 Temporary surge voltage (over-voltage) - TOV
 Response time
 Optical function display
 Design
 Ambient temperature (operational)
 Operating altitude

UL values

Category
 Rated Voltage U_n
 Max. continuous voltage MCOV (L-L / L-N / L-G / N-G)
 Protection level VPR (L-L / L-N / L-G / N-G)
 SCCR
 I_n
 UL Energy Networks

Connection data

Solid / Stranded
 Stripping length
 Tightening torque

Approvals

Approvals
 Standards

Dimensions / Remote signalling contact info

Clamping range (nominal / min. / max.) mm²
 Height x width x depth mm
 Signalling contact

Note

Ordering data

with remote signalling contact (R)

Note

Accessories

Note

Type II, Type III / T2, T3
 Type II, Type III
 230 V
 300 V / 305 V
 TN-C-S, TN-S, TT, IT with N, IT without N
 20 kA / 40 kA
 50 kA / 65 kA
 ≤ 1.3 kV
 ≤ 1.5 kV
 No Fuse necessary ≤ 160 A gG
 50 kA
 337 V
 ≤ 25 ns
 green = ok, yellow = warning, red = arrester is defective - replace.
 Installation housing; 4TE, Insta IP 20
 -40 °C... 85 °C
 ≤ 4000 m

SPD TYPE 1CA

240 V
 600 V / 300 V / 300 V / 305 V
 1800 V / 900 V / 900 V / 1000 V
 150 kA
 20 kA
 3-phase WYE

1.5...16 mm² / 1.5...35 mm²

18 mm

3...4.5 Nm

CE; cURus; VDE

IEC 61643-11, EN 61643-11, UL 1449

with remote signalling (R)

16 / 1.5 / 35

104.5 / 72 / 70

250 V 1A 1CO

Wire-end ferrules must be used when connecting finely stranded wire.

Type	Qty.	Order No.
VPU AC II 3+1 R 300/50 Y	1	2639320000

Only for IT networks where the earth at the distribution transformer is connected to the earth on the customer side.

Pluggable spare arrester L-N: VPU AC II 0 300/50 Y - 2659840000;
 N-PE: VPU AC II 0 N-PE 305/65 Y 2659950000

Type II, Type III / T2, T3
 Type II, Type III
 230 V
 300 V /
 TN-C-S, TN-S
 20 kA /
 50 kA /
 ≤ 1.3 kV

No Fuse necessary ≤ 160 A gG

50 kA

337 V

≤ 25 ns

green = ok, yellow = warning, red = arrester is defective - replace.

Installation housing; 4TE, Insta IP 20

-40 °C... 85 °C

≤ 4000 m

SPD TYPE 1CA

240 V
 600 V / 600 V / 300 V / 300 V
 1800 V / 1800 V / 900 V / 900 V
 150 kA
 20 kA
 3-phase WYE

1.5...16 mm² / 1.5...35 mm²

18 mm

3...4.5 Nm

CE; cURus; VDE

IEC 61643-11, EN 61643-11, UL 1449

with remote signalling (R)

16 / 1.5 / 35

104.5 / 72 / 70

250 V 1A 1CO

Wire-end ferrules must be used when connecting finely stranded wire.

Type	Qty.	Order No.
VPU AC II 4 R 300/50 Y	1	2639370000

Pluggable spare arrester L-N: VPU AC II 0 300/50 Y - 2659840000

Type II - 350 V / 50 kA

- Back-up fuse not necessary up to 315 A
- Pluggable, coded arrester
- High energy absorption with short response time
- No follow current
- Installation in the distribution board
- Co-ordination with VPU AC Typ I and Typ III
- Increased voltage tolerance up to 350 V

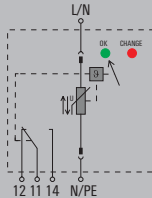
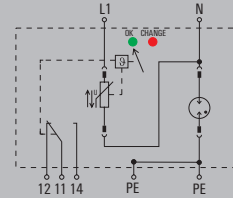
VPU AC II 1 (R) 350/50**VPU AC II 1+1 (R) 350/50****Technical data**

Requirements category acc. to IEC/EN 61643-11
 Energy coordination (≤ 10 m)
 Rated voltage (AC)
 Max. continuous voltage, U_c (L-N / N-PE)
 Low voltage network
 Discharge current I_n (8/20 μ s) (Ader-PE / N-PE)
 Discharge current I_{max} (8/20 μ s) (Ader-PE / N-PE)
 Protection level U_p at I_n (L/N-PE)
 Protection level U_p at I_n (N-PE)
 Fuse

Short-circuit current rating I_{scCR}
 Temporary surge voltage (over-voltage) - TOV
 Response time
 Optical function display
 Design
 Ambient temperature (operational)
 Operating altitude

UL values

Category
 Rated Voltage U_n
 Max. continuous voltage MCOV (L-L / L-N / L-G / N-G)
 Protection level VPR (L-L / L-N / L-G / N-G)
 SCCR
 I_n
 UL Energy Networks

Connection data

Solid / Stranded
 Stripping length
 Tightening torque

Approvals

Approvals
 Standards

Dimensions / Remote signalling contact info

Clamping range (nominal / min. / max.) mm²
 Height x width x depth mm
 Signalling contact

Note

Type II, Type III / T2, T3

Type II, Type III

230 V

350 V /

Single-phase

20 kA /

50 kA /

≤ 1.75 kV

No Fuse necessary ≤ 315 A gG, 250 A gG @50 kA Isccr, 315 A gG @25 kA Isccr

50 kA

403 V

≤ 25 ns

green = OK; red = arrester is defective - replace

Installation housing; 1TE, Insta IP 20

-40 °C...85 °C

≤ 4000 m

SPD TYPE 1CA

277 V

/ / 350 V /

/ / 1000 V /

200 kA

20 kA

Split-Phase

1.5...16 mm² / 1.5...35 mm²

18 mm

3...4.5 Nm

CE; cURus; VDE

IEC 61643-11, EN 61643-11, UL 1449

no remote sig. contact

with remote signalling (R)

16 / 1.5 / 35

16 / 1.5 / 35

90 / 18 / 68

111 / 18 / 68

No

250 V 1A 1CO

Wire-end ferrules must be used when connecting finely stranded wire.

Type II, Type III / T2, T3

Type II, Type III

230 V

350 V /

Single-phase, TN, TT, IT with N, IT without N

20 kA / 40 kA

50 kA / 65 kA

≤ 1.75 kV

≤ 1.5 kV

No Fuse necessary ≤ 315 A gG, 250 A gG @50 kA Isccr, 315 A gG @25 kA Isccr

50 kA

403 V

≤ 25 ns

green = OK; red = arrester is defective - replace

Installation housing; 2TE, Insta IP 20

-40 °C...85 °C

≤ 4000 m

SPD TYPE 1CA

277 V

/ 700 V / 350 V / 305 V

/ 1000 V / 3000 V / 1000 V

200 kA

20 kA

Split-Phase

1.5...16 mm² / 1.5...35 mm²

18 mm

3...4.5 Nm

CE; cURus; VDE

IEC 61643-11, EN 61643-11, UL 1449

no remote sig. contact

with remote signalling (R)

16 / 1.5 / 35

16 / 1.5 / 35

90 / 36 / 68

104.5 / 36 / 68

No

250 V 1A 1CO

Wire-end ferrules must be used when connecting finely stranded wire.

Ordering data

without remote signalling contact
 with remote signalling contact (R)

Type	Qty.	Order No.
VPU AC II 1 350/50	1	2591350000
VPU AC II 1 R 350/50	1	2591360000

Note

Type	Qty.	Order No.
VPU AC II 1+1 350/50	1	2637030000
VPU AC II 1+1 R 350/50	1	2637040000

Only for IT networks where the earth at the distribution transformer is connected to the earth on the customer side.

Accessories**Note**

Pluggable spare arrester L-N: VPU AC II 0 350/50 - 2591340000

Pluggable spare arrester L-N: VPU AC II 0 350/50 - 2591340000;
 N-PE: VPU AC I 1 N-PE 305/50 - 2591570000





Surge protection Type II – VPU AC II series

Type II - 350 V / 50 kA

- Back-up fuse not necessary up to 315 A
- Pluggable, coded arrester
- High energy absorption with short response time
- No follow current
- Installation in the distribution board
- Co-ordination with VPU AC Typ I and Typ III
- Increased voltage tolerance up to 350 V

VPU AC II 2 (R) 350/50

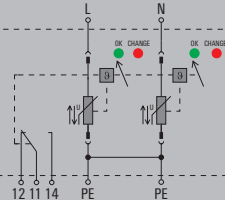

VPU AC II 3 (R) 350/50

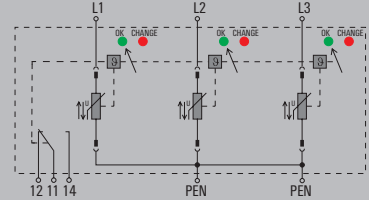

Technical data

Requirements category acc. to IEC/EN 61643-11
 Energy coordination (≤ 10 m)
 Rated voltage (AC)
 Max. continuous voltage, U_c (L-N / N-PE)
 Low voltage network
 Discharge current I_a (8/20 μ s) (Ader-PE / N-PE)
 Discharge current I_{max} (8/20 μ s) (Ader-PE / N-PE)
 Protection level U_p at I_a (L/N-PE)
 Protection level U_p at I_a (N-PE)
 Fuse

Short-circuit current rating I_{scCR}
 Temporary surge voltage (over-voltage) - TOV
 Response time
 Optical function display
 Design
 Ambient temperature (operational)
 Operating altitude

UL values

Category
 Rated Voltage U_n
 Max. continuous voltage MCOV (L-L / L-N / L-G / N-G)
 Protection level VPR (L-L / L-N / L-G / N-G)
 SCCR
 I_a
 UL Energy Networks

Connection data

Solid / Stranded
 Stripping length
 Tightening torque

Approvals

Approvals
 Standards

Dimensions / Remote signalling contact info

Clamping range (nominal / min. / max.) mm²
 Height x width x depth mm
 Signalling contact

Note

Type II, Type III / T2, T3

Type II, Type III

230 V

350 V /

Single-phase, TN

20 kA /

50 kA /

≤ 1.75 kV

No Fuse necessary ≤ 315 A gG, 250 A gG @50 kA I_{scCR} , 315 A gG @25 kA I_{scCR}

50 kA

403 V

≤ 25 ns

green = OK; red = arrester is defective - replace

Installation housing; 2TE, Insta IP 20

-40 °C...85 °C

≤ 4000 m

SPD TYPE 1CA

277 V

/ 700 V / 350 V / 350 V

/ 2000 V / 1000 V / 1000 V

200 kA

20 kA

Split-Phase

1.5...16 mm² / 1.5...35 mm²

18 mm

3...4.5 Nm

CE; cURus; VDE

IEC 61643-11, EN 61643-11, UL 1449

no remote sig. contact

with remote signalling (R)

16 / 1.5 / 35

16 / 1.5 / 35

90 / 36 / 68

104.5 / 36 / 68

No

250 V 1A 1C0

Wire-end ferrules must be used when connecting finely stranded wire.

Type II, Type III / T2, T3

Type II, Type III

230 V

350 V /

TN-C

20 kA /

50 kA /

≤ 1.75 kV

No Fuse necessary ≤ 315 A gG, 250 A gG @50 kA I_{scCR} , 315 A gG @25 kA I_{scCR}

50 kA

403 V

≤ 25 ns

green = OK; red = arrester is defective - replace

Installation housing; 3TE, Insta IP 20

-40 °C...85 °C

≤ 4000 m

SPD TYPE 1CA

277 V

700 V / / 350 V /

2000 V / / 1000 V /

200 kA

20 kA

3-phase WYE

1.5...16 mm² / 1.5...35 mm²

18 mm

3...4.5 Nm

CE; cURus; VDE

IEC 61643-11, EN 61643-11, UL 1449

no remote sig. contact

with remote signalling (R)

16 / 1.5 / 35

16 / 1.5 / 35

90 / 54 / 68

104.5 / 54 / 68

No

250 V 1A 1C0

Wire-end ferrules must be used when connecting finely stranded wire.

Ordering data

without remote signalling contact
 with remote signalling contact (R)

Type	Qty.	Order No.
VPU AC II 2 350/50	1	2637010000
VPU AC II 2 R 350/50	1	2637020000

Type	Qty.	Order No.
VPU AC II 3 350/50	1	2591100000
VPU AC II 3 R 350/50	1	2591110000

Note

Accessories

Note

Pluggable spare arrester L-N: VPU AC II 0 350/50 - 2591340000

Pluggable spare arrester L-N: VPU AC II 0 350/50 - 2591340000

**Type II - 350 V / 50 kA**

- Back-up fuse not necessary up to 315 A
- Pluggable, coded arrester
- High energy absorption with short response time
- No follow current
- Installation in the distribution board
- Co-ordination with VPU AC Typ I and Typ III
- Increased voltage tolerance up to 350 V

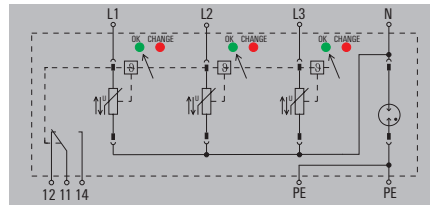
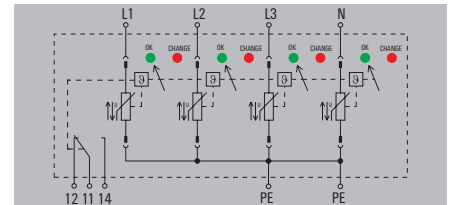
VPU AC II 3+1 (R) 350/50**VPU AC II 4 (R) 350/50****Technical data**

Requirements category acc. to IEC/EN 61643-11
 Energy coordination (≤ 10 m)
 Rated voltage (AC)
 Max. continuous voltage, U_c (L-N / N-PE)
 Low voltage network
 Discharge current I_n (8/20 μ s) (Ader-PE / N-PE)
 Discharge current I_{max} (8/20 μ s) (Ader-PE / N-PE)
 Protection level U_p at I_n (L/N-PE)
 Protection level U_p at I_n (N-PE)
 Fuse

Short-circuit current rating I_{scCR}
 Temporary surge voltage (over-voltage) - TOV
 Response time
 Optical function display
 Design
 Ambient temperature (operational)
 Operating altitude

UL values

Category
 Rated Voltage U_n
 Max. continuous voltage MCOV (L-L / L-N / L-G / N-G)
 Protection level VPR (L-L / L-N / L-G / N-G)
 SCCR
 I_n
 UL Energy Networks

Connection data

Solid / Stranded
 Stripping length
 Tightening torque

Approvals

Approvals
 Standards

Dimensions / Remote signalling contact info

Clamping range (nominal / min. / max.) mm²
 Height x width x depth mm
 Signalling contact

Note

Type II, Type III / T2, T3

Type II, Type III

230 V

350 V /

TN-C-S, TN-S, TT, IT with N, IT without N

20 kA / 40 kA

50 kA / 65 kA

≤ 1.75 kV

≤ 1.5 kV

No Fuse necessary ≤ 315 A gG, 250 A gG @50 kA I_{scCR}, 315 A gG @25 kA I_{scCR}

50 kA

403 V

≤ 25 ns

green = OK; red = arrester is defective - replace

Installation housing: 4TE, Insta IP 20

-40 °C...85 °C

≤ 4000 m

SPD TYPE 1CA

277 V

700 V / 700 V / 350 V / 305 V

2000 V / 1000 V / 1000 V / 1000 V

200 kA

20 kA

3-phase WYE

1.5...16 mm² / 1.5...35 mm²

18 mm

3...4.5 Nm

CE; cURus; VDE

IEC 61643-11, EN 61643-11, UL 1449

no remote sig. contact

with remote signalling (R)

16 / 1.5 / 35

16 / 1.5 / 35

90 / 72 / 68

104.5 / 72 / 68

No

250 V 1A 1C0

Wire-end ferrules must be used when connecting finely stranded wire.

Type II, Type III / T2, T3

Type II, Type III

230 V

350 V /

TN-C-S, TN-S

20 kA /

50 kA /

≤ 1.75 kV

≤ 1.5 kV

No Fuse necessary ≤ 315 A gG, 250 A gG @50 kA I_{scCR}, 315 A gG @25 kA I_{scCR}

50 kA

403 V

≤ 25 ns

green = OK; red = arrester is defective - replace

Installation housing: 4TE, Insta IP 20

-40 °C...85 °C

≤ 4000 m

SPD TYPE 1CA

277 V

700 V / 700 V / 350 V / 350 V

2000 V / 2000 V / 1000 V / 1000 V

200 kA

20 kA

3-phase WYE

1.5...16 mm² / 1.5...35 mm²

18 mm

3...4.5 Nm

CE; cURus; VDE

IEC 61643-11, EN 61643-11, UL 1449

no remote sig. contact

with remote signalling (R)

16 / 1.5 / 35

16 / 1.5 / 35

90 / 72 / 68

104.5 / 72 / 68

No

250 V 1A 1C0

Wire-end ferrules must be used when connecting finely stranded wire.

Ordering data

without remote signalling contact
 with remote signalling contact (R)

Type	Qty.	Order No.
VPU AC II 3+1 350/50	1	2637050000
VPU AC II 3+1 R 350/50	1	2637060000

Type	Qty.	Order No.
VPU AC II 4 350/50	1	2591120000
VPU AC II 4 R 350/50	1	2591130000

Note

Only for IT networks where the earth at the distribution transformer is connected to the earth on the customer side.

Accessories**Note**

Pluggable spare arrester L-N: VPU AC II 0 350/50 - 2591340000;
 N-PE: VPU AC I 1 N-PE 305/50 - 2591570000

Pluggable spare arrester L-N: VPU AC II 0 350/50 - 2591340000

Surge protection Type II – VPU AC II series

Type II - 480 V / 50 kA

- Back-up fuse not necessary up to 315 A
- Pluggable, coded arrester
- High energy absorption with short response time
- No follow current
- Installation in the distribution board
- Co-ordination with VPU AC Typ I and Typ III

VPU AC II 1 (R) 480/50

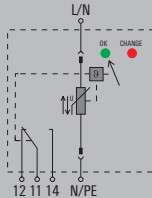

VPU AC II 2 (R) 480/50

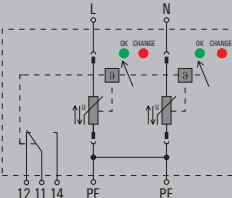

Technical data

Requirements category acc. to IEC/EN 61643-11
 Energy coordination (≤ 10 m)
 Rated voltage (AC)
 Max. continuous voltage, U_c (L-N / N-PE)
 Low voltage network
 Discharge current I_n (8/20 μ s) (Ader-PE / N-PE)
 Discharge current I_{max} (8/20 μ s) (Ader-PE / N-PE)
 Protection level U_p at I_n (L/N-PE)
 Protection level U_p at I_n (N-PE)
 Fuse

Short-circuit current rating I_{scCR}
 Temporary surge voltage (over-voltage) - TOV
 Response time
 Optical function display
 Design
 Ambient temperature (operational)
 Operating altitude

UL values

Category
 Rated Voltage U_n
 Max. continuous voltage MCOV (L-L / L-N / L-G / N-G)
 Protection level VPR (L-L / L-N / L-G / N-G)
 SCCR
 I_n
 UL Energy Networks

Connection data

Solid / Stranded
 Stripping length
 Tightening torque

Approvals

Approvals
 Standards

Dimensions / Remote signalling contact info

Clamping range (nominal / min. / max.) mm²
 Height x width x depth mm
 Signalling contact

Note

Ordering data

without remote signalling contact
 with remote signalling contact (R)

Note

Accessories

Note

Type II, Type III / T2, T3
 Type II, Type III
 400 V
 480 V /
 Single-phase, TN
 20 kA /
 50 kA /
 ≤ 2.3 kV

No Fuse necessary ≤ 315 A gG, 250 A gG @50 kA I_{scCR} , 315 A gG @25 kA I_{scCR}

50 kA
 581 V
 ≤ 25 ns
 green = OK; red = arrester is defective - replace
 Installation housing; 1TE, Insta IP 20
 -40 °C...85 °C
 ≤ 4000 m

SPD TYPE 1CA

400 V
 / / 480 V /
 / / 1500 V /
 200 kA
 20 kA
 Split-Phase

1.5...16 mm² / 1.5...35 mm²
 18 mm
 3...4.5 Nm

CE; cURus; VDE
 IEC 61643-11, EN 61643-11, UL 1449

no remote sig. contact with remote signalling (R)

no remote sig. contact	with remote signalling (R)
16 / 1.5 / 35	16 / 1.5 / 35
90 / 18 / 68	111 / 18 / 68
No	250 V 1A 1CO

Wire-end ferrules must be used when connecting finely stranded wire.

Type	Qty.	Order No.
VPU AC II 1 480/50	1	2591210000
VPU AC II 1 R 480/50	1	2591220000

Pluggable spare arrester L-N: VPU AC II 0 480/50 - 2591200000

Type II, Type III / T2, T3
 Type II, Type III
 400 V
 480 V /
 Single-phase, TN-S
 20 kA /
 50 kA /
 ≤ 2.3 kV

No Fuse necessary ≤ 315 A gG, 250 A gG @50 kA I_{scCR} , 315 A gG @25 kA I_{scCR}

50 kA
 581 V
 ≤ 25 ns
 green = OK; red = arrester is defective - replace
 Installation housing; 2TE, Insta IP 20
 -40 °C...85 °C
 ≤ 4000 m

SPD TYPE 1CA

400 V
 / 960 V / 480 V / 480 V
 / 3000 V / 1500 V / 1500 V
 200 kA
 20 kA
 Split-Phase

1.5...16 mm² / 1.5...35 mm²
 18 mm
 3...4.5 Nm

CE; cURus; VDE
 IEC 61643-11, EN 61643-11, UL 1449

no remote sig. contact with remote signalling (R)

no remote sig. contact	with remote signalling (R)
16 / 1.5 / 35	16 / 1.5 / 35
90 / 36 / 68	104.5 / 36 / 68
No	250 V 1A 1CO

Wire-end ferrules must be used when connecting finely stranded wire.

Type	Qty.	Order No.
VPU AC II 2 480/50	1	2591230000
VPU AC II 2 R 480/50	1	2591240000

Pluggable spare arrester L-N: VPU AC II 0 480/50 - 2591200000



Type II - 480 V / 50 kA

- Back-up fuse not necessary up to 315 A
- Pluggable, coded arrester
- High energy absorption with short response time
- No follow current
- Installation in the distribution board
- Co-ordination with VPU AC Typ I and Typ III

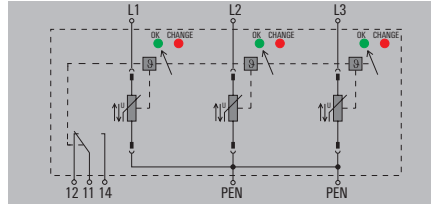
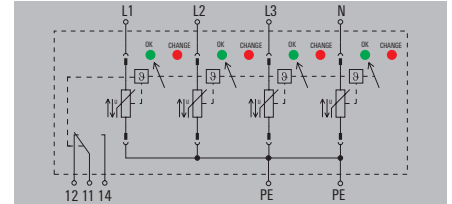
VPU AC II 3 (R) 480/50**VPU AC II 4 (R) 480/50****Technical data**

Requirements category acc. to IEC/EN 61643-11
 Energy coordination (≤ 10 m)
 Rated voltage (AC)
 Max. continuous voltage, U_c (L-N / N-PE)
 Low voltage network
 Discharge current I_a (8/20 μ s) (Ader-PE / N-PE)
 Discharge current I_{max} (8/20 μ s) (Ader-PE / N-PE)
 Protection level U_p at I_a (L/N-PE)
 Protection level U_p at I_a (N-PE)
 Fuse

Short-circuit current rating I_{scCR}
 Temporary surge voltage (over-voltage) - TOV
 Response time
 Optical function display
 Design
 Ambient temperature (operational)
 Operating altitude

UL values

Category
 Rated Voltage U_n
 Max. continuous voltage MCOV (L-L / L-N / L-G / N-G)
 Protection level VPR (L-L / L-N / L-G / N-G)
 SCCR
 I_a
 UL Energy Networks

Connection data

Solid / Stranded
 Stripping length
 Tightening torque

Approvals

Approvals
 Standards

Dimensions / Remote signalling contact info

Clamping range (nominal / min. / max.) mm²
 Height x width x depth mm
 Signalling contact

Note

Type II, Type III / T2, T3

Type II, Type III

400 V

480 V /

TN-C

20 kA /

50 kA /

≤ 2.3 kV

No Fuse necessary ≤ 315 A gG, 250 A gG @50 kA I_{scCR} , 315 A gG @25 kA I_{scCR}

50 kA

581 V

≤ 25 ns

green = OK; red = arrester is defective - replace

Installation housing: 3TE, Insta IP 20

-40 °C...85 °C

≤ 4000 m

SPD TYPE 1CA

400 V

960 V / 480 V /

3000 V / 1500 V /

200 kA

20 kA

3-phase WYE

1.5...16 mm² / 1.5...35 mm²

18 mm

3...4.5 Nm

CE; cURus; VDE

IEC 61643-11, EN 61643-11, UL 1449

no remote sig. contact

16 / 1.5 / 35

90 / 54 / 68

No

with remote signalling (R)

16 / 1.5 / 35

104.5 / 54 / 68

250 V 1A 1C0

Wire-end ferrules must be used when connecting finely stranded wire.

Type II, Type III / T2, T3

Type II, Type III

400 V

480 V /

TN-CS, TN-S

20 kA /

50 kA /

≤ 2.3 kV

No Fuse necessary ≤ 315 A gG, 250 A gG @50 kA I_{scCR} , 315 A gG @25 kA I_{scCR}

50 kA

581 V

≤ 25 ns

green = OK; red = arrester is defective - replace

Installation housing: 4TE, Insta IP 20

-40 °C...85 °C

≤ 4000 m

SPD TYPE 1CA

400 V

960 V / 960 V / 480 V / 480 V

3000 V / 3000 V / 1500 V / 1500 V

200 kA

20 kA

3-phase WYE

1.5...16 mm² / 1.5...35 mm²

18 mm

3...4.5 Nm

CE; cURus; VDE

IEC 61643-11, EN 61643-11, UL 1449

no remote sig. contact

16 / 1.5 / 35

90 / 72 / 68

No

with remote signalling (R)

16 / 1.5 / 35

104.5 / 72 / 68

250 V 1A 1C0

Wire-end ferrules must be used when connecting finely stranded wire.

Ordering data

without remote signalling contact
 with remote signalling contact (R)

Type	Qty.	Order No.
VPU AC II 3 480/50	1	2591250000
VPU AC II 3 R 480/50	1	2591260000

Type	Qty.	Order No.
VPU AC II 4 480/50	1	2591270000
VPU AC II 4 R 480/50	1	2591280000

Note**Accessories****Note**

Pluggable spare arrester L-N: VPU AC II 0 480/50 - 2591200000

Pluggable spare arrester L-N: VPU AC II 0 480/50 - 2591200000



Surge protection Type II – VPU AC II series

Type II - 750 V / 35 kA

- Back-up fuse not necessary up to 315 A
- Pluggable, coded arrester
- High energy absorption with short response time
- No follow current
- Installation in the distribution board
- Co-ordination with VPU AC Typ I and Typ III

VPU AC II 1 R 750/35

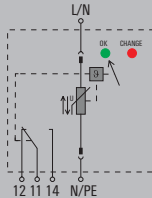

VPU AC II 2 R 750/35

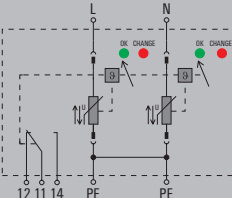

Technical data

Requirements category acc. to IEC/EN 61643-11
 Energy coordination (≤ 10 m)
 Rated voltage (AC)
 Max. continuous voltage, U_c (L-N / N-PE)
 Low voltage network
 Discharge current I_n (8/20 μ s) (Ader-PE / N-PE)
 Discharge current I_{max} (8/20 μ s) (Ader-PE / N-PE)
 Protection level U_p at I_n (L/N-PE)
 Protection level U_p at I_n (N-PE)
 Fuse

Short-circuit current rating I_{SCCR}
 Temporary surge voltage (over-voltage) - TOV
 Response time
 Optical function display
 Design
 Ambient temperature (operational)
 Operating altitude

UL values

Category
 Rated Voltage U_n
 Max. continuous voltage MCOV (L-L / L-N / L-G / N-G)
 Protection level VPR (L-L / L-N / L-G / N-G)
 SCCR
 I_n
 UL Energy Networks

Connection data

Solid / Stranded
 Stripping length
 Tightening torque

Approvals

Approvals
 Standards

Dimensions / Remote signalling contact info

Clamping range (nominal / min. / max.) mm²
 Height x width x depth mm
 Signalling contact

Note

Ordering data

with remote signalling contact (R)

Note

Accessories

Note

Type II, Type III / T2, T3
 Type II, Type III
 690 V
 750 V /
 Single-phase, TN
 20 kA /
 35 kA /
 ≤ 3.4 kV

No Fuse necessary ≤ 315 A gG, 250 A gG @50 kA I_{SCCR}, 315 A gG @25 kA I_{SCCR}

50 kA
 871 V
 ≤ 25 ns
 green = OK; red = arrester is defective - replace
 Installation housing; 1TE, Insta IP 20
 -40 °C...85 °C
 ≤ 4000 m

SPD TYPE 1CA

600 V
 / / 750 V /
 / / 2500 V /
 200 kA
 20 kA
 Split-Phase

1.5...16 mm² / 1.5...35 mm²

18 mm

3...4.5 Nm

CE; cURus; VDE

IEC 61643-11, EN 61643-11, UL 1449

with remote signalling (R)

16 / 1.5 / 35
 111 / 18 / 68
 250 V 1A 1CO

Wire-end ferrules must be used when connecting finely stranded wire.

Type	Qty.	Order No.
VPU AC II 1 R 750/35	1	2591300000

Pluggable spare arrester L-N: VPU AC II 0 750/35 - 25912900000

Type II, Type III / T2, T3
 Type II, Type III
 690 V
 750 V / 750 V
 Single-phase, TN-S
 20 kA /
 35 kA /
 ≤ 3.4 kV

No Fuse necessary ≤ 315 A gG, 250 A gG @50 kA I_{SCCR}, 315 A gG @25 kA I_{SCCR}

50 kA
 871 V
 ≤ 25 ns
 green = OK; red = arrester is defective - replace
 Installation housing; 2TE, Insta IP 20
 -40 °C...85 °C
 ≤ 4000 m

SPD TYPE 1CA

600 V
 1500 V / / 1500 V /
 5000 V / / 2500 V /
 200 kA
 20 kA
 Split-Phase

1.5...16 mm² / 1.5...35 mm²

18 mm

3...4.5 Nm

CE; cURus; VDE

IEC61643-11, EN61643-11, UL 1449

with remote signalling (R)

16 / 1.5 / 35
 104.5 / 36 / 68
 250 V 1A 1CO

Wire-end ferrules must be used when connecting finely stranded wire.

Type	Qty.	Order No.
VPU AC II 2 R 750/35	1	2591310000

Pluggable spare arrester L-N: VPU AC II 0 750/35 - 25912900000

Type II - 750 V / 35 kA

- Back-up fuse not necessary up to 315 A
- Pluggable, coded arrester
- High energy absorption with short response time
- No follow current
- Installation in the distribution board
- Co-ordination with VPU AC Typ I and Typ III

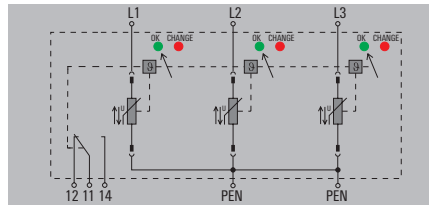
VPU AC II 3 R 750/35**Technical data**

Requirements category acc. to IEC/EN 61643-11
 Energy coordination (≤ 10 m)
 Rated voltage (AC)
 Max. continuous voltage, U_c (L-N / N-PE)
 Low voltage network
 Discharge current I_n (8/20 μ s) (Ader-PE / N-PE)
 Discharge current I_{max} (8/20 μ s) (Ader-PE / N-PE)
 Protection level U_p at I_n (L/N-PE)
 Protection level U_p at I_n (N-PE)
 Fuse

Short-circuit current rating I_{scCR}
 Temporary surge voltage (over-voltage) - TOV
 Response time
 Optical function display
 Design
 Ambient temperature (operational)
 Operating altitude

UL values

Category
 Rated Voltage U_n
 Max. continuous voltage MCOV (L-L / L-N / L-G / N-G)
 Protection level VPR (L-L / L-N / L-G / N-G)
 SCCR
 I_n
 UL Energy Networks

Connection data

Solid / Stranded
 Stripping length
 Tightening torque

Approvals

Approvals
 Standards

Dimensions / Remote signalling contact info

Clamping range (nominal / min. / max.) mm²
 Height x width x depth mm
 Signalling contact

Note**Ordering data**

with remote signalling contact (R)

Note**Accessories****Note**

Type II, Type III / T2, T3
 Type II, Type III
 690 V
 750 V /
 TN-C
 20 kA /
 35 kA /
 ≤ 3.4 kV

No Fuse necessary ≤ 315 A gG, 250 A gG @50 kA I_{scCR} , 315 A gG @25 kA I_{scCR}

50 kA
 871 V
 ≤ 25 ns
 green = OK; red = arrester is defective - replace
 Installation housing: 3TE, Insta IP 20
 -40 °C... 85 °C
 ≤ 4000 m

SPD TYPE 1CA
 600 V
 1500 V / / 750 V /
 5000 V / / 2500 V /
 200 kA
 20 kA
 Delta System

1.5...16 mm² / 1.5...35 mm²
 18 mm
 3...4.5 Nm

CE; cURus; VDE
 IEC 61643-11, EN 61643-11, UL 1449

with remote signalling (R)

16 / 1.5 / 35
 104.5 / 54 / 68
 250 V 1A 1CO

Wire-end ferrules must be used when connecting finely stranded wire.

Type	Qty.	Order No.
VPU AC II 3 R 750/35	1	2591320000

Pluggable spare arrester L-N: VPU AC II 0 750/35 - 25912900000



Type II - 1000 V / 40 kA

- Pluggable arrester
- Coded voltage level
- High energy absorption with short time to sparkover
- Insert can be rotated through 180°
- No follow-on current
- Installation in distribution board
- Thermal protection function

VPU II 1 (R) 1000/40 AC

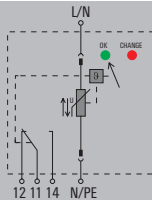

Technical data

Requirements category acc. to IEC/EN 61643-11
 Energy coordination (≤ 10 m)
 Rated voltage (AC)
 Max. continuous voltage, U_c (L-N / N-PE)
 Low voltage network
 Discharge current I_n (8/20 μ s) (Ader-PE / N-PE)
 Discharge current I_{max} (8/20 μ s) (Ader-PE / N-PE)
 Protection level U_p at I_n (L/N-PE)
 Protection level U_p at I_n (N-PE)
 Fuse

Short-circuit current rating I_{scCR}
 Temporary surge voltage (over-voltage) - TOV
 Response time
 Optical function display
 Design
 Ambient temperature (operational)
 Operating altitude

Connection data

Solid / Stranded
 Stripping length
 Tightening torque

Approvals

Approvals
 Standards

Type II / T2
 Type II, Type III
 830 V
 1000 V /
 Single-phase, TN
 20 kA /
 40 kA /
 ≤ 3.7 kV

125 A gL > (if back up fuse > 125 A), No Fuse necessary ≤ 125 A gG

25 kA
 1205 V
 ≤ 25 ns
 green = OK; red = arrester is defective - replace
 Installation housing; 1TE, Insta IP 20
 -40 °C...70 °C

1.5...16 mm² / 1.5...50 mm²
 15 mm
 2...3 Nm

CE
 IEC 61643-11, EN 61643-11

Dimensions / Remote signalling contact info

Clamping range (nominal / min. / max.) mm²
 Height x width x depth mm
 Signalling contact

Note

no remote sig. contact with remote signalling (R)

16 / 1.5 / 35	16 / 1.5 / 35
94 / 17.8 / 69	106 / 17.8 / 69
No	250 V 1A 1CO

Wire-end ferrules must be used when connecting finely stranded wire.

Ordering data

without remote signalling contact
 with remote signalling contact (R)

Type	Qty.	Order No.
VPU II 1 1000V/40KA AC	1	1473440000
VPU II 1 R 1000V/40KA AC	1	2811930000

Note

Accessories

Note

Spare arrester VPU II 0 1000 V/40 kA -1549700000



**Type II - N-PE**

- Tested in accordance with IEC/EN 61643-11
- Pluggable, coded N-PE arrester class II and III
- High energy absorption with short response time
- Installation in the distribution board
- Co-ordination with VPU AC Typ I and Typ III

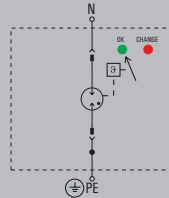
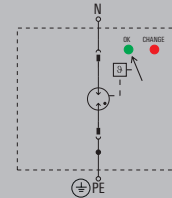
VPU AC II 1 N-PE 305/65**VPU AC II US 1 N-PE 240/65****Technical data**

Requirements category acc. to IEC/EN 61643-11
 Energy coordination (≤ 10 m)
 Rated voltage (AC)
 Max. continuous voltage, U_c (L-N / N-PE)
 Low voltage network
 Discharge current I_n (8/20 μ s) (Ader-PE / N-PE)
 Discharge current I_{max} (8/20 μ s) (Ader-PE / N-PE)
 Protection level U_p at I_n (L/N-PE)
 Protection level U_p at I_n (N-PE)
 Fuse

Short-circuit current rating I_{SCCR}
 Temporary surge voltage (over-voltage) - TOV
 Response time
 Optical function display
 Design
 Ambient temperature (operational)
 Operating altitude

UL values

Category
 Rated Voltage U_n
 Max. continuous voltage MCOV (L-L / L-N / L-G / N-G)
 Protection level VPR (L-L / L-N / L-G / N-G)
 SCCR
 I_n
 UL Energy Networks

Connection data

Solid / Stranded
 Stripping length
 Tightening torque

Approvals

Approvals
 Standards

Dimensions / Remote signalling contact info

Clamping range (nominal / min. / max.) mm²
 Height x width x depth mm
 Signalling contact

Note

Type II, Type III / T2, T3
 Type II, Type III
 230 V
 / 305 V
 Single-phase, TN, TT nur für N-PE
 / 40 kA
 / 65 kA

≤ 1.5 kV
 Not required

0.1 kA
 1200 V
 ≤ 100 ns
 green = OK; red = arrester is defective - replace
 Installation housing; 1TE, Insta IP 20
 -40 °C...85 °C
 ≤ 4000 m

SPD TYPE 1CA
 240 V
 / / / 305 V
 / / / 1000 V

20 kA
 Single Pole N-PE

1.5...16 mm² / 1.5...35 mm²
 18 mm
 3...4.5 Nm

CE; cURus; VDE
 IEC 61643-11, EN 61643-11, UL 1449

no remote sig. contact

16 / 1.5 / 35
 90 / 18 / 68
 No

Wire-end ferrules must be used when connecting finely stranded wire.

Type II / T2
 Type II, Type III
 230 V
 / 305 V
 Single-phase, TN, TT nur für N-PE
 / 40 kA
 / 65 kA

≤ 1.5 kV

0.1 kA
 1200 V
 ≤ 100 ns
 green = OK; red = arrester is defective - replace
 Installation housing; 1TE, Insta IP 20
 -40 °C...85 °C
 ≤ 4000 m

SPD TYPE 1
 240 V
 / / / 305 V
 / / / 1000 V

200 kA
 20 kA
 Single Pole N-PE

1.5...16 mm² / 2.5...35 mm²
 18 mm
 3...4.5 Nm

CE; cULus; VDE
 IEC 61643-11, EN 61643-11, UL 1449, NFPA 79

no remote sig. contact

16 / 1.5 / 35
 90 / 18 / 68
 No

Wire-end ferrules must be used when connecting finely stranded wire.

Ordering data

without remote signalling contact

Type	Qty.	Order No.
VPU AC II 1 N-PE 305/65	1	2591180000

Type	Qty.	Order No.
VPU AC II US 1 N-PE 240/65	1	2730800000

Note**Accessories****Note**

Pluggable spare arrester N-PE: VPU AC II 0 N-PE 305/65 - 2591190000

Pluggable spare arrester N-PE: VPU AC II US 0 N-PE 240/65 - 2726820000

Reliable planning for the choice of surge protection VARITECTOR PU AC II F with integrated fuse

In industrial facilities, private and public buildings as well as in systems for regenerative energy generation, the power distribution systems must be equipped with suitable surge protection. This reliably prevents cost-intensive lightning and overvoltage damage.

The proven surge protection devices of the VPU AC II series are also available in variants with integrated fuses. This eliminates the need for an additional fuse before the surge protection device. The combined type II+III surge protection devices have one back-up fuse per protective path and can be used universally in power distribution systems. The application-oriented pluggable product configurations allow flexible use in different network types.

Your special advantages:

- Optimum protection thanks to integrated fuse and high discharge currents
- Reduced wiring by sacrificing pre-fuse
- Flexible application in all power distribution systems
- Convenient installation and maintenance due to pluggable modules
- Particularly compact with space-saving design

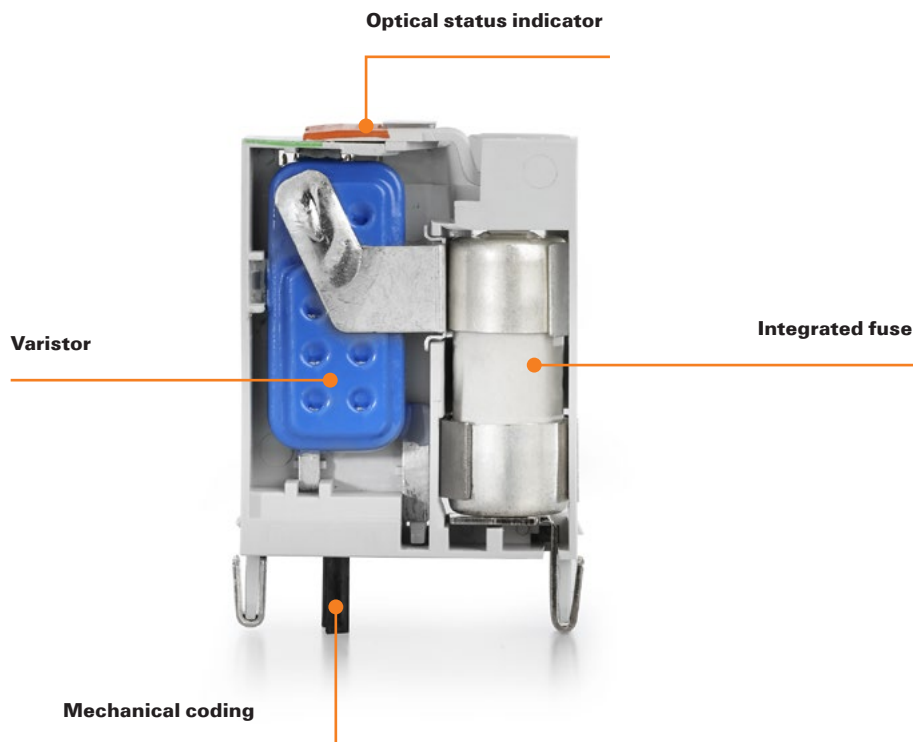



Compact design

The pluggable and thus particularly maintenancefriendly arresters have a width of only 18 mm per protective path.



Maximum protection

The surge protection devices with integrated fuse offer optimum protection thanks to 20 kA rated discharge current and 40 kA maximum discharge current.



Universal application

Dimensioning is independent of the main fuse rating – no additional pre-fuse is required, even above 315 A. The wiring effort is reduced to a minimum for all energy sources. The wiring effort can thus be minimised for all power distributions.

Type II - Integrated fuse

- Fuse integrated in the arrester
- Pluggable, coded arrester
- High energy absorption with short response time
- No follow current
- Installation in the distribution board
- Co-ordination with VPU AC Typ I and Typ III

VPU AC II F 1 (R) 300/40

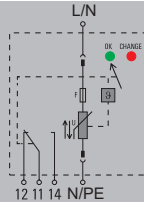

VPU AC II F 1+1 (R) 300/40

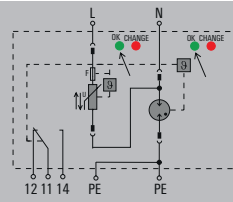

Technical data

Requirements category acc. to IEC/EN 61643-11
 Energy coordination (≤ 10 m)
 Rated voltage (AC)
 Max. continuous voltage, U_c (L-N / N-PE)
 Low voltage network
 Discharge current I_a (8/20 μ s) (Ader-PE / N-PE)
 Discharge current I_{max} (8/20 μ s) (Ader-PE / N-PE)
 Protection level U_p at I_a (L/N-PE)
 Protection level U_p at I_a (N-PE)
 Fuse

Short-circuit current rating I_{scCR}
 Temporary surge voltage (over-voltage) - TOV
 Response time
 Optical function display
 Design
 Ambient temperature (operational)
 Operating altitude

Connection data

Solid / Stranded
 Stripping length
 Tightening torque

Approvals

Approvals
 Standards

Type II, Type III / T2, T3

Type II, Type III

230 V

300 V /

Single-phase, TN

20 kA /

40 kA /

≤ 1.5 kV

Not required, internally available

100 kA

337 V

≤ 25 ns

green = OK; red = arrester is defective - replace

Installation housing; 1TE, Insta IP 20

-40 °C...85 °C

≤ 4000 m

1.5...16 mm² / 1.5...25 mm²

18 mm

3...4.5 Nm

CE

IEC 61643-11, EN 61643-11

Type II, Type III / T2, T3

Type II, Type III

230 V

300 V / 305 V

Single-phase, TN, TT, IT with N, IT without N

20 kA / 40 kA

40 kA / 65 kA

≤ 1.5 kV

≤ 1.5 kV

Not required, internally available

100 kA

337 V

≤ 25 ns

green = OK; red = arrester is defective - replace

Installation housing; 2TE, Insta IP 20

-40 °C...85 °C

≤ 4000 m

1.5...16 mm² / 1.5...25 mm²

18 mm

3...4.5 Nm

CE

IEC 61643-11, EN 61643-11

Dimensions / Remote signalling contact info

Clamping range (nominal / min. / max.) mm²
 Height x width x depth mm
 Signalling contact

Note

no remote sig. contact

16 / 1.5 / 35
 90 / 18 / 68
 No

Wire-end ferrules must be used when connecting finely stranded wire.

with remote signalling (R)

16 / 1.5 / 35
 111 / 18 / 68
 250 V 1A 1CO

no remote sig. contact

16 / 1.5 / 35
 90 / 36 / 68
 No

Wire-end ferrules must be used when connecting finely stranded wire.

with remote signalling (R)

16 / 1.5 / 35
 104.5 / 36 / 68
 250 V 1A 1CO

Ordering data

without remote signalling contact
 with remote signalling contact (R)

Type	Qty.	Order No.
VPU AC II F 1 300/40	1	2827580000
VPU AC II F 1 R 300/40	1	2807390000

Type	Qty.	Order No.
VPU AC II F 1+1 300/40	1	2827620000
VPU AC II F 1+1 R 300/40	1	2807430000

Note

Only for IT networks where the earth at the distribution transformer is connected to the earth on the customer side.

Accessories

Note

Pluggable spare arrester L-N: VPU AC II F 0 300/40 - 2807520000

Pluggable spare arrester L-N: VPU AC II F 0 300/40 - 2807520000;
 N-PE: VPU AC II F 0 N-PE 305/65 - 2807540000

Type II - Integrated fuse

- Fuse integrated in the arrester
- Pluggable, coded arrester
- High energy absorption with short response time
- No follow current
- Installation in the distribution board
- Co-ordination with VPU AC Typ I and Typ III

VPU AC II F 2 (R) 300/40

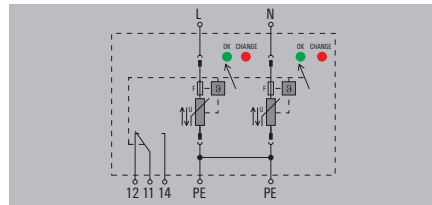

VPU AC II F 3 (R) 300/40

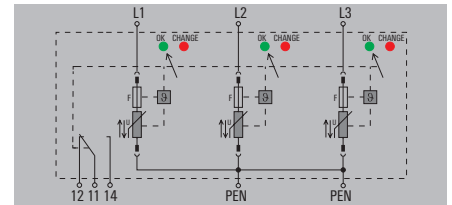

Technical data

Requirements category acc. to IEC/EN 61643-11
 Energy coordination (≤ 10 m)
 Rated voltage (AC)
 Max. continuous voltage, U_c (L-N / N-PE)
 Low voltage network
 Discharge current I_a (8/20 μ s) (Ader-PE / N-PE)
 Discharge current I_{max} (8/20 μ s) (Ader-PE / N-PE)
 Protection level U_p at I_a (L/N-PE)
 Protection level U_p at I_a (N-PE)
 Fuse

Short-circuit current rating I_{scCR}
 Temporary surge voltage (over-voltage) - TOV
 Response time
 Optical function display
 Design
 Ambient temperature (operational)
 Operating altitude

Connection data

Solid / Stranded
 Stripping length
 Tightening torque

Approvals

Approvals
 Standards

Type II, Type III / T2, T3

Type II, Type III

230 V

300 V /

Single-phase, TN-S

20 kA /

40 kA /

 ≤ 1.5 kV

Not required, internally available

100 kA

337 V

 ≤ 25 ns

green = OK; red = arrester is defective - replace

Installation housing; 2TE, Insta IP 20

-40 °C...85 °C

 ≤ 4000 m1.5...16 mm² / 1.5...25 mm²

18 mm

3...4.5 Nm

CE

IEC 61643-11, EN 61643-11

Type II, Type III / T2, T3

Type II, Type III

230 V

300 V /

TN-C

20 kA /

40 kA /

 ≤ 1.5 kV

Not required, internally available

100 kA

337 V

 ≤ 25 ns

green = OK; red = arrester is defective - replace

Installation housing; 3TE, Insta IP 20

-40 °C...85 °C

 ≤ 4000 m1.5...16 mm² / 1.5...25 mm²

18 mm

3...4.5 Nm

CE

IEC 61643-11, EN 61643-11

Dimensions / Remote signalling contact info

Clamping range (nominal / min. / max.) mm²
 Height x width x depth mm
 Signalling contact

Note

no remote sig. contact

16 / 1.5 / 35
 90 / 36 / 68
 No

Wire-end ferrules must be used when connecting finely stranded wire.

with remote signalling (R)

16 / 1.5 / 35
 104.5 / 36 / 68
 250 V 1A 1CO

no remote sig. contact

16 / 1.5 / 35
 90 / 54 / 68
 No

Wire-end ferrules must be used when connecting finely stranded wire.

with remote signalling (R)

16 / 1.5 / 35
 104.5 / 54 / 68
 250 V 1A 1CO

Ordering data

without remote signalling contact
 with remote signalling contact (R)

Note

Type	Qty.	Order No.
VPU AC II F 2 300/40	1	2827590000
VPU AC II F 2 R 300/40	1	2807400000

Type	Qty.	Order No.
VPU AC II F 3 300/40	1	2827600000
VPU AC II F 3 R 300/40	1	2807410000

Accessories

Note

Pluggable spare arrester L-N: VPU AC II F 0 300/40 - 2807520000

Pluggable spare arrester L-N: VPU AC II F 0 300/40 - 2807520000



Type II - Integrated fuse

- Fuse integrated in the arrester
- Pluggable, coded arrester
- High energy absorption with short response time
- No follow current
- Installation in the distribution board
- Co-ordination with VPU AC Typ I and Typ III

VPU AC II F 3+1 (R) 300/40

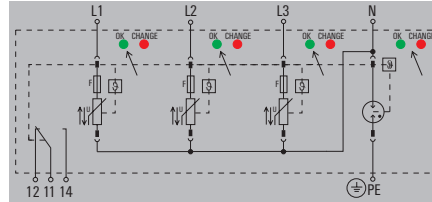

VPU AC II F 4 (R) 300/40

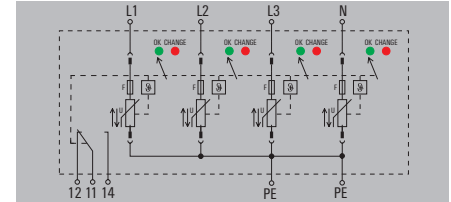

Technical data

Requirements category acc. to IEC/EN 61643-11
 Energy coordination (≤ 10 m)
 Rated voltage (AC)
 Max. continuous voltage, U_c (L-N / N-PE)
 Low voltage network
 Discharge current I_a (8/20 μ s) (Ader-PE / N-PE)
 Discharge current I_{max} (8/20 μ s) (Ader-PE / N-PE)
 Protection level U_p at I_a (L/N-PE)
 Protection level U_p at I_a (N-PE)
 Fuse

Short-circuit current rating I_{SCCR}
 Temporary surge voltage (over-voltage) - TOV
 Response time
 Optical function display
 Design
 Ambient temperature (operational)
 Operating altitude

Connection data

Solid / Stranded
 Stripping length
 Tightening torque

Approvals

Approvals
 Standards

Type II, Type III / T2, T3
 Type II, Type III
 230 V
 300 V / 305 V
 TN-C-S, TN-S, TT, IT with N, IT without N
 20 kA / 40 kA
 40 kA / 65 kA
 ≤ 1.5 kV
 ≤ 1.5 kV
 Not required, internally available

100 kA
 337 V
 ≤ 25 ns
 green = OK; red = arrester is defective - replace
 Installation housing: 4TE, Insta IP 20
 -40 °C... 85 °C
 ≤ 4000 m

1.5...16 mm² / 1.5...25 mm²
 18 mm
 3...4.5 Nm

CE
 IEC 61643-11, EN 61643-11

Type II, Type III / T2, T3
 Type II, Type III
 230 V
 300 V /
 TN-S
 20 kA /
 40 kA /
 ≤ 1.5 kV
 Not required, internally available

100 kA
 337 V
 ≤ 25 ns
 green = OK; red = arrester is defective - replace
 Installation housing: 4TE, Insta IP 20
 -40 °C... 85 °C
 ≤ 4000 m

1.5...16 mm² / 1.5...25 mm²
 18 mm
 3...4.5 Nm

CE
 IEC 61643-11, EN 61643-11

Dimensions / Remote signalling contact info

Clamping range (nominal / min. / max.) mm²
 Height x width x depth mm
 Signalling contact

Note

no remote sig. contact with remote signalling (R)

16 / 1.5 / 35 16 / 1.5 / 35
 90 / 72 / 68 104.5 / 72 / 68
 No 250 V 1A 1CO

Wire-end ferrules must be used when connecting finely stranded wire.

no remote sig. contact with remote signalling (R)

16 / 1.5 / 35 16 / 1.5 / 35
 90 / 72 / 68 104.5 / 72 / 68
 No 250 V 1A 1CO

Wire-end ferrules must be used when connecting finely stranded wire.

Ordering data

without remote signalling contact
 with remote signalling contact (R)

Type	Qty.	Order No.
VPU AC II F 3+1 300/40	1	2827630000
VPU AC II F 3+1 R 300/40	1	2807440000

Type	Qty.	Order No.
VPU AC II F 4 300/40	1	2827610000
VPU AC II F 4 R 300/40	1	2807420000

Note

Only for IT networks where the earth at the distribution transformer is connected to the earth on the customer side.

Accessories

Note

Pluggable spare arrester L-N: VPU AC II F 0 300/40 - 2807520000;
 N-PE: VPU AC II F 0 N-PE 305/65 - 2807540000

Pluggable spare arrester L-N: VPU AC II F 0 300/40 - 2807520000



High-performance surge protection for the North American market

VARITECTOR PU AC US meets the requirements of NFPA 79

In the North American market, electrical installations need to have surge protection. The current safety standard NFPA 79 defines the use of surge protection devices in machines with safety circuits.

According to NFPA 79, surge protection products must ensure voltage limitation according to the insulation coordination. This requirement is met by devices of the VARITECTOR PU US series. They are UL listed, which includes the requirements of NFPA 79. The product series has been specially adapted to the North American market. In addition to the requirements of UL 1449, it also meets the EN 61643-11 standard and can therefore be applied worldwide.

Your special advantages:

- Compliance with NFPA 79 for the entire product series
- UL-Listed Mark of conformity on all product variants
- Simplified approval of plants used for the North American
- Worldwide applicable due to simultaneous compliance with EN 61643-11





Powerful protection

The specially developed integrated disconnection mechanism enables safe operation with a short-circuit resistance (SCCR) of up to 200 kA. All products are approved as Type 1 CA according to the highest UL classification.



Complete status control

All products in the VPU AC series have a highly visible optical indicator. Variants with pre-warning status indication also ensure uninterrupted protection, as the integrated remote signalling contact already reports the pre-warning signal to external monitoring systems.

Made for worldwide use

The products have been adapted to the North American grounding networks such as WYE or DELTA. They are simultaneously approved to UL 1449 and VDE – for worldwide use in any application.



Type II US - 60 V UL 1449 & NFPA 79

- Back-up fuse not necessary up to 315 A
- Pluggable, coded arrester
- High energy absorption with short response time
- Installation in the distribution board
- Co-ordination with VPU AC Type I
- Approved according to IEC/EN 61643-11
- Approved according to UL 1449 and NFPA 79

VPU AC II US 1 (R) 60/50

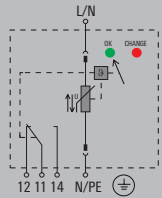

VPU AC II US 2 (R) 60/50

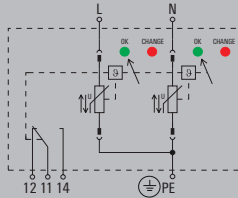

Technical data

Requirements category acc. to IEC/EN 61643-11
 Energy coordination (≤ 10 m)
 Rated voltage (AC)
 Max. continuous voltage, U_c (L-N / N-PE)
 Low voltage network
 Discharge current I_n (8/20 μ s) (Ader-PE / N-PE)
 Discharge current I_{max} (8/20 μ s) (Ader-PE / N-PE)
 Protection level U_p at I_n (L/N-PE)
 Protection level U_p at I_n (N-PE)
 Fuse

Short-circuit current rating I_{scCR}
 Temporary surge voltage (over-voltage) - TOV
 Response time
 Optical function display
 Design
 Ambient temperature (operational)
 Operating altitude

UL values

Category
 Rated Voltage U_n
 Max. continuous voltage MCOV (L-L / L-N / L-G / N-G)
 Protection level VPR (L-L / L-N / L-G / N-G)
 SCCR
 I_n
 UL Energy Networks

Connection data

Solid / Stranded
 Stripping length
 Tightening torque

Approvals

Approvals
 Standards

Dimensions / Remote signalling contact info

Clamping range (nominal / min. / max.) mm²
 Height x width x depth mm
 Signalling contact

Note

Ordering data

without remote signalling contact
 with remote signalling contact (R)

Note

Accessories

Note

Type II / T2
 Type II, Type III
 60 V
 75 V /
 Single-phase, TN
 20 kA /
 50 kA /
 ≤ 0.8 kV

No Fuse necessary ≤ 315 A gG, 250 A gG @50 kA Isccr, 315 A gG @25 kA Isccr

50 kA
 114 V
 ≤ 25 ns
 green = OK; red = arrester is defective - replace

Installation housing; 1TE, Insta IP 20
 -40 °C...85 °C
 ≤ 4000 m

SPD TYPE 1

60 V
 / / 75 V /
 / / 330 V /
 100 kA
 20 kA
 Split-Phase

1.5...16 mm² / 2.5...35 mm²
 18 mm
 2...4.5 Nm

CE; cULus; VDE
 IEC 61643-11, EN 61643-11, UL 1449, NFPA 79

no remote sig. contact	with remote signalling (R)
16 / 1.5 / 35	16 / 1.5 / 35
90 / 18 / 68	111 / 18 / 68
No	250 V 1A 1CO

Wire-end ferrules must be used when connecting finely stranded wire.

Type	Qty.	Order No.
VPU AC II US 1 60/50	1	2736210000
VPU AC II US 1 R 60/50	1	2736270000

Pluggable spare arrester L-N: VPU AC II US 0 60/50 - 2726810000

Type II / T2
 Type II, Type III
 60 V
 75 V /
 Single-phase, TN-S
 20 kA /
 50 kA /
 ≤ 0.8 kV

No Fuse necessary ≤ 315 A gG, 250 A gG @50 kA Isccr, 315 A gG @25 kA Isccr

50 kA
 114 V
 ≤ 25 ns
 green = OK; red = arrester is defective - replace

Installation housing; 2TE, Insta IP 20
 -40 °C...85 °C
 ≤ 4000 m

SPD TYPE 1

60 V
 / 150 V / 75 V / 75 V
 / 700 V / 330 V / 330 V
 100 kA
 20 kA
 Split-Phase

1.5...16 mm² / 2.5...35 mm²
 18 mm
 2...4.5 Nm

CE; cULus; VDE
 IEC 61643-11, EN 61643-11, UL 1449, NFPA 79

no remote sig. contact	with remote signalling (R)
16 / 1.5 / 35	16 / 1.5 / 35
90 / 36 / 68	104.5 / 36 / 68
No	250 V 1A 1CO

Wire-end ferrules must be used when connecting finely stranded wire.

Type	Qty.	Order No.
VPU AC II US 2 60/50	1	2736280000
VPU AC II US 2 R 60/50	1	2730790000

Pluggable spare arrester L-N: VPU AC II US 0 60/50 - 2726810000





Type II US - 120 V UL 1449 & NFPA 79

- Back-up fuse not necessary up to 315 A
- Pluggable, coded arrester
- High energy absorption with short response time
- Installation in the distribution board
- Co-ordination with VPU AC Type I
- Approved according to IEC/EN 61643-11
- Approved according to UL 1449 and NFPA 79

VPU AC II US 1 (R) 120/50

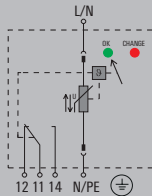

VPU AC II US 2 (R) 120/50

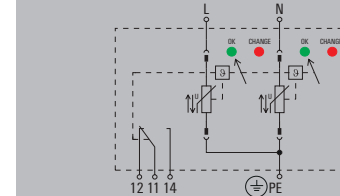

Technical data

Requirements category acc. to IEC/EN 61643-11
 Energy coordination (≤ 10 m)
 Rated voltage (AC)
 Max. continuous voltage, U_c (L-N / N-PE)
 Low voltage network
 Discharge current I_a (8/20 μ s) (Ader-PE / N-PE)
 Discharge current I_{max} (8/20 μ s) (Ader-PE / N-PE)
 Protection level U_p at I_a (L/N-PE)
 Protection level U_p at I_a (N-PE)
 Fuse

Short-circuit current rating I_{scCR}
 Temporary surge voltage (over-voltage) - TOV
 Response time
 Optical function display
 Design
 Ambient temperature (operational)
 Operating altitude

UL values

Category
 Rated Voltage U_n
 Max. continuous voltage MCOV (L-L / L-N / L-G / N-G)
 Protection level VPR (L-L / L-N / L-G / N-G)
 SCCR
 I_a
 UL Energy Networks

Connection data

Solid / Stranded
 Stripping length
 Tightening torque

Approvals

Approvals
 Standards

Dimensions / Remote signalling contact info

Clamping range (nominal / min. / max.) mm²
 Height x width x depth mm
 Signalling contact

Note

Ordering data

without remote signalling contact
 with remote signalling contact (R)

Note

Accessories

Note

Type II / T2
 Type II, Type III
 120 V
 150 V /
 Single-phase
 20 kA /
 50 kA /
 ≤ 1.25 kV

No Fuse necessary ≤ 315 A gG, 250 A gG @50 kA Isccr, 315 A gG @25 kA Isccr

50 kA
 229 V
 ≤ 25 ns
 green = OK; red = arrester is defective - replace

Installation housing; 1TE, Insta IP 20
 -40 °C...85 °C
 ≤ 4000 m

SPD TYPE 1

120 V
 / / 150 V /
 / / 600 V /
 200 kA
 20 kA
 Split-Phase

1.5...16 mm² / 2.5...35 mm²
 18 mm
 2...4.5 Nm

CE; cULus; VDE
 IEC 61643-11, EN 61643-11, UL 1449, NFPA 79

no remote sig. contact with remote signalling (R)

16 / 1.5 / 35	16 / 1.5 / 35
90 / 18 / 68	111 / 18 / 68
No	250 V 1A 1CO

Wire-end ferrules must be used when connecting finely stranded wire.

Type	Qty.	Order No.
VPU AC II US 1 120/50	1	2730450000
VPU AC II US 1 R 120/50	1	2730460000

Pluggable spare arrester L-N: VPU AC II US 0 120/50 - 2730440000

Type II / T2
 Type II, Type III
 120 V
 150 V /
 Single-phase, TN-S
 20 kA /
 50 kA /
 ≤ 1.25 kV

No Fuse necessary ≤ 315 A gG, 250 A gG @50 kA Isccr, 315 A gG @25 kA Isccr

50 kA
 229 V
 ≤ 25 ns
 green = OK; red = arrester is defective - replace

Installation housing; 2TE, Insta IP 20
 -40 °C...85 °C
 ≤ 4000 m

SPD TYPE 1

120 V
 / 300 V / 150 V / 150 V
 / 1000 V / 600 V / 600 V
 200 kA
 20 kA
 Split-Phase

1.5...16 mm² / 2.5...35 mm²
 18 mm
 2...4.5 Nm

CE; cULus; VDE
 IEC 61643-11, EN 61643-11, UL 1449, NFPA 79

no remote sig. contact with remote signalling (R)

16 / 1.5 / 35	16 / 1.5 / 35
90 / 36 / 68	104.5 / 36 / 68
No	250 V 1A 1CO

Wire-end ferrules must be used when connecting finely stranded wire.

Type	Qty.	Order No.
VPU AC II US 2 120/50	1	2730470000
VPU AC II US 2 R 120/50	1	2730480000

Pluggable spare arrester L-N: VPU AC II US 0 120/50 - 2730440000

Type II US - 120 V UL 1449 & NFPA 79

- Back-up fuse not necessary up to 315 A
- Pluggable, coded arrester
- High energy absorption with short response time
- Installation in the distribution board
- Co-ordination with VPU AC Type I
- Approved according to IEC/EN 61643-11
- Approved according to UL 1449 and NFPA 79

VPU AC II US 3 (R) 120/50

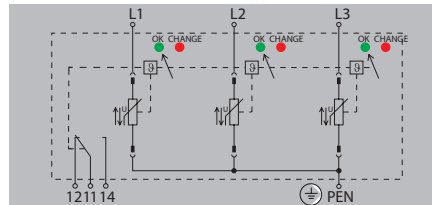

VPU AC II US 4 (R) 120/50

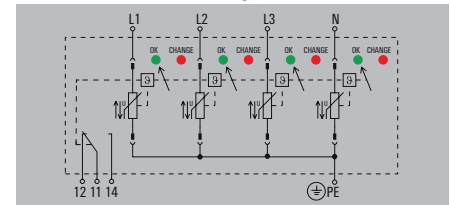

Technical data

Requirements category acc. to IEC/EN 61643-11
 Energy coordination (≤ 10 m)
 Rated voltage (AC)
 Max. continuous voltage, U_c (L-N / N-PE)
 Low voltage network
 Discharge current I_a (8/20 μ s) (Ader-PE / N-PE)
 Discharge current I_{max} (8/20 μ s) (Ader-PE / N-PE)
 Protection level U_p at I_a (L/N-PE)
 Protection level U_p at I_a (N-PE)
 Fuse

Short-circuit current rating I_{scCR}
 Temporary surge voltage (over-voltage) - TOV
 Response time
 Optical function display
 Design
 Ambient temperature (operational)
 Operating altitude

UL values

Category
 Rated Voltage U_n
 Max. continuous voltage MCOV (L-L / L-N / L-G / N-G)
 Protection level VPR (L-L / L-N / L-G / N-G)
 SCCR
 I_a
 UL Energy Networks

Connection data

Solid / Stranded
 Stripping length
 Tightening torque

Approvals

Approvals
 Standards

Dimensions / Remote signalling contact info

Clamping range (nominal / min. / max.) mm²
 Height x width x depth mm
 Signalling contact

Note

Ordering data

without remote signalling contact
 with remote signalling contact (R)

Note

Accessories

Note

Type II / T2
 Type II, Type III
 120 V
 150 V /
 TN-C
 20 kA /
 50 kA /
 ≤ 1.25 kV

No Fuse necessary ≤ 315 A gG, 250 A gG @50 kA I_{scCR} , 315 A gG @25 kA I_{scCR}

50 kA
 229 V
 ≤ 25 ns
 green = OK; red = arrester is defective - replace

Installation housing: 3TE, Insta IP 20
 -40 °C...85 °C
 ≤ 4000 m

SPD TYPE 1

120 V
 300 V / / 150 V /
 1000 V / / 600 V /
 200 kA
 20 kA
 3-phase WYE

1.5...16 mm² / 2.5...35 mm²
 18 mm
 2...4.5 Nm

CE; cULus; VDE
 IEC 61643-11, EN 61643-11, UL 1449, NFPA 79

no remote sig. contact	with remote signalling (R)
16 / 1.5 / 35	16 / 1.5 / 35
90 / 54 / 68	104.5 / 54 / 68
No	250 V 1A 1CO

Wire-end ferrules must be used when connecting finely stranded wire.

Type	Qty.	Order No.
VPU AC II US 3 120/50	1	2730510000
VPU AC II US 3 R 120/50	1	2730520000

Pluggable spare arrester L-N: VPU AC II US 0 120/50 - 2730440000

Type II / T2
 Type II, Type III
 120 V
 150 V /
 TN-C-S, TN-S
 20 kA / 40 kA
 50 kA / 50 kA
 ≤ 1.25 kV
 ≤ 1.25 kV

No Fuse necessary ≤ 315 A gG, 250 A gG @50 kA I_{scCR} , 315 A gG @25 kA I_{scCR}

50 kA
 229 V
 ≤ 25 ns
 green = OK; red = arrester is defective - replace

Installation housing: 4TE, Insta IP 20
 -40 °C...85 °C
 ≤ 4000 m

SPD TYPE 1

120 V
 300 V / 300 V / 150 V / 150 V
 1000 V / 1000 V / 600 V / 600 V
 200 kA
 20 kA
 3-phase WYE

1.5...16 mm² / 2.5...35 mm²
 18 mm
 2...4.5 Nm

CE; cULus; VDE
 IEC 61643-11, EN 61643-11, UL 1449, NFPA 79

no remote sig. contact	with remote signalling (R)
16 / 1.5 / 35	16 / 1.5 / 35
90 / 72 / 68	104.5 / 72 / 68
No	250 V 1A 1CO

Wire-end ferrules must be used when connecting finely stranded wire.

Type	Qty.	Order No.
VPU AC II US 4 120/50	1	2730490000
VPU AC II US 4 R 120/50	1	2730500000

Pluggable spare arrester L-N: VPU AC II US 0 120/50 - 2730440000





Type II US - 240 V UL 1449 & NFPA 79

- Back-up fuse not necessary up to 315 A
- Pluggable, coded arrester
- High energy absorption with short response time
- Installation in the distribution board
- Co-ordination with VPU AC Type I
- Approved according to IEC/EN 61643-11
- Approved according to UL 1449 and NFPA 79

VPU AC II US 1 (R) 240/50

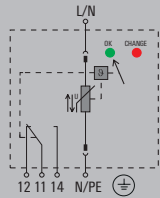

VPU AC II US 1+1 (R) 240/50

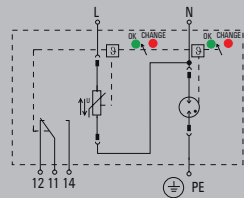

Technical data

Requirements category acc. to IEC/EN 61643-11
 Energy coordination (≤ 10 m)
 Rated voltage (AC)
 Max. continuous voltage, U_c (L-N / N-PE)
 Low voltage network
 Discharge current I_n (8/20 μ s) (Ader-PE / N-PE)
 Discharge current I_{max} (8/20 μ s) (Ader-PE / N-PE)
 Protection level U_p at I_n (L/N-PE)
 Protection level U_p at I_n (N-PE)
 Fuse

Short-circuit current rating I_{scCR}
 Temporary surge voltage (over-voltage) - TOV
 Response time
 Optical function display
 Design
 Ambient temperature (operational)
 Operating altitude

UL values

Category
 Rated Voltage U_n
 Max. continuous voltage MCOV (L-L / L-N / L-G / N-G)
 Protection level VPR (L-L / L-N / L-G / N-G)
 SCCR
 I_n
 UL Energy Networks

Connection data

Solid / Stranded
 Stripping length
 Tightening torque

Approvals

Approvals
 Standards

Dimensions / Remote signalling contact info

Clamping range (nominal / min. / max.) mm²
 Height x width x depth mm
 Signalling contact

Note

Ordering data

without remote signalling contact
 with remote signalling contact (R)

Note

Accessories

Note

Type II / T2
 Type II, Type III
 240 V
 300 V /
 Single-phase, TN
 20 kA /
 50 kA /
 ≤ 1.5 kV

No Fuse necessary ≤ 315 A gG, 250 A gG @50 kA Isccr, 315 A gG @25 kA Isccr

50 kA
 337 V
 ≤ 25 ns
 green = OK; red = arrester is defective - replace
 Installation housing; 1TE, Insta IP 20
 -40 °C... 85 °C
 ≤ 4000 m

SPD TYPE 1

240 V
 / 600 V / 300 V / 300 V
 / 1800 V / 900 V / 900 V
 150 kA
 20 kA
 Split-Phase

1.5...16 mm² / 2.5...35 mm²
 18 mm
 2...4.5 Nm

CE; cULus; VDE
 IEC 61643-11, EN 61643-11, UL 1449, NFPA 79

no remote sig. contact with remote signalling (R)

16 / 1.5 / 35	16 / 1.5 / 35
90 / 18 / 68	111 / 18 / 68
No	250 V 1A 1CO

Wire-end ferrules must be used when connecting finely stranded wire.

Type	Qty.	Order No.
VPU AC II US 1 240/50	1	2736300000
VPU AC II US 1 R 240/50	1	2736310000

Pluggable spare arrester L-N: VPU AC II US 0 240/50 - 2730530000

Type II / T2
 Type II, Type III
 240 V
 300 V / 305 V
 Single-phase, TN, TT, IT with N, IT without N
 20 kA / 40 kA
 50 kA / 65 kA
 ≤ 1.5 kV
 ≤ 1.5 kV

No Fuse necessary ≤ 315 A gG, 250 A gG @50 kA Isccr, 315 A gG @25 kA Isccr

50 kA
 337 V
 ≤ 25 ns
 green = OK; red = arrester is defective - replace
 Installation housing; 2TE, Insta IP 20
 -40 °C... 85 °C
 ≤ 4000 m

SPD TYPE 1

240 V
 / 300 V / 300 V / 305 V
 / 900 V / 1000 V / 1000 V
 150 kA
 20 kA
 Split-Phase

1.5...16 mm² / 2.5...35 mm²
 18 mm
 2...4.5 Nm

CE; cULus; VDE
 IEC 61643-11, EN 61643-11, UL 1449, NFPA 79

no remote sig. contact with remote signalling (R)

16 / 1.5 / 35	16 / 1.5 / 35
90 / 36 / 68	104.5 / 36 / 68
No	250 V 1A 1CO

Wire-end ferrules must be used when connecting finely stranded wire.

Type	Qty.	Order No.
VPU AC II US 1+1 240/50	1	2736340000
VPU AC II US 1+1 R 240/50	1	2736350000

Only for IT networks where the earth at the distribution transformer is connected to the earth on the customer side.

Pluggable spare arrester L-N: VPU AC II US 0 240/50 - 2730530000;
 N-PE: VPU AC II US 0 N-PE 240/65 - 2726820000

Type II US - 240 V UL 1449 & NFPA 79

- Back-up fuse not necessary up to 315 A
- Pluggable, coded arrester
- High energy absorption with short response time
- Installation in the distribution board
- Co-ordination with VPU AC Type I
- Approved according to IEC/EN 61643-11
- Approved according to UL 1449 and NFPA 79

VPU AC II US 2 (R) 240/50

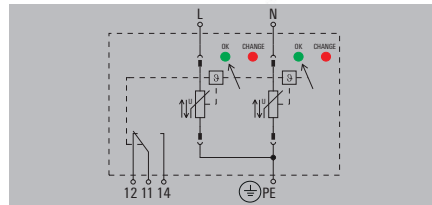

VPU AC II US 3 (R) 240/50

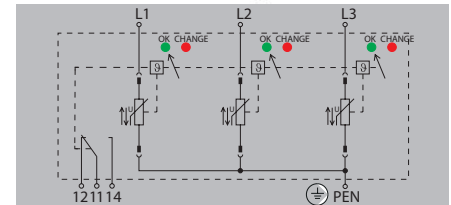

Technical data

Requirements category acc. to IEC/EN 61643-11
 Energy coordination (≤ 10 m)
 Rated voltage (AC)
 Max. continuous voltage, U_c (L-N / N-PE)
 Low voltage network
 Discharge current I_a (8/20 μ s) (Ader-PE / N-PE)
 Discharge current I_{max} (8/20 μ s) (Ader-PE / N-PE)
 Protection level U_p at I_a (L/N-PE)
 Protection level U_p at I_a (N-PE)
 Fuse

Short-circuit current rating I_{scCR}
 Temporary surge voltage (over-voltage) - TOV
 Response time
 Optical function display
 Design
 Ambient temperature (operational)
 Operating altitude

UL values

Category
 Rated Voltage U_n
 Max. continuous voltage MCOV (L-L / L-N / L-G / N-G)
 Protection level VPR (L-L / L-N / L-G / N-G)
 SCCR
 I_a
 UL Energy Networks

Connection data

Solid / Stranded
 Stripping length
 Tightening torque

Approvals

Approvals
 Standards

Dimensions / Remote signalling contact info

Clamping range (nominal / min. / max.) mm²
 Height x width x depth mm
 Signalling contact

Note

Ordering data

without remote signalling contact
 with remote signalling contact (R)

Note

Accessories

Note

Type II / T2
 Type II, Type III
 240 V
 300 V /
 Single-phase, TN-S
 20 kA /
 50 kA /
 ≤ 1.5 kV

No Fuse necessary ≤ 315 A gG, 250 A gG @50 kA I_{scCR} , 315 A gG @25 kA I_{scCR}

50 kA
 337 V
 ≤ 25 ns
 green = OK; red = arrester is defective - replace

Installation housing; 2TE, Insta IP 20
 -40 °C... 85 °C
 ≤ 4000 m

SPD TYPE 1

240 V
 / 600 V / /
 / 1800 V / 900 V / 900 V
 150 kA
 20 kA
 Split-Phase

1.5...16 mm² / 2.5...35 mm²
 18 mm
 2...4.5 Nm

CE; cULus; VDE
 IEC 61643-11, EN 61643-11, UL 1449, NFPA 79

no remote sig. contact	with remote signalling (R)
16 / 1.5 / 35	16 / 1.5 / 35
90 / 36 / 68	104.5 / 36 / 68
No	250 V 1A 1CO

Wire-end ferrules must be used when connecting finely stranded wire.

Type	Qty.	Order No.
VPU AC II US 2 240/50	1	2736320000
VPU AC II US 2 R 240/50	1	2736330000

Pluggable spare arrester L-N: VPU AC II US 0 240/50 - 2730530000

Type II / T2
 Type II, Type III
 240 V
 300 V /
 TN-C
 20 kA /
 50 kA /
 ≤ 1.5 kV

No Fuse necessary ≤ 315 A gG, 250 A gG @50 kA I_{scCR} , 315 A gG @25 kA I_{scCR}

50 kA
 337 V
 ≤ 25 ns
 green = OK; red = arrester is defective - replace

Installation housing; 3TE, Insta IP 20
 -40 °C... 85 °C
 ≤ 4000 m

SPD TYPE 1

240 V
 / 600 V / 300 V /
 1800 V / / 900 V /
 150 kA
 20 kA
 3-phase WYE

1.5...16 mm² / 2.5...35 mm²
 18 mm
 2...4.5 Nm

CE; cULus; VDE
 IEC 61643-11, EN 61643-11, UL 1449, NFPA 79

no remote sig. contact	with remote signalling (R)
16 / 1.5 / 35	16 / 1.5 / 35
90 / 54 / 68	104.5 / 54 / 68
No	250 V 1A 1CO

Wire-end ferrules must be used when connecting finely stranded wire.

Type	Qty.	Order No.
VPU AC II US 3 240/50	1	2730540000
VPU AC II US 3 R 240/50	1	2730550000

Pluggable spare arrester L-N: VPU AC II US 0 240/50 - 2730530000



Type II US - 240 V UL 1449 & NFPA 79

- Back-up fuse not necessary up to 315 A
- Pluggable, coded arrester
- High energy absorption with short response time
- Installation in the distribution board
- Co-ordination with VPU AC Type I
- Approved according to IEC/EN 61643-11
- Approved according to UL 1449 and NFPA 79

VPU AC II US 3+1 (R) 240/50

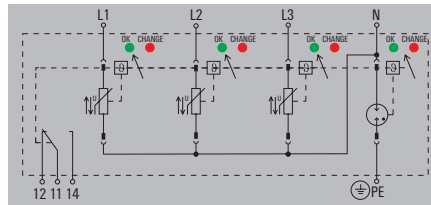

VPU AC II US 4 (R) 240/50

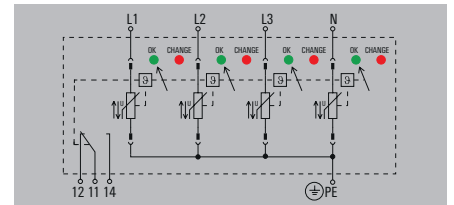

Technical data

Requirements category acc. to IEC/EN 61643-11
 Energy coordination (≤ 10 m)
 Rated voltage (AC)
 Max. continuous voltage, U_c (L-N / N-PE)
 Low voltage network
 Discharge current I_n (8/20 μ s) (Ader-PE / N-PE)
 Discharge current I_{max} (8/20 μ s) (Ader-PE / N-PE)
 Protection level U_p at I_n (L/N-PE)
 Protection level U_p at I_n (N-PE)
 Fuse

Short-circuit current rating I_{scCR}
 Temporary surge voltage (over-voltage) - TOV
 Response time
 Optical function display
 Design
 Ambient temperature (operational)
 Operating altitude

UL values

Category
 Rated Voltage U_n
 Max. continuous voltage MCOV (L-L / L-N / L-G / N-G)
 Protection level VPR (L-L / L-N / L-G / N-G)
 SCCR
 I_n
 UL Energy Networks

Connection data

Solid / Stranded
 Stripping length
 Tightening torque

Approvals

Approvals
 Standards

Dimensions / Remote signalling contact info

Clamping range (nominal / min. / max.) mm²
 Height x width x depth mm
 Signalling contact

Note

Ordering data

without remote signalling contact
 with remote signalling contact (R)

Note

Accessories

Note

Type II / T2
 Type II, Type III
 240 V
 300 V / 305 V
 TN-C-S, TN-S, TT, IT with N, IT without N
 20 kA / 40 kA
 50 kA / 65 kA
 ≤ 1.5 kV
 ≤ 1.5 kV
 No Fuse necessary ≤ 315 A gG, 250 A gG @50 kA I_{scCR}, 315 A gG @25 kA I_{scCR}

50 kA
 337 V
 ≤ 25 ns
 green = OK; red = arrester is defective - replace
 Installation housing: 4TE, Insta IP 20
 -40 °C...85 °C
 ≤ 4000 m

SPD TYPE 1
 240 V
 600 V / 600 V / 300 V / 305 V
 1800 V / 900 V / 1000 V / 1000 V
 150 kA
 20 kA
 3-phase WYE

1.5...16 mm² / 2.5...35 mm²
 18 mm
 2...4.5 Nm

CE; cULus; VDE
 IEC 61643-11, EN 61643-11, UL 1449, NFPA 79

no remote sig. contact	with remote signalling (R)
16 / 1.5 / 35	16 / 1.5 / 35
90 / 72 / 68	104.5 / 72 / 68
No	250 V 1A 1CO

Wire-end ferrules must be used when connecting finely stranded wire.

Type	Qty.	Order No.
VPU AC II US 3+1 240/50	1	2736360000
VPU AC II US 3+1 R 240/50	1	2736390000

Only for IT networks where the earth at the distribution transformer is connected to the earth on the customer side.

Pluggable spare arrester L-N: VPU AC II US 0 240/50 - 2730530000;
 N-PE: VPU AC II US 0 N-PE 240/65 - 2726820000

Type II / T2
 Type II, Type III
 240 V
 300 V /
 TN-C-S, TN-S
 20 kA /
 50 kA /
 ≤ 1.5 kV
 No Fuse necessary ≤ 315 A gG, 250 A gG @50 kA I_{scCR}, 315 A gG @25 kA I_{scCR}

50 kA
 337 V
 ≤ 25 ns
 green = OK; red = arrester is defective - replace
 Installation housing: 4TE, Insta IP 20
 -40 °C...85 °C
 ≤ 4000 m

SPD TYPE 1
 240 V
 600 V / 600 V / 300 V / 300 V
 1800 V / 1800 V / 900 V / 900 V
 150 kA
 20 kA
 3-phase WYE

1.5...16 mm² / 2.5...35 mm²
 18 mm
 2...4.5 Nm

CE; cULus; VDE
 IEC 61643-11, EN 61643-11, UL 1449, NFPA 79

no remote sig. contact	with remote signalling (R)
16 / 1.5 / 35	16 / 1.5 / 35
90 / 72 / 68	104.5 / 72 / 68
No	250 V 1A 1CO

Wire-end ferrules must be used when connecting finely stranded wire.

Type	Qty.	Order No.
VPU AC II US 4 240/50	1	2736400000
VPU AC II US 4 R 240/50	1	2736410000

Pluggable spare arrester L-N: VPU AC II US 0 240/50 - 2730530000

Type II US - 240 V UL 1449 & NFPA 79 (status indicator red, yellow, green)

- Back-up fuse not necessary up to 315 A
- Pluggable, coded arrester
- High energy absorption with short response time
- Installation in the distribution board
- Co-ordination with VPU AC Type I
- Approved according to IEC/EN 61643-11
- Approved according to UL 1449 and NFPA 79

VPU AC II US 1 R 240/50 Y

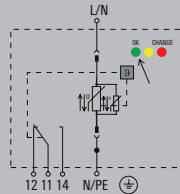

VPU AC II US 1+1 R 240/50 Y

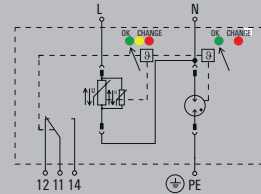

Technical data

Requirements category acc. to IEC/EN 61643-11
 Energy coordination (≤ 10 m)
 Rated voltage (AC)
 Max. continuous voltage, U_c (L-N / N-PE)
 Low voltage network
 Discharge current I_n (8/20 μ s) (Ader-PE / N-PE)
 Discharge current I_{max} (8/20 μ s) (Ader-PE / N-PE)
 Protection level U_p at I_n (L/N-PE)
 Protection level U_p at I_n (N-PE)
 Fuse
 Short-circuit current rating I_{SCCR}
 Temporary surge voltage (over-voltage) - TOV
 Response time
 Optical function display
 Design
 Ambient temperature (operational)
 Operating altitude

UL values

Category
 Rated Voltage U_n
 Max. continuous voltage MCOV (L-L / L-N / L-G / N-G)
 Protection level VPR (L-L / L-N / L-G / N-G)
 SCCR
 I_n
 UL Energy Networks

Connection data

Solid / Stranded
 Stripping length
 Tightening torque

Approvals

Approvals
 Standards

Dimensions / Remote signalling contact info

Clamping range (nominal / min. / max.) mm²
 Height x width x depth mm
 Signalling contact

Note

Ordering data

with remote signalling contact (R)

Note

Accessories

Note

Type II / T2
 Type II, Type III
 240 V
 300 V /
 Single-phase, TN
 20 kA /
 50 kA /
 ≤ 1.3 kV
 No Fuse necessary ≤ 160 A gG
 50 kA
 337 V
 ≤ 25 ns
 green = ok, yellow = warning, red = arrester is defective - replace.
 Installation housing; 1TE, Insta IP 20
 -40 °C...85 °C
 ≤ 4000 m

SPD TYPE 1

240 V
 / / 300 V /
 / / 900 V /
 150 kA
 20 kA
 Split-Phase

1.5...16 mm² / 2.5...35 mm²
 18 mm
 3...4.5 Nm

CE; cULus; VDE

IEC 61643-11, EN 61643-11, UL 1449, NFPA 79

with remote signalling (R)

16 / 1.5 / 35
 111 / 18 / 68
 250 V 1A 1CO

Wire-end ferrules must be used when connecting finely stranded wire.

Type	Qty.	Order No.
VPU AC II US 1 R 240/50 Y	1	2736470000

Pluggable spare arrester L-N: VPU AC II US 0 240/50 Y - 2736500000

Type II / T2
 Type II, Type III
 240 V
 300 V / 305 V
 Single-phase, TN, TT, IT with N, IT without N
 20 kA / 40 kA
 50 kA / 65 kA
 ≤ 1.3 kV
 ≤ 1.5 kV
 No Fuse necessary ≤ 160 A gG
 50 kA
 337 V
 ≤ 25 ns
 green = ok, yellow = warning, red = arrester is defective - replace.
 Installation housing; 2TE, Insta IP 20
 -40 °C...85 °C
 ≤ 4000 m

SPD TYPE 1

240 V
 / 300 V / 300 V / 305 V
 / 900 V / 900 V / 1000 V
 150 kA
 20 kA
 Split-Phase

1.5...16 mm² / 2.5...35 mm²
 18 mm
 3...4.5 Nm

CE; cULus; VDE

IEC 61643-11, EN 61643-11, UL 1449, NFPA 79

with remote signalling (R)

16 / 1.5 / 35
 104.5 / 36 / 68
 250 V 1A 1CO

Wire-end ferrules must be used when connecting finely stranded wire.

Type	Qty.	Order No.
VPU AC II US 1+1 R 240/50 Y	1	2736460000

Only for IT networks where the earth at the distribution transformer is connected to the earth on the customer side.

Pluggable spare arrester L-N: VPU AC II US 0 240/50 Y - 2736500000;
 N-PE: VPU AC II US 0 N-PE 240 Y - 2736520000



Type II US - 240 V UL 1449 & NFPA 79 (status indicator red, yellow, green)

- Back-up fuse not necessary up to 315 A
- Pluggable, coded arrester
- High energy absorption with short response time
- Installation in the distribution board
- Co-ordination with VPU AC Type I
- Approved according to IEC/EN 61643-11
- Approved according to UL 1449 and NFPA 79

VPU AC II US 2 R 240/50 Y

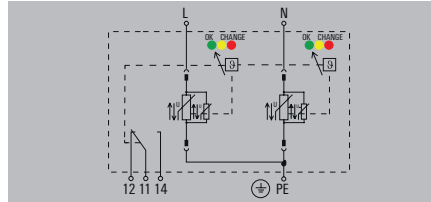

VPU AC II US 3 R 240/50 Y

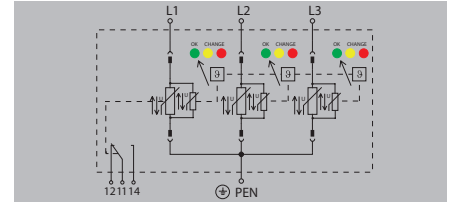

Technical data

Requirements category acc. to IEC/EN 61643-11
 Energy coordination (≤ 10 m)
 Rated voltage (AC)
 Max. continuous voltage, U_c (L-N / N-PE)
 Low voltage network
 Discharge current I_n (8/20 μ s) (Ader-PE / N-PE)
 Discharge current I_{max} (8/20 μ s) (Ader-PE / N-PE)
 Protection level U_p at I_n (L/N-PE)
 Protection level U_p at I_n (N-PE)
 Fuse
 Short-circuit current rating I_{SCCR}
 Temporary surge voltage (over-voltage) - TOV
 Response time
 Optical function display
 Design
 Ambient temperature (operational)
 Operating altitude

UL values

Category
 Rated Voltage U_n
 Max. continuous voltage MCOV (L-L / L-N / L-G / N-G)
 Protection level VPR (L-L / L-N / L-G / N-G)
 SCCR
 I_n
 UL Energy Networks

Connection data

Solid / Stranded
 Stripping length
 Tightening torque

Approvals

Approvals
 Standards

Dimensions / Remote signalling contact info

Clamping range (nominal / min. / max.) mm²
 Height x width x depth mm
 Signalling contact

Note

Ordering data

with remote signalling contact (R)

Note

Accessories

Note

Type II / T2

Type II, Type III

240 V

300 V /

Single-phase, TN-S

20 kA /

50 kA /

≤ 1.3 kV

No Fuse necessary ≤ 160 A gG

50 kA

337 V

≤ 25 ns

green = ok, yellow = warning, red = arrester is defective - replace.

Installation housing; 2TE, Insta IP 20

-40 °C...85 °C

≤ 4000 m

SPD TYPE 1

240 V

/ 600 V / 300 V / 300 V

/ 1800 V / 900 V / 900 V

150 kA

20 kA

Split-Phase

1.5...16 mm² / 2.5...35 mm²

18 mm

3...4.5 Nm

CE; cULus; VDE

IEC 61643-11, EN 61643-11, UL 1449, NFPA 79

with remote signalling (R)

16 / 1.5 / 35

104.5 / 36 / 68

250 V 1A 1CO

Wire-end ferrules must be used when connecting finely stranded wire.

Type

VPU AC II US 2 R 240/50 Y

Qty.

1

Order No.

2736480000

Type II / T2

Type II, Type III

240 V

300 V /

TN-C

20 kA /

50 kA /

≤ 1.3 kV

No Fuse necessary ≤ 160 A gG

50 kA

337 V

≤ 25 ns

green = ok, yellow = warning, red = arrester is defective - replace.

Installation housing; 3TE, Insta IP 20

-40 °C...85 °C

≤ 4000 m

SPD TYPE 1

240 V

600 V / / 300 V /

1800 V / / 900 V /

150 kA

20 kA

3-phase WYE

1.5...16 mm² / 2.5...35 mm²

18 mm

3...4.5 Nm

CE; cULus; VDE

IEC 61643-11, EN 61643-11, UL 1449, NFPA 79

with remote signalling (R)

16 / 1.5 / 35

104.5 / 54 / 68

250 V 1A 1CO

Wire-end ferrules must be used when connecting finely stranded wire.

Type

VPU AC II US 3 R 240/50 Y

Qty.

1

Order No.

2736450000

Pluggable spare arrester L-N: VPU AC II US 0 240/50 Y - 2736500000



Type II US - 240 V UL 1449 & NFPA 79 (status indicator red, yellow, green)

- Back-up fuse not necessary up to 315 A
- Pluggable, coded arrester
- High energy absorption with short response time
- Installation in the distribution board
- Co-ordination with VPU AC Type I
- Approved according to IEC/EN 61643-11
- Approved according to UL 1449 and NFPA 79

VPU AC II US 3+1 R 240/50 Y

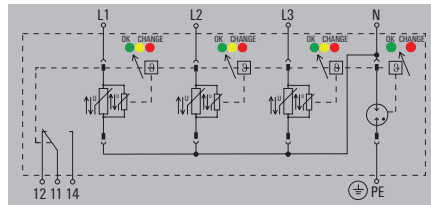

VPU AC II US 4 R 240/50 Y

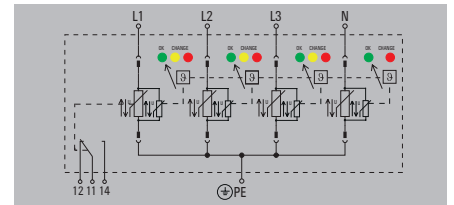

Technical data

Requirements category acc. to IEC/EN 61643-11
 Energy coordination (≤ 10 m)
 Rated voltage (AC)
 Max. continuous voltage, U_c (L-N / N-PE)
 Low voltage network
 Discharge current I_n (8/20 μ s) (Ader-PE / N-PE)
 Discharge current I_{max} (8/20 μ s) (Ader-PE / N-PE)
 Protection level U_p at I_n (L/N-PE)
 Protection level U_p at I_n (N-PE)
 Fuse
 Short-circuit current rating I_{SCCR}
 Temporary surge voltage (over-voltage) - TOV
 Response time
 Optical function display
 Design
 Ambient temperature (operational)
 Operating altitude

UL values

Category
 Rated Voltage U_n
 Max. continuous voltage MCOV (L-L / L-N / L-G / N-G)
 Protection level VPR (L-L / L-N / L-G / N-G)
 SCCR
 I_n
 UL Energy Networks

Connection data

Solid / Stranded
 Stripping length
 Tightening torque

Approvals

Approvals
 Standards

Dimensions / Remote signalling contact info

Clamping range (nominal / min. / max.) mm²
 Height x width x depth mm
 Signalling contact

Note

Ordering data

with remote signalling contact (R)

Note

Accessories

Note

Type II / T2
 Type II, Type III
 240 V
 300 V / 305 V
 TN-C-S, TN-S, TT, IT with N, IT without N
 20 kA / 40 kA
 50 kA / 65 kA
 ≤ 1.3 kV
 ≤ 1.5 kV
 No Fuse necessary ≤ 160 A gG
 50 kA
 337 V
 ≤ 25 ns
 green = ok, yellow = warning, red = arrester is defective - replace.
 Installation housing; 4TE, Insta IP 20
 -40 °C...85 °C
 ≤ 4000 m

SPD TYPE 1
 240 V
 600 V / 300 V / 300 V / 305 V
 1800 V / 900 V / 900 V / 1000 V
 150 kA
 20 kA
 3-phase WYE

1.5...16 mm² / 2.5...35 mm²
 18 mm
 3...4.5 Nm

CE; cULus; VDE
 IEC 61643-11, EN 61643-11, UL 1449, NFPA 79

with remote signalling (R)
 16 / 1.5 / 35
 104.5 / 72 / 68
 250 V 1A 1CO
 Wire-end ferrules must be used when connecting finely stranded wire.

Type	Qty.	Order No.
VPU AC II US 3+1 R 240/50 Y	1	2736440000

Only for IT networks where the earth at the distribution transformer is connected to the earth on the customer side.

Pluggable spare arrester L-N: VPU AC II US 0 240/50 Y - 2736500000;
 N-PE: VPU AC II US 0 N-PE 240 Y - 2736520000

Type II / T2
 Type II, Type III
 240 V
 300 V /
 TN-C-S, TN-S
 20 kA / 40 kA
 50 kA / 50 kA
 ≤ 1.3 kV
 No Fuse necessary ≤ 160 A gG
 50 kA
 337 V
 ≤ 25 ns
 green = ok, yellow = warning, red = arrester is defective - replace.
 Installation housing; 4TE, Insta IP 20
 -40 °C...85 °C
 ≤ 4000 m

SPD TYPE 1
 240 V
 600 V / 600 V / 300 V / 300 V
 1800 V / 1800 V / 900 V / 900 V
 150 kA
 20 kA
 3-phase WYE

1.5...16 mm² / 2.5...35 mm²
 18 mm
 3...4.5 Nm

CE; cULus; VDE
 IEC 61643-11, EN 61643-11, UL 1449, NFPA 79

with remote signalling (R)
 16 / 1.5 / 35
 104.5 / 72 / 68
 250 V 1A 1CO
 Wire-end ferrules must be used when connecting finely stranded wire.

Type	Qty.	Order No.
VPU AC II US 4 R 240/50 Y	1	2736490000

Pluggable spare arrester L-N: VPU AC II US 0 240/50 Y - 2736500000



Type II US - 277 V UL 1449 & NFPA 79

- Back-up fuse not necessary up to 315 A
- Pluggable, coded arrester
- High energy absorption with short response time
- Installation in the distribution board
- Co-ordination with VPU AC Type I
- Approved according to IEC/EN 61643-11
- Approved according to UL 1449 and NFPA 79

VPU AC II US 1 (R) 277/50

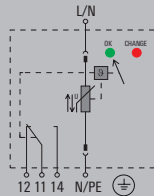

VPU AC II US 1+1 (R) 277/50

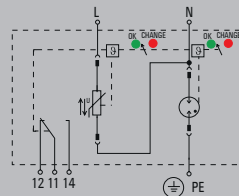

Technical data

Requirements category acc. to IEC/EN 61643-11
 Energy coordination (≤ 10 m)
 Rated voltage (AC)
 Max. continuous voltage, U_c (L-N / N-PE)
 Low voltage network
 Discharge current I_n (8/20 μ s) (Ader-PE / N-PE)
 Discharge current I_{max} (8/20 μ s) (Ader-PE / N-PE)
 Protection level U_p at I_n (L/N-PE)
 Protection level U_p at I_n (N-PE)
 Fuse

Short-circuit current rating I_{scCR}
 Temporary surge voltage (over-voltage) - TOV
 Response time
 Optical function display
 Design
 Ambient temperature (operational)
 Operating altitude

UL values

Category
 Rated Voltage U_n
 Max. continuous voltage MCOV (L-L / L-N / L-G / N-G)
 Protection level VPR (L-L / L-N / L-G / N-G)
 SCCR
 I_n
 UL Energy Networks

Connection data

Solid / Stranded
 Stripping length
 Tightening torque

Approvals

Approvals
 Standards

Dimensions / Remote signalling contact info

Clamping range (nominal / min. / max.) mm²
 Height x width x depth mm
 Signalling contact

Note

Type II / T2
 Type II, Type III
 277 V
 350 V /
 Single-phase, TN
 20 kA /
 50 kA /
 ≤ 1.75 kV

No Fuse necessary ≤ 315 A gG, 250 A gG @50 kA Isccr, 315 A gG @25 kA Isccr

50 kA
 403 V
 ≤ 25 ns
 green = OK; red = arrester is defective - replace
 Installation housing; 1TE, Insta IP 20
 -40 °C...85 °C
 ≤ 4000 m

SPD TYPE 1

277 V
 / / 350 V /
 / / 1000 V /
 200 kA
 20 kA
 Split-Phase

1.5...16 mm² / 2.5...35 mm²
 18 mm
 3...4.5 Nm

CE; cULus; VDE
 IEC 61643-11, EN 61643-11, UL 1449, NFPA 79

no remote sig. contact with remote signalling (R)

16 / 1.5 / 35 16 / 1.5 / 35
 90 / 18 / 68 111 / 18 / 68
 No 250 V 1A 1CO

Wire-end ferrules must be used when connecting finely stranded wire.

Type II / T2
 Type II, Type III
 277 V
 350 V / 305 V
 Single-phase, TN, TT, IT with N, IT without N
 20 kA / 40 kA
 50 kA / 65 kA
 ≤ 1.75 kV
 ≤ 1.5 kV

No Fuse necessary ≤ 315 A gG, 250 A gG @50 kA Isccr, 315 A gG @25 kA Isccr

50 kA
 403 V
 ≤ 25 ns
 green = OK; red = arrester is defective - replace
 Installation housing; 2TE, Insta IP 20
 -40 °C...85 °C
 ≤ 4000 m

SPD TYPE 1

277 V
 / 700 V / 350 V / 305 V
 / 1000 V / 3000 V / 1000 V
 200 kA
 20 kA
 Split-Phase

1.5...16 mm² / 2.5...35 mm²
 18 mm
 3...4.5 Nm

CE; cULus; VDE
 IEC 61643-11, EN 61643-11, UL 1449, NFPA 79

no remote sig. contact with remote signalling (R)

16 / 1.5 / 35 16 / 1.5 / 35
 90 / 36 / 68 104.5 / 36 / 68
 No 250 V 1A 1CO

Wire-end ferrules must be used when connecting finely stranded wire.

Ordering data

without remote signalling contact
 with remote signalling contact (R)

Type	Qty.	Order No.
VPU AC II US 1 277/50	1	2730570000
VPU AC II US 1 R 277/50	1	2730580000

Type	Qty.	Order No.
VPU AC II US 1+1 277/50	1	2730650000
VPU AC II US 1+1 R 277/50	1	2730660000

Note

Only for IT networks where the earth at the distribution transformer is connected to the earth on the customer side.

Accessories

Note

Pluggable spare arrester L-N: VPU AC II US 0 277/50 - 2730560000

Pluggable spare arrester L-N: VPU AC II US 0 277/50 - 2730560000;
 N-PE: VPU AC II US 0 N-PE 240/65 - 2726820000



Type II US - 277 V UL 1449 & NFPA 79

- Back-up fuse not necessary up to 315 A
- Pluggable, coded arrester
- High energy absorption with short response time
- Installation in the distribution board
- Co-ordination with VPU AC Type I
- Approved according to IEC/EN 61643-11
- Approved according to UL 1449 and NFPA 79

VPU AC II US 2 (R) 277/50

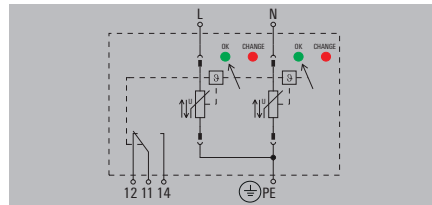

VPU AC II US 3 (R) 277/50

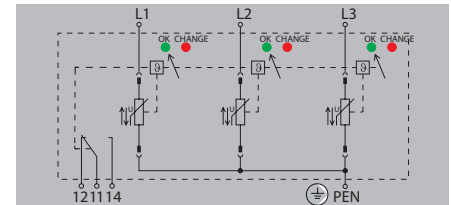

Technical data

Requirements category acc. to IEC/EN 61643-11
 Energy coordination (≤ 10 m)
 Rated voltage (AC)
 Max. continuous voltage, U_c (L-N / N-PE)
 Low voltage network
 Discharge current I_a (8/20 μ s) (Ader-PE / N-PE)
 Discharge current I_{max} (8/20 μ s) (Ader-PE / N-PE)
 Protection level U_p at I_a (L/N-PE)
 Protection level U_p at I_a (N-PE)
 Fuse

Short-circuit current rating I_{scCR}
 Temporary surge voltage (over-voltage) - TOV
 Response time
 Optical function display
 Design
 Ambient temperature (operational)
 Operating altitude

UL values

Category
 Rated Voltage U_n
 Max. continuous voltage MCOV (L-L / L-N / L-G / N-G)
 Protection level VPR (L-L / L-N / L-G / N-G)
 SCCR
 I_a
 UL Energy Networks

Connection data

Solid / Stranded
 Stripping length
 Tightening torque

Approvals

Approvals
 Standards

Dimensions / Remote signalling contact info

Clamping range (nominal / min. / max.) mm²
 Height x width x depth mm
 Signalling contact

Note

Ordering data

without remote signalling contact
 with remote signalling contact (R)

Note

Accessories

Note

Type II / T2
 Type II, Type III
 277 V
 350 V /
 Single-phase, TN-S
 20 kA /
 50 kA /
 ≤ 1.75 kV

No Fuse necessary ≤ 315 A gG, 250 A gG @50 kA I_{scCR} , 315 A gG @25 kA I_{scCR}

50 kA
 403 V
 ≤ 25 ns
 green = OK; red = arrester is defective - replace

Installation housing; 2TE, Insta IP 20
 -40 °C...85 °C
 ≤ 4000 m

SPD TYPE 1

277 V
 / 700 V / 350 V / 350 V
 / 2000 V / 1000 V / 1000 V
 200 kA
 20 kA
 Split-Phase

1.5...16 mm² / 2.5...35 mm²
 18 mm
 3...4.5 Nm

CE; cULus; VDE
 IEC 61643-11, EN 61643-11, UL 1449, NFPA 79

no remote sig. contact	with remote signalling (R)
16 / 1.5 / 35	16 / 1.5 / 35
90 / 36 / 68	104.5 / 36 / 68
No	250 V 1A 1CO

Wire-end ferrules must be used when connecting finely stranded wire.

Type	Qty.	Order No.
VPU AC II US 2 277/50	1	2730630000
VPU AC II US 2 R 277/50	1	2730640000

Pluggable spare arrester L-N: VPU AC II US 0 277/50 - 2730560000

Type II / T2
 Type II, Type III
 277 V
 350 V /
 TN-C
 20 kA /
 50 kA /
 ≤ 1.75 kV

No Fuse necessary ≤ 315 A gG, 250 A gG @50 kA I_{scCR} , 315 A gG @25 kA I_{scCR}

50 kA
 403 V
 ≤ 25 ns
 green = OK; red = arrester is defective - replace

Installation housing; 3TE, Insta IP 20
 -40 °C...85 °C
 ≤ 4000 m

SPD TYPE 1

277 V
 700 V / / 350 V /
 2000 V / / 1000 V /
 200 kA
 20 kA
 3-phase WYE

1.5...16 mm² / 2.5...35 mm²
 18 mm
 3...4.5 Nm

CE; cULus; VDE
 IEC 61643-11, EN 61643-11, UL 1449, NFPA 79

no remote sig. contact	with remote signalling (R)
16 / 1.5 / 35	16 / 1.5 / 35
90 / 54 / 68	104.5 / 54 / 68
No	250 V 1A 1CO

Wire-end ferrules must be used when connecting finely stranded wire.

Type	Qty.	Order No.
VPU AC II US 3 277/50	1	2730590000
VPU AC II US 3 R 277/50	1	2730600000

Pluggable spare arrester L-N: VPU AC II US 0 277/50 - 2730560000



Type II US - 277 V UL 1449 & NFPA 79

- Back-up fuse not necessary up to 315 A
- Pluggable, coded arrester
- High energy absorption with short response time
- Installation in the distribution board
- Co-ordination with VPU AC Type I
- Approved according to IEC/EN 61643-11
- Approved according to UL 1449 and NFPA 79

VPU AC II US 3+1 (R) 277/50

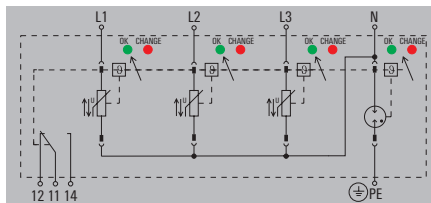

VPU AC II US 4 (R) 277/50

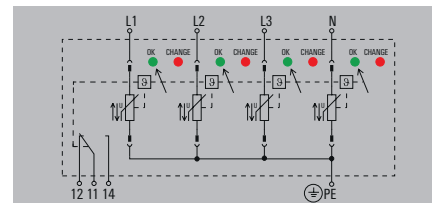

Technical data

Requirements category acc. to IEC/EN 61643-11
 Energy coordination (≤ 10 m)
 Rated voltage (AC)
 Max. continuous voltage, U_c (L-N / N-PE)
 Low voltage network
 Discharge current I_n (8/20 μ s) (Ader-PE / N-PE)
 Discharge current I_{max} (8/20 μ s) (Ader-PE / N-PE)
 Protection level U_p at I_n (L/N-PE)
 Protection level U_p at I_n (N-PE)
 Fuse

Short-circuit current rating I_{scCR}
 Temporary surge voltage (over-voltage) - TOV
 Response time
 Optical function display
 Design
 Ambient temperature (operational)
 Operating altitude

UL values

Category
 Rated Voltage U_n
 Max. continuous voltage MCOV (L-L / L-N / L-G / N-G)
 Protection level VPR (L-L / L-N / L-G / N-G)
 SCCR
 I_n
 UL Energy Networks

Connection data

Solid / Stranded
 Stripping length
 Tightening torque

Approvals

Approvals
 Standards

Dimensions / Remote signalling contact info

Clamping range (nominal / min. / max.) mm²
 Height x width x depth mm
 Signalling contact

Note

Ordering data

without remote signalling contact
 with remote signalling contact (R)

Note

Accessories

Note

Type II / T2
 Type II, Type III
 277 V
 350 V / 305 V
 TN-C-S, TN-S, TT, IT with N, IT without N
 20 kA / 40 kA
 50 kA / 65 kA
 ≤ 1.75 kV
 ≤ 1.5 kV
 No Fuse necessary ≤ 315 A gG, 250 A gG @50 kA I_{scCR}, 315 A gG @25 kA I_{scCR}

50 kA
 403 V
 ≤ 25 ns
 green = OK; red = arrester is defective - replace
 Installation housing: 4TE, Insta IP 20
 -40 °C...85 °C
 ≤ 4000 m

SPD TYPE 1
 277 V
 700 V / 350 V / 350 V / 305 V
 3000 V / 1500 V / 3000 V / 1000 V
 200 kA
 20 kA
 3-phase WYE, High-Leg Delta

1.5...16 mm² / 2.5...35 mm²
 18 mm
 3...4.5 Nm

CE; cULus; VDE
 IEC 61643-11, EN 61643-11, UL 1449, NFPA 79

no remote sig. contact	with remote signalling (R)
16 / 1.5 / 35	16 / 1.5 / 35
90 / 72 / 68	104.5 / 72 / 68
No	250 V 1A 1CO

Wire-end ferrules must be used when connecting finely stranded wire.

Type	Qty.	Order No.
VPU AC II US 3+1 277/50	1	2730670000
VPU AC II US 3+1 R 277/50	1	2730680000

Only for IT networks where the earth at the distribution transformer is connected to the earth on the customer side.

Pluggable spare arrester L-N: VPU AC II US 0 277/50 - 2730560000;
 N-PE: VPU AC II US 0 N-PE 240/65 - 2726820000

Type II / T2
 Type II, Type III
 277 V
 350 V /
 TN-C-S, TN-S
 20 kA / 40 kA
 50 kA / 50 kA
 ≤ 1.75 kV

No Fuse necessary ≤ 315 A gG, 250 A gG @50 kA I_{scCR}, 315 A gG @25 kA I_{scCR}
 50 kA
 403 V
 ≤ 25 ns
 green = OK; red = arrester is defective - replace
 Installation housing: 4TE, Insta IP 20
 -40 °C...85 °C
 ≤ 4000 m

SPD TYPE 1
 277 V
 700 V / 700 V / 350 V / 350 V
 2000 V / 2000 V / 1000 V / 1000 V
 200 kA
 20 kA
 3-phase WYE

1.5...16 mm² / 2.5...35 mm²
 18 mm
 3...4.5 Nm

CE; cULus; VDE
 IEC 61643-11, EN 61643-11, UL 1449, NFPA 79

no remote sig. contact	with remote signalling (R)
16 / 1.5 / 35	16 / 1.5 / 35
90 / 72 / 68	104.5 / 72 / 68
No	250 V 1A 1CO

Wire-end ferrules must be used when connecting finely stranded wire.

Type	Qty.	Order No.
VPU AC II US 4 277/50	1	2730610000
VPU AC II US 4 R 277/50	1	2730620000

Pluggable spare arrester L-N: VPU AC II US 0 277/50 - 2730560000

Type II US - 400 V UL 1449 & NFPA 79

- Back-up fuse not necessary up to 315 A
- Pluggable, coded arrester
- High energy absorption with short response time
- Installation in the distribution board
- Co-ordination with VPU AC Type I
- Approved according to IEC/EN 61643-11
- Approved according to UL 1449 and NFPA 79

VPU AC II US 1 (R) 400/50

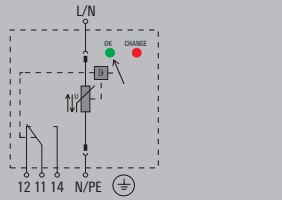

VPU AC II US 3 (R) 400/50

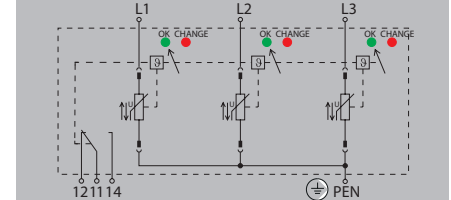

Technical data

Requirements category acc. to IEC/EN 61643-11
 Energy coordination (≤ 10 m)
 Rated voltage (AC)
 Max. continuous voltage, U_c (L-N / N-PE)
 Low voltage network
 Discharge current I_a (8/20 μ s) (Ader-PE / N-PE)
 Discharge current I_{max} (8/20 μ s) (Ader-PE / N-PE)
 Protection level U_p at I_a (L/N-PE)
 Protection level U_p at I_a (N-PE)
 Fuse

Short-circuit current rating I_{scCR}
 Temporary surge voltage (over-voltage) - TOV
 Response time
 Optical function display
 Design
 Ambient temperature (operational)
 Operating altitude

UL values

Category
 Rated Voltage U_n
 Max. continuous voltage MCOV (L-L / L-N / L-G / N-G)
 Protection level VPR (L-L / L-N / L-G / N-G)
 SCCR
 I_a
 UL Energy Networks

Connection data

Solid / Stranded
 Stripping length
 Tightening torque

Approvals

Approvals
 Standards

Dimensions / Remote signalling contact info

Clamping range (nominal / min. / max.) mm²
 Height x width x depth mm
 Signalling contact

Note

Ordering data

without remote signalling contact
 with remote signalling contact (R)

Note

Accessories

Note

Type II / T2
 Type II, Type III
 400 V
 480 V /
 Single-phase, TN
 20 kA /
 50 kA /
 ≤ 2.3 kV

No Fuse necessary ≤ 315 A gG, 250 A gG @50 kA Isccr, 315 A gG @25 kA Isccr

50 kA
 581 V
 ≤ 25 ns
 green = OK; red = arrester is defective - replace

Installation housing; 1TE, Insta IP 20
 -40 °C...85 °C
 ≤ 4000 m

SPD TYPE 1

400 V
 / / 480 V /
 / / 1500 V /
 200 kA
 20 kA
 Split-Phase

1.5...16 mm² / 2.5...35 mm²
 18 mm
 3...4.5 Nm

CE; cULus; VDE
 IEC 61643-11, EN 61643-11, UL 1449, NFPA 79

no remote sig. contact with remote signalling (R)

16 / 1.5 / 35	16 / 1.5 / 35
90 / 18 / 68	111 / 18 / 68
No	250 V 1A 1CO

Wire-end ferrules must be used when connecting finely stranded wire.

Type	Qty.	Order No.
VPU AC II US 1 400/50	1	2730700000
VPU AC II US 1 R 400/50	1	2730710000

Pluggable spare arrester L-N: VPU AC II US 0 400/50 - 2730690000

Type II / T2
 Type II, Type III
 400 V
 480 V /
 TN-C
 20 kA /
 50 kA /
 ≤ 2.3 kV

No Fuse necessary ≤ 315 A gG, 250 A gG @50 kA Isccr, 315 A gG @25 kA Isccr

50 kA
 581 V
 ≤ 25 ns
 green = OK; red = arrester is defective - replace

Installation housing; 3TE, Insta IP 20
 -40 °C...85 °C
 ≤ 4000 m

SPD TYPE 1

400 V
 960 V / / 480 V /
 3000 V / / 1500 V /
 200 kA
 20 kA
 3-phase WYE

1.5...16 mm² / 2.5...35 mm²
 18 mm
 3...4.5 Nm

CE; cULus; VDE
 IEC 61643-11, EN 61643-11, UL 1449, NFPA 79

no remote sig. contact with remote signalling (R)

16 / 1.5 / 35	16 / 1.5 / 35
90 / 54 / 68	104.5 / 54 / 68
No	250 V 1A 1CO

Wire-end ferrules must be used when connecting finely stranded wire.

Type	Qty.	Order No.
VPU AC II US 3 400/50	1	2730720000
VPU AC II US 3 R 400/50	1	2730730000

Pluggable spare arrester L-N: VPU AC II US 0 400/50 - 2730690000

Type II US - 400 V UL 1449 & NFPA 79

- Back-up fuse not necessary up to 315 A
- Pluggable, coded arrester
- High energy absorption with short response time
- Installation in the distribution board
- Co-ordination with VPU AC Type I
- Approved according to IEC/EN 61643-11
- Approved according to UL 1449 and NFPA 79

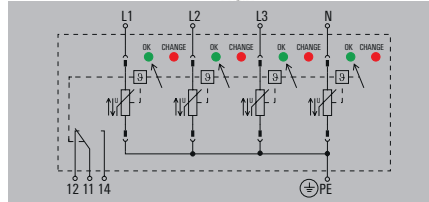
VPU AC II US 4 (R) 400/50**Technical data**

Requirements category acc. to IEC/EN 61643-11
 Energy coordination (≤ 10 m)
 Rated voltage (AC)
 Max. continuous voltage, U_c (L-N / N-PE)
 Low voltage network
 Discharge current I_n (8/20 μ s) (Ader-PE / N-PE)
 Discharge current I_{max} (8/20 μ s) (Ader-PE / N-PE)
 Protection level U_p at I_n (L/N-PE)
 Protection level U_p at I_n (N-PE)
 Fuse

Short-circuit current rating I_{SCCR}
 Temporary surge voltage (over-voltage) - TOV
 Response time
 Optical function display
 Design
 Ambient temperature (operational)
 Operating altitude

UL values

Category
 Rated Voltage U_n
 Max. continuous voltage MCOV (L-L / L-N / L-G / N-G)
 Protection level VPR (L-L / L-N / L-G / N-G)
 SCCR
 I_n
 UL Energy Networks

Connection data

Solid / Stranded
 Stripping length
 Tightening torque

Approvals

Approvals
 Standards

Dimensions / Remote signalling contact info

Clamping range (nominal / min. / max.) mm²
 Height x width x depth mm
 Signalling contact

Note**Ordering data**

without remote signalling contact
 with remote signalling contact (R)

Note**Accessories****Note**

Type II / T2
 Type II, Type III
 400 V
 480 V /
 TN-S, TN-C-S
 20 kA / 40 kA
 50 kA / 50 kA
 ≤ 2.3 kV
 ≤ 1.5 kV
 No Fuse necessary ≤ 315 A gG, 250 A gG @50 kA I_{SCCR} , 315 A gG @25 kA I_{SCCR}
 50 kA
 581 V
 ≤ 25 ns
 green = OK; red = arrester is defective - replace
 Installation housing: 4TE, Insta IP 20
 -40 °C... 85 °C
 ≤ 4000 m

SPD TYPE 1
 400 V
 960 V / 960 V / 480 V / 480 V
 3000 V / 3000 V / 1500 V / 1500 V
 200 kA
 20 kA
 3-phase WYE

1.5...16 mm² / 2.5...35 mm²
 18 mm
 3...4.5 Nm

CE; cULus; VDE
 IEC 61643-11, EN 61643-11, UL 1449, NFPA 79

no remote sig. contact	with remote signalling (R)
16 / 1.5 / 35	16 / 1.5 / 35
90 / 72 / 68	104.5 / 72 / 68
No	250 V 1A 1CO

Wire-end ferrules must be used when connecting finely stranded wire.

Type	Qty.	Order No.
VPU AC II US 4 400/50	1	2730740000
VPU AC II US 4 R 400/50	1	2730750000

Pluggable spare arrester L-N: VPU AC II US 0 400/50 - 2730690000



Type II US - 600 V UL 1449 & NFPA 79

- Back-up fuse not necessary up to 315 A
- Pluggable, coded arrester
- High energy absorption with short response time
- Installation in the distribution board
- Co-ordination with VPU AC Type I
- Approved according to IEC/EN 61643-11
- Approved according to UL 1449 and NFPA 79

VPU AC II US 1 R 600/35

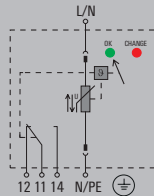

VPU AC II US 2 R 600/35

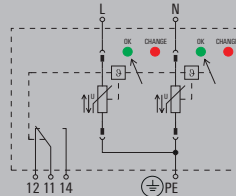

Technical data

Requirements category acc. to IEC/EN 61643-11
 Energy coordination (≤ 10 m)
 Rated voltage (AC)
 Max. continuous voltage, U_c (L-N / N-PE)
 Low voltage network
 Discharge current I_n (8/20 μ s) (Ader-PE / N-PE)
 Discharge current I_{max} (8/20 μ s) (Ader-PE / N-PE)
 Protection level U_p at I_n (L/N-PE)
 Protection level U_p at I_n (N-PE)
 Fuse

Short-circuit current rating I_{scCR}
 Temporary surge voltage (over-voltage) - TOV
 Response time
 Optical function display
 Design
 Ambient temperature (operational)
 Operating altitude

UL values

Category
 Rated Voltage U_n
 Max. continuous voltage MCOV (L-L / L-N / L-G / N-G)
 Protection level VPR (L-L / L-N / L-G / N-G)
 SCCR
 I_n
 UL Energy Networks

Connection data

Solid / Stranded
 Stripping length
 Tightening torque

Approvals

Approvals
 Standards

Dimensions / Remote signalling contact info

Clamping range (nominal / min. / max.) mm²
 Height x width x depth mm
 Signalling contact

Note

Ordering data

with remote signalling contact (R)

Note

Accessories

Note

Type II / T2
 Type II, Type III
 690 V
 750 V /
 Single-phase, TN
 20 kA /
 35 kA /
 ≤ 3.4 kV

No Fuse necessary ≤ 315 A gG, 250 A gG @50 kA I_{scCR} , 315 A gG @25 kA I_{scCR}

50 kA
 871 V
 ≤ 25 ns
 green = OK; red = arrester is defective - replace

Installation housing; 1TE, Insta IP 20
 -40 °C...85 °C
 ≤ 4000 m

SPD TYPE 1

600 V
 / / 750 V /
 / / 2500 V /
 200 kA
 20 kA
 Split-Phase

1.5...16 mm² / 2.5...35 mm²

18 mm
 3...4.5 Nm

CE; cULus; VDE
 IEC 61643-11, EN 61643-11, UL 1449, NFPA 79

with remote signalling (R)

16 / 1.5 / 35
 111 / 18 / 68
 250 V 1A 1CO

Wire-end ferrules must be used when connecting finely stranded wire.

Type	Qty.	Order No.
VPU AC II US 1 R 600/35	1	2736420000

Type II / T2
 Type II, Type III
 690 V
 750 V /
 Single-phase, TN-S
 20 kA /
 35 kA /
 ≤ 3.4 kV

No Fuse necessary ≤ 315 A gG, 250 A gG @50 kA I_{scCR} , 315 A gG @25 kA I_{scCR}

50 kA
 871 V
 ≤ 25 ns
 green = OK; red = arrester is defective - replace

Installation housing; 2TE, Insta IP 20
 -40 °C...85 °C
 ≤ 4000 m

SPD TYPE 1

600 V
 1500 V / / 1500 V /
 5000 V / / 2500 V /
 200 kA
 20 kA
 Delta System

1.5...16 mm² / 2.5...35 mm²

18 mm
 3...4.5 Nm

CE; cULus; VDE
 IEC 61643-11, EN 61643-11, UL 1449, NFPA 79

with remote signalling (R)

16 / 1.5 / 35
 104.5 / 36 / 68
 250 V 1A 1CO

Wire-end ferrules must be used when connecting finely stranded wire.

Type	Qty.	Order No.
VPU AC II US 2 R 600/35	1	2736430000

Pluggable spare arrester L-N: VPU AC II US 0 600/35 - 2730760000

Type II US - 600 V UL 1449 & NFPA 79

- Back-up fuse not necessary up to 315 A
- Pluggable, coded arrester
- High energy absorption with short response time
- Installation in the distribution board
- Co-ordination with VPU AC Type I
- Approved according to IEC/EN 61643-11
- Approved according to UL 1449 and NFPA 79

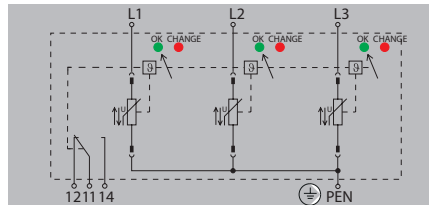
VPU AC II US 3 R 600/35**Technical data**

Requirements category acc. to IEC/EN 61643-11
 Energy coordination (≤ 10 m)
 Rated voltage (AC)
 Max. continuous voltage, U_c (L-N / N-PE)
 Low voltage network
 Discharge current I_a (8/20 μ s) (Ader-PE / N-PE)
 Discharge current I_{max} (8/20 μ s) (Ader-PE / N-PE)
 Protection level U_p at I_a (L/N-PE)
 Protection level U_p at I_a (N-PE)
 Fuse

Short-circuit current rating I_{scCR}
 Temporary surge voltage (over-voltage) - TOV
 Response time
 Optical function display
 Design
 Ambient temperature (operational)
 Operating altitude

UL values

Category
 Rated Voltage U_n
 Max. continuous voltage MCOV (L-L / L-N / L-G / N-G)
 Protection level VPR (L-L / L-N / L-G / N-G)
 SCCR
 I_a
 UL Energy Networks

Connection data

Solid / Stranded
 Stripping length
 Tightening torque

Approvals

Approvals
 Standards

Dimensions / Remote signalling contact info

Clamping range (nominal / min. / max.) mm²
 Height x width x depth mm
 Signalling contact

Note**Ordering data**

with remote signalling contact (R)

Note**Accessories****Note**

Type II / T2
 Type II, Type III
 690 V
 750 V /
 TN-C
 20 kA /
 35 kA /
 ≤ 3.4 kV

No Fuse necessary ≤ 315 A gG, 250 A gG @50 kA I_{scCR} , 315 A gG @25 kA I_{scCR}

50 kA
 871 V
 ≤ 25 ns
 green = OK; red = arrester is defective - replace
 Installation housing: 3TE, Insta IP 20
 -40 °C...85 °C
 ≤ 4000 m

SPD TYPE 1

600 V
 1500 V / / 750 V /
 5000 V / / 2500 V /
 200 kA
 20 kA
 Delta System

1.5...16 mm² / 2.5...35 mm²
 18 mm
 3...4.5 Nm

CE; cULus; VDE
 IEC 61643-11, EN 61643-11, UL 1449, NFPA 79

with remote signalling (R)

16 / 1.5 / 35
 104.5 / 54 / 68
 250 V 1A 1CO

Wire-end ferrules must be used when connecting finely stranded wire.

Type	Qty.	Order No.
VPU AC II US 3 R 600/35	1	2730780000

Pluggable spare arrester L-N: VPU AC II US 0 600/35 - 2730760000



Optimum protection in the smallest space

VARITECTOR PU AC II+III 20 S pluggable surge protection devices

Surge protection is now mandatory in all commercial and privately used properties according to the specifications of DIN VDE 0100-443 and -534. Easy-to-install and, above all, space-saving solutions are particularly popular here.

Our VARITECTOR PU AC II+III surge protection devices provides optimum protection against surge damage. With a width of only 9 mm per pole, they are particularly compact and can therefore be used in all sub-distribution boards, charging stations, and many other applications. The modules fulfil the requirement classes of type II and III. With a discharge current of 20 kA these products offer excellent and tailormade protection.

Your special advantages:

- Space-saving design with only 9 mm per pole
- Available for mains types TN-S, TN-C, IT, and TT
- Suitable for operating voltages (Uc) 275 V and 440 V
- Combined of type II and III arrester
- High short-circuit current resistance of up to 25 kA



Innovative status display

In addition to a visual display, the modules have an optional three-pole remote contact (RC), which enables convenient remote monitoring of the operating status.



Wide range of applications

The new VARITECTOR PU AC II+III 20 S modules meet the requirements of type II and III surge protection devices. They are suitable for operating voltages (U_c) of 275 V and 440 V and can therefore also be used in IT and TT networks.

Space-saving design

Due to their compact width of only 9 mm per pole, the surge protection devices can be installed even in small sub-distribution boards or cramped applications – for example in wallboxes.



Type II+III – 275 V / 20 kA

- Back-up fuse not necessary up to 100 A
- Pluggable, coded arrester
- Co-ordination with VPU AC Type I
- Approved according to IEC/EN 61643-11 as type II and III

VPU AC II+III 1+1 (R) 275/20 S

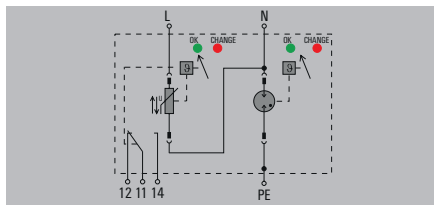

VPU AC II+III 2 (R) 275/20 S

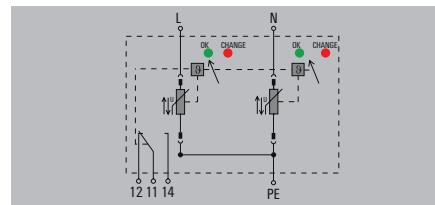

Technical data

Requirements category acc. to IEC/EN 61643-11
 Energy coordination (≤ 10 m)
 Rated voltage (AC)
 Max. continuous voltage, U_c (L-N / N-PE)
 Low voltage network
 Discharge current I_n (8/20 μ s) (Ader-PE / N-PE)
 Discharge current I_{max} (8/20 μ s) (Ader-PE / N-PE)
 Protection level U_p at I_n (L/N-PE)
 Protection level U_p at I_n (N-PE)
 Fuse

Short-circuit current rating I_{scCR}
 Temporary surge voltage (over-voltage) - TOV
 Response time
 Optical function display
 Design
 Ambient temperature (operational)
 Operating altitude

Connection data

Solid / Stranded
 Stripping length
 Tightening torque

Approvals

Approvals
 Standards

Type II, Type III / T2, T3
 Type II, Type III
 230 V
 275 V / 255 V
 Single-phase, TN, TT, IT with N, IT without N
 10 kA / 20 kA
 20 kA / 40 kA
 ≤ 1.25 kV
 ≤ 1.5 kV
 No Fuse necessary ≤ 100 A gG

25 kA
 335 V
 ≤ 25 ns
 green = OK; red = arrester is defective - replace
 Installation housing; 1TE, Insta IP 20
 -40 °C... 85 °C
 ≤ 2000 m

2.5...10 mm² / 2.5...10 mm²
 13 mm
 1.2...2 Nm

CE
 IEC 61643-11, EN 61643-11

Type II, Type III / T2, T3
 Type II, Type III
 230 V
 275 V /
 Single-phase, TN-S
 10 kA /
 20 kA /
 ≤ 1.25 kV

No Fuse necessary ≤ 100 A gG

25 kA
 335 V
 ≤ 25 ns
 green = OK; red = arrester is defective - replace
 Installation housing; 1TE, Insta IP 20
 -40 °C... 85 °C
 ≤ 2000 m

2.5...10 mm² / 2.5...10 mm²
 13 mm
 1.2...2 Nm

CE
 IEC 61643-11, EN 61643-11

Dimensions / Remote signalling contact info

Clamping range (nominal / min. / max.) mm²
 Height x width x depth mm
 Signalling contact

Note

no remote sig. contact with remote signalling (R)

10 / 2.5 / 35	10 / 2.5 / 35
97 / 18 / 70	105 / 18 / 70
No	250 V / 0,5 A

Wire-end ferrules must be used when connecting finely stranded wire.

no remote sig. contact with remote signalling (R)

10 / 2.5 / 35	10 / 2.5 / 35
97 / 18 / 70	105 / 18 / 70
No	250 V / 0,5 A

Wire-end ferrules must be used when connecting finely stranded wire.

Ordering data

without remote signalling contact
 with remote signalling contact (R)

Type	Qty.	Order No.
VPU AC II+III 1+1 275/20 S	1	2907930000
VPU AC II+III 1+1 R 275/20 S	1	2907940000

Type	Qty.	Order No.
VPU AC II+III 2 275/20 S	1	2907830000
VPU AC II+III 2 R 275/20 S	1	2907840000

Note

Accessories

Note

Pluggable spare arrester L/N-PE: VPU AC II+III 0 L/N-PE 275/20 S - 2908020000

Pluggable spare arrester L-N: VPU AC II+III 0 L-N 275/20 S - 2908010000



Type II+III - 275 V / 20 kA

- Back-up fuse not necessary up to 100 A
- Pluggable, coded arrester
- Co-ordination with VPU AC Type I
- Approved according to IEC/EN 61643-11 as type II and III

VPU AC II+III 3 (R) 275/20 S

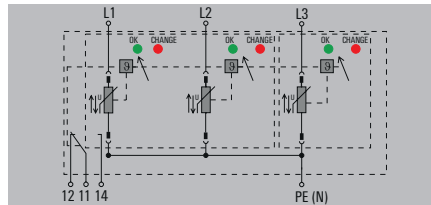

VPU AC II+III 3+1 (R) 275/20 S

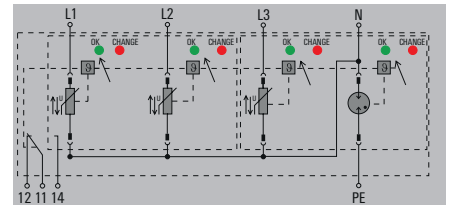

Technical data

Requirements category acc. to IEC/EN 61643-11
 Energy coordination (≤ 10 m)
 Rated voltage (AC)
 Max. continuous voltage, U_c (L-N / N-PE)
 Low voltage network
 Discharge current I_n (8/20 μ s) (Ader-PE / N-PE)
 Discharge current I_{max} (8/20 μ s) (Ader-PE / N-PE)
 Protection level U_p at I_n (L/N-PE)
 Protection level U_p at I_n (N-PE)
 Fuse

Short-circuit current rating I_{scCR}
 Temporary surge voltage (over-voltage) - TOV
 Response time
 Optical function display
 Design
 Ambient temperature (operational)
 Operating altitude

Connection data

Solid / Stranded
 Stripping length
 Tightening torque

Approvals

Approvals
 Standards

Type II, Type III / T2, T3

Type II, Type III

230 V

275 V /

TN-C

10 kA /

20 kA /

≤ 1.25 kV

No Fuse necessary ≤ 100 A gG

25 kA

335 V

≤ 25 ns

green = OK; red = arrester is defective - replace

Installation housing; 2TE, Insta IP 20

-40 °C...85 °C

≤ 2000 m

2.5...10 mm² / 2.5...10 mm²

13 mm

1.2...2 Nm

CE

IEC 61643-11, EN 61643-11

Type II, Type III / T2, T3

Type II, Type III

230 V

275 V / 255 V

TN-C-S, TN-S, TT, IT with N, IT without N

10 kA / 20 kA

20 kA / 40 kA

≤ 1.25 kV

≤ 1.5 kV

No Fuse necessary ≤ 100 A gG

25 kA

335 V

≤ 25 ns

green = OK; red = arrester is defective - replace

Installation housing; 2TE, Insta IP 20

-40 °C...85 °C

≤ 2000 m

2.5...10 mm² / 2.5...10 mm²

13 mm

1.2...2 Nm

CE

IEC 61643-11, EN 61643-11

Dimensions / Remote signalling contact info

Clamping range (nominal / min. / max.) mm²
 Height x width x depth mm
 Signalling contact

Note

no remote sig. contact

10 / 2.5 / 35
 97 / 36 / 70
 No

Wire-end ferrules must be used when connecting finely stranded wire.

with remote signalling (R)

10 / 2.5 / 35
 99 / 36 / 70
 250 V / 0,5 A

no remote sig. contact

10 / 2.5 / 35
 97 / 36 / 70
 No

Wire-end ferrules must be used when connecting finely stranded wire.

with remote signalling (R)

10 / 2.5 / 35
 99 / 36 / 70
 250 V / 0,5 A

Ordering data

without remote signalling contact
 with remote signalling contact (R)

Type	Qty.	Order No.
VPU AC II+III 3 275/20 S	1	2907870000
VPU AC II+III 3 R 275/20 S	1	2907880000

Type	Qty.	Order No.
VPU AC II+III 3+1 275/20 S	1	2907950000
VPU AC II+III 3+1 R 275/20 S	1	2907970000

Note

Accessories

Note

Pluggable spare arrester L-N: 2908010000; L/N-PE: 2908020000; L3-PEN: 2907980000

Pluggable spare arrester L-N: VPU AC II+III 0 L-N 275/20 S - 2908010000; L/N-PE: VPU AC II+III 0 L/N-PE 275/20 S - 2908020000

Type II+III - 275 V / 20 kA

- Back-up fuse not necessary up to 100 A
- Pluggable, coded arrester
- Co-ordination with VPU AC Type I
- Approved according to IEC/EN 61643-11 as type II and III

VPU AC II+III 4 (R) 275/20 S

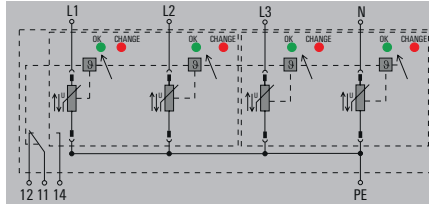

Technical data

Requirements category acc. to IEC/EN 61643-11
 Energy coordination (≤ 10 m)
 Rated voltage (AC)
 Max. continuous voltage, U_c (L-N / N-PE)
 Low voltage network
 Discharge current I_n (8/20 μ s) (Ader-PE / N-PE)
 Discharge current I_{max} (8/20 μ s) (Ader-PE / N-PE)
 Protection level U_p at I_n (L/N-PE)
 Protection level U_p at I_n (N-PE)
 Fuse

Short-circuit current rating I_{scCR}
 Temporary surge voltage (over-voltage) - TOV
 Response time
 Optical function display
 Design
 Ambient temperature (operational)
 Operating altitude

Connection data

Solid / Stranded
 Stripping length
 Tightening torque

Approvals

Approvals
 Standards

Type II, Type III / T2, T3
Type II, Type III
230 V
275 V /
TN-C-S, TN-S
10 kA /
20 kA /
≤ 1.25 kV
≤ 1.5 kV
No Fuse necessary ≤ 100 A gG
25 kA
335 V
≤ 25 ns
green = OK; red = arrester is defective - replace
Installation housing: ZTE, Insta IP 20
-40 °C...85 °C
≤ 2000 m
2.5...10 mm ² / 2.5...10 mm ²
13 mm
1.2...2 Nm
CE
IEC 61643-11, EN 61643-11

Dimensions / Remote signalling contact info

Clamping range (nominal / min. / max.)	mm ²
Height x width x depth	mm
Signalling contact	

Note

no remote sig. contact	with remote signalling (R)
10 / 2.5 / 35	10 / 2.5 / 35
97 / 36 / 70	99 / 36 / 70
No	250 V / 0,5 A

Wire-end ferrules must be used when connecting finely stranded wire.

Ordering data

without remote signalling contact
 with remote signalling contact (R)

Type	Qty.	Order No.
VPU AC II+III 4 275/20 S	1	2907890000
VPU AC II+III 4 R 275/20 S	1	2907920000

Note

Accessories

Note

Pluggable spare arrester L-N: VPU AC II+III 0 L-N 275/20 S - 2908010000



**Type II+III - 440 V / 20 kA**

- Back-up fuse not necessary up to 100 A
- Pluggable, coded arrester
- Co-ordination with VPU AC Type I
- Approved according to IEC/EN 61643-11 as type II and III

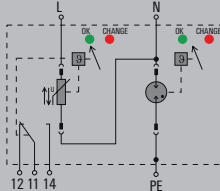
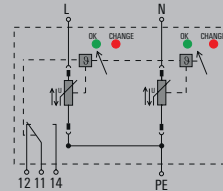
VPU AC II+III 1+1 (R) 440/20 S**VPU AC II+III 2 (R) 440/20 S****Technical data**

Requirements category acc. to IEC/EN 61643-11
Energy coordination (≤ 10 m)
Rated voltage (AC)
Max. continuous voltage, U_c (L-N / N-PE)
Low voltage network
Discharge current I_n (8/20 μ s) (Ader-PE / N-PE)
Discharge current I_{max} (8/20 μ s) (Ader-PE / N-PE)
Protection level U_p at I_n (L/N-PE)
Protection level U_p at I_n (N-PE)
Fuse

Short-circuit current rating I_{scCR}
Temporary surge voltage (over-voltage) - TOV
Response time
Optical function display
Design
Ambient temperature (operational)
Operating altitude

Connection data

Solid / Stranded
Stripping length
Tightening torque

Approvals

Approvals
Standards

Type II, Type III / T2, T3
Type II, Type III
230 V
440 V / 255 V
Single-phase, TN, TT, IT with N, IT without N
10 kA / 20 kA
20 kA / 40 kA
 ≤ 1.7 kV
 ≤ 1.5 kV
No Fuse necessary ≤ 100 A gG

25 kA
440 V
 ≤ 25 ns
green = OK; red = arrester is defective - replace
Installation housing: 1TE, Insta IP 20
-40 °C...85 °C
 ≤ 2000 m

2.5...10 mm² / 2.5...10 mm²
13 mm
1.2...2 Nm

CE
IEC 61643-11, EN 61643-11

Type II, Type III / T2, T3
Type II, Type III
230 V
440 V /
Single-phase, TN-S
10 kA /
20 kA /
 ≤ 1.7 kV

No Fuse necessary ≤ 100 A gG

25 kA
440 V
 ≤ 25 ns
green = OK; red = arrester is defective - replace
Installation housing: 1TE, Insta IP 20
-40 °C...85 °C
 ≤ 2000 m

2.5...10 mm² / 2.5...10 mm²
13 mm
1.2...2 Nm

CE
IEC 61643-11, EN 61643-11

Dimensions / Remote signalling contact info

Clamping range (nominal / min. / max.) mm²
Height x width x depth mm
Signalling contact

Note**no remote sig. contact with remote signalling (R)**

10 / 2.5 / 35 10 / 2.5 / 35
97 / 18 / 70 105 / 18 / 70
No 250 V / 0,5 A

Wire-end ferrules must be used when connecting finely stranded wire.

no remote sig. contact with remote signalling (R)

10 / 2.5 / 35 10 / 2.5 / 35
97 / 18 / 70 105 / 18 / 70
No 250 V / 0,5 A

Wire-end ferrules must be used when connecting finely stranded wire.

Ordering data

without remote signalling contact
with remote signalling contact (R)

Type	Qty.	Order No.
VPU AC II+III 1+1 440/20 S	1	2908500000
VPU AC II+III 1+1 R 440/20 S	1	2908510000

Type	Qty.	Order No.
VPU AC II+III 2 440/20 S	1	2908440000
VPU AC II+III 2 R 440/20 S	1	2908450000

Note**Accessories****Note**

Pluggable spare arrester: VPU AC II+III 0 L/N-PE 440/20 S - 2908550000

Pluggable spare arrester L-N: VPU AC II+III 0 L-N 440/20 S - 2908540000

Type II+III - 440 V / 20 kA

- Back-up fuse not necessary up to 100 A
- Pluggable, coded arrester
- Co-ordination with VPU AC Type I
- Approved according to IEC/EN 61643-11 as type II and III

VPU AC II+III 3 (R) 440/20 S

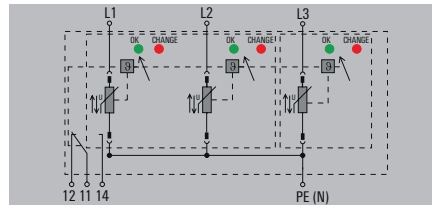

VPU AC II+III 3+1 (R) 440/20 S

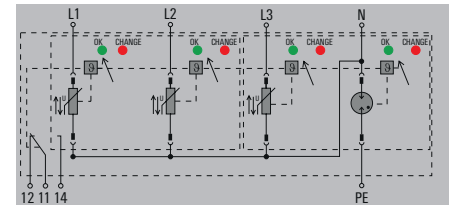

Technical data

Requirements category acc. to IEC/EN 61643-11
 Energy coordination (≤ 10 m)
 Rated voltage (AC)
 Max. continuous voltage, U_c (L-N / N-PE)
 Low voltage network
 Discharge current I_a (8/20 μ s) (Ader-PE / N-PE)
 Discharge current I_{max} (8/20 μ s) (Ader-PE / N-PE)
 Protection level U_p at I_a (L/N-PE)
 Protection level U_p at I_a (N-PE)
 Fuse

Short-circuit current rating I_{scCR}
 Temporary surge voltage (over-voltage) - TOV
 Response time
 Optical function display
 Design
 Ambient temperature (operational)
 Operating altitude

Connection data

Solid / Stranded
 Stripping length
 Tightening torque

Approvals

Approvals
 Standards

Type II, Type III / T2, T3

Type II, Type III

230 V

440 V /

TN-C

10 kA /

20 kA /

≤ 1.7 kV

No Fuse necessary ≤ 100 A gG

25 kA

440 V

≤ 25 ns

green = OK; red = arrester is defective - replace

Installation housing; 2TE, Insta IP 20

-40 °C...85 °C

≤ 2000 m

2.5...10 mm² / 2.5...10 mm²

13 mm

1.2...2 Nm

CE

IEC 61643-11, EN 61643-11

Type II, Type III / T2, T3

Type II, Type III

230 V

440 V / 255 V

TN-C-S, TN-S, TT, IT with N, IT without N

10 kA / 20 kA

20 kA / 40 kA

≤ 1.7 kV

≤ 1.5 kV

No Fuse necessary ≤ 100 A gG

25 kA

440 V

≤ 25 ns

green = OK; red = arrester is defective - replace

Installation housing; 2TE, Insta IP 20

-40 °C...85 °C

≤ 2000 m

2.5...10 mm² / 2.5...10 mm²

13 mm

1.2...2 Nm

CE

IEC 61643-11, EN 61643-11

Dimensions / Remote signalling contact info

Clamping range (nominal / min. / max.) mm²
 Height x width x depth mm
 Signalling contact

Note

no remote sig. contact

10 / 2.5 / 35
 97 / 36 / 70
 No

with remote signalling (R)

10 / 2.5 / 35
 99 / 36 / 70
 250 V / 0,5 A

Wire-end ferrules must be used when connecting finely stranded wire.

no remote sig. contact

10 / 2.5 / 35
 97 / 36 / 70
 No

with remote signalling (R)

10 / 2.5 / 35
 99 / 36 / 70
 250 V / 0,5 A

Wire-end ferrules must be used when connecting finely stranded wire.

Ordering data

without remote signalling contact
 with remote signalling contact (R)

Type	Qty.	Order No.
VPU AC II+III 3 440/20 S	1	2908460000
VPU AC II+III 3 R 440/20 S	1	2908470000

Type	Qty.	Order No.
VPU AC II+III 3+1 440/20 S	1	2908520000
VPU AC II+III 3+1 R 440/20 S	1	2908530000

Note

Accessories

Note

Pluggable spare arrester L-N: VPU AC II+III 0 L-N 440/20 S - 2908540000; VPU AC II+III 0 L3-PEN 440/20 S - 2908560000

Pluggable spare arrester L-N: VPU AC II+III 0 L-N 440/20 S - 2908540000; VPU AC II+III 0 L/N-PE 440/20 S - 2908550000



Type II+III - 440 V / 20 kA

- Back-up fuse not necessary up to 100 A
- Pluggable, coded arrester
- Co-ordination with VPU AC Type I
- Approved according to IEC/EN 61643-11 as type II and III

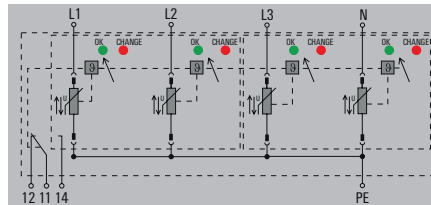
VPU AC II+III 4 (R) 440/20 S**Technical data**

Requirements category acc. to IEC/EN 61643-11
 Energy coordination (≤ 10 m)
 Rated voltage (AC)
 Max. continuous voltage, U_c (L-N / N-PE)
 Low voltage network
 Discharge current I_n (8/20 μ s) (Ader-PE / N-PE)
 Discharge current I_{max} (8/20 μ s) (Ader-PE / N-PE)
 Protection level U_p at I_n (L/N-PE)
 Protection level U_p at I_n (N-PE)
 Fuse

Short-circuit current rating I_{SCCR}
 Temporary surge voltage (over-voltage) - TOV
 Response time
 Optical function display
 Design
 Ambient temperature (operational)
 Operating altitude

Connection data

Solid / Stranded
 Stripping length
 Tightening torque

Approvals

Approvals
 Standards

Type II, Type III / T2, T3
 Type II, Type III
 230 V
 440 V /
 TN-C-S, TN-S
 10 kA /
 20 kA /
 ≤ 1.7 kV
 ≤ 1.5 kV
 No Fuse necessary ≤ 100 A gG

25 kA
 440 V
 ≤ 25 ns
 green = OK; red = arrester is defective - replace
 Installation housing: 2TE, Insta IP 20
 -40 °C... 85 °C
 ≤ 2000 m

2.5...10 mm² / 2.5...10 mm²
 13 mm
 1.2...2 Nm

CE
 IEC 61643-11, EN 61643-11

Dimensions / Remote signalling contact info

Clamping range (nominal / min. / max.) mm²
 Height x width x depth mm
 Signalling contact

Note**no remote sig. contact with remote signalling (R)**

10 / 2.5 / 35	10 / 2.5 / 35
97 / 36 / 70	99 / 36 / 70
No	250 V / 0,5 A

Wire-end ferrules must be used when connecting finely stranded wire.

Ordering data

without remote signalling contact
 with remote signalling contact (R)

Type	Qty.	Order No.
VPU AC II+III 4 440/20 S	1	2908480000
VPU AC II+III 4 R 440/20 S	1	2908490000

Note**Accessories****Note**

Pluggable spare arrester L-N: VPU AC II+III 0 L-N 440/20 S - 2908540000



VPU III surge protection for terminal devices

Maximum type III protection from surges

This product line provides an integrated protective strategy for surge protection for end devices. Rail-based mounting installations are especially important for industrial applications. For this reason, the housing design has been adapted to the standardised installation dimensions.

The VPU III has a wide array of available functions. A status signal and a connection for the floating contact make the unit easy to service. A defective device can easily be swapped out because of the plug-in connectors.

The VPU III covers all standard nominal voltages in the power range:

- 12 V
- 24 V
- 48 V
- 120 V
- 230 V





Best overview

LEDs provide clearly visible information on the status of the protective function.

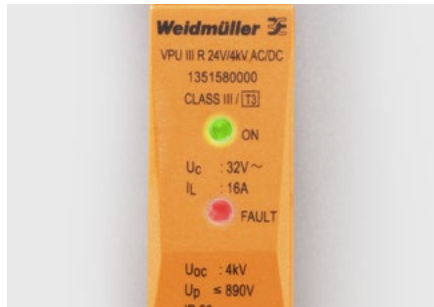

High ease of maintenance

The pluggable arresters enable quick, easy and safe replacement in the event of maintenance.



Faster to assemble

The optimised mounting rail clip enables easy and quick installation, without the need for tools.

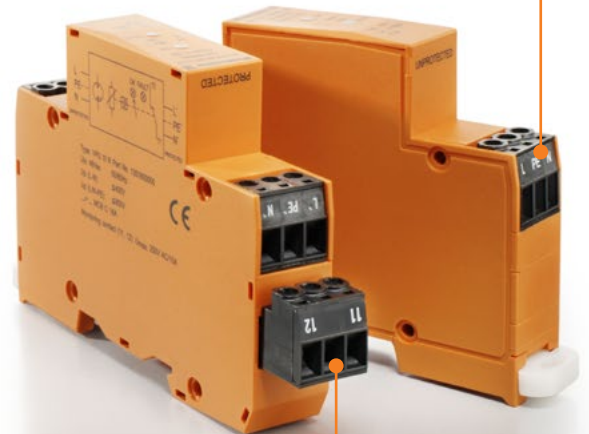

Rapid status messaging

The remote signalling contact provides reliable information regarding the status of the protective function.

Type III surge protection for end devices

Low-voltage consumer installations, small distribution units and electronics

Surge protection module type III

Our surge protection modules VPU III protects low voltage consumer installations and electronic devices from voltage surges that occur through atmospheric discharge (lightning) or switching activities (transients).

The VPU III can be built into small distribution boards or into multi-floor distribution boards.

The VPU III satisfies the requirements of IEC 61643-11.

Electrical connection

The VPU III surge protection device is installed after the VPU II arrester and before the device / consumer to be protected. It can protect electrical circuits of up to 16 A. An installation can be done in a consumer unit for an electrical circuit that protects monitors, for example..

Functional check and maintenance

The integrated temperature monitoring device automatically disconnects the varistor from the power supply. This disconnection is indicated by the warning LED being extinguished.

With the VPU III, a switch contact is also fitted for signalling. With the VPU III SO LD, an LED is used to indicate status and with the VPU III SO LD+A a buzzer highlights any error messages.

The back-up fuse you install depends on the conductor cross-section and type of routing. For VPU III arresters, the maximum power rating is 16 A. The connection is rated to IEC 947-7-1 for the following cross-sections:

solid conductor: 0.5...2.5 mm²
flexible conductor: 0.5...2.5 mm²



**Dimensioned drawing VPU III**

Overall width 18 mm

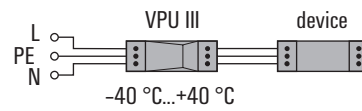
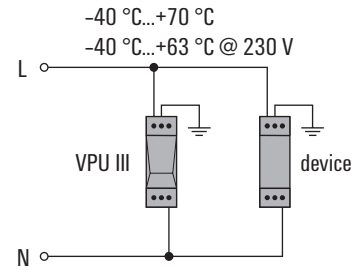
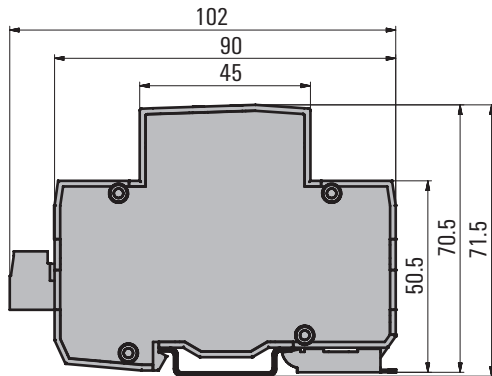

The standard implementation for operating the VPU III products is a series connection to the end device. Under this operational state, the protective device can bear a long-term load of 16 A. For higher demands, parallel circuitry is used

Type III - TS 35

- Type III surge protection
- Suitable for protecting terminals
- Installed in the vicinity of the equipment to be protected
- For mounting on rail TS 35
- Arrester with remote signalling contact
- Tested in accordance with IEC 61643-11

VPU III R 12V/4KV AC/DC

For use as device protector

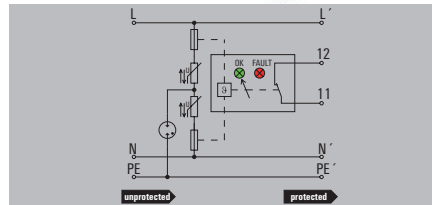

VPU III R 24V/4KV AC/DC

For use as device protector

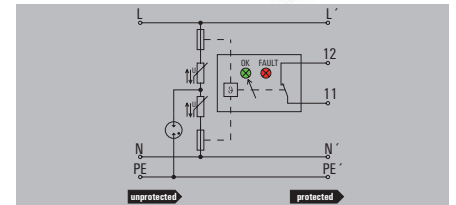

Technical data

Rated voltage (AC)
 Rated voltage (DC)
 Max. continuous voltage, U_c (AC)
 Max. continuous voltage, U_c (DC)
 Combined pulse U_{oc}
 Discharge current, max. (8/20 μ s)
 Rated current I_n
 Requirements class, acc. to EN 61643-11
 Short-circuit current rating I_{scCR}
 Leakage current at U_n
 Fuse
 Temporary surge voltage (over-voltage) - TOV
 Protection level U_p (typ.)
 Response time
 Optical function display
 Design
 Colour
 Ambient temperature (operational)

Connection data

Solid
 Stranded
 Stripping length
 Tightening torque

Approvals

Approvals
 Standards

12 V
 16 V
 20 V
 28 V
 4 kV
 2 kA
 16 A
 T3
 1.5 kA
 30 μ A
 16 A
 23 V
 ≤ 0.98 kV
 ≤ 100 ns
 Green LED = OK, Red LED = arrester is defective, replace
 Installation housing; 1TE, Insta IP 20
 orange
 -40 °C...70 °C

0.5...2.5 mm²
 0.5...2.5 mm²
 7 mm
 0.4...0.5 Nm

CE; OEVE
 IEC 61643-11, EN 61643-11

24 V
 32 V
 32 V
 42 V
 4 kV
 2 kA
 16 A
 T3
 1.5 kA
 30 μ A
 16 A
 46 V
 ≤ 0.9 kV
 ≤ 100 ns
 Green LED = OK, Red LED = arrester is defective, replace
 Installation housing; 1TE, Insta IP 20
 orange
 -40 °C...70 °C

0.5...2.5 mm²
 0.5...2.5 mm²
 7 mm
 0.4...0.5 Nm

CE; OEVE
 IEC 61643-11, EN 61643-11

Dimensions / Remote signalling contact info

Clamping range (nominal / min. / max.) mm²
 Height x width x depth mm
 Signalling contact

Note

Screw connection

2.5 / 0.5 / 2.5
 102 / 18 / 71.5
 250 V 10 A 1 NC
 Wire-end ferrules must be used when connecting finely stranded wire.

Screw connection

2.5 / 0.5 / 2.5
 102 / 18 / 71.5
 250 V 10 A 1 NC
 Wire-end ferrules must be used when connecting finely stranded wire.

Ordering data

Screw connection

Type	Qty.	Order No.
VPU III R 12V/4KV AC/DC	1	1351550000

Type	Qty.	Order No.
VPU III R 24V/4KV AC/DC	1	1351580000

Note

Accessories

Note

Type III - TS 35

- Type III surge protection
- Suitable for protecting terminals
- Installed in the vicinity of the equipment to be protected
- For mounting on rail TS 35
- Arrester with remote signalling contact
- Tested in accordance with IEC 61643-11

VPU III R 48V/4KV AC/DC

For use as device protector

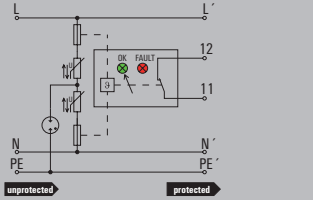

VPU III R 120V/6KV AC/DC

For use as device protector

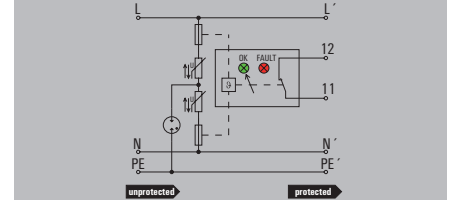

Technical data

Rated voltage (AC)
Rated voltage (DC)
Max. continuous voltage, U_c (AC)
Max. continuous voltage, U_c (DC)
Combined pulse U_{oc}
Discharge current, max. (8/20 μ s)
Rated current I_n
Requirements class, acc. to EN 61643-11
Short-circuit current rating I_{scCR}
Leakage current at U_n
Fuse
Temporary surge voltage (over-voltage) - TOV
Protection level U_p (typ.)
Response time
Optical function display
Design
Colour
Ambient temperature (operational)
Connection data
Solid
Stranded
Stripping length
Tightening torque
Approvals
Approvals
Standards

48 V
68 V
50 V
72 V
4 kV
2 kA
16 A
T3
1.5 kA
30 μ A
16 A
92 V
≤ 950 V
≤ 100 ns
Green LED = OK, Red LED = arrester is defective, replace
Installation housing; 1TE, Insta IP 20
orange
-40 °C...70 °C
0.5...2.5 mm ²
0.5...2.5 mm ²
7 mm
0.4...0.5 Nm
CE; OEVE
IEC 61643-11, EN 61643-11

120 V
150 V
150 V
212 V
6 kV
3 kA
16 A
T3
1.5 kA
30 μ A
16 A
229 V
≤ 1.75 kV
≤ 100 ns
Green LED = OK, Red LED = arrester is defective, replace
Installation housing; 1TE, Insta IP 20
orange
-40 °C...70 °C
0.5...2.5 mm ²
0.5...2.5 mm ²
7 mm
0.4...0.5 Nm
CE; OEVE
IEC 61643-11, EN 61643-11

Dimensions / Remote signalling contact info

Clamping range (nominal / min. / max.)	mm ²
Height x width x depth	mm
Signalling contact	

Note

Screw connection

2.5 / 0.5 / 2.5
102 / 18 / 71.5
250 V 10 A 1 NC

Wire-end ferrules must be used when connecting finely stranded wire.

Screw connection

2.5 / 0.5 / 2.5
102 / 18 / 71.5
250 V 10 A 1 NC

Wire-end ferrules must be used when connecting finely stranded wire.

Ordering data

Screw connection

Type	Qty.	Order No.
VPU III R 48V/4KV AC/DC	1	135160000

Type	Qty.	Order No.
VPU III R 120V/6KV AC/DC	1	135163000

Note

Accessories

Note



Type III - TS 35

- Type III surge protection
- Suitable for protecting terminals
- Installed in the vicinity of the equipment to be protected
- For mounting on rail TS 35
- Arrester with remote signalling contact
- Tested in accordance with IEC 61643-11

VPU III R 230V/6KV AC

For use as device protector

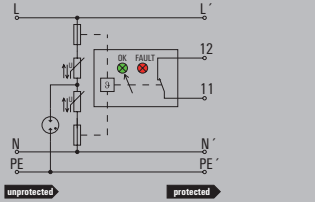

Technical data

Rated voltage (AC)
 Rated voltage (DC)
 Max. continuous voltage, U_c (AC)
 Max. continuous voltage, U_c (DC)
 Combined pulse U_{oc}
 Discharge current, max. (8/20 μ s)
 Rated current I_n
 Requirements class, acc. to EN 61643-11
 Short-circuit current rating I_{SCCR}
 Leakage current at U_n
 Fuse
 Temporary surge voltage (over-voltage) - TOV
 Protection level U_p (typ.)
 Response time
 Optical function display
 Design
 Colour
 Ambient temperature (operational)

230 V
 300 V
 6 kV
 3 kA
 16 A
 T3
 1.5 kA
 30 μ A
 16 A
 438 V
 ≤ 1.8 kV
 ≤ 100 ns
 Green LED = OK, Red LED = arrester is defective, replace
 Installation housing: 1TE, Insta IP 20
 orange
 -40 °C...70 °C

Connection data

Solid
 Stranded
 Stripping length
 Tightening torque

0.5...2.5 mm²
 0.5...2.5 mm²
 7 mm
 0.4...0.5 Nm

Approvals

Approvals
 Standards

CE: DEVE
 IEC 61643-11, EN 61643-11

Dimensions / Remote signalling contact info

Clamping range (nominal / min. / max.) mm²
 Height x width x depth mm
 Signalling contact

Screw connection

2.5 / 0.5 / 2.5
 102 / 18 / 71.5
 250 V 10 A 1 NC
 Wire-end ferrules must be used when connecting finely stranded wire.

Note

Ordering data

Screw connection

Type	Qty.	Order No.
VPU III R 230V/6KV AC	1	1351650000

Note

Accessories

Note

Type III – SO LD

- Type III surge protection
- Suitable for protecting terminals
- Installed in the vicinity of the equipment to be protected

VPU III SO LD / +A

For use as device protector

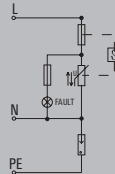
**Technical data**

Rated voltage (AC)
 Rated voltage (DC)
 Max. continuous voltage, U_c (AC)
 Max. continuous voltage, U_c (DC)
 Combined pulse U_{oc}
 Discharge current I_{max} (8/20 μ s) wire-PE
 Rated current I_n
 Requirements class, acc. to EN 61643-11
 Short-circuit current rating I_{SCCR}
 Leakage current at U_n
 Fuse
 Temporary surge voltage (over-voltage) - TOV
 Protection level U_p at I_n (L/N-PE)
 Response time
 Optical function display
 Design
 Colour
 Ambient temperature (operational)

230 V
 275 V
 3 kV
 T3
 1.5 kA
 30 μ A
 16 A
 440 V
 ≤ 1.5 kV
 $<100\mu$ s
 Green LED = OK, Red LED = arrester is defective, replace
 Flush mounting
 black
 -25 °C... 55 °C

Approvals

Approvals
 Standards

CE
 IEC 61643-11, EN 61643-11

Dimensions / Remote signalling contact info

Clamping range (nominal / min. / max.) mm²
 Height x width x depth mm
 Signalling contact

Note**Without audible signal****with acoustic signal (A)**

35 / 12 / 25
 No

35 / 12 / 25
 No

Cable length approx. 118 mm

Ordering data

with acoustic signal (A)
 without acoustic signal

Type	Qty.	Order No.
VPU III SO LD+A	1	1351700000
VPU III SO LD	1	1351680000

Note**Accessories****Note**

Going digital with communication-capable surge protection

VARITECTOR PU IoT AC for easy implementation in the IoT

Surge protection is becoming more and more important due to increasing digitalization. On the one hand, because the sensitivity of intelligent devices, systems, and infrastructures is growing, and on the other, because cloud communication and the exchange of process data are playing an increasing role.

The surge protection devices of the type VPU IoT AC combine the functions of a powerful surge protection with those of an intelligent IoT device. This enables important functions to be monitored. As a result, important functions can be monitored, including the device status in real time, the number of overvoltages, the status of the protective earth connection, the history of temporary overvoltages (TOV), replacement recommendations, and much more.

Your special advantages:

- Simple integration into cloud systems
- Higher added value due to condition monitoring
- Powerful surge protection
- Suitable for 3rd-party cloud solutions



Powerful surge protection

The powerful technology guarantees a discharge current up to 50 kA. Operation is possible up to 315 A without an additional pre-fuse. This saves components and installation time.



Simple cloud integration

The smart surge protection can be implemented directly in an existing WiFi infrastructure and connected to a cloud system. In this way, important process data of the device can be monitored regardless of location – e.g. the number of overvoltages.

Efficient condition monitoring

Condition monitoring of all important parameters takes place in real time. By evaluating the data, future maintenance measures can be planned efficiently. This increases system availability.

VPU IoT

- Condition monitoring in real time
- Integrated test device
- Overvoltage registration
- Exchange recommendation function of the modules
- Monitoring of the earth conductor connection
- History of temporary overvoltage (TOV)
- Voltage monitoring of the particular phases
- Status LED and push button
- Cloud connection via WiFi

VPU IOT AC II 3+1 300/50

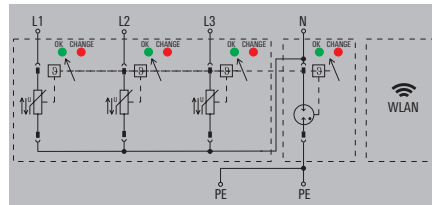

Technical data

Rated voltage (AC)	230 V
Max. continuous voltage, U_c (AC)	300 V
Discharge current I_n (8/20 μ s) wire-PE	20 kA
Discharge current I_{max} (8/20 μ s) wire-PE	50 kA
Requirements class, acc. to EN 61643-11	T2
Short-circuit current rating I_{scCR}	50 kA
Leakage current at U_n	1 μ A
Fuse	No Fuse necessary ≤ 315 A gG, 250 A gG @50 kA I_{scCR} , 315 A gG @25 kA I_{scCR}
Temporary surge voltage (over-voltage) - TOV	337 V
Protection level U_p (typ.)	$\leq 1,5$ kV
Response time	≤ 25 ns
Optical function display	green = OK; red = arrester is defective - replace
Design	Installation housing: 6 TE, Insta IP 20
Colour	black, orange
Ambient temperature (operational)	-40 °C...85 °C
Storage temperature	-40 °C...85 °C

Connection data	
Solid	4...16 mm ²
Stranded	2.5...25 mm ²
Stripping length	18 mm
Tightening torque	2...3 Nm
Approvals	
Approvals	CE
Standards	IEC 61643-11, EN 61643-11

Dimensions / Remote signalling contact info	
Clamping range (nominal / min. / max.)	mm ² 16 / 4 / 35
Height x width x depth	mm 90 / 108 / 68
Signalling contact	No
Note	
Wire-end ferrules must be used when connecting finely stranded wire.	

Ordering data

Type	Qty.	Order No.
VPU IOT AC II 3+1 300/50	1	2735900000

Note	
-------------	--

Accessories

Note	Pluggable spare arrester L-N: VPU IoT AC II 0 300/50 2810460000
-------------	-----------------------------------------------------------------

Lightning and surge protection for photovoltaic (PV)

Lightning and surge protection for photovoltaic (PV)	Quick selection guide	B.2
	Lightning and surge protection for photovoltaic systems on the DC side - VPU PV series	B.4
	Lightning and surge protection for photovoltaic systems on the DC side - PV Protect series	B.18



Product quick selection, Photovoltaics

Lightning and surge protection for photovoltaic systems

Product	Version	Rated voltage	Lightning test current	Total leakage current	Discharge current	Protection level	Short-circuit resistance	Operating altitude up to	Signalling contact	Overall width	Order No.
		U _c (DC)	I _{imp} (10/350µs)	I _{total} (10/350µs)	I _{max} (8/20µs)	U _p	I _{SCPV}				
Type I + II											
VPU PV I+II 3 600 E	3-pole, pluggable	600 V	6.25 kA	6.25 kA	40 kA	3.8 kV	11 kA	4000 m	-	3 TE	2857030000
VPU PV I+II 3 R 600 E	3-pole, pluggable	600 V	6.25 kA	6.25 kA	40 kA	3.8 kV	11 kA	4000 m	1 CO	3 TE	2857040000
VPU PV I+II 3 1000 E	3-pole, pluggable	1000 V	6.25 kA	6.25 kA	40 kA	3.8 kV	11 kA	4000 m	-	3 TE	2530520000
VPU PV I+II 3 R 1000 E	3-pole, pluggable	1000 V	6.25 kA	6.25 kA	40 kA	3.8 kV	11 kA	4000 m	1 CO	3 TE	2530190000
VPU PV I+II 3 1000	3-pole, pluggable	1000 V	6.25 kA	12.5 kA	40 kA	3.8 kV	11 kA	4000 m	-	3 TE	2530610000
VPU PV I+II 3 R 1000	3-pole, pluggable	1000 V	6.25 kA	12.5 kA	40 kA	3.8 kV	11 kA	4000 m	1 CO	3 TE	2530620000
VPU PV I+II 3 1500	3-pole, pluggable	1500 V	5 kA	10 kA	30 kA	5.0 kV	11 kA	4000 m	-	3 TE	2530580000
VPU PV I+II 3 R 1500	3-pole, pluggable	1500 V	5 kA	10 kA	30 kA	5.0 kV	11 kA	4000 m	1 CO	3 TE	2530590000
VPU PV I+II 5 1000	5-pole, pluggable	1000 V	5 kA	10 kA	40 kA	3.8 kV	11 kA	4000 m	-	5 TE	2856440000
VPU PV I+II 5 R 1000	5-pole, pluggable	1000 V	5 kA	10 kA	40 kA	3.8 kV	11 kA	4000 m	1 CO	5 TE	2856490000
VPU PV I+II 5 1500	5-pole, pluggable	1500 V	5 kA	10 kA	40 kA	5.0 kV	11 kA	4000 m	-	5 TE	3012980000
VPU PV I+II 5 R 1500	5-pole, pluggable	1500 V	5 kA	10 kA	40 kA	5.0 kV	11 kA	4000 m	1 CO	5 TE	3012990000
Type II											
VPU PV II 3 600	3-pole, pluggable	600 V	-	-	50 kA	2.0 kV	11 kA	4000 m	-	3 TE	2857060000
VPU PV II 3 R 600	3-pole, pluggable	600 V	-	-	50 kA	2.0 kV	11 kA	4000 m	1 CO	3 TE	2857070000
VPU PV II 3 1000	3-pole, pluggable	1100 V	-	-	40 kA	3.8 kV	11 kA	4000 m	-	3 TE	2530550000
VPU PV II 3 R 1000	3-pole, pluggable	1100 V	-	-	40 kA	3.8 kV	11 kA	4000 m	1 CO	3 TE	2530180000
VPU PV II 3 1500	3-pole, pluggable	1500 V	-	-	30 kA	5.0 kV	11 kA	4000 m	-	3 TE	2530640000
VPU PV II 3 R 1500	3-pole, pluggable	1500 V	-	-	30 kA	5.0 kV	11 kA	4000 m	1 CO	3 TE	2530650000
VPU PV II 5 1000	5-pole, pluggable	1100 V	-	-	40 kA	4.2 kV	9 kA	4000 m	-	5 TE	2856500000
VPU PV II 5 R 1000	5-pole, pluggable	1100 V	-	-	40 kA	4.2 kV	9 kA	4000 m	1 CO	5 TE	2857020000
Type I+II - PCB Adapter											
VPCB PV I+II R 600 E	solderable, pluggable	600 V	-	-	40 kA	-	11 kA	4000 m	1 CO	17.9 mm	2857100000
VPCB PV I+II 1000 E	solderable, pluggable	1000 V	-	-	40 kA	-	11 kA	4000 m	-	17.9 mm	2665700000
VPCB PV I+II R 1000 E	solderable, pluggable	1000 V	-	-	40 kA	-	11 kA	4000 m	1 CO	17.9 mm	2665730000
VPCB PV I+II 1000	solderable, pluggable	1000 V	-	-	40 kA	-	11 kA	4000 m	-	17.9 mm	2665740000
VPCB PV I+II R 1000	solderable, pluggable	1000 V	-	-	40 kA	-	11 kA	4000 m	1 CO	17.9 mm	2665760000
VPCB PV I+II M 1000	solderable, pluggable	1000 V	-	-	40 kA	-	11 kA	4000 m	-	17.9 mm	2665750000
VPCB PV I+II R M 1000	solderable, pluggable	1000 V	-	-	40 kA	-	11 kA	4000 m	1 CO	17.9 mm	2665770000
VPCB PV I+II 5 R M 1000	solderable, pluggable	1000 V	-	-	40 kA	-	11 kA	4000 m	1 CO	17.9 mm	2874710000
Type II - PCB Adapter											
VPCB PV II R 600	solderable, pluggable	600 V	-	-	40 kA	-	11 kA	4000 m	1 CO	17.9 mm	2857090000
VPCB PV II 1000	solderable, pluggable	1000 V	-	-	40 kA	-	11 kA	4000 m	-	17.9 mm	2665680000
VPCB PV II R 1000	solderable, pluggable	1000 V	-	-	40 kA	-	11 kA	4000 m	1 CO	17.9 mm	2665690000
Type I/II - PV Protect Box											
VPUM111SXFV100TXPX10	1 MPPT	1000 V	6.25 kA	12.5 kA	40 kA	≤ 4.2 kV	11 kA	4000 m	-	168 mm	2755970000
VPUM212SXFV100TXPX10	2 MPPT	1000 V	6.25 kA	12.5 kA	40 kA	≤ 4.2 kV	11 kA	4000 m	-	168 mm	2755980000
VPUM111SXFV101TXPX10	1 MPPT	1000 V	6.25 kA	12.5 kA	40 kA	≤ 4.2 kV	11 kA	4000 m	-	168 mm	2764140000
VPUM212SXFV101TXPX10	2 MPPT	1000 V	6.25 kA	12.5 kA	40 kA	≤ 4.2 kV	11 kA	4000 m	-	168 mm	2764150000
Type II - PV Protect Box											
VPUM111SXFV200TXPX10	1 MPPT	1000 V	-	-	40 kA	≤ 4.2 kV	11 kA	4000 m	-	168 mm	2755950000
VPUM212SXFV200TXPX10	2 MPPT	1000 V	-	-	40 kA	≤ 4.2 kV	11 kA	4000 m	-	168 mm	2755960000
VPUM111SXFV200TXPX15	1 MPPT	1000 V	-	-	40 kA	≤ 4.2 kV	11 kA	4000 m	-	168 mm	2755990000
VPUM212SXFV200TXPX15	2 MPPT	1000 V	-	-	40 kA	≤ 4.2 kV	11 kA	4000 m	-	168 mm	2756000000
VPUM111SXFV201TXPX10	1 MPPT	1000 V	-	-	40 kA	≤ 4.2 kV	11 kA	4000 m	-	168 mm	2764110000
VPUM212SXFV201TXPX10	2 MPPT	1000 V	-	-	40 kA	≤ 4.2 kV	11 kA	4000 m	-	168 mm	2764130000
VPUM111SXFV201TXPX15	1 MPPT	1000 V	-	-	40 kA	≤ 4.2 kV	11 kA	4000 m	-	168 mm	2764160000
VPUM212SXFV201TXPX15	2 MPPT	1000 V	-	-	40 kA	≤ 4.2 kV	11 kA	4000 m	-	168 mm	2764180000



VPU PV lightning and surge protection

Compact design an the latest technology to protect your PV application

Modern photovoltaic energy generation is streamlined to efficiency. Reliable surge protection with future-proof performance is a must to maximise system uptime and profitability. The VARITECTOR PU PV series is designed for use in PV string combiner boxes for generator voltages up to 1,500 V and complies with latest UL and EN standards for global application.

The VPU PV series offers products for the following rated voltages (DC):

- 600 V
- 1000 V
- 1500 V





Type I and II protection

Type I and II protection is supported for 600 V, 1,000 V and 1,500 V systems fully compliant to latest EN / IEC standards.

600 V
1,000 V
1,500 V

Maximum short-circuit capability

PV plants, which combine many panels in a string, are protected up to 11 kA of the expected short-circuit current. Additional fuses for the SPD are not required.

I_{scpv}
11 kA

Slim and pluggable arresters

The surge protection devices are easily pluggable and enable a tool-free, fast and cost-effective replacement.



Safe operation up to 4,000 m

PV plants, also such located in high altitude regions, are reliably protected. An additional risk analysis of deratings is not required for extraordinary locations.

up to
4,000 m



VPCB Base PV

A wide range of accessories round off the PV surge protection range, e.g. the special bracket for the arresters for direct mounting on the circuit board.



Customise your protection with VARITECTOR PU PV devices

A full scale portfolio for tailored DC and AC protection solutions



Several aspects need to be covered that are related to the type of system (e.g. rooftop systems or utility-scale open space systems). When selecting overvoltage protection measures, a set of regulations have to be observed.

PV-System with lightning rod system

In case the separation distance (typical >0,7m up to 1m) is met a Type II SPD can be used. Does the separation distance not meet the required value a Type I SPD should be in place for the DC-wiring.

PV-System without lightning rod system

This is a common set up in which a Type II SPD has to be in place for the DC-wiring.

The figure on the left shows a general PV system architecture. The selection guide table below gives the requirements out of the valid standards for surge protection in photovoltaic systems.

Because PV systems are always set up in exposed areas (exposed to direct lightning), it is advisable to always install Type I+II SPDs. This, in addition enhances the life time of installed protection components.

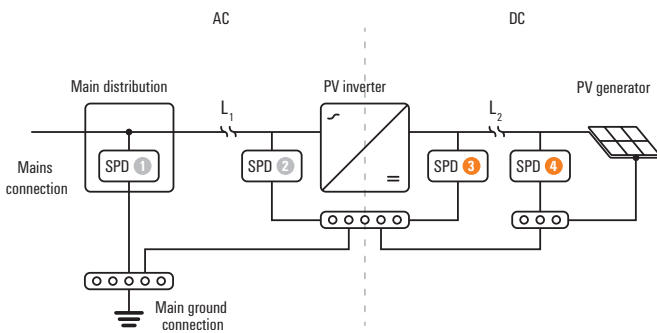

Surge protection selection guide

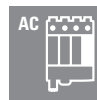

External lightning protection system	Observe separation distance	Line length L ₁ < 10 m	Line length L ₂ < 10 m	Place of installation ①	Place of installation ②*	Place of installation ③	Place of installation ④
no	-	no	no	Type II AC	Type II AC	Type II PV	Type II PV
no	-	no	yes	Type II AC	Type II AC	Type II PV	-
no	-	yes	no	Type II AC	-	Type II PV	Type II PV
no	-	yes	yes	Type II AC	-	Type II PV	-
yes	yes	no	no	Type I AC	Type II AC	Type II PV	Type II PV
yes	yes	no	yes	Type I AC	Type II AC	Type II PV	-
yes	yes	yes	no	Type I AC	-	Type II PV	Type II PV
yes	yes	yes	yes	Type I AC	-	Type II PV	-
yes	no	no	no	Type I AC	Type I AC	Type II PV	Type I PV
yes	no	no	yes	Type I AC	Type I AC	Type I PV	-
yes	no	yes	no	Type I AC	-	Type I PV	Type I PV
yes	no	yes	yes	Type I AC	-	Type I PV	-

*If the inverter and main distribution board are connected to the same earthing busbar with a cable length of less than or equal to 0.5 m each, no SPD is required at installation location „2“.

Energy co-ordination

All lightning and surge protection products of the VARITECTOR series are energetically coordinated with each other. No additional downstream components are required for decoupling.

Checking operation, maintenance and approvals

All arresters based on varistor technology have large status windows. If the status window is red, the corresponding arrester must be changed.

Remote contact (R)

All modules in the VPU PV series are optionally available with a remote signaling contact. This is integrated directly into the module. This contact is to be connected as a changeover contact via a PUSH IN plug connection.

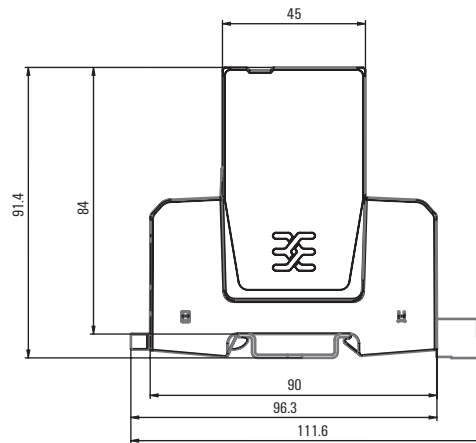

Dimensional drawing VPU PV I+II

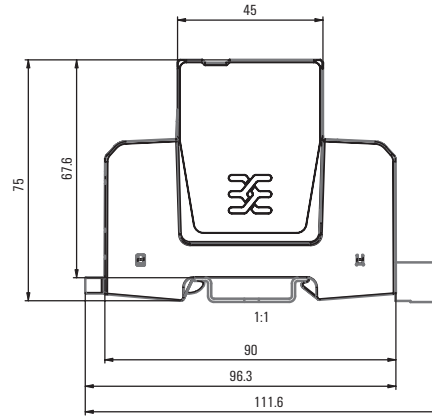

Dimensional drawing VPU PV II



Accessories: Remote signalling contact and locking clip

Type			
	Remote signalling contact	PLUG VPU AC	2855300000
	Locking clip	VPU Locking Clip S	2735080000
	Locking clip	VPU Locking Clip L	2735070000

Type I+II

- Suitable for protection level III and IV (LPL III/IV)
- Can also be used as Type II surge protection
- Tested in accordance with EN 50539-11
- Suitable for use in accordance with IEC 60364-7-712/ EN 50539-12
- Use if the separation distance cannot be observed

VPU PV I+II 3 (R) 600 E

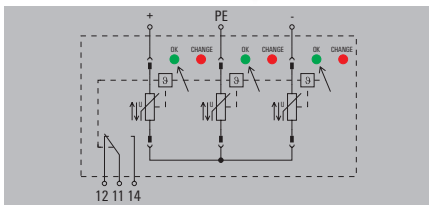

VPU PV I+II 3 (R) 1000 E

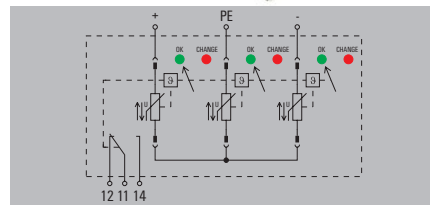

Technical data

PV system voltage, max. U_{opv}
 Lightning test current I_{imp} (10/350 μ s)
 Discharge current I_{max} (8/20 μ s) wire-PE
 Discharge current I_n (8/20 μ s)
 Total discharge current I_{total} (8/20 μ s)
 Total discharge current I_{total} (10/350 μ s)
 Protection level U_p (+/-, -/PE, +/-PE)
 Rated voltage (DC)
 Leakage current at U_n
 Response time
 Operating height in the grounded PV system
 Operating height in ungrounded PV system
 Short-circuit current I_{scpv}
 Optical function display
 Design
 Ambient temperature (operational)

600 V
 6.25 kA
 40 kA
 20 kA
 50 kA
 6.25 kA
 ≤ 2.8 kV
 600 V
 30 μ A
 ≤ 25 ns
 ≤ 2000 m
 ≤ 4000 m
 11000 A
 green = OK; red = arrester is defective - replace
 Installation housing; 3TE, Insta IP 20
 -40 °C...85 °C

1100 V
 6.25 kA
 40 kA
 20 kA
 50 kA
 6.25 kA
 ≤ 3.8 kV
 1000 V
 30 μ A
 ≤ 25 ns
 ≤ 2000 m
 ≤ 4000 m
 11000 A
 green = OK; red = arrester is defective - replace
 Installation housing; 3TE, Insta IP 20
 -40 °C...85 °C

Connection data

Solid
 Stranded
 Stripping length
 Tightening torque

1.5...6 mm²
 1.5...35 mm²
 18 mm
 3...4.5 Nm

1.5...6 mm²
 1.5...35 mm²
 18 mm
 3...4.5 Nm

Approvals

Approvals
 Standards

CE
 EN 61643-31, EN 50539-11

CE
 EN 61643-31, EN 50539-11

UL values

Rated Voltage U_n
 VPR (DC/G)
 VPR (DC+/DC-)
 SCCR
 I_n
 Category

Dimensions / Remote signalling contact info

Clamping range (nominal / min. / max.) mm²
 Height x width x depth mm
 Signalling contact

no remote sig. contact	with remote signalling (R)
6 / 1.5 / 35	6 / 1.5 / 35
96 / 54 / 77.2	110 / 54 / 77.2
No	250 V 1A 1CO

no remote sig. contact	with remote signalling (R)
6 / 1.5 / 35	6 / 1.5 / 35
96 / 54 / 70	104.5 / 54 / 70
No	250 V 1A 1CO

Note

Wire-end ferrules must be used when connecting finely stranded wire.

Wire-end ferrules must be used when connecting finely stranded wire.

Ordering data

without remote signalling contact
 with remote signalling contact (R)

Type	Qty.	Order No.
VPU PV I+II 3 600 E	1	2857030000
VPU PV I+II 3 R 600 E	1	2857040000

Type	Qty.	Order No.
VPU PV I+II 3 1000 E	1	2530520000
VPU PV I+II 3 R 1000 E	1	2530190000

Note

Accessories

Note

Pluggable spare arrester: VPU PV I+II 0 600 E - 2857050000

Pluggable spare arrester: VPU PV I+II 1000 E - 2530530000

Type I+II

- Suitable for protection level III and IV (LPL III/IV)
- Can also be used as Type II surge protection
- Tested in accordance with EN 50539-11
- Suitable for use in accordance with IEC 60364-7-712/ EN 50539-12
- Use if the separation distance cannot be observed

VPU PV I+II 3 (R) 1000

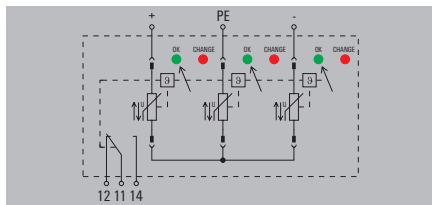

VPU PV I+II 3 (R) 1500

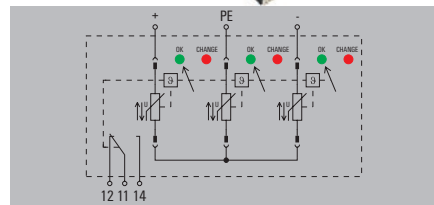

Technical data

PV system voltage, max. U_{opv}
 Lightning test current I_{imp} (10/350 μ s)
 Discharge current I_{max} (8/20 μ s) wire-PE
 Discharge current I_n (8/20 μ s)
 Total discharge current I_{total} (8/20 μ s)
 Total discharge current I_{total} (10/350 μ s)
 Protection level U_p (+/-, -/PE, +/-PE)
 Rated voltage (DC)
 Leakage current at U_n
 Response time
 Operating height in the grounded PV system
 Operating height in ungrounded PV system
 Short-circuit current I_{scpv}
 Optical function display
 Design
 Ambient temperature (operational)

Connection data

Solid
 Stranded
 Stripping length
 Tightening torque

Approvals

Approvals
 Standards

UL values

Rated Voltage U_n
 VPR (DC-/G)
 VPR (DC+/DC-)
 SCCR
 I_n
 Category

Dimensions / Remote signalling contact info

Clamping range (nominal / min. / max.) mm²
 Height x width x depth mm
 Signalling contact

Note

Ordering data

without remote signalling contact
 with remote signalling contact (R)

Note

Accessories

Note

1100 V
 6.25 kA
 30 kA
 20 kA
 50 kA
 12.5 kA
 ≤ 3.8 kV
 1000 V
 30 μ A
 ≤ 25 ns
 ≤ 2000 m
 ≤ 4000 m
 11000 A

green = OK; red = arrester is defective - replace
 Installation housing; 3TE, Insta IP 20

-40 °C...85 °C

1.5...6 mm²
 1.5...35 mm²
 18 mm
 3...4.5 Nm

CE; cURus; VDE
 EN 61643-31, EN 50539-11, UL 1449

1100 V
 2500 V
 2500 V
 50 kA
 20 kA
 SPD TYPE 1CA

no remote sig. contact with remote signalling (R)

6 / 1.5 / 35 6 / 1.5 / 35
 96 / 54 / 86 102 / 54 / 86
 No 250 V 1A 1CO

Wire-end ferrules must be used when connecting finely stranded wire.

Type	Qty.	Order No.
VPU PV I+II 3 1000	1	2530610000
VPU PV I+II 3 R 1000	1	2530620000

Pluggable spare arrester L-N: VPU PV I+II 0 1000 - 2530600000;
 VPU PV I+II 0M 1000 - 2534300000

1500 V
 5 kA
 80 kA
 20 kA
 40 kA
 10 kA
 ≤ 5.0 kV
 1500 V
 30 μ A
 ≤ 25 ns
 ≤ 2000 m
 ≤ 4000 m
 11000 A

green = OK; red = arrester is defective - replace
 Installation housing; 3TE, Insta IP 20

-40 °C...85 °C

1.5...6 mm²
 1.5...35 mm²
 18 mm
 3...4.5 Nm

CE; cURus; VDE
 EN 61643-31, EN 50539-11, UL 1449

1500 V
 4000 V
 4000 V
 65 kA
 20 kA
 SPD TYPE 1CA

no remote sig. contact with remote signalling (R)

6 / 1.5 / 35 6 / 1.5 / 35
 96 / 54 / 86 102 / 54 / 86
 No 250 V 1A 1CO

Wire-end ferrules must be used when connecting finely stranded wire.

Type	Qty.	Order No.
VPU PV I+II 3 1500	1	2530580000
VPU PV I+II 3 R 1500	1	2530590000

Pluggable spare arrester L-N: VPU PV I+II 0 1500 - 2530570000;
 VPU PV I+II 0M 1500 - 2534330000

Type I+II

- Suitable for protection level III and IV (LPL III/IV)
- Can also be used as Type II surge protection
- Tested in accordance with EN 50539-11
- Suitable for use in accordance with IEC 60364-7-712/ EN 50539-12
- Use if the separation distance cannot be observed

VPU PV I+II 5 (R) 1000

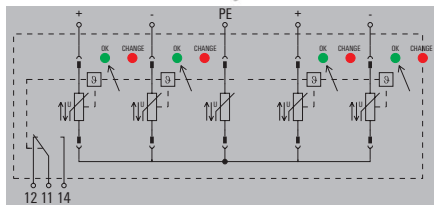

VPU PV I+II 5 (R) 1500

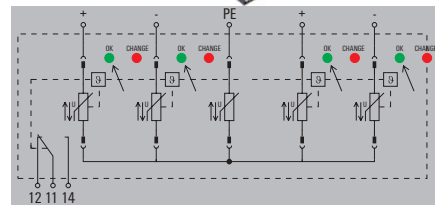

Technical data

PV system voltage, max. U_{opv}
 Lightning test current I_{imp} (10/350 μ s)
 Discharge current I_{max} (8/20 μ s) wire-PE
 Discharge current I_n (8/20 μ s)
 Total discharge current I_{total} (8/20 μ s)
 Total discharge current I_{total} (10/350 μ s)
 Protection level U_p (+/-, -/PE, +/-PE)
 Rated voltage (DC)
 Leakage current at U_n
 Response time
 Operating height in the grounded PV system
 Operating height in ungrounded PV system
 Short-circuit current I_{scpv}
 Optical function display
 Design
 Ambient temperature (operational)

1100 V
 5 kA
 30 kA
 20 kA
 50 kA
 10 kA
 ≤ 3.8 kV
 1000 V
 30 μ A
 ≤ 25 ns
 ≤ 2000 m
 ≤ 4000 m
 11000 A
 green = OK; red = arrester is defective - replace
 Installation housing, 5 TE, Insta IP 20
 -40 °C...85 °C

1500 V
 5 kA
 30 kA
 20 kA
 50 kA
 10 kA
 ≤ 5.0 kV
 1500 V
 30 μ A
 ≤ 25 ns
 ≤ 2000 m
 ≤ 4000 m
 11000 A
 green = OK; red = arrester is defective - replace
 Installation housing, 5 TE, Insta IP 20
 -40 °C...85 °C

Connection data

Solid
 Stranded
 Stripping length
 Tightening torque

1.5...6 mm²
 1.5...35 mm²
 18 mm
 3...4.5 Nm

1.5...6 mm²
 1.5...35 mm²
 18 mm
 3...4.5 Nm

Approvals

Approvals
 Standards

CE
 EN 61643-31, EN 50539-11

CE
 EN 61643-31, EN 50539-11

UL values

Rated Voltage U_n
 VPR (DC-/G)
 VPR (DC+/DC-)
 SCCR
 I_n
 Category

Dimensions / Remote signalling contact info

Clamping range (nominal / min. / max.) mm²
 Height x width x depth mm
 Signalling contact

no remote sig. contact	with remote signalling (R)
6 / 1.5 / 35	6 / 1.5 / 35
96.5 / 90 / 77.2	111 / 90 / 77.2
No	250 V 1A 1C0

no remote sig. contact	with remote signalling (R)
6 / 1.5 / 35	6 / 1.5 / 35
96.5 / 90 / 86	111 / 90 / 86
No	250 V 1A 1C0

Note

Wire-end ferrules must be used when connecting finely stranded wire.

Wire-end ferrules must be used when connecting finely stranded wire.

Ordering data

without remote signalling contact
 with remote signalling contact (R)

Type	Qty.	Order No.
VPU PV I+II 5 1000	1	2856440000
VPU PV I+II 5 R 1000	1	2856490000

Type	Qty.	Order No.
VPU PV I+II 5 1500	1	3012980000
VPU PV I+II 5 R 1500	1	3012990000

Note

Accessories

Note

Pluggable spare arrester: VPU PV I+II 5 0 1000 - 2857000000, VPU PV I+II 5 0M 1000 - 2856650000

Pluggable spare arrester: VPU PV I+II 5 0 1500 - 3013020000, VPU PV I+II 5 0M 1500 - 3013010000

Type II

- Pluggable arrester
- Suitable for protecting DC systems as Type II arrester
- Encapsulated, non-blow-out arrester
- Tested in accordance with EN 50539-11
- Pluggable arresters
- Suitable for use in accordance with IEC 60364-7-712 / EN 50539-12

VPU PV II 3 (R) 600

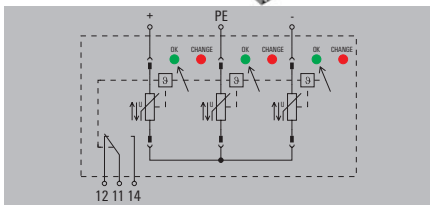

VPU PV II 3 (R) 1000

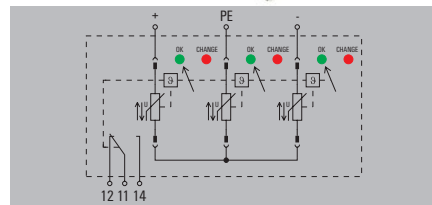

Technical data

PV system voltage, max. U_{spv}
 Discharge current I_{max} (8/20 μ s) wire-PE
 Discharge current I_n (8/20 μ s)
 Total discharge current I_{total} (8/20 μ s)
 Protection level U_p (+/-, -/PE, +/-PE)
 Rated voltage (DC)
 Leakage current at U_n
 Response time
 Operating height in the grounded PV system
 Operating height in ungrounded PV system
 Short-circuit current I_{scpv}
 Optical function display
 Design
 Ambient temperature (operational)

Connection data

Solid
 Stranded
 Stripping length
 Tightening torque

Approvals

Approvals
 Standards

UL values

Rated Voltage U_n
 VPR (DC-/G)
 VPR (DC+/DC-)
 SCCR
 I_n
 Category

600 V
 50 kA
 20 kA
 50 kA
 ≤ 2 kV
 600 V
 30 μ A
 ≤ 25 ns
 ≤ 2000 m
 ≤ 4000 m
 11000 A
 green = OK; red = arrester is defective - replace
 Installation housing; 3TE, Insta IP 20
 -40 °C...85 °C

1.5...6 mm²
 1.5...35 mm²
 18 mm
 3...4.5 Nm
 CE
 EN 61643-31, EN 50539-11

1100 V
 20 kA
 50 kA
 ≤ 3.8 kV
 1000 V
 30 μ A
 ≤ 25 ns
 ≤ 2000 m
 ≤ 4000 m
 11000 A
 green = OK; red = arrester is defective - replace
 Installation housing; 3TE, Insta IP 20
 -40 °C...85 °C

1.5...6 mm²
 1.5...35 mm²
 18 mm
 3...4.5 Nm
 CE; cURus; VDE
 EN 61643-31, EN 50539-11, UL 1449

1100 V
 2500 V
 2500 V
 50 kA
 20 kA
 SPD TYPE 1CA

Dimensions / Remote signalling contact info

Clamping range (nominal / min. / max.) mm²
 Height x width x depth mm
 Signalling contact

Note

no remote sig. contact	with remote signalling (R)
6 / 1.5 / 35	6 / 1.5 / 35
96 / 54 / 75	110 / 54 / 75
No	250 V 1A 1CO

Wire-end ferrules must be used when connecting finely stranded wire.

no remote sig. contact	with remote signalling (R)
6 / 1.5 / 35	6 / 1.5 / 35
96 / 54 / 70	102 / 54 / 70
No	250 V 1A 1CO

Wire-end ferrules must be used when connecting finely stranded wire.

Ordering data

without remote signalling contact
 with remote signalling contact (R)

Type	Qty.	Order No.
VPU PV II 3 600	1	2857060000
VPU PV II 3 R 600	1	2857070000

Type	Qty.	Order No.
VPU PV II 3 1000	1	2530550000
VPU PV II 3 R 1000	1	2530180000

Note

Accessories

Note

Pluggable spare arrester: VPU PV II 0 600 - 2857080000

Pluggable spare arrester L-N: VPU PV II 0 1000 - 2530660000





Type II

- Pluggable arrester
- Suitable for protecting DC systems as Type II arrester
- Encapsulated, non-blow-out arrester
- Tested in accordance with EN 50539-11
- Pluggable arresters
- Suitable for use in accordance with IEC 60364-7-712 / EN 50539-12

VPU PV II 3 (R) 1500

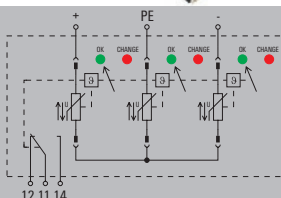

VPU PV II 5 (R) 1000

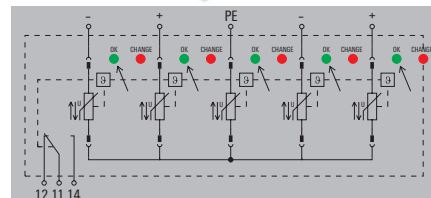

Technical data

PV system voltage, max. U_{spv}
 Discharge current I_{max} (8/20µs) wire-PE
 Discharge current I_n (8/20 µs)
 Total discharge current I_{total} (8/20µs)
 Protection level U_p (+/-, -/PE, +/-PE)
 Rated voltage (DC)
 Leakage current at U_n
 Response time
 Operating height in the grounded PV system
 Operating height in ungrounded PV system
 Short-circuit current I_{scpv}
 Optical function display
 Design
 Ambient temperature (operational)

Connection data

Solid
 Stranded
 Stripping length
 Tightening torque

Approvals

Approvals
 Standards

UL values

Rated Voltage U_n
 VPR (DC-/G)
 VPR (DC+/DC-)
 SCCR
 I_n
 Category

1500 V
 30 kA
 20 kA
 40 kA
 $\leq 5,0$ kV
 1500 V
 30 µA
 ≤ 25 ns
 ≤ 2000 m
 ≤ 4000 m
 11000 A
 green = OK; red = arrester is defective - replace
 Installation housing; 3TE, Insta IP 20
 -40 °C...85 °C

1.5...6 mm²
 1.5...35 mm²
 18 mm
 3...4.5 Nm

CE; cURus; VDE
 EN 61643-31, EN 50539-11, UL 1449

1500 V
 4000 V
 4000 V
 65 kA
 20 kA
 SPD TYPE 1CA

1100 V
 40 kA
 20 kA
 40 kA
 $\leq 4,2$ kV
 1000 V
 30 µA
 ≤ 25 ns
 ≤ 2000 m
 ≤ 2000 m
 11000 A
 green = OK; red = arrester is defective - replace
 Installation housing, 5 TE, Insta IP 20
 -40 °C...85 °C

1.5...6 mm²
 1.5...35 mm²
 18 mm
 3...4.5 Nm

CE
 IEC 61643-31, EN 61643-31

1100 V
 40 kA
 20 kA
 40 kA
 $\leq 4,2$ kV
 1000 V
 30 µA
 ≤ 25 ns
 ≤ 2000 m
 ≤ 2000 m
 11000 A
 green = OK; red = arrester is defective - replace
 Installation housing, 5 TE, Insta IP 20
 -40 °C...85 °C

Dimensions / Remote signalling contact info

Clamping range (nominal / min. / max.) mm²
 Height x width x depth mm
 Signalling contact

Note

no remote sig. contact	with remote signalling (R)
6 / 1.5 / 35	6 / 1.5 / 35
96 / 54 / 70	102 / 54 / 70
No	250 V 1A 1CO

Wire-end ferrules must be used when connecting finely stranded wire.

no remote sig. contact	with remote signalling (R)
6 / 1.5 / 35	6 / 1.5 / 35
96 / 90 / 60	105 / 90 / 60
No	250 V 1A 1CO

Wire-end ferrules must be used when connecting finely stranded wire.

Ordering data

without remote signalling contact
 with remote signalling contact (R)

Note

Type	Qty.	Order No.
VPU PV II 3 1500	1	2530640000
VPU PV II 3 R 1500	1	2530650000

Type	Qty.	Order No.
VPU PV II 5 1000	1	2856500000
VPU PV II 5 R 1000	1	2857020000

Accessories

Note

Pluggable spare arrester L-N: VPU PV II 0 1500 - 2530630000

Pluggable spare arrester: VPU PV II 5 0 1000 - 2857010000

Type I+II - PCB adapter

- Suitable for VPU PV type I and II
- Solderable in PCB
- With coding element

VPCB PV I+II (R) 600 E

VPCB PV I+II (R) 1000 E

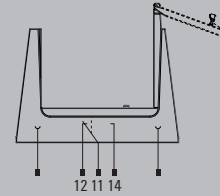
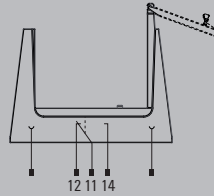

Technical data

Type of connection
 Short-circuit current I_{SCP}
 PV system voltage, max. U_{SPV}
 Lightning test current I_{imp} (10/350 μ s) (L-PE)
 Discharge current I_{max} (8/20 μ s) wire-PE
 Discharge current I_n (8/20 μ s)
 Operating height in the grounded PV system
 Design
 Colour
 Ambient temperature (operational)
 Storage temperature
 Conditions and requirements

Solder connection, when screwed in
 11 kA
 750 V
 6.25 kA
 40 kA
 20 kA
 ≤ 4000 m
 miscellaneous
 grey
 -40 °C...85 °C
 -40 °C...85 °C
 EN 50539-11

Solder connection, when screwed in
 11 kA
 1500 V
 6.25 kA
 40 kA
 20 kA
 ≤ 4000 m
 miscellaneous
 grey
 -40 °C...85 °C
 -40 °C...85 °C
 EN 50539-11

Dimensions / Remote signalling contact info

Height x width x depth mm

with remote signalling (R)

61.5 / 17.9 / 52.2

no remote sig. contact

61.6 / 17.9 / 52.2

with remote signalling (R)

61.6 / 17.9 / 52.2

Note

Ordering data

without remote signalling contact
 with remote signalling contact (R)

Type	Qty.	Order No.
VPCB PV I+II R 600 E	1	2857100000

Type	Qty.	Order No.
VPCB PV I+II 1000 E	20	2665700000
VPCB PV I+II R 1000 E	20	2665730000

Note

Accessories

Note

Pluggable spare arrester: VPU PV I+II 0 600 E - 2857050000

Pluggable spare arrester: VPU PV I+II 0 1000 E - 2530530000

Type I+II - PCB adapter

- Suitable for VPU PV type I and II
- Solderable in PCB
- With coding element

VPCB PV I+II (R) 1000

VPCB PV I+II (R) M 1000

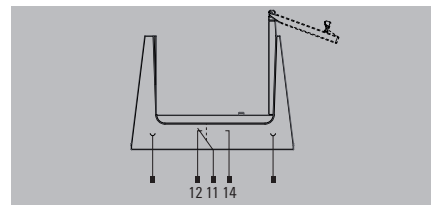
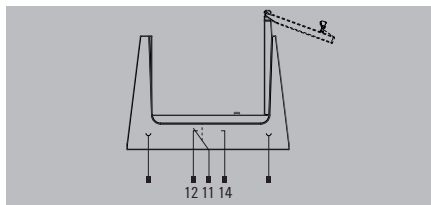

Technical data

Type of connection
 Short-circuit current I_{SCP}
 PV system voltage, max. U_{SPV}
 Lightning test current I_{imp} (10/350 μ s) (L-PE)
 Discharge current I_{max} (8/20 μ s) wire-PE
 Discharge current I_n (8/20 μ s)
 Operating height in the grounded PV system
 Design
 Colour
 Ambient temperature (operational)
 Storage temperature
 Conditions and requirements

Solder connection, when screwed in
 11 kA
 1500 V
 6.25 kA
 40 kA
 20 kA
 \leq 4000 m
 miscellaneous
 grey
 -40 °C...85 °C
 -40 °C...85 °C
 EN 50539-11

Solder connection, when screwed in
 11 kA
 1500 V
 6.25 kA
 40 kA
 20 kA
 \leq 4000 m
 miscellaneous
 grey
 -40 °C...85 °C
 -40 °C...85 °C
 EN 50539-11

Dimensions / Remote signalling contact info	
Height x width x depth	mm

no remote sig. contact	with remote signalling (R)
61.6 / 17.9 / 52.2	61.6 / 17.9 / 52.2

no remote sig. contact	with remote signalling (R)
61.6 / 17.9 / 52.2	61.6 / 17.9 / 52.2

Note

Ordering data

without remote signalling contact
with remote signalling contact (R)

Type	Qty.	Order No.
VPCB PV I+II 1000	20	2665740000
VPCB PV I+II R 1000	20	2665760000

Type	Qty.	Order No.
VPCB PV I+II M 1000	20	2665750000
VPCB PV I+II R M 1000	20	2665770000

Note

Accessories

Note

Pluggable spare arrester: VPU PV I+II 0 1000 - 2530600000

Pluggable spare arrester: VPU PV I+II 0M 1000 - 2534300000

Type I+II - PCB adapter

- Suitable for VPU PV type I and II
- Solderable in PCB
- With coding element

VPCB PV I+II 5 (R) M 1000

VPCB PV II (R) 600

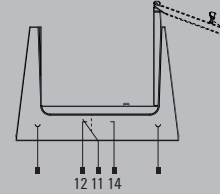
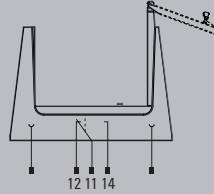

Technical data

Type of connection
 Short-circuit current I_{SCP}
 PV system voltage, max. U_{SPV}
 Lightning test current I_{imp} (10/350 μ s) (L-PE)
 Discharge current I_{max} (8/20 μ s) wire-PE
 Discharge current I_n (8/20 μ s)
 Operating height in the grounded PV system
 Design
 Colour
 Ambient temperature (operational)
 Storage temperature
 Conditions and requirements

Solder connection, when screwed in
 11 kA
 750 V
 6.25 kA
 40 kA
 20 kA
 ≤ 4000 m
 miscellaneous
 grey
 -40 °C...85 °C
 -40 °C...85 °C
 EN 50539-11

Solder connection, when screwed in
 11 kA
 750 V
 40 kA
 20 kA
 ≤ 4000 m
 miscellaneous
 grey
 -40 °C...85 °C
 -40 °C...85 °C
 EN 50539-11

Dimensions / Remote signalling contact info

Height x width x depth mm

with remote signalling (R)

61.5 / 17.9 / 52.2

with remote signalling (R)

61.5 / 17.9 / 52.2

Note

Ordering data

without remote signalling contact
 with remote signalling contact (R)

Type	Qty.	Order No.
VPCB PV I+II 5 R M 1000	1	2874710000

Type	Qty.	Order No.
VPCB PV II R 600	20	2857090000

Note

Accessories

Note

Pluggable spare arrester: VPU PV I+II 5 0M 1000 - 2856650000, VPU PV I+II 5 0 1000 - 2857000000

Pluggable spare arrester: VPU PV II 0 600 - 2857080000

Type I+II - PCB adapter

- Suitable for VPU PV type I and II
- Solderable in PCB
- With coding element

VPCB PV II (R) 1000

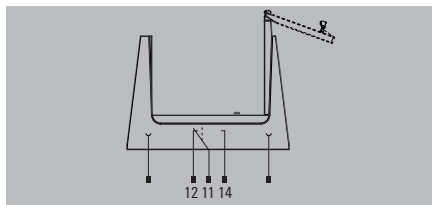
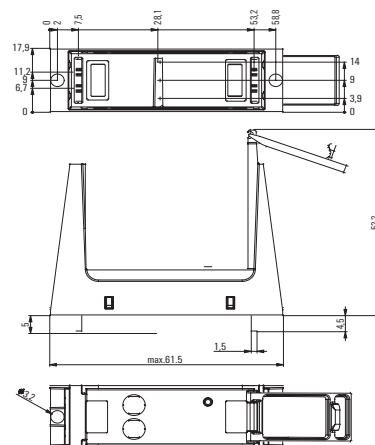

Technical data

Type of connection
 Short-circuit current I_{SCP}
 PV system voltage, max. U_{CPV}
 Lightning test current I_{imp} (10/350 μ s) (L-PE)
 Discharge current I_{max} (8/20 μ s) wire-PE
 Discharge current I_n (8/20 μ s)
 Operating height in the grounded PV system
 Design
 Colour
 Ambient temperature (operational)
 Storage temperature
 Conditions and requirements

Solder connection, when screwed in
 11 kA
 1500 V

 40 kA
 20 kA
 \leq 4000 m
 miscellaneous
 grey
 -40 °C...85 °C
 -40 °C...85 °C
 EN 50539-11

Dimensions / Remote signalling contact info	
Height x width x depth	mm

no remote sig. contact	with remote signalling (R)
61.6 / 17.9 / 52.2	61.6 / 17.9 / 52.2

Note

Ordering data

without remote signalling contact
with remote signalling contact (R)

Type	Qty.	Order No.
VPCB PV II 1000	20	2665680000
VPCB PV II R 1000	20	2665690000

Note

Accessories

Note

Pluggable spare arrester: VPU PV II 0 1000 - 2530660000



Protects PV systems optimally from overvoltages

Ready to connect all-in-one solution for your photovoltaic system

PV systems are directly affected by environmental influences because they are installed in exposed locations. This also increases the risk of lightning strikes. According to EN 51643-32, PV systems must be protected against overvoltages to avoid high repair costs and loss of revenue due to system failure.

PV Protect is the solution for optimum protection of the inverter against overvoltages. The ready-to-connect boxes are available for different system voltages and can be supplied with various arrester types and MPP trackers. Depending on requirements, connection is made via cable glands or WM4C connectors with convenient and reliable PUSH IN connection technology.

Your special advantages:

- Compact, space-saving design
- Reliable and maintenance-free PUSH IN connection technology
- Available in product variants suitable for different applications
- Ready to connect solution in protection class IP67





Mount the box, connect the cable, ready

Thanks to the pre-assembled arresters, the product can be connected quickly and with little effort. The protection of the PV system is ensured immediately. The clear marking of the ports eliminates the possibility of incorrect wiring.



Wide range of product variants

PV Protect is available with different arrester classes (Type I/II and Type II) and rated voltages (1,000 V/ 1,500 V). The connection is made either via photovoltaic plug connectors or cable glands – for high flexibility.

Designed to meet various requirements

PV Protect is compact, robust, and extremely weatherproof. The housing complies with protection class IP67 and protects the sensitive electronics inside, even from harsh environmental influences.

Type I/II - PV Protect Box

- Tested in accordance with EN 50539-11
- Suitable for use in accordance with IEC 60364-7-712/ EN 50539-12
- Use if the separation distance cannot be observed

VPU PV BOX CG I+II 3 1000 1M

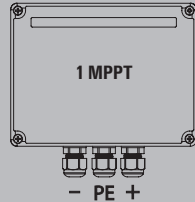

VPU PV BOX CG I+II 5 1000 2M

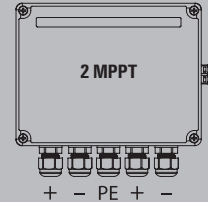

Technical data

	VPU PV BOX CG I+II 3 1000 1M	VPU PV BOX CG I+II 5 1000 2M
Requirements class	Type I/II	Type I/II
PV system voltage, max. U_{spv}	1100 V	1100 V
Lightning test current I_{imp} (10/350 μ s)	6.25 kA	6.25 kA
Discharge current I_{max} (8/20 μ s) wire-PE	40 kA	40 kA
Discharge current I_n (8/20 μ s)	20 kA	20 kA
Rated voltage (DC)	1000 V	1000 V
Leakage current at U_n	50 μ A	50 μ A
Response time	≤ 25 ns	≤ 25 ns
Operating height in the grounded PV system	≤ 4000 m	≤ 4000 m
Operating height in ungrounded PV system	≤ 4000 m	≤ 4000 m
Short-circuit current I_{scpv}	11 kA	11 kA
Optical function display	green = OK; red = arrester is defective - replace	green = OK; red = arrester is defective - replace
Protection degree	IP67	IP67
Colour	white	white
Ambient temperature (operational)	-40 °C...85 °C	-40 °C...85 °C
Storage temperature	-40 °C...85 °C	-40 °C...85 °C
Connection data		
Solid	2.5...6 mm ²	2.5...6 mm ²
Stranded	2.5...6 mm ²	2.5...6 mm ²
Stripping length	16 mm	16 mm
Tightening torque	2...4.5 Nm	2...4.5 Nm
Technical data - photovoltaic		
Protection level U_p (+/-, -/PE, +/-PE)	$\leq 4,2$ kV	$\leq 4,2$ kV
Short-circuit current I_{scpv}	11 kA	11 kA
Approvals		
Approvals	CE	CE
Standards	EN 50539-11	EN 50539-11

Dimensions / Remote signalling contact info	
Clamping range (nominal / min. / max.)	mm ²
Height x width x depth	mm
Signalling contact	
Note	

no remote sig. contact	
6 / 2.5 / 16	
145 / 168 / 91	
No	

no remote sig. contact	
6 / 2.5 / 16	
145 / 168 / 91	
No	

Ordering data

	Type	Qty.	Order No.
without remote signalling contact	VPUM111SXFV100TXPX10	1	2755970000
	VPUM2I2SXFV100TXPX10	1	2755980000

Note

Accessories

Note	Cable: 2814220000, 2814280000, 2814290000	Cable: 2814220000, 2814280000, 2814290000
-------------	-------------------------------------------	-------------------------------------------



Type I/II - PV Protect Box

- Tested in accordance with EN 50539-11
- Suitable for use in accordance with IEC 60364-7-712/ EN 50539-12
- Use if the separation distance cannot be observed

VPU PV BOX WM4 I+II 3 1000 1M

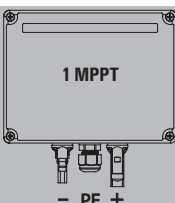

VPU PV BOX WM4 I+II 5 1000 2M

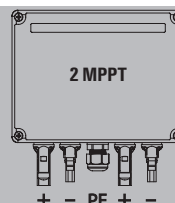

Technical data

Requirements class
PV system voltage, max. U_{SPV}
Lightning test current I_{imp} (10/350 μ s)
Discharge current I_{max} (8/20 μ s) wire-PE
Discharge current I_n (8/20 μ s)
Rated voltage (DC)
Leakage current at U_n
Response time
Operating height in the grounded PV system
Operating height in ungrounded PV system
Short-circuit current I_{SCPV}
Optical function display
Protection degree
Colour
Ambient temperature (operational)
Storage temperature
Connection data
Solid
Stranded
Stripping length
Tightening torque
Technical data - photovoltaic
Protection level U_p (+/-, -/PE, +/-PE)
Short-circuit current I_{SCPV}
Approvals
Approvals
Standards

Type I/II
1100 V
6.25 kA
40 kA
20 kA
1000 V
50 μ A
≤ 25 ns
≤ 4000 m
≤ 4000 m
11 kA
green = OK; red = arrester is defective - replace
IP67
white
-40 °C...85 °C
-40 °C...85 °C
2.5...6 mm ²
2.5...6 mm ²
16 mm
2...4.5 Nm
$\leq 4,2$ kV
11 kA
CE
EN 50539-11

Type I/II
1100 V
6.25 kA
40 kA
20 kA
1000 V
50 μ A
≤ 25 ns
≤ 4000 m
≤ 4000 m
11 kA
green = OK; red = arrester is defective - replace
IP67
white
-40 °C...85 °C
-40 °C...85 °C
2.5...6 mm ²
2.5...6 mm ²
16 mm
2...4.5 Nm
$\leq 4,2$ kV
11 kA
CE
EN 50539-11

Dimensions / Remote signalling contact info
Clamping range (nominal / min. / max.)
Height x width x depth
Signalling contact
Note

no remote sig. contact
6 / 2.5 / 16
160 / 168 / 91
No

no remote sig. contact
6 / 2.5 / 16
160 / 168 / 91
No

Ordering data

without remote signalling contact

Type	Qty.	Order No.
VPUM111SXFV101TXPX10	1	2764140000

Type	Qty.	Order No.
VPUM2I2SXFV101TXPX10	1	2764150000

Note

Accessories

Note

Cable: 2814220000, 2814280000, 2814290000

Cable: 2814220000, 2814280000, 2814290000

Type I/II - PV Protect Box

- Tested in accordance with EN 50539-11
- Suitable for use in accordance with IEC 60364-7-712/ EN 50539-12
- Use if the separation distance cannot be observed

VPU PV BOX CG II 3 1000 1M

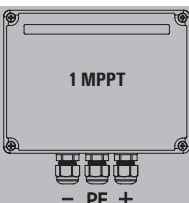

VPU PV BOX CG II 5 1000 2M

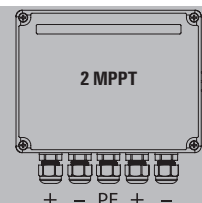

Technical data

Requirements class
 PV system voltage, max. U_{spv}
 Lightning test current I_{imp} (10/350 μ s)
 Discharge current I_{max} (8/20 μ s) wire-PE
 Discharge current I_n (8/20 μ s)
 Rated voltage (DC)
 Leakage current at U_n
 Response time
 Operating height in the grounded PV system
 Operating height in ungrounded PV system
 Short-circuit current I_{scpv}
 Optical function display
 Protection degree
 Colour
 Ambient temperature (operational)
 Storage temperature

Type II
 1100 V

 40 kA
 20 kA
 1000 V
 50 μ A
 ≤ 25 ns
 ≤ 4000 m
 ≤ 4000 m
 11 kA
 green = OK; red = arrester is defective - replace
 IP67
 Light Grey, white
 -40 °C...85 °C
 -40 °C...85 °C

Type II
 1100 V

 40 kA
 20 kA
 1000 V
 50 μ A
 ≤ 25 ns
 ≤ 4000 m
 ≤ 4000 m
 11 kA
 green = OK; red = arrester is defective - replace
 IP67
 Light Grey, white
 -40 °C...85 °C
 -40 °C...85 °C

Connection data

Solid
 Stranded
 Stripping length
 Tightening torque

2.5...6 mm²
 2.5...6 mm²
 16 mm
 2...4.5 Nm

2.5...6 mm²
 2.5...6 mm²
 16 mm
 2...4.5 Nm

Technical data - photovoltaic

Protection level U_p (+/-, -/PE, +/-PE)
 Short-circuit current I_{scpv}

$\leq 4,2$ kV
 11 kA

$\leq 4,2$ kV
 11 kA

Approvals

Approvals
 Standards

CE
 EN 50539-11

CE
 EN 50539-11

Dimensions / Remote signalling contact info

Clamping range (nominal / min. / max.) mm²
 Height x width x depth mm
 Signalling contact

no remote sig. contact

6 / 2.5 / 16
 145 / 168 / 91
 No

no remote sig. contact

6 / 2.5 / 16
 145 / 168 / 91
 No

Note

Ordering data

without remote signalling contact

Type	Qty.	Order No.
VPUM111SXFV200TXPX10	1	2755950000

Type	Qty.	Order No.
VPUM2I2SXFV200TXPX10	1	2755960000

Note

Accessories

Note

Cable: 2814220000, 2814280000, 2814290000

Cable: 2814220000, 2814280000, 2814290000



Type I/II - PV Protect Box

- Tested in accordance with EN 50539-11
- Suitable for use in accordance with IEC 60364-7-712/ EN 50539-12
- Use if the separation distance cannot be observed

VPU PV BOX CG II 3 1500 1M

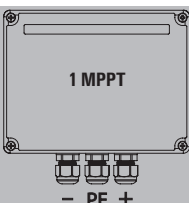

VPU PV BOX CG II 5 1500 2M

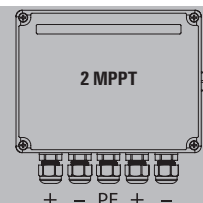

Technical data

Requirements class
 PV system voltage, max. U_{spv}
 Lightning test current I_{imp} (10/350 μ s)
 Discharge current I_{max} (8/20 μ s) wire-PE
 Discharge current I_n (8/20 μ s)
 Rated voltage (DC)
 Leakage current at U_n
 Response time
 Operating height in the grounded PV system
 Operating height in ungrounded PV system
 Short-circuit current I_{scpv}
 Optical function display
 Protection degree
 Colour
 Ambient temperature (operational)
 Storage temperature

Connection data

Solid
 Stranded
 Stripping length
 Tightening torque

Technical data - photovoltaic

Protection level U_p (+/-, -/PE, +/-PE)
 Short-circuit current I_{scpv}

Approvals

Approvals
 Standards

Type II
 1500 V

 40 kA
 15 kA
 1500 V
 50 μ A
 ≤ 25 ns
 ≤ 4000 m
 ≤ 4000 m
 11 kA
 green = OK; red = arrester is defective - replace
 IP67
 Light Grey, white
 -40 °C...85 °C
 -40 °C...85 °C

2.5...6 mm²
 2.5...6 mm²
 16 mm
 2...4.5 Nm

≤ 4.8 kV
 11 kA

CE
 EN 50539-11

Type II
 1500 V

 40 kA
 15 kA
 1500 V
 50 μ A
 ≤ 25 ns
 ≤ 4000 m
 ≤ 4000 m
 11 kA
 green = OK; red = arrester is defective - replace
 IP67
 Light Grey, white
 -40 °C...85 °C
 -40 °C...85 °C

2.5...6 mm²
 2.5...16 mm²
 16 mm
 2...4.5 Nm

≤ 4.8 kV
 11 kA

CE
 EN 50539-11

Dimensions / Remote signalling contact info

Clamping range (nominal / min. / max.) mm²
 Height x width x depth mm
 Signalling contact

Note

no remote sig. contact

6 / 2.5 / 16
 145 / 168 / 91
 No

no remote sig. contact

6 / 2.5 / 16
 145 / 168 / 91
 No

Ordering data

without remote signalling contact

Type	Qty.	Order No.
VPUM111SXFV200TXPX15	1	2755990000

Type	Qty.	Order No.
VPUM2I2SXFV200TXPX15	1	2756000000

Note

Accessories

Note

Cable: 2814220000, 2814280000, 2814290000

Cable: 2814220000, 2814280000, 2814290000



Type I/II - PV Protect Box

- Tested in accordance with EN 50539-11
- Suitable for use in accordance with IEC 60364-7-712/ EN 50539-12
- Use if the separation distance cannot be observed

VPU PV BOX WM4 II 3 1000 1M

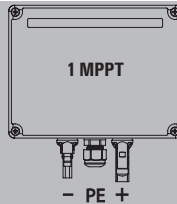

VPU PV BOX WM4 II 5 1000 2M

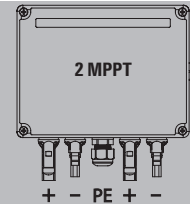

Technical data

Requirements class
 PV system voltage, max. U_{spv}
 Lightning test current I_{imp} (10/350 μ s)
 Discharge current I_{max} (8/20 μ s) wire-PE
 Discharge current I_n (8/20 μ s)
 Rated voltage (DC)
 Leakage current at U_n
 Response time
 Operating height in the grounded PV system
 Operating height in ungrounded PV system
 Short-circuit current I_{scpv}
 Optical function display
 Protection degree
 Colour
 Ambient temperature (operational)
 Storage temperature

Connection data

Solid
 Stranded
 Stripping length
 Tightening torque

Technical data - photovoltaic

Protection level U_p (+/-, -/PE, +/-PE)
 Short-circuit current I_{scpv}

Approvals

Approvals
 Standards

Type II
 1100 V

 40 kA
 20 kA
 1000 V
 50 μ A
 ≤ 25 ns
 ≤ 4000 m
 ≤ 4000 m
 11 kA
 green = OK; red = arrester is defective - replace
 IP67
 white
 -40 °C...85 °C
 -40 °C...85 °C

2.5...6 mm²
 2.5...6 mm²
 16 mm
 2...4.5 Nm

$\leq 4,2$ kV
 11 kA

CE
 EN 50539-11

Type II
 1100 V

 40 kA
 20 kA
 1000 V
 50 μ A
 ≤ 25 ns
 ≤ 4000 m
 ≤ 4000 m
 11 kA
 green = OK; red = arrester is defective - replace
 IP67
 white
 -40 °C...85 °C
 -40 °C...85 °C

2.5...6 mm²
 2.5...6 mm²
 16 mm
 2...4.5 Nm

$\leq 4,2$ kV
 11 kA

CE
 EN 50539-11

Dimensions / Remote signalling contact info

Clamping range (nominal / min. / max.) mm²
 Height x width x depth mm
 Signalling contact

Note

no remote sig. contact

6 / 2.5 / 16
 160 / 168 / 91
 No

no remote sig. contact

6 / 2.5 / 16
 160 / 168 / 91
 No

Ordering data

without remote signalling contact

Type	Qty.	Order No.
VPUM111SXFV201TXPX10	1	2764110000

Type	Qty.	Order No.
VPUM2I2SXFV201TXPX10	1	2764130000

Note

Accessories

Note

Cable: 2814220000, 2814280000, 2814290000

Cable: 2814220000, 2814280000, 2814290000



Type I/II - PV Protect Box

- Tested in accordance with EN 50539-11
- Suitable for use in accordance with IEC 60364-7-712/ EN 50539-12
- Use if the separation distance cannot be observed

VPU PV BOX WM4 II 3 1500 1M

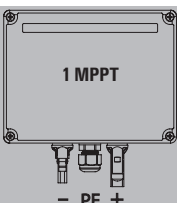

VPU PV BOX WM4 II 5 1500 2M

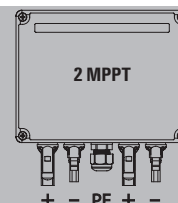

Technical data

Requirements class
 PV system voltage, max. U_{spv}
 Lightning test current I_{imp} (10/350 μ s)
 Discharge current I_{max} (8/20 μ s) wire-PE
 Discharge current I_n (8/20 μ s)
 Rated voltage (DC)
 Leakage current at U_n
 Response time
 Operating height in the grounded PV system
 Operating height in ungrounded PV system
 Short-circuit current I_{scpv}
 Optical function display
 Protection degree
 Colour
 Ambient temperature (operational)
 Storage temperature

Connection data

Solid
 Stranded
 Stripping length
 Tightening torque

Technical data - photovoltaic

Protection level U_p (+/-, -/PE, +/-PE)
 Short-circuit current I_{scpv}

Approvals

Approvals
 Standards

Type II
 1500 V

 40 kA
 15 kA
 1500 V
 50 μ A
 ≤ 25 ns
 ≤ 4000 m
 ≤ 4000 m
 11 kA
 green = OK; red = arrester is defective - replace
 IP67
 white
 -40 °C...85 °C
 -40 °C...85 °C

2.5...6 mm²
 2.5...6 mm²
 16 mm
 2...4.5 Nm

≤ 4.8 kV
 11 kA

CE
 EN 50539-11

Type II
 1500 V

 40 kA
 15 kA
 1500 V
 50 μ A
 ≤ 25 ns
 ≤ 4000 m
 ≤ 4000 m
 11 kA
 green = OK; red = arrester is defective - replace
 IP67
 grey, white
 -40 °C...85 °C
 -40 °C...85 °C

2.5...6 mm²
 2.5...6 mm²
 16 mm
 2...4.5 Nm

≤ 4.8 kV
 11 kA

CE
 EN 50539-11

Dimensions / Remote signalling contact info

Clamping range (nominal / min. / max.) mm²
 Height x width x depth mm
 Signalling contact

Note

no remote sig. contact

6 / 2.5 / 16
 160 / 168 / 91
 No

no remote sig. contact

6 / 2.5 / 16
 160 / 168 / 91
 No

Ordering data

without remote signalling contact

Type	Qty.	Order No.
VPUM111SXFV201TXPX15	1	2764160000

Type	Qty.	Order No.
VPUM2I2SXFV201TXPX15	1	2764180000

Note

Accessories

Note

Cable: 2814220000, 2814280000, 2814290000

Cable: 2814220000, 2814280000, 2814290000



B



Lightning and surge protection for instrumentation and control (I & C)

Lightning and surge protection for control and instrumentation signals	Quick selection guide	C.2	
	SIL certification	C.5	
	Lightning and surge protection for control and instrumentation signals	C.6	
	VARITECTOR SPC	C.8	
	VARITECTOR SSC 6AN	C.58	
	VARITECTOR SSC 4AN	C.88	
	MCZ OVP series	C.102	
	Earthing for shielded cables	C.114	
	Installation advice for instrumentation and control engineering	C.118	
	Ex zone	VARITECTOR SPC EX	C.126
		VARITECTOR SSC EX	C.146
		VARITECTOR Cable Gland (VCG)	C.162
		ATEX and IEC Ex approvals	C.164



Product quick selection for measurement and control signals

Instrumentation and control equipment

Interface/ signal	Mounting	Connection system	Protected wires	Discharge capacity	Nominal current	max. voltage	Protection device	Order No. Arrestor	Order No. Direct earthing base	Order No. Indirect earthing base
O(4) ... 20 mA	on DIN rail, separable	Screw terminals	4	5 kA	0.45 A	28 V	VSPC 2CL 24 V DC 0.5 A	8924470000	8924710000	8924270000
O(4) ... 20 mA	on DIN rail, separable	Screw terminals	2	5 kA	0.45 A	28 V	VSPC 1CL 24 V DC 0.5 A	8924480000	8924730000	8924290000
O...10 V	on DIN rail, separable	Screw terminals	4	5 kA	0.45 A	28 V	VSPC 2CL 24 V DC 0.5 A	8924470000	8924710000	8924270000
O...10 V	on DIN rail, separable	Screw terminals	2	5 kA	0.45 A	28 V	VSPC 1CL 24 V DC 0.5 A	8924480000	8924730000	8924290000
0-20 mA, 4-20 mA	on DIN rail, compact	Screw terminals	2	5 kA	0.5 A	42 V	VSSC4 CL 24VAC/DC 0.5A		1063730000	
Hart	on DIN rail, separable	Screw terminals	2	5 kA	0.45 A	28 V	VSPC 1CL 24 V DC 0.5 A	8924480000	8924730000	8924290000
Cathodic corrosion protection	on DIN rail, separable	Screw terminals	2	5 kA	2 A	72 V	VSPC GDT 2 CH 90 V 20 kA	8924570000	8924740000	8924300000
PT 100/RTD, PT 1000	on DIN rail, compact	Screw terminals	3	5 kA	0.5 A	1 V	VSSC RTD	1139710000		
RS232	on DIN rail, compact	Screw terminals	2	10 kA	0.5 A	42 V	VSSC4 SL 24VAC/DC 0.5A	1063840000		
RS422,V11	on DIN rail, compact	Screw terminals	2	10 kA	0.5 A	42 V	VSSC4 SL 24VAC/DC 0.5A	1063840000		
RS422A, V.11, X.27, RS423A	on DIN rail, separable	Screw terminals	4	5 kA	0.45 A	15 V	VSPC 2CL HF 12 V DC	8924460000	8924710000	8924270000
RS449	on DIN rail, separable	Screw terminals	4	5 kA	0.45 A	15 V	VSPC 2CL HF 12 V DC	8924460000	8924710000	8924270000
RS485	on DIN rail, compact	Screw terminals	2	10 kA	0.5 A	12 V	VSSC6 RS485	1064980000		
RS485	on DIN rail, separable	Screw terminals	4	5 kA	0.45 A	6.4 V	VSPC R485 2 CH	8924670000	8924710000	8924270000
RS232-C / V.24	on DIN rail, separable	Screw terminals	4	5 kA	0.45 A	15 V	VSPC 2CL HF 12 V DC	8924460000	8924710000	8924270000
TTL	on DIN rail, compact	Screw terminals	2	10 kA	0.5 A	34 V	VSSC4 SL 24VAC/DC 0.5A	1063840000		
TTY	on DIN rail, compact	Screw terminals	2	10 kA	0.5 A	34 V	VSSC4 SL 24VAC/DC 0.5A	1063840000		

Bus systems

Interface/ signal	Mounting	Connection system	Protected wires	Discharge capacity	Nominal current	max. voltage	Protection device	Order No. Arrestor	Order No. Direct earthing base	Order No. Indirect earthing base
ASI	on DIN rail, separable	Screw terminals	4	5 kA	0.45 A	15 V	VSPC 2CL HF 12 V DC	8924460000	8924710000	8924270000
BITBUS	on DIN rail, separable	Screw terminals	4	5 kA	0.45 A	15 V	VSPC 2CL HF 12 V DC	8924460000	8924710000	8924270000
BLN (Building Level Network)	on DIN rail, separable	Screw terminals	2	5 kA	0.45 A	28 V	VSPC 1CL 24 V DC 0,5 A	8924480000	8924730000	8924290000
BLN (Building Level Network)	on DIN rail, separable	Screw terminals	4	5 kA	0.45 A	28 V	VSPC 2CL HF 12 V DC	8924460000	8924710000	8924270000
CAN-Bus	on DIN rail, separable	Screw terminals	4	5 kA	0.45 A	15 V	VSPC 2CL HF 12 V DC	8924460000	8924710000	8924270000
CANopen	on DIN rail, compact	Tension clamp terminals	2	5 kA	0.3 A	12 V	MCZ OVP HF 12 V 0,3 A	8948610000		
C-BUS	on DIN rail, separable	Screw terminals	4	5 kA	0.45 A	15 V	VSPC 2CL HF 12 V DC	8924460000	8924710000	8924270000
C-Bus (Honeywell)	on DIN rail, compact	Tension clamp terminals	2	5 kA	0.3 A	5 V	MCZ OVP HF 5 V 0,3 A	8948620000		
CC-LINK	on DIN rail, separable	Screw terminals	4	5 kA	0.45 A	15 V	VSPC 2CL HF 12 V DC	8924460000	8924710000	8924270000
Data Highway (Plus), DH+	on DIN rail, separable	Screw terminals	4	5 kA	0.45 A	15 V	VSPC 2CL HF 12 V DC	8924460000	8924710000	8924270000
DATEx P	on DIN rail, compact	Tension clamp terminals	2	5 kA	0.3 A	24 V	MCZ OVP HF 24 V 0,3 A	8948600000		
Device Net	on DIN rail, compact	Tension clamp terminals	2	5 kA	0.3 A	12 V	MCZ OVP HF 12 V 0,3 A	8948610000		
DeviceNet	on DIN rail, separable	Screw terminals	4	5 kA	0.45 A	15 V	VSPC 2CL HF 12 V DC	8924460000	8924710000	8924270000
DIN Messbus	on DIN rail, separable	Screw terminals	2	5 kA	0.45 A	15 V	VSPC 1CL 12 V DC 0,5 A	8924450000	8924730000	8924290000
Dupline / Miniplex	on DIN rail, separable	Screw terminals	2	5 kA	0.45 A	28 V	VSPC 1CL 24 V DC 0,5 A	8924480000	8924730000	8924290000





Bus systems

Interface/ signal	Mounting	Connection system	Protected wires	Discharge	Nominal	max.	Protection device	Order No. Arrestor	Order No. Direct earthing base	Order No. Indirect earthing base
				capacity	current	voltage				
				8/20 μ s	I_n	DC				
BACnet (PTP)	on DIN rail, compact	Screw terminals		10 kA	0.5 A	12 V	VSSC 6 RS 232	1064990000		
BACnet (IP)	on DIN rail, compact	RJ 45 connection		10 kA	1 A	48 V	V DATA Cat 6	1348590000		
KNX	on DIN rail, compact	Screw terminals	4	10 kA	12 A	30 V	VSSC 6 GDT 24 V AC/DC	1064640000		
DALI	on DIN rail, compact	Screw terminals	2	5 kA	0.5 A	24 V	VSSC4 CL FG 24V AC/DC 0,5	1063770000		
E1	on DIN rail, separable	Screw terminals	4	5 kA	0.45 A	6.4 V	VSPC 2CL HF 5 V DC	8924430000	8924710000	8924270000
KNX	on DIN rail, separable	Screw terminals	2	5 kA	0.45 A	28 V	VSPC 1CL 24 V DC 0,5 A	8924480000	8924730000	8924290000
ET 200	on DIN rail, separable	Screw terminals	2	5 kA	0.45 A	28 V	VSPC 1CL 5 V DC 0,5 A	8924420000	8924730000	8924290000
ET 200	on DIN rail, compact	Tension clamp terminals	2	5 kA	0.3 A	5 V	MCZ OVP HF 5 V 0,3 A	8948620000		
Ethernet Cat.6	Plug-in adapter	RJ 45 connection	4	10 kA	1 A	48 V	V DATA Cat.6	1348590000		
Ethernet Cat 5e	on DIN rail, compact	RJ 45 connection		10 kA	1.5 kA	72 V	V DATA Cat 5e	2916360000		
FIPIO / FIPWAY	on DIN rail, separable	Screw terminals	4	5 kA	0.45 A	6.4 V	VSPC 2CL HF 5 V DC	8924430000	8924710000	8924270000
Genius I/O Bus	on DIN rail, separable	Screw terminals	4	5 kA	0.45 A	15 V	VSPC 2CL 12 V DC 0,5 A	8924440000	8924710000	8924270000
HDSL	on DIN rail, compact	Tension clamp terminals	2	5 kA	0.3 A	24 V	MCZ OVP HF 24 V 0,3 A	8948600000		
IEC-BUS	on DIN rail, separable	Screw terminals	4	5 kA	0.45 A	6.4 V	VSPC 2CL HF 5 V DC	8924430000	8924710000	8924270000
Interbus	on DIN rail, compact	Tension clamp terminals	2	5 kA	0.3 A	5 V	MCZ OVP HF 5 V 0,3 A	8948620000		
Interbus-Inline I/O	on DIN rail, compact	Screw terminals	2	10 kA	0.5 A	85 V	VSSC4 CL 48VAC/DC 0.5A	1063740000		
LON™ (Works)	on DIN rail, separable	Screw terminals	4	5 kA	0.45 A	85 V	VSPC 1CL 48 V AC 0,5 A	8924520000	8924730000	8924290000
LON™ TP/XF 78	on DIN rail, compact	Tension clamp terminals	2	10 kA	0.5 A	42 V	VSSC4 CL 24VAC/DC 0.5A	1063730000		
LON™-Bus	on DIN rail, compact	Tension clamp terminals	2	5 kA	0.3 A	12 V	MCZ OVP HF 12 V 0,3 A	8948610000		
LRE networks	on DIN rail, separable	Screw terminals	4	5 kA	0.45 A	6.4 V	VSPC 2CL HF 5 V DC	8924430000	8924710000	8924270000
LUXMATE-Bus	on DIN rail, separable	Screw terminals	4	5 kA	0.45 A	28 V	VSPC 2CL HF 24 V DC	8924510000	8924710000	8924270000
M-Bus	on DIN rail, compact	Tension clamp terminals	2	5 kA	0.3 A	24 V	MCZ OVP HF 24 V 0,3 A	8948600000		
M-Bus	on DIN rail, compact	Screw terminals	2	5 kA	0.5 A	48 V	VSSC 6 CL 48 V AC/DC 0,5	1064190000		
M-Bus	on DIN rail, compact	Screw terminals	2	5 kA	0.5 A	24 V	VSSC 4 CL FG 24 V AC/DC 0,5	1063770000		
M-Bus (remote reading of meter)	on DIN rail, separable	Screw terminals	2	5 kA	0.45 A	28 V	VSPC 1CL 48 V AC 0,5 A	8924520000	8924730000	8924290000
MOD-Bus	on DIN rail, compact	Tension clamp terminals	2	5 kA	0.3 A	5 V	MCZ OVP HF 5 V 0,3 A	8948620000		
MODBUS(-PLUS)	on DIN rail, separable	Screw terminals	4	5 kA	0.45 A	15 V	VSPC 2CL HF 12 V DC	8924460000	8924710000	8924270000
MPI Bus	on DIN rail, separable	Screw terminals	4	5 kA	0.45 A	6.4 V	VSPC R485 2 CH	8924670000	8924710000	8924270000
N1 LAN	on DIN rail, separable	Screw terminals	4	5 kA	0.45 A	6.4 V	VSPC 2CL HF 5 V DC	8924430000	8924710000	8924270000
N2 Bus	on DIN rail, separable	Screw terminals	2	5 kA	0.45 A	6.4 V	VSPC 2SL 5 V DC 0,5 A	8924210000	8924720000	8924280000
P-NET	on DIN rail, separable	Screw terminals	4	5 kA	0.45 A	15 V	VSPC 2CL HF 12 V DC	8924460000	8924710000	8924270000
Procontic CS31	on DIN rail, separable	Screw terminals	2	5 kA	0.45 A	15 V	VSPC 1CL 12 V DC 0,5 A	8924450000	8924730000	8924290000
Procontic CS31	on DIN rail, separable	Screw terminals	4	5 kA	0.45 A	15 V	VSPC 2CL HF 12 V DC	8924460000	8924710000	8924270000
Procontic T200	on DIN rail, separable	Screw terminals	4	5 kA	0.45 A	15 V	VSPC 2CL HF 12 V DC	8924460000	8924710000	8924270000
Profibus	on DIN rail, compact	Screw terminals	2	5 kA	0.3 A	5 V	VSSC 6 RS485 DP	1065010000		
(Profibus DP)	on DIN rail, separable	Screw terminals	4	5 kA	0.45 A	6.4 V	VSPC RS485 2 CH	8924670000	8924710000	8924270000
Profibus PA	on DIN rail, compact	Screw terminals	2	10 kA	0.5 A	85 V	VSSC4 CL 48VAC/DC 0.5A	1063740000		
Profinet	on DIN rail, compact	Tension clamp terminals	2	5 kA	0.3 A	5 V	MCZ OVP HF 5 V 0,3 A	8948620000		
Prozess Bus, Panel Bus	on DIN rail, separable	Screw terminals	4	5 kA	0.45 A	15 V	VSPC 2CL HF 12 V DC	8924460000	8924710000	8924270000
PSM-EG-RS422...	on DIN rail, separable	Screw terminals	4	5 kA	0.45 A	15 V	VSPC 2CL HF 12 V DC	8924460000	8924710000	8924270000
PSM-EG-RS485...	on DIN rail, separable	Screw terminals	4	5 kA	0.45 A	15 V	VSPC 2CL HF 12 V DC	8924460000	8924710000	8924270000
RACKBUS	on DIN rail, separable	Screw terminals	4	5 kA	0.45 A	6.4 V	VSPC 2CL HF 5 V DC	8924430000	8924710000	8924270000
SDLC	on DIN rail, separable	Screw terminals	4	5 kA	0.45 A	15 V	VSPC 2CL HF 12 V DC	8924460000	8924710000	8924270000
SDSL	on DIN rail, separable	Screw terminals	4	5 kA	0.45 A	185 V	VSPC Uko	8924660000	8924710000	8924270000
SecuriLan-LON™-Bus	on DIN rail, separable	Screw terminals	2	5 kA	0.45 A	15 V	VSPC 1CL 12 V DC 0,5 A	8924450000	8924730000	8924290000
SINEC L1	on DIN rail, separable	Screw terminals	4	5 kA	0.45 A	6.4 V	VSPC 2CL HF 5 V DC	8924430000	8924710000	8924270000
Sinec L2	on DIN rail, compact	Tension clamp terminals	2	5 kA	0.3 A	5 V	MCZ OVP HF 5 V 0,3 A	8948620000		
SINEC L2 DP	on DIN rail, separable	Screw terminals	4	5 kA	0.45 A	6.4 V	VSPC 2CL HF 5 V DC	8924430000	8924710000	8924270000
TCP / IP	on DIN rail, compact	Tension clamp terminals	2	5 kA	0.3 A	5 V	MCZ OVP HF 5 V 0,3 A	8948620000		
Token Ring	on DIN rail, compact	Tension clamp terminals	2	5 kA	0.3 A	5 V	MCZ OVP HF 5 V 0,3 A	8948620000		
TP/FTT 10+TP/LPT10	on DIN rail, compact	Screw terminals	2	10 kA	0.5 A	85 V	VSSC4 CL 48VAC/DC 0.5A	1063740000		
U-BUS	on DIN rail, separable	Screw terminals	4	5 kA	2 A	72 V	VSPC GDT 2 CH 90 V 20 kA	8924570000	8924740000	8924300000

Product quick selection, data interfaces

Telecommunications

Interface/ signal	Mounting	Connection system	Protected wires	Discharge	Nominal	max.	Protection device	Order No. Arrestor	Order No. Direct earthing base	Order No. Indirect earthing base
				capacity	current	voltage				
				8/20 μ s	I _n	DC				
ADSL	on DIN rail, separable	Screw terminals	4	5 kA	0.45 A	185 V	VSPC Uko	8924660000	8924710000	8924270000
ADVANT	on DIN rail, separable	Screw terminals	4	5 kA	0.45 A	6.4 V	VSPC 2CL HF 5 V DC	8924430000	8924710000	8924270000
HDSL	on DIN rail, separable	Screw terminals	4	5 kA	0.45 A	185 V	VSPC Uko	8924660000	8924710000	8924270000
SHDSL	on DIN rail, separable	Screw terminals	4	5 kA	0.45 A	185 V	VSPC Uko	8924660000	8924710000	8924270000
T-DSL	on DIN rail, separable	Screw terminals	4	5 kA	0.45 A	185 V	VSPC Uko	8924660000	8924710000	8924270000
Telephone analogue	on DIN rail, separable	Screw terminals	4	5 kA	0.45 A	185 V	VSPC Uko	8924660000	8924710000	8924270000
TTY, 0(4) - 20 mA	on DIN rail, separable	Screw terminals	4	5 kA	0.45 A	28 V	VSPC 2CL 24 V DC 0.5 A	8924470000	8924710000	8924270000
(Uko-Bus)	on DIN rail, separable	Screw terminals	4	5 kA	0.45 A	185 V	VSPC Uko	8924660000	8924710000	8924270000
V.35	on DIN rail, separable	Screw terminals	4	5 kA	0.45 A	6.4 V	VSPC 2CL HF 5 V DC	8924430000	8924710000	8924270000
VDSL	on DIN rail, separable	Screw terminals	4	5 kA	0.45 A	185 V	VSPC Uko	8924660000	8924710000	8924270000
X.21/X.24	on DIN rail, separable	Screw terminals	4	5 kA	0.45 A	15 V	VSPC 2CL HF 12 V DC	8924460000	8924710000	8924270000
X.25/X.31	on DIN rail, separable	Screw terminals	4	5 kA	0.45 A	15 V	VSPC 2CL HF 12 V DC	8924460000	8924710000	8924270000



SIL certification for VSSC and VSPC

Lightning and surge protection for instrumentation and control (I & C)

C



Zertifikat

Certificate

Registrier-Nr.
Registration No.
44 799 11 394001-001

Zeichen des Auftraggebers Customer's reference	Auftragsdatum Date of order	Aktenzeichen File reference	Technischer Bericht Nr. Test report no.
	18.03.2011	8000394001	11 799 304001-001

Name und Anschrift des Auftraggebers
Customer's name and address

Weidmüller Interface GmbH & Co. KG
Klingenbergrasse 16
32758 Detmold

Geprüft nach
Tested in accordance with

EN 61508:2010 Funktionale Sicherheit sicherheitsbezogener elektrischer/elektronischer/programmierbarer elektronischer Systeme

Beschreibung des Produktes
(Details siehe Anlage 1)

Überspannungsschutz / Overvoltage protection

VARITECTOR SPC und SSC

Bemerkung
Remark

Die einzelnen Typen der Überspannungsschutzserie können in SIL2 oder SIL3 Sicherheitskriterien eingesetzt werden / The single types of the overvoltage protection series can be used in SIL2 or SIL3 safety circuits. Die sichere Funktion bezieht sich auf den Einsatz in einem Kommunikationspfad / The safety function is intended for application in a communication path.

Dieses Zertifikat bescheinigt das Ergebnis der Prüfung an dem vorgestellten Prüfgegenstand. Eine allgemein gültige Aussage über die Qualität der Produkte aus der laufenden Fertigung kann hieraus nicht abgeleitet werden. This certifies the result of the examination of the product sample submitted by the manufacturer. A general statement concerning the quality of the products from the series manufacture cannot be derived there from.

TÜV NORD CERT GmbH
Zertifizierungsstelle / Certification body
Maschinen / Machinery

Gültig bis / Valid to: 12.04.2016

Hammer, 13.04.2011

Bitte beachten sie auch die umseitigen Hinweise
Please also pay attention to the information stated overleaf

Langemarkstr. 20 • 45141 Essen • Fon +49 (0)201 825 9120 • Fax +49 (0)201 825 3208 • Email: probent@tuv-nord.de

Anlage 1 zum Zertifikat Nr.:
Annex 1 to Certificate no.

44 799 11 394001-001

Rev. 1

Aktenzeichen: 8000394001
File reference

Seite 1 von 2
Page 1 of 2

Allgemeine Angaben
General information

Siehe Seite 1 des Zertifikates
See also page 1 of the Certificate

Typenbezeichnung
Type Description

VARITECTOR SPC und VARITECTOR SSC

Übersicht Parameter VARITECTOR SSC / Overview Parameter VARITECTOR SSC

Type	safe detected As in 1-10 ⁶ 1/h	safe undetected As in 1-10 ⁶ 1/h	dangerous detected As in 1-10 ⁶ 1/h	dangerous undetected As in 1-10 ⁶ 1/h	SFF	PFH in 1-10 ⁶ 1/h	Max. SIL
VSSC4 CL	6,1	10,95	0	1,95	89,74%	1,95	2
VSSC4 CL FG	7,1	19,95	0	1,95	93,28%	1,95	3
VSSC4 SL	7	35,1	0	0,9	97,91%	0,9	3
VSSC4 SL FG	7	35,1	0	0,9	97,91%	0,9	3
VSSC4 MOV	2,5	22,75	0,75	0	100,00%	0	3
VSSC4 GDY	1	9	0	0	100,00%	0	3
VSSC4 TAZ	2,5	24,25	5,25	0	100,00%	0	3
VSSC4 RC	2,5	24,15	0,75	0,8	97,76%	0,8	3
VSSC4 CL	6,1	10,95	0	1,95	89,74%	1,95	2
VSSC6 TR CL FG	7,1	19,95	0	1,95	93,28%	1,95	3
VSSC6 TR CL	6,1	10,95	0	1,95	89,74%	1,95	2
VSSC6 TR CL FG	7,1	19,95	0	1,95	93,28%	1,95	3
VSSC6 SL	7	45,2	0	1,8	96,67%	1,8	3
VSSC6 SL FG	7	45,2	0	1,8	96,67%	1,8	3
VSSC6 TR SL	7	45,2	0	1,8	96,67%	1,8	3
VSSC6 TR SL FG	7	45,2	0	1,8	96,67%	1,8	3
VSSC6 MOV	2,5	22,75	0,75	0	100,00%	0	3
VSSC6 GDY	1	9	0	0	100,00%	0	3
VSSC6 TAZ	2,5	24,25	5,25	0,9	97,91%	0,9	3
VSSC6 RC	2,5	24,15	0,75	3,25	94,58%	3,25	3
VSSC6 RS485 DP	8	43,75	5	3,5	95,39%	3,5	3
VSSC6 RS485 PA	8	43,75	5	3,5	95,39%	3,5	3
VSSC6 RTD	8	44,25	7	3,75	94,05%	3,75	3
VSSC6 RTD EX	8	43,75	6	3,25	94,67%	3,25	3

Anlage 1 zum Zertifikat Nr.:
Annex 1 to Certificate no.

44 799 11 394001-001

Rev. 1

Aktenzeichen: 8000394001
File reference

Seite 2 von 2
Page 2 of 2

Übersicht Parameter VARITECTOR SPC / Overview Parameter VARITECTOR SPC

Type	safe detected As in 1-10 ⁶ 1/h	safe undetected As in 1-10 ⁶ 1/h	dangerous detected As in 1-10 ⁶ 1/h	dangerous undetected As in 1-10 ⁶ 1/h	SFF	PFH in 1-10 ⁶ 1/h	Max. SIL
VSPC CL	13,6	29,45	0	1,95	95,67%	1,95	3
VSPC CL R	17,1	57,4	0	3,7	95,27%	3,70	3
VSPC CL HF	15,6	30,45	0	2,95	93,96%	2,95	3
VSPC CL HF R	19,1	58,4	0	4,7	94,25%	4,70	3
VSPC SL	6	27,1	1	8,9	79,30%	8,90	2
VSPC SL R	8,5	55,05	1	10,85	86,02%	10,7	2
VSPC 3/4 WRB	36	107	0	7	95,33%	7,00	3
VSPC RS485	12	31,75	9	4,25	92,54%	4,25	3
VSPC RS485 R	15,5	59,7	9	8	93,30%	6,00	3
VSPC TELE UKD	15,8	30,45	0	2,95	93,96%	2,95	3
VSPC 1CL F/W	13,6	29,45	0	1,95	95,67%	1,95	3
VSPC GDY ZCH	6	5	0	0	100,00%	0,00	3
VSPC MOV ZCH	2,5	22,75	0,75	0	100,00%	0,00	3
VSPC MOV ZCH R	2,5	73,95	0,75	0	100,00%	0,00	3
VSPC TAZ ZCH	2,5	24,25	5,25	0	100,00%	0,00	3
VSPC TAZ ZCH R	2,5	24,25	5,25	0	100,00%	0,00	3

TÜV NORD CERT GmbH
Zertifizierungsstelle / Certification body
Maschinen / Machinery

Gültig bis / Valid to: 12.04.2016

Hammer, 13.04.2011

Bitte beachten sie auch die umseitigen Hinweise
Please also pay attention to the information stated overleaf

Langemarkstr. 20 • 45141 Essen • Fon +49 (0)201 825 9120 • Fax +49 (0)201 825 3208 • Email: probent@tuv-nord.de

You can find the current certificates here:
www.weidmueller.com/certificates



Lightning and surge protection for control and instrumentation signals

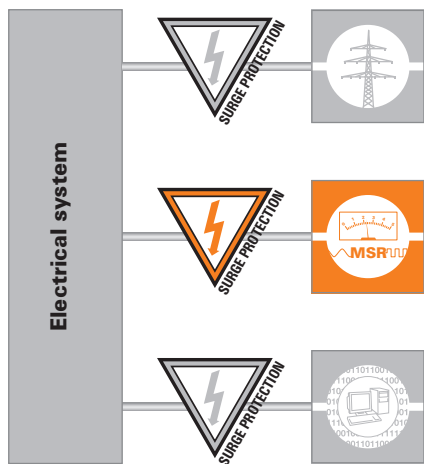

breakdowns or malfunctions can lead to exorbitant costs. As the standards covering low control voltages do not specify many parameters, the use of surge protection, apart from lightning protection zoning concepts, has to be classified according to type of signal, application circuit and the anticipated interference voltage phenomenon.

Types of interference voltage

Transient surges coupled into a system via one or more coupling mechanisms occur as normal- or common-mode interference. These are measured as longitudinal or transverse voltages and, depending on the circuit, designated as symmetrical or asymmetrical voltages. (For further information see the "Principles" chapter.)

Basic classification

The current scope of automation technology has resulted in a wide range of applications for surge protection in the field of instrumentation and control engineering. One important prerequisite is the consistent use of coordinated surge protection in all sections of the plant or building. In industry, instrumentation and control systems are important areas and

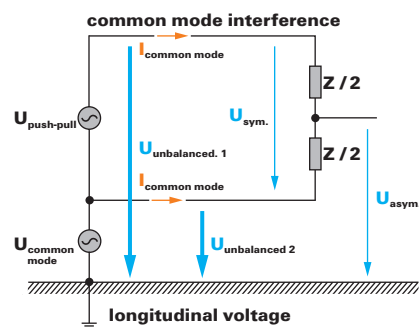

Common-mode interference (asymmetrical interference): Common-mode voltage between conductor and reference potential. (earth)/mainly caused by capacitive coupling (electrical field)

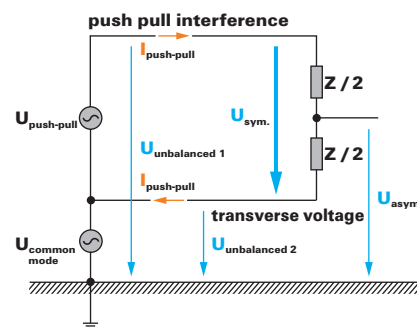

Normal-mode interference (symmetrical interference): Normal-mode voltage between supply and return conductor load and interference source connected in series, e.g. inductive (magnetic field) or conductive coupling (common impedance)

Types of signal

Binary signals SL [△] (symmetrical loop)

These are two-wire signals with a common reference potential which are required by, for example, by switches, PLC switch outputs, photoelectric barriers, position sensors, solenoid valves, warning lamps, PLC inputs, etc. Normally, these signals have a common reference potential that can be either connected or not connected to earth potential, depending on the type of protection. The coupled transient interference is primarily common-mode interference.

Analogue signals CL [△] (current loop)

Measuring circuits are normally designed as two-wire current loops or voltage signals without a common reference potential, like the 0(4)...20 mA current loop. The coupled transient interference is primarily normal-mode interference. For temperature measurements with the PT100 measuring shunt in the three-wire version, the voltage drop at the shunt is measured via the third wire. This must be included in the system of protection. The PT100 measuring shunt is also available in a four-wire version in which the voltage drop at the shunt is measured via the two additional lines without additional line losses in the PT100 measuring circuit. The coupled transient normal-mode interference occurs between the various wires.

Essential information for users can be found in the IEC 61643-22 standard (application standard for measurement and control signals) and in the IEC 62305-4 standard (application standard for installing internal lightning protection). It is important to determine which protection category is required. There are divisions for D1 (lightning protection), C2 (surge protection / overvoltage protection) and C1 (end device protection). These categories or classes are specified for the following products. All products were subjected to a test in accordance with product standard IEC 61643-21.

Binary signals

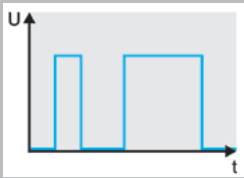

Two-wire, usually with common reference potential, e.g. signals from binary sensors, actuators and indicators such as limit switches, probes, position sensors, photoelectric barriers, contactors, solenoid valves, warning lamps.

Protection for binary signals connected to earth potential.

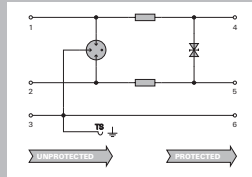

Protection for binary signals not connected to earth potential.

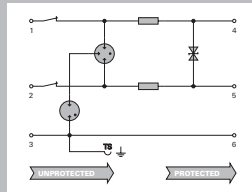

Protection for two-, three- and four-wire versions.

Type

- VSPC 2SL **Page C.30**
- VSPC 4SL **Page C.34**
- VSPC 3/4 **Page C.38**

- VSPC GDT **Page C.40**
- VSPC MOV **Page C.42**
- VSPC TAZ **Page C.44**
- VSPC UKO **Page C.46**

- VSSC6 SL LD **Page C.70**
- VSSC6 TR SL LD **Page C.72**
- VSSC6 SLFG LD **Page C.70**
- VSSC6 TR SLFG LD **Page C.72**

- VSSC6 MOV **Page C.74**
- VSSC6 TR LD MOV **Page C.76**
- VSSC6 GDT **Page C.78**
- VSSC6 TR GDT **Page C.80**
- VSSC6 TAZ **Page C.82**
- VSSC6 TR LD TAZ **Page C.82**
- VSSC6 RTD **Page C.86**

Type

- VSSC4 SL **Page C.92**
- VSSC4 SL FG **Page C.92**
- VSSC4 MOV **Page C.94**
- VSSC4 GDT **Page C.96**
- VSSC4 TAZ **Page C.98**
- VSSC4 RC **Page C.100**

- VSPC 2SL EX **Page C.138**
- VSPC 4SL EX **Page C.140**
- VSPC 3/4 wire EX **Page C.142**
- VSSC4 SL FG EX **Page C.152**
- VSSC4 GDT EX **Page C.154**
- VSSC6 RTD EX **Page C.160**
- VSSC6 TR SL FG EX **Page C.156**

- MCZ OVP SL **Page C.108**
- MCZ OVP SL FG **Page C.110**
- VCG 24 V EX 2 **Page C.162**
- VCG 24 V EX 4 **Page C.162**

Analogue signals

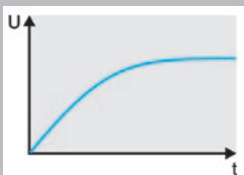

Two-, three- and four-wire versions without common reference potential.

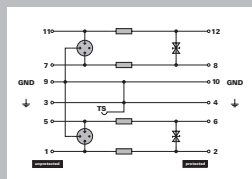

Signals from current loops (analogue measurements from sensors over long distances), 4...20 mA, 0...20 mA, etc., e.g. level measurements.

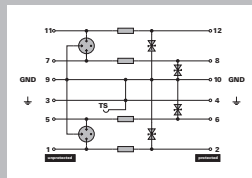

Signals from voltage sensors (analogue measurements from sensors over short distances), 0...10 V, PT100, etc., e.g. temperature measurements.

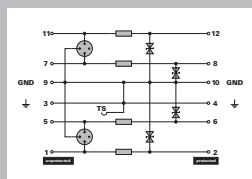

Type

- VSPC 1CL **Page C.16**
- VSPC 2CL **Page C.20**
- VSPC 1CL PW **Page C.28**
- VSPC RS485 **Page C.48**

- VSSC6 CL **Page C.66**
- VSSC6 TR CL **Page C.68**
- VSSC6 CLFG **Page C.66**
- VSSC6 TR CLFG **Page C.68**
- VSSC6 RS485 **Page C.84**
- VSSC6 RS485 DP **Page C.85**
- VSSC6 RS232 **Page C.85**

- VSSC4 CL **Page C.90**
- VSSC4 CL FG **Page C.90**

- VSPC 1CL EX **Page C.132**
- VSPC 2CL EX **Page C.134**
- VSPC 1CL PW EX **Page C.136**
- VSSC4 CL FG EX **Page C.150**
- VSSC6 TR CLFG EX **Page C.156**
- VSSC6 RS485 EX **Page C.158**

Type

- MCZ OVP HF **Page C.106**
- MCZ OVP CL **Page C.108**



VARIRECTOR SPC

Pluggable lightning and surge protection for measurement and control circuits

Pluggable lightning and surge protection for 2 analogue signals or 4 binary signals in measurement/control circuits – with integrated error detection and alert functions in only 17.8 mm width.

Our pluggable VARIRECTOR SPC surge protection is characterised by highest protective functions with compact dimensions. The arrestor of the modules can be removed, measured or exchanged during running operation impedance-neutral – without interrupting the measuring circuit. These features make this product the ideal secure protection mechanism for interfaces within instrumentation and control circuits.

Maintenance intervals are simplified by the V-TEST test unit, which is used for testing the function of the VARIRECTOR SPC. This test method satisfies the requirements of standard IEC 62305.

With the VARIRECTOR SPC R modules, error detection and error messages are realised by internal monitoring. The green LED indicates the active protective function. The red LED indicates a fault condition. This information is transmitted to the V-Control evaluation unit. From there, the information can be sent across to e.g. a controller.

Due to the impedance-neutral removing of the arrestor, the VARIRECTOR SPC modules can be used instead of terminals. For four binary signals or two analogue signals, just 17.8 mm of space on the mounting rail is used. By simply snapping onto a grounded mounting rail, time savings are also ensured when connecting. A colour code identifies the various voltage levels for all VARIRECTOR SPC modules. This simplifies maintenance work during operation. All VARIRECTOR products comply with the latest IEC 61643-21 requirement for a new overstress mode.

Accessories

V-TEST

Instrument for testing the protective function of the product family VSPC to IEC 62305 (periodic testing).



Monitoring function

Status display and message function: the protective function can be evaluated externally.



Quick identification

Colour-coded marking: simple identification of the different voltage levels in the switching cabinet.

- ≤ 12 V = green
- 24 V = binary signal, blue
- 24 V = analogue signal, yellow
- 48 V = red
- 60 V = violet
- special function = white

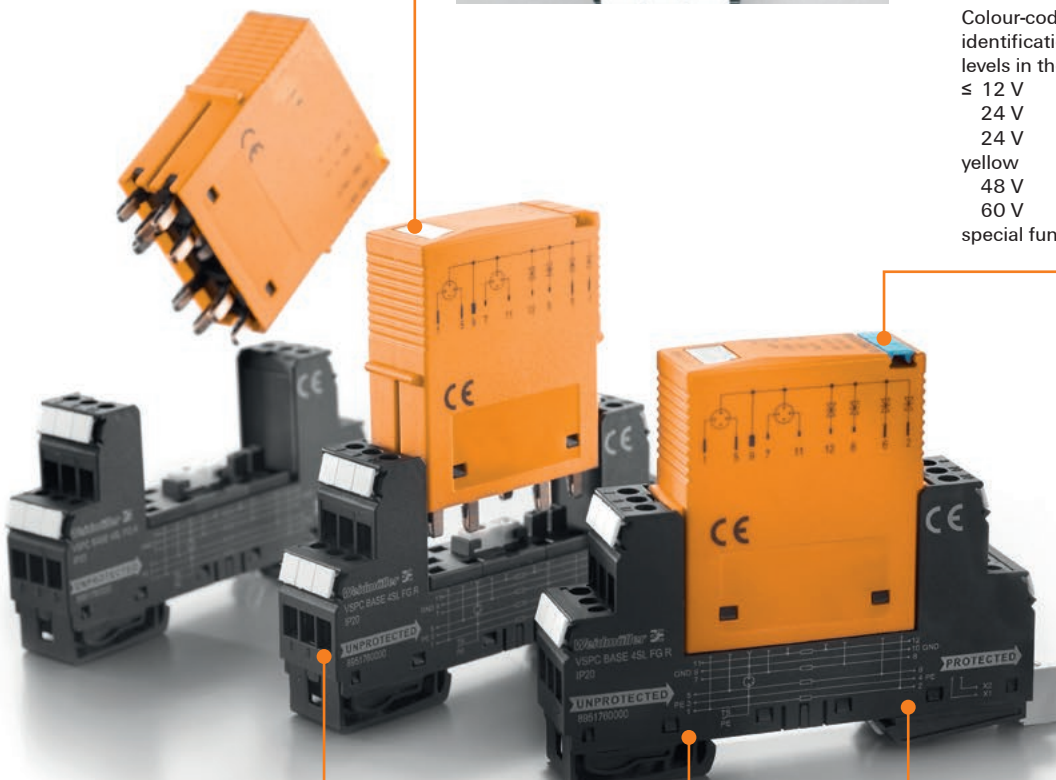

Space-saving

Saves space in the switching cabinet: 4 binary signals or 2 analogue signals on 17.8 mm.

Standard-conformant

Usable in accordance with installations standard IEC 62305 safely discharges high impulse currents up to 20 kA (8/20 μs) and 2.5 kA (10/350 μs) to PE. Tested for class D1, C1 and C2 to IEC 61643-21.

Large variety

A solution for every type of surge protection: current loops and binary signals as well as integrated components and combinations of current loops and voltage supply e.g. 24 V.



VARITECTOR SPC

Pluggable surge protection for the measurement and control industry VARITECTOR SPC

Weidmüller's VARITECTOR SPC pluggable surge protection is remarkable for its combination of extremely high protective functionality and compact dimensions. It is suited for use in measurement and control circuits. The size is made possible by the selection of INSTA dimensions, with a width of 17.8 mm (1TE).

Two versions are available:

- VSPC: a surge protector **with no** monitoring function
- VSPC R: a surge protector **with** monitoring function

The base components are plugged in to form a direct earthing contact via the mounting rail. This saves you time when making the connection. The VARITECTOR SPC series is optimally designed for compact installations in process automation, industrial automation and building automation. The two-stage surge-protection base components are equipped with gas discharge tubes, suppressor diodes (TVS) and decoupling components. Individual protective components (such as gas-filled spark gaps, varistors and suppressor diodes) supplement this product line. IEC 62305 requires that a periodic inspection of surge protection products be conducted. The functionality of all VARITECTOR SPC modules can be tested using testing equipment (such as the V-TEST Basic) that is available separately. The VARITECTOR SPC R modules also feature an internal monitoring function. The green LED signals when the protection function is ready. The red LED signals an error.

Up to ten modules can be wired together in succession. The modules alert an evaluative module (the VSPC CONTROL UNIT) in the event of an error. VARITECTOR SPC series surge protection is available with rated voltages of 5 V, 12 V, 24 V, 48 V and 60 V. The product's voltage level is colour-coded on the pluggable arrester. An earthing contact is established by snapping onto an earthed TS 35 rail. The TS 35 must be earthed in order to ensure safe power discharging via the terminals of up to 20 kA (8/20 μ s) and 2.5 kA (10/350 μ s). The rail must be screwed onto the earthed mounting plate for reasons of EMC. In order to optimise the protective function, a PE-contact connection should be made over the VSPC module every 60 cm for equipotential bonding. The pluggable protective element can be pulled out during operations without interrupting the measurement circuit. A testing instrument, available as a Weidmüller accessory, allows you to test the protective element in compliance with the IEC 62305-3 directive.



Overview of model types

A VARITECTOR SPC (VSPC) consists of a **pluggable component** and a separate **base component (VSPC BASE)**.

Explanation of terms:

CL = current loop / analogue signals

SL = symmetric loop - for binary signals

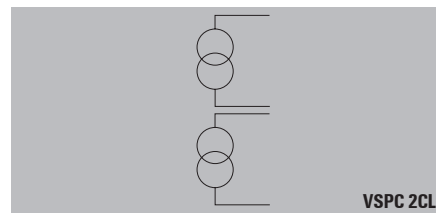
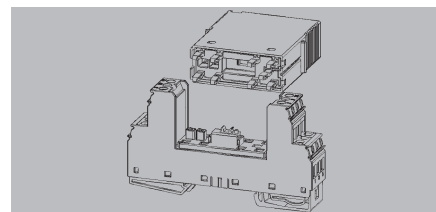

VSPC 2CL (CL = current loop) is a two-stage protective combination with a gas discharge tube and a suppressor diode located between the current paths. This VSPC 2CL limits the surge voltage within **two analogue signal circuits** (such as for current loops). This pluggable component can be inserted into the base (VSPC BASE 2CL). The base (VSPC BASE FG 2CL) is used when working with signal circuits which are not earthed. The VSPC 2CL HF is used in order to avoid influencing high-frequency signal circuits (this also includes the VSPC RS485 and the VSPC UKO). This protective combination is also inserted into the base mentioned above.

Monitoring function

The **VSPC 2CL R** products feature monitor and alert functions. As well as the alert function, there are two channels available for current loops in a single housing. The special VSPC BASE 2CL R and SPC BASE 2CL FG R bases





transfer the alert function to a 2-pole screw/plug-in connection in the bases and to the VSPC CONTROL UNIT.

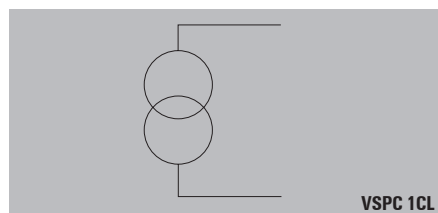

The **VSPC 1CL** is a two-stage protective combination with a gas discharge tube and a suppressor diode located between the current paths. This VSPC 1CL limits the surge voltage within **one analogue signal circuit** (such as for current loops). This pluggable component can be inserted into the base (VSPC BASE 1CL). The base (VSPC BASE FG 1CL) is used when working with signal circuits which are not earthed.

Monitoring function

The **VSPC 1CL R** products feature monitor and alert functions. All channels remain despite the alert function. The special VSPC BASE 1CL R and VSPC BASE 1CL FG R bases transfer the alert function to a 2-pole screw/plug-in connection in the bases and to the VSPC CONTROL UNIT.

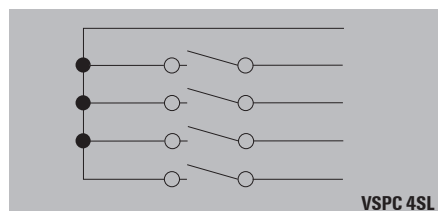

The **VSPC 4SL** is a two-stage protective combination with a gas discharge tube and a suppressor diode from the current path to the PE. This VSPC 4SL limits the surge voltage within **four binary signal circuits** (such as for alert contacts). This pluggable component can be inserted into the base (VSPC BASE 4SL). The base (VSPC BASE FG 4CL) is used

when working with signal circuits which are not earthed.

Monitoring function

The **VSPC 4SL R** products feature monitor and alert functions. Even with the alert function, there are still channels available for the four binary signal circuits in a single housing. The special VSPC BASE 4SL R base transfers the alert function to a 2-pole screw/plug-in connection in the base and to the VSPC CONTROL UNIT.

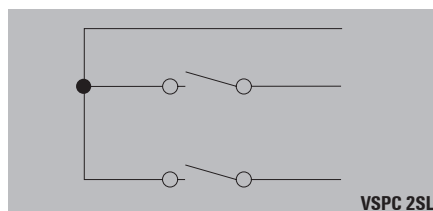

The **VSPC 2SL** is a two-stage protective combination with a gas discharge tube and a suppressor diode from the current path to the PE. This VSPC 2SL limits the surge voltage within **two binary signal circuits** (such as for alert contacts). This pluggable component can be inserted into the base (VSPC BASE 2SL). The base (VSPC BASE 2CL FG) is used when working with signal circuits which are not earthed.

Monitoring function

The VSPC 2SL R products feature monitor and alert functions. Even with the alert function, there are still channels available for the two binary signal circuits in a single housing. The special VSPC BASE 2SL R base transfers the alert function to a 2-pole screw/plug-in connection in the base and to the VSPC CONTROL UNIT.

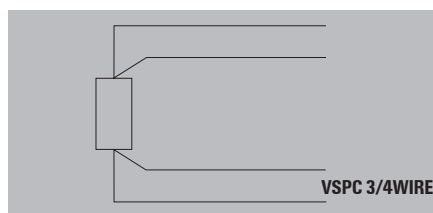

The **VSPC 3/4WIRE** is a two-stage protective combination with a gas discharge tube and a suppressor diode from the current path to the GND. This VSPC 3/4WIRE limits the surge voltage within four temperature-measurement circuits (such as for DMS or PT100/100 sensors). For non-earthed measurement circuits, we recommend using the base (VSPC BASE FG 4CL).

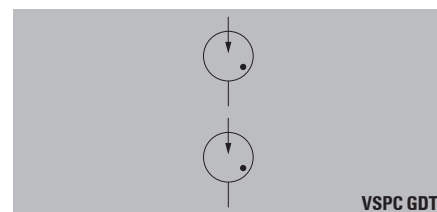

VSPC MOV 2CH, VSPC TAZ 2CH and VSPC GDT 2CH

Four cables can be protected with the 2CH modules. By wiring the connections differently, either two no-voltage signal lines or four binary signal lines can be protected. Two three-pole gas discharge tubes (GDTs) are used for the VSPC GDT 2CH. This universal protective circuitry limits the voltage between the signal lines and also between each signal line and the PE.

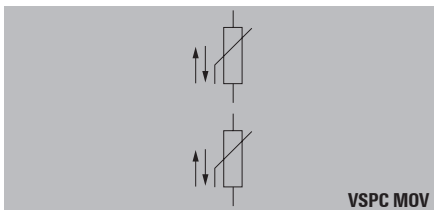
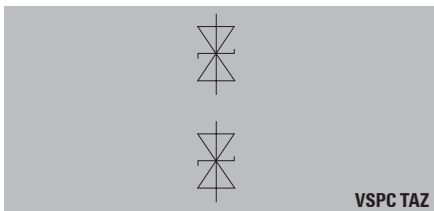

The **VSPC MOV 2CH** and **TAZ 2CH** offer one-stage protection with a varistor (MOV) or suppressor diode (TAZ or TVS) between the current paths. This makes it possible to protect a no-voltage (floating) signal circuit. Two binary signal circuits can also be protected if terminals 1 and 7 are assigned to GND / PE. These VSPC pluggable components are inserted into the base (VSPC BASE 2/4CH). The base (VSPC BASE 2/4CH FG) is used when working with signal circuits which are not earthed.

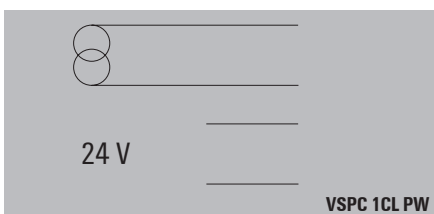

VSPC 1CL PW (power and signal 1CL) offers combined protection that is suitable for the 24 V DC power supply and the current loops within a device. This VSPC protects sensors with an additional 24 V DC.

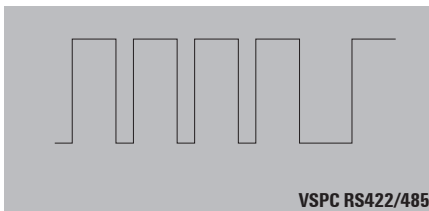

The **VSPC RS485** is a two-stage protective combination with a gas discharge tube and a suppressor diode located between the current paths. This VSPC RS485 limits the surge voltage within **two high-frequency signal circuits**. This pluggable component can be inserted into the base (VSPC BASE 2CL). The base (VSPC BASE FG 2CL) is used when working with signal circuits which are not earthed.

Monitoring function

The **VSPC RS485 R** product features monitoring and alert functions. Even with the alert function, there are still two channels available for current loops in a single housing. The special VSPC BASE 2CL R and VSPC BASE 2CL FG R bases transfer the alert function to a 2-pole screw/plug-in connection in the bases and to the VSPC CONTROL UNIT.

Applications

The pluggable INSTA housing was created in compliance with DIN 43880. It consists of a lower section (the VSPC BASE) and a pluggable component (the VSPC). The VSPC BASE is made from black PA6.6 V0. The pluggable component is made from red PA6.6 V0. The temperature range is from -40 °C to + 70 °C. The VSPC series has been tested to comply with IEC 61643-21 04/2008 and EN 61643-21. Modules were tested with categories C1, C2 and C3: with quick-rising edges with up to 300 pulses. Category D1 describes high power testing (10/350 µs lightning protection), so that the VSPC can be used according to IEC 62305-4. The base and pluggable components are colour coded according to the voltage level. This makes installation easier.

Colour coding

The pluggable components transfer their coding to the base element when they are plugged in for the first time. The voltage levels are also labelled with coloured Dekafix markers applied to the VSPC pluggable component. This gives you a better overview within the electrical cabinet.

Voltage level	Colour
≤ 12 V	green
24 V Binary	blue
24 V Analogue	yellow
48 V	red
≥ 60 V	violet
Special function	white



Test possibility / V-TEST

Because the modules are pluggable, it is possible to test the VSPC visually or by using a V-TEST testing device. The VSPC can be easily tested; the user needs only to insert the VSPC pluggable component into the V-TEST. The result is then shown on the display. The VSPC R modules also feature an internal monitoring function for the arrester. An error is displayed at the defective module. The VSPC CONTROL UNIT can then transfer an alert to the control room.

Reoccurring tests / V-TEST

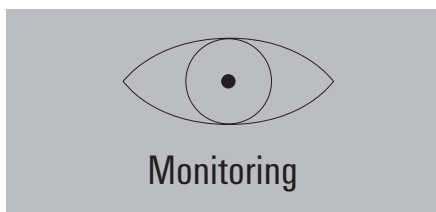

The IEC 62305-3 requires testing and maintenance for lightning protection systems. This includes the testing of the arresters used in the system.

Class of protection	Interval for complete testing	Interval for visual inspection
I/II	2 years	1 year
III/IV	4 years	2 years

Caution! These periodic inspections may be extended with stricter requirements pertaining to special applications or regions.

Remote error diagnostics

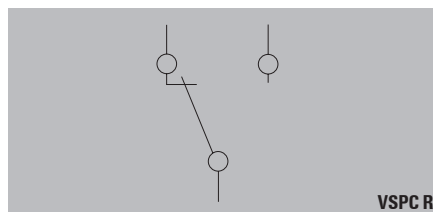

When the VSPC module labelled "R" is inserted into the corresponding "R" base component, it is then possible to use the outage alert function via a two-pole plug. This screw/plug-in connection has a clamping range from 0.5 to 1.5 mm².

The wire stripping length is 6 to 6.5 mm. A screwdriver with a 2-mm blade width is used to turn the screw. The VSPC Rs are connected in succession to the VSPC CONTROL UNIT evaluative module. Up to ten VSPC Rs can be connected in succession to the VSPC CONTROL UNIT. The evaluative module is supplied with 24 V DC. It is then responsible for the switching and for the voltage supply to the VSPC modules. A no-voltage (floating) CO contact can then be used to alert in the event of an outage. The error on the module, with the LED changing colour from green to red. An automatic reset is carried out by the VSPC CONTROL UNIT within one minute after the failed VSPC pluggable component is replaced.

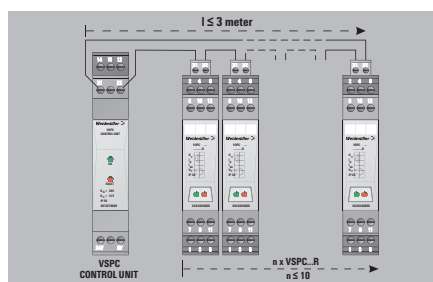

Installation

The VSPC series is appropriate for protecting signal circuits. In order to achieve a complete protective strategy for the facility, the power feed must be protected against Type II surge voltages (for example, by using our VPU II series). For existing lightning protection facilities, Type I protection must be used (for example, by using our VPU I series). Type II protection (for example, our VPU II) is sufficient when there is no lightning protection in place.

Fusing

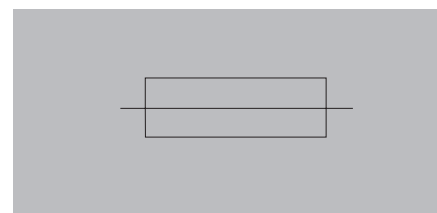

The VSPC surge protection modules are designed so that they are decoupled between the individual protective stages.

The following must be observed when providing fuse protection externally:

- Max. rated current
- Deratings curve
- Type of installation
- Application

VARITECTOR SPC

Discharge capacity

Testing is conducted using voltage and current pulses according to the IEC 61643-21 standard concerning surge protection in networks which process signals.

Category	Testing pulse	Surge voltage	Surge current	Pulse	Type
C1	Quick rising edge	0.5-2 kV with 1.2/50 μ s	0.25-1 kA with 8/20 μ s	300	Surge voltage arrester
C2	Quick rising edge	2-10 kV with 1.2/50 μ s	1-5 kA with 8/20 μ s	10	Surge voltage arrester
C3	Quick rising edge	≥ 1 kV with 1 kV/ μ s	10-100 A with 10/10.000 μ s	300	Surge voltage arrester
D1	High power	≥ 1 kV	0.5-2.5 kA with 10/350 μ s	2	Arrester for lightning current and surge voltages

Category C reflects the interference pulses with quick-rising edges and minimised power. Category D uses quick-rising edges and high power to detail the interference pulses. This energy simulates the high-power load that stems from coupled partial lightning currents.

Error mode

The VSSC and VSPC series are tested pursuant to IEC/EN 61643-21 and meet Mode 1 and 2 requirements.

More information can be found in Chapter W.

General technical data

Storage temperature -40 °C...+80 °C
 Operating temperature: -40 °C...+70 °C
 Air humidity 5%...96% RH with no condensation
 Material: V0, IP 20

Connection: screw connection
 screwdriver blade: 0.6 x 3.5 DIN 5264
 (for example, 0.6x3.5x200,
 order no. 9010110000)
 rated torque: 0.5 Nm
 max. torque: 0.8 Nm
 stripping length: 7 mm
 solid: 0.5...4 mm²
 flexible: 0.5...2.5 mm²
 wire-end ferrule with plastic collar:
 0.5...2.5 mm²

Remote signalling connection:
 screw connection
 screwdriver blade: 0.4 x 2.0 DIN 5264
 (for example, SD 0.4x2.0x60,
 order no. 9037160000)
 max. torque: 0.2 Nm
 stripping length: 6...6.5 mm
 solid: 0.5...1.5 mm²

Dimensions

Height: 90 mm
 Height: with remote signalling contact:
 98 mm
 Depth: 69 mm
 Width: 17.8 mm

Accessories

Markers

The VSPC BASE lower section can be labelled with Dekafix-5 markers. The VSPC pluggable modules are colour coded with Dekafix-5 markers according to their rated voltage.

V-TEST

Testing device for functional tests of the pluggable VSPC surge protection.



VSPC Ground

This plug is attached to unused wires in the base element, so that all wires have the same potential.

VARITECTOR SPC – Choice of device depending on the interface

Interface	Pluggable arrester	Order No. Arrester	Order No. Base	Order No. Base floating ground (FG)	Pluggable arrester with operation message (R)	Order No. Arrester	Order No. Base	Order No. Base floating ground (FG)
0(4) ... 20 mA	VSPC 2CL 24 V DC 0,5 A	8924470000	8924710000	8924270000	VSPC 2CL 24 V DC 0,5 A R	8951480000	8951710000	8951720000
0(4) ... 20 mA	VSPC 1CL 24 V DC 0,5 A	8924480000	8924730000	8924290000	VSPC 1CL 12 V DC 0,5 A R	8951540000	8951730000	8951740000
0 ... 10 V	VSPC 2CL 24 V DC 0,5 A	8924470000	8924710000	8924270000	VSPC 2CL 24 V DC 0,5 A R	8951480000	8951710000	8951720000
0 ... 10 V	VSPC 1CL 24 V DC 0,5 A	8924480000	8924730000	8924290000	VSPC 1CL 12 V DC 0,5 A R	8951540000	8951730000	8951740000
ADSL	VSPC Uko	8924660000	8924710000	8924270000				
ADVANT	VSPC 2CL HF 5 V DC	8924430000	8924710000	8924270000	VSPC 2CL HF 5 V DC R	8951680000	8951710000	8951720000
ARCNET (Plus)	VSPC RS485 2ch	8924670000	8924710000	8924270000	VSPC RS485 2ch R	8951670000	8951710000	8951720000
ASI	VPU III R 48 V DC	1351600000			VPU III R 48 V DC	1351600000		
	VPU III R 24 V DC	1351580000			VPU III R 24 V DC	1351580000		
BITBUS	VSPC 2CL HF 12 V DC	8924460000	8924710000	8924270000	VSPC 2CL 12 V DC 0,5 A R	8951470000	8951710000	8951720000
BLN (Building Level Network)	VSPC 2CL HF 12 V DC	8924460000	8924710000	8924270000	VSPC 2CL 12 V DC 0,5 A R	8951470000	8951710000	8951720000
CAN-Bus	VSPC 1CL 12 V DC 0,5 A	8924480000	8924730000	8924290000	VSPC 1CL 12 V DC 0,5 A R	8951540000	8951730000	8951740000
CAN-Bus	VSPC 2CL HF 12 V DC	8924460000	8924710000	8924270000	VSPC 2CL HF 12 V DC R	8951690000	8951710000	8951720000
C-BUS	VSPC 2CL HF 12 V DC	8924460000	8924710000	8924270000	VSPC 2CL HF 12 V DC R	8951690000	8951710000	8951720000
CC-LINK	VSPC 2CL HF 12 V DC	8924460000	8924710000	8924270000	VSPC 2CL HF 12 V DC R	8951690000	8951710000	8951720000
CANopen	VSPC 2CL HF 5 V DC	8951280000	8951710000	8951720000				
Data Highway (Plus), DH+	VSPC 2CL HF 12 V DC	8924460000	8924710000	8924270000	VSPC 2CL HF 12 V DC R	8951690000	8951710000	8951720000
Datex-P	VSPC 2CL HF 12 V DC	8924460000	8924710000	8924270000	VSPC 2CL HF 12 V DC R	8951690000	8951710000	8951720000
DeviceNet	VSPC 2CL HF 12 V DC	8924460000	8924710000	8924270000	VSPC 2CL HF 12 V DC R	8951690000	8951710000	8951720000
DIN Messbus	VSPC 2CL HF 12 V DC	8924460000	8924710000	8924270000	VSPC 2CL HF 12 V DC R	8951690000	8951710000	8951720000
Dupline/Miniplex	VSPC 1CL 12 V DC 0,5 A	8924450000	8924730000	8924290000	VSPC 1CL 12 V DC 0,5 A R	8951540000	8951730000	8951740000
KNX	VSPC 1CL 24 V DC 0,5 A	8924480000	8924730000	8924290000	VSPC 1CL 24 V DC 0,5 A R	8951550000	8951730000	8951740000
ET 200	VSPC 1CL 5 V DC 0,5 A	8924420000	8924730000	8924290000	VSPC 1CL 5 V DC 0,5 A R	8951530000	8951730000	8951740000
E1	VSPC Uko	8924660000	8924710000	8924270000				
	VSPC 2CL HF 5 V DC	8924430000	8924710000	8924270000	VSPC 2CL HF 5 V DC R	8951680000	8951710000	8951720000
FIPIO/FIPWAY	VSPC 2CL HF 5 V DC	8924430000	8924710000	8924270000	VSPC 2CL HF 5 V DC R	8951680000	8951710000	8951720000
Genius I/O Bus	VSPC 2CL 12 V DC 0,5 A	8924440000	8924710000	8924270000	VSPC 2CL 12 V DC 0,5 A R	8951470000	8951710000	8951720000
Hart	VSPC 1CL 24 V DC 0,5 A	8924480000	8924730000	8924290000	VSPC 1CL 24 V AC 0,5 A R	8951560000	8951730000	8951740000
HDSL	VSPC Uko	8924660000	8924710000	8924270000				
IEC-BUS	VSPC 2CL HF 5 V DC	8924430000	8924710000	8924270000	VSPC 2CL HF 5 V DC R	8951680000	8951710000	8951720000
ISDN Basic connection (Uko-Bus)	VSPC Uko	8924660000	8924710000	8924270000				
Cathodic corrosion prevention	VSPC GDT 2ch 90 V 20 kA	8924570000	8924740000	8924300000				
LON™ (Works)	VSPC 1CL 48 V AC 0,5 A	8924520000	8924730000	8924290000				
LRE networks	VSPC 2CL HF 5 V DC	8924430000	8924710000	8924270000	VSPC 2CL HF 5 V DC R	8951680000	8951710000	8951720000
LUXMATE-Bus	VSPC 2CL HF 24 V DC	8924510000	8924710000	8924270000	VSPC 2CL HF 24 V DC R	8951700000	8951710000	8951720000
M-Bus (Remote readout of counter)	VSPC 1CL 48 V AC 0,5 A	8924520000	8924730000	8924290000	VSPC 1CL 48 V DC 0,5 A R	8924520000	8924730000	8924290000
MODBUS-(PLUS)	VSPC 2CL HF 12 V DC	8924460000	8924710000	8924270000	VSPC 2CL HF 12 V DC R	8951690000	8951710000	8951720000
MPI-Bus	VSPC RS485 2ch	8924670000	8924710000	8924270000				
N1 LAN	VSPC 2CL HF 5 V DC	8924430000	8924710000	8924270000	VSPC 2CL HF 5 V DC R	8951680000	8951710000	8951720000
N2 Bus	VSPC 2SL 5 V DC 0,5 A	8924210000	8924720000	8924280000	VSPC 2SL 5 V DC 0,5 A R	8951610000	8951770000	8951780000
P-NET	VSPC 2CL HF 12 V DC	8924460000	8924710000	8924270000	VSPC 2CL HF 12 V DC R	8951690000	8951710000	8951720000
Proconic CS31	VSPC 1CL 12 V DC 0,5 A	8924450000	8924730000	8924290000	VSPC 1CL 12 V DC 0,5 A R	8951540000	8951730000	8951740000
	VSPC 2CL HF 12 V DC	8924460000	8924710000	8924270000	VSPC 2CL HF 12 V DC R	8951690000	8951710000	8951720000
Proconic T200	VSPC 2CL HF 12 V DC	8924460000	8924710000	8924270000	VSPC 2CL HF 12 V DC R	8951690000	8951710000	8951720000
Profibus DP (FMS)	VSPC 2CL HF 5 V DC	8924430000	8924710000	8924270000	VSPC 2CL HF 5 V DC R	8951680000	8951710000	8951720000
	VSPC 2CL HF 12 V DC	8924460000	8924710000	8924270000	VSPC 2CL HF 12 V DC R	8951690000	8951710000	8951720000
Prozess-Bus, Panel-Bus	VSPC 2CL HF 12 V DC	8924460000	8924710000	8924270000	VSPC 2CL HF 12 V DC R	8951690000	8951710000	8951720000
PT100	VSPC 3/WIRE 24 V DC	8924550000	8924740000	8924300000				
P-Bus	VPU III R 24 V DC	1351580000			VPU III R 24 V DC	1351580000		
PSM-EG-RS422...	VSPC 2CL HF 12 V DC	8924460000	8924710000	8924270000	VSPC 2CL HF 12 V DC R	8951690000	8951710000	8951720000
PSM-EG-RS485...	VSPC 2CL HF 12 V DC	8924460000	8924710000	8924270000	VSPC 2CL HF 12 V DC R	8951690000	8951710000	8951720000
RACKBUS	VSPC 2CL HF 5 V DC	8924430000	8924710000	8924270000	VSPC 2CL HF 5 V DC R	8951680000	8951710000	8951720000
RS 422A, V.11, X.27, RS423A	VSPC 2CL HF 12 V DC	8924460000	8924710000	8924270000	VSPC 2CL HF 12 V DC R	8951690000	8951710000	8951720000
RS449	VSPC 2CL HF 12 V DC	8924460000	8924710000	8924270000	VSPC 2CL HF 12 V DC R	8951690000	8951710000	8951720000
RS485	VSPC RS485 2ch	8924670000	8924710000	8924270000	VSPC RS485 2ch R	8951670000	8951710000	8951720000
RS232-C/V.24	VSPC 2CL HF 12 V DC	8924460000	8924710000	8924270000	VSPC 2CL HF 12 V DC R	8951690000	8951710000	8951720000
SDLC	VSPC 2CL HF 12 V DC	8924460000	8924710000	8924270000	VSPC 2CL HF 12 V DC R	8951690000	8951710000	8951720000
SDSL	VSPC Uko	8924660000	8924710000	8924270000				
SecurLan-LON™-Bus	VSPC 1CL 12 V DC 0,5 A	8924450000	8924730000	8924290000	VSPC 1CL 12 V DC 0,5 A R	8951540000	8951730000	8951740000
SHDSL	VSPC Uko	8924660000	8924710000	8924270000				
SINEC L1	VSPC 2CL HF 5 V DC	8924430000	8924710000	8924270000	VSPC 2CL HF 5 V DC R	8951680000	8951710000	8951720000
SINEC L2 DP	VSPC 2CL HF 5 V DC	8924430000	8924710000	8924270000	VSPC 2CL HF 5 V DC R	8951680000	8951710000	8951720000
Profibus DP	VSPC RS485 2ch	8924670000	8924710000	8924270000	VSPC RS485 2ch R	8951670000	8951710000	8951720000
T-DSL	VSPC Uko	8924660000	8924710000	8924270000				
Telephone analog	VSPC Uko	8924660000	8924710000	8924270000				
TTY, 0(4) - 20 mA	VSPC 2CL 24 V DC 0,5 A	8924470000	8924710000	8924270000	VSPC 2CL 24 V DC 0,5 A R	8951480000	8951710000	8951720000
U-BUS	VSPC GDT 2ch 90 V 20 kA	8924570000	8924740000	8924300000				
VDSL	VSPC Uko	8924660000	8924710000	8924270000				
V.35	VSPC 2CL HF 5 V DC	8924430000	8924710000	8924270000	VSPC 2CL HF 5 V DC R	8951680000	8951710000	8951720000
X.21/X.24	VSPC 2CL HF 12 V DC	8924460000	8924710000	8924270000	VSPC 2CL HF 12 V DC R	8951690000	8951710000	8951720000
X.25/X.31	VSPC 2CL HF 12 V DC	8924460000	8924710000	8924270000	VSPC 2CL HF 12 V DC R	8951690000	8951710000	8951720000

This table contains recommendations for the choice of device. Our technical consultants will be glad to assist you with your individual requirements.



VARITECTOR SPC

VSPC 1CL - protection for one analogue signal

- Optional monitoring function with status indicator and alert function
- Pluggable arrester (impedance-neutral plugging/unplugging without interruption)
- Can be tested with the V-TEST testing device
- Optional version with floating earth PE connection to avoid voltage potential differences
- Usable in accordance with installations standard IEC 62305
- Tested in accordance with IEC/EN 61643-21: D1,C1,C2,C3
- Integrated PE foot, safely discharges up to 20 kA (8/20 μ s) and 2.5 kA (10/350 μ s) to PE

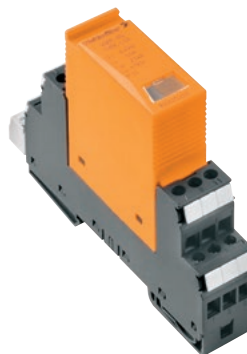

Technical data

Volume resistance	2.20 Ω
Overload - failure mode	Modus 2
Requirements category acc. to IEC 61643-21	C1, C2, C3, D1
Surge current-carrying capacity C1	< 1 kA 8/20 μ s
Surge current-carrying capacity C2	5 kA 8/20 μ s
Surge current-carrying capacity C3	100 A 10/1000 μ s
Surge current-carrying capacity D1	2.5 kA 10/350 μ s
Discharge current $I_{(8/20 \mu s)}$ wire-wire/wire-PE/GND-PE	2.5 kA / 2.5 kA / 2.5 kA
Discharge $I_{max(8/20 \mu s)}$ wire-wire/wire-PE/GND-PE	10 kA / 10 kA / 10 kA
Lightning test $I_{imp(10/350 \mu s)}$ wire-wire/wire-PE/GND-PE	2.5 kA / 2.5 kA / 2.5 kA
Type of connection	Pluggable in VSPC BASE
Storage temperature	-40 °C...80 °C
Ambient temperature (operational)	-40 °C...70 °C
Protection degree	IP20
Failure probability	
Ages	45
MTTF	2537
SIL in compliance with IEC 61508	3
Approvals	
Approvals	CE; CSAEX; FUSAFETY; UL
Standards	IEC 61643-21, HART-compatible

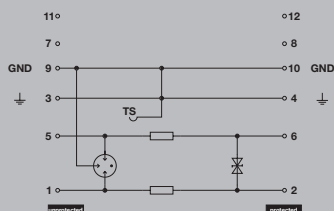

Complete module, direct earthing

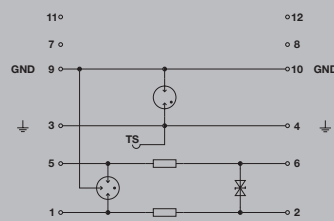

Complete module, indirect earthing

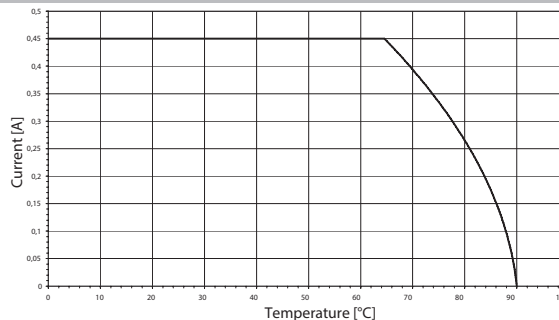

Dimensions of complete module (arrester + base element)	no remote sig. contact
Height x width x depth	mm 90 / 17.8 / 69

Note The associated VSPC base element should be ordered with this. The dimension information provided refers to the complete module.

Base elements / base to arresters



Ordering data for base

Description	Type	Qty.	Order No.
Base element, indirect earthing / floating earth FG	VSPC BASE 1CL FG	1	8924290000
Base element, direct earthing	VSPC BASE 1CL	1	8924730000

Note Technical data can be found at the beginning of the VARITECTOR SPC section.

VSPC 1CL - arrester / plug-in elements



Ordering data

	VSPC 1CL 5 V DC	VSPC 1CL 12 V DC	VSPC 1CL 24 V DC	VSPC 1CL 24 V AC
Rated voltage (AC)				24 V
Rated voltage (DC)	5 V	12 V	24 V	34 V
Max. continuous voltage, U _c (AC)				28 V
Max. continuous voltage, U _c (DC)	6.4 V	15 V	28 V	40 V
Rated current I _n	450 mA	450 mA	450 mA	450 mA
Input attenuation	730 KHz	1.7 MHz	2.4 MHz	2.7 MHz
Pulse-reset capacity	≤ 20 ms	≤ 20 ms	≤ 30 ms	≤ 450 ms
Residual voltage, U _r typical	< 800 V	< 800 V	< 800 V	< 800 V
Protection level				
Protection level wire-wire 1kV/μs, type	12 V	25 V	45 V	60 V
Protection level wire-wire 8/20 μs, type	12 V	25 V	45 V	60 V
Protection level wire-PE 1kV/μs, type	450 V	450 V	450 V	450 V
Protection level wire-PE 8/20 μs, type	< 800 V	< 800 V	< 800 V	< 800 V

Ordering data

without function indicator	Type	VSPC 1CL 5VDC	VSPC 1CL 12VDC	VSPC 1CL 24VDC	VSPC 1CL 24VAC
	Order No.	8924420000	8924450000	8924480000	8924500000
	Qty.	1	1	1	1
Note					

Ordering data

	VSPC 1CL 48 V AC	VSPC 1CL 60 V AC
Rated voltage (AC)	48 V	60 V
Rated voltage (DC)	68 V	85 V
Max. continuous voltage, U _c (AC)	60 V	72 V
Max. continuous voltage, U _c (DC)	85 V	102 V
Rated current I _n	350 mA	250 mA
Input attenuation	4.8 MHz	7.3 MHz
Pulse-reset capacity	≤ 500 ms	≤ 500 ms
Residual voltage, U _r typical	< 800 V	< 800 V
Protection level		
Protection level wire-wire 1kV/μs, type	85 V	100 V
Protection level wire-wire 8/20 μs, type	85 V	100 V
Protection level wire-PE 1kV/μs, type	450 V	450 V
Protection level wire-PE 8/20 μs, type	< 800 V	< 800 V

Ordering data

without function indicator	Type	VSPC 1CL 48VAC	VSPC 1CL 60VAC
	Order No.	8924520000	8924530000
	Qty.	1	1
Note			



VARITECTOR SPC

VSPC 1CL - protection for one analogue signal with remote alert

- Optional monitoring function with status indicator and alert function
- Pluggable arrester (impedance-neutral plugging/unplugging without interruption)
- Can be tested with the V-TEST testing device
- Optional version with floating earth PE connection to avoid voltage potential differences
- Usable in accordance with installations standard IEC 62305
- Tested in accordance with IEC/EN 61643-21: D1,C1,C2,C3
- Integrated PE foot, safely discharges up to 20 kA (8/20 μ s) and 2.5 kA (10/350 μ s) to PE

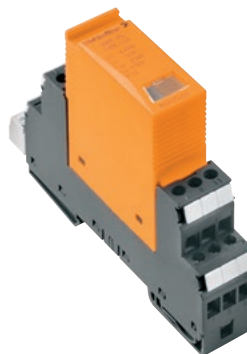

Technical data

Volume resistance	2.20 Ω
Overload - failure mode	Modus 2
Requirements category acc. to IEC 61643-21	C1, C2, C3, D1
Surge current-carrying capacity C1	< 1 kA 8/20 μ s
Surge current-carrying capacity C2	5 kA 8/20 μ s
Surge current-carrying capacity C3	100 A 10/1000 μ s
Surge current-carrying capacity D1	2.5 kA 10/350 μ s
Discharge current $I_{(8/20 \mu s)}$ wire-wire/wire-PE/GND-PE	2.5 kA / 2.5 kA / 2.5 kA
Discharge $I_{max(8/20 \mu s)}$ wire-wire/wire-PE/GND-PE	10 kA / 10 kA / 10 kA
Lightning test $I_{imp(10/350 \mu s)}$ wire-wire/wire-PE/GND-PE	2.5 kA / 2.5 kA / 2.5 kA
Type of connection	Pluggable in VSPC BASE
Storage temperature	-40 °C...80 °C
Ambient temperature (operational)	-40 °C...70
Protection degree	IP20
Failure probability	
Ages	45
MTTF	2537
SIL in compliance with IEC 61508	3
Approvals	
Approvals	CE; CSAEX; FUSAFETY; UL
Standards	IEC 61643-21, HART-compatible

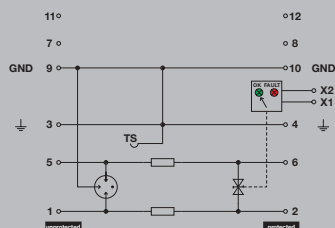

Complete module, direct earthing, with remote alert

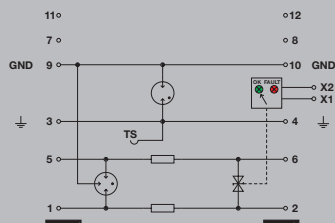

Complete module, indirect earthing, with remote alert

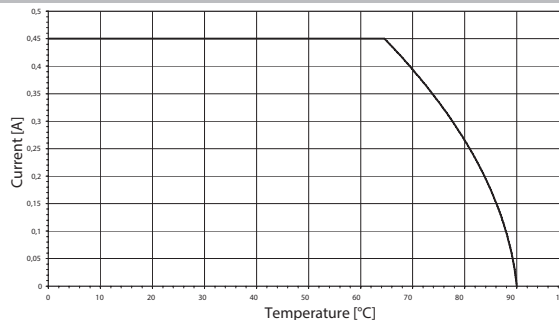

Dimensions of complete module (arrester + base element)	with remote signalling (R)
Height x width x depth	mm 98 / 17.8 / 69

Note The associated VSPC base element should be ordered with this. The dimension information provided refers to the complete module.

Base elements / base to arresters



Ordering data for base

Description	Type	Qty.	Order No.
Base element, direct earthing with remote contact	VSPC BASE 1CL R	1	8951730000
Base element, indirect earthing with remote contact	VSPC BASE 1CL FG R	1	8951740000

Note Technical data can be found at the beginning of the VARITECTOR SPC section. Order with VSPC CONTROL UNIT.

**VSPC 1CL - arrester / plug-in components
with remote alert**



Ordering data

	VSPC 1CL 5 V DC R	VSPC 1CL 12 V DC R	VSPC 1CL 24 V DC R	VSPC 1CL 24 V AC R
Rated voltage (AC)				24 V
Rated voltage (DC)	5 V	12 V	24 V	34 V
Max. continuous voltage, U_c (AC)				28 V
Max. continuous voltage, U_c (DC)	6.4 V	15 V	28 V	40 V
Rated current I_N	450 mA	450 mA	450 mA	450 mA
Signalling contact	U _N 250 V AC 0.1 A 1CO at VSPC R with VSPC control unit		U _N 250 V AC 0.1 A 1CO at VSPC R with VSPC control unit	
Optical function display	green = OK; red = arrester is defective - replace		green = OK; red = arrester is defective - replace	
Input attenuation	730 KHz	1.7 MHz	2.4 MHz	2.6 MHz
Pulse-reset capacity	≤ 20 ms	≤ 20 ms	≤ 30 ms	≤ 450 ms
Residual voltage, U_r typical	< 800 V	< 800 V	< 800 V	< 800 V
Protection level				
Protection level wire-wire 1kV/μs, type	12 V	25 V	45 V	60 V
Protection level wire-wire 8/20 μs, type	12 V	25 V	45 V	60 V
Protection level wire-PE 1kV/μs, type	450 V	450 V	450 V	450 V
Protection level wire-PE 8/20 μs, type	< 800 V	< 800 V	< 800 V	< 800 V

Ordering data

with function indicator	Type	VSPC 1CL 5VDC R	VSPC 1CL 12VDC R	VSPC 1CL 24VDC R	VSPC 1CL 24VAC R
Order No.		8951530000	8951540000	8951550000	8951560000
Qty.		1	1	1	1
Note					



VARITECTOR SPC

VSPC 2CL - protection for two analogue signals

- Optional monitoring function with status indicator and alert function
- Pluggable arrester (impedance-neutral plugging/unplugging without interruption)
- Can be tested with the V-TEST testing device
- Optional version with floating earth PE connection to avoid voltage potential differences
- Usable in accordance with installations standard IEC 62305
- Tested in accordance with IEC/EN 61643-21: D1,C1,C2,C3
- Integrated PE foot, safely discharges up to 20 kA (8/20 μ s) and 2.5 kA (10/350 μ s) to PE



C

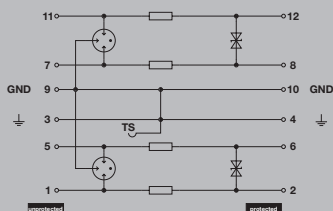

Complete module, direct earthing

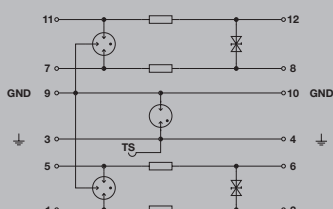

Complete module, indirect earthing

Technical data

Volume resistance	2.20 Ω
Overload - failure mode	Modus 2
Requirements category acc. to IEC 61643-21	C1, C2, C3, D1
Surge current-carrying capacity C1	< 1 kA 8/20 μ s
Surge current-carrying capacity C2	5 kA 8/20 μ s
Surge current-carrying capacity C3	100 A 10/1000 μ s
Surge current-carrying capacity D1	2.5 kA 10/350 μ s
Discharge current $I_{(8/20 \mu s)}$ wire-wire/wire-PE/GND-PE	2.5 kA / 2.5 kA / 2.5 kA
Discharge $I_{max (8/20 \mu s)}$ wire-wire/wire-PE/GND-PE	10 kA / 2 x 10 kA / 10 kA
Lightning test $I_{imp (10/350 \mu s)}$ wire-wire/wire-PE/GND-PE	2.5 kA / 2.5 kA / 2.5 kA
Type of connection	Pluggable in VSPC BASE
Storage temperature	-40 °C...80 °C
Ambient temperature (operational)	-40 °C...70 °C
Protection degree	IP20
Failure probability	
Ages	45
MTTF	2537
SIL in compliance with IEC 61508	3
Approvals	
Approvals	CE; CSAEX; FUSAFETY; UL
Standards	IEC 61643-21, HART-compatible

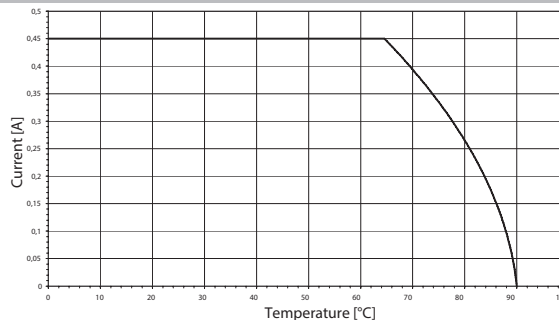

Dimensions of complete module (arrester + base element) **no remote sig. contact**

Height x width x depth mm 90 / 17.8 / 69

Note

The associated VSPC base element should be ordered with this. The dimension information provided refers to the complete module.

Base elements / base to arresters



Ordering data for base

Description	Type	Qty.	Order No.
Base element, indirect earthing / floating earth FG	VSPC BASE 2CL FG	1	8924270000
Base element, direct earthing	VSPC BASE 2CL	1	8924710000

Note

Technical data can be found at the beginning of the VARITECTOR SPC section.

VSPC 2CL - arrester / plug-in elements



Ordering data	VSPC 2CL 5 V DC	VSPC 2CL 12 V DC	VSPC 2CL 24 V DC	VSPC 2CL 24 V AC
Rated voltage (AC)				24 V
Rated voltage (DC)	5 V	12 V	24 V	24 V
Max. continuous voltage, U _c (AC)				28 V
Max. continuous voltage, U _c (DC)	6.4 V	15 V	28 V	40 V
Rated current I _n	450 mA	450 mA	450 mA	450 mA
Input attenuation	730 KHz	1.7 MHz	2.3 MHz	2.7 MHz
Pulse-reset capacity	≤ 20 ms	≤ 20 ms	≤ 30 ms	≤ 450 ms
Residual voltage, U _p typical	< 800 V	< 800 V	< 800 V	< 800 V
Protection level				
Protection level wire-wire 1kV/μs, type	12 V	25 V	45 V	60 V
Protection level wire-wire 8/20 μs, type	12 V	25 V	45 V	60 V
Protection level wire-PE 1kV/μs, type	450 V	450 V	450 V	450 V
Protection level wire-PE 8/20 μs, type	< 800 V	< 800 V	< 800 V	< 800 V

Ordering data	VSPC 2CL 5VDC	VSPC 2CL 12VDC	VSPC 2CL 24VDC	VSPC 2CL 24VAC
without function indicator				
Type	VSPC 2CL 5VDC	VSPC 2CL 12VDC	VSPC 2CL 24VDC	VSPC 2CL 24VAC
Order No.	8924400000	8924440000	8924470000	8924490000
Qty.	1	1	1	1
Note				

Ordering data	VSPC 2CL 48 V AC
Rated voltage (AC)	48 V
Rated voltage (DC)	68 V
Max. continuous voltage, U _c (AC)	60 V
Max. continuous voltage, U _c (DC)	85 V
Rated current I _n	350 mA
Input attenuation	4.8 MHz
Pulse-reset capacity	≤ 500 ms
Residual voltage, U _p typical	< 800 V
Protection level	
Protection level wire-wire 1kV/μs, type	85 V
Protection level wire-wire 8/20 μs, type	85 V
Protection level wire-PE 1kV/μs, type	450 V
Protection level wire-PE 8/20 μs, type	< 800 V

Ordering data	VSPC 2CL 48VAC
without function indicator	
Type	VSPC 2CL 48VAC
Order No.	8951490000
Qty.	1
Note	

VARITECTOR SPC

VSPC 2CL - protection for two analogue signals with remote alert

- Optional monitoring function with status indicator and alert function
- Pluggable arrester (impedance-neutral plugging/unplugging without interruption)
- Can be tested with the V-TEST testing device
- Optional version with floating earth PE connection to avoid voltage potential differences
- Usable in accordance with installations standard IEC 62305
- Tested in accordance with IEC/EN 61643-21: D1,C1,C2,C3
- Integrated PE foot, safely discharges up to 20 kA (8/20 μ s) and 2.5 kA (10/350 μ s) to PE



C

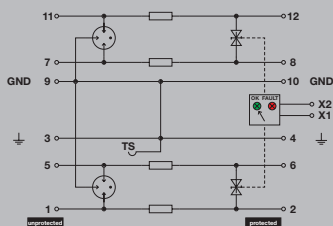

Complete module, direct earthing, with remote alert

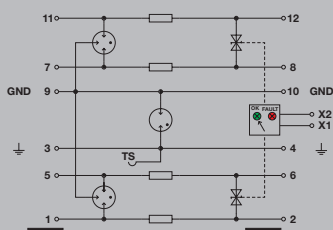

Complete module, indirect earthing, with remote alert

Technical data

Volume resistance	2.20 Ω
Overload - failure mode	Modus 2
Requirements category acc. to IEC 61643-21	C1, C2, C3, D1
Surge current-carrying capacity C1	< 1 kA 8/20 μ s
Surge current-carrying capacity C2	5 kA 8/20 μ s
Surge current-carrying capacity C3	100 A 10/1000 μ s
Surge current-carrying capacity D1	2.5 kA 10/350 μ s
Discharge current $I_{(8/20 \mu s)}$ wire-wire/wire-PE/GND-PE	2.5 kA / 2.5 kA / 2.5 kA
Discharge $I_{max} (8/20 \mu s)$ wire-wire/wire-PE/GND-PE	10 kA / 2 x 10 kA / 10 kA
Lightning test $I_{imp} (10/350 \mu s)$ wire-wire/wire-PE/GND-PE	2.5 kA / 2.5 kA / 2.5 kA
Type of connection	Pluggable in VSPC BASE
Storage temperature	-40 °C...80 °C
Ambient temperature (operational)	-40 °C...70 °C
Protection degree	IP20
Failure probability	
Ages	45
MTTF	2537
SIL in compliance with IEC 61508	3
Approvals	
Approvals	CE; CSAEX; FUSAFETY; UL
Standards	IEC 61643-21, HART-compatible

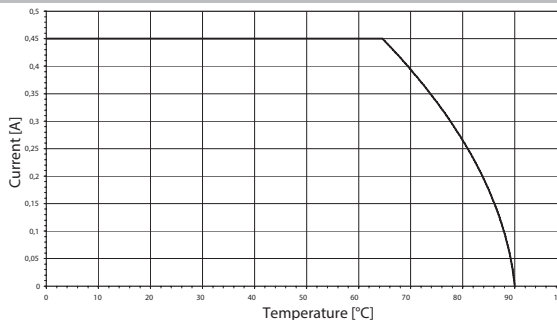

Dimensions of complete module (arrester + base element)	with remote signalling (R)
Height x width x depth	mm 98 / 17.8 / 69

Note The associated VSPC base element should be ordered with this. The dimension information provided refers to the complete module.

Base elements / base to arresters



Ordering data for base

Description	Type	Qty.	Order No.
Base element, direct earthing with remote contact	VSPC BASE 2CL R	1	8951710000
Base element, indirect earthing with remote contact	VSPC BASE 2CL FG R	1	8951720000

Note Technical data can be found at the beginning of the VARITECTOR SPC section. Order with VSPC CONTROL UNIT.

**VSPC 2CL - arrester / plug-in components
with remote alert**



Ordering data

	VSPC 2CL 5 V DC R	VSPC 2CL 12 V DC R	VSPC 2CL 24 V DC R	VSPC 2CL 24 V AC R
Rated voltage (AC)				24 V
Rated voltage (DC)	5 V	12 V	24 V	24 V
Max. continuous voltage, U_c (AC)				28 V
Max. continuous voltage, U_c (DC)	6.4 V	15 V	28 V	40 V
Rated current I_N	450 mA	450 mA	450 mA	450 mA
Signalling contact	U _N 250 V AC 0.1 A 1CO at VSPC R with VSPC control unit		U _N 250 V AC 0.1 A 1CO at VSPC R with VSPC control unit	
Optical function display	green = OK; red = arrester is defective - replace		green = OK; red = arrester is defective - replace	
Input attenuation	730 KHz	1.7 MHz	2.3 MHz	2.7 MHz
Pulse-reset capacity	≤ 20 ms	≤ 20 ms	≤ 30 ms	≤ 450 ms
Residual voltage, U_r typical	< 800 V	< 800 V	< 800 V	< 800 V
Protection level				
Protection level wire-wire 1kV/μs, type	12 V	25 V	45 V	60 V
Protection level wire-wire 8/20 μs, type	12 V	25 V	45 V	60 V
Protection level wire-PE 1kV/μs, type	450 V	450 V	450 V	450 V
Protection level wire-PE 8/20 μs, type	< 800 V	< 800 V	< 800 V	< 800 V

Ordering data

with function indicator	Type	VSPC 2CL 5VDC R	VSPC 2CL 12VDC R	VSPC 2CL 24VDC R	VSPC 2CL 24VAC R
Order No.		8951460000	8951470000	8951480000	1093400000
Qty.		1	1	1	1
Note					



VARITECTOR SPC

VSPC 2CL HF - protection for two analogue signals

- Optional monitoring function with status indicator and alert function
- Pluggable arrester (impedance-neutral plugging/unplugging without interruption)
- Can be tested with the V-TEST testing device
- Optional version with floating earth PE connection to avoid voltage potential differences
- Usable in accordance with installations standard IEC 62305
- Tested in accordance with IEC/EN 61643-21: D1,C1,C2,C3
- Integrated PE foot, safely discharges up to 20 kA (8/20 μ s) and 2.5 kA (10/350 μ s) to PE



Technical data

Volume resistance	2.20 Ω
Overload - failure mode	Modus 2
Requirements category acc. to IEC 61643-21	C1, C2, C3, D1
Surge current-carrying capacity C1	< 1 kA 8/20 μ s
Surge current-carrying capacity C2	5 kA 8/20 μ s
Surge current-carrying capacity C3	100 A 10/1000 μ s
Surge current-carrying capacity D1	2.5 kA 10/350 μ s
Discharge current $I_{(8/20 \mu s)}$ wire-wire/wire-PE/GND-PE	2.5 kA / 2.5 kA / 2.5 kA
Discharge $I_{max(8/20 \mu s)}$ wire-wire/wire-PE/GND-PE	10 kA / 2 x 10 kA / 10 kA
Lightning test $I_{imp(10/350 \mu s)}$ wire-wire/wire-PE/GND-PE	2.5 kA / 2.5 kA / 2.5 kA
Type of connection	Pluggable in VSPC BASE
Storage temperature	-40 °C...80 °C
Ambient temperature (operational)	-40 °C...70 °C
Protection degree	IP20
Failure probability	
Ages	45
MTTF	2537
SIL in compliance with IEC 61508	3
Approvals	
Approvals	CE; CSAEX; FUSAFETY; UL
Standards	IEC 61643-21, HART-compatible

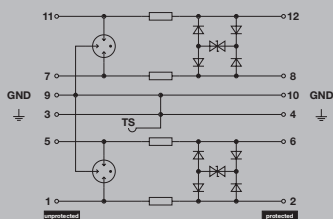

Complete module, direct earthing

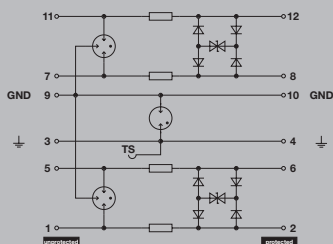

Complete module, indirect earthing

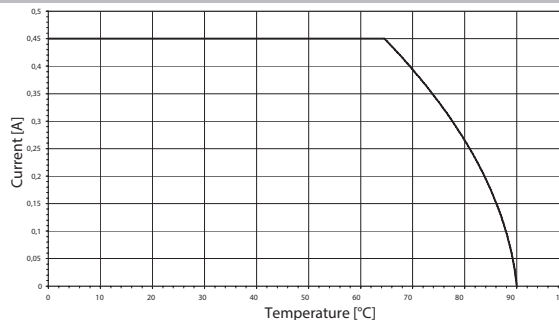

Dimensions of complete module (arrester + base element)	no remote sig. contact
Height x width x depth	mm 90 / 17.8 / 69

Note The associated VSPC base element should be ordered with this. The dimension information provided refers to the complete module.

Base elements / base to arresters



Ordering data for base

Description	Type	Qty.	Order No.
Base element, indirect earthing / floating earth FG	VSPC BASE 2CL FG	1	8924270000
Base element, direct earthing	VSPC BASE 2CL	1	8924710000

Note Technical data can be found at the beginning of the VARITECTOR SPC section.

VSPC 2CL HF - arrester / plug-in components



Ordering data

	VSPC 2CL HF 5 V DC	VSPC 2CL HF 12 V DC	VSPC 2CL HF 24 V DC
Rated voltage (AC)			
Rated voltage (DC)	5 V	12 V	24 V
Max. continuous voltage, U_c (AC)			
Max. continuous voltage, U_c (DC)	6.4 V	15 V	28 V
Rated current I_n	450 mA	450 mA	450 mA
Input attenuation	103 MHz	104 MHz	109 MHz
Pulse-reset capacity	≤ 20 ms	≤ 80 ms	≤ 40 ms
Residual voltage, U_r typical	< 800 V	< 800 V	< 800 V
Protection level			
Protection level wire-wire 1kV/ μ s, type	12 V	25 V	45 V
Protection level wire-wire 8/20 μ s, type	12 V	25 V	45 V
Protection level wire-PE 1kV/ μ s, type	450 V	450 V	450 V
Protection level wire-PE 8/20 μ s, type	< 800 V	< 800 V	< 800 V

Ordering data		VSPC 2CL HF 5VDC	VSPC 2CL HF 12VDC	VSPC 2CL HF 24VDC
without function indicator	Type	VSPC 2CL HF 5VDC	VSPC 2CL HF 12VDC	VSPC 2CL HF 24VDC
	Order No.	8924430000	8924460000	8924510000
	Qty.	1	1	1
Note				



VARITECTOR SPC

VSPC 2CL HF - protection for two analogue signals with remote alert

- Optional monitoring function with status indicator and alert function
- Pluggable arrester (impedance-neutral plugging/unplugging without interruption)
- Can be tested with the V-TEST testing device
- Optional version with floating earth PE connection to avoid voltage potential differences
- Usable in accordance with installations standard IEC 62305
- Tested in accordance with IEC/EN 61643-21: D1,C1,C2,C3
- Integrated PE foot, safely discharges up to 20 kA (8/20 μ s) and 2.5 kA (10/350 μ s) to PE

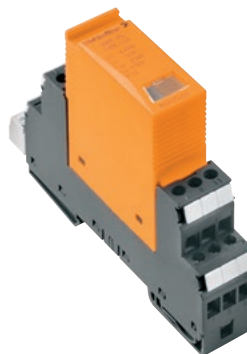

Technical data

Volume resistance	2.20 Ω
Overload - failure mode	Modus 2
Requirements category acc. to IEC 61643-21	C1, C2, C3, D1
Surge current-carrying capacity C1	< 1 kA 8/20 μ s
Surge current-carrying capacity C2	5 kA 8/20 μ s
Surge current-carrying capacity C3	100 A 10/1000 μ s
Surge current-carrying capacity D1	2.5 kA 10/350 μ s
Discharge current $I_{(8/20 \mu s)}$ wire-wire/wire-PE/GND-PE	2.5 kA / 2.5 kA / 2.5 kA
Discharge $I_{max(8/20 \mu s)}$ wire-wire/wire-PE/GND-PE	10 kA / 2 x 10 kA / 10 kA
Lightning test $I_{imp(10/350 \mu s)}$ wire-wire/wire-PE/GND-PE	2.5 kA / 2.5 kA / 2.5 kA
Type of connection	Pluggable in VSPC BASE
Storage temperature	-40 °C...80 °C
Ambient temperature (operational)	-40 °C...70 °C
Protection degree	IP20
Failure probability	
Ages	45
MTTF	2537
SIL in compliance with IEC 61508	3
Approvals	
Approvals	CE; CSAEX; FUSAFETY; UL
Standards	IEC 61643-21, HART-compatible

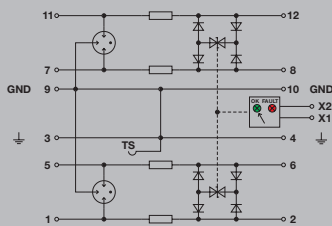

Complete module, direct earthing, with remote alert

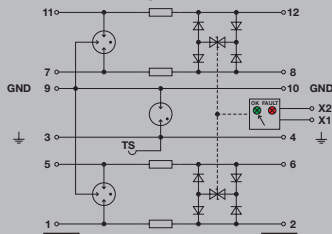

Complete module, indirect earthing, with remote alert

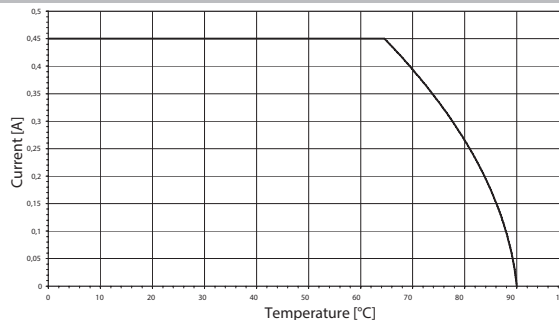

Dimensions of complete module (arrester + base element)	with remote signalling (R)
Height x width x depth	mm 98 / 17.8 / 69

Note The associated VSPC base element should be ordered with this. The dimension information provided refers to the complete module.

Base elements / base to arresters



Ordering data for base

Description	Type	Qty.	Order No.
Base element, direct earthing with remote contact	VSPC BASE 2CL R	1	8951710000
Base element, indirect earthing with remote contact	VSPC BASE 2CL FG R	1	8951720000

Note Technical data can be found at the beginning of the VARITECTOR SPC section. Order with VSPC CONTROL UNIT.

**VSPC 2CL HF - arrester / plug-in components
with remote alert**



Ordering data	VSPC 2CL HF 5 V DC R	VSPC 2CL HF 12 V DC R	VSPC 2CL HF 24 V DC R
Rated voltage (AC)			
Rated voltage (DC)	5 V	12 V	24 V
Max. continuous voltage, U _c (AC)			
Max. continuous voltage, U _c (DC)	6.4 V	15 V	28 V
Rated current I _N	450 mA	450 mA	450 mA
Signalling contact	U _N 250 V AC 0.1 A 1CO at VSPC R with VSPC control unit	U _N 250 V AC 0.1 A 1CO at VSPC R with VSPC control unit	U _N 250 V AC 0.1 A 1CO at VSPC R with VSPC control unit
Optical function display	green = OK; red = arrester is defective - replace	green = OK; red = arrester is defective - replace	green = OK; red = arrester is defective - replace
Input attenuation	103 MHz	104 MHz	109 MHz
Pulse-reset capacity	≤ 20 ms	≤ 80 ms	≤ 40 ms
Residual voltage, U _r typical	< 800 V	< 800 V	< 800 V
Protection level			
Protection level wire-wire 1kV/μs, type	12 V	25 V	45 V
Protection level wire-wire 8/20 μs, type	12 V	25 V	45 V
Protection level wire-PE 1kV/μs, type	450 V	450 V	450 V
Protection level wire-PE 8/20 μs, type	< 800 V	< 800 V	< 800 V
Ordering data			
with function indicator	Type	Type	Type
	VSPC 2CL HF 5VDC R	VSPC 2CL HF 12VDC R	VSPC 2CL HF 24VDC R
	Order No.	Order No.	Order No.
	8951680000	8951690000	8951700000
	Qty.	Qty.	Qty.
	1	1	1
Note			

VARITECTOR SPC

VSPC 1CL PW - combination of current loop protection and end device protection

- Pluggable arrester (impedance-neutral plugging/unplugging without interruption)
- Can be tested with V-TEST testing device
- Version with floating-earth PE connection for avoiding voltage potential differences
- Usable in accordance with installation standard IEC 62305
- Tested in accordance with IEC/EN 61643-21: D1, C1, C2, C3
- Tested in accordance with IEC/EN 61643-11 Class III
- Integrated PE foot, safely discharges up to 20 kA (8/20 μ s) and 2.5 kA (10/350 μ s) to PE



C

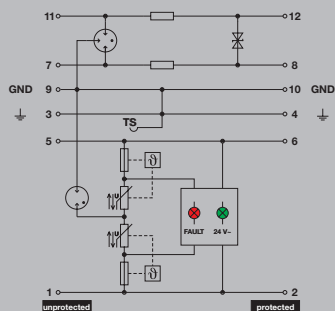

Complete module, direct earthing

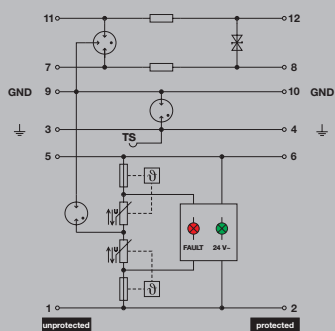

Complete module, indirect earthing

Technical data

Measurement and control protection data	
Volume resistance	2.20 Ω
Rated current	450 mA
Overload - failure mode	Modus 2
Requirements category acc. to IEC 61643-21	C1, C2, C3, D1
Surge current-carrying capacity C1	< 1 kA 8/20 μ s
Surge current-carrying capacity C2	5 kA 8/20 μ s
Surge current-carrying capacity C3	100 A 10/1000 μ s
Surge current-carrying capacity D1	2.5 kA 10/350 μ s
Standards	IEC 61643-21, HART-compatible
Discharge current I_L (8/20 μ s) wire-wire	2.5 kA / 2.5 kA / 2.5 kA
Discharge I_{max} (8/20 μ s) wire-wire/wire-PE/GND-PE	10 kA / 10 kA / 10 kA
Lightning test current, I_{imp} (10/350 μ s) wire-wire	2.5 kA / 2.5 kA / 2.5 kA
End device protection data	
Combined pulse U_{oc}	6 kV
Max. continuous voltage, U_c (DC)	38 V
Residual voltage, U_p typical	\leq 0.8 kV
Rated current I_N	10 A
General data	
Type of connection	Pluggable in VSPC BASE
Storage temperature	-40 °C...80 °C
Requirements category acc. to IEC 61643-21	C1, C2, C3, D1
Ambient temperature (operational)	-40 °C...70
Protection degree	IP20
Failure probability	
Ages	45
MTTF	2537
SIL in compliance with IEC 61508	3
Approvals	
Approvals	CE; FUSAFETY; UL
Standards	IEC 61643-21, HART-compatible

Dimensions of complete module (arrester + base element)	no remote sig. contact
Height x width x depth	mm 90 / 17.8 / 69

Note The associated VSPC base element should be ordered with this. The dimension information provided refers to the complete module.

Base elements / base to arresters



Ordering data for base

Description	Type	Qty.	Order No.
Base element, indirect earthing / floating earth FG	VSPC BASE 1CL PW FG	1	1105700000
Base element, direct earthing	VSPC BASE 1CL PW	1	1070230000

Note Technical data can be found at the beginning of the VARITECTOR SPC section.

VSPC 1CL PW - arrester / plug-in components



Ordering data

VSPC 1CL PW 24 V DC

Rated voltage (AC)	24 V
Rated voltage (DC)	24 V
Max. continuous voltage, U _c (AC)	27 V
Max. continuous voltage, U _c (DC)	38 V
Signalling contact	No
Optical function display	For Class III protection, green = OK; red = arrester is defective - replace
Input attenuation	3 MHz
Pulse-reset capacity	≤ 10 ms
Residual voltage, U _r typical	≤ 0.8 kV
Protection level	
Protection level wire-wire 1kV/μs, type	60 V
Protection level wire-wire 8/20 μs, type	60 V
Protection level wire-PE 1kV/μs, type	450 V
Protection level wire-PE 8/20 μs, type	≤ 0.8 kV

Ordering data

without function indicator	Type	VSPC 1CL PW 24V
	Order No.	8951510000
	Qty.	1
Note		



VARITECTOR SPC

VSPC 2SL - protection for two binary signals

- Optional monitoring function with status indicator and alert function
- Pluggable arrester (impedance-neutral plugging/unplugging without interruption)
- Can be tested with the V-TEST testing device
- Optional version with floating earth PE connection to avoid voltage potential differences
- Usable in accordance with installations standard IEC 62305
- Tested in accordance with IEC/EN 61643-21: D1,C1,C2,C3
- Integrated PE foot, safely discharges up to 20 kA (8/20 μ s) and 2.5 kA (10/350 μ s) to PE



C

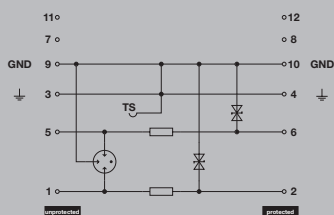

Complete module, direct earthing

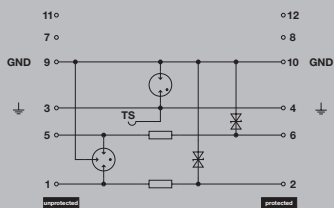

Complete module, indirect earthing

Technical data

Volume resistance	4.7 Ω
Overload - failure mode	Modus 2
Requirements category acc. to IEC 61643-21	C1, C2, C3, D1
Surge current-carrying capacity C1	< 1 kA 8/20 μ s
Surge current-carrying capacity C2	5 kA 8/20 μ s
Surge current-carrying capacity C3	100 A 10/1000 μ s
Surge current-carrying capacity D1	2.5 kA 10/350 μ s
Discharge current $I_{(8/20 \mu s)}$ wire-wire/wire-PE/GND-PE	2.5 kA / 2.5 kA / 2.5 kA
Discharge $I_{max(8/20 \mu s)}$ wire-wire/wire-PE/GND-PE	10 kA / 10 kA / 10 kA
Lightning test $I_{imp(10/350 \mu s)}$ wire-wire/wire-PE/GND-PE	2.5 kA / 2.5 kA / 2.5 kA
Type of connection	Pluggable in VSPC BASE
Storage temperature	-40 °C...80 °C
Ambient temperature (operational)	-40 °C...70
Protection degree	IP20
Failure probability	
Ages	43
MTTF	2665
SIL in compliance with IEC 61508	2
Approvals	
Approvals	CE; CSAEX; FUSAFETY; UL
Standards	IEC 61643-21

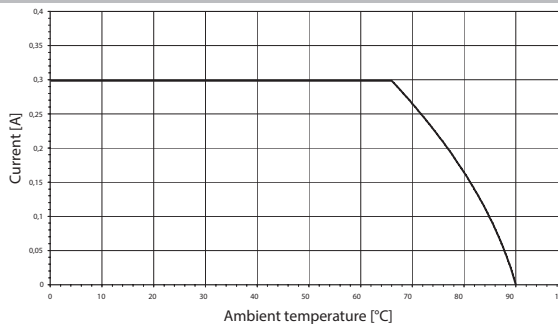

Dimensions of complete module (arrester + base element) no remote sig. contact

Height x width x depth mm 90 / 17.8 / 69

Note

The associated VSPC base element should be ordered with this. The dimension information provided refers to the complete module.

Base elements / base to arresters



Ordering data for base

Description	Type	Qty.	Order No.
Base element, indirect earthing / floating earth FG	VSPC BASE 2SL FG	1	8924280000
Base element, direct earthing	VSPC BASE 2SL	1	8924720000

Note

Technical data can be found at the beginning of the VARITECTOR SPC section.

VSPC 2SL - arrester / plug-in components



Ordering data	VSPC 2SL 5 V DC	VSPC 2SL 12 V DC	VSPC 2SL 24 V DC	VSPC 2SL 48 V AC
Rated voltage (AC)				48 V
Rated voltage (DC)	5 V	12 V	24 V	68 V
Max. continuous voltage, U_c (AC)				60 V
Max. continuous voltage, U_c (DC)	6.4 V	15 V	28 V	85 V
Rated current I_n	300 mA	300 mA	300 mA	250 mA
Input attenuation	1.2 MHz	2.5 MHz	2.7 MHz	8.7 MHz
Pulse-reset capacity	≤ 20 ms	≤ 20 ms	≤ 30 ms	≤ 60 ms
Residual voltage, U_r typical	< 200 V	< 200 V	250 V	≤ 300 V
Protection level				
Protection level wire-wire 1kV/ μ s, type	25 V	45 V	80 V	210 V
Protection level wire-wire 8/20 μ s, type	25 V	45 V	80 V	80 V
Protection level wire-PE 1kV/ μ s, type	12 V	25 V	40 V	85 V
Protection level wire-PE 8/20 μ s, type	< 200 V	< 200 V	250 V	≤ 300 V

Ordering data	VSPC 2SL 5VDC	VSPC 2SL 12VDC	VSPC 2SL 24VDC	VSPC 2SL 48VAC
without function indicator	Type			
	Order No.	8924210000	8924230000	8924330000
	Qty.	1	1	1
Note				

Ordering data	VSPC 2SL 24 V AC
Rated voltage (AC)	24 V
Rated voltage (DC)	34 V
Max. continuous voltage, U_c (AC)	28 V
Max. continuous voltage, U_c (DC)	39 V
Rated current I_n	300 mA
Input attenuation	5.5 MHz
Pulse-reset capacity	≤ 60 ms
Residual voltage, U_r typical	250 V
Protection level	
Protection level wire-wire 1kV/ μ s, type	110 V
Protection level wire-wire 8/20 μ s, type	80 V
Protection level wire-PE 1kV/ μ s, type	60 V
Protection level wire-PE 8/20 μ s, type	250 V

Ordering data	VSPC 2SL 24VAC
without function indicator	Type
	Order No.
	Qty.
Note	

VARITECTOR SPC

VSPC 2SL - protection for two binary signals with remote alert

- Optional monitoring function with status indicator and alert function
- Pluggable arrester (impedance-neutral plugging/unplugging without interruption)
- Can be tested with the V-TEST testing device
- Optional version with floating earth PE connection to avoid voltage potential differences
- Usable in accordance with installations standard IEC 62305
- Tested in accordance with IEC/EN 61643-21: D1,C1,C2,C3
- Integrated PE foot, safely discharges up to 20 kA (8/20 μ s) and 2.5 kA (10/350 μ s) to PE



C

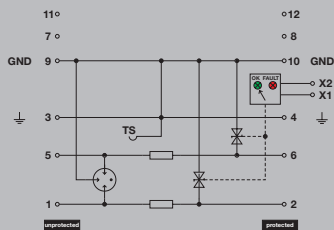

Complete module, direct earthing, with remote alert

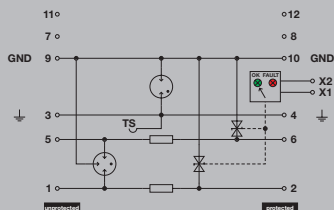

Complete module, indirect earthing, with remote alert

Technical data

Volume resistance	4.7 Ω
Overload - failure mode	Modus 2
Requirements category acc. to IEC 61643-21	C1, C2, C3, D1
Surge current-carrying capacity C1	< 1 kA 8/20 μ s
Surge current-carrying capacity C2	5 kA 8/20 μ s
Surge current-carrying capacity C3	100 A 10/1000 μ s
Surge current-carrying capacity D1	2.5 kA 10/350 μ s
Discharge current $I_{(8/20 \mu s)}$ wire-wire/wire-PE/GND-PE	2.5 kA / 2.5 kA / 2.5 kA
Discharge $I_{max(8/20 \mu s)}$ wire-wire/wire-PE/GND-PE	10 kA / 10 kA / 10 kA
Lightning test $I_{imp(10/350 \mu s)}$ wire-wire/wire-PE/GND-PE	2.5 kA / 2.5 kA / 2.5 kA
Type of connection	Pluggable in VSPC BASE
Storage temperature	-40 °C...80 °C
Ambient temperature (operational)	-40 °C...70
Protection degree	IP20
Failure probability	
Ages	43
MTTF	2665
SIL in compliance with IEC 61508	2
Approvals	
Approvals	CE; CSAEX; FUSAFETY; UL
Standards	IEC 61643-21

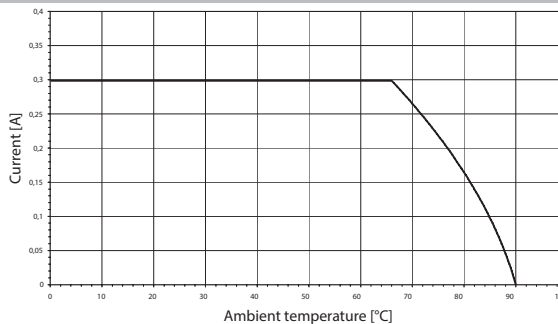

Dimensions of complete module (arrester + base element) with remote signalling (R)

Height x width x depth mm 98 / 17.8 / 69

Note

The associated VSPC base element should be ordered with this. The dimension information provided refers to the complete module.

Base elements / base to arresters



Ordering data for base

Description	Type	Qty.	Order No.
Base element, direct earthing with remote contact	VSPC BASE 2SL R	1	8951770000
Base element, indirect earthing with remote contact	VSPC BASE 2SL FG R	1	8951780000

Note

Technical data can be found at the beginning of the VARITECTOR SPC section.
Order with VSPC CONTROL UNIT.

VSPC 2SL - arrester / plug-in elements with remote alert



Lightning and surge protection for instrumentation and control (I & C)

Ordering data

	VSPC 2SL 5 V DC R	VSPC 2SL 12 V DC R	VSPC 2SL 24 V DC R	VSPC 2SL 24 V AC R
Rated voltage (AC)				24 V
Rated voltage (DC)	5 V	12 V	24 V	34 V
Max. continuous voltage, U_c (AC)				28 V
Max. continuous voltage, U_c (DC)	6.4 V	15 V	28 V	40 V
Rated current I_N	300 mA	300 mA	300 mA	300 mA
Signalling contact	U _N 250 V AC 0.1 A 1CO at VSPC R with VSPC control unit		U _N 250 V AC 0.1 A 1CO at VSPC R with VSPC control unit	
Optical function display	green = OK; red = arrester is defective - replace		green = OK; red = arrester is defective - replace	
Input attenuation	1.2 MHz	2.5 MHz	2.7 MHz	5.5 MHz
Pulse-reset capacity	≤ 20 ms	≤ 20 ms	≤ 30 ms	≤ 60 ms
Residual voltage, U_r typical	< 200 V	< 200 V	< 200 V	250 V
Protection level				
Protection level wire-wire 1kV/μs, type	25 V	45 V	80 V	110 V
Protection level wire-wire 8/20 μs, type	25 V	45 V	80 V	80 V
Protection level wire-PE 1kV/μs, type	12 V	25 V	40 V	60 V
Protection level wire-PE 8/20 μs, type	< 200 V	< 200 V	< 200 V	250 V

Ordering data		VSPC 2SL 5VDC R	VSPC 2SL 12VDC R	VSPC 2SL 24VDC R	VSPC 2SL 24VAC R
with function indicator	Type	VSPC 2SL 5VDC R	VSPC 2SL 12VDC R	VSPC 2SL 24VDC R	VSPC 2SL 24VAC R
	Order No.	8951610000	8951620000	8951630000	8951640000
	Qty.	1	1	1	1
Note					



VARITECTOR SPC

VSPC 4SL - protection for four binary signals

- Optional monitoring function with status indicator and alert function
- Pluggable arrester (impedance-neutral plugging/unplugging without interruption)
- Can be tested with the V-TEST testing device
- Optional version with floating earth PE connection to avoid voltage potential differences
- Usable in accordance with installations standard IEC 62305
- Tested in accordance with IEC/EN 61643-21: D1,C1,C2,C3
- Integrated PE foot, safely discharges up to 20 kA (8/20 μ s) and 2.5 kA (10/350 μ s) to PE

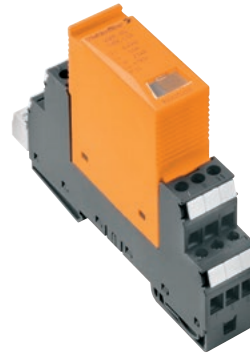

Technical data

Volume resistance	4.7 Ω
Overload - failure mode	Modus 2
Requirements category acc. to IEC 61643-21	C1, C2, C3, D1
Surge current-carrying capacity C1	< 1 kA 8/20 μ s
Surge current-carrying capacity C2	5 kA 8/20 μ s
Surge current-carrying capacity C3	100 A 10/1000 μ s
Surge current-carrying capacity D1	2.5 kA 10/350 μ s
Discharge current I_t (8/20 μ s) wire-wire/wire-PE/GND-PE	2.5 kA / 2.5 kA / 2.5 kA
Discharge I_{max} (8/20 μ s) wire-wire/wire-PE/GND-PE	10 kA / 10 kA / 10 kA
Lightning test I_{imp} (10/350 μ s) wire-wire/wire-PE/GND-PE	2.5 kA / 2.5 kA / 2.5 kA
Type of connection	Pluggable in VSPC BASE
Storage temperature	-40 °C...80 °C
Ambient temperature (operational)	-40 °C...70
Protection degree	IP20
Failure probability	
Ages	43
MTTF	2665
SIL in compliance with IEC 61508	2
Approvals	
Approvals	CE; CSAEX; FUSAFETY; UL
Standards	IEC 61643-21

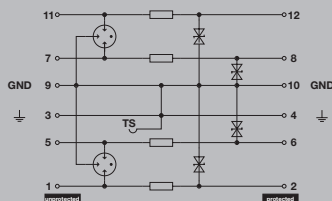

Complete module, direct earthing

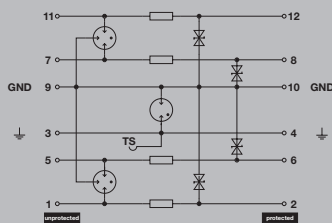

Complete module, indirect earthing

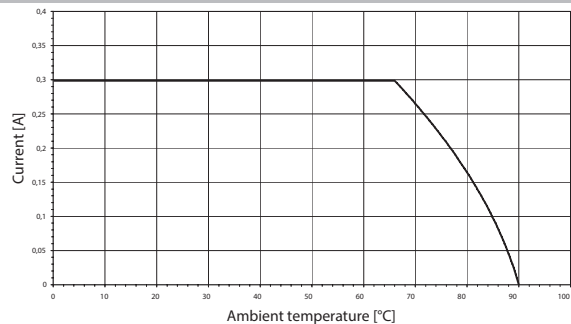

Dimensions of complete module (arrester + base element) no remote sig. contact

Height x width x depth mm 90 / 17.8 / 69

Note

The associated VSPC base element should be ordered with this. The dimension information provided refers to the complete module.

Base elements / base to arresters



Ordering data for base

Description	Type	Qty.	Order No.
Base element, indirect earthing / floating earth FG	VSPC BASE 4SL FG	1	8924260000
Base element, direct earthing	VSPC BASE 4SL	1	8924700000

Note

Technical data can be found at the beginning of the VARITECTOR SPC section.

VSPC 4SL - arrester / plug-in elements



Ordering data	VSPC 4SL 5 V DC	VSPC 4SL 12 V DC	VSPC 4SL 24 V DC	VSPC 4SL 48 V AC
Rated voltage (AC)				48 V
Rated voltage (DC)	5 V	12 V	24 V	68 V
Max. continuous voltage, U_c (AC)				60 V
Max. continuous voltage, U_c (DC)	6.4 V	15 V	28 V	85 V
Rated current I_n	300 mA	300 mA	300 mA	250 mA
Input attenuation	1.2 MHz	2.5 MHz	4 MHz	8.7 MHz
Pulse-reset capacity	≤ 20 ms	≤ 20 ms	≤ 30 ms	≤ 60 ms
Residual voltage, U_r typical	< 200 V	< 200 V	250 V	≤ 300 V
Protection level				
Protection level wire-wire 1kV/ μ s, type	25 V	45 V	80 V	210 V
Protection level wire-wire 8/20 μ s, type	25 V	45 V	80 V	80 V
Protection level wire-PE 1kV/ μ s, type	12 V	25 V	40 V	85 V
Protection level wire-PE 8/20 μ s, type	< 200 V	< 200 V	250 V	≤ 300 V

Ordering data	VSPC 4SL 5VDC	VSPC 4SL 12VDC	VSPC 4SL 24VDC	VSPC 4SL 48VAC
without function indicator				
Type	VSPC 4SL 5VDC	VSPC 4SL 12VDC	VSPC 4SL 24VDC	VSPC 4SL 48VAC
Order No.	8924200000	8924220000	8924320000	8924360000
Qty.	1	1	1	1
Note				

Ordering data	VSPC 4SL 24 V AC	VSPC 4SL 60 V AC
Rated voltage (AC)	24 V	60 V
Rated voltage (DC)	34 V	85 V
Max. continuous voltage, U_c (AC)	28 V	72 V
Max. continuous voltage, U_c (DC)	40 V	101 V
Rated current I_n	300 mA	200 mA
Input attenuation	2.7 MHz	13.6 MHz
Pulse-reset capacity	≤ 40 ms	≤ 60 ms
Residual voltage, U_r typical	250 V	350 V
Protection level		
Protection level wire-wire 1kV/ μ s, type	110 V	280 V
Protection level wire-wire 8/20 μ s, type	80 V	80 V
Protection level wire-PE 1kV/ μ s, type	60 V	110 V
Protection level wire-PE 8/20 μ s, type	250 V	350 V

Ordering data	VSPC 4SL 24VAC	VSPC 4SL 60VAC
without function indicator		
Type	VSPC 4SL 24VAC	VSPC 4SL 60VAC
Order No.	8924340000	8924380000
Qty.	1	1
Note		

VARITECTOR SPC

VSPC 4SL - protection for four binary signals with remote alert

- Optional monitoring function with status indicator and alert function
- Pluggable arrester (impedance-neutral plugging/unplugging without interruption)
- Can be tested with the V-TEST testing device
- Optional version with floating earth PE connection to avoid voltage potential differences
- Usable in accordance with installations standard IEC 62305
- Tested in accordance with IEC/EN 61643-21: D1,C1,C2,C3
- Integrated PE foot, safely discharges up to 20 kA (8/20 μ s) and 2.5 kA (10/350 μ s) to PE



C

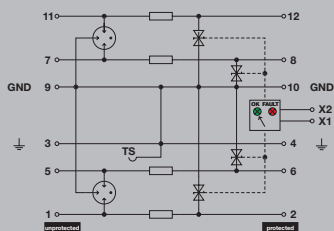

Complete module, direct earthing, with remote alert

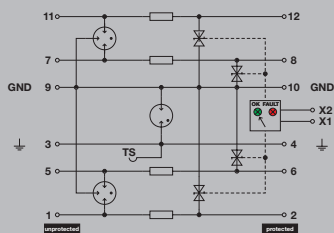

Complete module, indirect earthing, with remote alert

Technical data

Volume resistance	4.7 Ω
Overload - failure mode	Modus 2
Requirements category acc. to IEC 61643-21	C1, C2, C3, D1
Surge current-carrying capacity C1	< 1 kA 8/20 μ s
Surge current-carrying capacity C2	5 kA 8/20 μ s
Surge current-carrying capacity C3	100 A 10/1000 μ s
Surge current-carrying capacity D1	2.5 kA 10/350 μ s
Discharge current I_{imp} (8/20 μ s) wire-wire/wire-PE/GND-PE	2.5 kA / 2.5 kA / 2.5 kA
Discharge I_{max} (8/20 μ s) wire-wire/wire-PE/GND-PE	10 kA / 10 kA / 10 kA
Lightning test I_{imp} (10/350 μ s) wire-wire/wire-PE/GND-PE	2.5 kA / 2.5 kA / 2.5 kA
Type of connection	Pluggable in VSPC BASE
Storage temperature	-40 °C...80 °C
Ambient temperature (operational)	-40 °C...70
Protection degree	IP20
Failure probability	
Ages	43
MTTF	2665
SIL in compliance with IEC 61508	2
Approvals	
Approvals	CE; CSAEX; FUSAFETY; UL
Standards	IEC 61643-21

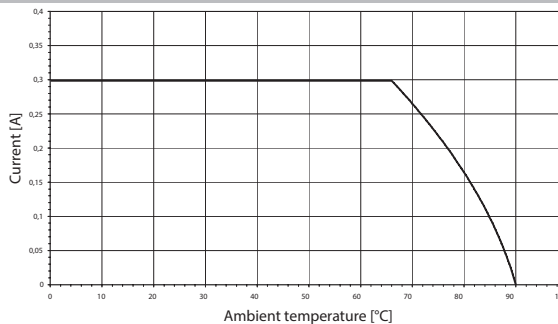

Dimensions of complete module (arrester + base element)	with remote signalling (R)
Height x width x depth	mm 98 / 17.8 / 69

Note The associated VSPC base element should be ordered with this. The dimension information provided refers to the complete module.

Base elements / base to arresters



Ordering data for base

Description	Type	Qty.	Order No.
Base element, direct earthing with remote contact	VSPC BASE 4SL R	1	8951750000
Base element, indirect earthing with remote contact	VSPC BASE 4SL FG R	1	8951760000

Note Technical data can be found at the beginning of the VARITECTOR SPC section. Order with VSPC CONTROL UNIT.

VSPC 4SL - arrester / plug-in elements with remote alert



Ordering data

	VSPC 4SL 5 V DC R	VSPC 4SL 12 V DC R	VSPC 4SL 24 V DC R	VSPC 4SL 24 V AC R
Rated voltage (AC)				24 V
Rated voltage (DC)	5 V	12 V	24 V	34 V
Max. continuous voltage, U_c (AC)				28 V
Max. continuous voltage, U_c (DC)	6.4 V	15 V	28 V	40 V
Rated current I_N	300 mA	300 mA	300 mA	300 mA
Signalling contact	U _N 250 V AC 0.1 A 1CO at VSPC R with VSPC control unit		U _N 250 V AC 0.1 A 1CO at VSPC R with VSPC control unit	
Optical function display	green = OK; red = arrester is defective - replace		green = OK; red = arrester is defective - replace	
Input attenuation	1.2 MHz	2.5 MHz	4 MHz	2.7 MHz
Pulse-reset capacity	≤ 20 ms	≤ 20 ms	≤ 30 ms	≤ 40 ms
Residual voltage, U_r typical	< 200 V	< 200 V	< 200 V	250 V
Protection level				
Protection level wire-wire 1kV/μs, type	25 V	45 V	80 V	110 V
Protection level wire-wire 8/20 μs, type	25 V	45 V	80 V	80 V
Protection level wire-PE 1kV/μs, type	12 V	25 V	40 V	60 V
Protection level wire-PE 8/20 μs, type	< 200 V	< 200 V	< 200 V	250 V

Ordering data		VSPC 4SL 5VDC R	VSPC 4SL 12VDC R	VSPC 4SL 24VDC R	VSPC 4SL 24VAC R
with function indicator	Type	VSPC 4SL 5VDC R	VSPC 4SL 12VDC R	VSPC 4SL 24VDC R	VSPC 4SL 24VAC R
	Order No.	8951570000	8951580000	8951590000	8951600000
	Qty.	1	1	1	1
Note					



VARITECTOR SPC

VSPC 4 SL WIRE - protection for 3/4-wire signals

- Protection of measuring bridge signals
- Pluggable arrester (impedance-neutral plugging/unplugging without interruption)
- Can be tested with the V-TEST testing device
- Version with floating-earth PE connection for avoiding voltage potential differences
- Space-saving design for 4 binary signals
- Usable in accordance with installations standard IEC 62305
- Tested in accordance with IEC/EN 61643-21: D1,C1,C2,C3
- Integrated PE foot, safely discharges up to 20 kA (8/20 μs) and 2.5 kA (10/350 μs) to PE



Technical data

Volume resistance	0.20 Ω
Overload - failure mode	Modus 2
Requirements category acc. to IEC 61643-21	C1, C2, C3, D1
Surge current-carrying capacity C1	< 1 kA 8/20 μs
Surge current-carrying capacity C2	5 kA 8/20 μs
Surge current-carrying capacity C3	100 A 10/1000 μs
Surge current-carrying capacity D1	2.5 kA 10/350 μs
Discharge current I ₁ (8/20 μs) wire-wire/wire-PE/GND-PE	2.5 kA / 2.5 kA / 2.5 kA
Discharge I _{max} (8/20 μs) wire-wire/wire-PE/GND-PE	10 kA / 10 kA / 10 kA
Lightning test I _{imp} (10/350 μs) wire-wire/wire-PE/GND-PE	2.5 kA / 2.5 kA / 2.5 kA
Type of connection	Pluggable in VSPC BASE
Storage temperature	-40 °C...80 °C
Ambient temperature (operational)	-40 °C...70
Protection degree	IP20
Failure probability	
Ages	43
MTTF	2655
SIL in compliance with IEC 61508	3
Approvals	
Approvals	CE; CSAEX; FUSAFETY; UL
Standards	IEC 61643-21

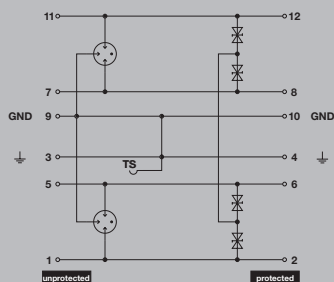

Complete module, direct earthing

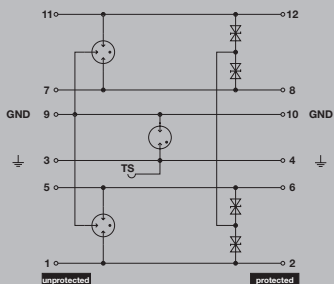

Complete module, indirect earthing

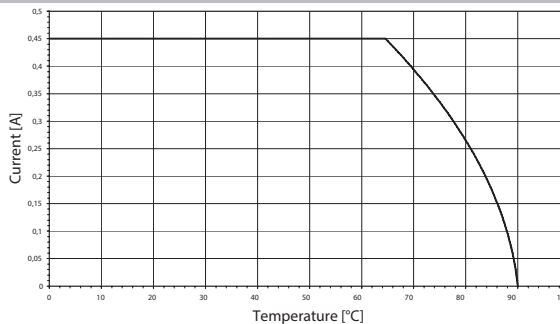

Dimensions of complete module (arrester + base element)	no remote sig. contact
Height x width x depth	mm 90 / 17.8 / 69

Note The associated VSPC base element should be ordered with this. The dimension information provided refers to the complete module.

Base elements / base to arresters



Ordering data for base

Description	Type	Qty.	Order No.
Base element, direct earthing	VSPC BASE 2/4CH	1	8924740000
Base element, indirect earthing / floating earth FG	VSPC BASE 2/4CH FG	1	8924300000

Note Technical data can be found at the beginning of the VARITECTOR SPC section. Order with VSPC CONTROL UNIT.

VSPC 4SL WIRE - arrester / plug-in components



Ordering data

	VSPC 3/4 WIRE 5 V DC	VSPC 3/4 WIRE 24 V DC
Rated voltage (AC)		
Rated voltage (DC)	3 V	24 V
Max. continuous voltage, U _c (AC)		
Max. continuous voltage, U _c (DC)	6.4 V	28 V
Rated current I _n	450 mA	450 mA
Signalling contact	No	No
Optical function display	No	No
Capacitance	2.3 nF	935 pF
Pulse-reset capacity	≤ 20 ms	≤ 30 ms
Residual voltage, U _r typical	< 800 V	< 800 V
Protection level		
Protection level wire-wire 1kV/μs, type	35 V	50 V
Protection level wire-wire 8/20 μs, type	35 V	50 V
Protection level wire-PE 1kV/μs, type	250 V	270 V
Protection level wire-PE 8/20 μs, type	< 800 V	< 800 V

Ordering data		VSPC 3/4WIRE 5VDC	VSPC 3/4WIRE 24VDC
without function indicator	Type		
	Order No.	8924540000	8924550000
	Qty.	1	1
Note			

VARITECTOR SPC

VSPC GDT - with sparkover gap (GDT)

- Pluggable arrester (impedance-neutral plugging/unplugging without interruption)
- Can be tested with the V-TEST testing device
- Version with floating-earth PE connection for avoiding voltage potential differences
- Tested in accordance with IEC 61643-21
- Integrated PE foot, safely discharges up to 20 kA (8/20 μ s) and 2.5 kA (10/350 μ s) to PE



Technical data

Volume resistance	0.20 Ω
Overload - failure mode	Modus 2
Requirements category acc. to IEC 61643-21	C1, C2, C3, D1
Surge current-carrying capacity C1	< 1 kA 8/20 μ s
Surge current-carrying capacity C2	5 kA 8/20 μ s
Surge current-carrying capacity C3	100 A 10/1000 μ s
Surge current-carrying capacity D1	2.5 kA 10/350 μ s
Discharge current I_t (8/20 μ s) wire-wire/wire-PE/GND-PE	2 x 2.5 kA / 2.5 kA / 2.5 kA
Discharge I_{max} (8/20 μ s) wire-wire/wire-PE/GND-PE	2 x 10 kA / / 10 kA
Lightning test I_{imp} (10/350 μ s) wire-wire/wire-PE/GND-PE	2 x 0.2 kA / / 0.2 kA
Type of connection	Pluggable in VSPC BASE
Storage temperature	-40 °C...80 °C
Ambient temperature (operational)	-40 °C...70
Protection degree	IP20
Failure probability	
Ages	11
MTTF	10378
SIL in compliance with IEC 61508	3
Approvals	
Approvals	CE; CSAEX; FUSAFETY; UL
Standards	According to IEC61643-21

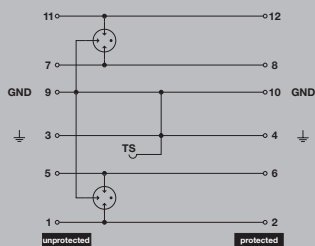

Complete module, direct earthing

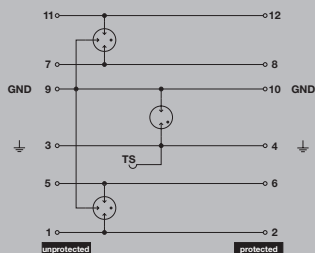

Complete module, indirect earthing

Dimensions of complete module (arrester + base element)	no remote sig. contact
Height x width x depth	mm 90 / 17.8 / 69

Note The associated VSPC base element should be ordered with this. The dimension information provided refers to the complete module.

Base elements / base to arresters



Ordering data for base

Description	Type	Qty.	Order No.
Base element, direct earthing	VSPC BASE 2/4CH	1	8924740000
Base element, indirect earthing / floating earth FG	VSPC BASE 2/4CH FG	1	8924300000

Note Technical data can be found at the beginning of the VARITECTOR SPC section. Order with VSPC CONTROL UNIT.

VSPC GDT - arrester / plug-in components



Ordering data

	VSPC GDT 2CH 90 V	VSPC GDT 2CH 150 V AC/230 V DC
Rated voltage (AC)	48 V	110 V
Rated voltage (DC)	68 V	150 V
Max. continuous voltage, U _c (AC)	50 V	125 V
Max. continuous voltage, U _c (DC)	72 V	180 V
Rated current I _n	2 A	2 A
Signalling contact	No	No
Optical function display	No	No
Capacitance	9.37 pF	7.45 pF
Pulse-reset capacity		
Residual voltage, U _r typical	< 1000 V	< 1000 V
Protection level		
Protection level wire-wire 1kV/μs, type	650 V	450 V
Protection level wire-wire 8/20 μs, type	1000 V	800 V
Protection level wire-PE 1kV/μs, type	650 V	800 V
Protection level wire-PE 8/20 μs, type	< 1000 V	< 1000 V

Ordering data		
without function indicator	Type	VSPC GDT 2CH 90V
	Order No.	8924570000
	Qty.	1
Note		The 90 V gas discharge tube has a tolerance of +/- 20 %.
		VSPC GDT 2CH 150VAC/230VDC
	Order No.	8924590000
	Qty.	1
Note		The 230 V gas discharge tube has a tolerance of +/- 20 %.

VARITECTOR SPC

VSPC MOV - protection with varistor

- Pluggable arrester (impedance-neutral plugging/unplugging without interruption)
- Can be tested with the V-TEST testing device
- Optional monitoring function with status display and alert functions for MOV components
- Version with floating-earth PE connection for avoiding voltage potential differences
- Tested in accordance with IEC 61643-21
- Integrated PE foot, safely discharges up to 20 kA (8/20 μ s) and 2.5 kA (10/350 μ s) to PE

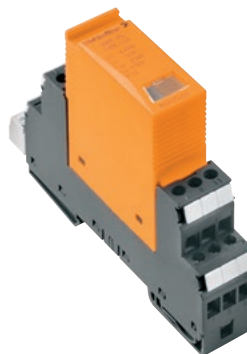

Technical data

Volume resistance	0.20 Ω
Overload - failure mode	Mode 1
Requirements category acc. to IEC 61643-21	C1, C2, C3, D1
Surge current-carrying capacity C1	< 1 kA 8/20 μ s
Surge current-carrying capacity C2	1.5 kA 8/20 μ s
Surge current-carrying capacity C3	100 A 10/1000 μ s
Surge current-carrying capacity D1	0.5 kA 10/350 μ s
Discharge current I_d (8/20 μ s) wire-wire/wire-PE/GND-PE	0.2 kA / 2.5 kA / 0.5 kA
Discharge I_{max} (8/20 μ s) wire-wire/wire-PE/GND-PE	1.5 kA / / 1.5 kA
Lightning test I_{imp} (10/350 μ s) wire-wire/wire-PE/GND-PE	0.2 kA / / 0.5 kA
Type of connection	Pluggable in VSPC BASE
Storage temperature	-40 °C...80 °C
Ambient temperature (operational)	-40 °C...70
Protection degree	IP20
Failure probability	
Ages	26
MTTF	4391
SIL in compliance with IEC 61508	3
Approvals	
Approvals	CE; CSAEX; FUSAFETY; UL
Standards	IEC 61643-21

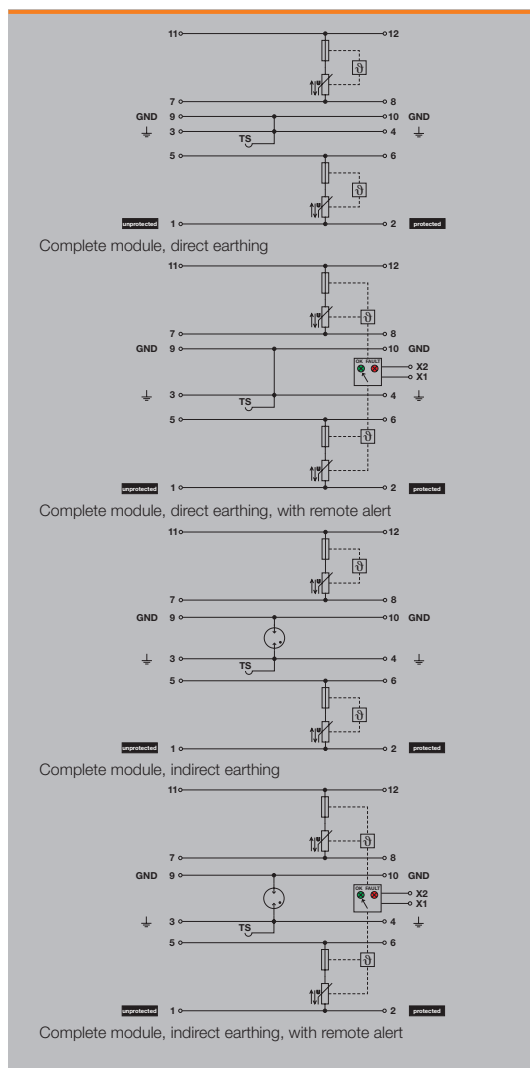

Dimensions of complete module (arrester + base element)	no remote sig. contact
Height x width x depth	mm 90 / 17.8 / 69

Note The associated VSPC base element should be ordered with this. The dimension information provided refers to the complete module.

Base elements / base to arresters



Ordering data for base

Description	Type	Qty.	Order No.
Base element, direct earthing	VSPC BASE 2/4CH	1	8924740000
Base element, direct earthing with remote contact	VSPC BASE 2/4CH R	1	8951790000
Base element, indirect earthing with remote contact	VSPC BASE 2/4CH FG R	1	8951800000
Base element, indirect earthing / floating earth FG	VSPC BASE 2/4CH FG	1	8924300000

Note Technical data can be found at the beginning of the VARITECTOR SPC section. Order with VSPC CONTROL UNIT.

VSPC MOV - arrester / plug-in components



Ordering data	VSPC MOV 2CH 24 V	VSPC MOV 2CH 230 V	VSPC MOV 2CH 24 V R	VSPC MOV 2CH 230 V R
Rated voltage (AC)	24 V	230 V	24 V	230 V
Rated voltage (DC)	30 V	230 V	30 V	230 V
Max. continuous voltage, U_c (AC)	30 V	275 V	30 V	275 V
Max. continuous voltage, U_c (DC)	38 V	350 V	38 V	350 V
Rated current I_n	10 A	10 A	10 A	10 A
Signalling contact	No	No	U_n 250 V AC 0.1 A 1CO at VSPC R with VSPC control unit	U_n 250 V AC 0.1 A 1CO at VSPC R with VSPC control unit
Optical function display	No	No	green = OK; red = arrester is defective - replace	green = OK; red = arrester is defective - replace
Capacitance	14.5 nF	720 pF	14.5 nF	720 pF
Residual voltage, U_r typical	200 V	850 V	200 V	850 V
Protection level				
Protection level wire-wire 1kV/ μ s, type	80 V	600 V	80 V	600 V
Protection level wire-wire 8/20 μ s, type	95 V	700 V	95 V	700 V
Protection level wire-PE 1kV/ μ s, type				
Protection level wire-PE 8/20 μ s, type				
Ordering data	Without functional display	Without functional display	With functional display	With functional display
Type	VSPC MOV 2CH 24V	VSPC MOV 2CH 230V	VSPC MOV 2CH 24V R	VSPC MOV 2CH 230V R
Order No.	8924600000	8924610000	8951650000	8951660000
Qty.	1	1	1	1
Note				



VARITECTOR SPC

VSPC TAZ protection with suppressor diode

- Pluggable arrester (impedance-neutral plugging/unplugging without interruption)
- Can be tested with the V-TEST testing device
- Optional monitoring function with status display and alert functions for MOV components
- Lower residual voltage
- Version with floating-earth PE connection for avoiding voltage potential differences
- Tested in accordance with IEC 61643-21
- Integrated PE foot, safely discharges up to 20 kA (8/20 μ s) and 2.5 kA (10/350 μ s) to PE

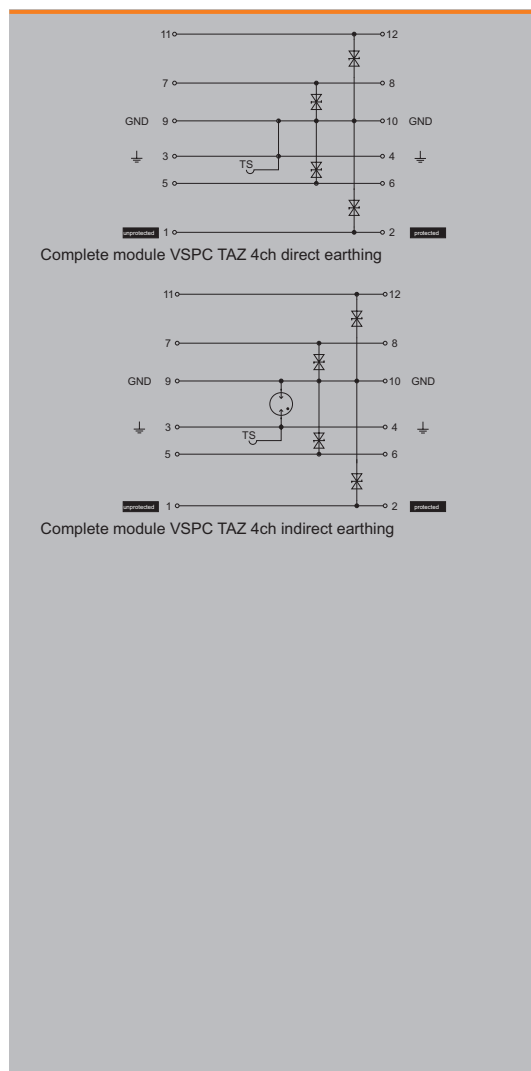

Technical data

Volume resistance	0.20 Ω
Overload - failure mode	Mode 1
Requirements category acc. to IEC 61643-21	C3
Surge current-carrying capacity C1	
Surge current-carrying capacity C2	
Surge current-carrying capacity C3	20 A 10/1000 μ s
Surge current-carrying capacity D1	
Discharge current I_t (8/20 μ s) wire-wire/wire-PE/GND-PE	0.05 kA /
Discharge I_{max} (8/20 μ s) wire-wire/wire-PE/GND-PE	0,1 kA /
Lightning test I_{imp} (10/350 μ s) wire-wire/wire-PE/GND-PE	/
Type of connection	Pluggable in VSPC BASE
Storage temperature	-40 °C...80 °C
Ambient temperature (operational)	-40 °C...70
Protection degree	IP20
Failure probability	
Ages	32
MTTF	3567
SIL in compliance with IEC 61508	3
Approvals	
Approvals	CE; CSAEX; FUSAFETY; UL
Standards	According to IEC61643-21

Dimensions of complete module (arrester + base element)	no remote sig. contact
Height x width x depth	mm 90 / 17.8 / 69

Note The associated VSPC base element should be ordered with this. The dimension information provided refers to the complete module.

Base elements / base to arresters



Ordering data for base

Description	Type	Qty.	Order No.
Base element, direct earthing	VSPC BASE 2/4CH	1	8924740000
Base element, indirect earthing / floating earth FG	VSPC BASE 2/4CH FG	1	8924300000

Note Technical data can be found at the beginning of the VARITECTOR SPC section. Order with VSPC CONTROL UNIT.

VSPC TAZ - arrester / plug-in components



Ordering data

VSPC TAZ 4CH 24 V	
Rated voltage (AC)	24 V
Rated voltage (DC)	28 V
Max. continuous voltage, U _c (AC)	28 V
Max. continuous voltage, U _c (DC)	39 V
Rated current I _n	10 A
Signalling contact	No
Optical function display	No
Capacitance	680 pF
Pulse-reset capacity	
Residual voltage, U _r typical	65 V
Protection level	
Protection level wire-wire 1kV/μs, type	50 V
Protection level wire-wire 8/20 μs, type	55 V
Protection level wire-PE 1kV/μs, type	55 V
Protection level wire-PE 8/20 μs, type	65 V

Ordering data

without function indicator	Type	VSPC TAZ 4CH 24V
	Order No.	8924650000
	Qty.	1
Note		



VARITECTOR SPC

VSPC TELE UKO - protection for telephones

- Pluggable arrester (impedance-neutral plugging/unplugging without interruption)
- Can be tested with the V-TEST testing device
- Two-wire input interface - U_{10}
- Version with floating-earth PE connection for avoiding voltage potential differences
- Tested in accordance with IEC 61643-21
- Integrated PE foot, safely discharges up to 20 kA (8/20 μ s) and 2.5 kA (10/350 μ s) to PE



Technical data

Volume resistance	2.20 Ω
Overload - failure mode	Modus 2
Requirements category acc. to IEC 61643-21	C1, C2, C3, D1
Surge current-carrying capacity C1	< 1 kA 8/20 μ s
Surge current-carrying capacity C2	5 kA 8/20 μ s
Surge current-carrying capacity C3	100 A 10/1000 μ s
Surge current-carrying capacity D1	2.5 kA 10/350 μ s
Discharge current $I_{(8/20 \mu s)}$ wire-wire/wire-PE/GND-PE	2.5 kA / 2.5 kA / 2.5 kA
Discharge I_{max} (8/20 μ s) wire-wire/wire-PE/GND-PE	10 kA / 2 x 10 kA / 10 kA
Lightning test I_{imp} (10/350 μ s) wire-wire/wire-PE/GND-PE	0.2 kA / 2 x 0.2 kA / 0.2 kA
Type of connection	Pluggable in VSPC BASE
Storage temperature	-40 °C...80 °C
Ambient temperature (operational)	-40 °C...70
Protection degree	IP20
Failure probability	
Ages	49
MTTF	2330
SIL in compliance with IEC 61508	3
Approvals	
Approvals	CE; CSAEX; FUSAFETY; UL
Standards	According to IEC61643-21

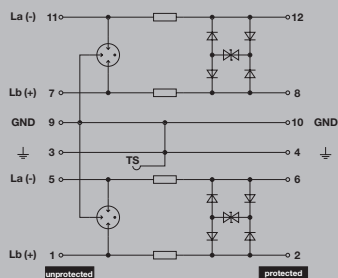

Complete module, direct earthing

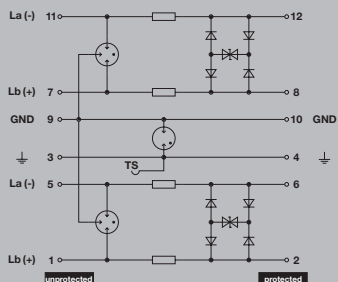

Complete module, indirect earthing

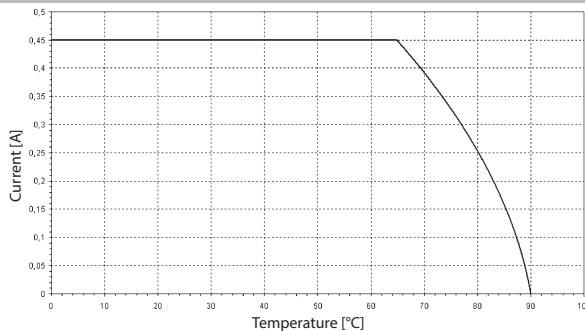

Dimensions of complete module (arrester + base element)	no remote sig. contact
Height x width x depth	mm 90 / 17.8 / 69

Note Order the associated VSPC base element with this. The dimension information provided refers to the complete module.

Base elements / base to arresters



Ordering data for base

Description	Type	Qty.	Order No.
Base element, indirect earthing / floating earth FG	VSPC BASE 2CL FG	1	8924270000
Base element, direct earthing	VSPC BASE 2CL	1	8924710000

Note Technical data can be found at the beginning of the VARITECTOR SPC section.

VSPC TELE UK0 - arrester/plug-in components



Ordering data

VSPC TELE UK0 2 WIRE	
Rated voltage (AC)	127 V
Rated voltage (DC)	120 V
Max. continuous voltage, U _c (AC)	130 V
Max. continuous voltage, U _c (DC)	180 V
Rated current I _n	450 mA
Input attenuation	101.7 MHz
Pulse-reset capacity	≤ 60 ms
Residual voltage, U _p typical	< 800 V
Protection level	
Protection level wire-wire 1kV/μs, type	250 V
Protection level wire-wire 8/20 μs, type	300 V
Protection level wire-PE 1kV/μs, type	450 V
Protection level wire-PE 8/20 μs, type	< 800 V

Ordering data		
without function indicator	Type	VSPC TELE UK0 2WIRE
	Order No.	8924660000
	Qty.	1
Note		



VARITECTOR SPC

VSPC RS485 - protection for data signals

- Pluggable arrester (impedance-neutral plugging/unplugging without interruption)
- Can be tested with V-TEST testing device
- Optional monitoring function with status indicator and alert functions
- Low residual voltage
- Version with floating-earth PE connection for avoiding voltage potential differences
- Tested in accordance with IEC 61643-21
- Integrated PE foot, safely discharges up to 20 kA (8/20 μ s) and 2.5 kA (10/350 μ s) to PE



Technical data

Volume resistance	2.20 Ω
Overload - failure mode	Modus 2
Requirements category acc. to IEC 61643-21	C1, C2, C3, D1
Surge current-carrying capacity C1	< 1 kA 8/20 μ s
Surge current-carrying capacity C2	5 kA 8/20 μ s
Surge current-carrying capacity C3	100 A 10/1000 μ s
Surge current-carrying capacity D1	2.5 kA 10/350 μ s
Discharge current I_{imp} (8/20 μ s) wire-wire/wire-PE/GND-PE	2.5 kA / 2.5 kA / 2.5 kA
Discharge I_{max} (8/20 μ s) wire-wire/wire-PE/GND-PE	10 kA / 2 x 10 kA / 10 kA
Lightning test I_{imp} (10/350 μ s) wire-wire/wire-PE/GND-PE	0.2 kA / 2 x 0.2 kA / 0.2 kA
Type of connection	Pluggable in VSPC BASE
Storage temperature	-40 °C...80 °C
Ambient temperature (operational)	-40 °C...70
Protection degree	IP20
Failure probability	
Ages	57
MTTF	2003
SIL in compliance with IEC 61508	3
Approvals	
Approvals	CE; CSAEX; FUSAFETY; UL
Standards	IEC 61643-21

C

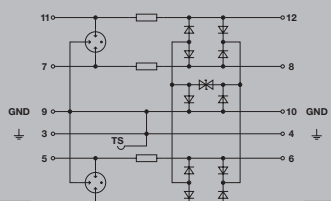

Complete module, direct earthing

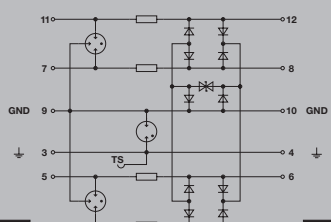

Complete module, indirect earthing

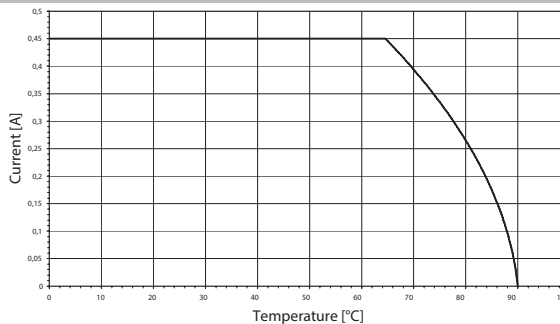

Dimensions of complete module (arrester + base element)	no remote sig. contact
Height x width x depth	mm 90 / 17.8 / 69

Note The associated VSPC base element should be ordered with this. The dimension information provided refers to the complete module.

Base elements / base to arresters



Ordering data for base

Description	Type	Qty.	Order No.
Base element, indirect earthing / floating earth FG	VSPC BASE 2CL FG	1	8924270000
Base element, direct earthing	VSPC BASE 2CL	1	8924710000

Note Technical data can be found at the beginning of the VARITECTOR SPC section.

VSPC RS485 - arrester / plug-in elements



Ordering data

Ordering data		VSPC RS485 2CH
Rated voltage (AC)		5 V
Rated voltage (DC)		5 V
Max. continuous voltage, U_c (AC)		5 V
Max. continuous voltage, U_c (DC)		6.4 V
Rated current I_N		450 mA
Input attenuation		113.6 MHz
Pulse-reset capacity		≤ 20 ms
Residual voltage, U_p typical		250 V
Protection level		
Protection level wire-wire 1kV/ μ s, type		10 V
Protection level wire-wire 8/20 μ s, type		15 V
Protection level wire-PE 1kV/ μ s, type		10 V
Protection level wire-PE 8/20 μ s, type		250 V

Ordering data		
without function indicator	Type	VSPC RS485 2CH
	Order No.	8924670000
	Qty.	1
Note		



VARITECTOR SPC

VSPC RS485 - protection for data signals with remote alert

- Pluggable arrester (impedance-neutral plugging/unplugging without interruption)
- Can be tested with the V-TEST testing device
- Optional monitoring function with status indicator and alert functions
- Lower residual voltage
- Version with floating-earth PE connection for avoiding voltage potential differences
- Tested in accordance with IEC 61643-21
- Integrated PE foot, safely discharges up to 20 kA (8/20 μ s) and 2.5 kA (10/350 μ s) to PE

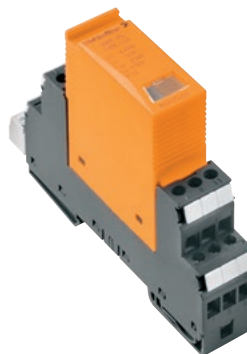

C

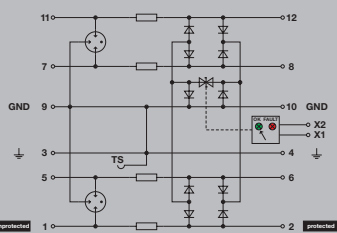

Complete module, direct earthing, with remote alert

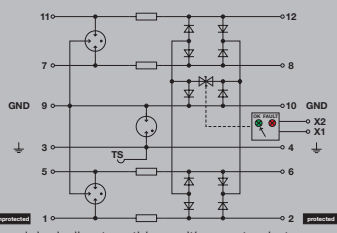

Complete module, indirect earthing, with remote alert

Technical data

Volume resistance	2.20 Ω
Overload - failure mode	Modus 2
Requirements category acc. to IEC 61643-21	C1, C2, C3, D1
Surge current-carrying capacity C1	< 1 kA 8/20 μ s
Surge current-carrying capacity C2	5 kA 8/20 μ s
Surge current-carrying capacity C3	100 A 10/1000 μ s
Surge current-carrying capacity D1	2.5 kA 10/350 μ s
Discharge current $I_{(8/20 \mu s)}$ wire-wire/wire-PE/GND-PE	2.5 kA / 2.5 kA / 2.5 kA
Discharge I_{max} (8/20 μ s) wire-wire/wire-PE/GND-PE	10 kA / 2 x 10 kA / 10 kA
Lightning test I_{imp} (10/350 μ s) wire-wire/wire-PE/GND-PE	0.2 kA / 2 x 0.2 kA / 0.2 kA
Type of connection	Pluggable in VSPC BASE
Storage temperature	-40 °C...80 °C
Ambient temperature (operational)	-40 °C...70
Protection degree	IP20
Failure probability	
Ages	90
MTTF	1266
SIL in compliance with IEC 61508	3
Approvals	
Approvals	CE; CSAEX; FUSAFETY; UL
Standards	IEC 61643-21

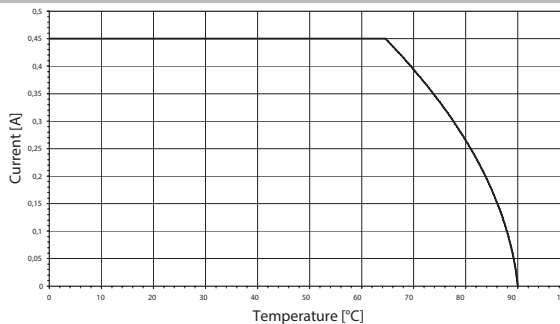

Dimensions of complete module (arrester + base element)	with remote signalling (R)
Height x width x depth	mm 98 / 17.8 / 69

Note The associated VSPC base element should be ordered with this. The dimension information provided refers to the complete module.

Base elements / base to arresters



Ordering data for base

Description	Type	Qty.	Order No.
Base element, direct earthing with remote contact	VSPC BASE 2CL R	1	8951710000
Base element, indirect earthing with remote contact	VSPC BASE 2CL FG R	1	8951720000

Note Technical data can be found at the beginning of the VARITECTOR SPC section. Order with VSPC CONTROL UNIT.

**VSPC RS485 - arrester / plug-in elements
with remote alert**



Ordering data

	VSPC RS485 2CH R
Rated voltage (AC)	5 V
Rated voltage (DC)	5 V
Max. continuous voltage, U_c (AC)	5 V
Max. continuous voltage, U_c (DC)	6.4 V
Rated current I_N	450 mA
Signalling contact	U_N 250 V AC 0.1 A 1CO at VSPC R with VSPC control unit
Optical function display	green = OK; red = arrester is defective - replace
Input attenuation	113.6 MHz
Pulse-reset capacity	≤ 20 ms
Residual voltage, U_r typical	250 V
Protection level	
Protection level wire-wire 1kV/ μ s, type	10 V
Protection level wire-wire 8/20 μ s, type	15 V
Protection level wire-PE 1kV/ μ s, type	10 V
Protection level wire-PE 8/20 μ s, type	250 V

Ordering data		
with function indicator	Type	VSPC RS485 2CH R
	Order No.	8951670000
	Qty.	1
Note		





VARITECTOR SPC

Direct earthing

VSPC BASE

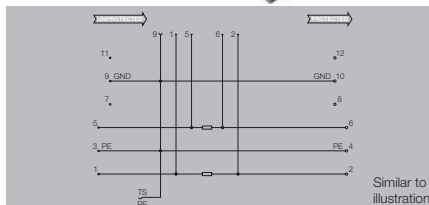

Technical data

Stripping length, rated connection
 Wire cross-section, stranded, min.
 Wire cross-section, stranded, max.
 Wire cross-section, solid, min.
 Wire cross-section, solid, max.
 Clamping range, min.
 Clamping range, max.
 Tightening torque, min.
 Tightening torque, max.
 Type of connection
 Certificate No. (UL)
 Approvals
 Ambient temperature (operational)
 Storage temperature
 UL 94 flammability rating
 Pollution degree
 Overvoltage category
 Protection degree
 Rail
 Humidity

7 mm
0.5 mm ²
2.5 mm ²
0.5 mm ²
4 mm ²
0.5 mm ²
4 mm ²
0.5 Nm
0.8 Nm
Screw connection
E311081VOL1SEC2
CE, CSAEX, UL
-40 °C...70
-40 °C...80 °C
V-0
2
III
IP20
TS 35, TS 35 x 7.5
5...96 %

CSA protection data

Input current, max. I_i
 Gas groups A, B
 Gas group C
 Gas group D
 Internal inductance, max. L_i

450 mA
IIC
IIB
IIA

Dimensions

Height x width mm

90 / 17.8

Note

Ordering data

No remote sig. contact

Type	Qty.	Order No.
VSPC BASE 1CL	1	8924730000
VSPC BASE 2SL	1	8924720000
VSPC BASE 2CL	1	8924710000
VSPC BASE 2/4CH	1	8924740000
VSPC BASE 1CL.PW	1	1070230000
VSPC BASE 4SL	1	8924700000

Note

Technical data can be found at the beginning of the VARITECTOR SPC section.

Accessories

Note

Marker: DEK 5

Indirect earthing

VSPC BASE FG

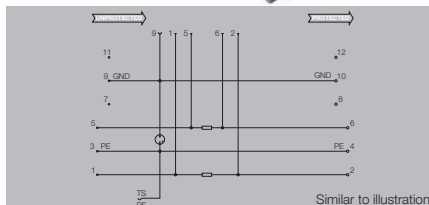

Technical data

Stripping length, rated connection
Wire cross-section, stranded, min.
Wire cross-section, stranded, max.
Wire cross-section, solid, min.
Wire cross-section, solid, max.
Clamping range, min.
Clamping range, max.
Tightening torque, min.
Tightening torque, max.
Type of connection
Certificate No. (UL)
Approvals
Ambient temperature (operational)
Storage temperature
UL 94 flammability rating
Pollution degree
Overvoltage category
Protection degree
Rail
Humidity

7 mm
0.5 mm ²
2.5 mm ²
0.5 mm ²
4 mm ²
0.5 mm ²
4 mm ²
0.5 Nm
0.8 Nm
Screw connection
E311081VOL1SEC2
CE, CSAEX, UL
-40 °C...70
-40 °C...80 °C
V-0
2
III
IP20
TS 35, TS 35 x 7.5
5...96 %

CSA protection data

Input current, max. I _i
Gas groups A, B
Gas group C
Gas group D
Internal inductance, max. L _i

450 mA
IIC
IIB
IIA

Dimensions

Height x width	mm	90 / 17.8
----------------	----	-----------

Note

Ordering data

No remote sig. contact

Type	Qty.	Order No.
VSPC BASE 1CL FG	1	8924290000
VSPC BASE 2SL FG	1	8924280000
VSPC BASE 2CL FG	1	8924270000
VSPC BASE 1CL PW FG	1	1105700000
VSPC BASE 2/4CH FG	1	8924300000
VSPC BASE 4SL FG	1	8924260000

Note

Technical data can be found at the beginning of the VARITECTOR SPC section.

Accessories

Note

Marker: DEK 5





VARITECTOR SPC

Direct earthing, with remote alert

VSPC BASE R

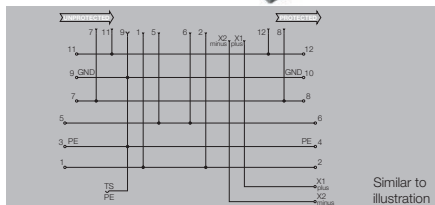

Technical data

Stripping length, rated connection
Wire cross-section, stranded, min.
Wire cross-section, stranded, max.
Wire cross-section, solid, min.
Wire cross-section, solid, max.
Clamping range, min.
Clamping range, max.
Tightening torque, min.
Tightening torque, max.
Type of connection
Certificate No. (UL)
Approvals
Ambient temperature (operational)
Storage temperature
UL 94 flammability rating
Pollution degree
Overvoltage category
Protection degree
Rail
Humidity
CSA protection data
Input current, max. I _i
Gas groups A, B
Gas group C
Gas group D
Internal inductance, max. L _i

7 mm
0.5 mm ²
2.5 mm ²
0.5 mm ²
4 mm ²
0.5 mm ²
4 mm ²
0.5 Nm
0.8 Nm
Screw connection
E311081VOL1SEC2
CE, CSAEX, UL
-40 °C...70
-40 °C...80 °C
V-0
2
III
IP20
TS 35, TS 35 x 7.5
5...96 %
300 mA
IIC
IIB
IIA

Dimensions

Height x width	mm	98 / 17.8
----------------	----	-----------

Note

Ordering data

With remote sig. contact (R)

Type	Qty.	Order No.
VSPC BASE 2SL R	1	8951770000
VSPC BASE 1CL R	1	8951730000
VSPC BASE 2CL R	1	8951710000
VSPC BASE 2/4CH R	1	8951790000
VSPC BASE 4SL R	1	8951750000

Note

Technical data can be found at the beginning of the VARITECTOR SPC section. Order with VSPC CONTROL UNIT.

Accessories

Note

Marker: DEK 5

Indirect earthing, with remote alert

VSPC BASE FG R

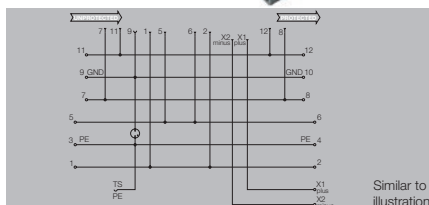

Technical data

Stripping length, rated connection	7 mm
Wire cross-section, stranded, min.	0.5 mm ²
Wire cross-section, stranded, max.	2.5 mm ²
Wire cross-section, solid, min.	0.5 mm ²
Wire cross-section, solid, max.	4 mm ²
Clamping range, min.	0.5 mm ²
Clamping range, max.	4 mm ²
Tightening torque, min.	0.5 Nm
Tightening torque, max.	0.8 Nm
Type of connection	Screw connection
Certificate No. (UL)	E311081VOL1SEC2
Approvals	CE, CSAEX, UL
Ambient temperature (operational)	-40 °C...70
Storage temperature	-40 °C...80 °C
UL 94 flammability rating	V-0
Pollution degree	2
Overvoltage category	III
Protection degree	IP20
Rail	TS 35, TS 35 x 7.5
Humidity	5...96 %
CSA protection data	
Input current, max. I _i	300 mA
Gas groups A, B	IIC
Gas group C	IIB
Gas group D	IIA
Internal inductance, max. L _i	

7 mm
0.5 mm ²
2.5 mm ²
0.5 mm ²
4 mm ²
0.5 mm ²
4 mm ²
0.5 Nm
0.8 Nm
Screw connection
E311081VOL1SEC2
CE, CSAEX, UL
-40 °C...70
-40 °C...80 °C
V-0
2
III
IP20
TS 35, TS 35 x 7.5
5...96 %
300 mA
IIC
IIB
IIA

Dimensions

Height x width	mm	98 / 17.8
----------------	----	-----------

98 / 17.8

Note

Ordering data

With remote sig. contact (R)

Type	Qty.	Order No.
VSPC BASE 2SL FG R	1	8951780000
VSPC BASE 1CL FG R	1	8951740000
VSPC BASE 2CL FG R	1	8951720000
VSPC BASE 2/4CH FG R	1	8951800000
VSPC BASE 4SL FG R	1	8951760000

Note

Technical data can be found at the beginning of the VARITECTOR SPC section. Order with VSPC CONTROL UNIT.

Accessories

Note

Marker: DEK 5



VARITECTOR SPC

VSPC Ground

- Can be applied to unassigned wires
- Usable during start-up and maintenance
- Earthing of all sensor cables
- Can be plugged into standard base sockets



C

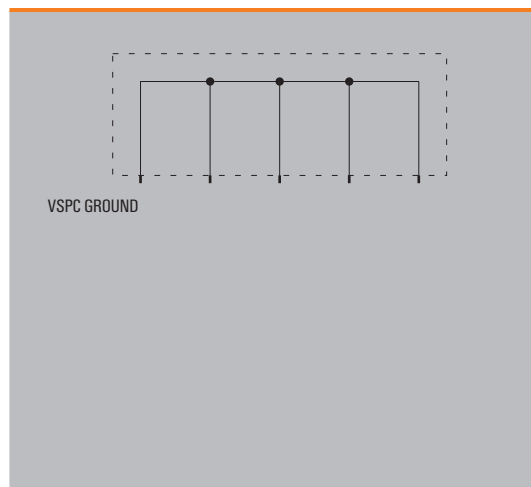

Technical data

Rated voltage	230 V AC
Max. continuous voltage, U_c	255 V AC
Rated current	< 0.5 A
Volume resistivity per path	< 0.2 Ω
Type of connection	Pluggable in VSPC BASE
Storage temperature	-40 °C...+80 °C
Ambient temperature (operational)	-40 °C...+70 °C
Rel. humidity	5 %...96 % RH
Degree of protection	IP 20

Note

Ordering data

Arrester / plug-in elements	Type
	Order No.
	Qty.
Note	

VSPC GROUND	
VSPC GROUND	
8924680000	
1	

VSPC CONTROL UNIT 24 V DC

- For monitoring up to 10 protective modules
- Signalling module for all VSPCs with status indicator
- Signalling of cable breaks / signal interruptions
- Voltage supply from 18...31 V DC
- Potential-free changeover contact
- Function indicator (red/green LED)
- Other NC-contact monitoring functions can be integrated into the signal circuit (e.g. VPU I, VPU II and VPU III)

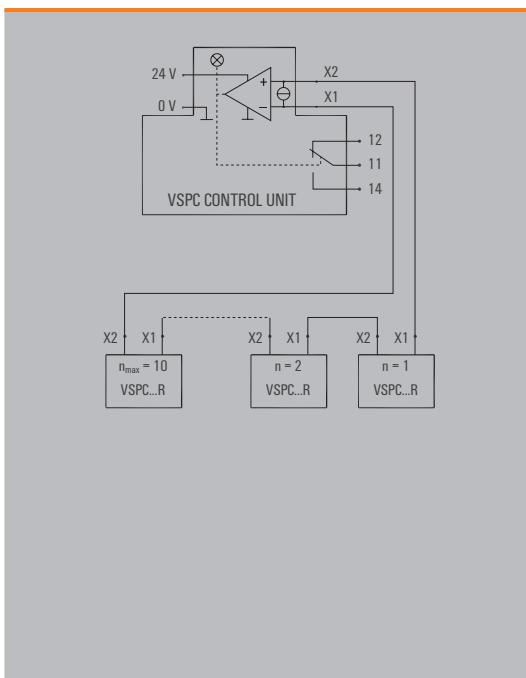

Technical data

Input	
Rated voltage (DC)	18 V...24 V DC...31 V DC
Rated current	max. 50 mA
Power rating	1.5 W
Output	
Current loop	8 mA at < 51 V
Monitoring option	1...10 VSPC modules
Signal output	
Type	1 CO contact
Max. switching voltage / continuous current	250 V / 1 A
Diagnostics	
Operating status	Green LED
Defect at current loop	Red LED (control unit and defective module)
Wire breakage	Red/green LED, flashing
General data	
Terminal rail	TS 35
Design, Protection class	Insta-enclosure, IP 20
Type of connection	BL / SL
Storage temperature	-40 °C...+80 °C
Ambient temperature (operational)	-40 °C...+70 °C
Rel. humidity	5 %...96 % RH
Start-up time after fault correction	60 s

Dimensions	
Dimensions incl. enclosure H x W x D	mm 102 x 18 x 71.5
Note	

Application

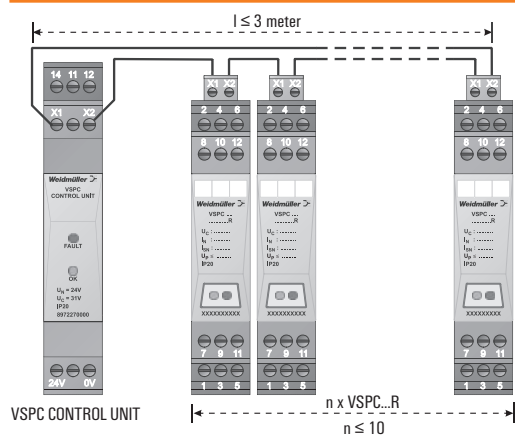

LED green	LED red	Function	
		OK	✓
		Error (one or more VSPC ... R are defective)	
		Line break in the monitoring circuit; arrester pulled out or plug not in base	

Ordering data

Type	VSPC CONTROL UNIT 24Vdc
Order No.	8972270000
Qty.	1 piece
Note	

VSPC CONTROL UNIT 24 V DC	
Type	VSPC CONTROL UNIT 24Vdc
Order No.	8972270000
Qty.	1 piece
Note	

VARIRECTOR SSC 6AN

Lightning and surge protection in terminal block design

Lightning and surge protection in 6 mm overall width for measurement and control circuits including isolation/measuring function

The VARIRECTOR SSC combined surge protection, a direct PE contact function, separation of signal paths and operational status indication in one module. It is suitable for C&I applications.

C

The disconnect lever in the terminal guarantees that the measurement/control circuit can be quickly and precisely switched off to test the signal path. Using a test plug (PS 2.3 mm), the measuring instrument can be easily inserted into the integrated test socket on Torx®/Slot headed screws. The shield can be attached onto the additional lower level of the VSSC 6AN which then leads directly to the PE potential on the mounting rail. Weidmüller's SNAPMARK device marker can be snapped onto a terminal so that the equipment identification can be easily read regardless of the installation position.

All VARIRECTOR products comply with the latest IEC 61643-21 requirement for a new overstress mode and with categories D1, C3, C2 and C1 according to IEC 61643-22.

Simple and precise isolation

The disconnect lever guarantees a simple signal path disconnection and a safe disconnect point that is easy to see.

Space-saving

A terminal of just 6.2 mm for four binary signals or two analogue signals. Terminals can be fitted side by side.

Fast identification

Versatile marking options: markers for equipment and terminals and SNAPMARK markers that are easy to read in any installation position.

Testing and measuring

To enable simple testing it is possible to insert the test plug (PS 2.3 mm) of the measuring instrument into the integrated test socket of the Torx®/slot headed screw.

Convenient

Connection convenience is assured by a clamping range of 0.5 mm² to 6 mm² with a Torx®/slot headed screw and a 0.8 Nm tightening torque.

Easy and safe

A shield can be mounted on both sides of the unit which will provide direct connection to PE. It features a very high discharge current of up to 20 kA for increased plant safety.

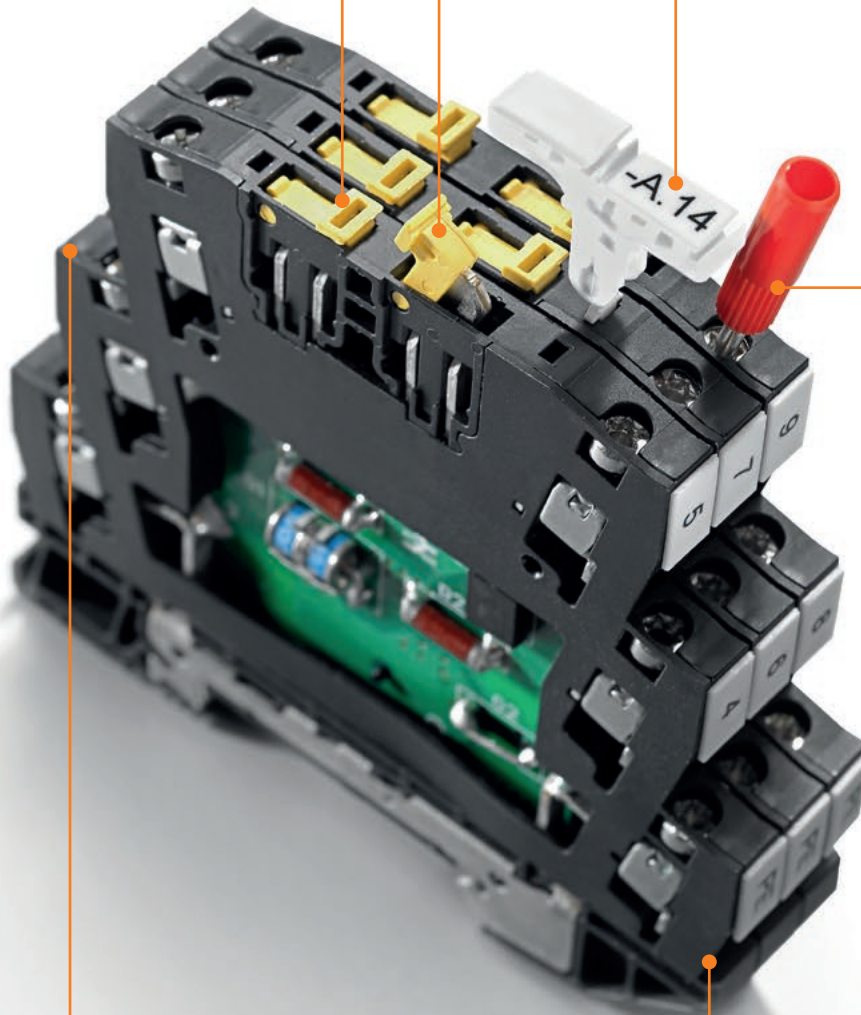

VARITECTOR SSC

Surge protection in a terminal block: for measurement and control systems

VARITECTOR SSC

Weidmüller's VARITECTOR SSC series for surge protection (VSSC4 and VSSC6) is well suited for protecting measurement and control circuits. It features good protective functionality in a compact terminal-block design. This is due to its 6.2 mm width. The combined Torx®/ slotted screw ensures that the proper nominal or max. torque is applied to the connection. The required screwdrivers are available from Weidmüller under the following order numbers:

4-mm slotted SDS 0.8x4.0x100 (order no. 2749360000) or T15 Torx® (order no. 9009170000). The VSSC can be snapped on, to directly earth it to the DIN rail. The VSSC series is available with four clamping yokes (VSSC4) and six clamping yokes (VSSC6). The screw terminal has a nominal torque of 0.5 Nm, but it can be tightened to 0.8 Nm. The VARITECTOR SSC series is optimally designed for compact installation locations in process automation, industrial automation or building automation.

The two-stage surge protection terminals are equipped with gas discharge tubes (GDT), suppressor diodes (TVS) and decoupling components. Individual protective components (such as gas-filled spark gaps, varistors and suppressor diodes) supplement this product line. Our VARITECTOR SSC surge protectors are available for components with nominal voltages of 12 V, 24 V, 48 V to 230 V. Please contact us for other voltages or special applications.

The two-stage surge protection terminals are equipped with gas discharge tubes (GDT), suppressor diodes (TVS) and decoupling components. Individual protective

components (such as gas-filled spark gaps, varistors and suppressor diodes) supplement this product line. Our VARITECTOR SSC surge protectors are available for components with nominal voltages of 12 V, 24 V, 48 V to 230 V. Please contact us for other voltages or special applications. The PE contact is established by snapping onto an earthed DIN rail. The TS 35 must be earthed in order to ensure safe power discharging via the terminals of up to 20 kA (8/20 µs) and 2.5 kA (10/350 µs). The DIN rail must be screwed onto the earthed mounting plate to ensure EMC. The best protection is achieved when a PE contact is established every 60 cm / 24 inch using the terminal at the VARITECTOR SSC terminals with direct equipotential bonding. The cable should correspond to the max. cross-section of the VSSC connection. The four-port VARITECTOR SSC terminal can be used for binary and / or analogue signal circuits. The six-port VARITECTOR SSC can also be used to open signal circuits via an isolated level and monitor them using the optional built-in LED.

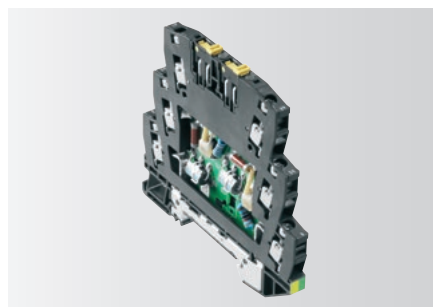

VARITECTOR SSC6



VARITECTOR SSC4

Overview of model types

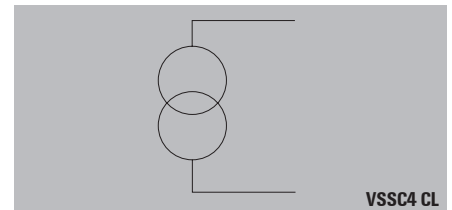

VSSC4 CL

The **VSSC4 CL** is a two-stage protective combination that has a suppressor diode between the current paths. This VSSC4 CL limits the surge voltage in **an analogue signal circuit** (e.g. a current loop).

The **VSSC4 CL FG** is a two-stage protective combination that has a suppressor diode between the current paths. The gas discharge tube to the PE provides a high-resistance earthing for the protective circuitry. Thus the current loop can be operated with a floating ground. This VSSC4 CL FG limits the surge voltage in **an analogue unearthed signal circuit** (e.g. a current loop).

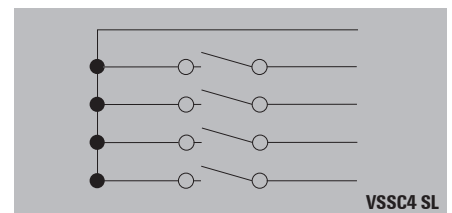

VSSC4 SL

The basic principle of a binary current circuit

The **VSSC4 SL** is a two-stage protective combination with a suppressor diode for each stage from the current path to PE. This **VSSC4 SL** limits the surge voltage in an **earthed binary signal** (e.g. for alert contacts). The VSSC4 SL FG is used for **non-earthed signal circuits**.



VARITECTOR SSC

The **VSSC4 SL FG** is a two-stage protective combination with a suppressor between the current paths and common return wire. The gas discharge tube to the PE provides a high-resistance earthing for the protective circuitry. Thus the protective circuitry can be operated with a floating earth. This VSSC4 SL FG limits the surge voltage in **a binary floating signal circuit**.

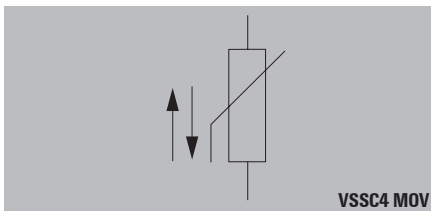

The **VSSC4 MOV** provides one-stage protection with a varistor (MOV) for the current path to PE. This **VSSC4 MOV** limits the surge voltage in **a circuit** (e.g. for solenoid valves). The thermally monitored MOV is available in voltages of 12 V, 24 V, 48 V, 60 V, 120 V, 150 V and 240 V.

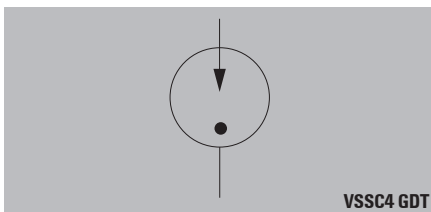

The **VSSC4 GDT** provides one-stage protection with a gas discharge tube (GDT) for the current path to PE. This **VSSC4 GDT** limits the surge voltage in **a circuit**. This terminal is used where no leakage current is permitted to flow to the earth, or where a high-impedance cable shield is connected to the earth. The GDT is available in voltages of 90 V, 110 V and 240 V.

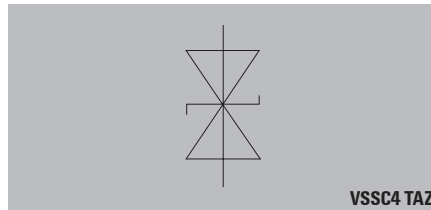

The **VSSC4 TAZ** provides one-stage protection with a quick-response (<10 ps) suppressor diode (TAZ) for the current path to PE. This **VSSC4 TAZ** limits the surge voltage in **a circuit** (e.g. for digital inputs). The TAZ is available in voltages of 12 V, 24 V, 48 V and 60 V.

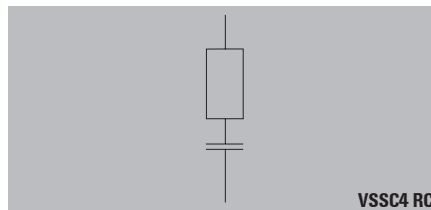

VSSC4 RC is the final protective variant in the VSSC series. This variant combines a thermally monitored varistor and an RC combination. It can be used for spark suppression on inductive loads. The VSSC4 RC is available in 24 V and 240 V.

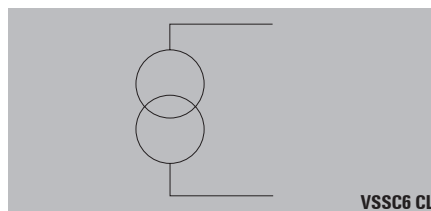

The **VSSC6 CL** is a two-stage protective combination that has a suppressor diode between the current paths. This VSSC6 CL limits the surge voltage in **an analogue signal circuit** (e.g. a current loop). The PE potential can be provided on terminal point 3/6 by snapping the terminal on an earthed DIN rail. This allows a shield connection to be connected. This version is also available as the **VSSC6 CL FG** floating-ground protective circuit.

The **VSSC6 TR CL** is built like the VSSC6 CL and also has two isolators. The 2.3-mm PS 2.3 (order number 018040000) can be plugged into the Torx® screw head. The isolation makes it possible to take measurements in the field, in the electrical cabinet or via the surge protection. This version is also available as the **VSSC6 TR CL FG** floating-ground protective circuit.

The **VSSC6 SL LD** is a two-stage protective combination with a suppressor between the current paths and common return wire. This VSSC6 SL limits the surge voltage in **two binary signal circuits**. The signal status for each signal circuit is indicated by an LED.

The **VSSC6 TR SL LD** is built like the VSSC6 L LD but also has two isolators. The 2.3-mm plug uses the screws to provide easy signal measurements. This version is also available as the **VSSC6 TR SL FG** floating-ground protective circuit.

The **VSSC6 MOV** provides one-stage protection with two thermally monitored varistors (MOV) between the current paths and common return wire. This VSSC6 MOV limits the surge voltage in **two binary signal circuits**.

The **VSSC6 TR LD MOV** provides one-stage protection with two thermally monitored varistors (MOV) between the current paths and common return wire. The VSSC6 MOV limits the surge voltage in **two binary signal circuits** and also has an isolator and an LED for each signal circuit.

The **VSSC6 GDT** provides one-stage protection with two gas discharge tubes (GDT) between the current paths and common return wire. This VSSC6 GDT limits the surge voltage in **two binary signal circuits**.

The **VSSC6 TR LD GDT** provides two-stage protection with two gas discharge tubes (GDT) between the current paths and common return wire. The VSSC6 GDT limits the surge voltage in **two binary signal circuits** and also has an isolator for each signal circuit.

The **VSSC6 TAZ** provides one-stage protection with two suppressor diodes (TAZ) between the current paths and common return wire. The VSSC6 TAZ limits the surge voltage in **two binary signal circuits** and also has an isolator and an LED for each signal circuit.

The **VSSC6 TR LD TAZ** provides one-stage protection with two suppressor diodes (TAZ) between the current paths and common return wire. The VSSC6 TAZ limits the surge voltage in **two binary signal circuits** and also has an isolator and an LED for each signal circuit.

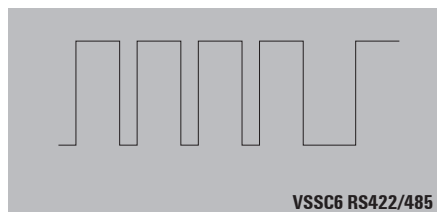

The **VSSC6 RS485** is a two-stage protective combination that has suppressor diodes between the current paths. This VSSC6 RS485 limits the surge voltage in **two high-frequency signal circuits** with common return wires. The VSSC6 RS485 is available in the PROFIBUS PA and DP variants.

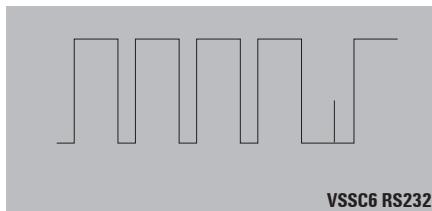

The **VSSC6 RS232** is a two-stage protective combination that has suppressor diodes between the current paths. This VSSC6 RS232 limits the surge voltage in **a signal circuit**.

Black Material PA6.6 with UL94 V0 is used for the VSSC4 and VSSC6 series so that they are suitable for use in many applications. They are suitable for use in temperatures ranging from -40 to +70 °C.

Discharge capacity

Tested in compliance with standard IEC 61643-21 for providing surge protection in signalling networks with voltage and current pulses. The VSSC series has been tested to comply with IEC 61643-21 and EN 61643-21. Modules were tested with categories C1, C2 and C3: with quick-rising edges with up to 300 pulses. Category D1 describes high-power testing (10/350 µs), so that the VSSC series can be used in compliance with IEC 62305-4. The VSSC is colour-coded so that it is easy to detect the voltage level (or the signal location SL or CL).

Colour coding

Voltage level	Colour
≤ 12 V	green
24 V Binary	blue
24 V Analogue	yellow
48 V	red
≥ 60 V	violet
Special function	white

Installation

The VSSC series is used to protect signal circuits. In order to achieve a complete protective strategy for the facility, the power feed must be protected with Type II surge protection (for example, by using the VPU II series).

For existing lightning protection facilities, Type I protection must be used (for example, by using the VPU I series). Type II protection (for example, the VPU II) is sufficient when there is no lightning protection facility.

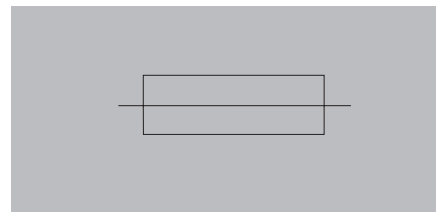

Fusing

The VSPC surge protection modules are designed so that they are decoupled between the individual protective stages. When relying on an external fuse, make sure to maintain the following:

- Maximum nominal current
- Derating curve
- Type of installation
- Application

Category

**IEC 61643-21
C1, C2, C3, D1**

VARITECTOR SSC

Category	Testing pulse	Surge voltage	Surge current	Pulse	Type
C1	Quick rising edge	0,5 < 2 kV with 1.2/50 µs	0.25 < 1 kA with 8/20 µs	300	Surge voltage arrester
C2	Quick rising edge	2 < 10 kV with 1.2/50 µs	1 < 5 kA with 8/20 µs	10	Surge voltage arrester
C3	Quick rising edge	≥ 1 kV with 1 kV/µs	10 < 100 A with 10/10.000 µs	300	Surge voltage arrester
D1	High power	≥ 1 kV	0.5 < 2.5 kA with 10/350 µs	2	Arrester for lightning current and surge voltages

Category C reflects the interference pulses with quick-rising edges and minimised power. Category D uses quick-rising edges and high power to detail the interference pulses. This energy simulates the high-power load that stems from coupled partial lightning currents.

General technical data

Storage temperature: -40 °C ... +80 °C
 Operating temperature: -40 °C ... +70 °C
 Humidity: 5 % ... 96 % 5 %...96 %
 RH without condensation
 Material: VO, IP 20

Connection: VSSC4 and VSSC6
 Torx®: T15 900917
 Slotted: 0.8 x 4
 (order number 9008340000)
 Nominal torque: 0.5 Nm
 Max. Drehmoment: 1 Nm
 Max. torque: 10 mm
 Solid core: 0.5...6 mm²
 Stranded: 0.5 ... 4 mm²
 Finely stranded: 0.5 4 mm²
 Finely stranded with ferrule: 0.5 4 mm²

Dimensions

VSSC4:
 Width: 6.1 mm
 Width with frame: 12.2 mm
 Height: 76 mm
 Depth: 58.5 mm with TS 35 x 7.5

Top connections:
 Unprotected: 1
 Protected: 4
 Bottom connections:
 Unprotected: 2
 Protected: 3

VSSC6:
 Width: 6.1 mm
 Width with frame: 12.2 mm
 Height: 88.5 mm
 Depth: 81 mm with TS 35 x 7.5

Top connections:
 Unprotected: 1
 Protected: 4
 Mid-level connections:
 Unprotected: 2
 Protected: 5
 Bottom connections:
 Unprotected: 3
 Protected: 6

Markers for VSSC4 and VSSC6:

Dekafix: DEK 5 for the connections WS 10/6 middle as device marker SNAPMARK only for the VSSC6 and DEK5/5 for the terminal points.

Derating curves

VSSC4 GDT MOV TAZ

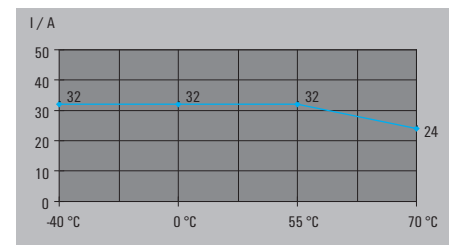

VSSC4 RC

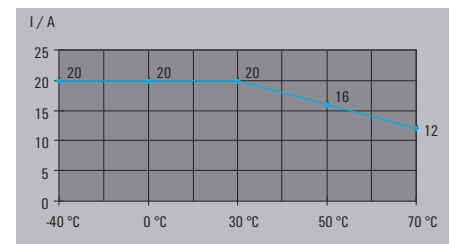

VSSC6 GDT MOV

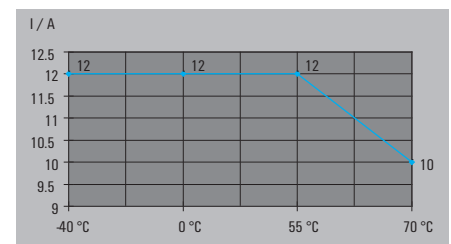

Other VSSC4 und VSS

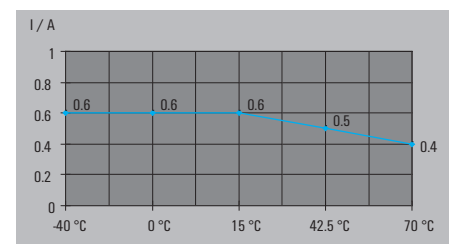

Quick product selection for the VARITECTOR SSC

Technical data

Interface	Product designation	Order No.
0(4) ... 20 mA / 0 ... 10 V	VSSC4 CL 24 V UC 0.5 A	1063730000
	VSSC6 CL 24 V UC 0.5 A	1064170000
	VSSC6TR CL FG 24 V UC 0.5 A	1064310000
	VSSC4 CL FG 24 V UC 0.5 A	1063770000
	VSSC6 CL FG 24 V UC 0.5 A	1064270000
	VSSC6TR CL FG 24 V UC 0.5 A	1064310000
ARCNET (Plus)	VSSC6 RS485	1064980000
BACnet	VSSC6 RS485 DP	1065010000
BACnet	VSSC6 RS232	1064990000
BLN (Building Level Network)	see 0(4) ... 20 mA / 0 ... 10 V	
DALI Bus	VSSC4 CL FG 24 V AC/DC 0.5 A	1063770000
DeviceNet	VSSC6 RS485	1064980000
DIN Messbus	see 0(4) ... 20 mA / 0 ... 10 V	
Dupline / Miniplex	VSSC6 CL 12 V DC 0.5 A	1064150000
KNX	VSSC 6 GDT 24 V AC/DC	1064640000
EIB/KNX	VSSC6 GDT 110 V UC 10 kA	1064690000
EIB/KNX	VSSC6 GDT 110 V UC 20 kA	1064700000
ET200	VSSC6 CL 12 V DC 0.5 A	1064150000
Genius I/O Bus	see 0(4) ... 20 mA / 0 ... 10 V	
Hart	see 0(4) ... 20 mA / 0 ... 10 V	
Cathodic corrosion protection	VSSC6 GDT 230 V UC 20 kA	1064720000
LON™ (Works)	VSSC6 CL 48 V UC 0.5 A	1064190000
M-Bus (Remote meter reading)	see 0(4) ... 20 mA / 0 ... 10 V	
M-Bus	VSSC6 CL 48 V UC 0.5	1064190000
MPI Bus	VSSC6 RS485	1064980000
N2 Bus	VSSC6 SL LD 12 V DC 0.5 A	1064340000
Procontic CS31	VSSC6TR CL FG 12 V DC 0.5 A	1064300000
Profibus DP (FMS)	VSSC6 RS485 DP	1065010000
PT100	VSSC6 RTD	1139710000
PSM-EG-RS422...	VSSC6 RS485 DP	1065010000
PSM-EG-RS485...	VSSC6 RS485 DP	1065010000
RS422A, V.11, X.27, RS423A	VSSC6 RS485 DP	1065010000
RS485	VSSC6 RS485 DP	1065010000
RS232-C / V.24	VSSC6 RS232	1064990000
SecuriLan-LON™-Bus	see 0(4) ... 20 mA / 0 ... 10 V	
(Profibus DP)	VSSC6 RS485 DP	1065010000
TTY, 0(4) - 20 mA	see 0(4) ... 20 mA / 0 ... 10 V	
U-BUS	VSSC6 GDT 110 V UC 20 kA	1064700000

Note: This table contains selection recommendations. Our technical consultants will be glad to assist you with your individual application requirements.





C

VSSC 6 CL and CL FG - protection for analogue signals

- Two-stage surge protection with screw connection for measurement and control signals
- Surge protection in terminal block design
- Modular width of only 6.2 mm
- Space-saving design: 1 analogue signal
- Torx® slotted screw connection
- Can be used in compliance with installation standard IEC 62305
- Tested in accordance with IEC 61643-21: D1, C2, C3
- Integrated PE foot, safely discharges up to 20 kA (8/20 μs) and 2.5 kA (10/350 μs) to PE

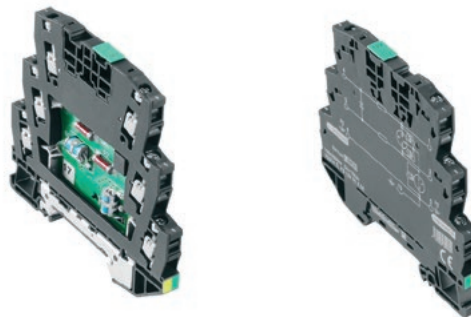

Technical data

Rated current I_N	500 mA
Volume resistance	1.8 Ω 10 %
Overload - failure mode	Modus 2
Requirements category acc. to IEC 61643-21	C2, C3, D1
Standards	IEC 61643-21, HART-compatible
Surge current-carrying capacity C1	
Surge current-carrying capacity C2	2.5 kA
Surge current-carrying capacity C3	50 A
Surge current-carrying capacity D1	0.5 kA
Discharge current I_t (8/20 μs) wire-wire/wire-PE/GND-PE	2.5 kA / 2.5 kA
Discharge I_{max} (8/20 μs) wire-wire/wire-PE/GND-PE	5 kA / 5 kA
Lightning test I_{imp} (10/350 μs) wire-wire/wire-PE/GND-PE	/ 0.5 kA
Storage temperature	-40 °C...80 °C
Ambient temperature (operational)	-40 °C...70 °C
Protection degree	IP20
UL 94 flammability rating	V-0

Connection data	
Type of connection	Screw connection
Tightening torque	0.5 Nm
Wire connection cross section, finely stranded, max.	4 mm ²
Wire connection cross-section, finely stranded, min.	0.5 mm ²
Wire cross-section, solid, max.	6 mm ²
Wire cross-section, solid, min.	0.5 mm ²
Wire cross-section, stranded, max.	4 mm ²
Wire cross-section, stranded, min.	0.5 mm ²
Stripping length	10 mm
Rail	TS 35

Failure probability	
λges	19
MTTF	6008
SIL in compliance with IEC 61508	2

Approvals	
Approvals	CE; CSAEX; FUSAFETY; DEVE; UL
Standards	IEC 61643-21, HART-compatible

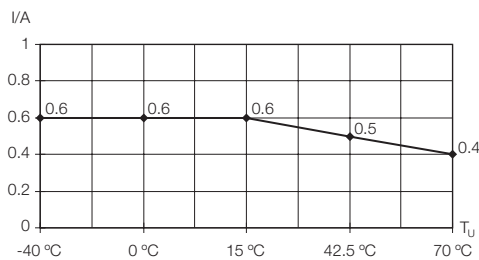
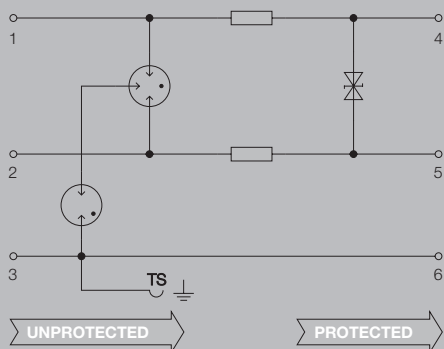
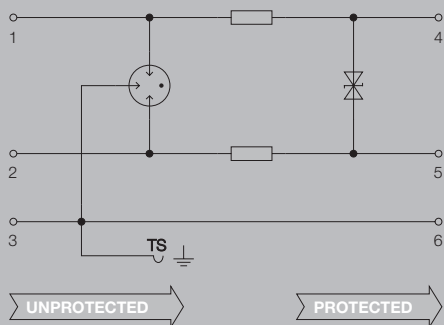

Dimensions	
Height x width x depth	mm 88.5 / 6.2 / 81

Note



VSSC 6 CL and CL FG

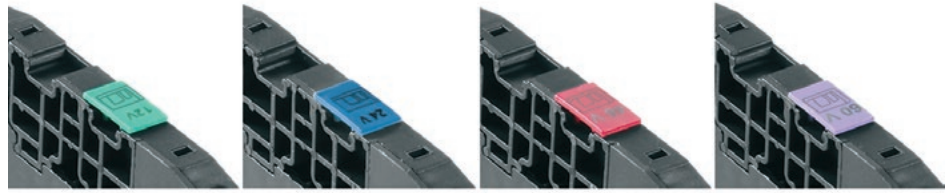

Lightning and surge protection for instrumentation and control (I & C)

Ordering data

	CL 12 V DC	CL 24 V UC	CL 48 V UC	CL 60 V UC
Rated voltage (AC)		24 V	48 V	60 V
Rated voltage (DC)	12 V	34 V	68 V	85 V
Max. continuous voltage, U _c (AC)		30 V	60 V	75 V
Max. continuous voltage, U _c (DC)	15 V	42 V	85 V	106 V
Rated current I _n	500 mA	500 mA	500 mA	500 mA
Optical function display	No	No	No	No
Isolating function	No	No	No	No
Input attenuation	≤ 700 kHz	3.4 MHz	5 Mhz	6.8 MHz
Pulse-reset capacity	≤ 20 ms	≤ 170 ms	≤ 150 ms	≤ 20 ms
Residual voltage, U _r typical	900 V	900 V	770 V	780 V

Ordering data	Type	VSSC6 CL 12VDC 0.5A	VSSC6 CL 24VAC/DC 0.5A	VSSC6 CL 48VAC/DC 0.5A	VSSC6 CL 60VAC/DC 0.5A
Order No.		1064150000	1064170000	1064190000	1064210000
Qty.		10	10	10	10
Note		End plate AP VSSC6 1063110000	End plate AP VSSC6 1063110000	End plate AP VSSC6 1063110000	End plate AP VSSC6 1063110000

Ordering data

	CLFG 12 V DC	CLFG 24 V UC	CLFG 48 V UC	CLFG 60 V UC
Rated voltage (AC)		24 V	48 V	60 V
Rated voltage (DC)	12 V	34 V	68 V	85 V
Max. continuous voltage, U _c (AC)		30 V	60 V	75 V
Max. continuous voltage, U _c (DC)	15 V	42 V	85 V	106 V
Rated current I _n	500 mA	500 mA	500 mA	500 mA
Optical function display	No	No	No	No
Isolating function	No	No	No	No
Input attenuation	≤ 700 kHz	3.4 MHz	5 Mhz	6.8 MHz
Pulse-reset capacity	≤ 20 ms	≤ 20 ms	≤ 20 ms	≤ 20 ms
Residual voltage, U _r typical	1600 V	1632 V	≤ 1510 V	≤ 1510 V

Ordering data	Type	VSSC6 CL FG 12VDC 0.5A	VSSC6 CLFG24VAC/DC0.5A	VSSC6 CLFG48VAC/DC0.5A	VSSC6 CLFG60VAC/DC0.5A
Order No.		1064260000	1064270000	1064280000	1064290000
Qty.		10	10	10	10
Note		End plate AP VSSC6 1063110000	End plate AP VSSC6 1063110000	End plate AP VSSC6 1063110000	End plate AP VSSC6 1063110000



VARITECTOR SSC 6AN

VSSC 6 TR CL and TR CL FG - protection for floating current loops

- Two-stage surge protection with screw connection for measurement and control signals
- Surge protection in terminal block design
- Modular width of only 6.2 mm
- Space-saving design: 1 analogue signal
- Torx® slotted screw connection
- Can be used in compliance with installation standard IEC 62305
- Tested in accordance with IEC 61643-21: D1, C2, C3
- Integrated PE foot, safely discharges up to 20 kA (8/20 μs) and 2.5 kA (10/350 μs) to PE

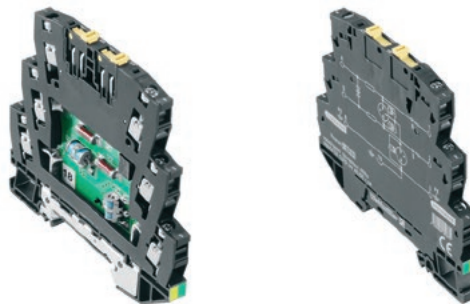

Technical data

Rated current I_N	500 mA
Volume resistance	1.8 Ω 10 %
Overload - failure mode	Modus 2
Requirements category acc. to IEC 61643-21	C2, C3, D1
Standards	IEC 61643-21, HART-compatible
Surge current-carrying capacity C1	
Surge current-carrying capacity C2	2.5 kA 8/20 μs 5 kV 1.2/50 μs
Surge current-carrying capacity C3	50 A 10/1000 μs
Surge current-carrying capacity D1	0.5 kA 10/350 μs
Discharge current I_d (8/20 μs) wire-wire/wire-PE/GND-PE	2.5 kA / 2.5 kA
Discharge current I_{dmax} (8/20 μs) wire-wire/wire-PE/GND-PE	5 kA / 5 kA
Lightning test I_{imp} (10/350 μs) wire-wire/wire-PE/GND-PE	/ 0.5 kA
Storage temperature	-40 °C...80 °C
Ambient temperature (operational)	-40 °C...70 °C
Protection degree	IP20
UL 94 flammability rating	V-0

Connection data	
Type of connection	Screw connection
Tightening torque	0.5 Nm
Wire connection cross section, finely stranded, max.	4 mm ²
Wire connection cross-section, finely stranded, min.	0.5 mm ²
Wire cross-section, solid, max.	6 mm ²
Wire cross-section, solid, min.	0.5 mm ²
Wire cross-section, stranded, max.	4 mm ²
Wire cross-section, stranded, min.	0.5 mm ²
Stripping length	10 mm
Rail	TS 35

Failure probability	
λges	19
MTTF	6008
SIL in compliance with IEC 61508	2

Approvals	
Approvals	CE; CSAEX; FUSAFETY; DEVE; UL
Standards	IEC 61643-21, HART-compatible

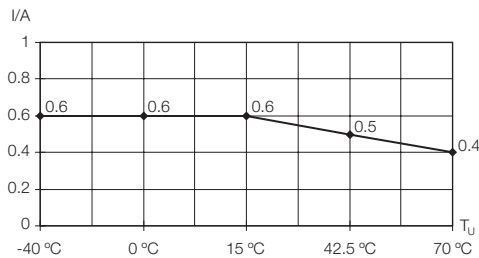
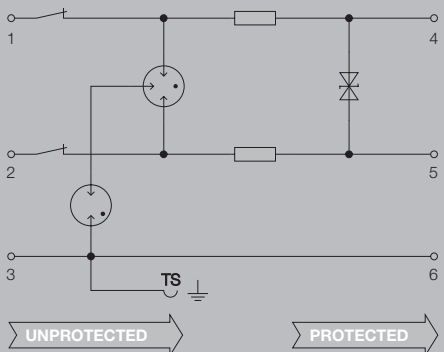
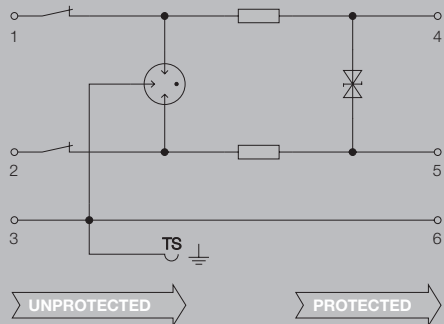

Dimensions	
Height x width x depth	mm 88.5 / 6.2 / 81

Note

C



VSSC 6TR CL and TR CL FG

Ordering data

	TR CL 12 V DC	TR CL 24 V UC	TR CL 48 V UC	TR CL 60 V UC
Rated voltage (AC)		24 V	48 V	60 V
Rated voltage (DC)	12 V	34 V	68 V	85 V
Max. continuous voltage, U_c (AC)		30 V	60 V	75 V
Max. continuous voltage, U_c (DC)	15 V	42 V	85 V	106 V
Rated current I_n	500 mA	500 mA	500 mA	500 mA
Optical function display	No	No	No	No
Isolating function	Yes	Yes	Yes	Yes
Input attenuation	270 Mhz	270 Mhz	270 Mhz	270 Mhz
Pulse-reset capacity	≤ 20 ms	≤ 170 ms	≤ 150 ms	≤ 20 ms
Residual voltage, U_r typical	900 V	900 V	770 V	780 V

Ordering data

	VSSC6 TR CL 12VDC 0.5A	VSSC6 TRCL24VAC/DC0.5A	VSSC6 TRCL48VAC/DC0.5A	VSSC6 TRCL60VAC/DC0.5A
Type	VSSC6 TR CL 12VDC 0.5A	VSSC6 TRCL24VAC/DC0.5A	VSSC6 TRCL48VAC/DC0.5A	VSSC6 TRCL60VAC/DC0.5A
Order No.	1064220000	1064230000	1064240000	1064250000
Qty.	10	10	10	10
Note	End plate AP VSSC6 1063110000	End plate AP VSSC6 1063110000	End plate AP VSSC6 1063110000	End plate AP VSSC6 1063110000

Ordering data

	TR CLFG 12 V DC	TR CLFG 24 V UC	TR CLFG 48 V UC	TR CLFG 60 V UC
Rated voltage (AC)		24 V	48 V	60 V
Rated voltage (DC)	12 V	34 V	68 V	85 V
Max. continuous voltage, U_c (AC)		30 V	60 V	75 V
Max. continuous voltage, U_c (DC)	15 V	42 V	85 V	106 V
Rated current I_n	500 mA	500 mA	500 mA	500 mA
Optical function display	No	No	No	No
Isolating function	Yes	Yes	Yes	Yes
Input attenuation	270 Mhz	270 Mhz	270 Mhz	270 Mhz
Pulse-reset capacity	≤ 20 ms	≤ 20 ms	≤ 20 ms	≤ 20 ms
Residual voltage, U_r typical	≤ 1.7 kV	≤ 1650 V	≤ 1550 V	≤ 1550 V

Ordering data

	VSSC6TRCLFG12VDC0.5A	VSSC6TRCLFG24VAC/DC0.5A	VSSC6TRCLFG48VAC/DC0.5A	VSSC6TRCLFG60VAC/DC0.5A
Type	VSSC6TRCLFG12VDC0.5A	VSSC6TRCLFG24VAC/DC0.5A	VSSC6TRCLFG48VAC/DC0.5A	VSSC6TRCLFG60VAC/DC0.5A
Order No.	1064300000	1064310000	1064320000	1064330000
Qty.	10	10	10	10
Note	End plate AP VSSC6 1063110000	End plate AP VSSC6 1063110000	End plate AP VSSC6 1063110000	End plate AP VSSC6 1063110000



VSSC 6 SL and SL FG - protection for binary signals with signal display

- One-stage surge protection with screw connection for measurement and control signals
- Surge protection in terminal block design
- Modular width of only 6.2 mm
- Space-saving design for two signals
- Torx® slotted screw connection
- Can be used in compliance with installation standard IEC 62305
- Tested in accordance with IEC 61643-21: C1, C2
- Integrated PE foot, safely discharges up to 20 kA (8/20 μs) and 2.5 kA (10/350 μs) to PE

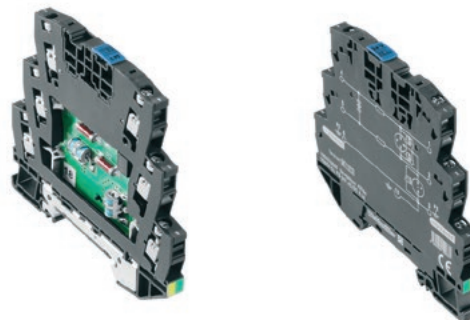

Technical data

Rated current I_N	500 mA
Volume resistance	1.8 n 10 %
Overload - failure mode	Modus 2
Requirements category acc. to IEC 61643-21	C2, C3, D1
Standards	IEC 61643-21
Surge current-carrying capacity C1	
Surge current-carrying capacity C2	2.5 kA 8/20 μs
Surge current-carrying capacity C3	10 A 10/1000 μs
Surge current-carrying capacity D1	1 kA 10/350 μs
Discharge current I_t (8/20 μs) wire-wire/wire-PE/GND-PE	/ 2.5 kA
Discharge I_{max} (8/20 μs) wire-wire/wire-PE/GND-PE	/ 10 kA
Lightning test I_{imp} (10/350 μs) wire-wire/wire-PE/GND-PE	/ 1 kA
Storage temperature	-40 °C...80 °C
Ambient temperature (operational)	-40 °C...70 °C
Protection degree	IP20
UL 94 flammability rating	V-0

Connection data

Type of connection	Screw connection
Tightening torque	0.5 Nm
Wire connection cross section, finely stranded, max.	4 mm ²
Wire connection cross-section, finely stranded, min.	0.5 mm ²
Wire cross-section, solid, max.	6 mm ²
Wire cross-section, solid, min.	0.5 mm ²
Wire cross-section, stranded, max.	4 mm ²
Wire cross-section, stranded, min.	0.5 mm ²
Stripping length	10 mm
Rail	TS 35

Failure probability

λges	54
MTTF	2114
SIL in compliance with IEC 61508	3

Approvals

Approvals	CE; CSAEX; FUSAFETY; DEVE; UL
Standards	IEC 61643-21

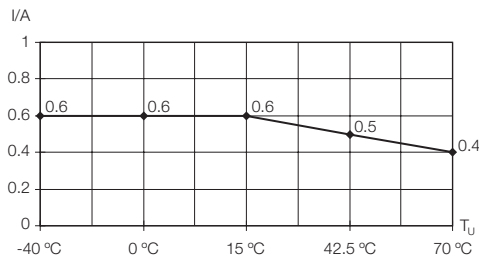
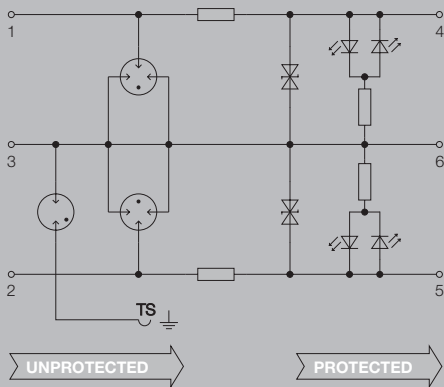
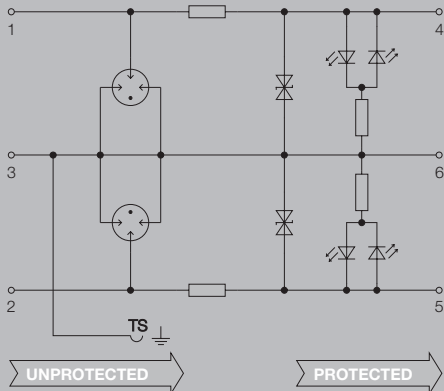

Dimensions

Height x width x depth	mm	88.5 / 6.2 / 81
------------------------	----	-----------------

Note



VSSC 6 SL and SL FG

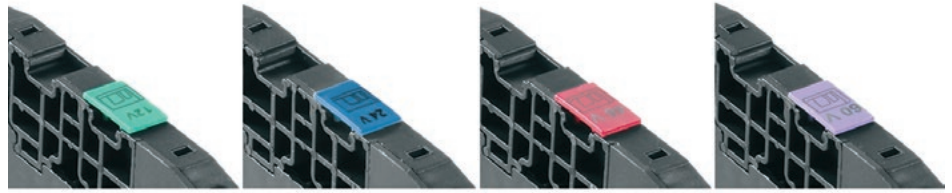

Lightning and surge protection for instrumentation and control (I & C)

Ordering data

Rated voltage (AC)
 Rated voltage (DC)
 Max. continuous voltage, U_c (AC)
 Max. continuous voltage, U_c (DC)
 Rated current I_n
 Optical function display
 Isolating function
 Input attenuation
 Pulse-reset capacity
 Residual voltage, U_r typical

	SL LD 12 V DC	SL LD 24 V UC	SLFG LD 12 V DC	SLFG LD 24 V UC
		24 V		24 V
	12 V	34 V	12 V	34 V
		30 V		30 V
	15 V	42 V	15 V	42 V
	500 mA	500 mA	500 mA	500 mA
	Yes	Yes	Yes	Yes
	No	No	No	No
	750 KHz	3.2 MHz	750 KHz	3.2 MHz
	≤ 20 ms	≤ 20 ms	≤ 20 ms	≤ 20 ms
	≤ 100 V	150 V	≤ 100 V	150 V

Ordering data	Type	Order No.	Qty.
	VSSC6SL LD 12VDC 0.5A	1064340000	10
Note	End plate AP VSSC6 1063110000		

Ordering data	Type	Order No.	Qty.
	VSSC6SL LD24VAC/DC0.5A	1064350000	10
Note	End plate AP VSSC6 1063110000		

Ordering data	Type	Order No.	Qty.
	VSSC6SL FG LD12VDC0.5A	1064420000	10
Note	End plate AP VSSC6 1063110000		

Ordering data	Type	Order No.	Qty.
	VSSC6SLFG LD24VAC/DC0.5A	1064430000	10
Note	End plate AP VSSC6 1063110000		

Ordering data

Rated voltage (AC)
 Rated voltage (DC)
 Max. continuous voltage, U_c (AC)
 Max. continuous voltage, U_c (DC)
 Rated current I_n
 Optical function display
 Isolating function
 Input attenuation
 Pulse-reset capacity
 Residual voltage, U_r typical

	SLFG LD 48 V UC
	48 V
	68 V
	60 V
	85 V
	500 mA
	Yes
	No
	4.6 MHz
	≤ 20 ms
	< 200 V

Ordering data	Type	Order No.	Qty.
	VSSC6SLFLD48VAC/DC0.5A	1064440000	10
Note	End plate AP VSSC6 1063110000		

Ordering data	Type	Order No.	Qty.
	VSSC6SLFLD48VAC/DC0.5A	1064440000	10
Note	End plate AP VSSC6 1063110000		

VSSC 6 TR SL and TR SL FG - protection for floating signals with signal display

- Two-stage surge protection with screw connection for measurement and control signals with signal display
- Surge protection in terminal block design
- Modular width of only 6.2 mm
- Space-saving design for two signals
- Torx® slotted screw connection
- Can be used in compliance with installation standard IEC 62305
- Tested in accordance with IEC 61643-21: D1, C2, C3
- Integrated PE foot, safely discharges up to 20 kA (8/20 µs) and 2.5 kA (10/350 µs) to PE

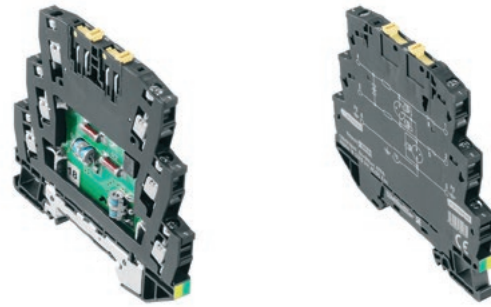

Technical data

Rated current I_N	500 mA
Volume resistance	1.8 n 10 %
Overload - failure mode	Modus 2
Requirements category acc. to IEC 61643-21	C2, C3, D1
Standards	IEC 61643-21
Surge current-carrying capacity C1	
Surge current-carrying capacity C2	2.5 kA 8/20 µs 5 kV 1.2/50 µs
Surge current-carrying capacity C3	10 A 10/1000 µs
Surge current-carrying capacity D1	1 kA 10/350 µs
Discharge current I_d (8/20 µs) wire-wire/wire-PE/GND-PE	/ 2.5 kA
Discharge I_{max} (8/20 µs) wire-wire/wire-PE/GND-PE	/ 10 kA
Lightning test I_{imp} (10/350 µs) wire-wire/wire-PE/GND-PE	/ 1 kA
Storage temperature	-40 °C...80 °C
Ambient temperature (operational)	-40 °C...70 °C
Protection degree	IP20
UL 94 flammability rating	V-0

Connection data	
Type of connection	Screw connection
Tightening torque	0.5 Nm
Wire connection cross section, finely stranded, max.	4 mm ²
Wire connection cross-section, finely stranded, min.	0.5 mm ²
Wire cross-section, solid, max.	6 mm ²
Wire cross-section, solid, min.	0.5 mm ²
Wire cross-section, stranded, max.	4 mm ²
Wire cross-section, stranded, min.	0.5 mm ²
Stripping length	10 mm
Rail	TS 35

Failure probability	
λges	54
MTTF	2114
SIL in compliance with IEC 61508	3

Approvals	
Approvals	CE; CSAEX; FUSAFETY; DEVE; UL
Standards	IEC 61643-21

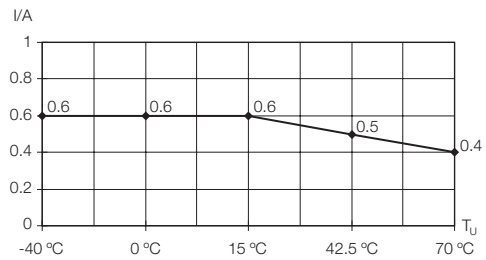
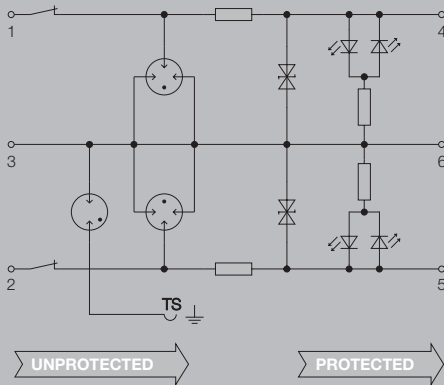
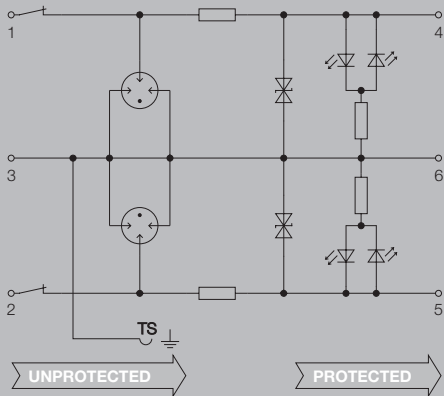

Dimensions	
Height x width x depth	mm 88.5 / 6.2 / 81

Note



VSSC 6 TR SL and TR CL FG

Ordering data

	TR SL LD 12 V DC	TR SL LD 24 V UC	TR SL 24 V AC	TR SL LD 48 V UC
Rated voltage (AC)		24 V	24 V	48 V
Rated voltage (DC)	12 V	34 V	34 V	68 V
Max. continuous voltage, U_c (AC)		30 V	30 V	60 V
Max. continuous voltage, U_c (DC)	15 V	42 V	42 V	85 V
Rated current I_n	500 mA	500 mA	500 mA	500 mA
Optical function display	Yes	Yes	No	Yes
Isolating function	Yes	Yes	Yes	Yes
Input attenuation	750 KHz	3.2 MHz	3.2 MHz	4.6 MHz
Pulse-reset capacity	≤ 20 ms	≤ 20 ms	≤ 20 ms	≤ 20 ms
Residual voltage, U_r typical	≤ 100 V	150 V	150 V	< 200 V

Ordering data

	TR SL LD 12 V DC	TR SL LD 24 V UC	TR SL 24 V AC	TR SL LD 48 V UC
Type	VSSC6TRSLD12VDC0.5A	VSSC6TRSLD24VAC/DC0.5A	VSSC6TRSL24VAC/DC0.5A	VSSC6TRSLD48VAC/DC0.5A
Order No.	1064380000	1064390000	1354790000	1064400000
Qty.	10	10	10	10
Note	End plate AP VSSC6 1063110000	End plate AP VSSC6 1063110000	End plate AP VSSC6 1063110000	End plate AP VSSC6 1063110000

Ordering data

	TR SLFG LD 12 V DC	TR SLFG LD 24 V UC	TR SL FG 24 V AC
Rated voltage (AC)		24 V	24 V
Rated voltage (DC)	12 V	34 V	34 V
Max. continuous voltage, U_c (AC)		30 V	30 V
Max. continuous voltage, U_c (DC)	15 V	42 V	42 V
Rated current I_n	500 mA	500 mA	500 mA
Optical function display	Yes	Yes	No
Isolating function	Yes	Yes	Yes
Input attenuation	750 KHz	3.2 MHz	3.2 MHz
Pulse-reset capacity	≤ 20 ms	≤ 20 ms	≤ 20 ms
Residual voltage, U_r typical	≤ 100 V	150 V	150 V

Ordering data

	TR SLFG LD 12 V DC	TR SLFG LD 24 V UC	TR SL FG 24 V AC
Type	VSSC6TRSLFGLD12VDC0.5A	VSSC6TRSLFGLD24VUC 0.5A	VSSC6TRSLFG24VAC/DC0.5A
Order No.	1064490000	1064500000	1354800000
Qty.	10	10	10
Note	End plate AP VSSC6 1063110000	End plate AP VSSC6 1063110000	End plate AP VSSC6 1063110000



VSSC 6 MOV - protection with Varistor (MOV)

- One-stage surge protection with screw connection for measurement and control signals
- Surge protection in terminal block design
- Modular width of only 6.2 mm
- Space-saving design for two signals
- Torx® slotted screw connection
- Can be used in compliance with installation standard IEC 62305
- Tested in accordance with IEC 61643-21: C1, C2
- Integrated PE foot, safely discharges up to 20 kA (8/20 μs) and 2.5 kA (10/350 μs) to PE

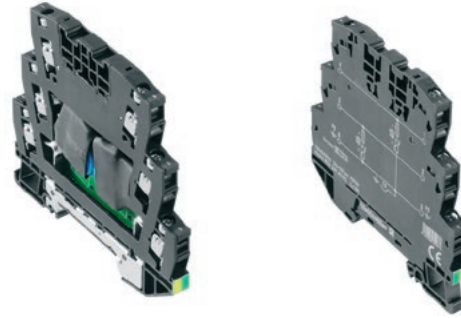

Technical data

Rated current I_N	12 A
Volume resistance	<0.1 Ω
Overload - failure mode	Mode 1
Requirements category acc. to IEC 61643-21	C1
Standards	According to IEC61643-21
Surge current-carrying capacity C1	0.25 kA 8/20 μs 0.5 kV 1.2/50 μs
Surge current-carrying capacity C2	
Surge current-carrying capacity C3	
Surge current-carrying capacity D1	
Discharge current I_d (8/20 μs) wire-wire/wire-PE/GND-PE	/ 0.5 kA
Discharge I_{dmax} (8/20 μs) wire-wire/wire-PE/GND-PE	/ 1 kA
Lightning test I_{imp} (10/350 μs) wire-wire/wire-PE/GND-PE	/
Storage temperature	-40 °C...80 °C
Ambient temperature (operational)	-40 °C...70 °C
Protection degree	IP20
UL 94 flammability rating	V-0

Connection data	
Type of connection	Screw connection
Tightening torque	0.5 Nm
Wire connection cross section, finely stranded, max.	4 mm ²
Wire connection cross-section, finely stranded, min.	0.5 mm ²
Wire cross-section, solid, max.	6 mm ²
Wire cross-section, solid, min.	0.5 mm ²
Wire cross-section, stranded, max.	4 mm ²
Wire cross-section, stranded, min.	0.5 mm ²
Stripping length	10 mm
Rail	TS 35

Failure probability	
λges	26
MTTF	4391
SIL in compliance with IEC 61508	3

Approvals	
Approvals	CE; CSAEX; FUSAFETY; DEVE; UL
Standards	According to IEC61643-21

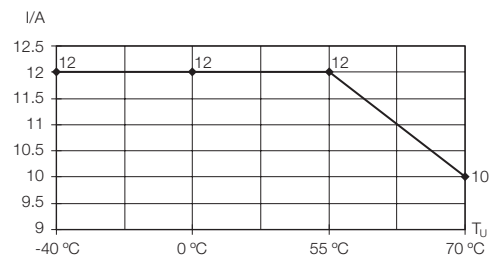
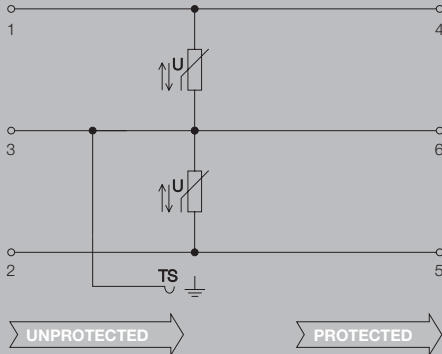

Dimensions	
Height x depth	mm 88.5 / 81

Note	
-------------	--



VSSC 6 MOV

Ordering data

	MOV 12 V DC	MOV 24 V UC	MOV 48 V UC	MOV 60 V UC
Rated voltage (AC)		24 V	48 V	60 V
Rated voltage (DC)	12 V	34 V	68 V	85 V
Max. continuous voltage, U _c (AC)		30 V	60 V	75 V
Max. continuous voltage, U _c (DC)	15 V	42 V	85 V	106 V
Rated current I _n	12 A	12 A	12 A	12 A
Optical function display	No	No	No	No
Isolating function	No	No	No	No
Input attenuation				
Pulse-reset capacity				
Protection level U _p (typ.)	≤ 100 V	150 V	250 V	≤ 300 V
Capacitance	10.8 nF	4.6 nF	2.0 nF	1.78 nF
Width	7.2 mm	7.2 mm	7.2 mm	7.2 mm

Ordering data	VSSC6 MOV 12VDC	VSSC6 MOV 24VAC/DC	VSSC6 MOV 48VAC/DC	VSSC6 MOV 60VAC/DC
Type	VSSC6 MOV 12VDC	VSSC6 MOV 24VAC/DC	VSSC6 MOV 48VAC/DC	VSSC6 MOV 60VAC/DC
Order No.	1064530000	1064540000	1064570000	1064600000
Qty.	8	8	8	8
Note	End plate AP VSSC6 1063110000	End plate AP VSSC6 1063110000	End plate AP VSSC6 1063110000	End plate AP VSSC6 1063110000

Ordering data

	MOV 120 V UC	MOV 240 V UC
Rated voltage (AC)	120 V	240 V
Rated voltage (DC)	170 V	339 V
Max. continuous voltage, U _c (AC)	150 V	288 V
Max. continuous voltage, U _c (DC)	212 V	407 V
Rated current I _n	12 A	12 A
Optical function display	No	No
Isolating function	No	No
Input attenuation		
Pulse-reset capacity		
Protection level U _p (typ.)	< 600 V	≤ 1200 V
Capacitance	283 pF	0.5 nF
Width	12.4 mm	12.4 mm

Ordering data	VSSC6 MOV 120VAC/DC	VSSC6 MOV 240VAC/DC
Type	VSSC6 MOV 120VAC/DC	VSSC6 MOV 240VAC/DC
Order No.	1064610000	1064630000
Qty.	5	5
Note	End plate AP VSSC6 1063110000	End plate AP VSSC6 1063110000



VARITECTOR SSC 6AN

VSSC 6 TR LD MOV - protection with varistor (MOV)

- One-stage surge protection with screw connection for measurement and control signals
- Surge protection in terminal block design
- Modular width of only 6.2 mm
- Space-saving design for two signals
- Torx® slotted screw connection
- Can be used in compliance with installation standard IEC 62305
- Tested in accordance with IEC 61643-21: C1, C2
- Integrated PE foot, safely discharges up to 20 kA (8/20 µs) and 2.5 kA (10/350 µs) to PE

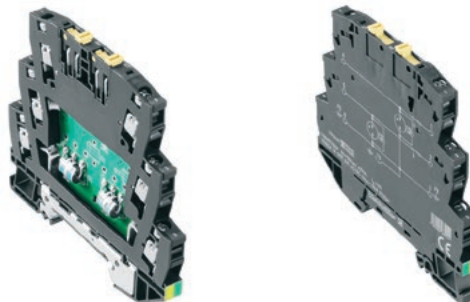

C

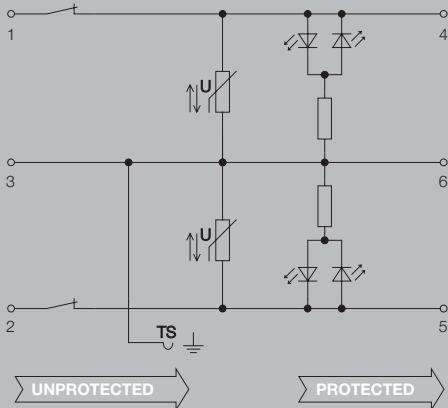

Technical data

Rated current I_N	12 A
Volume resistance	<0.1 Ω
Overload - failure mode	Mode 1
Requirements category acc. to IEC 61643-21	C1
Standards	IEC 61643-21
Surge current-carrying capacity C1	0.25 kA 8/20 µs 0.5 kV 1.2/50 µs
Surge current-carrying capacity C2	1.5 kA 8/20 µs
Surge current-carrying capacity C3	
Surge current-carrying capacity D1	
Discharge current I_d (8/20 µs) wire-wire/wire-PE/GND-PE	/ 0.5 kA
Discharge I_{dmax} (8/20 µs) wire-wire/wire-PE/GND-PE	/ 1 kA
Lightning test I_{imp} (10/350 µs) wire-wire/wire-PE/GND-PE	/
Storage temperature	-40 °C...80 °C
Ambient temperature (operational)	-40 °C...70 °C
Protection degree	IP20
UL 94 flammability rating	V-0

Connection data	
Type of connection	Screw connection
Tightening torque	0.5 Nm
Wire connection cross section, finely stranded, max.	4 mm ²
Wire connection cross-section, finely stranded, min.	0.5 mm ²
Wire cross-section, solid, max.	6 mm ²
Wire cross-section, solid, min.	0.5 mm ²
Wire cross-section, stranded, max.	4 mm ²
Wire cross-section, stranded, min.	0.5 mm ²
Stripping length	10 mm
Rail	TS 35

Failure probability	
λges	37
MTTF	3085
SIL in compliance with IEC 61508	3

Approvals	
Approvals	CE; CSAEX; FUSAFETY; DEVE; UL
Standards	IEC 61643-21

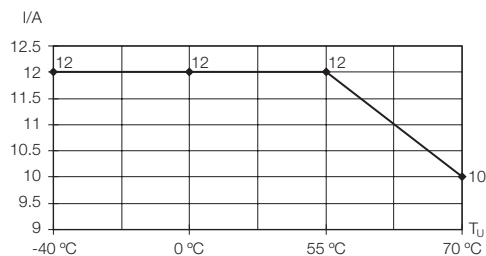

Dimensions	
Height x depth	mm 88.5 / 81

Note

VSSC 6 TR LD MOV

Ordering data

	TR LD MOV 12 V DC	TR LD MOV 24 V UC	TR LD MOV 48 V UC	TR LD MOV 120 V UC
Rated voltage (AC)		24 V	48 V	120 V
Rated voltage (DC)	12 V	34 V	68 V	170 V
Max. continuous voltage, U_c (AC)		30 V	60 V	150 V
Max. continuous voltage, U_c (DC)	15 V	42 V	85 V	212 V
Rated current I_n	12 A	12 A	12 A	12 A
Optical function display	Yes	Yes	Yes	Yes
Isolating function	Yes	Yes	Yes	Yes
Input attenuation				
Pulse-reset capacity				
Protection level U_p (typ.)	≤ 100 V	150 V	250 V	< 600 V
Capacitance	10.8 nF	4.6 nF	2.0 nF	283 pF
Width	7.2 mm	7.2 mm	7.2 mm	12.4 mm

Ordering data

	VSSC6 TRLDMOV 12VDC	VSSC6 TRLDMOV 24VAC/DC	VSSC6 TRLDMOV 48VAC/DC	VSSC6 TRLDMOV120VAC/DC
Type	VSSC6 TRLDMOV 12VDC	VSSC6 TRLDMOV 24VAC/DC	VSSC6 TRLDMOV 48VAC/DC	VSSC6 TRLDMOV120VAC/DC
Order No.	1064800000	1064810000	1064820000	1064840000
Qty.	8	8	8	5
Note	End plate AP VSSC6 1063110000	End plate AP VSSC6 1063110000	End plate AP VSSC6 1063110000	End plate AP VSSC6 1063110000

Ordering data

	TR LD MOV 240 V UC
Rated voltage (AC)	240 V
Rated voltage (DC)	339 V
Max. continuous voltage, U_c (AC)	288 V
Max. continuous voltage, U_c (DC)	407 V
Rated current I_n	12 A
Optical function display	Yes
Isolating function	Yes
Input attenuation	
Pulse-reset capacity	
Protection level U_p (typ.)	≤ 1200 V
Capacitance	0.5 nF
Width	12.4 mm

Ordering data

	VSSC6 TRLDMOV240VAC/DC
Type	VSSC6 TRLDMOV240VAC/DC
Order No.	1064860000
Qty.	5
Note	End plate AP VSSC6 1063110000



VARITECTOR SSC 6AN

VSSC 6 GDT - protection with sparkover gap (GDT)

- One-stage surge protection with screw connection for measurement and control signals
- Surge protection in terminal block design
- Modular width of only 12.4 mm
- Space-saving design for two signals
- Torx® slotted screw connection
- Can be used in compliance with installation standard IEC 62305
- Tested in accordance with IEC 61643-21: D1, C2, C3
- Integrated PE foot, safely discharges up to 20 kA (8/20 μs) and 2.5 kA (10/350 μs) to PE

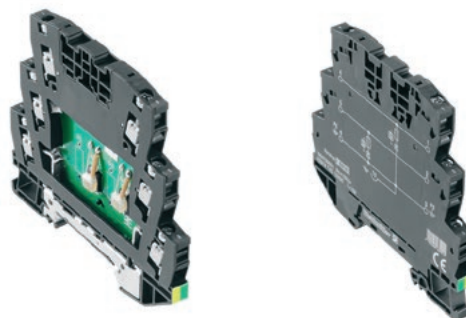

C

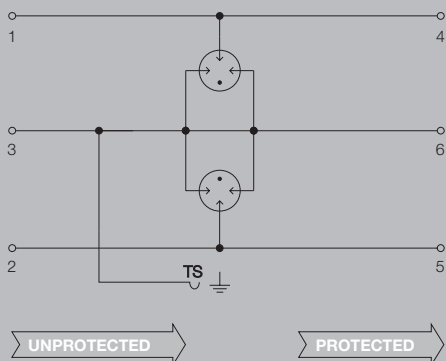

Technical data

Rated current I_N	12 A
Volume resistance	<0.1 Ω
Overload - failure mode	Modus 2
Requirements category acc. to IEC 61643-21	C2, C3, D1
Standards	IEC 61643-21
Surge current-carrying capacity C1	
Surge current-carrying capacity C2	2.5 kA 8/20 μs 5 kV 1.2/50 μs
Surge current-carrying capacity C3	50 A 10/1000 μs
Surge current-carrying capacity D1	1 kA 10/350 μs
Discharge current I_d (8/20 μs) wire-wire/wire-PE/GND-PE	/ 2.5 kA
Discharge I_{dmax} (8/20 μs) wire-wire/wire-PE/GND-PE	/ 10 kA
Lightning test I_{imp} (10/350 μs) wire-wire/wire-PE/GND-PE	/ 1 kA
Storage temperature	-40 °C...80 °C
Ambient temperature (operational)	-40 °C...70 °C
Protection degree	IP20
UL 94 flammability rating	V-0

Connection data	
Type of connection	Screw connection
Tightening torque	0.5 Nm
Wire connection cross section, finely stranded, max.	4 mm ²
Wire connection cross-section, finely stranded, min.	0.5 mm ²
Wire cross-section, solid, max.	6 mm ²
Wire cross-section, solid, min.	0.5 mm ²
Wire cross-section, stranded, max.	4 mm ²
Wire cross-section, stranded, min.	0.5 mm ²
Stripping length	10 mm
Rail	TS 35

Failure probability	
ages	10
MTTF	11416
SIL in compliance with IEC 61508	3

Approvals	
Approvals	CE; CSAEX; FUSAFETY
Standards	IEC 61643-21

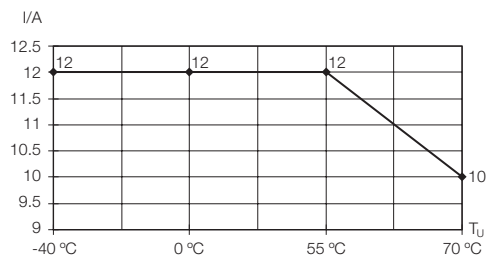

Dimensions	
Height x depth	mm 88.5 / 81

Note

VSSC 6 GDT

Ordering data

	GDT 24 V UC 10 kA	GDT 110 V UC 10 kA	GDT 240 V UC 10 kA	GDT 110 V UC 20 kA
Rated voltage (AC)	24 V	110 V	240 V	110 V
Rated voltage (DC)	34 V	156 V	339 V	156 V
Max. continuous voltage, U _c (AC)	30 V	138 V	288 V	138 V
Max. continuous voltage, U _c (DC)	42 V	195 V	407 V	195 V
Rated current I _n	12 A	12 A	12 A	12 A
Optical function display	No	No	No	No
Isolating function	No	No	No	No
Input attenuation				
Pulse-reset capacity				
Protection level U _p (typ.)	< 1000 V	≤ 1200 V	≤ 1900 V	< 1000 V
Capacitance	1.5 nF	4.2 nF	3.0 nF	2.5 nF
Width	6.2 mm	6.2 mm	12.4 mm	12.4 mm

Ordering data				
Type	VSSC6 GDT 24VAC/DC 10KA	VSSC6 GDT 110VAC/DC10KA	VSSC6 GDT 240VAC/DC10KA	VSSC6 GDT 110VAC/DC20KA
Order No.	1064640000	1064690000	1064710000	1064700000
Qty.	10	10	5	5
Note	End plate AP VSSC6 1063110000	End plate AP VSSC6 1063110000	End plate AP VSSC6 1063110000	End plate AP VSSC6 1063110000

Ordering data

	GDT 240 V UC 20 kA
Rated voltage (AC)	240 V
Rated voltage (DC)	339 V
Max. continuous voltage, U _c (AC)	288 V
Max. continuous voltage, U _c (DC)	407 V
Rated current I _n	12 A
Optical function display	No
Isolating function	No
Input attenuation	
Pulse-reset capacity	
Protection level U _p (typ.)	≤ 1900 V
Capacitance	2.4 nF
Width	12.4 mm

Ordering data	
Type	VSSC6 GDT 240VAC/DC20KA
Order No.	1064720000
Qty.	5
Note	End plate AP VSSC6 1063110000



VARITECTOR SSC 6AN

VSSC 6 TR GDT - protection with sparkover gap (GDT)

- One-stage surge protection with screw connection for measurement and control signals
- Surge protection in terminal block design
- Modular width of only 6.2 mm or 12.4 mm
- Space-saving design for two signals
- Torx® slotted screw connection
- Can be used in compliance with installation standard IEC 62305
- Tested in accordance with IEC 61643-21: D1, C2, C3
- Integrated PE foot, safely discharges up to 20 kA (8/20 µs) and 2.5 kA (10/350 µs) to PE



C

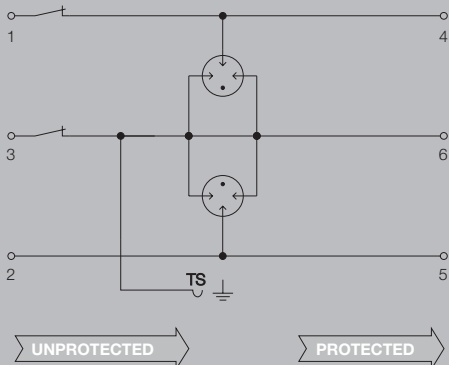

Technical data

Rated current I_N	12 A
Volume resistance	<0.1 Ω
Overload - failure mode	Modus 2
Requirements category acc. to IEC 61643-21	C2, C3, D1
Standards	IEC 61643-21
Surge current-carrying capacity C1	
Surge current-carrying capacity C2	2.5 kA 8/20 µs 5 kV 1.2/50 µs
Surge current-carrying capacity C3	50 A 10/1000 µs
Surge current-carrying capacity D1	1 kA 10/350 µs
Discharge current I_d (8/20 µs) wire-wire/wire-PE/GND-PE	/ 2.5 kA
Discharge I_{dmax} (8/20 µs) wire-wire/wire-PE/GND-PE	/ 10 kA
Lightning test I_{imp} (10/350 µs) wire-wire/wire-PE/GND-PE	/ 1 kA
Storage temperature	-40 °C...80 °C
Ambient temperature (operational)	-40 °C...80 °C
Protection degree	IP20
UL 94 flammability rating	V-0

Connection data	
Type of connection	Screw connection
Tightening torque	0.5 Nm
Wire connection cross section, finely stranded, max.	4 mm ²
Wire connection cross-section, finely stranded, min.	0.5 mm ²
Wire cross-section, solid, max.	6 mm ²
Wire cross-section, solid, min.	0.5 mm ²
Wire cross-section, stranded, max.	4 mm ²
Wire cross-section, stranded, min.	0.5 mm ²
Stripping length	10 mm
Rail	TS 35

Failure probability	
λges	10
MTTF	11416
SIL in compliance with IEC 61508	3

Approvals	
Approvals	CE; CSAEX; FUSAFETY
Standards	IEC 61643-21

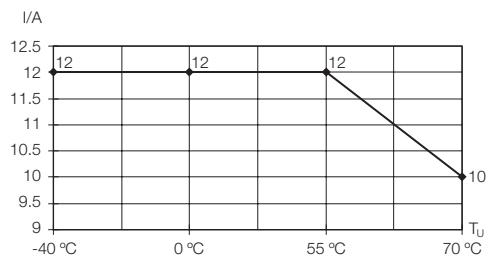

Dimensions	
Height x depth	mm 88.5 / 81

Note

VSSC 6 TR GDT

Ordering data

	TR GDT 24 V UC 10 kA	TR GDT 110 V UC 10 kA	TR GDT 240 V UC 10 kA
Rated voltage (AC)	24 V	110 V	240 V
Rated voltage (DC)	34 V	156 V	339 V
Max. continuous voltage, U_c (AC)	30 V	138 V	288 V
Max. continuous voltage, U_c (DC)	42 V	195 V	407 V
Rated current I_n	12 A	12 A	12 A
Optical function display	No	No	No
Isolating function	Yes	Yes	Yes
Input attenuation			
Pulse-reset capacity			
Protection level U_p (typ.)	< 1000 V	≤ 1200 V	≤ 1900 V
Capacitance	1.5 nF	4.2 nF	3.0 nF
Width	6.2 mm	6.2 mm	12.4 mm

Ordering data			
Type	VSSC6TRGDT24VAC/DC10KA	VSSC6TRGDT110VAC/DC10KA	VSSC6TRGDT240VAC/DC10KA
Order No.	1064870000	1064890000	1064920000
Qty.	10	10	5
Note	End plate AP VSSC6 1063110000	End plate AP VSSC6 1063110000	End plate AP VSSC6 1063110000

C



VSSC 6 TAZ and TR TAZ - suppressor diode, with and without isolation option (TR)

- Two-stage surge protection with screw connection for PROFIBUS RS422/485 data interfaces
- Surge protection in terminal block design
- Modular width of only 6.2 mm
- Space-saving design: 1 signal
- Torx® slotted screw connection
- Can be used in compliance with installation standard IEC 62305
- Tested in accordance with IEC 61643-21
- Integrated PE foot, safely discharges up to 20 kA (8/20 μs) and 2.5 kA (10/350 μs) to PE

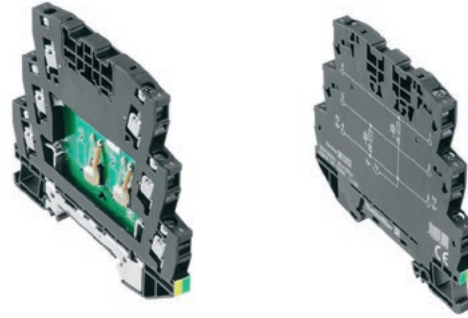

Technical data

Rated current I_N	12 A
Volume resistance	<0.1 Ω
Overload - failure mode	Mode 1
Requirements category acc. to IEC 61643-21	C3
Standards	According to IEC61643-21
Surge current-carrying capacity C1	
Surge current-carrying capacity C2	
Surge current-carrying capacity C3	50 A 10/1000 μs
Surge current-carrying capacity D1	
Discharge current I_t (8/20 μs) wire-wire/wire-PE/GND-PE	/ 0.2 kA
Discharge I_{max} (8/20 μs) wire-wire/wire-PE/GND-PE	/ 0.5 kA
Lightning test I_{imp} (10/350 μs) wire-wire/wire-PE/GND-PE	/
Storage temperature	-40 °C...80 °C
Ambient temperature (operational)	-40 °C...70
Protection degree	IP20
UL 94 flammability rating	V-0

Connection data	
Type of connection	Screw connection
Tightening torque	0.5 Nm
Wire connection cross section, finely stranded, max.	4 mm ²
Wire connection cross-section, finely stranded, min.	0.5 mm ²
Wire cross-section, solid, max.	6 mm ²
Wire cross-section, solid, min.	0.5 mm ²
Wire cross-section, stranded, max.	4 mm ²
Wire cross-section, stranded, min.	0.5 mm ²
Stripping length	10 mm
Rail	TS 35

Failure probability	
λges	32
MTTF	3567
SIL in compliance with IEC 61508	3

Approvals	
Approvals	CE; CSAEX; FUSAFETY; DEVE; UL
Standards	According to IEC61643-21

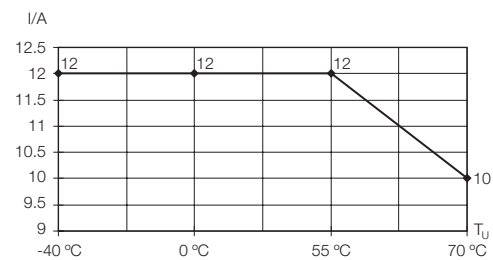
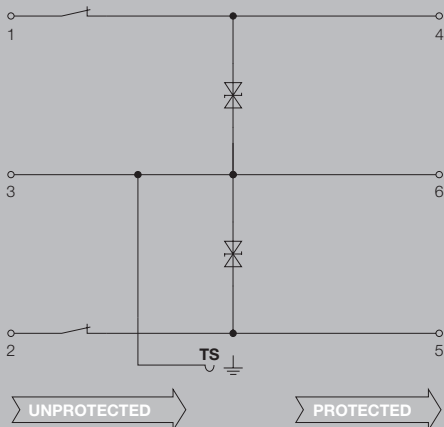
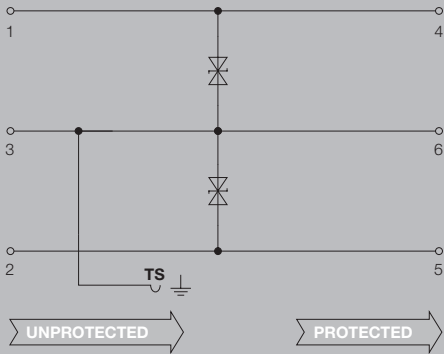

Dimensions	
Height x width x depth	mm 88.5 / 6.2 / 81

Note



VSSC 6 TAZ and TR LD TAZ

Ordering data

	TAZ 12 V DC	TAZ 24 V UC	TR LD TAZ 24 V UC
Rated voltage (AC)		24 V	24 V
Rated voltage (DC)	12 V	34 V	34 V
Max. continuous voltage, U_c (AC)		30 V	30 V
Max. continuous voltage, U_c (DC)	15 V	42 V	42 V
Rated current I_N	12 A	12 A	12 A
Optical function display	No	No	Yes
Isolating function	No	No	Yes
Residual voltage, U_r typical	< 50 V	70 V	≤ 100 V
Capacitance	4.9 pF	0.8 nF	0.8 nF

Ordering data	VSSC6 TAZ 12VDC	VSSC6 TAZ 24VAC/DC	VSSC6 TRLDTAZ 24VAC/DC
Type	VSSC6 TAZ 12VDC	VSSC6 TAZ 24VAC/DC	VSSC6 TRLDTAZ 24VAC/DC
Order No.	1064730000	1064740000	1064950000
Qty.	10	10	10
Note	End plate AP VSSC6 1063110000	End plate AP VSSC6 1063110000	End plate AP VSSC6 1063110000



VSSC 6 RS485 - protection for RS232/RS485 signal interfaces

- Two-stage surge protection with screw connection for RS422/RS485 data interfaces
- Surge protection in terminal block design
- Modular width of only 6.2 mm
- Space-saving design: 1 signal
- Torx® slotted screw connection
- Can be used in compliance with installation standard IEC 62305
- Tested in accordance with IEC 61643-21: D1, C2, C3
- Integrated PE foot, safely discharges up to 20 kA (8/20 μs) and 2.5 kA (10/350 μs) to PE

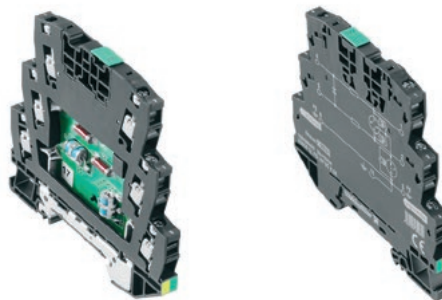

Technical data

Rated current I_N	500 mA
Volume resistance	1.8 n 10 %
Overload - failure mode	Modus 2
Requirements category acc. to IEC 61643-21	C2, C3, D1
Standards	IEC 61643-21
Surge current-carrying capacity C1	
Surge current-carrying capacity C2	2.5 kA 8/20 μs 5 kV 1.2/50 μs
Surge current-carrying capacity C3	10 A 10/1000 μs
Surge current-carrying capacity D1	0.5 kA 10/350 μs
Discharge current I_L (8/20 μs) wire-wire/wire-PE/GND-PE	2.5 kA / 2.5 kA
Discharge I_{max} (8/20 μs) wire-wire/wire-PE/GND-PE	10 kA / 10 kA
Lightning test I_{imp} (10/350 μs) wire-wire/wire-PE/GND-PE	/ 0.5 kA
Storage temperature	-40 °C...80 °C
Ambient temperature (operational)	-40 °C...70 °C
Protection degree	IP20
UL 94 flammability rating	V-0

Connection data	
Type of connection	Screw connection
Tightening torque	0.5 Nm
Wire connection cross section, finely stranded, max.	4 mm ²
Wire connection cross-section, finely stranded, min.	0.5 mm ²
Wire cross-section, solid, max.	6 mm ²
Wire cross-section, solid, min.	0.5 mm ²
Wire cross-section, stranded, max.	4 mm ²
Wire cross-section, stranded, min.	0.5 mm ²
Stripping length	10 mm
Rail	TS 35

Failure probability	
λges	60
MTTF	1903
SIL in compliance with IEC 61508	3

Approvals	
Approvals	CE; CSAEX; FUSAFETY; DEVE; UL
Standards	IEC 61643-21

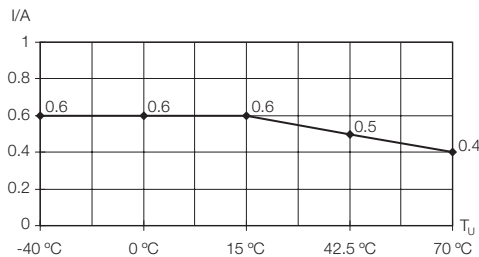
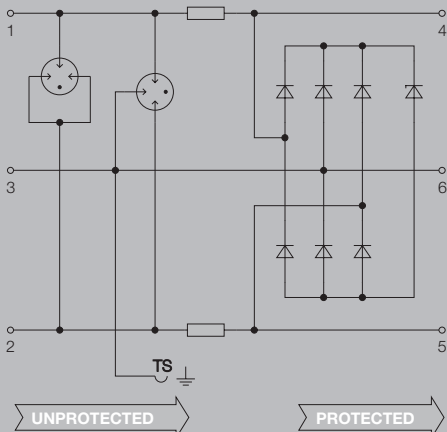
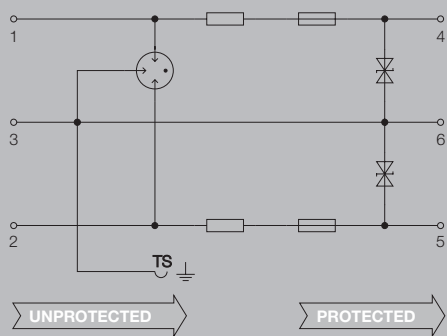

Dimensions	
Height x width x depth	mm 88.5 / 6.2 / 81

Note



VSSC 6 RS485, RS485 DP and RS232

Ordering data

	RS485	RS485 DP	RS232
Rated voltage (AC)			
Rated voltage (DC)	12 V	12 V	12 V
Max. continuous voltage, U_c (AC)			
Max. continuous voltage, U_c (DC)	15 V	15 V	15 V
Rated current I_N	500 mA	500 mA	500 mA
Optical function display	No	No	No
Isolating function	No	No	No
Input attenuation	113.6 MHz	113.6 MHz	1.4 MHz
Pulse-reset capacity	≤ 15 ms	≤ 15 ms	≤ 15 ms
Residual voltage, U_r typical	≤ 100 V	≤ 100 V	≤ 100 V

Ordering data

	RS485	RS485 DP	RS232
Type	VSSC6 RS485	VSSC6 RS485 DP	VSSC6 RS232
Order No.	1064980000	1065010000	1064990000
Qty.	10	10	10
Note	End plate AP VSSC6 1063110000	End plate AP VSSC6 1063110000	End plate AP VSSC6 1063110000



VSSC 6 RTD - protection for PT100 signal interfaces

- One-stage surge protection with screw connection for measurement and control signals
- Surge protection in terminal block design
- Modular width of only 6.2 mm
- Space-saving design for two signals
- Torx® slotted screw connection
- Can be used in compliance with installation standard IEC 62305
- Tested in accordance with IEC 61643-21
- Integrated PE foot, safely discharges up to 20 kA (8/20 μs) and 2.5 kA (10/350 μs) to PE

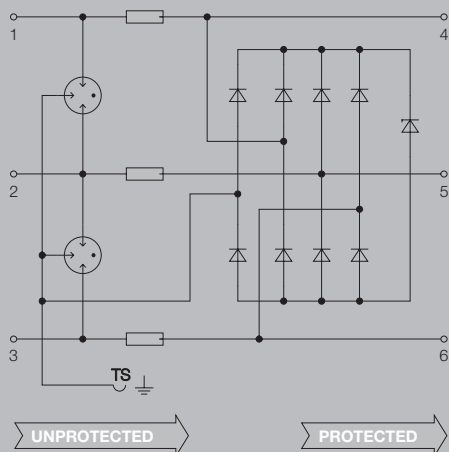
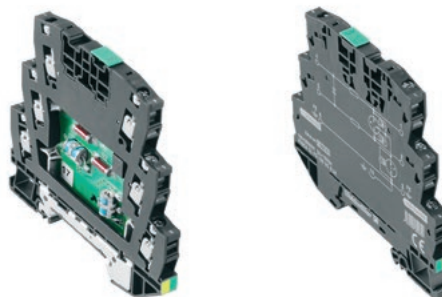

Technical data

Rated current I_N	300 mA
Volume resistance	1.8 n 10 %
Overload - failure mode	Modus 2
Requirements category acc. to IEC 61643-21	C2, C3, D1
Standards	IEC 61643-21
Surge current-carrying capacity C1	
Surge current-carrying capacity C2	2.5 kA 8/20 μs 5 kV 1.2/50 μs
Surge current-carrying capacity C3	10 A 10/1000 μs
Surge current-carrying capacity D1	0.5 kA 10/350 μs
Discharge current I_d (8/20 μs) wire-wire/wire-PE/GND-PE	2.5 kA / 2.5 kA
Discharge current I_{dmax} (8/20 μs) wire-wire/wire-PE/GND-PE	5 kA / 5 kA
Lightning test I_{imp} (10/350 μs) wire-wire/wire-PE/GND-PE	/
Storage temperature	-40 °C...80 °C
Ambient temperature (operational)	-40 °C...70 °C
Protection degree	IP20
UL 94 flammability rating	V-0
Connection data	
Type of connection	Screw connection
Tightening torque	
Wire connection cross section, finely stranded, max.	4 mm ²
Wire connection cross-section, finely stranded, min.	0.5 mm ²
Wire cross-section, solid, max.	6 mm ²
Wire cross-section, solid, min.	0.5 mm ²
Wire cross-section, stranded, max.	4 mm ²
Wire cross-section, stranded, min.	0.5 mm ²
Stripping length	10 mm
Rail	TS 35
Failure probability	
λges	63
MTTF	1812
SIL in compliance with IEC 61508	3
Approvals	
Approvals	CE; CSAEX; FUSAFETY; DEVE; UL
Standards	IEC 61643-21

Dimensions	Dimensions
Height x width x depth	mm 88.5 / 6.2 / 81

Note

VSSC 6 RTD

Ordering data

Rated voltage (AC)
 Rated voltage (DC)
 Max. continuous voltage, U_c (AC)
 Max. continuous voltage, U_c (DC)
 Rated current I_N
 Optical function display
 Isolating function
 Input attenuation
 Residual voltage, U_r typical

RTD

1 V

5 V

300 mA

No

113.6 MHz

150 V

Ordering data

Type
 Order No.
 Qty.

VSSC6 RTD

1139710000

10

Note

End plate AP VSSC6 1063110000



VARIRECTOR SSC 4AN

Lightning and surge protection in terminal block design

The new and comprehensive surge protection family for measurement and control technology in 6 mm overall width

The interfaces in C&I applications must be protected against surges, since coupling of surges on lines can interfere with or destroy signal inputs. It is therefore necessary that C&I devices be protected in their immediate vicinity. For this purpose, VARIRECTOR SSC, with its compact terminal-block format, is ideal for this application. The protective circuits are matched to the current loops and to binary signals.

The VARIRECTOR SSC products are tested according to the latest standards (IEC61643-21): They satisfy the safe short-circuit mode in the event of overload by AC currents in classes D1, C2 and C1. The products are ATEX-tested for use in intrinsically safe circuits.





Large variety

A solution for every type of surge protection:
More than 100 variations: current loops and binary signals for 5 V, 12 V, 24 V, 48 V and 60 V, with integrated components, e.g. varistors.

Quick identification

Large-area marking options: marking of devices and single connections as well as colour-coded marking of the voltage levels for fast identification in the switching cabinet.

Easy to use

The clamping area of 0.5 mm² – 6 mm² is covered with combined Torx®/Slot headed screw and a tightening torque of 0.8 Nm.



Simple and safe

Simple installation and high safety through direct PE contact when mounting on the terminal rail, with a very high discharge current of up to 20 kA.

Space-saving

Modular width of terminals just 6.2 mm for two binary signals or per analogue signal.

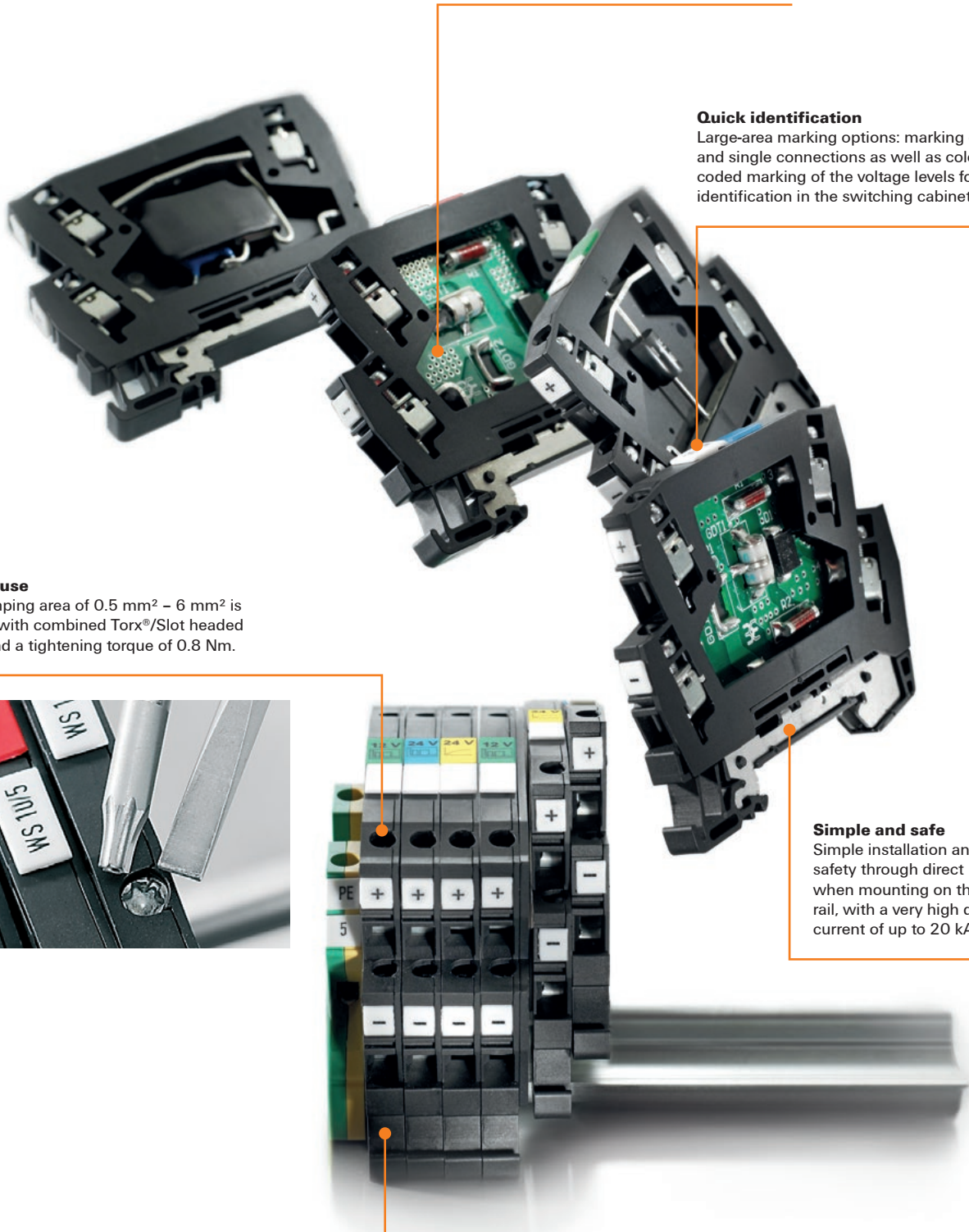

VARITECTOR SSC 4AN

VSSC 4 CL and CL FG - protection for current loops

- Two-stage surge protection with screw connection for measurement and control signals
- Surge protection in terminal block design
- Modular width of only 6.2 mm
- Space-saving design: 1 analogue signal
- Torx® slotted screw connection
- Can be used in compliance with installation standard IEC 62305
- Integrated PE foot, safely discharges up to 20 kA (8/20 μ s) and 2.5 kA (10/350 μ s) to PE



C

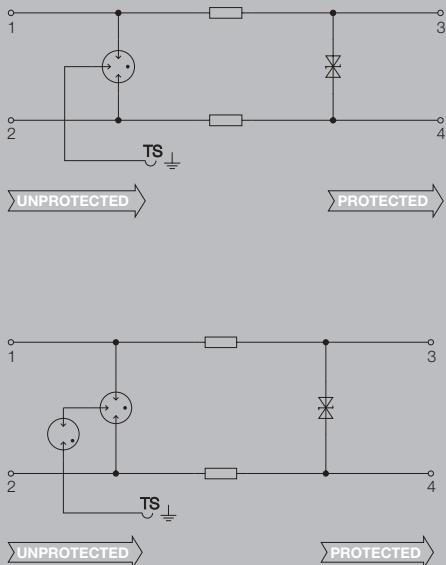

Technical data

Rated current I_N	500 mA
Volume resistance	1.8 Ω 10 %
Overload - failure mode	Modus 2
Requirements category acc. to IEC 61643-21	C2, C3, D1
Standards	IEC 61643-21, HART-compatible
Surge current-carrying capacity C1	
Surge current-carrying capacity C2	2.5 kA 8/20 μ s 5 kV 1.2/50 μ s
Surge current-carrying capacity C3	50 A 10/1000 μ s
Surge current-carrying capacity D1	0.5 kA 10/350 μ s
Discharge current I_t (8/20 μ s) wire-wire/wire-PE/GND-PE	2.5 kA / 2.5 kA
Discharge I_{max} (8/20 μ s) wire-wire/wire-PE/GND-PE	5 kA / 5 kA
Lightning test I_{imp} (10/350 μ s) wire-wire/wire-PE/GND-PE	/ 0.5 kA
Storage temperature	-40 °C...80 °C
Ambient temperature (operational)	-40 °C...70 °C
Protection degree	IP20
UL 94 flammability rating	V-0

Connection data

Type of connection	Screw connection
Tightening torque	0.5 Nm
Wire connection cross section, finely stranded, max.	4 mm ²
Wire connection cross-section, finely stranded, min.	0.5 mm ²
Wire cross-section, solid, max.	6 mm ²
Wire cross-section, solid, min.	0.5 mm ²
Wire cross-section, stranded, max.	4 mm ²
Wire cross-section, stranded, min.	0.5 mm ²
Stripping length	10 mm
Rail	TS 35

Failure probability

ages	19
MTTF	6008
SIL in compliance with IEC 61508	2

Approvals

Approvals	CE; CSAEX; FUSAFETY; DEVE; UL
Standards	IEC 61643-21, HART-compatible

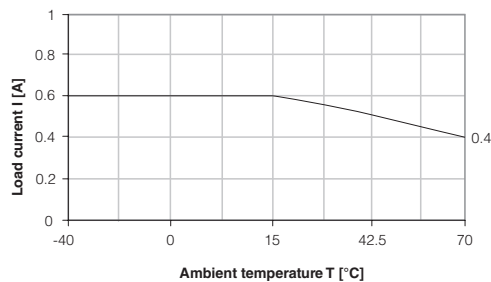

Dimensions

Height x width x depth	mm	76 / 6.2 / 58.5
------------------------	----	-----------------

Note

VSSC 4 CL and CL FG

Ordering data

	VSSC4 CL 12 V DC 0.5 A	VSSC4 CL 24 V UC 0.5 A	VSSC4 CL 48 V UC 0.5 A	VSSC4 CL FG 12 V DC 0.5 A
Rated voltage (AC)		24 V	48 V	
Rated voltage (DC)	12 V	34 V	68 V	12 V
Max. continuous voltage, U_c (AC)		30 V	60 V	
Max. continuous voltage, U_c (DC)	15 V	42 V	85 V	15 V
Rated current I_n	500 mA	500 mA	500 mA	500 mA
Optical function display	No	No	No	No
Isolating function	No	No	No	No
Input attenuation	750 KHz	3.4 MHz	5 Mhz	750 KHz
Pulse-reset capacity	≤ 20 ms	≤ 150 ms	≤ 110 ms	≤ 20 ms
Residual voltage, U_r typical	< 1000 V	< 1000 V	< 800 V	≤ 1500 V

Ordering data

	VSSC4 CL 12VDC 0.5A	VSSC4 CL 24VAC/DC 0.5A	VSSC4 CL 48VAC/DC 0.5A	VSSC4 CL FG 12VDC 0.5A
Type	VSSC4 CL 12VDC 0.5A	VSSC4 CL 24VAC/DC 0.5A	VSSC4 CL 48VAC/DC 0.5A	VSSC4 CL FG 12VDC 0.5A
Order No.	1063720000	1063730000	1063740000	1063760000
Qty.	10	10	10	10
Note	End plate AP VSSC4 1063120000	End plate AP VSSC4 1063120000	End plate AP VSSC4 1063120000	End plate AP VSSC4 1063120000

Ordering data

	VSSC4 CL FG 24 V UC 0.5 A	VSSC4 CL FG 48 V UC 0.5 A
Rated voltage (AC)	24 V	48 V
Rated voltage (DC)	34 V	68 V
Max. continuous voltage, U_c (AC)	30 V	60 V
Max. continuous voltage, U_c (DC)	42 V	85 V
Rated current I_n	500 mA	500 mA
Optical function display	No	No
Isolating function	No	No
Input attenuation	3.4 MHz	5 Mhz
Pulse-reset capacity	≤ 20 ms	≤ 20 ms
Residual voltage, U_r typical	≤ 1500 V	≤ 1500 V

Ordering data

	VSSC4 CL FG24VAC/DC0.5A	VSSC4 CL FG48VAC/DC0.5A
Type	VSSC4 CL FG24VAC/DC0.5A	VSSC4 CL FG48VAC/DC0.5A
Order No.	1063770000	1063780000
Qty.	10	10
Note	End plate AP VSSC4 1063120000	End plate AP VSSC4 1063120000



VSSC 4 SL and SL FG - protection for binary signal

- Two-stage surge protection with screw connection for measurement and control signals
- Surge protection in terminal block design
- Modular width of only 6.2 mm
- Space-saving design: 1 binary signal
- Torx® slotted screw connection
- Can be used in compliance with installation standard IEC 62305
- Tested in accordance with IEC 61643-21: D1, C2, C3
- Integrated PE foot, safely discharges up to 20 kA (8/20 μs) and 2.5 kA (10/350 μs) to PE

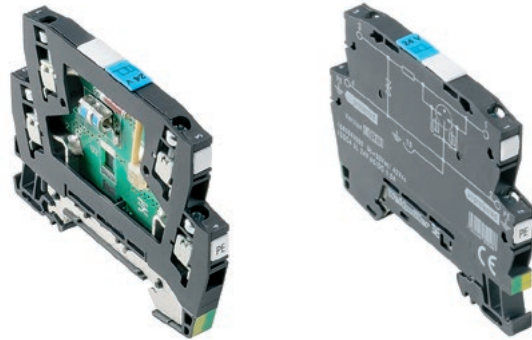

Technical data

Rated current I_N	500 mA
Volume resistance	1.8 n 10 %
Overload - failure mode	Modus 2
Requirements category acc. to IEC 61643-21	C2, C3, D1
Standards	IEC 61643-21
Surge current-carrying capacity C1	
Surge current-carrying capacity C2	2.5 kA 8/20 μs 5 kV 1.2/50 μs
Surge current-carrying capacity C3	10 A 10/1000 μs
Surge current-carrying capacity D1	1 kA 10/350 μs
Discharge current I_d (8/20 μs) wire-wire/wire-PE/GND-PE	/ 2.5 kA
Discharge I_{dmax} (8/20 μs) wire-wire/wire-PE/GND-PE	/ 10 kA
Lightning test I_{imp} (10/350 μs) wire-wire/wire-PE/GND-PE	/ 0.5 kA
Storage temperature	-40 °C...80 °C
Ambient temperature (operational)	-40 °C...70 °C
Protection degree	IP20
UL 94 flammability rating	V-0

Connection data	
Type of connection	Screw connection
Tightening torque	0.5 Nm
Wire connection cross section, finely stranded, max.	4 mm ²
Wire connection cross-section, finely stranded, min.	0.5 mm ²
Wire cross-section, solid, max.	6 mm ²
Wire cross-section, solid, min.	0.5 mm ²
Wire cross-section, stranded, max.	4 mm ²
Wire cross-section, stranded, min.	0.5 mm ²
Stripping length	10 mm
Rail	TS 35

Failure probability	
λges	43
MTTF	2655
SIL in compliance with IEC 61508	3

Approvals	
Approvals	CE; CSAEX; FUSAFETY; DEVE; UL
Standards	IEC 61643-21

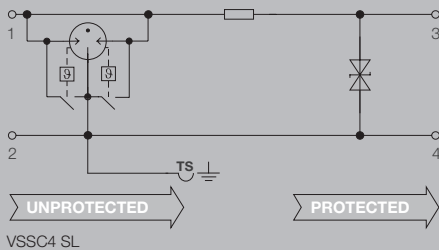

VSSC4 SL

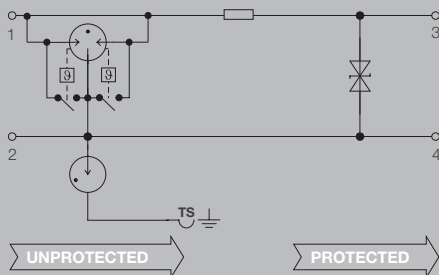

VSSC SL FG

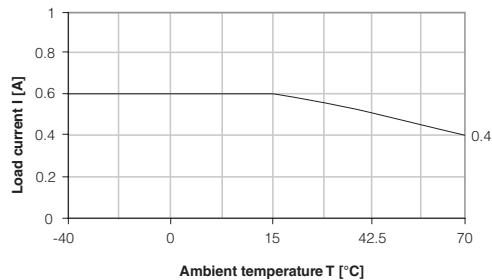

Dimensions	Dimensions
Height x width x depth	mm 76 / 6.2 / 58.5

Note



VSSC 4 SL and SL FG

Ordering data

	VSSC4 SL 12 V DC 0.5 A	VSSC4 SL 24 V UC 0.5 A	VSSC4 SL 48 V UC 0.5 A	VSSC4 SL 60 V UC 0.5 A
Rated voltage (AC)		24 V	48 V	60 V
Rated voltage (DC)	12 V	34 V	68 V	85 V
Max. continuous voltage, U _c (AC)		30 V	60 V	75 V
Max. continuous voltage, U _c (DC)	15 V	42 V	85 V	106 V
Rated current I _n	500 mA	500 mA	500 mA	500 mA
Optical function display	No	No	No	No
Isolating function	No	No	No	No
Input attenuation	860 KHz	3.4 MHz	5.2 MHz	6.6 MHz
Pulse-reset capacity	≤ 20 ms	≤ 35 ms	≤ 20 ms	≤ 20 ms
Residual voltage, U _r typical	≤ 100 V	150 V	< 200 V	250 V

Ordering data	VSSC4 SL 12VDC 0.5A	VSSC4 SL 24VAC/DC 0.5A	VSSC4 SL 48VAC/DC 0.5A	VSSC4 SL 60VAC/DC 0.5A
Type	VSSC4 SL 12VDC 0.5A	VSSC4 SL 24VAC/DC 0.5A	VSSC4 SL 48VAC/DC 0.5A	VSSC4 SL 60VAC/DC 0.5A
Order No.	1063830000	1063840000	1063860000	1063870000
Qty.	10	10	10	10
Note	End plate AP VSSC4 1063120000	End plate AP VSSC4 1063120000	End plate AP VSSC4 1063120000	End plate AP VSSC4 1063120000

Ordering data

	VSSC4 SL FG 12 V DC 0.5 A	VSSC4 SL FG 24 V UC 0.5 A
Rated voltage (AC)		24 V
Rated voltage (DC)	12 V	34 V
Max. continuous voltage, U _c (AC)		30 V
Max. continuous voltage, U _c (DC)	15 V	42 V
Rated current I _n	500 mA	500 mA
Optical function display	No	No
Isolating function	No	No
Input attenuation	860 KHz	3.4 MHz
Pulse-reset capacity	≤ 20 ms	≤ 20 ms
Residual voltage, U _r typical	≤ 100 V	150 V

Ordering data	VSSC4 SL FG 12VDC 0.5A	VSSC4 SL FG24VAC/DC0.5A
Type	VSSC4 SL FG 12VDC 0.5A	VSSC4 SL FG24VAC/DC0.5A
Order No.	1063880000	1063890000
Qty.	10	10
Note	End plate AP VSSC4 1063120000	End plate AP VSSC4 1063120000



VSSC 4 MOV - protection with Varistor (MOV)

- One-stage surge protection with screw connection for measurement and control signals
- Surge protection in terminal block design
- Space-saving design for one signal
- Torx® slotted screw connection
- Can be used in compliance with installation standard IEC 62305
- Tested in accordance with IEC 61643-21: C1, C2
- Integrated PE foot, safely discharges up to 20 kA (8/20 μs) and 2.5 kA (10/350 μs) to PE

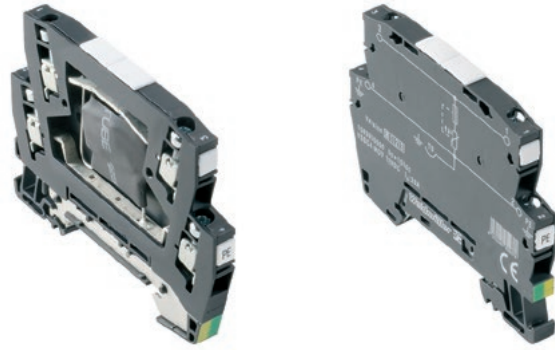

Technical data

Rated current I_N	20 A
Volume resistance	<0.1 Ω
Overload - failure mode	Mode 1
Requirements category acc. to IEC 61643-21	C1
Standards	IEC 61643-21
Surge current-carrying capacity C1	0.25 kA 8/20 μs 0.5 kV 1.2/50 μs
Surge current-carrying capacity C2	1 kA 8/20 μs
Surge current-carrying capacity C3	
Surge current-carrying capacity D1	
Discharge current I_d (8/20 μs) wire-wire/wire-PE/GND-PE	/ 0.5 kA
Discharge I_{dmax} (8/20 μs) wire-wire/wire-PE/GND-PE	/ 1 kA
Lightning test I_{imp} (10/350 μs) wire-wire/wire-PE/GND-PE	/
Storage temperature	-40 °C...80 °C
Ambient temperature (operational)	-40 °C...70 °C
Protection degree	IP20
UL 94 flammability rating	V-0

Connection data

Type of connection	Screw connection
Tightening torque	0.5 Nm
Wire connection cross section, finely stranded, max.	4 mm ²
Wire connection cross-section, finely stranded, min.	0.5 mm ²
Wire cross-section, solid, max.	6 mm ²
Wire cross-section, solid, min.	0.5 mm ²
Wire cross-section, stranded, max.	4 mm ²
Wire cross-section, stranded, min.	0.5 mm ²
Stripping length	10 mm
Rail	TS 35

Failure probability

λges	26
MTTF	4391
SIL in compliance with IEC 61508	3

Approvals

Approvals	CE; CSAEX; FUSAFETY; DEVE; UL
Standards	IEC 61643-21

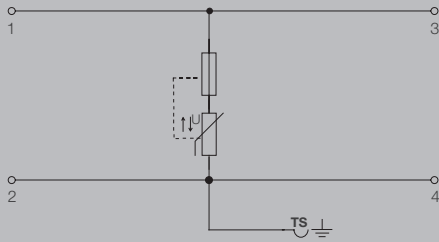

VSSC4 MOV

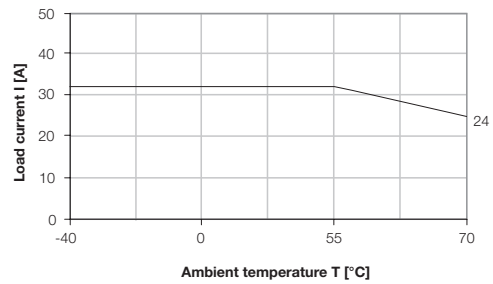

Dimensions	Dimensions
Height x depth	mm 76 / 58.5

Note Products with a rated voltage (AC) of 120 V / 150 V / 240 V are 12.4 mm wide.



VSSC MOV 4 - components

Ordering data

	VSSC4 MOV 12 V DC	VSSC4 MOV 24 V UC	VSSC4 MOV 48 V UC	VSSC4 MOV 60 V UC
Rated voltage (AC)		24 V	48 V	60 V
Rated voltage (DC)	12 V	34 V	68 V	85 V
Max. continuous voltage, U _c (AC)		30 V	60 V	75 V
Max. continuous voltage, U _c (DC)	15 V	42 V	85 V	106 V
Rated current I _n	20 A	20 A	20 A	20 A
Optical function display	No	No	No	No
Isolating function	No	No	No	No
Requirements category acc. to IEC 61643-21	C1	C1	C1, C2	C1, C2
Pulse-reset capacity				
Residual voltage, U _p typical	≤ 100 V	150 V	250 V	< 300 V
Capacitance	11.2 nF	4.8 nF	1.9 nF	1.7 nF
Width	6.2 mm	6.2 mm	6.2 mm	6.2 mm

Ordering data

	VSSC4 MOV 12VDC	VSSC4 MOV 24VAC/DC	VSSC4 MOV 48VAC/DC	VSSC4 MOV 60VAC/DC
Type	VSSC4 MOV 12VDC	VSSC4 MOV 24VAC/DC	VSSC4 MOV 48VAC/DC	VSSC4 MOV 60VAC/DC
Order No.	1063950000	1063960000	1063970000	1063980000
Qty.	10	10	10	10
Note	End plate AP VSSC4 1063120000	End plate AP VSSC4 1063120000	End plate AP VSSC4 1063120000	End plate AP VSSC4 1063120000

Ordering data

	VSSC4 MOV 120 V UC	VSSC4 MOV 150 V UC	VSSC4 MOV 240 V UC
Rated voltage (AC)	120 V	150 V	240 V
Rated voltage (DC)	170 V	212 V	339 V
Max. continuous voltage, U _c (AC)	150 V	188 V	288 V
Max. continuous voltage, U _c (DC)	212 V	266 V	407 V
Rated current I _n	20 A	20 A	20 A
Optical function display	No	No	No
Isolating function	No	No	No
Requirements category acc. to IEC 61643-21	C1, C2	C1, C2	C1, C2
Pulse-reset capacity			
Residual voltage, U _p typical	< 600 V	< 700 V	< 1200 V
Capacitance	1.48 nF	0.97 nF	0.7 nF
Width	12.4 mm	12.4 mm	12.4 mm

Ordering data

	VSSC4 MOV 120VAC/DC	VSSC4 MOV 150VAC/DC	VSSC4 MOV 240VAC/DC
Type	VSSC4 MOV 120VAC/DC	VSSC4 MOV 150VAC/DC	VSSC4 MOV 240VAC/DC
Order No.	1063990000	1064010000	1064020000
Qty.	5	5	5
Note	End plate AP VSSC4 1063120000	End plate AP VSSC4 1063120000	End plate AP VSSC4 1063120000



VSSC 4 GDT - protection with sparkover gap (GDT)

- One-stage surge protection with screw connection for measurement and control signals
- Surge protection in terminal block design
- Modular width of only 12.4 mm
- Space-saving design for one signal
- Torx® slotted screw connection
- Can be used in compliance with installation standard IEC 62305
- Tested in accordance with IEC 61643-21: C2, C3, D1
- Integrated PE foot, safely discharges up to 20 kA (8/20 μs) and 2.5 kA (10/350 μs) to PE

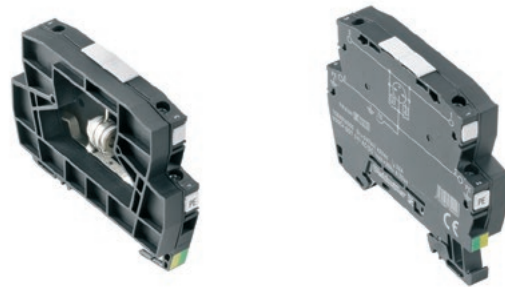

Technical data

Rated current I_N	20 A
Volume resistance	<0.1 Ω
Overload - failure mode	Modus 2
Requirements category acc. to IEC 61643-21	C2, C3, D1
Standards	IEC 61643-21
Surge current-carrying capacity C1	
Surge current-carrying capacity C2	5 kA 8/20 μs
Surge current-carrying capacity C3	100 A 10/1000 μs
Surge current-carrying capacity D1	2.5 kA 10/350 μs
Discharge current I_d (8/20 μs) wire-wire/wire-PE/GND-PE	/ 5 kA
Discharge I_{dmax} (8/20 μs) wire-wire/wire-PE/GND-PE	/ 20 kA
Lightning test I_{imp} (10/350 μs) wire-wire/wire-PE/GND-PE	/ 2.5 kA
Storage temperature	-40 °C...80 °C
Ambient temperature (operational)	-40 °C...70 °C
Protection degree	IP20
UL 94 flammability rating	V-0

Connection data

Type of connection	Screw connection
Tightening torque	0.5 Nm
Wire connection cross section, finely stranded, max.	4 mm ²
Wire connection cross-section, finely stranded, min.	0.5 mm ²
Wire cross-section, solid, max.	6 mm ²
Wire cross-section, solid, min.	0.5 mm ²
Wire cross-section, stranded, max.	4 mm ²
Wire cross-section, stranded, min.	0.5 mm ²
Stripping length	10 mm
Rail	TS 35

Failure probability

λges	10
MTTF	11416
SIL in compliance with IEC 61508	3

Approvals

Approvals	CE; CSAEX; FUSAFETY
Standards	IEC 61643-21

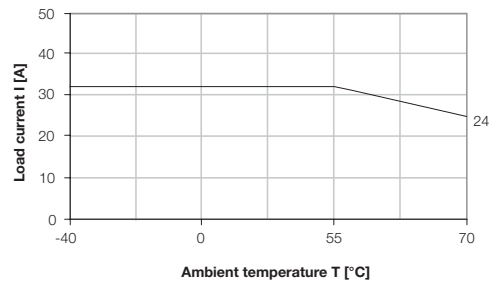
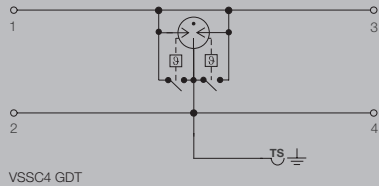

Dimensions

Height x width x depth	mm	76 / 12.4 / 58.5
------------------------	----	------------------

Note



VSSC 4 GDT - components

Lightning and surge protection for instrumentation and control (I & C)

Ordering data

	VSSC4 GDT 110 V UC 20 kA	VSSC4 GDT 240 V UC 20 kA
Rated voltage (AC)	110 V	240 V
Rated voltage (DC)	156 V	339 V
Max. continuous voltage, U_c (AC)	138 V	288 V
Max. continuous voltage, U_c (DC)	195 V	407 V
Rated current I_n	20 A	20 A
Optical function display	No	No
Isolating function	No	No
Residual voltage, U_r typical	< 1000 V	\leq 1200 V
Capacitance	4.65 pF	4.65 pF

Ordering data	VSSC4 GDT 110VAC/DC20KA	VSSC4 GDT 240VAC/DC20KA
Type	VSSC4 GDT 110VAC/DC20KA	VSSC4 GDT 240VAC/DC20KA
Order No.	1064050000	1064060000
Qty.	5	5
Note	End plate AP VSSC4 1063120000	End plate AP VSSC4 1063120000



VARITECTOR SSC 4AN

VSSC 4 TAZ - protection with suppressor diode (TAZ)

- One-stage surge protection with screw connection for measurement and control signals
- Surge protection in terminal block design
- Modular width of only 6.2 mm
- Space-saving design for one signal
- Torx® slotted screw connection
- Can be used in compliance with installation standard IEC 62305
- Tested in accordance with IEC 61643-21: C3
- Integrated PE foot, safely discharges up to 20 kA (8/20 μ s) and 2.5 kA (10/350 μ s) to PE

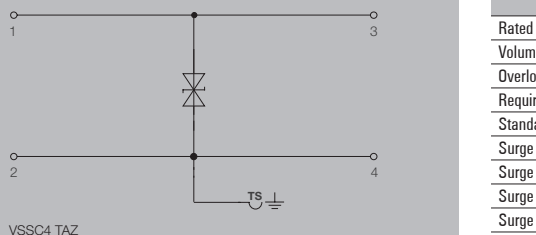
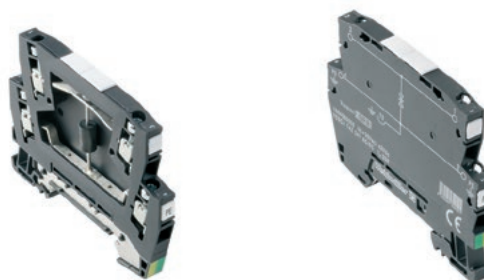

Technical data

Rated current I_N	20 A
Volume resistance	<0.1 Ω
Overload - failure mode	Mode 1
Requirements category acc. to IEC 61643-21	C3
Standards	IEC 61643-21
Surge current-carrying capacity C1	
Surge current-carrying capacity C2	
Surge current-carrying capacity C3	50 A
Surge current-carrying capacity D1	
Discharge current I_t (8/20 μ s) wire-wire/wire-PE/GND-PE	/ 0.2 kA
Discharge I_{max} (8/20 μ s) wire-wire/wire-PE/GND-PE	/ 0.5 kA
Lightning test I_{imp} (10/350 μ s) wire-wire/wire-PE/GND-PE	/
Storage temperature	-40 °C...80 °C
Ambient temperature (operational)	-40 °C...70 °C
Protection degree	IP20
UL 94 flammability rating	V-0

Connection data

Type of connection	Screw connection
Tightening torque	0.5 Nm
Wire connection cross section, finely stranded, max.	4 mm ²
Wire connection cross-section, finely stranded, min.	0.5 mm ²
Wire cross-section, solid, max.	6 mm ²
Wire cross-section, solid, min.	0.5 mm ²
Wire cross-section, stranded, max.	4 mm ²
Wire cross-section, stranded, min.	0.5 mm ²
Stripping length	10 mm
Rail	TS 35

Failure probability

ages	32
MTTF	3567
SIL in compliance with IEC 61508	3

Approvals

Approvals	CE; CSAEX; FUSAFETY; DEVE; UL
Standards	IEC 61643-21

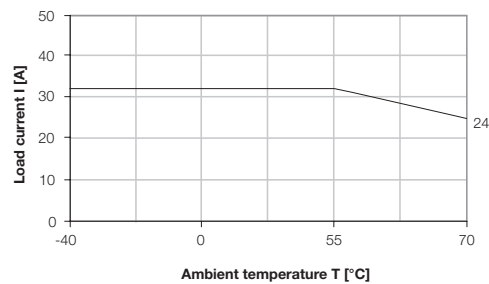

Dimensions

Dimensions	Dimensions
Height x width x depth	mm 76 / 6.2 / 58.5

Note

VSSC 4 TAZ - components

Ordering data

	VSSC4 TAZ 12 V DC	VSSC4 TAZ 24 V UC	VSSC4 TAZ 48 V UC
Rated voltage (AC)		24 V	48 V
Rated voltage (DC)	12 V	34 V	75 V
Max. continuous voltage, U_c (AC)		30 V	60 V
Max. continuous voltage, U_c (DC)	15 V	42 V	85 V
Rated current I_n	20 A	20 A	20 A
Optical function display	No	No	No
Isolating function	No	No	No
Residual voltage, U_r typical	30 V	70 V	< 165 V
Capacitance	5.06 nF	0.82 nF	0.45 nF

Ordering data	VSSC4 TAZ 12VDC	VSSC4 TAZ 24VAC/DC	VSSC4 TAZ 48VAC/DC
Type	VSSC4 TAZ 12VDC	VSSC4 TAZ 24VAC/DC	VSSC4 TAZ 48VAC/DC
Order No.	1064070000	1064080000	1064090000
Qty.	10	10	10
Note	End plate AP VSSC4 1063120000	End plate AP VSSC4 1063120000	End plate AP VSSC4 1063120000



VSSC 4 RC - protection with a combination of resistors and capacitors

- Two-stage surge protection with screw connection for measurement and control signals
- Surge protection in terminal block design
- Modular width of only 12.4 mm
- Space-saving design for one signal
- Torx® slotted screw connection
- Can be used in compliance with installation standard IEC 62305
- Tested in accordance with IEC 61643-21
- Integrated PE foot, safely discharges up to 20 kA (8/20 μs) and 2.5 kA (10/350 μs) to PE

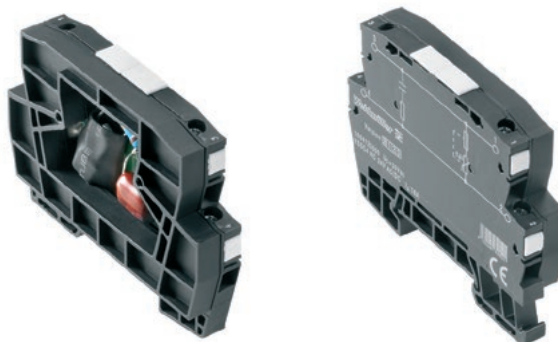

Technical data

Rated current I_N	20 A
Volume resistance	<0.1 Ω
Overload - failure mode	Mode 1
Requirements category acc. to IEC 61643-21	C1
Standards	IEC 61643-21
Surge current-carrying capacity C1	0.25 kA 8/20 μs 0.5 kV 1.2/50 μs
Surge current-carrying capacity C2	
Surge current-carrying capacity C3	
Surge current-carrying capacity D1	
Discharge current I_t (8/20 μs) wire-wire/wire-PE/GND-PE	/ 0.5 kA
Discharge I_{max} (8/20 μs) wire-wire/wire-PE/GND-PE	/
Lightning test I_{imp} (10/350 μs) wire-wire/wire-PE/GND-PE	/
Storage temperature	-40 °C...80 °C
Ambient temperature (operational)	-40 °C...70 °C
Protection degree	IP20
UL 94 flammability rating	V-0
Connection data	
Type of connection	Screw connection
Tightening torque	0.5 Nm
Wire connection cross section, finely stranded, max.	4 mm ²
Wire connection cross-section, finely stranded, min.	0.5 mm ²
Wire cross-section, solid, max.	6 mm ²
Wire cross-section, solid, min.	0.5 mm ²
Wire cross-section, stranded, max.	4 mm ²
Wire cross-section, stranded, min.	0.5 mm ²
Stripping length	10 mm
Failure probability	
λges	28
MTTF	4048
SIL in compliance with IEC 61508	3
Approvals	
Approvals	CE; CSAEX; FUSAFETY; DEVE; UL
Standards	IEC 61643-21

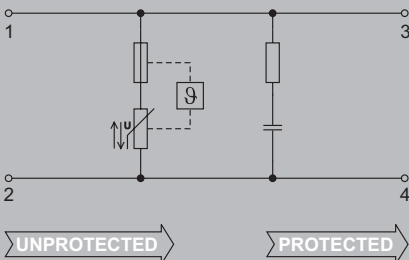

VSSC4 RC

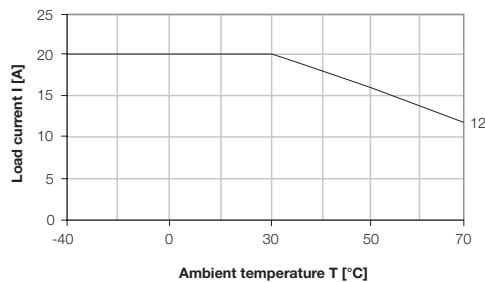

Dimensions	Dimensions
Height x width x depth	mm 76 / 12.4 / 58.5

Note



VSSC 4 RC - components

Ordering data

	VSSC4 RC 24 V UC	VSSC4 RC 240 V UC
Rated voltage (AC)	24 V	240 V
Rated voltage (DC)	34 V	339 V
Max. continuous voltage, U _c (AC)	30 V	275 V
Max. continuous voltage, U _c (DC)	42 V	388 V
Rated current I _n	20 A	20 A
Optical function display	No	No
Isolating function	No	No
Input attenuation		
Pulse-reset capacity		
Residual voltage, U _r typical	150 V	< 500 V
Capacitance	220 nF	220 nF

Ordering data	VSSC4 RC 24VAC/DC	VSSC4 RC 240VAC/DC
Type	VSSC4 RC 24VAC/DC	VSSC4 RC 240VAC/DC
Order No.	1064120000	1064130000
Qty.	5	5
Note	End plate AP VSSC4 1063120000	End plate AP VSSC4 1063120000



MCZ OVP

Lightning and surge protection for data interfaces

Weidmüller's "MCZ OVP" surge protection for industrial bus systems and data interfaces: Narrow surge protection terminals with tension-clamp connections for PROFIBUS, Interbus, CAN, DeviceNet – with no signal delay. The Omega stainless steel spring used for DIN rail contact ensures outstanding discharging characteristics that are consistent and reliable.



Space-saving

The narrow 6-mm MCZ OVP surge protector is installed simply and quickly due to its terminal block design.



Vibration-resistant PE contact

Up to 10 kA (8/20 μ s) of surge voltage can be reliably discharged via the stainless steel Omega spring. This contact snaps onto the rail and requires no tools to install.

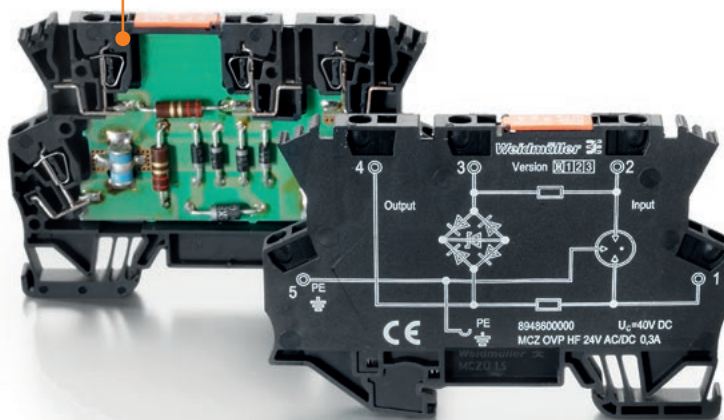
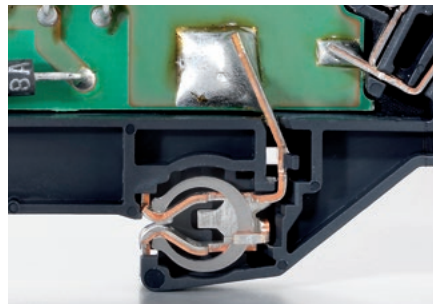

Quick to connect

Maintenance-free tension-clamp wire connection: providing strong contact force and quick wiring times. This ensures a more securely clamped wire across the entire clamping area.

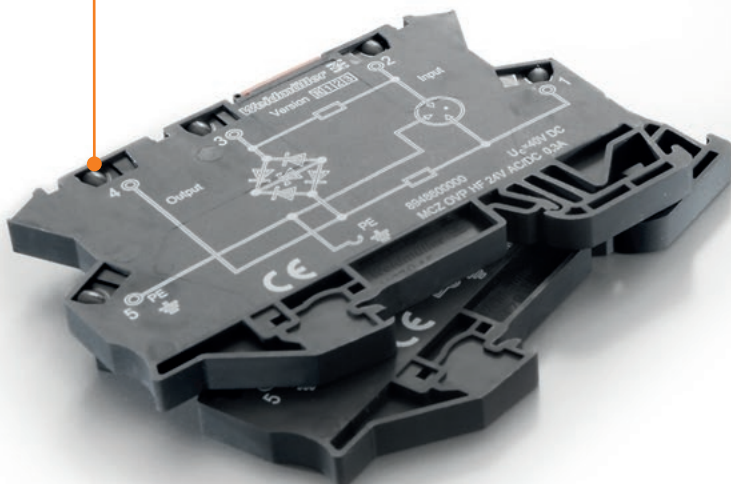
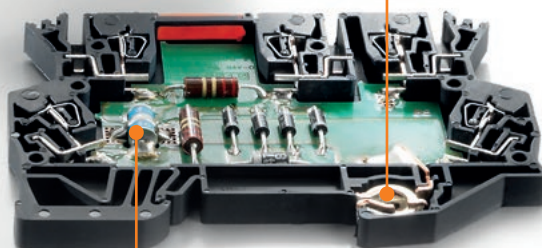

High transfer rates with protection

Variants are available for protecting data lines (including the following industrial bus systems: PROFIBUS, PROFINET, Interbus, C-Bus, MODBUS, CAN, DeviceNet, etc.)

Lightning and surge protection for instrumentation and control (I & C)



Narrow surge protection terminals with tension-clamp wire connections for measurement and control systems

Weidmüller MCZ surge protection terminals are characterised by their maximum protective function, and a compact design of only 6 mm. The tension spring connection and direct earthing via the terminal rail contact results in time-savings during installation.

The MCZ OVP terminals are suitable for installing in the tightest of places in automated process, industrial and building services systems.

The different models

MCZ OVP HF is a two-stage protective combination with a bridge circuit consisting of suppressor diodes. With this circuitry, high transmission rates of up to 100 Mhz can be reached in 100 Ohm systems.

The protective circuitry is particularly suitable for protecting high-speed data transmission systems and high-speed analogue systems.

MCZ OVP CL is a three-stage protective combination with a suppression diode between the current paths. It limits the surge in analogue signal circuits, e.g. current loops.

MCZ OVP SL is a three-stage protective combination with two suppression diodes, each from the signal line to earth. It limits the surge in binary circuits, e.g. for actuators.

MCZ OVP CL FG is a three-stage protective combination with a suppression diode between the current paths. It limits the surge in analogue signal circuits. A high-resistance earth connection is achieved with a gas discharge tube.



The three-stage surge protection terminals are fitted with gas discharge tubes, varistors, suppression diodes (TAZ) and decoupling inductors. Individual protective components such as varistors and suppression diodes complement the range. The MCZ OVP surge protection terminals are available with rated voltages of 24 V and 48 V. The response time for the 3-stage MCZ OVP is typically 100 ps. The earth contact is produced by clipping the terminal to an earthed terminal rail. To guarantee a safe energy discharge of up to 10 kA (8/20 μ s) via these terminals, the TS 35 rail must be earthed.

EMC regulations require the terminal rail to be securely screwed to an earthed mounting plate. Optimum protection is achieved when the PE contact is made via a tension spring terminal every 60 cm.



MCZ OVP SL FG is a three-stage protective combination with two suppression diodes, each from the signal line to earth. It limits the surge in binary circuits, e.g. for actuators. A high-resistance earth connection is achieved with three gas discharge tubes.

Derating curve MCZ OVP $I_{max} = 0,5 A$

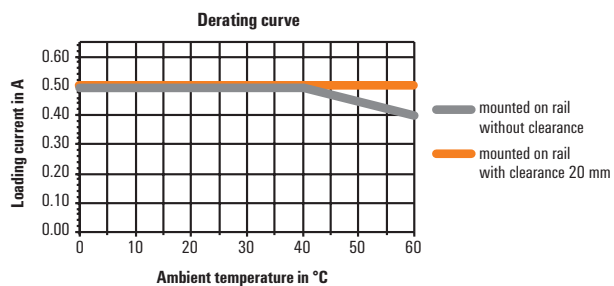

Derating curve MCZ OVP $I_{max} = 1,25 A$

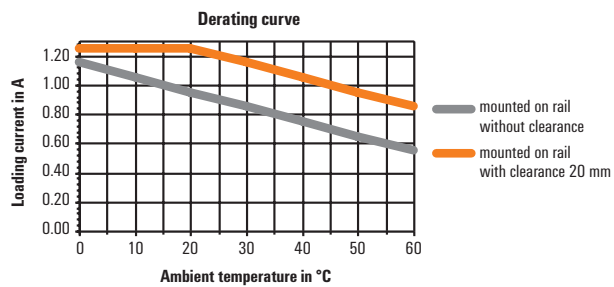



MCZ OVP series

2-stage protection with tension clamp connection

connection

- Slim overvoltage protection terminal with tension clamp connection
- 6 mm slim fine overvoltage protection
- Fast wiring thanks to TS contact and tension clamp connections

MCZ OVP HF 5 V 0.3 A

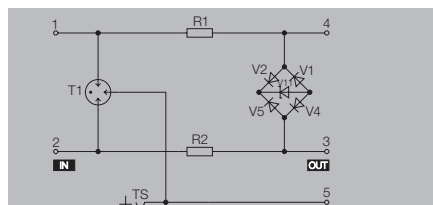
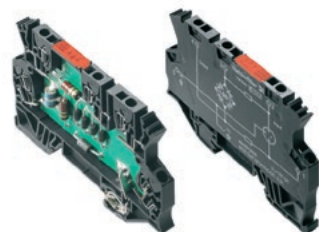

MCZ OVP HF 12 V 0.3 A

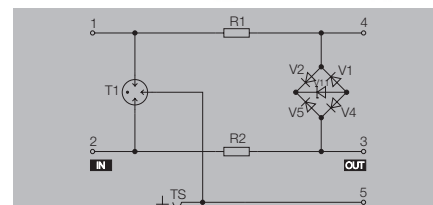
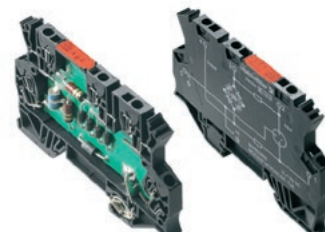

Technical data

Rated voltage (AC) / Rated voltage (DC)
Max. continuous voltage, U_c (AC)
Rated voltage (DC), max.
Operating current, I_{max}
Volume resistance
Gas discharge tube
Limiting frequency (-3 dB) at load resistance
Discharge current, max. (8/20 μ s)
Lightning test current I_{imp} (10/350 μ s)
Requirements category acc. to IEC 61643-21
Storage temperature
Ambient temperature (operational)
Protection level
Protection level wire-PE 1kV/ μ s, type
Protection level wire-PE 8/20 μ s, type
Protection level wire-wire 1kV/ μ s, type
Protection level wire-wire 8/20 μ s, type
Approvals
Approvals

5 V / 5 V
7 V
10 V
0.3 A
2.50 Ω
Yes
100 MHz (measured in 100- Ω system)
5 kA
D1, C3, C2, C1
-40 °C...85 °C
-40 °C...60
15 V
30 V
15 V
15 V
CE

13 V / 12 V
13 V
18.5 V
0.3 A
2.50 Ω
Yes
100 MHz (measured in 100- Ω system)
5 kA
D1, C3, C2, C1
-40 °C...85 °C
-40 °C...60
25 V
40 V
25 V
25 V
CE

Dimensions

Height x width x depth mm

91 / 6 / 63.5

91 / 6 / 63.5

Note

Ordering data

--

Type	Qty.	Order No.
MCZ OVP HF 5V 0,3A	10	8948620000

Type	Qty.	Order No.
MCZ OVP HF 12V 0,3A	10	8948610000

Note

2-stage protection with tension clamp

connection

- Slim overvoltage protection terminal with tension clamp connection
- 6 mm slim fine overvoltage protection
- Fast wiring thanks to TS contact and tension clamp connections

MCZ OVP HF 24 V 0.3 A

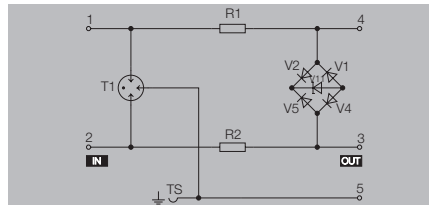
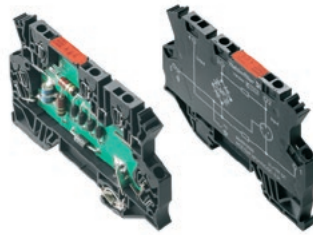

Technical data

Rated voltage (AC) / Rated voltage (DC)
 Max. continuous voltage, U_c (AC)
 Rated voltage (DC), max.
 Operating current, I_{max}
 Volume resistance
 Gas discharge tube
 Limiting frequency (-3 dB) at load resistance
 Discharge current, max. (8/20 μ s)
 Lightning test current I_{imp} (10/350 μ s)
 Requirements category acc. to IEC 61643-21
 Storage temperature
 Ambient temperature (operational)

Protection level

Protection level wire-PE 1kV/ μ s, type
 Protection level wire-PE 8/20 μ s, type
 Protection level wire-wire 1kV/ μ s, type
 Protection level wire-wire 8/20 μ s, type

Approvals

Approvals

24 V / 24 V
 28 V
 40 V
 0.3 A
 2.50 Ω
 Yes
 100 MHz (measured in 100- Ω system)
 5 kA

 D1, C3, C2, C1
 -40 °C...85 °C
 -40 °C...60

 80 V
 150 V
 80 V
 80 V

 CE

Dimensions

Height x width x depth

mm

91 / 6 / 63.5

Note

Ordering data

Type	Qty.	Order No.
MCZ OVP HF 24V 0,3A	10	8948600000

Note



MCZ OVP series

3- or 1-stage protection with tension clamp connection

- Slim overvoltage protection terminal with tension clamp connection
- 6 mm slim fine overvoltage protection
- Fast wiring thanks to TS contact and tension clamp connections

MCZ OVP CL 24 V DC 0.5 A

Protection for current loops

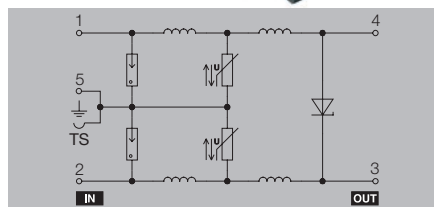

MCZ OVP CL 24 V AC 0.5 A

Protection for current loops

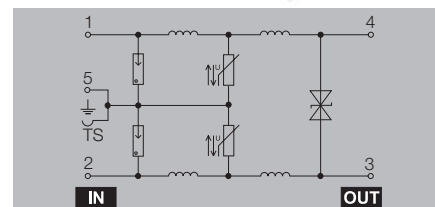

Technical data

Rated voltage (AC)
 Rated voltage (DC)
 Max. continuous voltage, U_c (AC)
 Operating current, I_{max}
 Volume resistance
 Gas discharge tube
 Varistor
 Suppression diodes
 Limiting frequency (-3 dB) at load resistance
 Discharge current, max. (8/20 μ s)
 Lightning test current I_{imp} (10/350 μ s)
 Requirements category acc. to IEC 61643-21
 Design
 Storage temperature
 Ambient temperature (operational)

Protection level

Protection level wire-PE 1kV/ μ s, type
 Protection level wire-PE 8/20 μ s, type
 Protection level wire-wire 1kV/ μ s, type
 Protection level wire-wire 8/20 μ s, type

Approvals

Approvals

24 V
 28 V
 0.5 A
 2,50 Ω
 Yes
 Yes
 Yes
 500 kHz 240 Ω
 5 kA
 1 kA
 D1
 Terminal
 -40 °C...85 °C
 -40 °C...60

40 V
 65 V
 40 V
 65 V

CE; UL

24 V
 28 V
 38 V
 0.5 A
 1,00 Ω
 Yes
 Yes
 Yes
 500 kHz 240 Ω
 5 kA
 1 kA
 D1
 Terminal
 -40 °C...85 °C
 -40 °C...60

45 V
 70 V
 45 V
 70 V

CE; UL

Dimensions

Height x width x depth mm

91 / 6 / 63.5

91 / 6 / 63.5

Note

See derating curve in the introductory text chapter in Catalogue 4.4

See derating curve in the introductory text chapter in Catalogue 4.4

Ordering data

Type	Qty.	Order No.
MCZ OVP CL 24VDC 0,5A	10	8448920000

Type	Qty.	Order No.
MCZ OVP CL 24VAC 0,5A	10	8472880000

Note

3- or 1-stage protection with tension clamp connection

- Slim overvoltage protection terminal with tension clamp connection
- 6 mm slim fine overvoltage protection
- Fast wiring thanks to TS contact and tension clamp connections

MCZ OVP CL 24 V UC 1.25 A

Protection for current loops

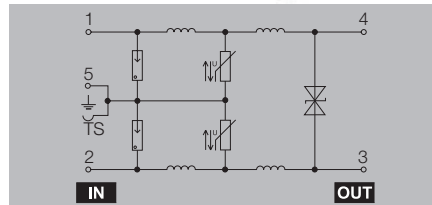

MCZ OVP SL 24 V DC 0.5 A

Protection for binary signals

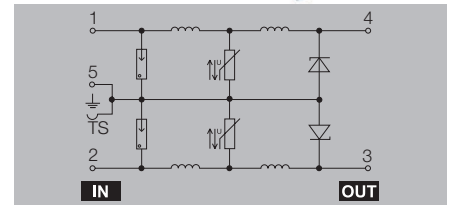
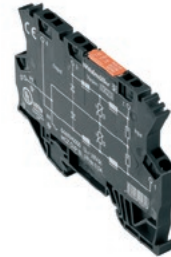

Technical data

Rated voltage (AC)	24 V
Rated voltage (DC)	24 V
Max. continuous voltage, U_c (AC)	27 V
Operating current, I_{max}	1.25 A
Volume resistance	1.00 Ω
Gas discharge tube	Yes
Varistor	Yes
Suppression diodes	Yes
Limiting frequency (-3 dB) at load resistance	500 kHz 240 Ω
Discharge current, max. (8/20 μ s)	5 kA
Lightning test current I_{imp} (10/350 μ s)	1 kA
Requirements category acc. to IEC 61643-21	D1
Design	Terminal
Storage temperature	-40 °C...85 °C
Ambient temperature (operational)	-40 °C...60
Protection level	
Protection level wire-PE 1kV/ μ s, type	40 V
Protection level wire-PE 8/20 μ s, type	65 V
Protection level wire-wire 1kV/ μ s, type	80 V
Protection level wire-wire 8/20 μ s, type	130 V
Approvals	
Approvals	CE; UL

Rated voltage (AC)	24 V
Rated voltage (DC)	24 V
Max. continuous voltage, U_c (AC)	27 V
Operating current, I_{max}	0.5 A
Volume resistance	2.50 Ω
Gas discharge tube	Yes
Varistor	Yes
Suppression diodes	Yes
Limiting frequency (-3 dB) at load resistance	500 kHz 240 Ω
Discharge current, max. (8/20 μ s)	5 kA
Lightning test current I_{imp} (10/350 μ s)	1 kA
Requirements category acc. to IEC 61643-21	D1
Design	Terminal
Storage temperature	-40 °C...85 °C
Ambient temperature (operational)	-40 °C...60
Protection level	
Protection level wire-PE 1kV/ μ s, type	40 V
Protection level wire-PE 8/20 μ s, type	65 V
Protection level wire-wire 1kV/ μ s, type	80 V
Protection level wire-wire 8/20 μ s, type	130 V
Approvals	
Approvals	CE; UL

Rated voltage (AC)	24 V
Rated voltage (DC)	24 V
Max. continuous voltage, U_c (AC)	27 V
Operating current, I_{max}	0.5 A
Volume resistance	2.50 Ω
Gas discharge tube	Yes
Varistor	Yes
Suppression diodes	Yes
Limiting frequency (-3 dB) at load resistance	500 kHz 240 Ω
Discharge current, max. (8/20 μ s)	5 kA
Lightning test current I_{imp} (10/350 μ s)	1 kA
Requirements category acc. to IEC 61643-21	D1
Design	Terminal
Storage temperature	-40 °C...85 °C
Ambient temperature (operational)	-40 °C...60
Protection level	
Protection level wire-PE 1kV/ μ s, type	40 V
Protection level wire-PE 8/20 μ s, type	65 V
Protection level wire-wire 1kV/ μ s, type	80 V
Protection level wire-wire 8/20 μ s, type	130 V
Approvals	
Approvals	CE; UL

Dimensions

Height x width x depth mm

91 / 6 / 63.5

91 / 6 / 63.5

Note

See derating curve in the introductory text chapter in Catalogue 4.4

See derating curve in the introductory text chapter in Catalogue 4.4

Ordering data

Type	Qty.	Order No.
MCZ OVP CL 24VUC 1,25A	10	8448960000

Type	Qty.	Order No.
MCZ OVP SL 24VDC 0,5A	10	8448940000

Note





MCZ OVP series

3- or 1-stage protection with tension clamp connection

- Slim overvoltage protection terminal with tension clamp connection
- 6 mm slim fine overvoltage protection
- Fast wiring thanks to TS contact and tension clamp connections

MCZ OVP SL 24 V UC 1.25 A

Protection for binary signals

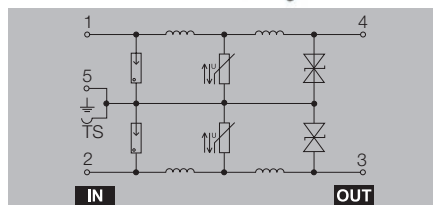

MCZ OVP CL 48 V UC 0.5 A

Protection for current loops

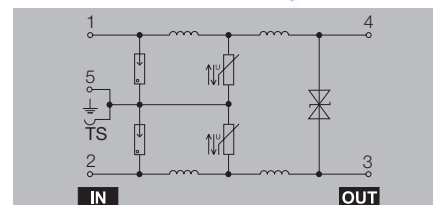

Technical data

Rated voltage (AC)	24 V
Rated voltage (DC)	24 V
Max. continuous voltage, U_c (AC)	28 V
Operating current, I_{max}	1.25 A
Volume resistance	1.00 Ω
Gas discharge tube	Yes
Varistor	Yes
Suppression diodes	Yes
Limiting frequency (-3 dB) at load resistance	500 kHz 240 Ω
Discharge current, max. (8/20 μ s)	5 kA
Lightning test current I_{imp} (10/350 μ s)	1 kA
Requirements category acc. to IEC 61643-21	D1
Design	Terminal
Storage temperature	-40 °C...85 °C
Ambient temperature (operational)	-40 °C...60
Protection level	
Protection level wire-PE 1kV/ μ s, type	40 V
Protection level wire-PE 8/20 μ s, type	65 V
Protection level wire-wire 1kV/ μ s, type	80 V
Protection level wire-wire 8/20 μ s, type	130 V
Approvals	
Approvals	CE; UL

Rated voltage (AC)	48 V
Rated voltage (DC)	48 V
Max. continuous voltage, U_c (AC)	53 V
Operating current, I_{max}	0.5 A
Volume resistance	2.50 Ω
Gas discharge tube	Yes
Varistor	Yes
Suppression diodes	Yes
Limiting frequency (-3 dB) at load resistance	500 kHz 240 Ω
Discharge current, max. (8/20 μ s)	5 kA
Lightning test current I_{imp} (10/350 μ s)	2.5 kA
Requirements category acc. to IEC 61643-21	D1
Design	Terminal
Storage temperature	-40 °C...85 °C
Ambient temperature (operational)	-40 °C...60
Protection level	
Protection level wire-PE 1kV/ μ s, type	80 V
Protection level wire-PE 8/20 μ s, type	150 V
Protection level wire-wire 1kV/ μ s, type	82 V
Protection level wire-wire 8/20 μ s, type	150 V
Approvals	
Approvals	CE; UL

Rated voltage (AC)	48 V
Rated voltage (DC)	48 V
Max. continuous voltage, U_c (AC)	53 V
Operating current, I_{max}	0.5 A
Volume resistance	2.50 Ω
Gas discharge tube	Yes
Varistor	Yes
Suppression diodes	Yes
Limiting frequency (-3 dB) at load resistance	500 kHz 240 Ω
Discharge current, max. (8/20 μ s)	5 kA
Lightning test current I_{imp} (10/350 μ s)	2.5 kA
Requirements category acc. to IEC 61643-21	D1
Design	Terminal
Storage temperature	-40 °C...85 °C
Ambient temperature (operational)	-40 °C...60
Protection level	
Protection level wire-PE 1kV/ μ s, type	80 V
Protection level wire-PE 8/20 μ s, type	150 V
Protection level wire-wire 1kV/ μ s, type	82 V
Protection level wire-wire 8/20 μ s, type	150 V
Approvals	
Approvals	CE; UL

Dimensions

Height x width x depth mm

91 / 6 / 63.5

91 / 6 / 63.5

Note

See derating curve in the introductory text chapter in Catalogue 4.4

See derating curve in the introductory text chapter in Catalogue 4.4

Ordering data

Type	Qty.	Order No.
MCZ OVP SL 24VUC 1,25A	10	8448970000

Type	Qty.	Order No.
MCZ OVP SL 24VUC 1,25A	10	8448970000

Type	Qty.	Order No.
MCZ OVP CL 48VUC 0,5A	10	8449000000

Note

3- or 1-stage protection with tension clamp connection

- Slim overvoltage protection terminal with tension clamp connection
- 6 mm slim fine overvoltage protection
- Fast wiring thanks to TS contact and tension clamp connections

MCZ OVP SL 48 V UC 0.5 A

Protection for binary signals

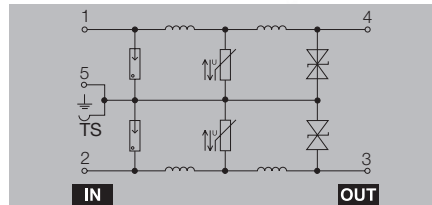

MCZ OVP CL 48 V UC 1.25 A

Protection for current loops

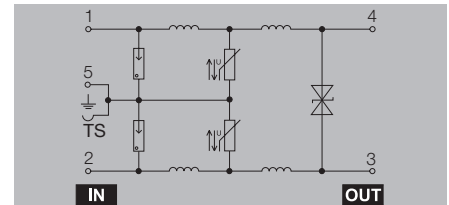

Technical data

Rated voltage (AC)	48 V
Rated voltage (DC)	48 V
Max. continuous voltage, U_c (AC)	53 V
Operating current, I_{max}	0.5 A
Volume resistance	2,50 Ω
Gas discharge tube	Yes
Varistor	Yes
Suppression diodes	Yes
Limiting frequency (-3 dB) at load resistance	500 kHz 240 Ω
Discharge current, max. (8/20 μ s)	5 kA
Lightning test current I_{imp} (10/350 μ s)	1 kA
Requirements category acc. to IEC 61643-21	D1
Design	Terminal
Storage temperature	-40 °C...85 °C
Ambient temperature (operational)	-40 °C...60 °C
Protection level	
Protection level wire-PE 1kV/ μ s, type	82 V
Protection level wire-PE 8/20 μ s, type	150 V
Protection level wire-wire 1kV/ μ s, type	160 V
Protection level wire-wire 8/20 μ s, type	300 V
Approvals	
Approvals	CE; UL

Rated voltage (AC)	48 V
Rated voltage (DC)	48 V
Max. continuous voltage, U_c (AC)	53 V
Operating current, I_{max}	1.25 A
Volume resistance	1,00 Ω
Gas discharge tube	Yes
Varistor	Yes
Suppression diodes	Yes
Limiting frequency (-3 dB) at load resistance	500 kHz 240 Ω
Discharge current, max. (8/20 μ s)	5 kA
Lightning test current I_{imp} (10/350 μ s)	1 kA
Requirements category acc. to IEC 61643-21	D1
Design	Terminal
Storage temperature	-40 °C...85 °C
Ambient temperature (operational)	-40 °C...60 °C
Protection level	
Protection level wire-PE 1kV/ μ s, type	82 V
Protection level wire-PE 8/20 μ s, type	150 V
Protection level wire-wire 1kV/ μ s, type	82 V
Protection level wire-wire 8/20 μ s, type	150 V
Approvals	
Approvals	CE; UL

Rated voltage (AC)	48 V
Rated voltage (DC)	48 V
Max. continuous voltage, U_c (AC)	53 V
Operating current, I_{max}	1.25 A
Volume resistance	1,00 Ω
Gas discharge tube	Yes
Varistor	Yes
Suppression diodes	Yes
Limiting frequency (-3 dB) at load resistance	500 kHz 240 Ω
Discharge current, max. (8/20 μ s)	5 kA
Lightning test current I_{imp} (10/350 μ s)	1 kA
Requirements category acc. to IEC 61643-21	D1
Design	Terminal
Storage temperature	-40 °C...85 °C
Ambient temperature (operational)	-40 °C...60 °C
Protection level	
Protection level wire-PE 1kV/ μ s, type	82 V
Protection level wire-PE 8/20 μ s, type	150 V
Protection level wire-wire 1kV/ μ s, type	82 V
Protection level wire-wire 8/20 μ s, type	150 V
Approvals	
Approvals	CE; UL

Dimensions

Height x width x depth mm

91 / 6 / 63.5

91 / 6 / 63.5

Note

See derating curve in the introductory text chapter in Catalogue 4.4

See derating curve in the introductory text chapter in Catalogue 4.4

Ordering data

Type	Qty.	Order No.
MCZ OVP SL 48VUC 0,5A	10	8449030000

Type	Qty.	Order No.
MCZ OVP CL 48VUC 1,25A	10	8449040000

Note





MCZ OVP series

3- or 1-stage protection with tension clamp connection

- Slim overvoltage protection terminal with tension clamp connection
- 6 mm slim fine overvoltage protection
- Fast wiring thanks to TS contact and tension clamp connections

MCZ OVP SL 48 V UC 1.25 A

Protection for binary signals

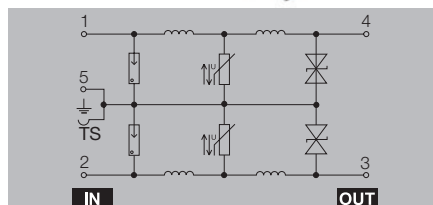
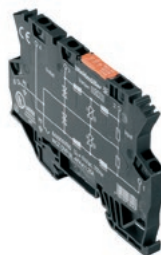

MCZ OVP SL FG 24 V AC 0.5 A

Floating earth

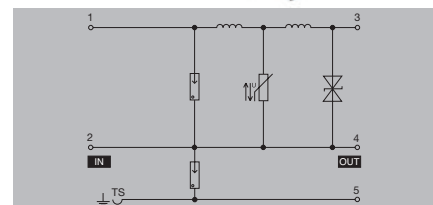

Technical data

Rated voltage (AC)
 Rated voltage (DC)
 Max. continuous voltage, U_c (AC)
 Operating current, I_{max}
 Volume resistance
 Gas discharge tube
 Varistor
 Suppression diodes
 Limiting frequency (-3 dB) at load resistance
 Discharge current, max. (8/20 μ s)
 Lightning test current I_{imp} (10/350 μ s)
 Requirements category acc. to IEC 61643-21
 Design
 Storage temperature
 Ambient temperature (operational)

Protection level

Protection level wire-PE 1kV/ μ s, type
 Protection level wire-PE 8/20 μ s, type
 Protection level wire-wire 1kV/ μ s, type
 Protection level wire-wire 8/20 μ s, type

Approvals

Approvals

48 V
 48 V
 53 V
 1.25 A
 1.00 Ω
 Yes
 Yes
 Yes
 500 kHz 240 Ω
 5 kA
 2.5 kA
 D1
 Terminal
 -40 °C...85 °C
 -40 °C...60

80 V
 150 V
 160 V
 300 V

CE; UL

24 V
 24 V
 28 V
 0.5 A
 1.00 Ω
 Yes
 Yes
 Yes
 500 kHz 240 Ω
 5 kA
 1 kA
 D1
 Terminal
 -40 °C...85 °C
 -40 °C...60

40 V
 65 V
 40 V
 65 V

CE

Dimensions

Height x width x depth mm

91 / 6 / 63.5

91 / 6 / 63.5

Note

See derating curve in the introductory text chapter in Catalogue 4.4

See derating curve in the introductory text chapter in Catalogue 4.4

Ordering data

Type	Qty.	Order No.
MCZ OVP SL 48VUC 1,25A	10	8449050000

Type	Qty.	Order No.
MCZ OVP SL FG 24VUC 0,5A	10	8823280000

Note

3- or 1-stage protection with tension clamp connection

- Slim overvoltage protection terminal with tension clamp connection
- 6 mm slim fine overvoltage protection
- Fast wiring thanks to TS contact and tension clamp connections

MCZ OVP CL FG 24 V AC 0.5 A

Floating earth

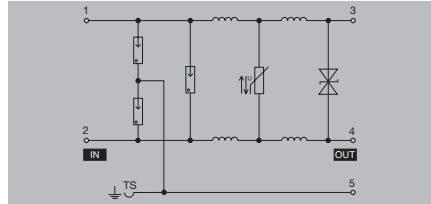

Technical data

Rated voltage (AC)
 Rated voltage (DC)
 Max. continuous voltage, U_c (AC)
 Operating current, I_{max}
 Volume resistance
 Gas discharge tube
 Varistor
 Suppression diodes
 Limiting frequency (-3 dB) at load resistance
 Discharge current, max. (8/20 μ s)
 Lightning test current I_{imp} (10/350 μ s)
 Requirements category acc. to IEC 61643-21
 Design
 Storage temperature
 Ambient temperature (operational)

24 V
 24 V
 28 V
 0.5 A
 2.50 Ω
 Yes
 Yes
 Yes
 500 kHz 240 Ω
 5 kA
 1 kA
 D1
 Terminal
 -40 °C...85 °C
 -40 °C...60

Protection level

Protection level wire-PE 1kV/ μ s, type
 Protection level wire-PE 8/20 μ s, type
 Protection level wire-wire 1kV/ μ s, type
 Protection level wire-wire 8/20 μ s, type

40 V
 65 V
 40 V
 65 V

Approvals

Approvals

CE

Dimensions

Height x width x depth

mm

91 / 6 / 63.5

Note

See derating curve in the introductory text chapter in Catalogue 4.4

Ordering data

Type	Qty.	Order No.
MCZ OVP CL FG 24VUC 0,5A	10	8704240000

Note

C



Differences between earthing and shielding

The terms “earthing” and “shielding” are classified according to their relation to human safety or facility safety. The earth is installed primarily to protect human life and for this reason is referred to as the protective earth conductor. On the other hand, shielding is used to ensure that the electrical system functions properly. It also ensures electromagnetic compatibility.

These main differences between the two terms influence the electrical design and installation. Shielding is not designed to transfer power, although leakage currents may flow on them. A protective earth conductor, however, must be able to briefly discharge a high fault current (IEC 60947-7-2). The short-term current resistance of the PE connection must be 120 A/mm² for the connected cross-section.

The illustration below shows how these two topics relate to each other in application.

As shown in the picture below, the cable’s shielding is connected to the earth potential so that the shield’s current can be discharged. Depending on the sensitivity of the facility, isolated areas of potential can be created. However it is still typical to mix the areas, so that the shielding is on a common equipotential earth. This illustration shows how the number of shields and PE conductors that need to be connected can increase quite rapidly (in this case only one component is used). The shielding and earthing systems must be planned carefully to provide adequate safeguards for personnel and equipment. The following sections describe the complexity and uniqueness in more detail.

Different symbols are also used for the two themes:



Shielding



Earthing

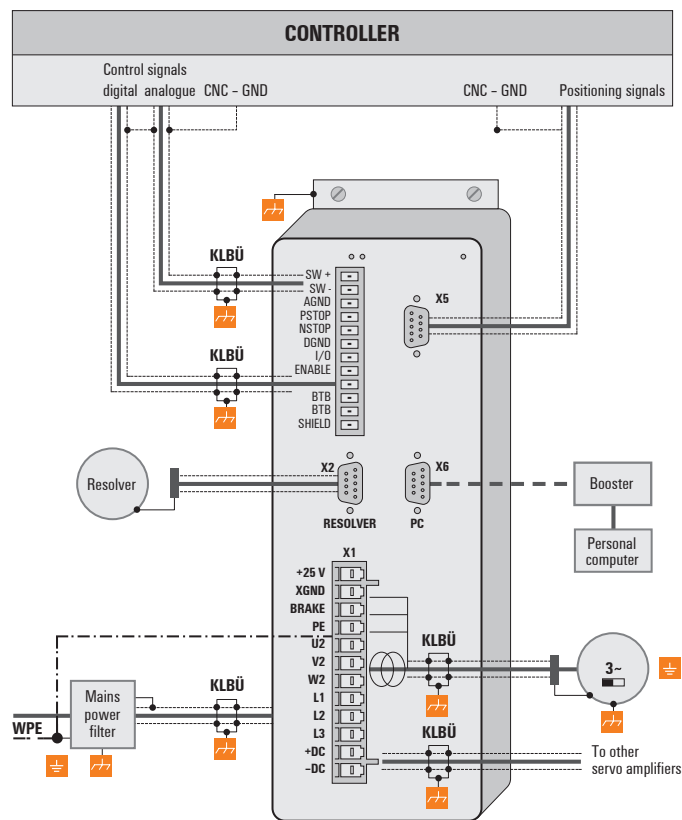

Connection diagram for a frequency converter

Earthing for shielded cables

Electrical and electronic systems should be designed and installed so that they are essentially protected against electrical interference, so that they also function reliably in the event of transient interference voltages.

Electrical interference is introduced into circuits in many different ways. The most frequent cause is inductive interference effects. However, conductive or capacitive coupling plus electrical fields and other phenomena can also cause interference voltages. In these cases high-frequency voltage oscillations – the so-called transients – are very likely the cause of the interference.

Shielded lines enhance interference immunity

The sources of interference voltages can never be eliminated completely. Therefore, we have to take measures to deal with their effects. Generally, it is true to say that the more effectively we can keep interference voltages away or discharge them from circuit elements, the smaller are their disturbing effects. This can be done in many ways – with differing degrees of effectiveness. One really effective measure for protecting against inductive influences, i.e. guaranteeing the electromagnetic compatibility, is to shield the electric functional components at earth potential. One way of doing this is to install components in metal, earthed housings and to shield the connecting lines.

Generally, it is true to say that counteracting the interference effects of lines is feasible by laying the lines as far apart as possible, keeping the common return as short as practical, or using twisted lines. A far better method of protection, however, is to provide a continuous shield for all lines. This is the most effective measure that can be taken against the coupling together of interferences.

The best form of shielding consists of a braided hose of individual wires made from a non-magnetic material (copper, aluminium). The braiding should be sufficiently robust and as solid as possible. Care must be taken with lines protected by a foil shield because of the foil's low mechanical strength and low current-carrying capacity.

Correct use of shielded lines

Adding shielding to lines achieves the desired effect only when they are properly designed and installed. Incorrect earthing or the use of components that do not function satisfactorily reduce the effect or even nullify it altogether. It is not sufficient to connect the shielding to earth potential at just any point because it could be the case that this earth connection is inadequate for high frequencies. In addition, we must also watch out for earth loops, the shielding must be earthed over a large area, and the quality of the shield bonding lines and earthing accessories is also important.



Shielding



In practice, the shield is often twisted and connected to a terminal point. There is very high attenuation (voltage drop) on these connections, especially for high-frequency interference. Therefore this type of shielding should not be used, even for short cable lengths. The cable shield is practically negated and can, at best, be helpful for low-frequency interference. We recommend a large, extensive contact with the braided shield of the cable.

There are four main types of coupling:

- Galvanic coupling
- Capacitive coupling
- Inductive coupling
- Radiation coupling

Such interferences usually occur mixed together, but they can be categorised as follows:

- Electromagnetic fields
- Ripple voltage (50 Hz)
- Lightning
- Interference pulses (current, voltage)
- Transient surge voltages
- Radio interference
- ESD (electrostatic)
- Burst
- Mains feedback

The conductor "flow" is another detail for concern with the shield contact. The temperature changes caused by the current flow lead to changes in the wire's diameter. A rigid contact can therefore only be partially effective. A self-adjusting contact is what is really required. Weidmüller's clamping yoke products (KLBÜ) provide the perfect solution for this challenge.

The following pictures show examples of use:

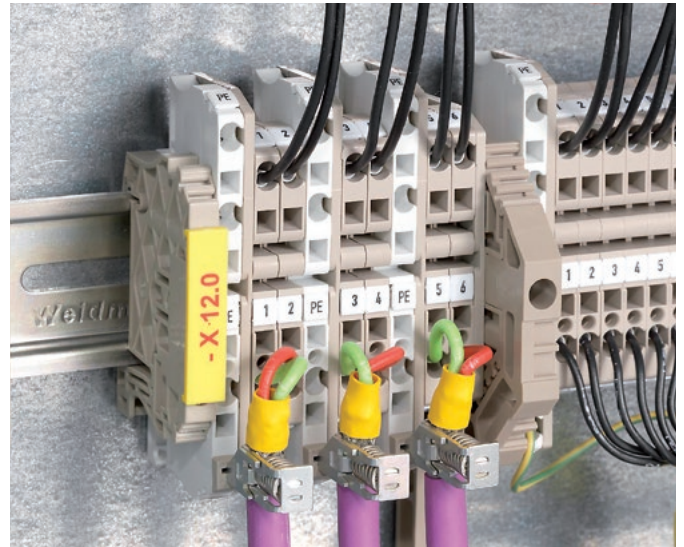

Shield connection via functional earth

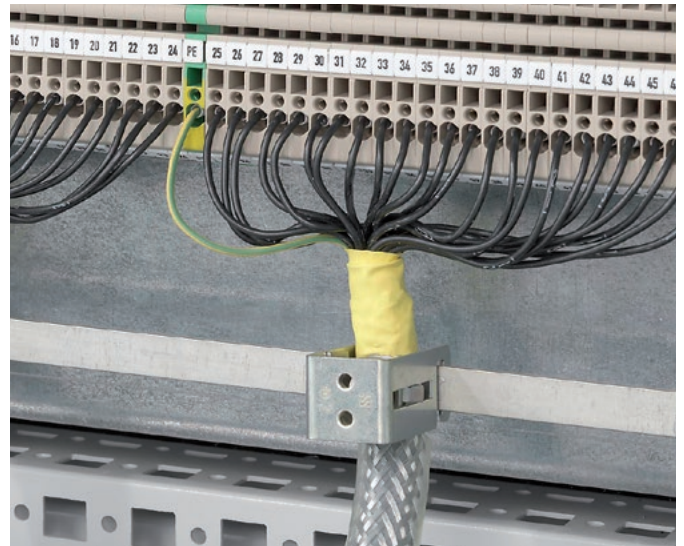

Shield connection on common earth



Effective shielding

It is important to remember that the shielding should not be connected to the earth of the module connected, but rather to the protective earth (PE). In the case of modules mounted in an earthed, metal housing, the shielding must be connected to this housing. If an earthed housing is not available, the shielding must be connected to a separate earth.

When laying earth connections to shields it must also always be ensured that no earth loops are formed. The smaller the earth loop, the lower is the risk of inducing interference voltages. Therefore, a true star arrangement is the best answer.

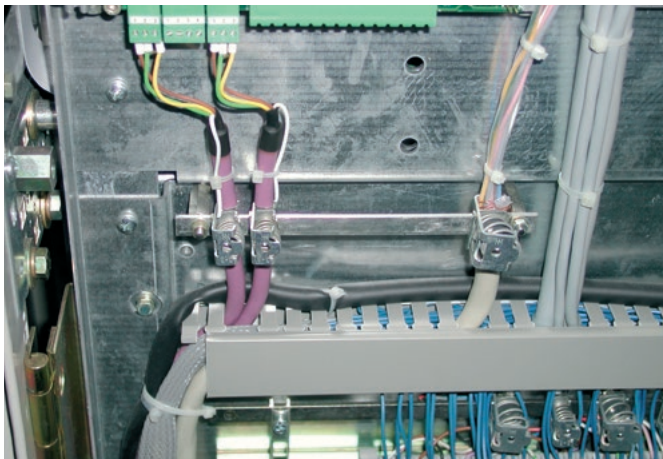

The sketches below show general, feasible connections between shield and protective earth.

Connecting the shield at one end protects against capacitive-coupled interference voltages.

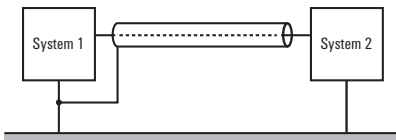

Connecting the shield at both ends is suitable for protecting against inductive-coupled interference fields.

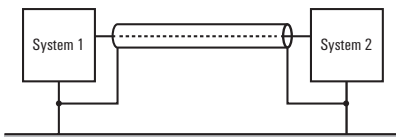

A high-resistance connection at one end of the shield is recommended when trying to avoid the disadvantages of forming an earth loop in the case of shields connected at both ends.

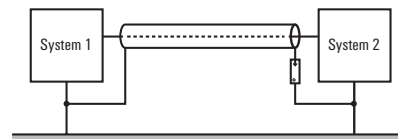

On longer shielded lines, e.g. when a sensor has to be routed to the control room, the potential difference between the two ends should not be ignored. If a current-carrying shield bonding line is used, it is possible to compensate for the potential difference between the measuring point and the control room by means of this shield. However, such shield lines are relatively expensive and also complicated to fabricate and install. Another possibility is to lay an additional equipotential bonding line between the measuring point and the control room. The shield can then be connected at both ends.

Yet another possibility is a high-resistance earth. The shield is then connected to earth potential in the control room, and at the measuring point connected to earth via a gas discharge tube in a high-resistance arrangement. This solves the problems of potential transfer and a 50 Hz hum.

Two gas discharge tubes must be installed for non-floating measuring points. One connects the shield to earth and the other to the non-floating measuring point. This prevents conductive coupling between the measuring circuit and the earthed measuring point.

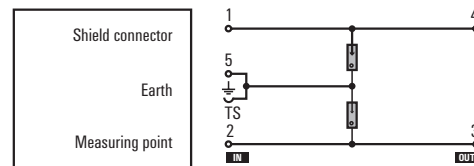

Summary

The earthing is an important factor affecting the reliable operation of electrical installations in the event of interference effects. RF aspects must be taken into account. Only the correct use of materials and well-thought-out circuit design can bring success.

Installation advice for instrumentation and control engineering

The supply and earth lines to protective modules should be kept short in order to achieve optimum protection for equipment.

The fuses for the protective modules should be chosen depending on the rated current as well as on the type of line and its route.

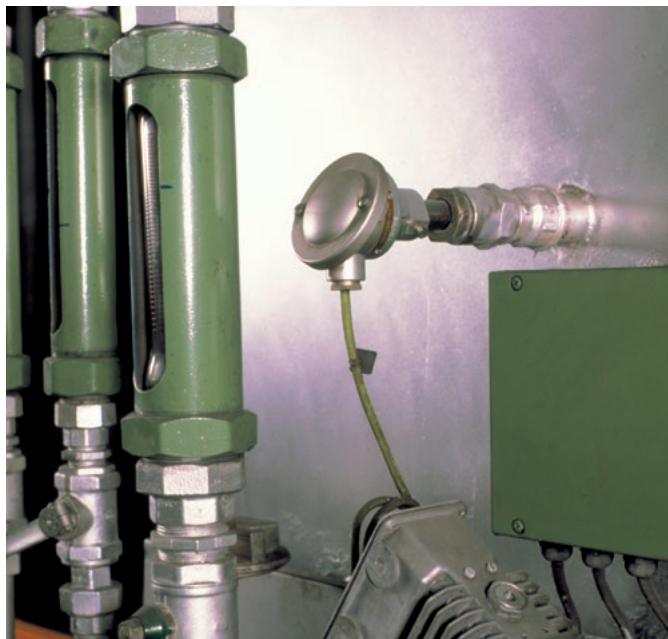

Installation position

The protective modules are frequently installed at both ends of the line.

It is important to ensure that protected and unprotected lines are routed separately. In addition, there must be some distance between power lines and data lines. A common cable duct should be connected with metal partitions.

The protective modules should be mounted in a panel near the entry point of the lines. Unprotected lines should not be fed into parts of the system. Therefore, the lower level in the panel should be used for the protective modules.

Mounting rail contact as earth in connection for MCZ OVP

Contact to the rail is automatically established using the snap-on attachment. The TS35 rail must be earthed in order to ensure safe power discharging via the surge protection elements of up to 20 kA (8/20 μ s) and 2.5 kA (10/350 μ s). The DIN rail should be screwed onto the earthed mounting plate to ensure EMC. It is also possible to contact the PE every 60 cm / 24 inch using the tension-clamp terminal on the MCZ OVP.

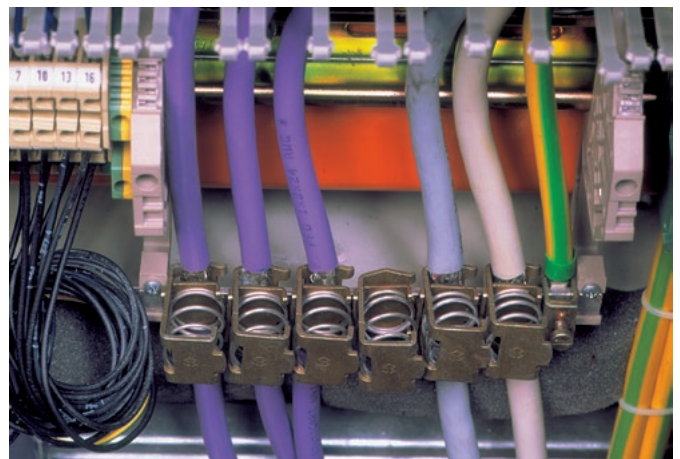

The shielded signal lines should be connected to PE via terminal clamps (Weidmüller KLBÜ). Unshielded lines should be twisted. Neutral earthing is preferred. All the protective modules belonging to one part of the system should have neutral earthing. A through-connection of the earth line should be avoided.

Protected and unprotected lines must be laid separately. A common cable duct should be connected with metal partitions.

Likewise, signal and power lines should be laid separately. Electrical isolation, e.g. with relay couplers or analogue converters, should be employed for installations involving several buildings. This avoids interference currents via minus, PE or N.

The supply and earth lines to protective modules should be kept short in order to achieve optimum protection for equipment. Transmission paths should also be kept as short as possible because the longer the line, the greater is the chance that interference can affect the line. The inclusion of surge protection also increases the attenuation of the line and therefore changes the signal-to-noise ratio.



Surge protection for binary signals

The VSPC 4 SL plug-in surge protector can be used to protect the 24-V supply and also the 24-V switching signals.

The unprotected side points in the direction where the pulse or interference is expected. The connecting cable's shield is connected to terminal 3 e. g. the Weidmüller clamping bracket (KLBÜ) can be used.

The earthed DIN rail can then pick up the pulse and discharge it to the earth.

For long cables, and especially for current loops, additional protection is set-up at the sensors. The VSPC BASE FG floating-earth base can be used there. A built-in gas discharge tube makes this a "high impedance" earth, which prevents an interference current on the shield.

C

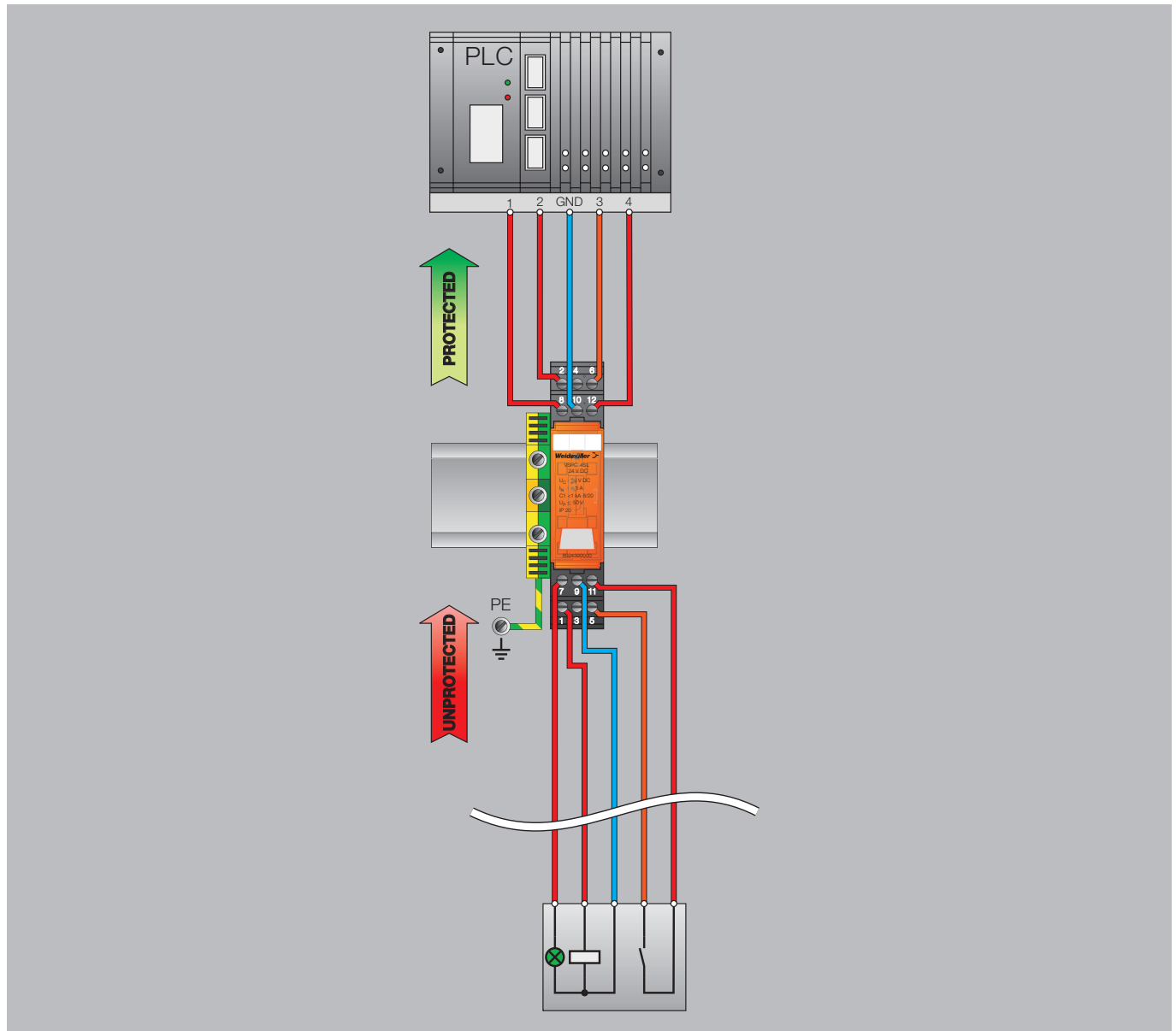

Surge protection for sensors with current loop output 0 (4)...20 mA

VSPC 2CL plug-in surge protector for protecting two current loops with 0 (4)...20 mA.

The unprotected side points in the direction where the pulse or interference is expected. The connecting cable's shield is connected to terminal 3 e. g. the Weidmüller clamping bracket (KLBÜ) can be used.

The earthed DIN rail can then pick up the pulse and discharge it to the earth.

For long cables, and especially for current loops, additional protection is set-up at the sensors. The VSPC BASE FG floating-earth base can be used there. A built-in gas discharge tube makes this a "high impedance" earth, which prevents an interference current on the shield.

C

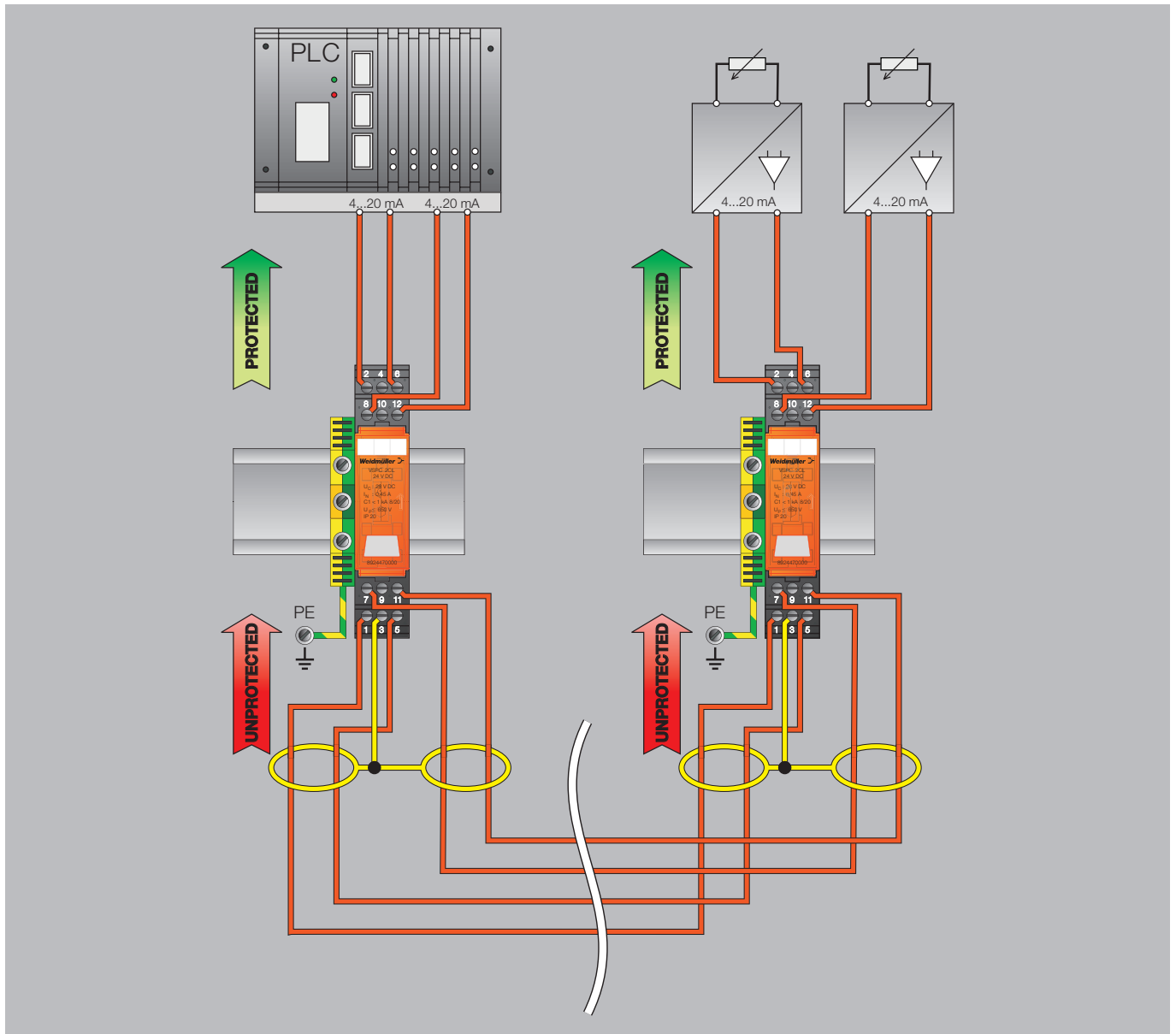

Surge protection for sensors with supply voltage and a current loop 0 (4)...20 mA

The VSPC 1CL PW plug-in surge protector uses a Type III arrester to protect the 24-V supply voltage and also a D1/C2/C1-arrester for the current loop 0 (4)...20 mA. This 17.5-mm configuration protects both power and measurement/control (e.g. for a pumping facility).

The unprotected side points in the direction where the pulse or interference is expected. The connecting cable's shield is connected to terminal 3 e.g. the Weidmüller clamping bracket (KLBÜ) can be used. The earthed DIN rail can then pick up the pulse and discharge it to the earth.

For long cables, and especially for current loops, additional protection is set-up at the sensors. The VSPC BASE FG floating-earth base can be used there. A built-in gas discharge tube makes this a "high impedance" earth, which prevents an interference current on the shield.

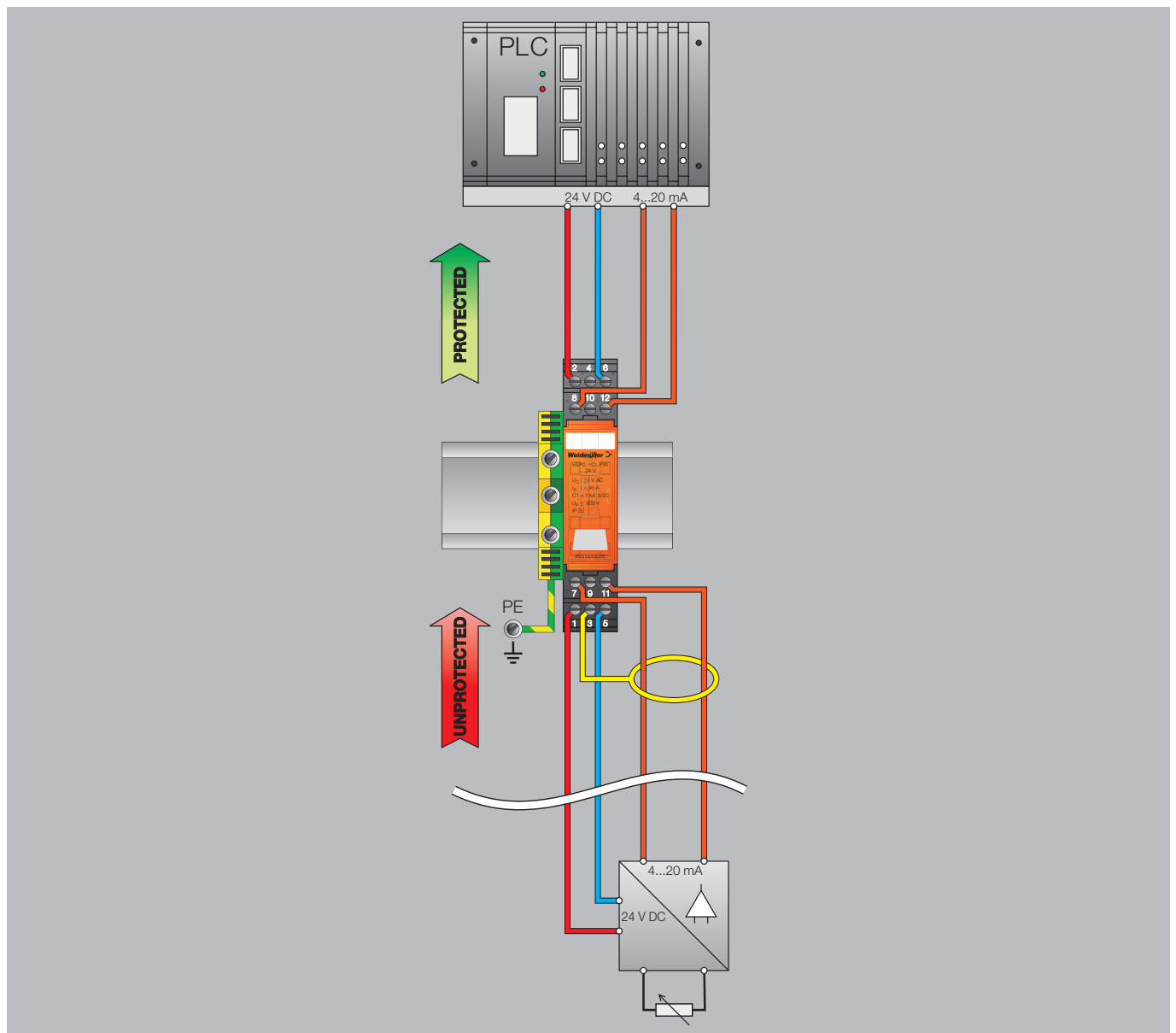

Surge protection for sensors with 4-wire connection or temperature measurement

The plug-in VSPC 3/4 surge protector is used to protect 3- or 4-wire measurement signals (e.g. from temperature sensors or load cells).

The unprotected side points in the direction where the pulse or interference is expected. The connecting cable's shield is connected to terminal 3 e. g. the Weidmüller clamping bracket (KLBÜ) can be used.

The earthed DIN rail can then pick up the pulse and discharge it to the earth.

For long cables, and especially for current loops, additional protection is set-up at the sensors. The VSPC BASE FG floating-earth base can be used there. A built-in gas discharge tube makes this a "high impedance" earth, which prevents an interference current on the shield.

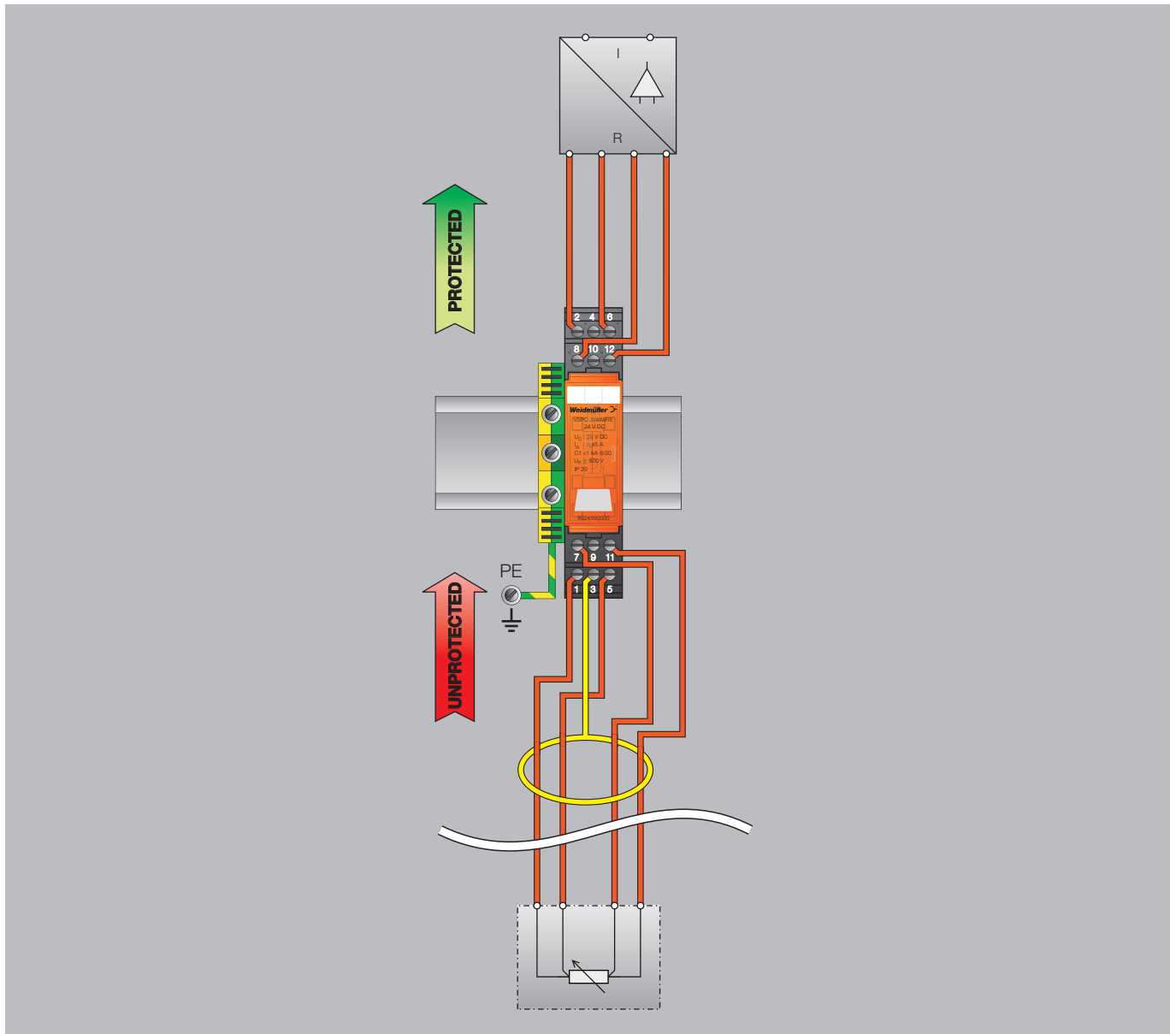

Surge protection for telephone signals U_{ko}

The VSPC U_{ko} plug-in surge protector is used to protect up to two phone lines with up to 4 wires.

The unprotected side points in the direction where the pulse or interference is expected. The connecting cable's shield is connected to terminal 3 e. g. the Weidmüller clamping bracket (KLBÜ) can be used.

The earthed DIN rail can then pick up the pulse and discharge it to the earth.

For long cables, and especially for current loops, additional protection is set-up at the sensors. The VSPC BASE FG floating-earth base can be used there. A built-in gas discharge tube makes this a "high impedance" earth, which prevents an interference current on the shield.

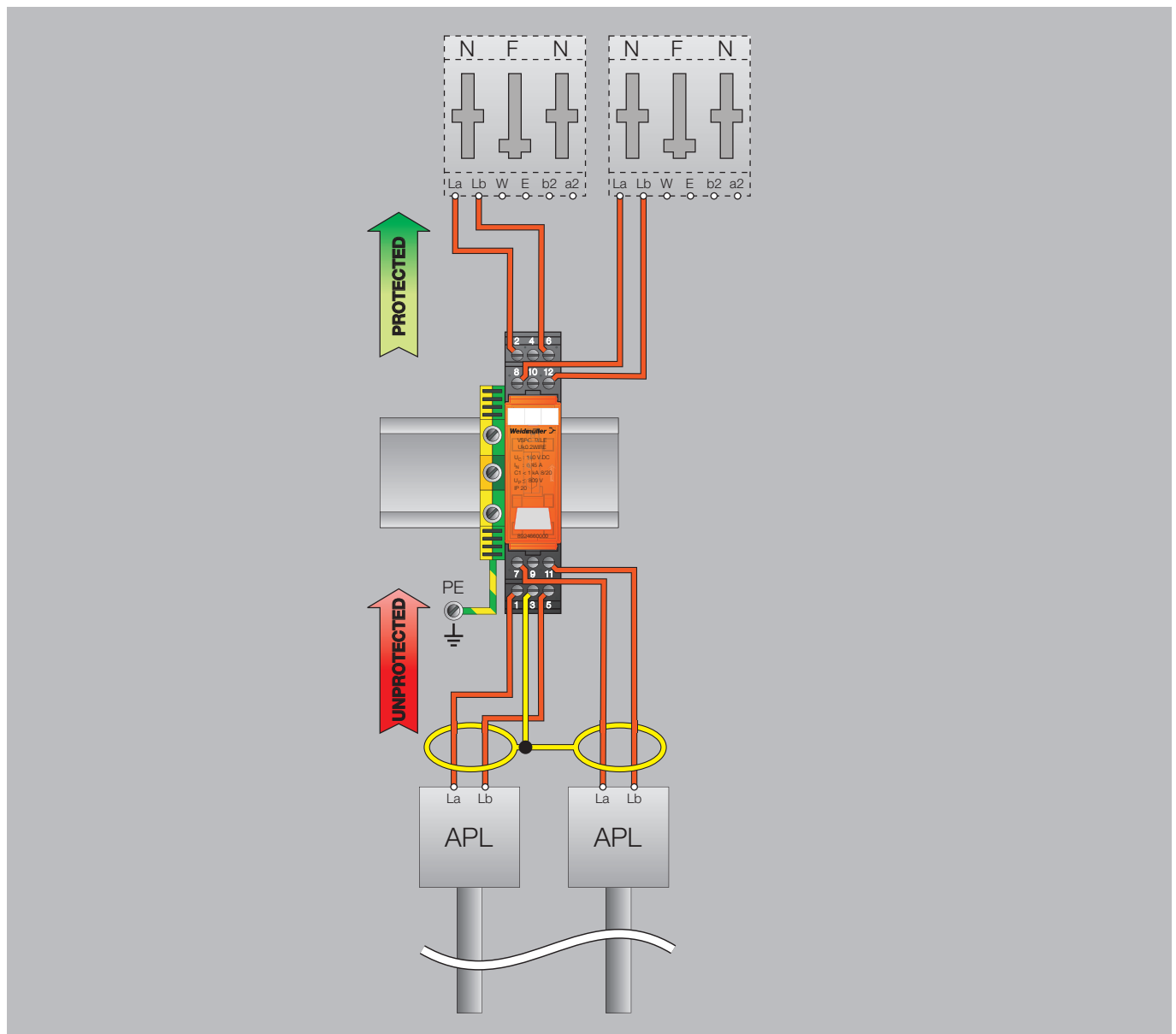

Surge protection for data lines, RS485 or RS422

The VSPC RS485 plug-in surge protector is used to protect an RS485 data line or two RS422 data lines.

The unprotected side points in the direction where the pulse or interference is expected. The connecting cable's shield is connected to terminal 3 e. g. the Weidmüller clamping bracket (KLBÜ) can be used.

The earthed DIN rail can then pick up the pulse and discharge it to the earth.

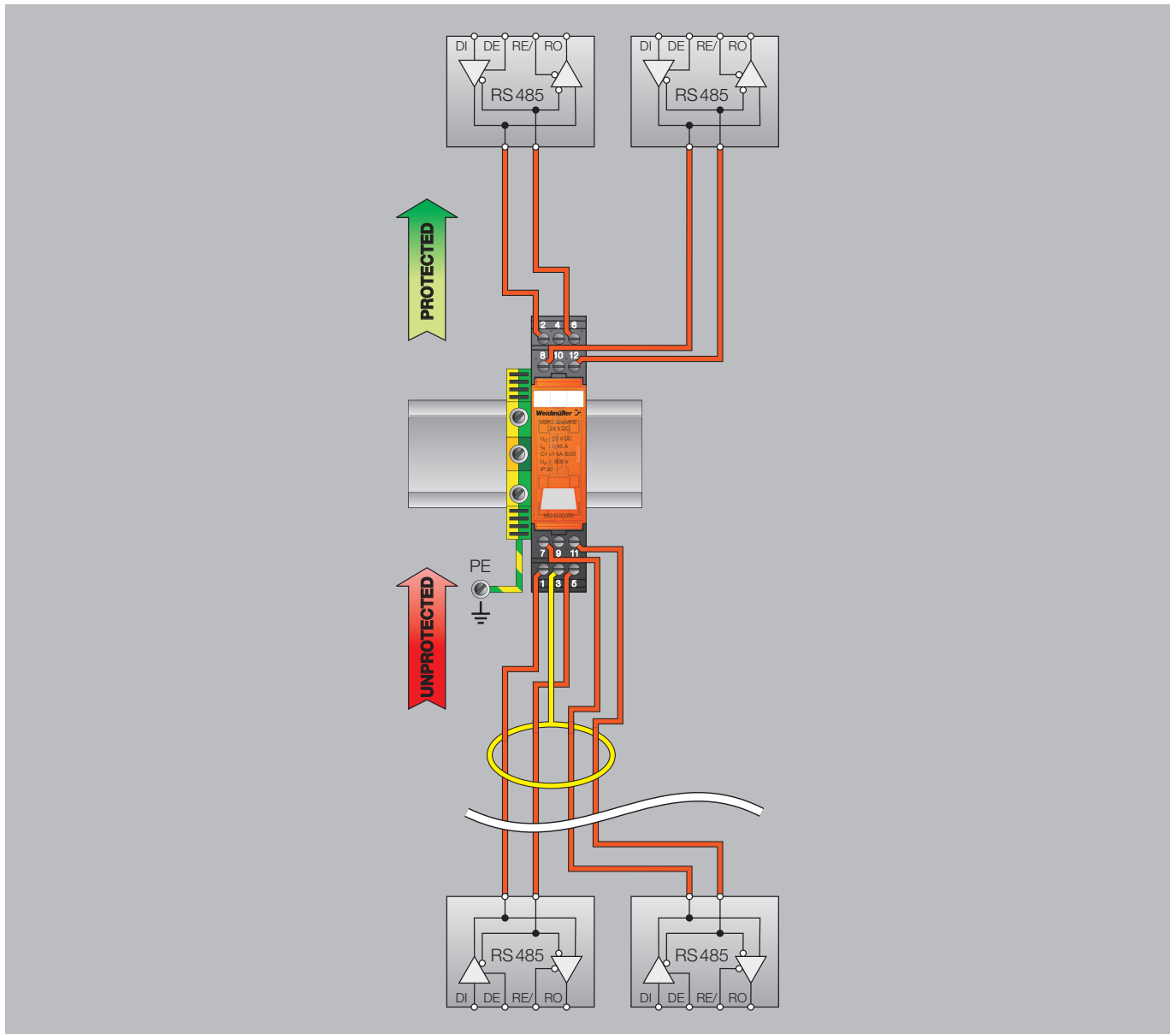



C

VARITECTOR SPC EX and ACT20X



Pluggable surge protection and a universal signal converter for C&I signals in hazardous area applications

Intrinsically safe circuits to limit energy are used in hazardous areas. In these circuits, the intrinsically safe signal converters with their galvanic isolation and Ex approved surge arresters provide excellent protection for sensitive control electronics.

Surge voltages on the field side of the measurement and control lines can damage the facility. The VARITECTOR SPC EX can discharge surge voltages in hazardous area applications (zone 0, 1 and 2). The pluggable arresters conform to the requirements of the current standards with regards to Ex intrinsic safety.

They also comply with the IEC 61643-2-1 surge protection product standard and are certified for protection classes D1, C2 and C3.

The ACT20X-HUI-SAO-LP offers an intrinsically safe input for standard DC signals, temperature signals and resistance signals. It also isolates the Ex zone from the safe area. The 12.5 mm wide module is powered via the 4 ... 20 mA output. The global ATEX, IECEx and cULus Ex approvals allow it to be used throughout the world.



For hazardous areas up to zone 0
 Due to the Ex II 1 G Ex ia II C T4...T6 Ga and Ex II 1D Ex ia III T135 °C...T85 °C approvals, the VARITECTOR SPC EX surge protection component can be installed directly in zones 0, 1 or 2 in order to protect signals.



Unlimited protection

The VSPC EX products are special, intrinsically safe surge arresters. Low Li and Ci values mean they are not relevant for the entire application's proof of intrinsic safety.

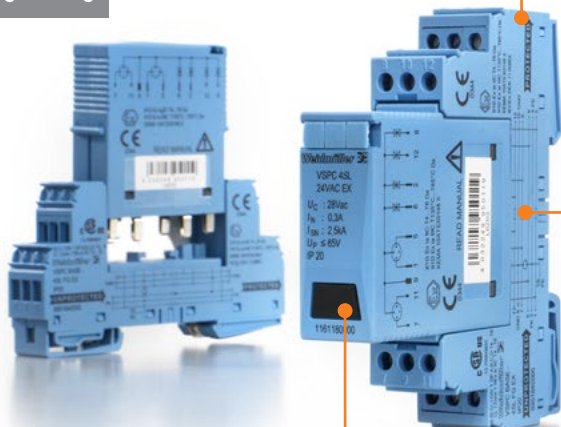

Space saving

The VSPC EX uses less space in the electrical cabinet, with four binary or two analogue signals in only 17.8 mm width.

Hazardous area applications

The ACT20X signal converter is approved for installation in zone 2 and converts signals from zones 0, 1 or 2 for the controller. The product is approved by ATEX, IECEx, and cULus Ex Div 1.



Universal intrinsically safe input

The HART protocol-transparent current isolator ACT20X-HAI-S transmits 4...20 mA signals from Ex-Zone 0 into the safe area. External sensors can be fed via the devices.



Configuration via FDT/DTM

The new ACT20X module can be quickly and comfortably configured with vendor neutral FDT/DTM software such as the WI-Manager software. The software also offers monitoring and diagnostic options.



VARITECTOR SPC EX



Pluggable surge protection for measurement and control systems

VARITECTOR SPC EX

Weidmüller's VARITECTOR SPC EX pluggable surge protector is remarkable for its combination of extremely high protective functionality and compact dimensions. It protects intrinsically safe measurement and control circuits. The size is made possible by the selection of INSTA dimensions, with a width of 17.8 mm (1 TE). You save time on connections because of the screw connection and the indirect earthing contact via the DIN rail. The VARITECTOR SPC series is optimally designed for compact installations in process automation, industrial automation and building automation. The two-stage surge protection terminals are equipped with gas discharge tubes, suppressor diodes (TVS) and decoupling components. IEC 62305 requires that a periodic inspection of surge protection products be conducted. The functionality of all VARITECTOR SPC modules can be tested using testing equipment (such as the V-TEST) that is available separately.

You can get our VARITECTOR SPC surge protection series in the nominal voltages of 5 V, 12 V and 24 V. The product's voltage level is colour-coded on the pluggable arrester.

It can be snapped on an earthed DIN for indirect earthing. The TS 35 must be earthed in order to ensure safe power discharging via the terminals of up to 20 kA (8/20 μ s) and 2.5 kA (10/350 μ s). The DIN rail must be screwed onto the earthed mounting plate to ensure EMC.

In order to optimise the protective function, the PE contact should be made every 60 cm / 24 inch using the terminal on the VARITECTOR SPC module.

A testing device, available as a Weidmüller accessory, allows you to test the protective element in compliance with the IEC 62305-3 directive.

Overview of model types

Surge protection consists of a separate plug-in VARITECTOR SPC EX and a separate base unit VARITECTOR SPC BASE.

ATEX



The VSPC EX series comes in a light blue housing and is used to protect electronics connected to intrinsically safe circuits. The unearthed (floating ground - FG) VARITECTOR SPCs have negligible internal inductance and capacitance.

Labelling of the VSPC EX equipment

ATEX:

For gas
T II 1 G Ex ia IIC T4 ... T6 Ga or
For dust
T II 1 D Ex ia IIIC T135°C ... T85°C Da
KEMA 10 ATEX 0148 X

IEC EX:

For gas
Ex ia IIC T4 ... T6 Ga
For dust
Ex ia IIIC T135 °C ... T85 °C Da

The basic health and safety functions are fulfilled by compliance with: EN 60079-0, EN 60079-11, EN 60079-26 and EN 61241-11, IEC 61643-21

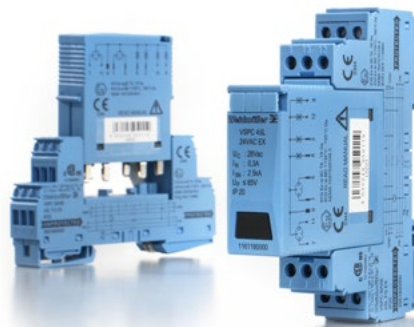

VARITECTOR SPC EX



Products for intrinsically safe circuits

VSPC 1CL 12 V ATEX and VSPC 1CL 24 V ATEX
This VSPC surge protector is used to protect an intrinsically safe current loop.

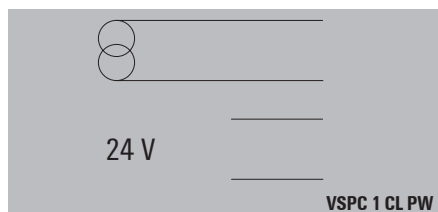

VSPC EX 1 CL 24 V/Power ATEX
This VARITECTOR SPC surge protector protects an analogue signal and has an intrinsically safe power supply which is protected by a Type III end-device protection mechanism. All in one product it is suitable for an intrinsically safe sensor, which also requires an intrinsically safe power supply.

VSPC EX 2SL 12 V DC ATEX
VSPC EX 2SL 12 V AC ATEX
VSPC EX 2SL 24 V DC ATEX
These VSPC EX surge protection modules are used for protecting two intrinsically safe binary signals.

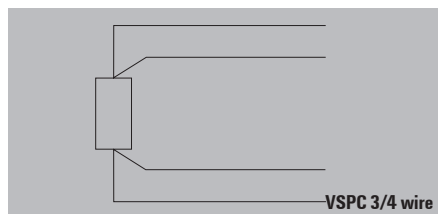

VSPC EX 3/4 wire 5 V ATEX
This VSPC EX surge protector is suitable for 3- or 4-wire measurement systems with signals going in and out of the intrinsically safe zone.

VSPC EX 1CL 5 V ATEX
This VSPC EX surge protector is suitable for temperature signals which goes in and out of the intrinsically safe zone.

VSPC EX 1CL 12 V ATEX (Namur)
This VSPC EX surge protector is used to protect a Namur sensor signal in an intrinsically safe zone.

Colour coding

The pluggable components transfer their coding to the BASE when they are plugged in for the first time. The voltage level is also marked with coloured Dekafix on the VSPC EX plug section. This gives you a better overview within the electrical cabinet.

Voltage level	Colour
≤ 12 V	green
24 V Binary	blue
24 V Analogue	yellow
Special function	white

Testing option

Because the modules are pluggable, it is possible to test the VSPC EX using the V-TEST testing device. The user inserts the VSPC EX into the testing device for testing. The result is then shown on the display.

Periodic inspections

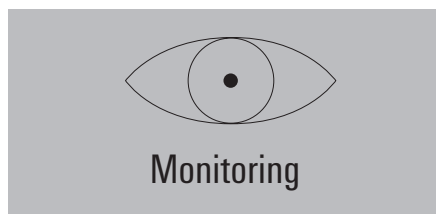

IEC 62305-3 requires testing and maintenance for lightning protection systems.

This includes the testing of the arresters used in the system.

Lightning protection level	Visual inspection	Extensive check	Extensive check in critical situations ^{a), b)}
	Year	Year	Year
I und II	1	2	1
III und IV	2	4	1

Caution! These periodic inspections may be extended with stricter requirements pertaining to special applications or regions.

Markers

The VSPC BASE lower section can be labelled with Dekafix 5 markers. The VSPC pluggable modules are colour coded with Dekafix 5 according to their nominal voltage.

Installation

The VSPC EX series is used to protect signal circuits. In order to achieve a complete protective strategy for the facility, the power feed must be protected with Type II surge protection (for example, by using the VPU AC II series). For existing lightning protection facilities, Type I protection must be used (for example, by using the VPU AC I series).

When there is no lightning protection system, the Type II protection is sufficient (such as the VPU AC II).



VARITECTOR SPC EX

Discharge capacity

Testing is conducted using voltage and current pulses according to the IEC 61643-21 standard concerning surge protection in networks which process signals.

Category	Testing pulse	Surge voltage	Surge current	Pulse	Type
C1	Quick rising edge	0.5 < 2 kV with 1.2/50 µs	0.25 < 1 kA with 8/20 µs	300	Surge voltage arrester
C2	Quick rising edge	2 < 10 kV with 1.2/50 µs	1 < 5 kA with 8/20 µs	10	Surge voltage arrester
C3	Quick rising edge	≥ 1 kV with 1 kV/µs	10 < 100 A with 10/10.000 µs	300	Surge voltage arrester
D1	High power	≥ 1 kV	0.5 < 2.5 kA with 10/350 µs	2	Arrester for lightning current and surge voltages

Category C reflects the interference pulses with quick-rising edges and minimised power. Category D uses quick-rising edges and high power to detail the interference pulses. This energy simulates the high-power load that stems from coupled partial lightning currents.

General technical data

Storage temperature: -40 °C...+80 °C
 Operating temperature: -40 °C...70 °C
 Humidity: 5 %...96 % RH without condensation

Material: V0, IP 20

Wire connection: screw
 SD blade: 0.6 x 3.5 DIN 5264
 Nominal torque: 0.5 Nm
 Max. torque: 0.8 Nm
 Stripping length: 7 mm
 Solid core: 0.5...4 mm²
 Finely stranded: 0.5...2.5 mm²
 Ferrule with plastic collar:
 0.5...2.5 mm²

Dimensions

Height: 90 mm
 Depth: 69 mm
 Width: 17,8 mm





C

VSPC 1CL EX - protection for one analogue signal in intrinsically safe circuits

- For use in zones 2, 1, and 0
- Pluggable arrester (impedance-neutral plugging/unplugging without interruption)
- Can be tested with the V-TEST testing device
- Version with floating-earth PE connection for avoiding voltage potential differences
- Can be used in accordance with installation standard IEC 62305 as well as in ATEX applications
- Tested in accordance with IEC/EN 61643-21: D1,C1,C2,C3
- Integrated PE foot, safely discharges up to 20 kA (8/20 μs) and 2.5 kA (10/350 μs) to PE



Technical data

Dielectric strength at FG against PE	≥ 500 V
Volume resistance	2.20 Ω
Overload - failure mode	Modus 2
Requirements category acc. to IEC 61643-21	C1, C2, C3, D1
Surge current-carrying capacity C1	< 1 kA 8/20 μs
Surge current-carrying capacity C2	5 kA 8/20 μs
Surge current-carrying capacity C3	100 A 10/1000 μs
Surge current-carrying capacity D1	1 kA 10/350 μs
Discharge current I ₁ (8/20 μs) wire-wire/wire-PE/GND-PE	2.5 kA / 2.5 kA / 2.5 kA
Discharge I _{max} (8/20 μs) wire-wire/wire-PE/GND-PE	10 kA / 10 kA / 10 kA
Lightning test I _{imp} (10/350 μs) wire-wire/wire-PE/GND-PE	2.5 kA / 2.5 kA / 2.5 kA
Type of connection	Pluggable in VSPC BASE
Storage temperature	-40 °C...80 °C
Ambient temperature (operational)	-40 °C...70 °C
Protection degree	IP20
UL 94 flammability rating	V-0
Temperature class T6/85 °C (-40 °C ... +60°C) li	250 mA
Temperature class T5/100°C (-40 °C ... +75°C) li	250 mA
Temperature class T4/135°C (-40°C ... +85°C) li	350 mA
Failure probability	
Ages	45
MTTF	2537
SIL in compliance with IEC 61508	3
Approvals	
Approvals	CCCEX; CE; CSAEX; FUSAFETY; IECEXDEK; KEMAATEX
Standards	IEC 61643-21, IEC 62305, DIN EN 60079-0:2009, DIN EN 60079-11:2007, DIN EN 60079-26:2007, DIN EN 61241-11:2006, HART-compatible
ATEX - dust labelling	II 1 D Ex ia IIIC T135 °C ...T85 °C Da
ATEX - gas labelling	II 1 G Ex ia IIC T4... T6 Ga
IECEX - dust labelling	II 1 D Ex ia IIIC T135 °C ...T85 °C Da
IECEX - gas labelling	II 1 G Ex ia IIC T4... T6 Ga

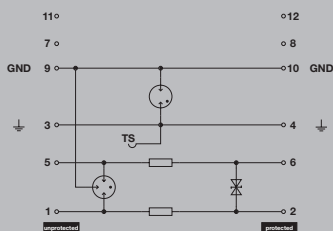

Complete module, indirect earthing

Dimensions	Dimensions
Height x width x depth	mm 90 / 17.8 / 69

Note The associated VSPC base element should be ordered with this. The dimension information provided refers to the complete module.

Base elements / base to arresters



Ordering data for base

Description	Type	Qty.	Order No.
EX base element, indirect earthing / floating earth FG	VSPC BASE 1CL FG EX	1	8951810000

Note Technical data can be found at the beginning of VARITECTOR SPC EX.



VSPC 1CL EX - plug-in components / arrester



Pluggable component / Arrester

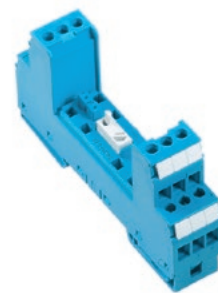

Base element / Base

Ordering data

	VSPC 1CL 5 V DC EX	VSPC 1CL 12 V DC EX	VSPC 1CL 24 V DC EX
Rated voltage (AC)			
Rated voltage (DC)	5 V	12 V	24 V
Rated current I_N	350 mA	350 mA	350 mA
Optical function display	No	No	No
Input attenuation	730 KHz	1.7 MHz	2.4 MHz
Pulse-reset capacity	≤ 20 ms	≤ 20 ms	≤ 30 ms
Residual voltage, U_p typical	< 800 V	< 800 V	< 800 V
EX protection data			
Input voltage, max. U_i	6 V	14 V	26 V
Internal capacity, max. C_i	< 4 nF	< 4 nF	< 4 nF
Internal inductance, max. L_i	0 μ H	0 μ H	0 μ H
Input power, max. P_i	3 W	3 W	3 W
Protection level			
Protection level wire-wire 1kV/ μ s, type	12 V	25 V	45 V
Protection level wire-wire 8/20 μ s, type	12 V	25 V	45 V
Protection level wire-PE 1kV/ μ s, type	450 V	450 V	450 V
Protection level wire-PE 8/20 μ s, type	< 800 V	< 800 V	< 800 V

Ordering data	VSPC 1CL 5VDC EX	VSPC 1CL 12VDC EX	VSPC 1CL 24VDC EX
Type	VSPC 1CL 5VDC EX	VSPC 1CL 12VDC EX	VSPC 1CL 24VDC EX
Order No.	8953660000	8953690000	8953600000
Qty.	1	1	1
Note			

Lightning and surge protection for instrumentation and control (I & C)



VARITECTOR SPC EX

VSPC 2CL EX – protection for two analogue signals in intrinsically safe circuits

- For use in zones 2, 1, and 0
- Pluggable arrester (impedance-neutral plugging/unplugging without interruption)
- Can be tested with the V-TEST testing device
- Space-saving design for 3 analogue signals
- Version with floating-earth PE connection for avoiding voltage potential differences
- Usable in accordance with installations standard IEC 62305
- Tested in accordance with IEC/EN 61643-21: D1,C1,C2,C3
- Integrated PE foot, safely discharges up to 20 kA (8/20 μs) and 2.5 kA (10/350 μs) to PE



C

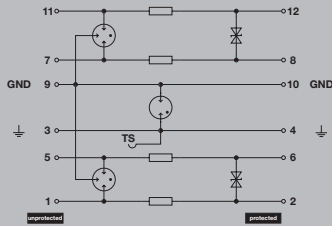

Complete module, indirect earthing

Technical data

Dielectric strength at FG against PE	≥ 500 V
Volume resistance	2.20 Ω
Overload - failure mode	Modus 2
Requirements category acc. to IEC 61643-21	C1, C2, C3, D1
Surge current-carrying capacity C1	< 1 kA 8/20 μs
Surge current-carrying capacity C2	5 kA 8/20 μs
Surge current-carrying capacity C3	100 A 10/1000 μs
Surge current-carrying capacity D1	1 kA 10/350 μs
Discharge current I ₁ (8/20 μs) wire-wire/wire-PE/GND-PE	2.5 kA / 2.5 kA / 2.5 kA
Discharge I _{max} (8/20 μs) wire-wire/wire-PE/GND-PE	10 kA / 2 x 10 kA / 10 kA
Lightning test I _{imp} (10/350 μs) wire-wire/wire-PE/GND-PE	2.5 kA / 2.5 kA / 2.5 kA
Type of connection	Pluggable in VSPC BASE
Storage temperature	-40 °C...80 °C
Ambient temperature (operational)	-40 °C...70 °C
Protection degree	IP20
UL 94 flammability rating	V-0
Temperature class T6/85 °C (-40 °C ... +60 °C) li	250 mA
Temperature class T5/100 °C (-40 °C ... +75 °C) li	250 mA
Temperature class T4/135 °C (-40 °C ... +85 °C) li	350 mA
Failure probability	
Ages	45
MTTF	2537
SIL in compliance with IEC 61508	3
Approvals	
Approvals	CCCEX; CE; CSAEX; FUSAFETY; IECEXDEK; KEMAATEX
Standards	IEC 61643-21, IEC 62305, DIN EN 60079-0:2009, DIN EN 60079-11:2007, DIN EN 60079-26:2007, DIN EN 61241-11:2006, HART-compatible
ATEX - dust labelling	II 1 D Ex ia IIIC T135 °C ...T85 °C Da
ATEX - gas labelling	II 1 G Ex ia IIC T4... T6 Ga
IECEX - dust labelling	II 1 D Ex ia IIIC T135 °C ...T85 °C Da
IECEX - gas labelling	II 1 G Ex ia IIC T4... T6 Ga

Dimensions

Height x width x depth

Dimensions

mm 90 / 17.8 / 69

Note

The associated VSPC base element should be ordered with this. The dimension information provided refers to the complete module.

Base elements / base to arresters

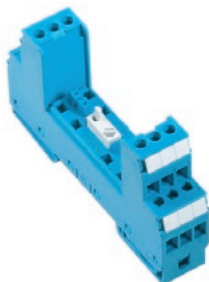

Ordering data for base

Description	Type	Qty.	Order No.
EX base element, indirect earthing / floating earth FG	VSPC BASE 2CL FG EX	1	8951820000

Note

Technical data can be found at the beginning of VARITECTOR SPC EX.

VSPC 2CL EX - plug-in components / arrester



Pluggable component / Arrester



Base element / Base

Ordering data

Rated voltage (AC)
Rated voltage (DC)
Rated current I_N
Optical function display
Input attenuation
Pulse-reset capacity
Residual voltage, U_R typical

VSPC 2CL 24 V DC EX	
Rated voltage (AC)	
Rated voltage (DC)	24 V
Rated current I_N	250 mA
Optical function display	No
Input attenuation	2.3 MHz
Pulse-reset capacity	≤ 30 ms
Residual voltage, U_R typical	< 800 V

EX protection data

Input voltage, max. U_i
Internal capacity, max. C_i
Internal inductance, max. L_i
Input power, max. P_i

Input voltage, max. U_i	26 V
Internal capacity, max. C_i	< 4 nF
Internal inductance, max. L_i	0 μH
Input power, max. P_i	3 W

Protection level

Protection level wire-wire 1kV/μs, type
Protection level wire-wire 8/20 μs, type
Protection level wire-PE 1kV/μs, type
Protection level wire-PE 8/20 μs, type

Protection level wire-wire 1kV/μs, type	45 V
Protection level wire-wire 8/20 μs, type	45 V
Protection level wire-PE 1kV/μs, type	450 V
Protection level wire-PE 8/20 μs, type	< 800 V

Ordering data

Type
Order No.
Qty.

Type	VSPC 2CL 24VDC EX
Order No.	8953720000
Qty.	1

Note

--

--

Lightning and surge protection for instrumentation and control (I & C)

C



VARITECTOR SPC EX

VSPC 1CL PW EX - combinations in current loop signal and device protection in intrinsically safe circuits

- Pluggable arrester (impedance-neutral plugging/unplugging without interruption)
- Can be tested with the V-TEST testing device
- Version with floating-earth PE connection for avoiding voltage potential differences
- Usable in accordance with installations standard IEC 62305
- Tested in accordance with IEC/EN 61643-21: D1,C1,C2,C3
- For use in zones 2, 1, and 0
- Tested in accordance with IEC/EN 61643-11 Class III
- Integrated PE foot, safely discharges up to 20 kA (8/20 μ s) and 2.5 kA (10/350 μ s) to PE



Technical data

Rated voltage (DC)	24 V
Max. continuous voltage, U_c (DC)	38 V
Dielectric strength at FG against PE	≥ 500 V
Volume resistance	2.20 Ω
Overload - failure mode	Modus 2
Requirements category acc. to IEC 61643-21	C1, C2, C3, D1

Surge current-carrying capacity C1	< 1 kA 8/20 μ s
Surge current-carrying capacity C2	5 kA 8/20 μ s
Surge current-carrying capacity C3	100 A 10/1000 μ s
Surge current-carrying capacity D1	2.5 kA 10/350 μ s
Input attenuation	3 MHz
Pulse-reset capacity	≤ 10 ms
Discharge current I_d (8/20 μ s) wire-wire/wire-PE/GND-PE	2.5 kA / 2.5 kA / 2.5 kA
Discharge I_{max} (8/20 μ s) wire-wire/wire-PE/GND-PE	10 kA / 10 kA / 10 kA
Lightning test I_{mp} (10/350 μ s) wire-wire/wire-PE/GND-PE	2.5 kA / 2.5 kA / 2.5 kA
Residual voltage, U_r typical	
Protection level wire-PE 1kV/ μ s, type	450 V
Protection level wire-PE 8/20 μ s, type	
Protection level wire-wire 1kV/ μ s, type	60 V
Protection level wire-wire 8/20 μ s, type	60 V
Standards	IEC 61643-21, IEC 62305, DIN EN 60079-0:2009, DIN EN 60079-11:2007, DIN EN 60079-26:2007, DIN EN 61241-11:2006, HART-compatible

Power protection class III

Rated voltage (DC)	24 V
Max. continuous voltage, U_c (DC)	38 V
Combined pulse U_{oc}	6 kV
Residual voltage, U_r typical	
Rated current	
Input voltage, max. U_i	20 V

Dimensions	Dimensions
Height x width x depth	mm 90 / 17.8 / 69

Note	The associated VSPC base element should be ordered with this. The dimension information provided refers to the complete module.
-------------	---------------------------------------------------------------------------------------------------------------------------------

Base elements / base to arresters

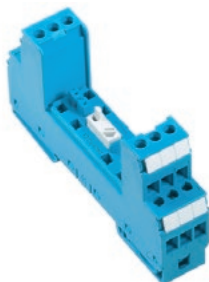

Ordering data for base

Description	Type	Qty.	Order No.
EX base element, indirect earthing / floating earth FG	VSPC BASE 1CL PW FG EX	1	1070470000

Note	Technical data can be found at the beginning of VARITECTOR SPC EX.
-------------	--------------------------------------------------------------------

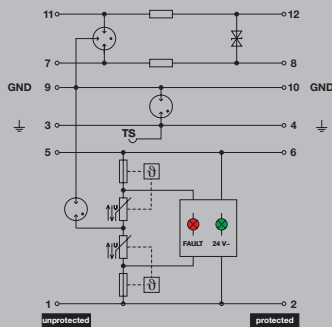

Complete module, indirect earthing

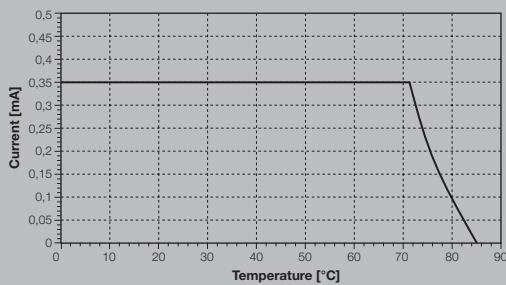

VSPC 1CL PW EX - plug-in components / arrester



Pluggable component / Arrester



Base element / Base

Ordering data

VSPC 1CL PW 24 V EX

Rated voltage (AC)	24 V
Rated voltage (DC)	24 V
Rated current I_n	350 mA
Optical function display	For Class III protection, green = OK; red = arrester is defective - replace
Input attenuation	3 MHz
Pulse-reset capacity	≤ 10 ms
Residual voltage, U_r , typical	≤ 0.9 kV
EX protection data	
Input voltage, max. U_i	20 V
Internal capacity, max. C_i	< 4 nF
Internal inductance, max. L_i	0 μ H
Input power, max. P_i	3 W
Protection level	
Protection level wire-wire 1kV/ μ s, type	60 V
Protection level wire-wire 8/20 μ s, type	60 V
Protection level wire-PE 1kV/ μ s, type	450 V
Protection level wire-PE 8/20 μ s, type	≤ 0.9 kV

Ordering data

Type	VSPC 1CL PW 24V EX
Order No.	8953610000
Qty.	1

Note



VSPC 2SL EX – protection for two binary signals in intrinsically safe circuits

- For use in zones 2, 1, and 0
- Pluggable arrester (impedance-neutral plugging/unplugging without interruption)
- Can be tested with the V-TEST testing device
- Version with floating-earth PE connection for avoiding voltage potential differences
- Can be used in accordance with installation standard IEC 62305 as well as in ATEX applications
- Tested in accordance with IEC/EN 61643-21: D1,C1,C2,C3
- Integrated PE foot, safely discharges up to 20 kA (8/20 μs) and 2.5 kA (10/350 μs) to PE



Technical data

Dielectric strength at FG against PE	≥ 500 V
Volume resistance	4.7 Ω
Overload - failure mode	Modus 2
Requirements category acc. to IEC 61643-21	C1, C2, C3, D1
Surge current-carrying capacity C1	< 1 kA 8/20 μs
Surge current-carrying capacity C2	5 kA 8/20 μs
Surge current-carrying capacity C3	100 A 10/1000 μs
Surge current-carrying capacity D1	2.5 kA 10/350 μs
Discharge current I ₁ (8/20 μs) wire-wire/wire-PE/GND-PE	2.5 kA / 2.5 kA / 2.5 kA
Discharge I _{max} (8/20 μs) wire-wire/wire-PE/GND-PE	10 kA / 10 kA / 10 kA
Lightning test I _{imp} (10/350 μs) wire-wire/wire-PE/GND-PE	2.5 kA / 2.5 kA / 2.5 kA
Type of connection	Pluggable in VSPC BASE
Storage temperature	-40 °C...80 °C
Ambient temperature (operational)	-40 °C...70 °C
Protection degree	IP20
UL 94 flammability rating	V-0
Temperature class T6/85 °C (-40 °C ... +60°C) li	250 mA
Temperature class T5/100°C (-40 °C ... +75°C) li	250 mA
Temperature class T4/135°C (-40°C ... +85°C) li	350 mA
Failure probability	
Ages	43
MTTF	2665
SIL in compliance with IEC 61508	2
Approvals	
Approvals	CCCEX; CE; CSAEX; FUSAFETY; IECEXDEK; KEMAATEX
Standards	IEC 61643-21, IEC 62305, DIN EN 60079-0:2009, DIN EN 60079-11:2007, DIN EN 60079-26:2007, DIN EN 61241-11:2006
ATEX - dust labelling	II 1 D Ex ia IIIC T135 °C ...T85 °C Da
ATEX - gas labelling	II 1 G Ex ia IIC T4... T6 Ga
IECEX - dust labelling	II 1 D Ex ia IIIC T135 °C ...T85 °C Da
IECEX - gas labelling	II 1 G Ex ia IIC T4... T6 Ga

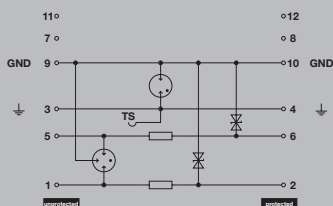

Complete module, indirect earthing

Dimensions	Dimensions
Height x width x depth	mm 90 / 17.8 / 69
Note	Order the associated VSPC base element with this. The dimension information provided refers to the complete module.

Base elements / base to arresters

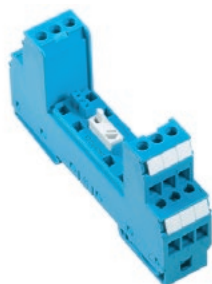

Ordering data for base

Description	Type	Qty.	Order No.
EX base element, indirect earthing / floating earth FG	VSPC BASE 2SL FG EX	1	8951830000

Note Technical data can be found at the beginning of VARITECTOR SPC EX.



VSPC 2SL EX - plug-in components / arrester



Pluggable component / Arrester

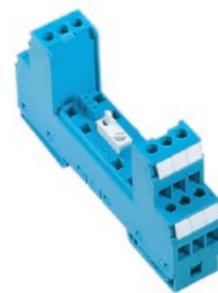

Base element / Base

Ordering data

	VSPC 2SL 12 V DC EX	VSPC 2SL 12 V AC EX	VSPC 2SL 24 V DC EX	VSPC 2SL 48 V AC EX
Rated voltage (AC)		12 V		48 V
Rated voltage (DC)	12 V	16 V	24 V	68 V
Rated current I_N	250 mA	250 mA	250 mA	250 mA
Optical function display	No	No	No	No
Input attenuation	1.2 MHz	2.5 MHz	2.7 MHz	2.7 MHz
Pulse-reset capacity	≤ 20 ms	≤ 20 ms	≤ 30 ms	≤ 60 ms
Residual voltage, U_R typical	< 200 V	250 V	250 V	≤ 300 V
EX protection data				
Input voltage, max. U_i	14 V	19 V	26 V	75 V
Internal capacity, max. C_i	< 4 nF	< 4 nF	< 4 nF	< 4 nF
Internal inductance, max. L_i	0 μ H	0 μ H	0 μ H	0 μ H
Input power, max. P_i	3 W	3 W	3 W	3 W
Protection level				
Protection level wire-wire 1kV/ μ s, type	20 V	20 V	40 V	80 V
Protection level wire-wire 8/20 μ s, type	45 V	55 V	75 V	80 V
Protection level wire-PE 1kV/ μ s, type	25 V	30 V	40 V	85 V
Protection level wire-PE 8/20 μ s, type	< 200 V	250 V	250 V	≤ 300 V
Ordering data				
Type	VSPC 2SL 12VDC EX	VSPC 2SL 12VAC EX	VSPC 2SL 24VDC EX	VSPC 2SL 48VAC EX
Order No.	8953620000	8953630000	8953670000	8953640000
Qty.	1	1	1	1
Note				



VSPC 4SL EX - protection for four binary signals in intrinsically safe circuits

- For use in zones 2, 1, and 0
- Pluggable arrester (impedance-neutral plugging/unplugging without interruption)
- Can be tested with the V-TEST testing device
- Version with floating-earth PE connection for avoiding voltage potential differences
- Usable in accordance with installations standard IEC 62305
- Tested in accordance with IEC/EN 61643-21: D1,C1,C2,C3
- Integrated PE foot, safely discharges up to 20 kA (8/20 μs) and 2.5 kA (10/350 μs) to PE



Technical data

Dielectric strength at FG against PE	≥ 500 V
Volume resistance	4.7 Ω
Overload - failure mode	Modus 2
Requirements category acc. to IEC 61643-21	C1, C2, C3, D1
Surge current-carrying capacity C1	< 1 kA 8/20 μs
Surge current-carrying capacity C2	5 kA 8/20 μs
Surge current-carrying capacity C3	100 A 10/1000 μs
Surge current-carrying capacity D1	2.5 kA 10/350 μs
Discharge current I _d (8/20 μs) wire-wire/wire-PE/GND-PE	2.5 kA / 2.5 kA / 2.5 kA
Discharge I _{max} (8/20 μs) wire-wire/wire-PE/GND-PE	10 kA / 10 kA / 10 kA
Lightning test I _{imp} (10/350 μs) wire-wire/wire-PE/GND-PE	2.5 kA / 2.5 kA / 2.5 kA
Type of connection	Pluggable in VSPC BASE
Storage temperature	-40 °C...80 °C
Ambient temperature (operational)	-40 °C...70 °C
Protection degree	IP20
UL 94 flammability rating	V-0
Temperature class T6/85 °C (-40 °C ... +60°C) li	250 mA
Temperature class T5/100°C (-40 °C ... +75°C) li	250 mA
Temperature class T4/135°C (-40°C ... +85°C) li	350 mA
Failure probability	
Ages	43
MTTF	2665
SIL in compliance with IEC 61508	2
Approvals	
Approvals	CCCEX; CE; CSAEX; FUSAFETY; IECEXDEK; KEMAATEX
Standards	IEC 61643-21, IEC 62305, DIN EN 60079-0:2009, DIN EN 60079-11:2007, DIN EN 60079-26:2007, DIN EN 61241-11:2006
ATEX - dust labelling	II 1 D Ex ia IIIC T135 °C ...T85 °C Da
ATEX - gas labelling	II 1 G Ex ia IIC T4... T6 Ga
IECEX - dust labelling	II 1 D Ex ia IIIC T135 °C ...T85 °C Da
IECEX - gas labelling	II 1 G Ex ia IIC T4... T6 Ga

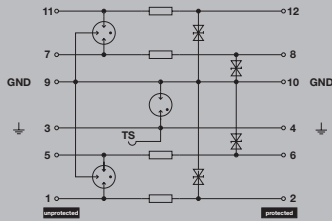

Complete module, indirect earthing

Dimensions	Dimensions
Height x width x depth	mm 90 / 17.8 / 69

Note The associated VSPC base element should be ordered with this. The dimension information provided refers to the complete module.

Base elements / base to arresters

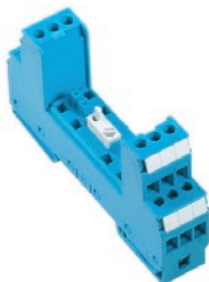

Ordering data for base

Description	Type	Qty.	Order No.
EX base element, indirect earthing / floating earth FG	VSPC BASE 4SL FG EX	1	8951840000

Note Technical data can be found at the beginning of VARITECTOR SPC EX.



VSPC 4SL EX - plug-in components / arrester



Pluggable component / Arrester



Base element / Base

Ordering data

	VSPC 4SL 12 V DC EX	VSPC 4SL 12 V AC EX	VSPC 4SL 24 V DC EX	VSPC 4SL 24 V AC EX
Rated voltage (AC)		12 V		24 V
Rated voltage (DC)	12 V	16 V	24 V	34 V
Rated current I_N	300 mA	300 mA	300 mA	300 mA
Optical function display	No	No	No	No
Input attenuation	1.2 MHz	2.5 MHz	4 MHz	2.7 MHz
Pulse-reset capacity	≤ 20 ms	≤ 20 ms	≤ 30 ms	≤ 30 ms
Residual voltage, U_R typical	< 200 V	250 V	250 V	250 V
EX protection data				
Input voltage, max. U_i	14 V	19 V	26 V	38 V
Internal capacity, max. C_i	< 4 nF	< 4 nF	< 4 nF	< 4 nF
Internal inductance, max. L_i	0 μ H	0 μ H	0 μ H	0 μ H
Input power, max. P_i	3 W	3 W	3 W	3 W
Protection level				
Protection level wire-wire 1kV/ μ s, type	45 V	55 V	80 V	110 V
Protection level wire-wire 8/20 μ s, type	45 V	55 V	80 V	80 V
Protection level wire-PE 1kV/ μ s, type	25 V	30 V	40 V	60 V
Protection level wire-PE 8/20 μ s, type	< 200 V	250 V	250 V	250 V
Ordering data				
Type	VSPC 4SL 12VDC EX	VSPC 4SL 12VAC EX	VSPC 4SL 24VDC EX	VSPC 4SL 24VAC EX
Order No.	1161170000	1161150000	1161190000	1161180000
Qty.	1	1	1	1
Note				



VARITECTOR SPC EX

VSPC 3/4 SL WIRE EX - protection for 3/4-wire signals in intrinsically safe areas

- Protection of measuring bridge signals in zones 0, 1 and 2
- Pluggable arrester (impedance-neutral plugging/unplugging without interruption)
- Can be tested with the V-TEST testing device
- Version with floating-earth PE connection for avoiding voltage potential differences
- Can be used in accordance with installation standard IEC 62305 and in ATEX applications
- Tested in accordance with IEC/EN 61643-21: D1, C1, C2, C3
- Integrated PE foot, safely discharges up to 20 kA (8/20 µs) and 2.5 kA (10/350 µs) to PE



C

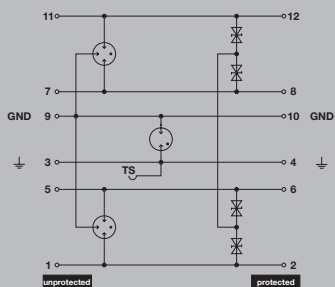

Complete module, indirect earthing

Technical data

Dielectric strength at FG against PE	≥ 500 V
Volume resistance	0.20 Ω
Overload - failure mode	Modus 2
Requirements category acc. to IEC 61643-21	C1, C2, C3, D1
Surge current-carrying capacity C1	< 1 kA 8/20 µs
Surge current-carrying capacity C2	5 kA 8/20 µs
Surge current-carrying capacity C3	100 A 10/1000 µs
Surge current-carrying capacity D1	2.5 kA 10/350 µs
Discharge current I ₁ (8/20 µs) wire-wire/wire-PE/GND-PE	2.5 kA / 2.5 kA / 2.5 kA
Discharge I _{max} (8/20 µs) wire-wire/wire-PE/GND-PE	10 kA / 10 kA / 10 kA
Lightning test I _{imp} (10/350 µs) wire-wire/wire-PE/GND-PE	2.5 kA / 2.5 kA / 2.5 kA
Type of connection	Pluggable in VSPC BASE
Storage temperature	-40 °C...80 °C
Ambient temperature (operational)	-40 °C...70 °C
Protection degree	IP20
UL 94 flammability rating	V-0
Temperature class T6/85 °C (-40 °C ... +60°C) li	250 mA
Temperature class T5/100°C (-40 °C ... +75°C) li	250 mA
Temperature class T4/135°C (-40°C ... +85°C) li	350 mA
Failure probability	
Ages	43
MTTF	2655
SIL in compliance with IEC 61508	3
Approvals	
Approvals	CCCEX; CE; CSAEX; FUSAFETY; IECEXDEK; KEMAATEX
Standards	IEC 61643-21, IEC 62305, DIN EN 60079-0:2009, DIN EN 60079-11:2007, DIN EN 60079-26:2007, DIN EN 61241-11:2006
ATEX - dust labelling	II 1 D Ex ia IIIC T135 °C ...T85 °C Da
ATEX - gas labelling	II 1 G Ex ia IIC T4... T6 Ga
IECEX - dust labelling	II 1 D Ex ia IIIC T135 °C ...T85 °C Da
IECEX - gas labelling	II 1 G Ex ia IIC T4... T6 Ga

Dimensions	Dimensions
Height x width x depth	mm 90 / 17.8 / 69

Note The associated VSPC base element should be ordered with this. The dimension information provided refers to the complete module.

Base elements / base to arresters

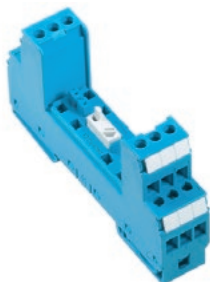

Ordering data for base

Description	Type	Qty.	Order No.
EX base element, indirect earthing / floating earth FG	VSPC BASE 2/4CH FG EX	1	8951850000

Note Technical data can be found at the end of VARITECTOR SPC EX.

VSPC 3/4SL WIRE EX- plug-in components / arrester



Pluggable component / Arrester



Base element / Base

Ordering data

Rated voltage (AC)
 Rated voltage (DC)
 Rated current I_N
 Optical function display
 Input attenuation
 Pulse-reset capacity
 Residual voltage, U_R typical

VSPC 3/4 WIRE 5 V DC EX

Rated voltage (AC)	3 V
Rated voltage (DC)	300 mA
Rated current I_N	No
Optical function display	750 KHz
Input attenuation	≤ 20 ms
Pulse-reset capacity	< 800 V
Residual voltage, U_R typical	

EX protection data

Input voltage, max. U_i
 Internal capacity, max. C_i
 Internal inductance, max. L_i
 Input power, max. P_i

Input voltage, max. U_i	6 V
Internal capacity, max. C_i	< 4 nF
Internal inductance, max. L_i	0 μ H
Input power, max. P_i	3 W

Protection level

Protection level wire-wire 1kV/ μ s, type
 Protection level wire-wire 8/20 μ s, type
 Protection level wire-PE 1kV/ μ s, type
 Protection level wire-PE 8/20 μ s, type

Protection level wire-wire 1kV/ μ s, type	35 V
Protection level wire-wire 8/20 μ s, type	35 V
Protection level wire-PE 1kV/ μ s, type	250 V
Protection level wire-PE 8/20 μ s, type	< 800 V

Ordering data

Type
 Order No.
 Qty.

VSPC 3/4WIRE 5VDC EX

8953650000

1

Note





VARITECTOR SPC EX

Indirect earthing

Base element, indirect earthing via spark gap FG, floating earth for ATEX applications.

VSPC BASE FG EX

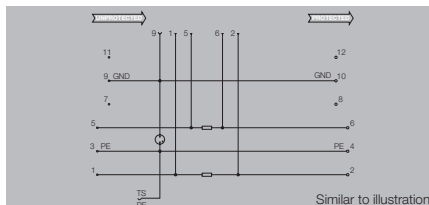

Technical data

Stripping length, rated connection
 Wire cross-section, stranded, min.
 Wire cross-section, stranded, max.
 Wire cross-section, solid, min.
 Wire cross-section, solid, max.
 Clamping range, min.
 Clamping range, max.
 Tightening torque, min.
 Tightening torque, max.
 Type of connection
 Approvals
 Ambient temperature (operational)
 Storage temperature
 UL 94 flammability rating
 Pollution degree
 Overvoltage category

7 mm
0.5 mm ²
2.5 mm ²
0.5 mm ²
4 mm ²
0.5 mm ²
4 mm ²
0.5 Nm
0.8 Nm
Screw connection
CCCEX; CE; CSAEX; IECXDEK; KEMAATEX
-40 °C...70 °C
-40 °C...80 °C
V-0
2
III

Dimensions	
Height x width	mm

90 / 17.8

Note

Ordering data

No remote sig. contact

Type	Qty.	Order No.
VSPC BASE 1CL FG EX	1	8951810000
VSPC BASE 2CL FG EX	1	8951820000
VSPC BASE 1CL PW FG EX	1	1070470000
VSPC BASE 2SL FG EX	1	8951830000
VSPC BASE 4SL FG EX	1	8951840000
VSPC BASE 2/4CH FG EX	1	8951850000

Note

Technical data can be found at the beginning of VARITECTOR SPC EX.

Accessories

Note

Marker: DEK 5



VARIRECTOR SSC EX



Lightning and surge protection for intrinsically safe circuits in the explosion hazard area

When used in intrinsically safe circuits within EX zones 2 to 0, the VARIRECTOR SSC can reliably protect measurement and control signals from lightning and surge voltages.

C Lightning and surge voltages – whether direct at the facilities, near field or far field – can cause signal interference or even destroy connected devices. They could even lead to an explosion within hazardous areas applications. The VARIRECTOR SSC EX product line, with a width of 12.4 mm, offers protection against these risks. These products comply with the new IEC 61643-21 standard. They fulfil the “over-stress mode” described. They are also in compliance with the most current ATEX Standard, in EN 60079.

Lightning and surge protection components are versatile and simple to use since they feature direct contact to the PE, many marking and diagnostic options, and an easily disconnected signal path. The VARIRECTOR SSC EX takes advantages of these features so that it can easily be used in place of a transfer terminal.



Fast identification

Versatile labelling: labels for equipment and individual connections, also easy to read SnapMark markers for any installation position.

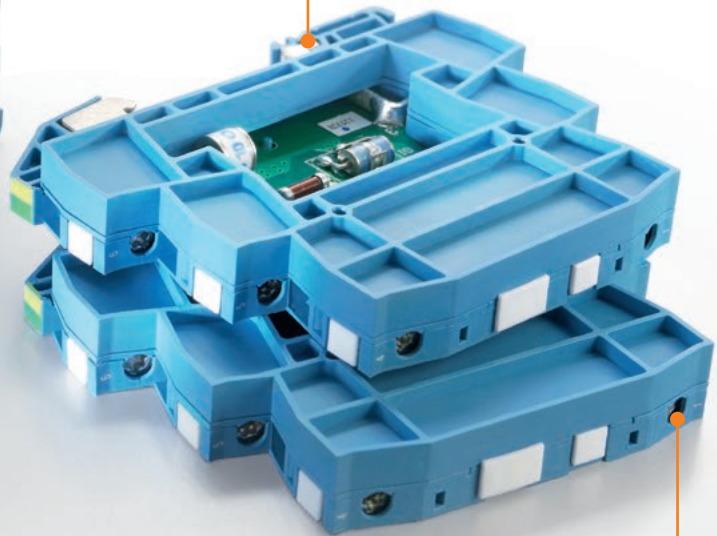
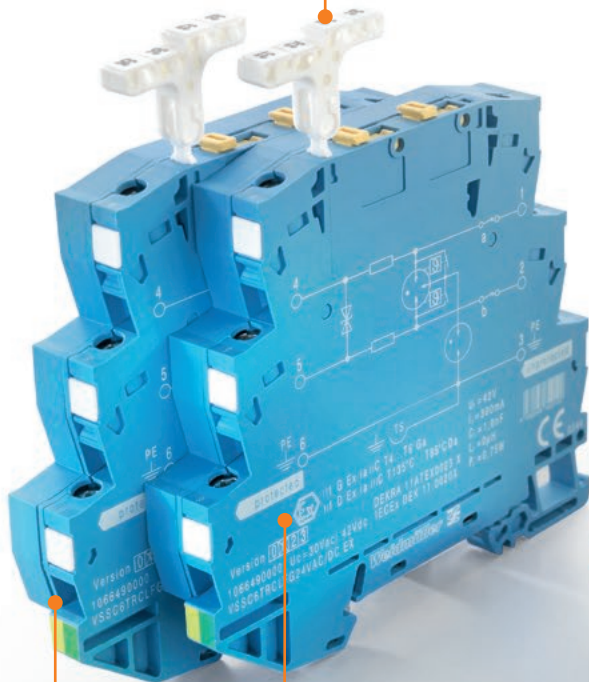
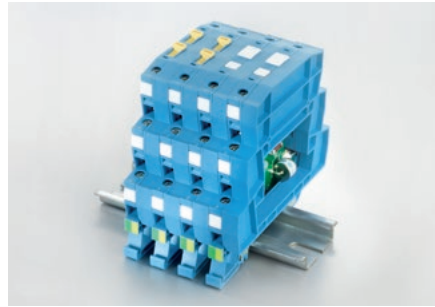

Complete, standard compliant protection

The VSSC EX prevents compensation currents via the PE. It also complies with the over stress mode of the IEC 61643-21 standard.



No limitations when used in the EX zone

The EX zone approval provides the proof that the VSSC EX can be used in all EX zones (from zone 2 to zone 0) for dust or gas.

No proof of intrinsic safety

Because of the negligible Li and Ci values, no special proof is required for EX zone use.



Space-saving

A compact installation is possible because of the VSSC EX module's terminal design and 12.4 mm alignment width.



VARIRECTOR SSC EX



VARIRECTOR SSC EX

12.4-mm-wide lightning and surge protection for measurement and control signals in the Ex zone

When used in intrinsically safe circuits within Ex zones 2 to 0, the VARIRECTOR SSC can reliably protect measurement and control signals from lightning and surge voltages. Lightning and surge voltages – coupled from the field side to machines and facilities – can cause signal interference or even destroy connected devices. They could even lead to an explosion within high-risk Ex-zone applications. The new VARIRECTOR SSC EX product line, with a width of 12.4 mm, offers protection against these risks. These products comply with the new IEC 61643-21:2008 standard. They fulfil the “over-stress mode” described. They also meet the latest ATEX standards, EN 60079. These lightning and surge components are a versatile and efficient solution because they feature a direct PE contact, extensive labelling and diagnostic options, and easy separation of the signal paths. The VARIRECTOR SSC EX takes advantage of these features so that it can easily be used in place of a transfer terminal.

Labelling of the VSSC EX equipment

ATEX:

For gas
II 1 G Ex ia IIC T4...T6
For dust
II 1 D Ex ia IIIC T135 °C...T85 °C
DEKRA 11ATEX0023X

IEX EX:

For gas
Ex ia IIC T4...T6 Ga
For dust
Ex ia IIIC T135 °C...T85 °C Da

Basic health and safety functions are fulfilled through compliance with: IEC 61643-21, EN 60079-0, EN 60079-1, EN 60079-26, EN 61241-11;

The VSSC series comes in a light blue housing and is used to protect electronics connected to intrinsically safe circuits. The VSSC has a negligible internal inductance and capacitance.

Products for intrinsically safe circuits

VSSC4 CL FG EX are used to protect an intrinsically safe current loop.

VSSC4 SL FG EX are used to protect intrinsically safe **binary signal circuits** (such as alarm contacts).

VSSC4 GDT 24Vuc 20kA EX can be used to provide high-resistance earthing for shields

VSSC6 TR CL 24Vuc EX are used to protect an intrinsically safe current loop. Measurements can be taken in the current loop by simply opening the isolator. A test plug can be inserted in the 2.3-mm test socket (built into the head of the Torx® screws).

VSSC6 RS485 PA EX is used to protect the intrinsically safe PROFIBUS-DP.

General technical data

Storage temperature: -40 °C...+80 °C
Operating temperature: -40 °C...70 °C
Humidity: 5 %...96 % RH without condensation

Material: V0, IP 20
Connection: VSSC4 and VSSC6
Torx® T15 900917
Slotted: 0.8 x 4 900834
Nominal torque: 0.5 Nm
Max. torque: 1 Nm
Stripping length: 10 mm
Solid core: 0.5...6 mm²
Finely stranded: 0.5...4 mm²
Finely stranded with ferrule: 0.5...4 mm²

Dimensions

VSSC4:

Width with frame: 12.4 mm
Height: 76 mm
Depth: 58.5 mm with TS 35 x 7.5
Top connections:
Unprotected: 1
Protected: 4
Bottom connections:
Unprotected: 2
Protected: 3

VSSC6:

Width with frame: 12,4 mm
Height: 88,5 mm
Depth: 81 mm mit TS 35 x 7,5
Top connections:
Unprotected: 1
Protected: 4
Mid-level connections:
Unprotected: 2
Protected: 5
Bottom connections:
Unprotected: 3
Protected: 6

Markers for VSSC4 and VSSC6:

Dekafix: DEK6 for the connections
WS10/6 middle for the device markers
SNAPMARK only for the VSSC6





C

VSSC 4 CL FG EX - protection for floating earth, intrinsically safe current loops

- 2-level surge protection with screw connection for intrinsically safe instrumentation and control signals
- Surge protection in terminal block design
- Width of only 12.4 mm
- Torx® for the connection
- Version with floating-earth PE connection used to avoid differences in voltage potential
- Can be used in accordance with installation standard IEC 62305 as well as in ATEX user standards
- Integrated PE foot, safely discharges up to 20 kA (8/20 μs) and 2.5 kA (10/350 μs) to PE



Technical data

Rated current I_N	300 mA
Volume resistance	1.8 n 10 %
Overload - failure mode	Modus 2
Requirements category acc. to IEC 61643-21	C2, C3, D1
Standards	IEC61643-21:2009, DIN EN 60079-0:2009, DIN EN 60079-26:2007, DIN EN 61241-11:2006, HART-compatible
Surge current-carrying capacity C1	
Surge current-carrying capacity C2	2.5 kA 8/20 μs 5 kV 1.2/50 μs
Surge current-carrying capacity C3	50 A 10/1000 μs
Surge current-carrying capacity D1	0.5 kA 10/350 μs
Discharge current I_t (8/20 μs) wire-wire/wire-PE/GND-PE	2.5 kA / 2.5 kA
Discharge I_{max} (8/20 μs) wire-wire/wire-PE/GND-PE	5 kA / 5 kA
Lightning test I_{imp} (10/350 μs) wire-wire/wire-PE/GND-PE	/ 0.5 kA
Storage temperature	-40 °C...80 °C
Ambient temperature (operational)	-40 °C...70 °C
Protection degree	IP20
UL 94 flammability rating	V-0
Connection data	
Type of connection	Screw connection
Tightening torque	0.5 Nm
Wire connection cross section, finely stranded, max.	4 mm ²
Wire connection cross-section, finely stranded, min.	0.5 mm ²
Wire cross-section, solid, max.	6 mm ²
Wire cross-section, solid, min.	0.5 mm ²
Wire cross-section, stranded, max.	4 mm ²
Wire cross-section, stranded, min.	0.5 mm ²
Stripping length	10 mm
Rail	TS 35
Failure probability	
λges	29
MTTF	3936
SIL in compliance with IEC 61508	3
Approvals	
Approvals	CE; CSAEX; DEKRAATEX; FUSAFETY; IECEXDEK
Standards	IEC61643-21:2009, DIN EN 60079-0:2009, DIN EN 60079-26:2007, DIN EN 61241-11:2006, HART-compatible

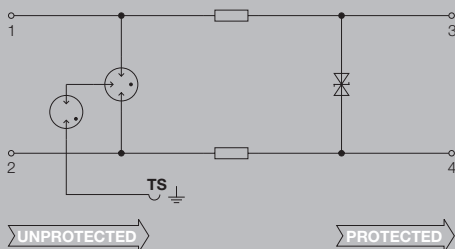

Dimensions	Dimensions
Height x width x depth	mm 76 / 12.4 / 58.5

Note ATEX approval: II 1 G EX ia IIC T4...T6 Ga II 1 D EX ia IIC T135°C...T85°C DEKRA N.º: 11ATEX0023 X



VSSC 4 CL FG EX

Ordering data

	VSSC4 CL FG 24 V UC EX	VSSC4 CL FG 48 V UC EX
Rated voltage (AC)	24 V	48 V
Rated voltage (DC)	34 V	68 V
Rated current I_N	300 mA	300 mA
Optical function display	No	No
Input attenuation	3.4 MHz	5 MHz
Pulse-reset capacity	≤ 15 ms	≤ 15 ms
Residual voltage, U_R typical	≤ 2000 V	≤ 2000 V
EX protection data		
Input voltage, max. U_i	42 V	55 V
Internal capacity, max. C_i	1 nF	1 nF
Internal inductance, max. L_i	0 μH	0 μH
Input power, max. P_i	0.75 W	0.75 W

Ordering data	VSSC4 CL FG 24VAC/DC EX	VSSC4 CL FG 48VAC/DC EX
Type	VSSC4 CL FG 24VAC/DC EX	VSSC4 CL FG 48VAC/DC EX
Order No.	1063810000	1063820000
Qty.	1	1
Note	End plate AP VSSC4 LB 1067240000	End plate AP VSSC4 LB 1067240000



VSSC 4 SL FG EX - protection for floating earth, binary, intrinsically safe signals

- 2-stage surge protection. Screw connection for intrinsically safe measurement, control & feedback control signals
- Terminal block design
- Modular width of only 12.4 mm
- Space-saving design: 1 binary floating ground signal
- Torx® for the connection
- Complies with installation standard IEC 62305 and ATEX applications
- Complies with IEC 61643-21: D1, C1, C2, C3
- Integrated PE foot, discharges up to 20 kA (8/20 μs) and 2.5 kA (10/350 μs) to PE

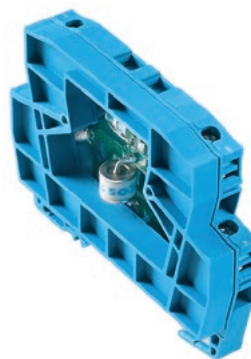

Technical data

Rated current I_N	300 mA
Volume resistance	1.8 Ω 10 %
Overload - failure mode	Modus 2
Requirements category acc. to IEC 61643-21	C2, C3, D1
Standards	IEC61643-21:2009, DIN EN 60079-0:2009, DIN EN 60079-26:2007, DIN EN 61241-11:2006
Surge current-carrying capacity C1	
Surge current-carrying capacity C2	2.5 kA 8/20 μs 5 kV 1.2/50 μs
Surge current-carrying capacity C3	10 A 10/1000 μs
Surge current-carrying capacity D1	1 kA 10/350 μs
Discharge current I_t (8/20 μs) wire-wire/wire-PE/GND-PE	/ 2.5 kA / 2.5 kA
Discharge I_{max} (8/20 μs) wire-wire/wire-PE/GND-PE	/ 10 kA / 10 kA
Lightning test I_{imp} (10/350 μs) wire-wire/wire-PE/GND-PE	/ 0.5 kA
Storage temperature	-40 °C...80 °C
Ambient temperature (operational)	-40 °C...70 °C
Protection degree	IP20
UL 94 flammability rating	V-0
Connection data	
Type of connection	Screw connection
Tightening torque	0.5 Nm
Wire connection cross section, finely stranded, max.	4 mm ²
Wire connection cross-section, finely stranded, min.	0.5 mm ²
Wire cross-section, solid, max.	6 mm ²
Wire cross-section, solid, min.	0.5 mm ²
Wire cross-section, stranded, max.	4 mm ²
Wire cross-section, stranded, min.	0.5 mm ²
Stripping length	10 mm
Rail	TS 35
Failure probability	
λges	43
MTTF	2655
SIL in compliance with IEC 61508	3
Approvals	
Approvals	CE; CSAEX; DEKRAATEX; FUSAFETY; IECEXDEK; OEVE
Standards	IEC61643-21:2009, DIN EN 60079-0:2009, DIN EN 60079-26:2007, DIN EN 61241-11:2006

Dimensions	Dimensions
Height x width x depth	mm 76 / 12.4 / 58.5

Note	ATEX approval: II 1 G EX ia IIC T4...T6 Ga II 1 D EX ia IIC T135°C...T85°C DEKRA N.º: 11ATEX0023 X
-------------	----------------------------------------------------------------------------------------------------

VSSC 4 SL FG EX

Ordering data

	VSSC4 SL FG 24 V UC EX	VSSC4 SL FG 48 V UC EX
Rated voltage (AC)	24 V	48 V
Rated voltage (DC)	34 V	68 V
Rated current I_N	300 mA	300 mA
Optical function display	No	No
Input attenuation	3.4 MHz	5.2 MHz
Pulse-reset capacity	≤ 35 ms	≤ 20 ms
Residual voltage, U_R typical	150 V	< 200 V
EX protection data		
Input voltage, max. U_i	42 V	55 V
Internal capacity, max. C_i	1 nF	1 nF
Internal inductance, max. L_i	0 μ H	0 μ H
Input power, max. P_i	0.75 W	0.75 W

Ordering data	VSSC4 SL FG 24VAC/DC EX	VSSC4 SL FG 48VAC/DC EX
Type	VSSC4 SL FG 24VAC/DC EX	VSSC4 SL FG 48VAC/DC EX
Order No.	1063930000	1063940000
Qty.	1	1
Note	End plate AP VSSC4 LB 1067240000	End plate AP VSSC4 LB 1067240000



VSSC 4 GDT EX - protection with sparkover gap (GDT)

- One-stage surge protection with screw connection for measurement and control signals
- Surge protection in terminal block design
- Modular width of only 12.4 mm
- Space-saving design for one signal
- Torx® slotted screw connection®
- Can be used in compliance with installation standard IEC 62305
- Tested in accordance with IEC 61643-21: C1, C2, C3
- Integrated PE foot, safely discharges up to 20 kA (8/20 µs) and 2.5 kA (10/350 µs) to PE



Technical data

Rated current I_N	300 mA
Volume resistance	<0.1 Ω
Overload - failure mode	Modus 2
Requirements category acc. to IEC 61643-21	C2, C3, D1
Standards	IEC61643-21:2009, DIN EN 60079-0:2009, DIN EN 60079-26:2007, DIN EN 61241-11:2006
Surge current-carrying capacity C1	
Surge current-carrying capacity C2	5 kA 8/20 µs
Surge current-carrying capacity C3	100 A 10/1000 µs
Surge current-carrying capacity D1	2.5 kA 10/350 µs
Discharge current I_t (8/20 µs) wire-wire/wire-PE/GND-PE	/ 5 kA
Discharge I_{max} (8/20 µs) wire-wire/wire-PE/GND-PE	/ 20 kA
Lightning test I_{imp} (10/350 µs) wire-wire/wire-PE/GND-PE	/
Storage temperature	-40 °C...80 °C
Ambient temperature (operational)	-40 °C...70 °C
Protection degree	IP20
UL 94 flammability rating	V-0
Connection data	
Type of connection	Screw connection
Tightening torque	0.5 Nm
Wire connection cross section, finely stranded, max.	4 mm ²
Wire connection cross-section, finely stranded, min.	0.5 mm ²
Wire cross-section, solid, max.	6 mm ²
Wire cross-section, solid, min.	0.5 mm ²
Wire cross-section, stranded, max.	4 mm ²
Wire cross-section, stranded, min.	0.5 mm ²
Stripping length	10 mm
Rail	TS 35
Failure probability	
λges	10
MTTF	11416
SIL in compliance with IEC 61508	3
Approvals	
Approvals	CCCEX; CE; CSAEX; DEKRAATEX; FUSAFETY; IECEXDEK
Standards	IEC61643-21:2009, DIN EN 60079-0:2009, DIN EN 60079-26:2007, DIN EN 61241-11:2006

Dimensions	Dimensions
Height x width x depth	mm 76 / 12.4 / 58.5

Note ATEX approval: II 1 G EX ia IIC T4...T6 Ga II 1 D EX ia IIC T135°C...T85°C DEKRA N.º: 11ATEX0023 X

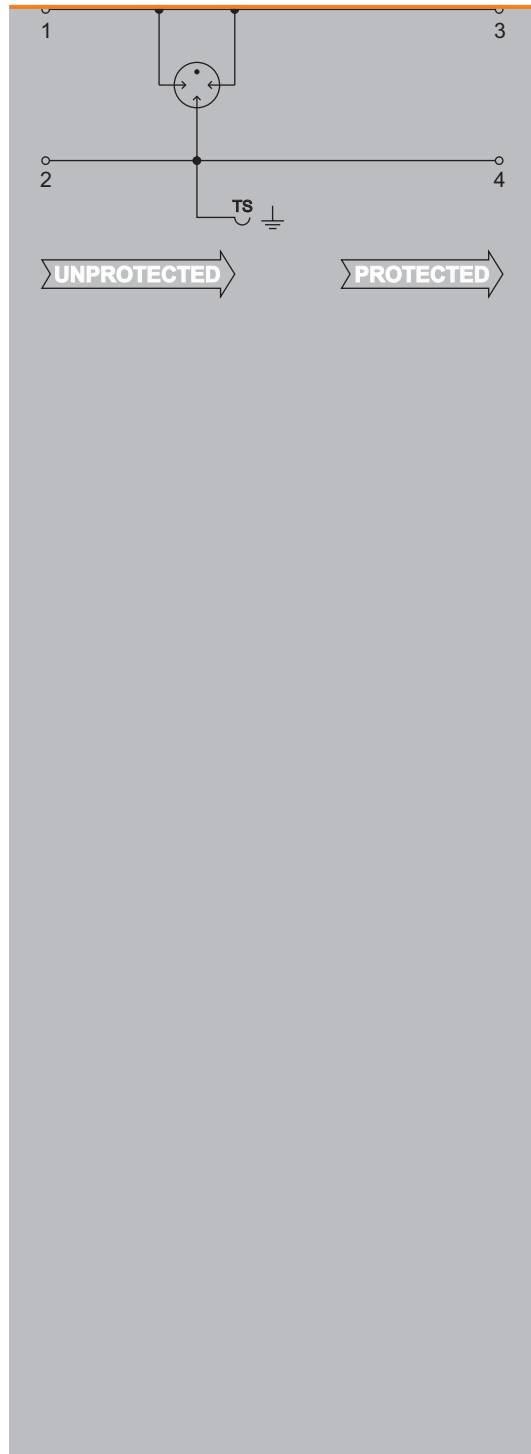

VSSC 4 GDT EX

Ordering data

Ordering data	VSSC4 GDT 55 V UC 20 kA EX
Rated voltage (AC)	55 V
Rated voltage (DC)	80 V
Rated current I_n	300 mA
Optical function display	No
Capacitance	4.65 pF
Residual voltage, U_p , typical	≤ 1900 V
EX protection data	
Input voltage, max. U_i	55 V
Internal capacity, max. C_i	0 nF
Internal inductance, max. L_i	0 μ H
Input power, max. P_i	0.75 W

Ordering data	
Type	VSSC4 GDT55VUC 20KA EX
Order No.	1064040000
Qty.	1
Note	End plate AP VSSC4 LB 1067240000

C



VSSC 6 TR FG EX - protection for floating, intrinsically safe current loops with isolator function

- 2-level surge protection with screw connection for intrinsically safe instrumentation and control signals
- Surge protection in terminal block design
- Alignment width of only 12.4 mm
- Signals can be separated for measurement
- For use in zones 2, 1, and 0
- Torx screw® for the connection
- Can be used in compliance with installation standard IEC 62305
- Tested according to IEC 61643-21: D1, C2, C3
- Integrated PE foot, safely discharges up to 20 kA (8/20 μs) and 2.5 kA (10/350 μs) to PE

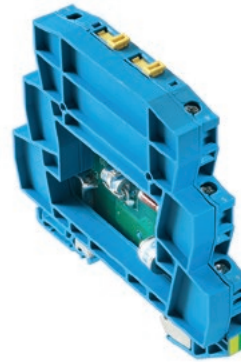

Technical data

Rated current I_N	300 mA
Volume resistance	1.8 n 10 %
Overload - failure mode	Modus 2
Requirements category acc. to IEC 61643-21	C2, C3, D1
Standards	IEC61643-21:2009, DIN EN 60079-0:2009, DIN EN 60079-26:2007, DIN EN 61241-11:2006, HART-compatible

Surge current-carrying capacity C1	
Surge current-carrying capacity C2	2.5 kA 8/20 μs 5 kV 1.2/50 μs
Surge current-carrying capacity C3	50 A 10/1000 μs
Surge current-carrying capacity D1	0.5 kA 10/350 μs
Discharge current I_t (8/20 μs) wire-wire/wire-PE/GND-PE	2.5 kA / 2.5 kA
Discharge I_{max} (8/20 μs) wire-wire/wire-PE/GND-PE	5 kA / 5 kA
Lightning test I_{imp} (10/350 μs) wire-wire/wire-PE/GND-PE	/ 0.5 kA
Storage temperature	-40 °C...80 °C
Ambient temperature (operational)	-40 °C...70
Protection degree	IP20
UL 94 flammability rating	V-0

Connection data	
Type of connection	Screw connection
Tightening torque	0.5 Nm
Wire connection cross section, finely stranded, max.	4 mm ²
Wire connection cross-section, finely stranded, min.	0.5 mm ²
Wire cross-section, solid, max.	6 mm ²
Wire cross-section, solid, min.	0.5 mm ²
Wire cross-section, stranded, max.	4 mm ²
Wire cross-section, stranded, min.	0.5 mm ²
Stripping length	10 mm
Rail	TS 35

Failure probability	
λges	29
MTTF	3936
SIL in compliance with IEC 61508	3

Approvals	
Approvals	CE; CSAEX; DEKRAATEX; FUSAFETY; IECEXDEK
Standards	IEC61643-21:2009, DIN EN 60079-0:2009, DIN EN 60079-26:2007, DIN EN 61241-11:2006, HART-compatible

Dimensions	Dimensions
Height x width x depth	mm 88.5 / 12.4 / 81

Note ATEX approval: II 1 G EX ia IIC T4...T6 Ga II 1 D EX ia IIC T135°C...T85°C DEKRA N.º: 11ATEX0023 X

Lightning and surge protection for instrumentation and control (I & C)

C

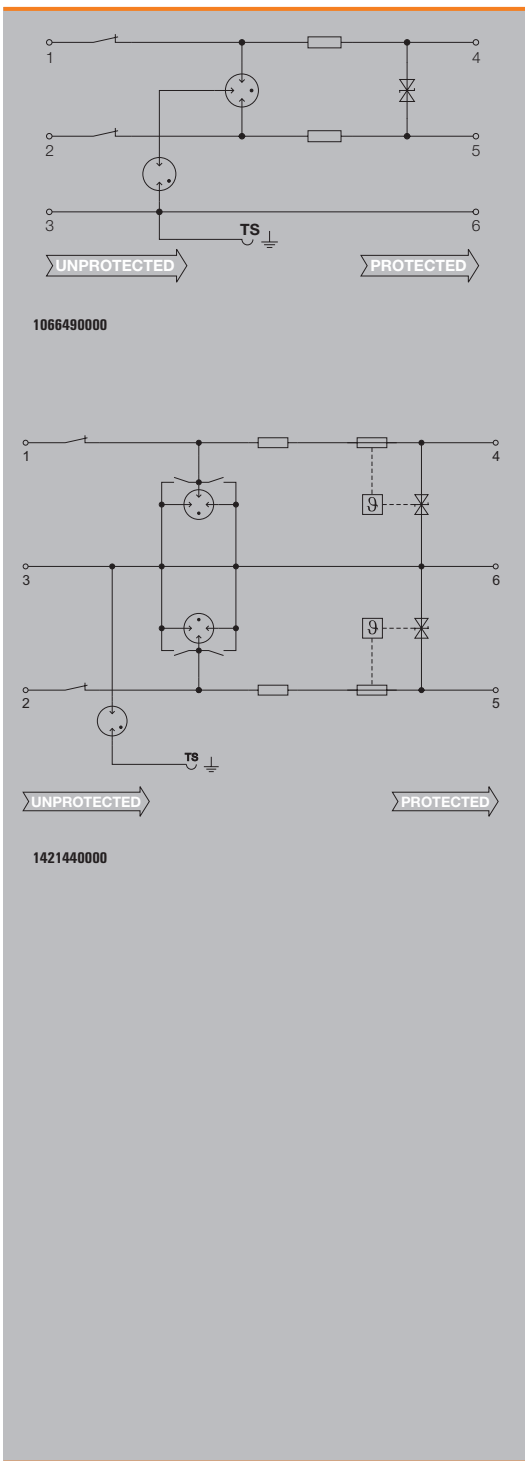

VSSC 6 TR FG EX

Lightning and surge protection for instrumentation and control (I & C)

Ordering data

Rated voltage (AC)
 Rated voltage (DC)
 Rated current I_N
 Optical function display
 Input attenuation
 Pulse-reset capacity
 Residual voltage, U_R typical

VSSC6 TR CLFG 24 V UC EX

24 V
 34 V
 300 mA
 No
 270 Mhz
 ≤ 20 ms
 ≤ 1870 V

VSSC6 TR SLFG 24 V DC EX

24 V
 34 V
 300 mA
 No
 270 Mhz
 ≤ 20 ms
 ≤ 1870 V

EX protection data

Input voltage, max. U_i
 Internal capacity, max. C_i
 Internal inductance, max. L_i
 Input power, max. P_i

42 V
 2 nF
 0 μ H
 0.75 W

42 V
 2 nF
 0 μ H
 0.75 W

Ordering data

Type
 Order No.
 Qty.

VSSC6TRCLFG24VAC/DC EX
1066490000
 1

VSSC6 TR SL FG 24VAC/DC EX
1421440000
 1

Note

End plate AP VSSC LB 1067230000

End plate AP VSSC LB 1067230000



VSSC 6 RS485 PROFIBUS PA - protection for RS422/485 intrinsically safe signal interfaces

- Two-stage surge protection with screw connection for PROFIBUS PA RS422/485 data interfaces
- Surge protection in terminal block design
- Modular width of only 6.2 mm
- For use in zones 2, 1, and 0
- Space-saving design: 1 signal
- Torx® slotted screw connection®
- Can be used in compliance with installation standard IEC 62305
- Tested in accordance with IEC 61643-21: D1, C2, C3
- Integrated PE foot, safely discharges up to 20 kA (8/20 µs) and 2.5 kA (10/350 µs) to PE

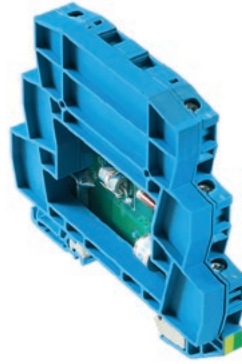

Technical data

Dielectric strength at FG against PE	≥ 500 V
Volume resistance	1.8 Ω 10 %
Overload - failure mode	Modus 2
Requirements category acc. to IEC 61643-21	C2, C3, D1
Surge current-carrying capacity C1	
Surge current-carrying capacity C2	2.5 kA 8/20 µs 5 kV 1.2/50 µs
Surge current-carrying capacity C3	10 A 10/1000 µs
Surge current-carrying capacity D1	0.5 kA 10/350 µs
Discharge current I _d (8/20 µs) wire-wire/wire-PE/GND-PE	2.5 kA / 2.5 kA
Discharge I _{max} (8/20 µs) wire-wire/wire-PE/GND-PE	5 kA / 5 kA
Lightning test I _{imp} (10/350 µs) wire-wire/wire-PE/GND-PE	/ 0.5 kA
Type of connection	Screw connection
Storage temperature	-40 °C...80 °C
Ambient temperature (operational)	-40 °C...70
Protection degree	IP20
UL 94 flammability rating	V-0

Connection data	
Type of connection	Screw connection
Tightening torque	0.5 Nm
Wire connection cross section, finely stranded, max.	4 mm ²
Wire connection cross-section, finely stranded, min.	0.5 mm ²
Wire cross-section, solid, max.	6 mm ²
Wire cross-section, solid, min.	0.5 mm ²
Wire cross-section, stranded, max.	4 mm ²
Wire cross-section, stranded, min.	0.5 mm ²
Stripping length	10 mm
Rail	TS 35

Failure probability	
λges	29
MTTF	3936
SIL in compliance with IEC 61508	3

Approvals	
Approvals	CE; CSAEX; DEKRAATEX; FUSAFETY; IECXDEK
Standards	IEC61643-21:2009, DIN EN 60079-0:2009, DIN EN 60079-26:2007, DIN EN 61241-11:2006
ATEX - dust labelling	II 1 D Ex ia IIC T135 °C ...T85 °C Da
ATEX - gas labelling	II 1 G Ex ia IIC T4... T6 Ga
IECEX - dust labelling	II 1 D Ex ia IIC T135 °C ...T85 °C Da
IECEX - gas labelling	II 1 G Ex ia IIC T4... T6 Ga

Dimensions	
Height x width x depth	mm 88.5 / 12.4 / 81

Note ATEX approval: II 1 G EX ia IIC T4... T6 Ga II 1 D EX ia IIC T135°C...T85°C DEKRA N.º: 11ATEX0023 X

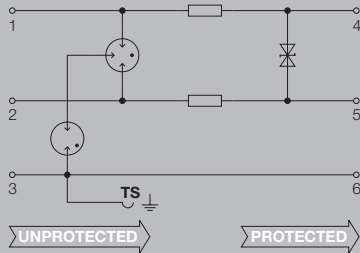

VSSC 6 RS485 PROFIBUS PA

Ordering data

VSSC6 RS485 PA EX

Rated voltage (AC)	
Rated voltage (DC)	12 V
Rated current I_N	300 mA
Optical function display	No
Input attenuation	113.6 MHz
Pulse-reset capacity	≤ 15 ms
Residual voltage, U_R typical	≤ 2 kV
EX protection data	
Input voltage, max. U_i	35 V
Internal capacity, max. C_i	1 nF
Internal inductance, max. L_i	0 μH
Input power, max. P_i	0.75 W

Ordering data	
Type	VSSC6 RS485 PA EX
Order No.	1065020000
Qty.	1
Note	End plate AP VSSC LB 1067230000



VSSC 6 RTD EX - protection for intrinsically safe PT100 signal interfaces

- Two-stage surge protection with screw connection for intrinsically safe PT100/PT1000 signals
- Surge protection in terminal block design
- Modular width of only 12.4 mm
- Torx® slotted screw connection
- Can be used in compliance with installation standard IEC 62305
- Tested in accordance with IEC 61643-21: D1, C2, C3
- Integrated PE foot, safely discharges up to 20 kA (8/20 μs) and 2.5 kA (10/350 μs) to PE

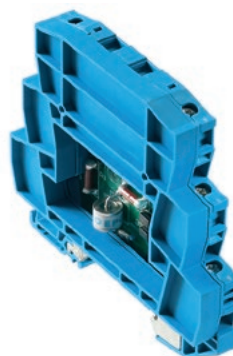

Technical data

Dielectric strength at FG against PE	≥ 500 V
Volume resistance	1.8 Ω 10 %
Overload - failure mode	Modus 2
Requirements category acc. to IEC 61643-21	C2, D1
Surge current-carrying capacity C1	
Surge current-carrying capacity C2	2.5 kA 8/20 μs 5 kV 1.2/50 μs
Surge current-carrying capacity C3	10 A 10/1000 μs
Surge current-carrying capacity D1	0.5 kA 10/350 μs
Discharge current I _d (8/20 μs) wire-wire/wire-PE/GND-PE	2.5 kA / 2.5 kA
Discharge I _{max} (8/20 μs) wire-wire/wire-PE/GND-PE	5 kA / 5 kA
Lightning test I _{imp} (10/350 μs) wire-wire/wire-PE/GND-PE	/ 0.5 kA
Type of connection	Screw connection
Storage temperature	-40 °C...80 °C
Ambient temperature (operational)	-40 °C...70
Protection degree	IP20
UL 94 flammability rating	V-0

Connection data

Type of connection	Screw connection
Tightening torque	
Wire connection cross section, finely stranded, max.	4 mm ²
Wire connection cross-section, finely stranded, min.	0.5 mm ²
Wire cross-section, solid, max.	6 mm ²
Wire cross-section, solid, min.	0.5 mm ²
Wire cross-section, stranded, max.	4 mm ²
Wire cross-section, stranded, min.	0.5 mm ²
Stripping length	
Rail	TS 35

Failure probability

λges	61
MTTF	1871
SIL in compliance with IEC 61508	3

Approvals

Approvals	CE; CSAEX; DEKRAATEX; FUSAFETY; IECEXDEK
Standards	IEC61643-21:2009, DIN EN 60079-0:2009, DIN EN 60079-26:2007, DIN EN 61241-11:2006
ATEX - dust labelling	II 1 D Ex ia IIC T135 °C ...T85 °C Da
ATEX - gas labelling	II 1 G Ex ia IIC T4... T6 Ga
IECEX - dust labelling	II 1 D Ex ia IIC T135 °C ...T85 °C Da
IECEX - gas labelling	II 1 G Ex ia IIC T4... T6 Ga

Dimensions

Height x width x depth	mm	88.5 / 12.4 / 81
------------------------	----	------------------

Note ATEX approval: II 1 G EX ia IIC T4... T6 Ga II 1 D EX ia IIC T135°C...T85°C DEKRA No: 11ATEX0023 X

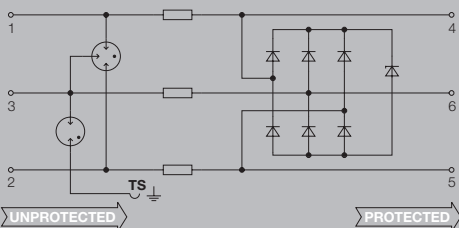

VSSC 6 RTD EX

Ordering data

Rated voltage (AC)
 Rated voltage (DC)
 Rated current I_N
 Optical function display
 Input attenuation
 Pulse-reset capacity
 Residual voltage, U_R typical

VSSC6 RTD EX

1 V

300 mA

No

120 Mhz

 ≤ 10 ms ≤ 1.8 kV

EX protection data

Input voltage, max. U_i
 Internal capacity, max. C_i
 Internal inductance, max. L_i
 Input power, max. P_i

5 V

7 nF

0 μ H

0.75 W

Ordering data

Type
 Order No.
 Qty.

VSSC6 RTD EX

1130670000

1

Note

End plate AP VSSC LB 1067230000

C





VARITECTOR Cable Gland (VCG)

VARITECTOR Cable Gland (VCG) protect intrinsically safe circuits in IP67 applications

- Tested in accordance with IEC/EN 61643-21
- Suitable for use in EX areas
- High protection class with IP67
- Screw-in housing with different threads

VCG 24 V EX 2



VCG 24 V EX 4

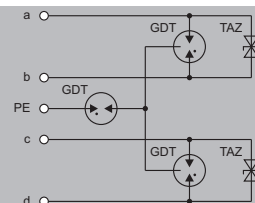
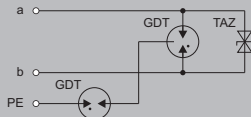

Technical data

Input voltage, max. U_i
Rated voltage (DC)
Rated voltage (DC), max.
Frequency range
Insertion loss
Requirements category acc. to IEC 61643-21
Lightning test current, I_{imp} (10/350 μ s) wire-wire
Lightning test current, I_{imp} (10/350 μ s) Wire-PE
Discharge I_{max} (8/20 μ s) wire-wire/wire-PE/GND-PE
Discharge current I_n (8/20 μ s) wire-wire
Discharge current I_{max} (8/20 μ s) wire-PE
Discharge current I_n (8/20 μ s) wire-PE
Response time
Protection level U_p (typ.)
Protection level, U_p wire - wire
Protection level, U_p wire - PE
Dielectric strength at FG against PE
ATEX - gas labelling
ATEX - dust labelling
Input power, max. P_i
Input voltage, max. U_i
Input current, max. I_i
Internal inductance, max. L_i
Internal capacity, max. C_i
Protection degree
Version
Design
Ambient temperature (operational)

50 V
24 V
33 V
0...30 MHz
30 MHz
D1, C1, C2, C3
1 kA
1 kA
10 kA
5 kA
10 kA
5 kA
< 1 ns
< 1300 V
44 V
864 V
≥ 500 V
18ATEX0141X, II 1GD, Ex ia II T6 Ga, (-30 °C \leq Ta \leq 50 °C)
IEC Ex BAS 18.0085X, Ex ia IIIC T85 °C Da, (-30 °C \leq Ta \leq 50 °C)
2 W
50 V
0.8 A
60 μ H
0 nF
IP67
Stainless steel screw mounting housing
straight, 1/2" NPT
-30 °C...60 °C

50 V
24 V
33 V
0...30 MHz
30 MHz
D1, C1, C2, C3
2 kA
2 kA
20 kA
10 kA
20 kA
10 kA
< 1 ns
< 1300 V
44 V
864 V
≥ 500 V
18ATEX0141X, II 1GD, Ex ia II T6 Ga, (-30 °C \leq Ta \leq 50 °C)
IEC Ex BAS 18.0085X, Ex ia IIIC T85 °C Da, (-30 °C \leq Ta \leq 50 °C)
2 W
50 V
0.8 A
60 μ H
0 nF
IP67
Stainless steel screw mounting housing
straight, 1/2" NPT
-30 °C...60 °C

Approvals

Approvals
Standards

BASATEX; CCCEX; CE; IECEXBAS
IEC 61643-21, IEC 60079-0, IEC 60079-11

BASATEX; CCCEX; CE; IECEXBAS
IEC 61643-21, IEC 60079-0, IEC 60079-11

Dimensions

Wire connection method / Cross-section
Length

Cable length: 250 mm (min.) / 1 mm ²
78 / 24 mm

Cable length: 250 mm (min.) / 1 mm ²
120 / 24 mm

Note

Ordering data

Type
Qty.
Order No.

VCG 24V EX 2 NPT1/2	1	2593120000
VCG 24V EX 2 M20X1.5	1	2593140000
VCG 24V EX 2 G 1/2	1	2593160000

Type
Qty.
Order No.

VCG 24V EX 4 NPT1/2	1	2593130000
VCG 24V EX 4 M20X1.5	1	2593150000
VCG 24V EX 4 G 1/2	1	2593170000

Note

Accessories

Note

Note

Note



C

Approval – VSPC-ATEX



CERTIFICATE

(1) **EU-Type Examination**

(2) **Equipment or protective systems intended for use in potentially explosive atmospheres - Directive 2014/54/EU**

(3) EU-Type Examination Certificate Number: **KEMA 10ATEX0148 X** Issue Number: **5**

(4) Product: **Surge Voltage Protection Unit, Type VSPC ... Ex**

(5) Manufacturer: **Weidmüller Interface GmbH & Co. KG**

(6) Address: **Klingenbergstraße 16, 32788 Detmold, Germany**

(7) This product and any acceptable variation thereto is specified in the **schedule** to this certificate and the documents therein referred to.

(8) DEKRA Certification B.V., Notified Body number 0344 in accordance with Article 17 of Directive 2014/54/EU of the European Parliament and of the Council, dated 26 February 2014, certifies that this product has been found to comply with the Essential Health and Safety Requirements relating to the design and construction of products intended for use in potentially explosive atmospheres given in Annex II to the Directive.

The examination and test results are recorded in confidential test report number **NL/DEK/EXTR11.0099/04**.

(9) Compliance with the Essential Health and Safety Requirements has been assured by compliance with:

EN 60079-0 : 2012+ A11 : 2013 EN 60079-11 : 2012

except in respect of those requirements listed at item 18 of the Schedule.

(10) If the sign "X" is placed after the certificate number, it indicates that the product is subject to the Specific Conditions of Use specified in the schedule to this certificate.

(11) This EU-Type Examination Certificate relates only to the design and construction of the specified product. Further requirements of the Directive apply to the manufacturing process and supply of this product. These are not covered by this certificate.

(12) The marking of the product shall include the following:

**II 1 G Ex ia IIC T4 ... T6 Ga or
II 1 D Ex ia IIC T135 °C ... T85 °C Da**

Date of certification: 1 April 2020
DEKRA Certification B.V.

R. Schuller
Certification Manager

Page 1/4

Integral publication of this certificate and adjoining reports is allowed. This Certificate may only be reproduced in its entirety and without any change.

DEKRA Certification B.V., Meander 1051, 6825 MJ Arnhem, P.O. Box 5165, 6802 ED Arnhem, The Netherlands
T +31 88 98 83000, F +31 88 98 83100, www.dekra-product-safety.com, Registered Arnhem 09085396

(13) **SCHEDULE**

(14) **to EU-Type Examination Certificate KEMA 10ATEX0148 X** Issue No. **5**

(15) **Description**

The Surge Voltage Protection Unit of Series VSPC ... Ex serves to limit eventual surge voltages in intrinsically safe circuits.

The Units consist out of a Base Module for rail mounting and a pluggable protection Module provided with a (for each Base Module type) unique mechanical key.

The Plug-in unit Type VSPC 1CL PW 24Vac EX also contains a LED error-indication.

Several units for different intrinsically safe circuits may be mounted next to each other.

Electrical data

Input circuit (Terminals 1, 5, 7 and 11):
in type of protection intrinsic safety Ex ia IIC or Ex ia IIIC, only for connection to a certified intrinsically safe circuit, with the following maximum values:
L_i = 0 µH; C_i = 25 nF (for Type VSPC 1CL PW 24VAC EX); C_i = 4 nF (for the other Types).

The values of U_i for the different types of pluggable modules are listed in the following table:

Pluggable protection Module Types	U _i
VSPC ... 5VDC EX	6 V
VSPC ... 12VDC EX	14 V
VSPC ... 12VAC EX	19 V
VSPC ... 24VDC EX	26 V
VSPC 1CL PW 24VAC EX	27 V
VSPC ... 24VAC EX	38 V
VSPC ... 48VAC EX	75 V

Page 2/4
Form 227A
Version 2 (2019-06)

(13) **SCHEDULE**

(14) **to EU-Type Examination Certificate KEMA 10ATEX0148 X** Issue No. **5**

The temperature class / maximum surface temperature of the Base modules, depending on I and the ambient temperature range is listed in the following table:

Base Module Type	I	Ambient temperature range	Temperature class / Maximum surface temperature
VSPC BASE 4SL FG EX	250 mA	-40 °C to +60 °C	T6 / T85 °C
VSPC BASE 2CL FG EX			
VSPC BASE 1CL PW FG EX	250 mA	-40 °C to +75 °C	T5 / T100 °C
VSPC BASE 1CL FG EX			
VSPC BASE 2SL FG EX	350 mA	-40 °C to +85 °C	T4 / T135 °C
VSPC BASE 2CH FG EX			
VSPC BASE 2CH FG EX	3,3 A	-40 °C to +60 °C	T6 / T85 °C
		-40 °C to +75 °C	T5 / T100 °C
		-40 °C to +85 °C	T4 / T135 °C

Output circuits (Terminals 2, 6, 8 and 12):
in type of protection intrinsic safety Ex ia IIC or Ex ia IIIC. The output parameters are equal to the output parameters of the external intrinsically safe circuits connected to the input circuit. For the determination of the maximum allowed external capacitance (C_e) and inductance (L_e), the values of the internal capacitance (C_i) and inductance (L_i) shall be taken into account.

Installation instructions

The instructions provided with the product shall be followed in detail to assure safe operation.

(15) **Report Number**

No. NL/DEK/EXTR11.0099/04.

(17) **Specific conditions of use**

For application in explosive dust atmospheres:
The Surge Voltage Protection Units shall be installed in an enclosure, which providing a degree of protection of at least IP6X in accordance with EN 60529. The maximum surface temperature of the enclosure is specified in the description (15).

Measures shall be taken to avoid the danger of ignition due to electrostatic charges.

(18) **Essential Health and Safety Requirements**

Covered by the standards listed at (9).

(19) **Test documentation**

As listed in Test Report No. NL/DEK/EXTR11.0099/04.

Page 3/4
Form 227A
Version 2 (2019-06)

Approval – VSSC-ATEX



CERTIFICATE

(1) EC-Type Examination

(2) Equipment and protective systems intended for use in potentially explosive atmospheres – Directive 94/9/EC

(3) EC-Type Examination Certificate Number: DEKRA 11ATEX0023 X Issue Number: 2

(4) Equipment: Surge Voltage Protection Unit, Series VSSC ... Ex

(5) Manufacturer: Weidmüller Interface GmbH & Co. KG

(6) Address: Klingenbergstraße 16, 32758 Detmold, Germany

(7) This equipment and any acceptable variation thereto is specified in the schedule to this certificate and the documents therein referred to.

(8) DEKRA Certification B.V., notified body number 0344 in accordance with Article 9 of the Council Directive 94/9/EC of 23 March 1994, certifies that this equipment has been found to comply with the Essential Health and Safety Requirements relating to the design and construction of equipment and protective systems intended for use in potentially explosive atmospheres given in Annex II to the directive.

The examination and test results are recorded in confidential test report No. NU/DEK/ExTR11.0016**

(9) Compliance with the Essential Health and Safety Requirements has been assessed by compliance with

EN 60079-0 : 2012 EN 60079-11 : 2012 EN 60079-26 : 2007

(10) If the sign "X" is placed after the certificate number, it indicates that the equipment is subject to special conditions for safe use specified in the schedule to this certificate.

(11) This EC-Type Examination Certificate relates only to the design, examination and tests of the specified equipment, without according to the Directive 94/9/EC. Further requirements of the directive apply to the manufacturing process and supply of this equipment. These are not covered by this certificate.

(12) The marking of the equipment shall include the following:



II 1 G Ex ia IIC T4 ... T6 Ga
or
II 1 D Ex ia IIC T135 °C ... T85 °C Da

This certificate is issued on 20 August 2013 and, as far as applicable, shall be revised before the date of cessation of presumption of conformity of (one of) the standards mentioned above as communicated in the Official Journal of the European Union.

DEKRA Certification B.V.

Certification Manager

Page 1/3

Page 1 Release of this certificate to the holding room is allowed. The Certificate may only be reprinted in its entirety and without any change.

DEKRA Certification B.V., Meander 1051, 6825 MJ Arnhem, P.O. Box 5185, 6802 ED Arnhem, The Netherlands
T +31 88 96 83000 F +31 88 96 83100 www.dekra-certification.com Registered Arnhem 09085396



(13) SCHEDULE

(14) to EC-Type Examination Certificate DEKRA 11ATEX0023 X Issue No. 2

(15) Description

The Surge Voltage Protection Unit of Series VSSC ... Ex serves to limit any surge voltages in intrinsically safe circuits.

The earth connection can be made via the mounting foot to a normalized metal mounting rail and via a terminal.

Several units for different intrinsically safe circuits may be mounted next to each other.

Ambient temperature range: -40 °C to +70 °C (T6 / T85 °C),
-40 °C to +85 °C (T5 / T100 °C),
-40 °C to +120 °C (T4 / T135 °C)

Electrical data

Input circuit (Terminals 1, 2):
in type of protection intrinsic safety Ex ia IIC or Ex ia IIC, only for connection to a certified intrinsically safe circuit, with the following maximum values:
I_n = 300 mA, P = 0,75 W, L = 0 µH
The values of U and C, for the different types are listed in the following table:

Type	U	C
VSSC4 CL FG 24VAC/DC EX	42 V	1 nF
VSSC4 CL FG 48VAC/DC EX	55 V	1 nF
VSSC4 SL FG 24VAC/DC EX	42 V	1 nF
VSSC4 SL FG 48VAC/DC EX	55 V	1 nF
VSSC4 GDT 55Vdc 20kA EX	55 V	0 nF
VSSC6 TR CL FG 24VAC/DC EX	42 V	1 nF
VSSC6 RS485 PA EX	35 V	1 nF
VSSC6 RTD EX	5 V	7 nF
VSSC6 TR SL FG 24VAC/DC EX	42 V	2 nF

Output circuit (Terminals 3, 4):
in type of protection intrinsic safety Ex ia IIC or Ex ia IIC. The output parameters are equal to the output parameters of the external intrinsically safe circuit connected to the input circuit.
For the determination of the maximum allowed external capacitance (C_{ext}) and inductance (L_{ext}), the values of the internal capacitance (C) and inductance (L) shall be taken into account.

Installation instructions

The instructions provided with the equipment shall be followed in detail to assure safe operation.

(16) Test Report

No. NU/DEK/ExTR11.0016**

Page 2/3
Form 101
Version 5 (2013-07)



(13) SCHEDULE

(14) to EC-Type Examination Certificate DEKRA 11ATEX0023 X Issue No. 2

(17) Special conditions for safe use

The intrinsic safe signal of Surge Voltage Protection Unit, Type VSSC4 GDT 55Vdc 20kA EX, is directly connected to earth.

For ambient temperature range, see (15).

(18) Essential Health and Safety Requirements

Covered by the standards listed at (9).

(19) Test documentation

As listed in Test Report No. NU/DEK/ExTR11.0016**

Page 3/3
Form 101
Version 5 (2013-07)



Approval – VSSC-IEC Ex

IECEX Certificate of Conformity

INTERNATIONAL ELECTROTECHNICAL COMMISSION
IEC Certification Scheme for Explosive Atmospheres
for rules and details of the IECEx Scheme visit www.iecex.com

Certificate No: **IECEX DEK 11 0020X** Issue No.: 1

Status: **Current**

Date of Issue: **2013-08-20** Page 1 of 4

Applicant: **Weidmüller Interface GmbH & Co. KG**
Klingerbergstraße 16, 32758 Detmold
Germany

Electrical Apparatus: **Surge Voltage Protection Unit, Series VSSC ... Ex**
Optional accessory:

Type of Protection: **Ex ia**

Marking: **Ex ia IIC T4 ... T8 Ga or Ex ia IIC T135 °C ... T85 °C Da**

Approved for issue on behalf of the IECEx: **R. Schüller**
Certification Body: **Certification Manager**

Signature (for printed version):
Date: **2013-08-20**

1. This certificate and schedule may only be reproduced in full.
2. This certificate is not transferable and remains the property of the issuing body.
3. The status and authenticity of this certificate may be verified by visiting the Official IECEx Website.

Certificate issued by:

DEKRA Certification B.V.
Meander 1051,
6825 MJ Arnhem
The Netherlands

IECEX Certificate of Conformity

Certificate No: **IECEX DEK 11 0020X** Issue No.: 1

Date of Issue: **2013-08-20** Page 2 of 4

Manufacturer: **Weidmüller Interface GmbH & Co. KG**
Klingerbergstraße 16, 32758 Detmold
Germany

Additional Manufacturing location (S):
Weidmüller Interface (Suzhou) Co., Ltd
New Technology Park
81 Xiangyang Road
Suzhou New District
Jiangsu Province
China

This certificate is issued as verification that a sample(s), representative of production, was assessed and tested and found to comply with the IEC Standards list below and that the manufacturer's quality system, relating to the Ex products covered by this certificate, was assessed and found to comply with the IECEx Quality system requirements. This certificate is granted subject to the conditions as set out in IECEx Scheme Rules, IECEx 02 and Operational Documents as amended.

STANDARDS:
The electrical apparatus and any acceptable variations to it specified in the schedule of this certificate and the identified documents, was found to comply with the following standards:

IEC 60079-0 : 2011 Edition: 8-3	Explosive atmospheres - Part 0: General requirements
IEC 60079-11 : 2011 Edition: 6-0	Explosive atmospheres - Part 11: Equipment protection by intrinsic safety "I"
IEC 60079-26 : 2006 Edition: 2	Explosive atmospheres - Part 26: Equipment with equipment protection level (EPL) Ga

This Certificate **does not** indicate compliance with electrical safety and performance requirements other than those expressly included in the Standards listed above.

TEST & ASSESSMENT REPORTS:
A sample(s) of the equipment listed has successfully met the examination and test requirements as recorded in:

Test Report
NUDEXTR11 0016/01

Quality Assessment Report
NUDEXGAR12 0052/00 NUDEXGAR12 0072/00

IECEX Certificate of Conformity

Certificate No: **IECEX DEK 11 0020X** Issue No.: 1

Date of Issue: **2013-08-20** Page 3 of 4

Schedule

EQUIPMENT:
Equipment and systems covered by this certificate are as follows:

The Surge Voltage Protection Unit of Series VSSC ... Ex serves to limit any surge voltages in intrinsically safe circuits.

For thermal and electrical data, refer to Annex.

CONDITIONS OF CERTIFICATION: YES as shown below:

The intrinsic safe signal of Surge Voltage Protection Unit Type VSSC4 GDT 55Vuc 20 KA EX, is directly connected to earth (PE).

For ambient temperature range, refer to Annex.

IECEX Certificate of Conformity

Certificate No: **IECEX DEK 11 0020X** Issue No.: 1

Date of Issue: **2013-08-20** Page 4 of 4

DETAILS OF CERTIFICATE CHANGES (for issues 1 and above):

- New Surge Voltage Protection Unit, Type VSSC4 TR SL FG EX is added.
- certificate upgraded to the latest standards
- rename of types

Approval – VSPC-IEC Ex

IECEx Certificate of Conformity		
INTERNATIONAL ELECTROTECHNICAL COMMISSION IEC Certification System for Explosive Atmospheres <small>for rules and details of the IECEx Scheme visit www.iecex.com</small>		
Certificate No.:	IECEx DEK 11.0086X	Page 1 of 4
Status:	Current	Issue No. 4
Date of Issue:	2020-04-01	Issue 3 (2014-03-13) Issue 2 (2013-12-23) Issue 1 (2012-09-06) Issue 0 (2011-10-12)
Applicant:	Weidmüller Interface GmbH & Co. KG Klingenbergstraße 18 37158 Dremdel Germany	
Equipment:	Surge Voltage Protection Unit Series VSPC...Ex	
Optional accessory:		
Type of Protection:	Ex ia	
Marking:	Ex ia IIC T4 ... T8 Ga or Ex ia IIC T135 °C ... T85 °C Da	
Approved for issue on behalf of the IECEx Certification Body:	R. Schuller	
Position:	Certification Manager	
Signature: (for printed version)		
Date:	2020-04-01	
<p>1. This certificate and schedule may only be reproduced in full. 2. This certificate is not transferable and remains the property of the issuing body. 3. The status and authenticity of this certificate may be verified by visiting www.iecex.com or use of this QR Code.</p> 		
<p>Certificate issued by: DEKRA Certification B.V. Meander 1051 6825 NJ Arnhem Netherlands</p> 		

IECEx Certificate of Conformity		
Certificate No.:	IECEx DEK 11.0086X	Page 2 of 4
Date of Issue:	2020-04-01	Issue No. 4
Manufacturer:	Weidmüller Interface GmbH & Co. KG Klingenbergstraße 18 37158 Dremdel Germany	
Additional manufacturing locations:		
<p>This certificate is issued as verification that a sample(s), representative of production, was assessed and tested and found to comply with the IEC Standard (set below) and that the manufacturer's quality system, relating to the Ex products covered by this certificate, was assessed and found to comply with the IECEx Quality system requirements. This certificate is granted subject to the conditions as set out in IECEx Scheme Rules, IECEx 02 and Operational Documents as amended.</p>		
<p>STANDARDS: The equipment and any acceptable variations to it specified in the schedule of this certificate and the identified documents, was found to comply with the following standards:</p>		
IEC 60079-0:2011	Explosive atmospheres – Part 0: General requirements Edition 6.0	
IEC 60079-11:2011	Explosive atmospheres – Part 11: Equipment protection by intrinsic safety "I" Edition 6.0	
<p>This Certificate does not indicate compliance with safety and performance requirements other than those expressly included in the Standards listed above.</p>		
<p>TEST & ASSESSMENT REPORTS: A sample(s) of the equipment listed has successfully met the examination and test requirements as recorded in:</p>		
<p>Test Reports: NU/DEK/EXTR11.0099/00 NU/DEK/EXTR11.0099/01 NU/DEK/EXTR11.0099/02 NU/DEK/EXTR11.0099/03 NU/DEK/EXTR11.0099/04</p>		
<p>Quality Assessment Report: NU/DEK/QAR12.0052/07</p>		

IECEx Certificate of Conformity		
Certificate No.:	IECEx DEK 11.0086X	Page 3 of 4
Date of Issue:	2020-04-01	Issue No. 4
<p>EQUIPMENT: Equipment and systems covered by this Certificate are as follows:</p> <p>The Surge Voltage Protection Unit of Series VSPC...Ex serves to limit eventual surge voltages in intrinsically safe circuits. The Units consist out of a Base unit for rail mounting and a plugable protection Module provided with a (for each Unit Model) unique mechanical key. The Plug-in unit Type VSPC 1CL PW 24Vac EX also contains a LED error-indication. Several units for different intrinsically safe circuits may be mounted next to each other. See annex "attachment to IECEx DEK 11.0086 X Issue 4" for more detailed information.</p>		
<p>SPECIFIC CONDITIONS OF USE: YES as shown below: For application in explosive dust atmospheres: The Surge Voltage Protection Units shall be installed in an enclosure, which provides a degree of protection of at least IP6X in accordance with IEC 60529, and is suitable for the application and correctly installed. The maximum surface temperature of the enclosure is specified in the annex "attachment to IECEx DEK 11.0086 X Issue 4". Measures shall be taken to avoid the danger of ignition due to electrostatic charges.</p>		

IECEx Certificate of Conformity		
Certificate No.:	IECEx DEK 11.0086X	Page 4 of 4
Date of Issue:	2020-04-01	Issue No. 4
<p>DETAILS OF CERTIFICATE CHANGES (for issues 1 and above) Minor constructional change and IEC 60079-26 removed.</p>		
<p>Annex: 224485000 - Annex 1.pdf</p>		

Approval – VSPC-IEC Ex



Attachment 1 to IECEx DEK 11.0086 X

General product information:

The Surge Voltage Protection Unit of Series VSPC...Ex serves to limit eventual surge voltages in intrinsically safe circuits.

The Units consist out of a Base unit for rail mounting and a pluggable protection Module provided with a (for each Unit Model) unique mechanical key.

The Plug-in unit Type VSPC 1CL PW 24Vac EX also contains a LED error-indication.

Several units for different intrinsically safe circuits may be mounted next to each other.

Electrical data

Input circuit (Terminals 1, 5, 7 and 11):
in type of protection intrinsic safety Ex ia IIC or Ex ia IIIC, only for connection to a certified intrinsically safe circuit, with the following maximum values:
 $L_i = 0 \mu\text{H}$; $C_i = 25 \text{ nF}$ (for Type VSPC 1CL PW 24VAC EX);
 $C_i = 4 \text{ nF}$ (for the other Types).

The values of U_i for the different types of pluggable modules are listed in the following table:

Pluggable protection Module Types	U_i
VSPC ... 5VDC EX	6 V
VSPC ... 12VDC EX	14 V
VSPC ... 12VAC EX	19 V
VSPC ... 24VDC EX	26 V
VSPC 1CL PW 24VAC EX	27 V
VSPC ... 24VAC EX	38 V
VSPC ... 48VAC EX	75 V

The temperature class / maximum surface temperature of the Base modules, depending on I_i and the ambient temperature range is listed in the following table:

Base Module Type	I_i	Ambient temperature range	Temperature class / Maximum surface temperature
VSPC BASE 4SL FG EX	250 mA	-40 °C to +60 °C	T6 / T85 °C
VSPC BASE 2CL FG EX	250 mA	-40 °C to +75 °C	T5 / T100 °C
VSPC BASE 1CL PW FG EX	350 mA	-40 °C to +85 °C	T4 / T135 °C
VSPC BASE 1CL FG EX		-40 °C to +60 °C	T6 / T85 °C
VSPC BASE 2SL FG EX		-40 °C to +75 °C	T5 / T100 °C
VSPC BASE 2/4CH FG EX	3.3 A	-40 °C to +85 °C	T4 / T135 °C

Page 1/2



Attachment 1 to IECEx DEK 11.0086 X

Output circuits (Terminals 2, 6, 8 and 12):
in type of protection intrinsic safety Ex ia IIC or Ex ia IIIC. The output parameters are equal to the output parameters of the external intrinsically safe circuits connected to the input circuit. For the determination of the maximum allowed external capacitance (C_e) and inductance (L_e), the values of the internal capacitance (C_i) and inductance (L_i) shall be taken into account.

Page 2/2

You can find the current certificates here:
www.weidmueller.com/certificates



Lightning and surge protection for data interfaces

Lightning and surge protection for data interfaces	Surge protection fundamentals for data signals	D.2
	Surge protection for data interfaces	D.4
	Installation instructions for data interfaces	D.16



Surge protection for data interfaces

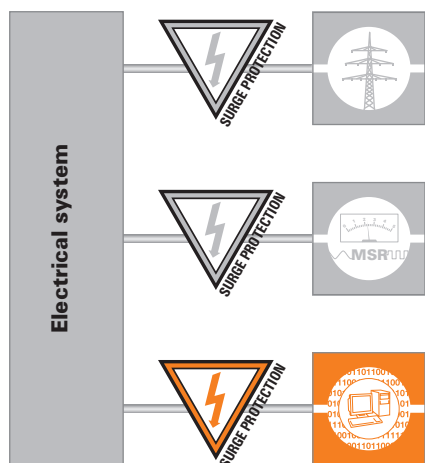

“Data transmission” is the name given to the sending of characters, numbers, statuses and measurements between different, decentralised units. Decentralised units are, for example, controls, computers, measuring sensors, actuators, etc. One unit transmits the data, the second unit receives it. This corresponds to the simplest method of data transmission. It is often necessary for one unit to receive data and then send an “answer” back to the other unit. Two data lines in a back-to-back arrangement are required for this, or data lines are combined by providing each end of the data line with a transmitter and receiver.

Structures and properties of networks

There are various options for networking data terminals. We distinguish between star, ring, point-to-point and bus networks.

Star networks

The main unit is located in the centre. The individual data lines then radiate out from this centre to the individual terminals. In this system all data terminals are connected to the central terminal via their own cable.

Ring networks

The computers or data terminals are all connected to each other like a chain by means of, for example, coaxial cable. In this case the data is passed on from one data terminal to the next. Therefore, the entire ring is always under load. The advantage of the ring network is that it can cover a larger area than a star network because the length of the transmission path is only ever the distance between two adjacent data terminals.

Point-to-point networks

These are basically networks between two data terminals that are connected directly with each other, e.g. an RS 232 or RS 422 link.

Bus networks

These are networks based on the parallel connection of modules. All components operate on one and the same line. Therefore, only two/four wires are required for the data bus. If bus cabling includes branches, then we call that a tree structure. Every bus system includes a bus controller that issues “transmission licences” to the individual data terminals.

Transmission media

In order to be able to send any data at all, data lines are necessary:

Two- and three-wire systems

Data transmissions requiring relatively low transmission rates can make use of two-wire systems. For example, an ISDN system acting as an exchange line to a building requires only two wires.

However, there are bus systems which also require only two or three wires.

Four-wire systems

This is the current standard for the majority of corporate data networks. Two wires are used for transmitting data and two for receiving. These cables are well shielded and can transmit data with frequencies of up to 500 MHz over distances of up to 100 m.

Serial interfaces

A serial interface operates with 8 data bits (1 byte). A start bit (low bit) is always sent before the output of a byte, and one or two stop bits (high bits) are appended to the end of the byte. This encryption is critical for the data receiver as it can then detect where each data byte begins and ends. Serial interfaces frequently operate with +5 V (logical 1) and 0 V (logical 0). Advantage: less cabling (only 3 wires). Disadvantage: slow data transmission.

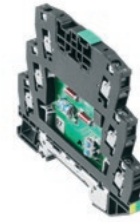
**RS 232**

Serial interface for point-to-point connections up to 20 kbit/s
Voltage signal to earth:
logic 1 (mark) -15 V to -3 V
logic 0 (space) +3 V to +15 V
max. signal level ± 15 V
Lines up to 20 m long depending on transmission rate.

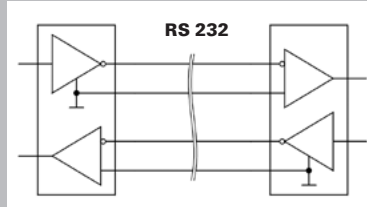

Protection module in terminal housing
VSSC 6 / RS232

Page D.14**RS 422**

Serial uni-directional high-speed interface for up to 10 parallel receivers
Differential voltage signal:
logic 1 (mark) A-B < -0.3 V
logic 0 (space) A-B > +0.3 V
max. signal level ± 12 V
Lines up to 1200 m long
max. data rate 10 Mbit/s

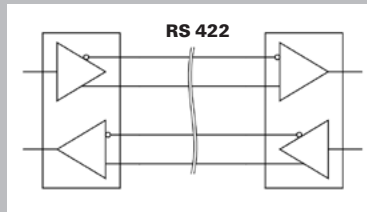

Protection module in plug-in housing
VSSC / RS485

Page D.8**RS485**

Serial bi-directional high-speed interface for up to 32 subscribers
2- or 4-wire system
Differential voltage signal:
logic 1 (mark) A-B < -0.3 V
logic 0 (space) A-B > +0.3 V
max. signal level -7 V to +12 V
Lines up to 1200 m long
max. data rate 10 Mbit/s

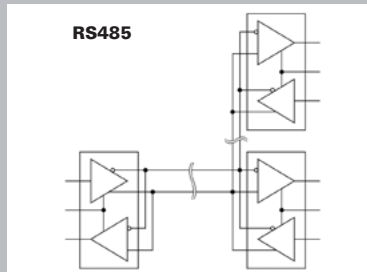

Protection module in plug-in housing
VSSC / RS485
VSSC / RS485 R

Page D.8
Page D.10

Protection module in terminal housing
VSSC 6 / RS485
VSSC 6 / RS485 DP

Page D.14

VSPC 2CL HF - protection for two analogue high-frequency signals

- Optional monitoring function with status indicator and alert function
- Pluggable arrester (impedance-neutral plugging/unplugging without interruption)
- Can be tested with the V-TEST testing device
- Optional version with floating earth PE connection to avoid voltage potential differences
- Usable in accordance with installations standard IEC 62305
- Tested in accordance with IEC/EN 61643-21: D1,C1,C2,C3
- Integrated PE foot, safely discharges up to 20 kA (8/20 μs) and 2.5 kA (10/350 μs) to PE

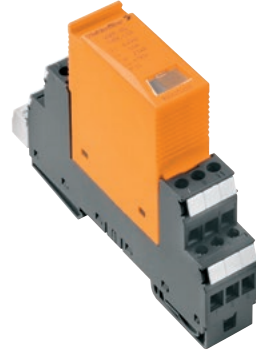

Technical data

Volume resistance	2.20 Ω
Overload - failure mode	Modus 2
Requirements category acc. to IEC 61643-21	C1, C2, C3, D1
Surge current-carrying capacity C1	< 1 kA 8/20 μs
Surge current-carrying capacity C2	5 kA 8/20 μs
Surge current-carrying capacity C3	100 A 10/1000 μs
Surge current-carrying capacity D1	2.5 kA 10/350 μs
Discharge current I ₁ (8/20 μs) wire-wire/wire-PE/GND-PE	2.5 kA / 2.5 kA / 2.5 kA
Discharge I _{max} (8/20 μs) wire-wire/wire-PE/GND-PE	10 kA / 2 x 10 kA / 10 kA
Lightning test I _{imp} (10/350 μs) wire-wire/wire-PE/GND-PE	2.5 kA / 2.5 kA / 2.5 kA
Type of connection	Pluggable in VSPC BASE
Storage temperature	-40 °C...80 °C
Ambient temperature (operational)	-40 °C...70
Protection degree	IP20
Failure probability	
Ages	45
MTTF	2537
SIL in compliance with IEC 61508	3
Approvals	
Approvals	CE; CSAEX; FUSAFETY; UL
Standards	IEC 61643-21, HART-compatible

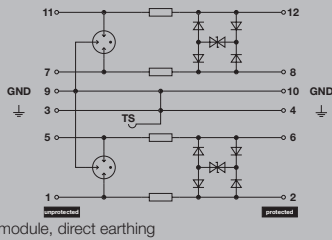

Complete module, direct earthing

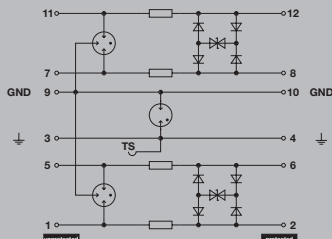

Complete module, indirect earthing

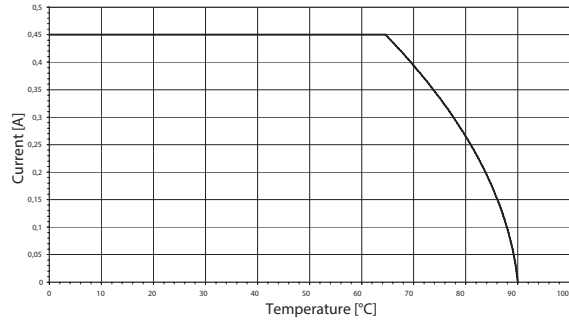

Dimensions of complete module (arrester + base element)	no remote sig. contact
Height x width x depth	mm 90 / 17.8 / 69

Note The associated VSPC base element should be ordered with this. The dimension information provided refers to the complete module.

Base elements / base to arresters



Socket, ordering data

Description	Type	Qty.	Order No.
Base element, direct earthing	VSPC BASE 2CL	1	8924710000
Base element, indirect earthing / floating earth FG	VSPC BASE 2CL FG	1	8924270000

Note Technical data can be found at the beginning of the VARITECTOR SPC section.

VSPC 2CL HF - arrester / plug-in components



Ordering data

	VSPC 2CL HF 5 V DC	VSPC 2CL HF 12 V DC	VSPC 2CL HF 24 V DC
Rated voltage (AC)			
Rated voltage (DC)	5 V	12 V	24 V
Max. continuous voltage, U _c (AC)			
Max. continuous voltage, U _c (DC)	6.4 V	15 V	28 V
Rated current I _n	450 mA	450 mA	450 mA
Input attenuation	103 MHz	104 MHz	109 MHz
Pulse-reset capacity	≤ 20 ms	≤ 80 ms	≤ 40 ms
Residual voltage, U _r typical	< 800 V	< 800 V	< 800 V
Protection level			
Protection level wire-wire 1kV/μs, type	12 V	25 V	45 V
Protection level wire-wire 8/20 μs, type	12 V	25 V	45 V
Protection level wire-PE 1kV/μs, type	450 V	450 V	450 V
Protection level wire-PE 8/20 μs, type	< 800 V	< 800 V	< 800 V

Ordering data	VSPC 2CL HF 5VDC	VSPC 2CL HF 12VDC	VSPC 2CL HF 24VDC
without function indicator			
Type	VSPC 2CL HF 5VDC	VSPC 2CL HF 12VDC	VSPC 2CL HF 24VDC
Order No.	8924430000	8924460000	8924510000
Qty.	1	1	1
Note			



VSPC 2CL HF - protection for two analogue high-frequency signals with remote alert

- Optional monitoring function with status indicator and alert function
- Pluggable arrester (impedance-neutral plugging/unplugging without interruption)
- Can be tested with the V-TEST testing device
- Optional version with floating earth PE connection to avoid voltage potential differences
- Usable in accordance with installations standard IEC 62305
- Tested in accordance with IEC/EN 61643-21: D1,C1,C2,C3
- Integrated PE foot, safely discharges up to 20 kA (8/20 µs) and 2.5 kA (10/350 µs) to PE

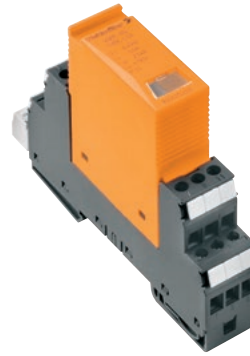

Technical data

Volume resistance	2.20 Ω
Overload - failure mode	Modus 2
Requirements category acc. to IEC 61643-21	C1, C2, C3, D1
Surge current-carrying capacity C1	< 1 kA 8/20 µs
Surge current-carrying capacity C2	5 kA 8/20 µs
Surge current-carrying capacity C3	100 A 10/1000 µs
Surge current-carrying capacity D1	2.5 kA 10/350 µs
Discharge current I ₁ (8/20 µs) wire-wire/wire-PE/GND-PE	2.5 kA / 2.5 kA / 2.5 kA
Discharge I _{max} (8/20 µs) wire-wire/wire-PE/GND-PE	10 kA / 2 x 10 kA / 10 kA
Lightning test I _{imp} (10/350 µs) wire-wire/wire-PE/GND-PE	2.5 kA / 2.5 kA / 2.5 kA
Type of connection	Pluggable in VSPC BASE
Storage temperature	-40 °C...80 °C
Ambient temperature (operational)	-40 °C...70
Protection degree	IP20
Failure probability	
Ages	45
MTTF	2537
SIL in compliance with IEC 61508	3
Approvals	
Approvals	CE; CSAEX; FUSAFETY; UL
Standards	IEC 61643-21, HART-compatible

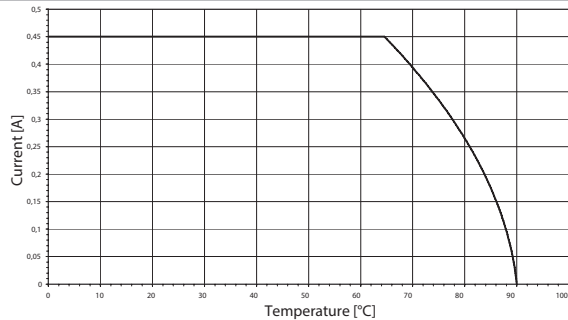
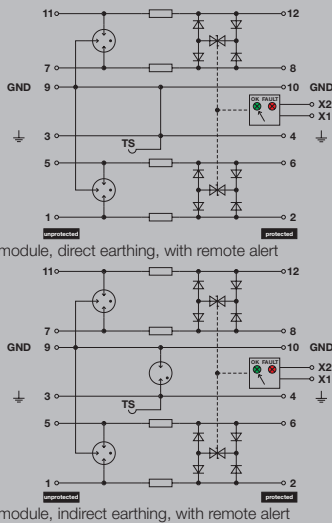

Dimensions of complete module (arrester + base element)	with remote signalling (R)
Height x width x depth	mm 98 / 17.8 / 69

Note The associated VSPC base element should be ordered with this. The dimension information provided refers to the complete module.

Base elements / base to arresters



Socket, ordering data

Description	Type	Qty.	Order No.
Base element, direct earthing with remote contact	VSPC BASE 2CL R	1	8951710000
Base element, indirect earthing with remote contact	VSPC BASE 2CL FG R	1	8951720000

Note Technical data can be found at the beginning of the VARITECTOR SPC section. Order with VSPC CONTROL UNIT.

**VSPC 2CL HF - arrester / plug-in components
with remote alert**

Ordering data

	VSPC 2CL HF 5 V DC R	VSPC 2CL HF 12 V DC R	VSPC 2CL HF 24 V DC R
Rated voltage (AC)			
Rated voltage (DC)	5 V	12 V	24 V
Max. continuous voltage, U_c (AC)			
Max. continuous voltage, U_c (DC)	6.4 V	15 V	28 V
Rated current I_N	450 mA	450 mA	450 mA
Signalling contact	U_N 250 V AC 0.1 A 1CO at VSPC R with VSPC control unit	U_N 250 V AC 0.1 A 1CO at VSPC R with VSPC control unit	U_N 250 V AC 0.1 A 1CO at VSPC R with VSPC control unit
Optical function display	green = OK; red = arrester is defective - replace	green = OK; red = arrester is defective - replace	green = OK; red = arrester is defective - replace
Input attenuation	103 MHz	104 MHz	109 MHz
Pulse-reset capacity	≤ 20 ms	≤ 80 ms	≤ 40 ms
Residual voltage, U_r typical	< 800 V	< 800 V	< 800 V
Protection level			
Protection level wire-wire 1kV/ μ s, type	12 V	25 V	45 V
Protection level wire-wire 8/20 μ s, type	12 V	25 V	45 V
Protection level wire-PE 1kV/ μ s, type	450 V	450 V	450 V
Protection level wire-PE 8/20 μ s, type	< 800 V	< 800 V	< 800 V

Ordering data

with function indicator	Type	VSPC 2CL HF 5VDC R	VSPC 2CL HF 12VDC R	VSPC 2CL HF 24VDC R
Order No.		8951680000	8951690000	8951700000
Qty.		1	1	1
Note				



VSPC RS485 / RS422

- Pluggable arrester (impedance-neutral plugging/unplugging without interruption)
- Can be tested with V-TEST testing device
- Optional monitoring function with status indicator and alert functions
- Low residual voltage
- Version with floating-earth PE connection for avoiding voltage potential differences
- Tested in accordance with IEC 61643-21
- Integrated PE foot, safely discharges up to 20 kA (8/20 μs) and 2.5 kA (10/350 μs) to PE

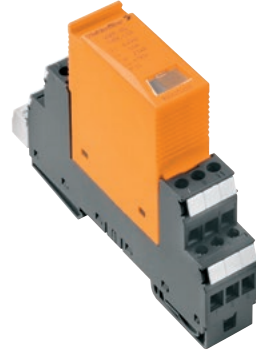

Technical data

Volume resistance	2.20 Ω
Overload - failure mode	Modus 2
Requirements category acc. to IEC 61643-21	C1, C2, C3, D1
Surge current-carrying capacity C1	< 1 kA 8/20 μs
Surge current-carrying capacity C2	5 kA 8/20 μs
Surge current-carrying capacity C3	100 A 10/1000 μs
Surge current-carrying capacity D1	2.5 kA 10/350 μs
Discharge current I _d (8/20 μs) wire-wire/wire-PE/GND-PE	2.5 kA / 2.5 kA / 2.5 kA
Discharge I _{max} (8/20 μs) wire-wire/wire-PE/GND-PE	10 kA / 2 x 10 kA / 10 kA
Lightning test I _{imp} (10/350 μs) wire-wire/wire-PE/GND-PE	0.2 kA / 2 x 0.2 kA / 0.2 kA
Type of connection	Pluggable in VSPC BASE
Storage temperature	-40 °C...80 °C
Ambient temperature (operational)	-40 °C...70
Protection degree	IP20
Failure probability	
Ages	57
MTTF	2003
SIL in compliance with IEC 61508	3
Approvals	
Approvals	CE; CSAEX; FUSAFETY; UL
Standards	IEC 61643-21

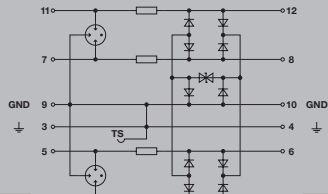

Complete module, direct earthing

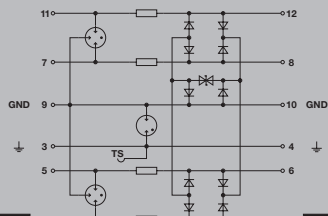

Complete module, indirect earthing

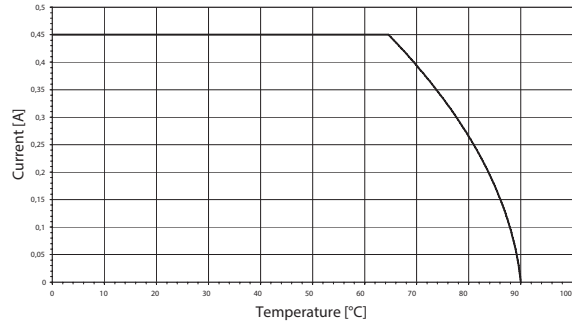

Dimensions of complete module (arrester + base element)	no remote sig. contact
Height x width x depth	mm 90 / 17.8 / 69

Note The associated VSPC base element should be ordered with this. The dimension information provided refers to the complete module.

Base elements / base to arresters



Socket, ordering data

Description	Type	Qty.	Order No.
Base element, indirect earthing / floating earth FG	VSPC BASE 2CL FG	1	8924270000
Base element, direct earthing	VSPC BASE 2CL	1	8924710000

Note Technical data can be found at the beginning of the VARITECTOR SPC section.

VSPC RS485 / RS422 - arrester / plug-in components



Ordering data

Ordering data		VSPC RS485 2CH
Rated voltage (AC)		5 V
Rated voltage (DC)		5 V
Max. continuous voltage, U_c (AC)		5 V
Max. continuous voltage, U_c (DC)		6.4 V
Rated current I_n		450 mA
Input attenuation		113.6 MHz
Pulse-reset capacity		≤ 20 ms
Residual voltage, U_p typical		250 V
Protection level		
Protection level wire-wire 1kV/ μ s, type		10 V
Protection level wire-wire 8/20 μ s, type		15 V
Protection level wire-PE 1kV/ μ s, type		10 V
Protection level wire-PE 8/20 μ s, type		250 V

Ordering data		
without function indicator	Type	VSPC RS485 2CH
	Order No.	8924670000
	Qty.	1
Note		



VSPC RS485 with remote alert

- Pluggable arrester (impedance-neutral plugging/unplugging without interruption)
- Can be tested with the V-TEST testing device
- Optional monitoring function with status indicator and alert functions
- Lower residual voltage
- Version with floating-earth PE connection for avoiding voltage potential differences
- Tested in accordance with IEC 61643-21
- Integrated PE foot, safely discharges up to 20 kA (8/20 μs) and 2.5 kA (10/350 μs) to PE

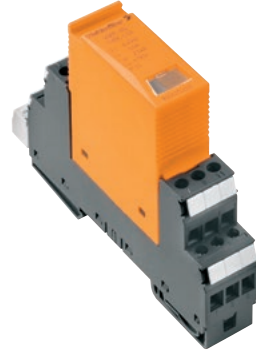

Technical data

Volume resistance	2.20 Ω
Overload - failure mode	Modus 2
Requirements category acc. to IEC 61643-21	C1, C2, C3, D1
Surge current-carrying capacity C1	< 1 kA 8/20 μs
Surge current-carrying capacity C2	5 kA 8/20 μs
Surge current-carrying capacity C3	100 A 10/1000 μs
Surge current-carrying capacity D1	2.5 kA 10/350 μs
Discharge current I ₁ (8/20 μs) wire-wire/wire-PE/GND-PE	2.5 kA / 2.5 kA / 2.5 kA
Discharge current I _{max} (8/20 μs) wire-wire/wire-PE/GND-PE	10 kA / 2 x 10 kA / 10 kA
Lightning test I _{imp} (10/350 μs) wire-wire/wire-PE/GND-PE	0.2 kA / 2 x 0.2 kA / 0.2 kA
Type of connection	Pluggable in VSPC BASE
Storage temperature	-40 °C...80 °C
Ambient temperature (operational)	-40 °C...70
Protection degree	IP20
Failure probability	
Ages	90
MTTF	1266
SIL in compliance with IEC 61508	3
Approvals	
Approvals	CE; CSAEX; FUSAFETY; UL
Standards	IEC 61643-21

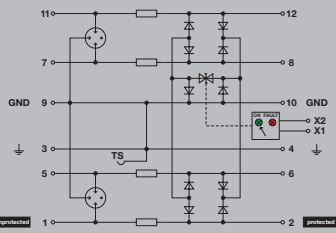

Complete module, direct earthing, with remote alert

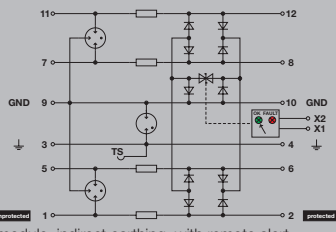

Complete module, indirect earthing, with remote alert

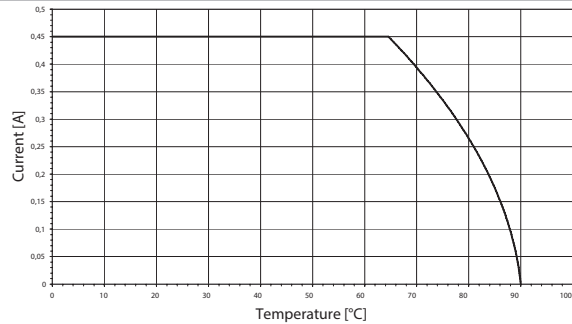

Dimensions of complete module (arrester + base element)	with remote signalling (R)
Height x width x depth	mm 98 / 17.8 / 69

Note The associated VSPC base element should be ordered with this. The dimension information provided refers to the complete module.

Base elements / base to arresters



Socket, ordering data

Description	Type	Qty.	Order No.
Base element, direct earthing with remote contact	VSPC BASE 2/4CH R	1	8951790000
Base element, indirect earthing with remote contact	VSPC BASE 2/4CH FG R	1	8951800000

Note Technical data can be found at the beginning of the VARICTECTOR SPC section. Order with VSPC CONTROL UNIT.

**VSPC RS485 - arrester / plug-in components
with remote alert**



Ordering data

	VSPC RS485 2CH R
Rated voltage (AC)	5 V
Rated voltage (DC)	5 V
Max. continuous voltage, U_c (AC)	5 V
Max. continuous voltage, U_c (DC)	6.4 V
Rated current I_N	450 mA
Signalling contact	U_N 250 V AC 0.1 A 1CO at VSPC R with VSPC control unit
Optical function display	green = OK; red = arrester is defective - replace
Input attenuation	113.6 MHz
Pulse-reset capacity	≤ 20 ms
Residual voltage, U_r typical	250 V
Protection level	
Protection level wire-wire 1kV/ μ s, type	10 V
Protection level wire-wire 8/20 μ s, type	15 V
Protection level wire-PE 1kV/ μ s, type	10 V
Protection level wire-PE 8/20 μ s, type	250 V

Ordering data

with function indicator	Type	VSPC RS485 2CH R
	Order No.	8951670000
	Qty.	1
Note		



V DATA surge protection for four wire pairs with RJ45 socket

- RJ45 connection
- All 4 wire pairs are protected
- Sturdy and compact metal housing
- Suitable for Cat. 5 (up to 100 MHz) and Cat. 6 (up to 250 MHz, Class E)
- Suitable for PoE+ (according to IEEE 802.3at, IEEE 802.3bt Type 3 and 4)



V DATA CAT6

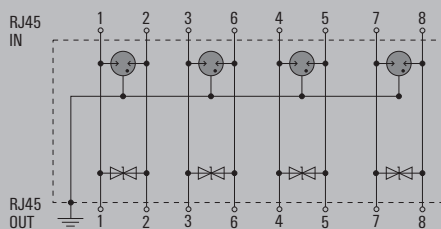

V DATA CAT5e

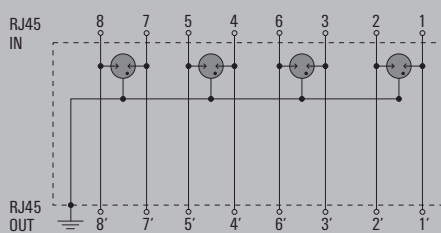

Technical data

Requirements category acc. to IEC 61643-21	D1, C1, C2, C3
Surge current-carrying capacity C2	10 kA
Surge current-carrying capacity D1	1 kA 10/350 μ s
Discharge current I_t (8/20 μ s) wire-wire/wire-PE	/ 10 kA
Discharge I_{max} (8/20 μ s) wire-wire/wire-PE	/ 10 kA
Lightning test I_{imp} (10/350 μ s) wire-wire/wire-PE	/ 1 kA
Humidity	0...95 % (no condensation)
Type of connection	RJ45-Port
Storage temperature	-40 °C...85 °C
Ambient temperature (operational)	-40 °C...80 °C
Net weight	137 g
Protection degree	IP20

Approvals

Standards	IEC 61643-21
-----------	--------------

Dimensions of complete module (arrester + base element)

Height x width x depth	mm	75 / 19 / 46
------------------------	----	--------------

Note

V DATA surge protection for four wire pairs with RJ45 socket

Ordering data

	V DATA CAT6	V DATA CAT5e
Max. continuous voltage, U_c (AC)	48 V	48 V
Rated current I_n	1 A	1 A
Insertion loss	≤ 1 dB @ 250 MHz	
Protection level, U_p wire - wire	150 V	600 V
Protection level, U_p wire - PE	550 V	550 V
Frequency range, max.	250	100
Response time	<1 ns	<1 ns
Volume resistance	<0.1 Ω	<0.1 Ω
Wire-wire capacitance @ 1 MHz, 1 Vrms	30 pF	30 pF
Wire-PE capacitance @ 1 MHz, 1 Vrms	20 pF	20 pF
Voltage Breakdown (VDC) L-L	53 V - 73 V	
Voltage Breakdown (VDC) L-G	72 V - 120 V	
Approvals	CE; UL	

Ordering data	V DATA CAT6	V DATA CAT5e
Type	V DATA CAT6	V DATA CAT5e
Order No.	1348590000	2916360000
Qty.	1	1
Note		



**VSSC 6AN RS485, RS485 DP and RS232 –
for interface signals**

- Two-stage surge protection with screw connection for RS422/RS485 data interfaces
- Surge protection in terminal block design
- Modular width of only 6.2 mm
- Space-saving design: 1 signal
- Torx® slotted screw connection
- Can be used in compliance with installation standard IEC 62305
- Tested in accordance with IEC 61643-21: D1, C2, C3
- Integrated PE foot, safely discharges up to 20 kA (8/20 µs) and 2.5 kA (10/350 µs) to PE

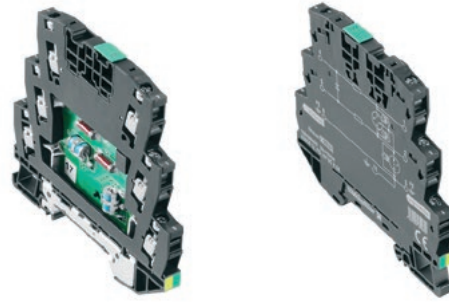

Technical data

Rated current I_N	500 mA
Volume resistance	1.8 Ω 10 %
Overload - failure mode	Modus 2
Requirements category acc. to IEC 61643-21	C2, C3, D1
Standards	IEC 61643-21
Surge current-carrying capacity C1	2.5 kA 8/20 µs 5 kV 1.2/50 µs
Surge current-carrying capacity C2	10 A 10/1000 µs
Surge current-carrying capacity C3	0.5 kA 10/350 µs
Discharge current I_t (8/20 µs) wire-wire/wire-PE/GND-PE	2.5 kA / 2.5 kA
Discharge I_{max} (8/20 µs) wire-wire/wire-PE/GND-PE	10 kA / 10 kA
Lightning test I_{imp} (10/350 µs) wire-wire/wire-PE/GND-PE	/ 0.5 kA
Storage temperature	-40 °C...80 °C
Ambient temperature (operational)	-40 °C...70 °C
Protection degree	IP20
UL 94 flammability rating	V-0

Connection data	
Type of connection	Screw connection
Tightening torque	0.5 Nm
Wire connection cross section, finely stranded, max.	4 mm ²
Wire connection cross-section, finely stranded, min.	0.5 mm ²
Wire cross-section, solid, max.	6 mm ²
Wire cross-section, solid, min.	0.5 mm ²
Wire cross-section, stranded, max.	4 mm ²
Wire cross-section, stranded, min.	0.5 mm ²
Stripping length	10 mm
Rail	TS 35

Failure probability	
ages	60
MTTF	1903
SIL in compliance with IEC 61508	3

Approvals	
Approvals	CE; CSAE; FUSAFETY; DEVE; UL
Standards	IEC 61643-21

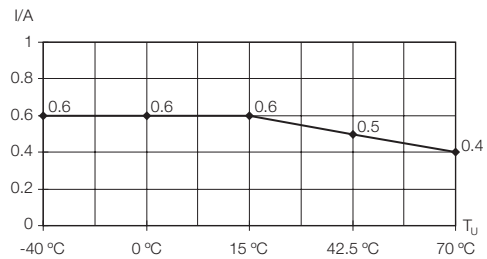
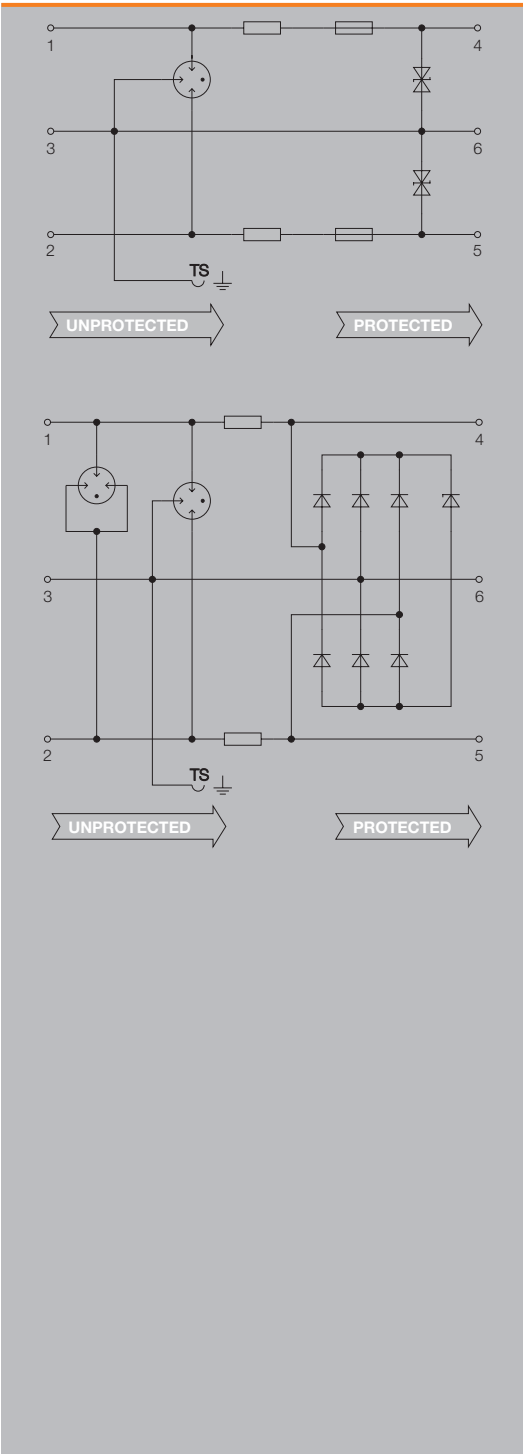

Dimensions	Dimensions
Height x width x depth	mm 88.5 / 6.2 / 81

Note

VSSC 6AN RS485, RS485 DP and RS232

Ordering data

	RS485	RS485 DP	RS232
Rated voltage (DC)	12 V	12 V	12 V
Max. continuous voltage, U_c (DC)	15 V	15 V	15 V
Rated current I_N	500 mA	500 mA	500 mA
Input attenuation	113.6 MHz	113.6 MHz	1.4 MHz
Pulse-reset capacity	≤ 15 ms	≤ 15 ms	≤ 15 ms
Residual voltage, U_p typical	≤ 100 V	≤ 100 V	≤ 100 V
Protection level			
Protection level wire-PE 8/20 μ s, type	≤ 100 V	≤ 100 V	≤ 100 V

Ordering data			
Type	VSSC6 RS485	VSSC6 RS485 DP	VSSC6 RS232
Order No.	1064980000	1065010000	1064990000
Qty.	10	10	10
Note	End plate AP VSSC6 1063110000	End plate AP VSSC6 1063110000	End plate AP VSSC6 1063110000

D



Installation instructions for data interfaces

The supply and earth lines of the protective modules should be kept short in order to achieve optimum protection for the data terminals.

Likewise, the transmission paths should also be kept as short as possible because the longer the line, the greater is the chance of interference having an effect.

Inserting surge protection increases the attenuation of the line and so changes the signal-to-noise ratio.

Installation position

Protective modules are frequently installed at both ends of the line.

It is important to ensure that protected and unprotected lines are routed separately. Further, there should be some clearance between power lines and data lines. A common cable duct must be subdivided with metal partitions.

Shielded lines for data interfaces

Systems involving several buildings should be designed with cable shielding capable of carrying current. These data lines often have two shields: one for carrying transient currents, the other as protection against coupled interference.

Circuit concepts

High transmission frequencies place greater demands on surge protection in protective circuits for data interfaces. Gas discharge tubes are frequently the sole means of protection in these cases. However, the disadvantage of this is that the protection level is very high. Lower protection levels can be attained at high transmission frequencies by using special low-capacity suppressor diodes.

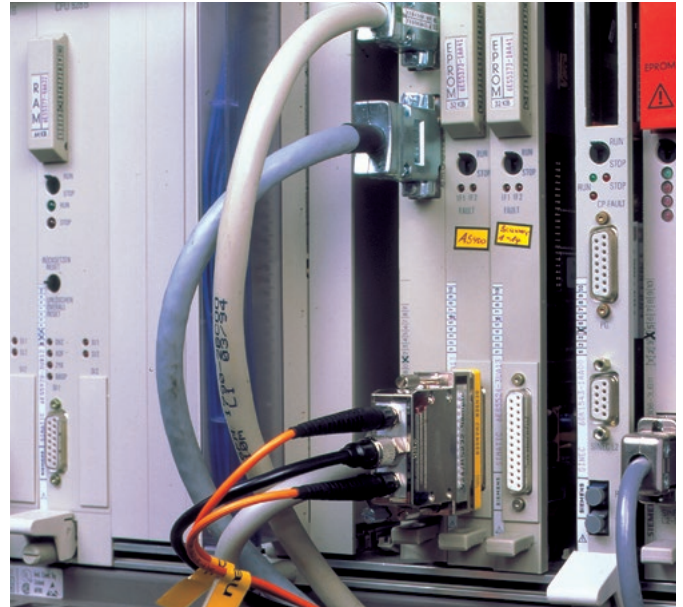

Mains filter

Mains filter

WAVEFILTER

E.2



WAVEFILTER

WAVEFILTERS for simple radio interference suppression in the control cabinet

The WAVEFILTER series eliminates the time consuming work of screwing in mains filters. These filters are simply clipped on to the TS35 rail and connected to the device requiring suppression. The two-stage WAVEFILTER with overall width 22.5 mm in 3 A, 6 A and 10 A versions offers high attenuation.

The WAVEFILTER, with current-compensating choke, is ideal for applications in drive technology and control/automation systems, e.g. for suppressing continuous interference types such as "noise" or "ripple" caused by interfering radiation from other systems, or interference from frequency converters and switch-mode power supplies. A short, low ohm mass connection is required for the WAVEFILTER to function perfectly. We recommend earthing all devices directly with the largest possible cross-section to a central earthing point in the control cabinet.

Interference signals

We distinguish between two types of induced transient and continuous interference signals: symmetrical (differential mode) and asymmetrical (common mode). The symmetrical interference signals generate a voltage between the signal leads of the system. The asymmetrical interference voltages occur between the signal leads and earth.

The WAVEFILTER is suitable for attenuating both kinds of interference signal. In addition, WAVEFILTER 10 A also has an earthing conductor choke. This earthing conductor choke supports both attenuation on the earthing conductor for the filter and additional attenuation of asymmetrical interference voltages.

The WAVEFILTER has cULus approval.

Insertion loss

WAVEFILTER 3 A

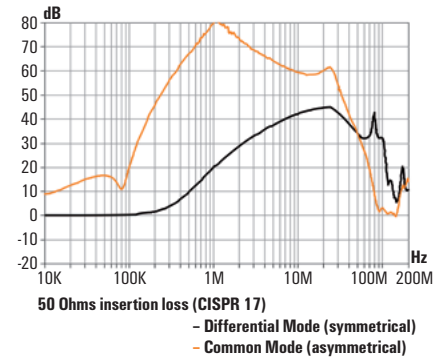

WAVEFILTER 6 A

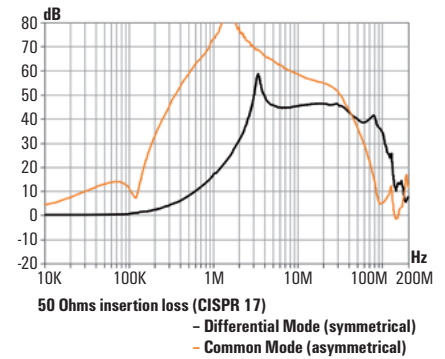

WAVEFILTER 10 A

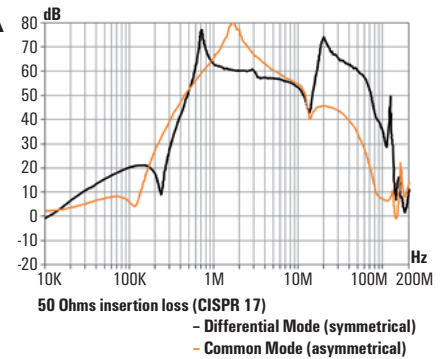

Installation height 112.4 mm



Installation height 92.4 mm



Dimensions

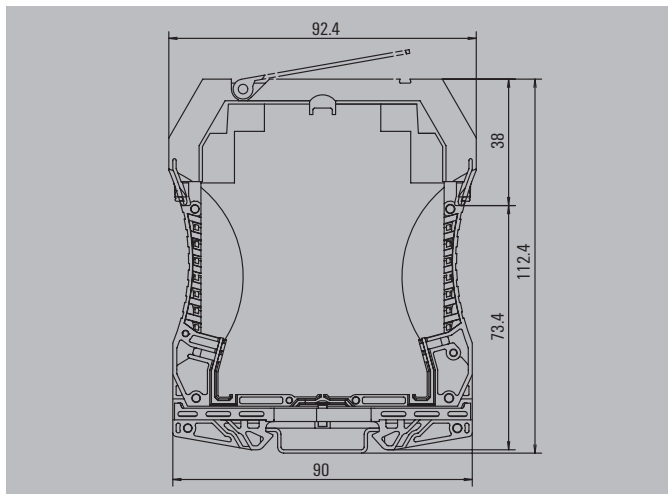

Dimensions

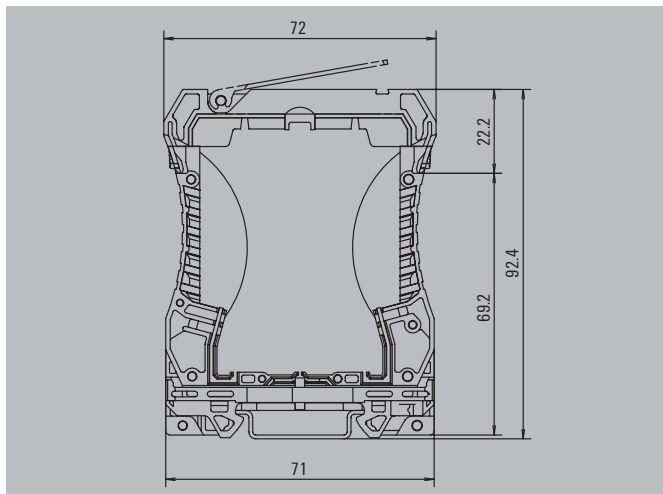

WAVEFILTER

WAVEFILTER

- Clips to TS 35
- High symmetrical and asymmetrical attenuation
- Suitable for voltages from 5 V to 250 V

WAVEFILTER 3 A 250 V

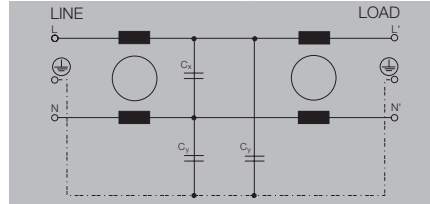

WAVEFILTER 6 A 250 V

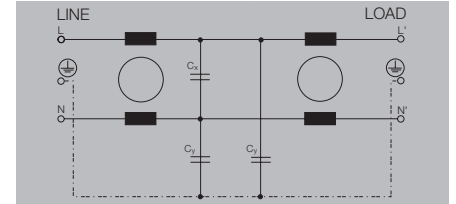

Technical data

Rated voltage
 Rated current I_n
 Capacitance
 Inductance L and L1
 Leakage current at U_n
 Test voltage P/N-PE
 Test voltage P-N
 Ambient temperature (operational)

Approvals

Approvals

250 V
 3 A
 $C_x / C_{\text{grid}}: 33\text{nF}$
 2 mH
 190 μA
 2000 V AC
 1700 V DC
 -20 °C...40 °C

CE; cURus

250 V
 6 A
 $C_x: 33\text{ nF} / C_{\text{grid}}: 22\text{ nF}$
 0.8 mH
 190 μA
 2000 V AC
 1700 V DC
 -20 °C...40 °C

CE; cURus

Dimensions

Clamping range (nominal / min. / max.) mm²
 Height x width x depth mm

2.5 / 0.5 / 2.5
 73 / 22.5 / 92

2.5 / 0.5 / 2.5
 96.5 / 22.5 / 110.5

Note

See attenuation curve in the introductory text in Chapter E

See attenuation curve in the introductory text in Chapter E

Ordering data

Type	Qty.	Order No.
WAVEFILTER 3A	1	8614780000

Type	Qty.	Order No.
WAVEFILTER 6A	1	8614800000

Note

WAVEFILTER

- Clips to TS 35
- High symmetrical and asymmetrical attenuation
- Suitable for voltages from 5 V to 250 V

WAVEFILTER 10 A 250 V

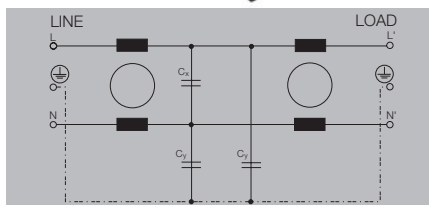

Technical data

Rated voltage
 Rated current I_n
 Capacitance
 Inductance L and L1
 Leakage current at U_n
 Test voltage P/N-PE
 Test voltage P-N
 Ambient temperature (operational)

250 V
 10 A
 C_v : 470 nF / C_{and} : 4.7 nF
 0.8 mH
 190 μ A
 2000 V AC
 1700 V DC
 -20 °C...40 °C

Approvals

Approvals

CE; cURus

Dimensions

Clamping range (nominal / min. / max.)	mm ²	2.5 / 0.5 / 2.5
Height x width x depth	mm	96.5 / 22.5 / 110.5

Note

See attenuation curve in the introductory text in Chapter E

Ordering data

Type	Qty.	Order No.
WAVEFILTER 10A	1	8614770000

Note





Accessories

Accessories	Energy	PLUG VPU AC - Remote contact	F.2
		VPU LOCKING CLIP	F.2
		VPU AC FB - cross-connection	F.3
		VARITECTOR TEST II - Test device	F.4
<hr/>			
	MSR technology	VSPC LOCKING CLIP	F.7
		VSPC cross-connection	F.7
		V-Test - testing device	F.8

Energy

PLUG VPU AC - Remote contact

- Accessories for VPU AC and VPU PV series
- Pluggable remote signaling contact
- PUSH IN connection technology

PLUG VPU AC



Technical data

Execution
Strip length
Connection type
Conductor cross-section, solid, min./max.
Rated voltage (AC)
Operating temperature
Depth x Width x Height

Connector, labeled
8 mm
PUSH IN
0,14...1,5 mm²
250 V
-40 °C...70 °C
21.5 x 11.6 x 8 mm

Note

Ordering data

Note

Type	Qty.	Order No.
PLUG VPU AC	10	2855300000

VPU LOCKING CLIP

- Accessories for VPU AC and VPU PV series
- Locking clips for pluggable VPU arresters

VPU LOCKING CLIP S



VPU LOCKING CLIP L



Technical data

Flammability class according to UL 94
Protection class
Operating temperature
Depth x Width x Height

V-0
IP20
-40 °C...70 °C
7 x 14 x 17 mm

V-0
IP20
-40 °C...70 °C
7,5 x 13 x 17 mm

Note

Ordering data

Note

Type	Qty.	Order No.
VPU LOCKING CLIP S	10	2735080000

Type	Qty.	Order No.
VPU LOCKING CLIP L	10	2735070000

VPU AC FB - cross-connection

Busbar for the VPU AC F series for creating various SPD configurations

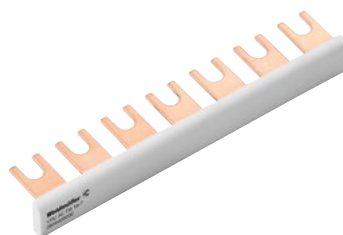
VPU AC FB**Technical data**

Colour	
Note	

Colour	grey
Note	

Ordering data

	2-pole
	3-pole
	4-pole
	6-pole
	7-pole
Note	

Type	Qty.	Order No.
VPU AC FB 16-2	12	2904360000
VPU AC FB 16-3	20	2904370000
VPU AC FB 16-4	1	2904380000
VPU AC FB 16-6	1	2904390000
VPU AC FB 16-7	1	2904400000
Note		

VARITECTOR TEST II

Testing the protective function for all VARITECTOR PU AC and PV products

The surge protection function, when enabled, guarantees reliable protection of devices and systems. The IEC 62305/VDE 0185-305 requires regular testing of overvoltage surge protection devices. That applies to all applications – especially to building infrastructures.

The function of VARITECTOR surge protection devices can be tested with the V-TEST II. The handy, battery-powered device detects the type of surge protection and automatically checks whether the module is at the end of its life. Therefore, your system remains in operation, and you avoid service costs. V-TEST II is easy to use. It comes with a robust enclosure and a charging device. It has a high-quality TFT colour display and can be operated intuitively via a touchscreen.

Ensures timely testing intervals

The portable V-TEST can be used to carry out repeated testing in compliance with IEC 62305-3.

Lightning protection level	Visual inspection	Extensive check	Extensive check in critical situations ^{a), b)}
	Year	Year	Year
I and II	1	2	1
III and IV	2	4	1

a) Lightning protection systems for explosive structural facilities should be visually inspected every six months. The installation should be metrologically tested once per year. To obtain findings about the seasonal fluctuations, it is permissible to take measurements at 14 to 15-month intervals so as to determine the earth wire circuit resistance at different times of the year.

b) "Critical situations" could refer to structural facilities containing systems that are sensitive to interference or to office buildings, commercial properties or places where a large number of people may reside.

High flexibility

V-TEST II is powered by rechargeable batteries and is therefore independent of the mains supply. Its flexible use is particularly relevant, as surge protection components are usually distributed at different points in the system.

Consistent testing

V-TEST II tests all components used in surge protection devices. These include gas discharge tubes (GDT), metal oxide varistors (MOV) and transient voltage arresters Transient voltage suppressor (TVS) diodes.

**Automatic recognition**

The overvoltage protection variant is automatically detected by the V-TEST II. This leads to a reduction in operating errors. The measurement result has to be compared with the enclosed measurement value table. If the result is within the limit values, the tested component is OK.



VARITECTOR TEST II - Test device

- Portable, battery-operated testing instrument
- Supplied with flexible plug-in adapter
- Compact design with touchscreen operation



Technical data

Rated voltage
Degree of protection
Measuring range
Standards
Note

100...240 V AC
IP 20
U < 1500 V / I = 0.1; 0.5; 1 mA
IEC 61326-1, IEC 61010-1

Ordering data

Dimensions	
Height x Width x Depth	mm
Ordering data	
Type	
Order No.	
Qty.	
Note	

V-TEST II
205 x 220 x 82
V-TEST II
2661040000
1

V-TEST II Adapter

Replacement adapter for V-Test II

V-TEST II ADP



Technical data

Flammability class according to UL 94
Protection class
Moisture
Operating temperature
Depth x Width x Height

V-0
IP20
25...75 %, no condensation
0 °C...40 °C
60 x 109 x 52 mm

Hinweis

Hinweis

Ordering data

Hinweis

Type	Qty.	Order No.
V-TEST II ADP	1	2661050000

VSPC Locking Clip

The interlock mechanism on the VSPC Series pluggable arresters delivers extra reliability and an improved permanent contact under strong vibrating conditions.

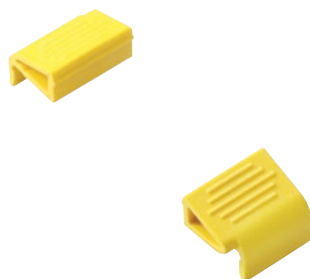
VSPC Locking Clip**Technical data**

Colour
Marking
Function
Weight
Note

yellow
Individually with a label
Removal with screwdriver
Snap-on by hand (press on)
10 g

Ordering data

Note

Type	Qty.	Order No.
VSPC LOCKING CLIP	100	1317340000

VSPC – cross connection

Cross-connection (QB) between the VSPC signal contacts can be installed quickly. Cross-connections can be individually separated for the alert function, with maximum of 10 VSPC R.

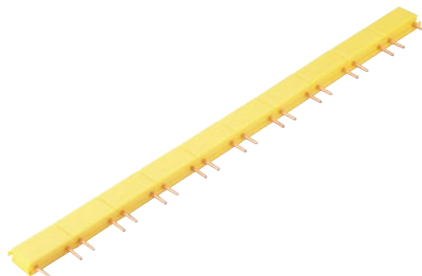
QB 17,8/2**Technical data**

Version
Dimensions (L x W x H)
Pitch
Rated current
Cross-section
Weight
Colour
Note

2-pole with 9 QBs together = 1 strip
9 mm (15.5 mm with contact) x 6 mm x 21 mm (9 QBs = 160.7 mm)
17.8 mm
17.5 A
1.5 mm ²
12.4 g/QB
yellow

Ordering data

Note

Type	Qty.	Order No.
QB 17.8/2	10 strips, with 9 QBs each	1309470000

V-TEST

Testing device from the VARITECTOR SPC series

A testing device for pluggable surge protection: for testing in compliance with the IEC 62305-3 standard

The V-TEST is a compact, easily carried, testing device for pluggable protection modules from the VARITECTOR SPC family. The testing device can be used to test the protective function of the overvoltage protection components in accordance with the test intervals required in IEC 62305-3.

It provides information regarding the functional status of the protective components.

The backlit display shows the measured reading per component (GDT, MOV, TAZ) as "OK" or "not OK".

This function allows you to detect ageing components as it highlights possible damage right away. Thus total protection is guaranteed.

The V-TEST is equipped with a charger and a battery set which allows autonomous use in the field. A comfortable and protective carry bag is delivered free with the tester.

Ensures timely testing intervals

The portable V-TEST can be used to carry out repeated testing in compliance with IEC 62305-3.

Lightning protection level	Visual inspection	Extensive check	Extensive check in critical situations ^{a), b)}
	Year	Year	Year
I und II	1	2	1
III und IV	2	4	1

a) Lightning protection systems for explosive structural facilities should be visually inspected every six months. The installation should be metrologically tested once per year. To obtain findings about the seasonal fluctuations, it is permissible to take measurements at 14 to 15-month intervals so as to determine the earth wire circuit resistance at different times of the year.

b) "Critical situations" could refer to structural facilities containing systems that are sensitive to interference or to office buildings, commercial properties or places where a large number of people may reside.

Quick and easy to operate

It only takes a few simple menu steps (in German or English) to navigate directly to the measurement function.



Always delivers precise readings

The V-TEST self-calibrates when it is turned on, ensuring that it can always deliver precise measurement and test values.

Portable

The compact device comes with an integrated rechargeable battery and protective case – making it perfect for use in the field.



MSR technology

V-TEST

- Testing device for testing the protective functions of the VARITECTOR SPC series
- Device for implementing the IEC 62305 standard (regarding periodic testing)
- Easy-to-use device with integrated battery set for on-site measurements
 - Result display via LCD display
 - Including protective bag and power supply
 - Intuitive user navigation in German and English

The V-TEST is a compact, portable test device for pluggable surge protection Varitector SPC (VSPC). Using this testing instrument, Weidmüller surge protection can be tested for their protective function in line with the testing schedules laid down in IEC 62305-3 (DIN VDE 185 part 3).

In a display with background illumination, the test result is indicated for each component with „OK“ or „Not OK“.



Technical data

Rated voltage	100...240 V AC
Accumulator set	8 NiMH with 2600 mA
Storage temperature	0 °C ... 40 °C
Ambient temperature (operational)	0 °C ... 40 °C
Degree of protection	IP 20
Measuring range	U < 1000 V / I = 1 mA
UL94 flammability class	V0

General tolerances of measurement range

Gas discharge tube	+/- 10%
Varistor	+/- 5%
TVS-diode	+/- 5%

Note

Ordering data

Dimensions	
Height x Width x Depth	mm
Ordering data	
Type	
Order No.	
Qty.	
Note	

V-TEST

230 x 122 x 65
V-TEST
8951860000
1
Note

Service and support

Service and support	Service connects - worldwide	V.2
	Engineering services and customised products	V.3
	easyConnect - Your Industrial Service Platform	V.4
	Support Center	V.6
	Additional support services	V.7
	Weidmüller Configurator: intuitive, uncomplicated & fast digital engineering	V.8
	Your digital ordering options at Weidmüller	V.10

Our expertise for your requirements

Service connects – worldwide



Automation technology functions are becoming more complex in a globally-oriented world facing ambitious targets in terms of energy efficiency and smart production. We are your equal partners for the best connections in Industrial Connectivity.

Our personal support answers all questions reliably and expertly. During planning, installation or operation our service and support offer is your best companion.

In short: Weidmüller's global service combines our expertise with your requirements.

V



Your way to our service
www.weidmueller.com/service

Engineering services and customised products

Automation engineering and connectivity consulting belongs to our services as well as assembly of engineered products. We also support the process from the idea to the product with our Weidmüller Configurator and the Configure-to-Order process.



Consulting and engineering

The challenge for you is reducing costs and increasing efficiency. This requires intelligent, individual solutions. Whether it is modified products, pre-fitted mounting rails or complete small cabinets – our application centres provide a highly qualified custom-made engineering and production service.



Connectivity Consulting

Increase your competitiveness - supported by our experts. Our drive is to optimise your competitiveness. That's why our team of experts supports you in significantly increasing your efficiency in electrical machine design and control cabinet construction. With proven products and services from the Weidmüller portfolio – and with the experience gained from over 300 projects worldwide.



Assembled terminal rails - Flexibly designed to suit your requirements

Your processes in panel building have to be fast, flexible and productive. This is the only way you can cut your costs and increase efficiency. Depending on the application in question, you will have different requirements with respect to the engineering service, delivery speed and flexibility to be provided.



Modified and assembled enclosures - Competitive advantages included

To compete internationally, your plants need to satisfy high standards of safety, quality and performance. The smart combination of consultation, application expertise and industry know-how is our key to finding a custom-fit solution for your application. Reduce costs and increase efficiency.

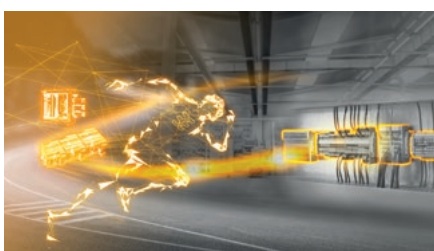

Fast Delivery Service - Your ideas deserve a quick realisation

Obtain offers 24/7 and within minutes, including directly orderable article numbers with our Fast Delivery Service. The Weidmüller Configurator (WMC) for planning and configuration is key for consistent processes. Dispatch your orders in 5 days. Assemble individual terminal strips and enclosures from batch size 1!

Your ticket to the world of digital service

easyConnect – Your Industrial Service Platform



Our cloud-based platform is your ticket to the world of digital services from Weidmüller, and the intuitive and future-proof tool for your way to the Industrial IoT. Realise your use cases easily, consistently and without any relevant prior knowledge, thanks to the perfect interaction of platform, devices and diverse software services.

As an open, modular and perfectly integrable system, the platform is your enabler for a wide range of use cases. Increase your efficiency and unleash your full innovation potential with easyConnect.

V



Interested in using easyConnect?

Learn how to get started with easyConnect step-by-step.

www.weidmueller.com/easyconnect

Why should you use easyConnect?

- You want to enter your digital transformation step-by-step?
- You want to make the step into Industrial IOT, but have no or little IT expertise?
- You want to use your digital data for smart & scalable services?
- You want to offer digital services (such as customised dashboard) to your customers?
- You want to improve your service offering and efficiency, e.g. through remote access?
- You feel Weidmüller’s digital services are interesting, but you have „your cloud“ already?



Weidmüller comes up with the solution: easyConnect, the new digitalisation platform. It bundles Weidmüller’s digital services at one place in the cloud and connects them with various Weidmüller devices.

With easyConnect you start digitalising your application step-by-step without ballast in a secure way.

The following services are initially available on easyConnect:

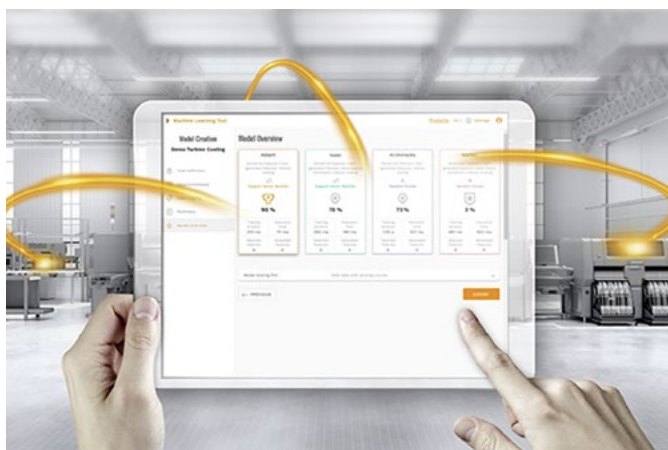

Device management

Adding and managing cloud-connected devices is typically the first step in any Industrial IoT use case.

Asset management

The asset management service is a modelling tool that allows users to model their assets and processes and link them to relevant time series data.

Remote access (u-link)

u-link guarantees a quick and secure access to machines and plants while also allowing for efficient management.

Data visualisation

easyConnect data visualisation services enable users to view, monitor and display live and historical data.

AutoML

With Weidmüller Industrial AutoML, you can optimize operations, increase product quality and develop new business models by benefiting from advanced analytics.

Expand the possibilities of our products

Our Support Center provides you with comprehensive, clear and personal assistance



Receive fast and intuitive support to get the most out of our products in your application. In our new Support Center you can search or navigate to the many application notes, product information, video tutorials or software downloads of our products.

- **Everything at a glance** – One central support hub, where all relevant information is available
- **Powerful search** – Provides filter functions for various types of information and products
- **Different views and navigations** – Content provided in views product information, engineering support or software downloads
- **More than 170,000 downloads** – Application notes, video tutorials, templates and examples, user documentation, engineering data, ...
- **Personal contact** – Direct access to your personal technical contact in your country



Explore the world of our new Support Center
support.weidmueller.com

Additional support services

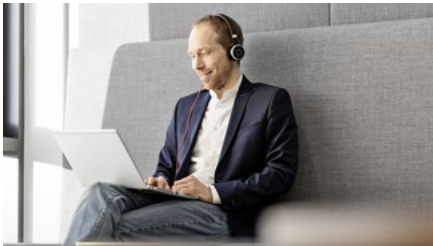

Training and Webinars

Stay tuned in a world that is accelerating. In our entertaining interactive webinars, we offer you the opportunity to learn about new products and technology topics and to interact with our experts.



Repairs and replacement parts

We offer repair and components for our Workplace Solutions as well as assistance for other Weidmüller products. Find out how our experts can help you with your repair request.



Security advisory board

Our Product Security Incident Response Team (PSIRT) continuously informs you about possible security-related vulnerabilities of our products.



Engineering data

For the quick integration of our products into your design, there are a lot of digital product data for engineering systems like EPLAN, Zuken E3.series, WSCAD and many others available for download.



Product change notifications

Technical modifications of our products always available online.



Technical product catalogues

Technical data for our entire program in Industrial Connectivity for download in PDF-format.

From the idea to the finished solution

Weidmüller Configurator: intuitive, uncomplicated & fast digital engineering

Digital engineering can be so easy – with the Weidmüller Configurator!

It's a **free to use** software application to easily configure industrial solutions. It features more than **12,000 articles** from multiple product families including rail-mounted components, industrial and ex-certified enclosures, Heavy Duty Connectors, remote I/O-systems and PCB connectors.

Unleash the full power of digital engineering:

Our application wizards help you choose the right articles.

Place, mark or modify them to your needs and get your solution **visualized in 3D** – what you see is what you get!

Our promise: Speed up your solution planning process by up to 70%!

Your benefits:

- **Proven configuration designs in real 3D:** The plausibility and collision check with the complete digital documentation ensures that you can rely 100% on your configuration.
- **Seamless E-CAD Roundtrip:** Interfaces enable the simple exchange of product data between the WMC and all common engineering tools, such as Zuken E3 or EPLAN Electric P8.
- **Sample Service & Fast Delivery Service:** to support your design-in process, we offer a **3-day sample service** for many products. Inquire them directly online – for free!
You want your solution right away? Our **Fast Delivery Service** guarantees delivery of individually assembled terminal strips or enclosures within a few days.

Get started online now!

The Weidmüller Configurator makes solution planning easy. Visit our website for more information, tutorials and download it for free:



www.weidmueller.com/wmc



or register on easyconnect.weidmueller.com and use it online.



Wizards:

Design complete applications within few clicks – even without detailed product knowledge – for signal wiring, load monitoring, instrument transformers, enclosures, remote I/O-systems and many more.

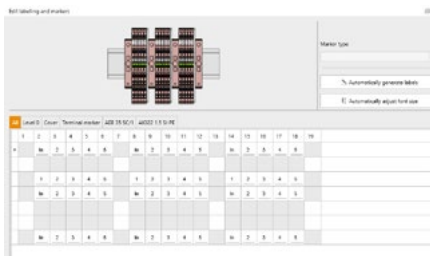

Assistants:

Finalize your solutions with supporting assistants to add cross-connectors, markers or colors and verify the faultlessness. Automatic modes save valuable time!



1-click documentation:

Get assembly drawings for production – only 1 click. Bill of material – only 1 click. The complete solution documentation including all component data sheets – you’re right, only 1 click!



Digital ordering options

Your digital ordering options at Weidmüller

Find and easily select the products you need, with convenient ordering: as your Partner in Industrial Connectivity, we know what counts in purchasing. That is why we offer you a variety of options for ordering products from us and optimising your purchasing processes to meet your individual requirements and your workflow. The choice is yours.

Order via the Weidmüller eShop

Our eShop offers you access to the complete Weidmüller product range around the clock – directly from a PC, tablet, or smartphone. The intuitive user guidance supports you as you select from over 50,000 products. Technical data, prices, and availabilities are available at any time. The shopping basket with check out function lets you place an order in seconds. Convenient additional functions like CSV upload, order history, reports, or custom order templates make your ordering processes even more efficient.

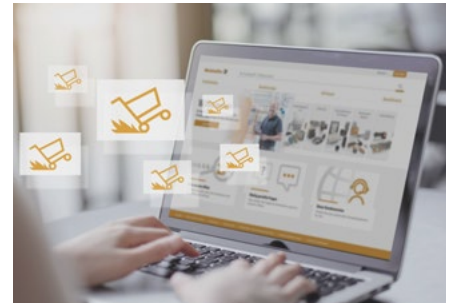

Order via the OCI interface

The Open Catalogue Interface (OCI) facilitates the exchange of data between your enterprise resource planning system and our eShop. This means that our eShop is integrated into your system via an OCI interface, so you have access to our complete product catalogue from your enterprise resource planning system. You can filter and select products, place them in your shopping basket and place direct orders without changing your software application. The open OCI standard is supported worldwide from a variety of software providers.

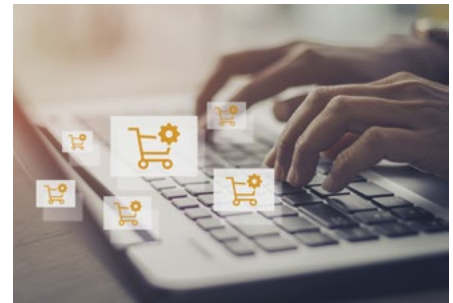

Order via the EDI interface

Our Electronic Data Interchange (EDI) also offers you the option of ordering our products directly from your enterprise resource planning system. All order data is transmitted automatically to our system and processed immediately. Orders, order confirmations, invoices, and delivery notices are transmitted lightning fast. This helps you make your purchasing processes even more efficient.



We will be glad to advise you on which solutions are suitable for you and how implementation is possible.

Get in touch with us

www.weidmueller.com/digital-order

The basics of lightning and surge protection

The basics of lightning and surge protection	The importance of lightning and surge protection	W.2
	What are surge voltages?	W.4
	How do surge voltages occur?	W.5
	How do we achieve surge protection?	W.8
	Surge protection concept	W.9
	Classification and protective zones	W.11
	Lightning protection levels	W.12
	Guidelines SEV 4022	W.13
	Network forms	W.14
	3+1 circuit: universal solution	W.16
	Important installation information	W.18
	Planning aids	W.24
	Office building with lightning protection	W.26
	Industrial building with lightning protection	W.27
	Components for Surge protection	W.28
	Test criteria	W.31
	Electromagnetic compatibility	W.32
	Questions and answers concerning surge protection	W.34
	Summary of standards and regulations	W.37

The importance of lightning and surge protection



Cost-effective strategies demand an investment in surge protection. Such an investment would only be a fraction of the amount of possible damage. The shut down of a manufacturing plant because of the failure of a controller or the collapse of industrial data transmission can be very costly. But the significant overhead in repairing the problem is not the only factor. You must also take into account the system down times. The lifespan of your components (mean time between failure) will also be shortened.

Surge voltages present a significant danger and this can be demonstrated in many other ways than the examples given in damage statistics from property insurers.

All electrical equipment is potentially threatened by surge voltages: this includes free-standing high-voltage switching facilities and also electronic micro-components. For low voltages, this risk is predominant in the fields of power supply, measure and control technology, telecommunications, and data transmission. We therefore work with protective strategies and systems when designing lightning and surge protection. Only an entire system can provide effective protection for all areas of power, signals and data and we offer an ideal form of surge protection for all these applications fields.

Surge protection has become an area of increasing significance. On the one hand, electrical and electronic components continue to get smaller. On the other hand, the levels of automation in the industrial and consumer electronics sectors are continuing to rise.

The safety clearances for insulation decrease as do the tolerance limits. Electronic circuits function at low voltage levels of only several hundred volts. Thus surge voltages can present a significant danger.

The German "Law on electromagnetic compatibility in devices" establishes the proper EMC-compliant design and layout for electrical and electronic devices.

Surge protection is an element of these EMC measures and implementation of this protection is described in a variety of IEC/VDE standards. Such measures can also help in obtaining the CE mark of approval.

To guarantee the safety of consumers, different product standards offer a method for ensuring a global product standard.

Causes of surge voltage	Protection measures described in			Installation of protective devices described in
	DIN V ENV 61024-1	DIN VDE 0185-103	DIN VDE 0100-443	DIN VDE 0100-534
Direct lightning strike	X	X		X
Remote lightning strike		X	X	X
Lightning fields		X		X
Switching operations			X	X



For energy protection, these is IEC 61643-11. For protection of measurement and control systems, IEC 61643-21 is relevant. These standards provide the rules which are globally valid for all manufacturers of surge protection components.

The standards also provide helpful support for users. IEC 61643-12 is valid for the installation of energy-protection components and IEC 61643-22 is valid when protecting measurement and control systems. IEC 62305 is the overall guideline for all applications when dealing with lightning and surge protection. This standard covers all the parameters: risk analysis, external and internal lightning protection.

The subject of surge protection is rather complicated and requires special knowledge. Therefore, this catalogue provides you with some helpful information. And if you want to know more, simply contact us. We are happy to help and advise you.

What are overvoltages?

What are surge voltages?

Surges are extremely high voltages that damage or even completely destroy insulation and hence impair or completely disrupt the function of electrical and electronic components of all kinds.

Every electrical component is provided with insulation to isolate the electrical voltage from earth or other voltage-carrying parts. The insulation strength is dependent on the rated voltage and the type of electrical component, as stipulated by the IEC/VDE regulations. It is tested by applying the prescribed voltages for a defined period of time.

If the test voltage is exceeded in operation, the safety effect of the insulation is no longer guaranteed. The component can be damaged or completely ruined. Surges are voltage pulses that are higher than the test voltage, and these could detrimentally affect an electrical component or system. This means that components with a high rated voltage may be capable of withstanding a surge voltage. But components with a lower rated voltage would be very much at risk from the same surge. An overvoltage allowable in an electric motor can spell disaster for an electronic circuit!

Permanently higher voltages also occur with the 50/60 Hz mains frequency. These voltage can be coupled and can also occur as a result of faulty switching operations. The resulting continuous interference voltages are another reason for installing overvoltage protection.

Individual surge pulses, which have a high frequency because of their physical formation, have a current rise that is about ten thousand times steeper compared with 50 Hz voltage. If the current rise time in the 50/60 Hz range is 5 ms, then for an overvoltage it is around 1 μ s.

These surges are designated as “transient” voltages. This means that they are short-lived, temporary oscillations. Their shape and frequency depends on the impedance of the circuit.

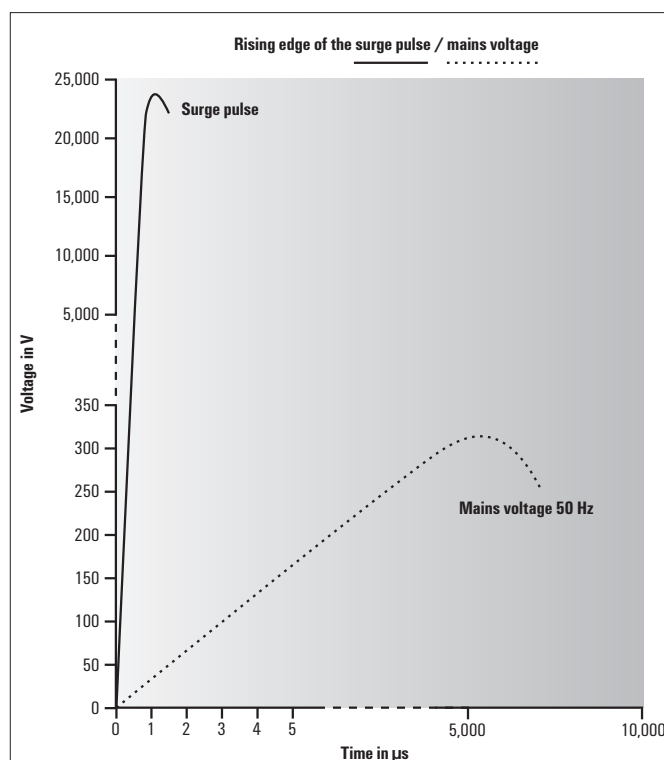

Edge behaviour between a 50 Hz sine wave and surge pulse

How do surge voltages occur?

Surges are primarily caused by:

- Transient switching operations
- Lightning due to atmospheric discharges
- Electrostatic discharges
- Faulty switching operations

Lightning

Bolts of lightning comprise extremely high currents. They can cause a large voltage drop and a large rise in potential, even in well-earthed buildings or systems, despite low earthing resistances.

This can then result in a galvanic, inductive or capacitive coupling of surge voltages within the circuits of electrical or electronic facilities. Any insulation will also be penetrated. So, in reality, there are no electrical isolation methods which provide reliable protection against surge voltages. Analogue converters, relays or opto modules are important for separating potentials, but they are definitely not surge protection components.

A natural lightning strike consists of a main discharge and a time-shifted post discharge. The strength of this second discharge is usually far below the energy level of the main discharge. Both discharges, however, have enough power to cause significant damage.

Our table below shows results from a natural lightning strike and a lightning current generator which simulates a lightning pulse.

The various forms of coupling must be considered in order to understand the effects of lightning.

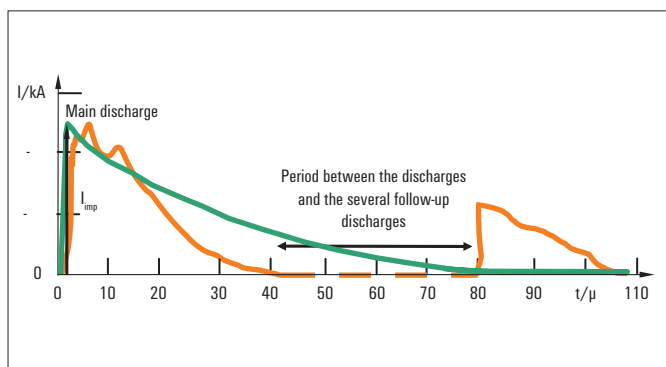

The discharge curve of natural lightning (red) and a simulated lightning strike from lightning current generator (green)

Conductive coupling

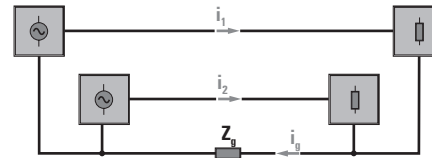

Surges are transferred directly into circuits via common earthing impedances. The magnitude of the overvoltage depends on the amperage of the lightning and the earthing conditions. The frequency and the wave behaviour are mainly determined by the inductance and the speed of the current rise. Even distant lightning strikes can lead to overvoltages in the form of travelling waves, which affect different parts of electrical systems by way of conductive coupling

Inductive coupling

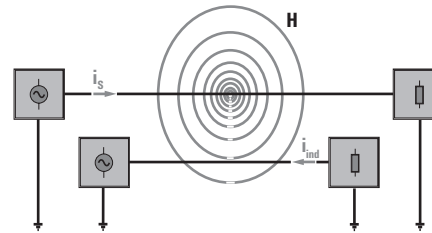

A high-amperage lightning strike generates a strong magnetic field. Starting from here, overvoltages reach nearby circuits by means of an induction effect (e.g. directly earthed conductor, power supply lines, data lines, etc.). According to the transformer principle, the coupling of induced voltages is considerable owing to the high-frequency current di/dt – even when primary and secondary windings consist of only a single winding each, i.e. the inductance is low.

Capacitive coupling

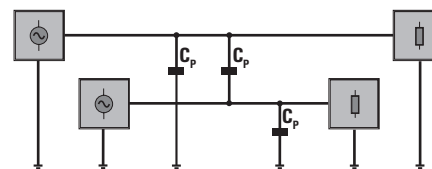

A capacitive coupling of overvoltages is also possible. The high voltage of the lightning generates an electric field with a high field strength. The transport of electrons can cause a capacitive decay to circuits with lower potentials and raise the potential concerned to an overvoltage level.

How do overvoltages occur?

Radiation coupling

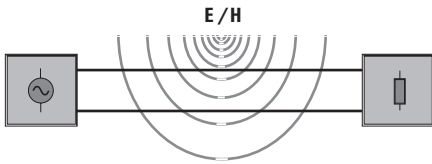

Electromagnetic wave fields (E/H field), that also ensue during lightning (distant field condition, E/H field vectors perpendicular to each other), affect conductor structures in such a way that coupled overvoltages must be expected even without direct lightning strikes. Permanent wave fields from strong transmitters are also able to cause coupled interference voltages in lines and circuits.

Switching operations – transients

More often, it is switching operations that cause interference rather than lightning. High-amperage shutdowns in the mains in particular can generate considerable overvoltages (e. g. welding equipment). Switching operations generate overvoltages because, due to their construction, switching contacts that switch the current on or off do not operate in synchronisation with the current zero of an alternating current. This means that in the majority of cases there is a very rapid change of current, from a high value to zero (di/dt). Owing to the impedances in the circuit concerned, this leads to transient overvoltages with high-frequency oscillations and high voltage peaks. These can reach electrical components by conductive, inductive or capacitive means and endanger or damage them. The situation is similar in the case of short-circuits in the mains because these also represent a rapid switching operation.

Electrostatic discharges – ESD

Electrostatic discharges (ESD) caused by frictional charges are well known. You can experience them when getting out of a car or walking across a carpet. These discharges can be over 10,000 volts in strength. We speak of ESD when these discharge to a lower potential. If such a charge strikes, for example, electronic components, then these can be completely ruined. Special care is taken, for example, with ESD issues when manufacturing electronic circuit boards.

Faulty switching operations

Again and again, we experience faulty switching operations in the 50/60 Hz mains. These can be caused by a failed power supply unit controller or incorrect wiring in a panel. The relatively high voltages that can occur as a result also represent dangerous overvoltages. Protection against these is vital.

Description of interference voltages

Surge voltages that occur between live conductors, or between a live conductor and the neutral conductor, are called transverse voltage or symmetric interference [UQ].

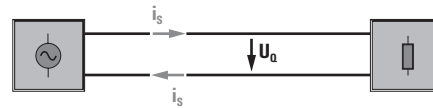

Surge voltages that occur between a live conductor and the PE conductor are called longitudinal voltage or asymmetric interference [UL].

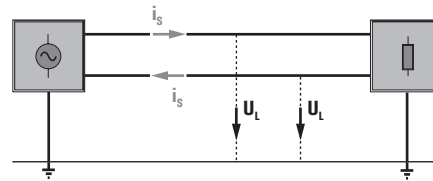

The forms of interference voltage

Coupled transient surge voltages are basically either symmetric (differential-mode interference) or asymmetric (common-mode) interferences, which are measured as longitudinal or transverse voltages.

Normal-mode interference (symmetrical interference)

A voltage between supply and return conductor, differential mode voltage/current. Occurs mainly at low interference frequencies in the existing lines. The interference current causes an interference voltage U_0 directly at the interference sink (between the input terminals). With galvanic or inductive coupling, both the effective sources and the interference sources are connected serially. The load and interference sources are connected in series as an inductive (magnetic field) or conductive coupling (common impedance). In symmetrical circuits (non-earthed or virtual potential earthed), the normal-mode interference occurs as symmetrical voltages.

In unsymmetrical circuits (earthed one side), the normal-mode interference occurs as unsymmetrical voltages.



Transverse voltage U_Q (normal-mode voltage)

This is a transient coupled interference between two active conductors. For asymmetric circuits with ground potential, the transverse voltage is equal to the longitudinal voltage [$U_Q = U_L$].

A remedy or limitation may be achieved by twisting the corresponding wires together and shielding or multiple shielding with cable sheath. This reduces the induction of transverse voltages.

Common-mode interference
(unsymmetrical interference)

Voltage between conductor and reference potential (earth), common-mode voltage/current. Mainly caused by a capacitive coupling (electrical field).

Therefore, significant common-mode interference currents only flow at higher interference frequencies. The interference voltage at the potentially susceptible device is caused by different voltage drops at the supply and return conductors (in each case between input terminal and reference earth). The source of interference can be between a signal wire and reference conductor increase in reference potential between separate earths.

In symmetrical circuits, common-mode interference occurs as asymmetrical voltages between the d.c. offset of the circuit and the reference earth. The forward and return conductors have the same interference voltages compared to the reference ground. In unsymmetrical circuits, common-mode interference occurs as unsymmetrical voltages between the individual conductors and the reference earth.

Longitudinal voltage U_L (common-mode voltage)

A coupled transient interference voltage between an active conductor and the earth potential. As a rule, the longitudinal voltage is higher than the transverse voltage (transverse voltage is lower owing to cable shielding and twisting). Longitudinal voltages caused by lightning currents on cable shielding can assume quite high values, especially in the case of long lines entering a building from the outside.

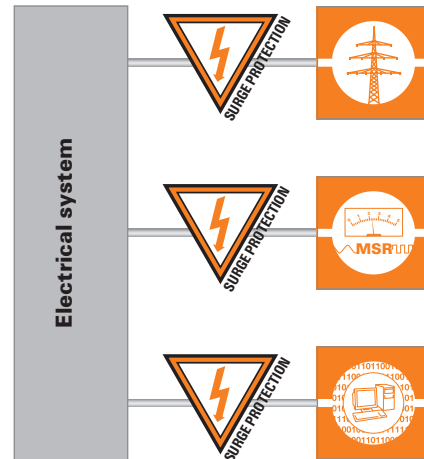

Consequences

The impedances and stray capacitances are equal in ideal circuits. This means that the currents in the supply and return conductors generated by coupled overvoltages are also equal and so do not generate any interference voltage. However, in practice the impedances and stray capacitances in the supply and return conductors are different. This results in unequal currents which cause different voltages to earth in the supply and return conductors.

This means that the unequal impedances lead to the common-mode voltage becoming, for the most part, a normal-mode voltage because of the dissimilarity in the voltages to earth of the supply and return conductors.

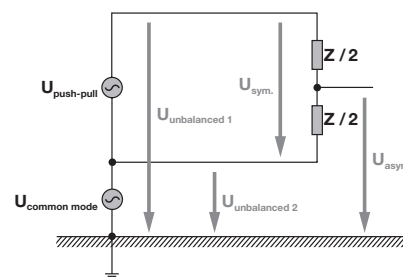

How do we achieve surge protection?

We have to consider surge protection from two points of view:

- General protective measures during the planning and construction of buildings and electrical installations.
- Special protective measures realised by the installation of additional surge protection components.

Planning buildings and electrical installations

Some primary measures to prevent or limit surge voltage damages can be incorporated into buildings and electrical/electronic facilities right from the start. Although such measures can achieve only basic protection, they can save some of the costs involved when it comes to planning an effective, complete protection concept. Beginning with the first phase of construction, it is very important to set up an earthing or equipotential bonding facility of sufficient size. Only this will ensure full equipotential bonding in the event of a malfunction.

Thus when speaking of lightning protection, we only refer to lightning protection equipotential bonding. All cables are connected to the lightning protection equipotential bonding: including the power supply, measurement and control signals, telephone lines, and even the water and gas lines. When planning the electrical installation, care must be taken to ensure that electrical systems with dissimilar rated voltages are kept separate. Corresponding protection zones can then be set up and this leads to cost-savings in the surge protection.

Furthermore, the physical separation or shielding of lines that can influence each other is a good way to achieve maximum electrical isolation. Another good option is to split up the individual phases of three-phase systems corresponding to their functions, e.g. one phase only for the supply to instrumentation and control systems.

Of course, all these primary measures do not achieve complete protection. To do this, you must install additional protective components.

Surge protection components

Surge voltages are kept away from at-risk electrical components by first reducing them to a harmless dimension before they reach the components.

The quick reaction times of surge arresters are used to provide this protection. They must respond during the high-frequency rising phase of the overvoltage, i.e. before a dangerous value has been reached, and quench the overvoltage. The response time lies in the nanoseconds range.

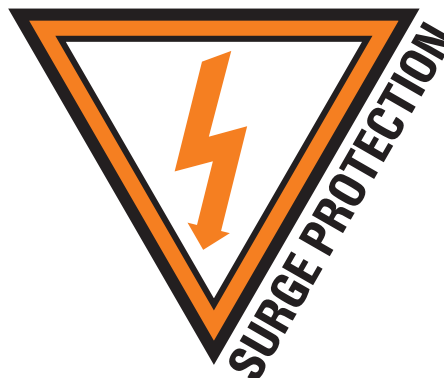

Naturally the surge protection components must be able to withstand very high currents, since a surge can, under certain circumstances, deliver several thousand amperes. At the same time, no excessive (i.e., dangerous) residual voltages should remain, even if the operating current is very high. So surge protection components must exhibit a very low resistance discharge behaviour.

In addition, it is absolutely essential that the surge protection component is very quickly available again in electrical terms after the surge has been quenched by earthing it. This is necessary to ensure that the function of the circuit is guaranteed.

Good surge protection is characterised by:

- Fast response behaviour
- High current-carrying capacity
- Low residual voltage
- Good reactivation time

Weidmüller can supply protective components that fulfil these criteria. Depending on the application, these usually consist of a combination of individual components, as described in the chapter on surge components.

Which combination of protective components is available for the respective application is described in the chapters A, B and C.

It will become clearer, from the set-up of the protective elements, how and where a product is used.

The first protection mechanism is always installed at the building entrance, so that the initial coupling interference can be directly "intercepted" before the sensitive end devices.

Surge protection concept

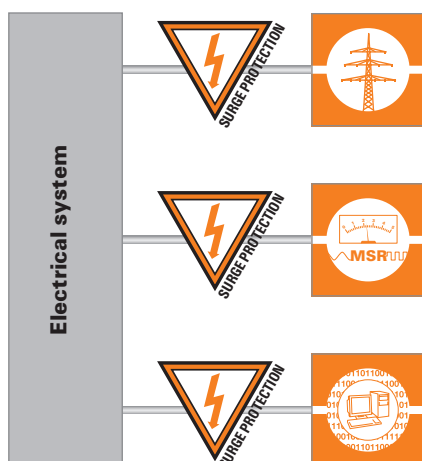

A fundamental requirement for effective surge protection is the presence of properly functioning equipotential bonding to DIN VDE 0100 part 540 in a series, or better still, star or grid arrangement.

DIN VDE 0110 (insulation coordination) divides overvoltage protection for power supplies and power distribution into the following three areas:

1. Power supply

The surge voltage strength of the insulation is 6 kV from the incoming supply to the building – by means of underground cables or overhead lines – right up to the main distribution board (backup fuse and meter cupboard). Owing to the lightning protection zoning concept and the physical circumstances, high-energy overvoltages have to be discharged here.

Fundamental concept of protection

One important aspect of surge protection is the area of power supply and distribution. The procedure is linked to the systematic subdivision prescribed by the protective zones concept and the corresponding coordination of surge arresters. Protection of power supply lines forms the basis for protecting all electrical and electronic equipment right down to the smallest and most sensitive components.

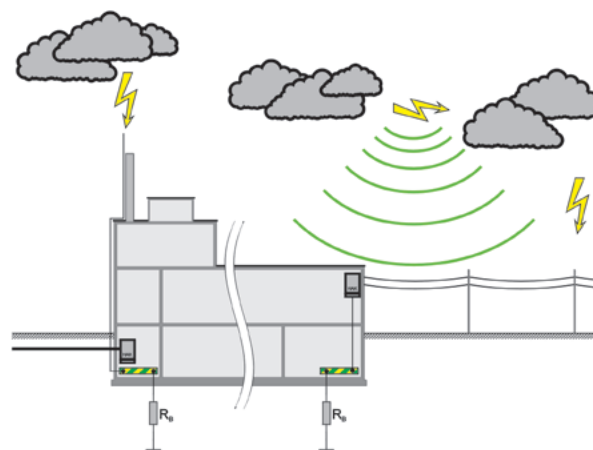

Surge currents exceeding 200 kA can be generated by cloud-to-ground but also cloud-to-cloud lightning discharges.

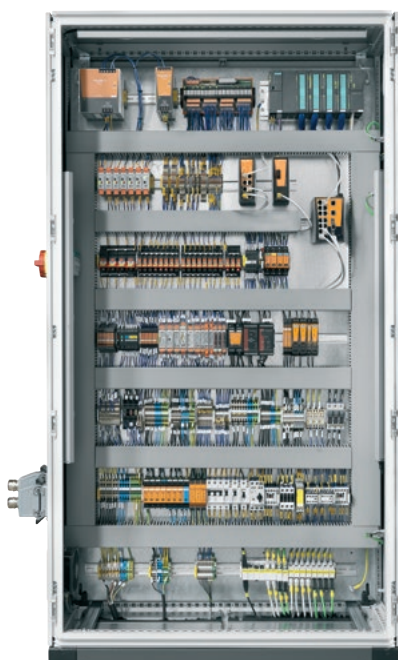

As a rule, 50 % of the current is discharged via the lightning protection system and the remaining 50 % is coupled into the conductors and conductive parts in the building and distributed uniformly. The closer a conductor is to the lightning protection system, the greater is the launched voltage (which can exceed 100 kV). The pulse duration can be up to 0.5 ms. These powerful interference pulses are discharged to earth directly at the incoming supply or main distribution board by Type I lightning arresters and limited to voltages below 6 kV. Power follow currents and backup fuse values are just some of the aspects that need to be taken into account here.

Depending on the local circumstances and the discharge currents to be expected, sparkover gaps or varistor surge arresters are used, taking into account the type of network.

Surge protection concept

If a lightning protection system has been installed, or the power supply is via overhead lines, or buildings or plants are spread over a wide area and individual buildings are sited on elevated ground or open areas, high-capacity Type I arresters should always be employed.

2. Subdistribution

The surge voltage strength of the insulation is 4 kV from the main distribution board up to and including subdistribution boards. Owing to the co-ordinated use of arresters, Type II surge arresters are used here. The use of decoupling coils is only necessary when the Type I arresters consist of one sparkover gap and the length of the line between the Type I and Type II arresters is less than 10 m.

It is not necessary to decouple Weidmüller Type I and Type II arresters. The pulse currents that occur here are no longer that high because most of the energy has already been absorbed by the Type I arresters. Nevertheless, the line impedances give rise to high interference voltages which must be limited to less than 4 kV by the Type II arresters.

Type II arresters based on varistors are normally installed in the subdistribution board before the residual-current circuit-breakers.

3. Terminals, consumers, sockets

The surge voltage strength of the insulation is 2.5 kV from the subdistribution board to the electrical consumer. Surge arresters in Type III are used for this purpose. Depending on the application, they can be used as protective components or in composite switching together with gas discharge tubes, varistors, suppressor diodes and decoupling elements. These arresters are best installed directly before the device to be protected. This can be in a socket or trailing socket (on extension lead) but also in the terminal or junction box of the device itself.

To protect against permanent interference such as "ripples" or "noise" caused by other systems, additional filter circuits are available for the voltage supplies to devices. The insulation of the electrical consumer itself has a surge voltage strength of 1.5 kV.

Principle for selecting arresters according to IEC 60664-1 (DIN VDE 0110-1)

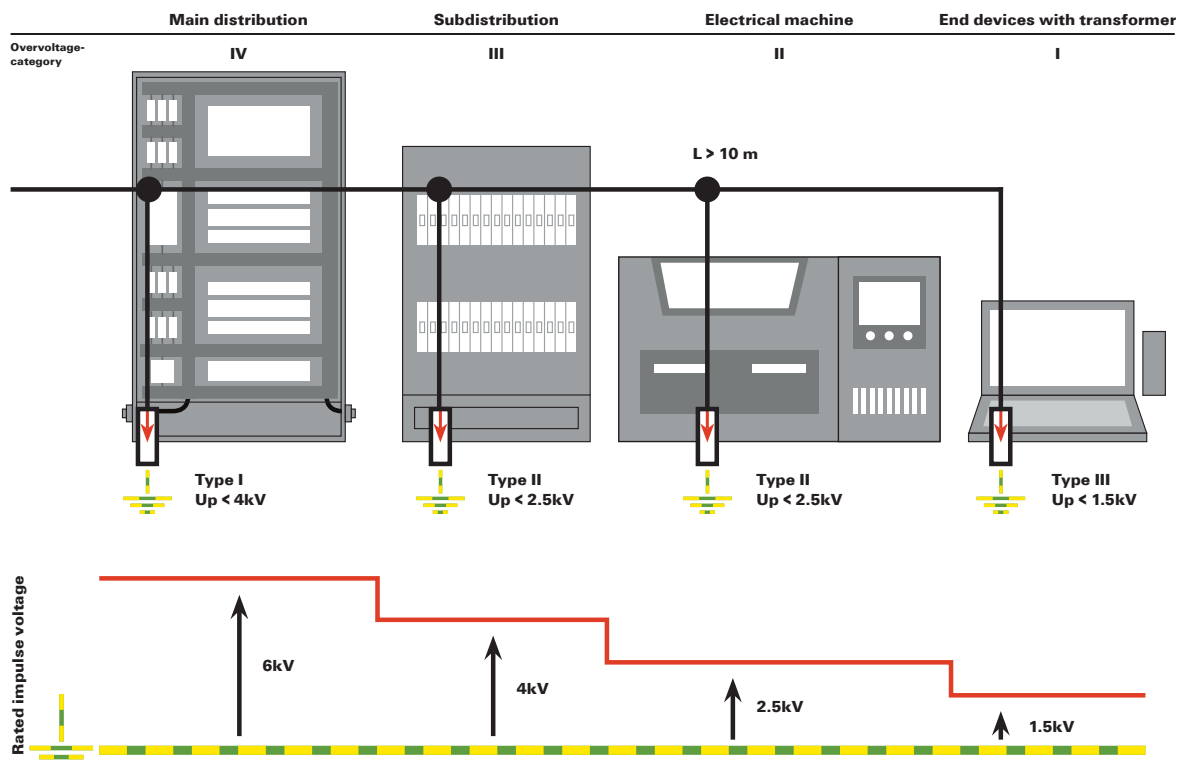

Classification and protective zones

The requirements placed on surge protection and the necessary tests for surge protection components are stipulated by national and international standards. A product can only be considered safe after the product has been fully tested.

For rated voltages up to 1000 V AC, the standards are valid for the manufacturers of surge protection devices and the installers of the surge protection within the facility or system. This catalogue contains a list of valid standards for your reference.

The insulation coordination for electrical equipment in low-voltage systems to IIV EN 60664-1 (IEC 60664-1) is critical for the design of a surge protection solution. This specifies different dielectric strengths within electrical systems. Based on this, individual lightning protection zones can be set up according to IEC/EN 62305-3.

Lightning protection zones

A protective zone is characterised by a fully earthed envelope. In other words, it has an enclosing shield which enables full equipotential bonding. This shielding can be formed by building materials such as metal facades or metal reinforcements. Lines that pass through this shield must be protected with arresters in such a way that a prescribed protection level is achieved. Further protective zones can be set up inside such a protective zone. Additional protective zones that only have to be fused below the higher-level protection zone's insulation strength can be set up inside such a protective zone.

This leads to a co-ordinated protection level for the objects to be protected. Not every individual section has to be protected with the maximum protection level (e.g. against lightning). Instead, the individual protective zones guarantee that a certain overvoltage level is not exceeded and hence cannot infiltrate that zone.

This leads to economic protection concepts with respect to the capital outlay for protective components.

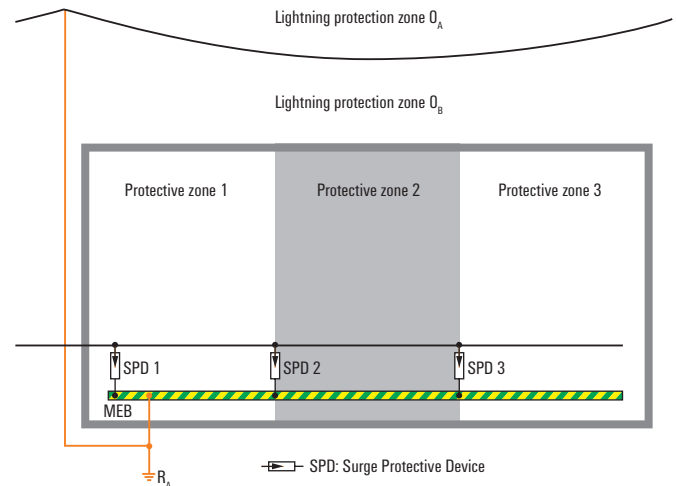

Classification

Originally, the arrestors were classified according to coarse, medium and fine protection. These arrestors were designated classes B, C and D in DIN VDE 0675 Part 6 / A1. There was also a class A for external arrestors (e.g. for low-voltage overhead lines); however, this class has now been abolished. IEC 61643-11 classifies the protective zones as Types I, II and III.

Comparison of surge protection classifications. Many national standards, e.g. in Austria, are derived from the aforementioned VDE or IEC standards.

Formerly DIN VDE 0675 Part 6/A1	Today IEC 61643-11
Arrestors of requirements class B, lightning protection equipotential bonding to DIN VDE 0185 part 1 ("B arrestors")	"Type I" arrestors
Arrestors of requirements class C, surge protection in permanent installations, surge withstand voltage category (surge cat.) III ("C arrestors")	"Type II" arrestors
Arrestors of requirements class D, surge protection in mobile/permanent installations, surge withstand voltage category (surge cat.) II ("D arrestors")	"Type III" arrestors

At Weidmüller, we make sure that all our surge protection products are tested by an independent testing lab for compliance with the relevant product standards. This is documented by test reports and corresponding test certificates.

Lightning protection levels

Lightning protection levels (LPL)

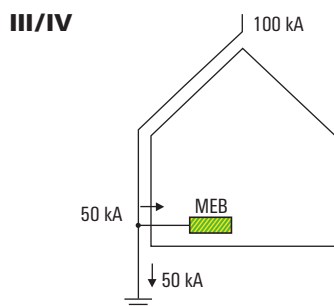
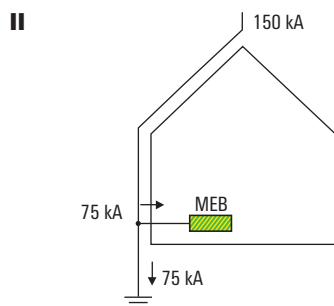
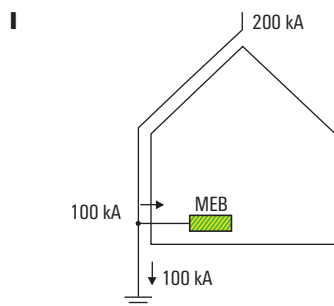

The lightning protection level applies only to the pulse current 10/350 or to Type I.

Lightning protection level I

Lightning protection level I covers a pulse of 200 kA. This is the worst-case scenario of a direct strike. This pertains to external lightning protection facilities.

Half of this pulse is conducted to the earth and the other half is conducted to the section of the facility that is conductive. If only a four-wire system is available, then a current of 25 kA is distributed to each wire. For a five-wire system, that would correspond to 20 kA.

This lightning protection level I covers multiple areas, including: petrochemical facilities (Ex-zones) and explosive material depots.

Lightning protection level II

Lightning protection level II covers a pulse of 150 kA. This pertains to external lightning protection facilities. Half of this pulse is conducted to the earth and the other half is conducted to that section of the facility that is conductive. If only a four-wire system is available, then a current of 19 kA is distributed to each wire. For a five-wire system, that would correspond to 15 kA.

This lightning protection level II covers multiple areas, including: parts of hospitals, shipping warehouses with fire alarm systems and telecommunication towers.

Lightning protection level III/IV

Lightning protection level III/IV covers a pulse of 100 kA. This pertains to external lightning protection facilities. Half of this pulse is conducted to the earth and the other half is conducted to that section of the facility that is conductive. If only a four-wire system is available, then a current of 12.5 kA is distributed to each wire. For a five-wire system, that calculates to 10 kA. The 12.5 kA value is also used here. About 80% of all applications are covered by lightning protection level III/IV. This includes houses, homes, administrative buildings, industrial facilities and so on.



Table 2.2.1
Buildings requiring lightning protection, lightning protection levels, control intervals

Building, facility, zone, areas	Lightning protection level	Control intervals (years)
<p>a Buildings that have rooms with a large number of occupants (e.g. theatres, concert halls, dance halls, cinemas, multi-purpose sporting/exhibition arenas, retail stores, restaurants, churches, schools, transportation facilities such as railway stations and similar sites of public assembly, including the associated buildings, which can be adversely affected by a lightning strike);</p> <p>Note Especially multi-purpose sports/exhibition arenas, theatres, cinemas, restaurants and similar sites with rooms where there could be 100 or more persons; sales sites with a total sales area of less than 1,200 m², if the calculated number exceeds 100 persons, sales sites with a total sales area of more than 1,200 m².</p>	II	10
<p>b Accommodation facilities (e.g. hotels, nursing homes, institutions, hospitals, prisons, military barracks);</p> <p>Note Especially hospitals, nursing homes where there are permanently or temporarily 10 or more persons who depend on outside help; especially hotels, inns and boarding houses where there are permanently or temporarily 15 or more persons that do not depend on outside help.</p>	II	10
<p>c Particularly tall buildings, including the adjoining buildings of normal height; high-rise buildings used as residential and commercial buildings, high chimneys and towers (church steeples).</p> <p>Note Buildings which are considered tall according to building legislation or where the top floor is more than 22 metres above the surrounding terrain serviced by firemen or where the eaves have a height of more than 25 metres.</p>	III II	10 10
d Buildings made from combustible materials with a total volume of more than 3,000 m ³ ;	III	10
e Large agricultural and operational buildings (more than 3,000 m ³) including the adjoining silos and adjacent residential buildings which could be adversely affected by a lightning strike; fermenting facilities or biogas plants;	III	10
f Industrial and commercial buildings in high-risk areas (such as plants and equipment where flammable or explosive materials are handled or stored), wood processing factories, mills, chemical plants, textile and plastics factories, explosives and ammunition depots, pipelines, gas stations;	II - I	10 - 3
<ul style="list-style-type: none"> - Areas at risk of fire - Explosion-risk zones under a roof 	II I	10 3
g Containers for flammable or explosive substances (such as flammable liquids or gases), warehouses for solid or liquid fuels and associated buildings and facilities (e.g. machine buildings, gas stations, storage buildings with filling equipment);		
h Buildings and facilities which house content with special value items (e.g. archives, museums, collections);	II	10
i Buildings and facilities which house sensitive technical equipment (e.g. IT and telecommunications facilities); Data centres;	II	10
j Buildings and installations in exposed topographic positions (e.g. free-standing building [alpine huts] in the mountains	III - I	10 - 3

Extract from the guidelines of the SEV 4022 Lightning Protection Systems 2008; please follow the installation regulations and standards in the individual countries.

W



Network forms to DIN VDE 0100-100 (IEC 60364-1)

The letters in this table describe the earthing conditions:

1st letter Earthing at current source	2nd letter Earthing of exposed conductive parts of electrical installation	3rd letter Routing of N and PE conductor (only applies to TN systems)
T- Direct earthing of current source (of transformer)	T- Exposed conductive parts of electrical installation are earthed directly	C- "Combined" N conductor and PE conductor are routed together as PEN conductor from current source into electrical installation
I- Insulated structure of current source	N- Exposed conductive parts of electrical installation are connected to earth of current source	S- "Separate" N conductor and PE conductor are routed separately from current source to exposed conductive parts of electrical installation

Four-conductor systems:

Still valid according to VDE but unfavourable for information technology systems from the point of view of EMC (VDE 0100-444 / -540).

TN-C systems ("classic earthing")

Neutral conductor and protective earth conductor functions are combined throughout the network in a single conductor, the PEN conductor.

TN-C-S systems ("modern earthing")

Neutral conductor, PEN conductor and equipotential bonding system are connected once at the main distribution board or after the incoming supply to the building. Therefore, a TN-C system becomes a TN-S system (TN-C-S system) from this point onwards.

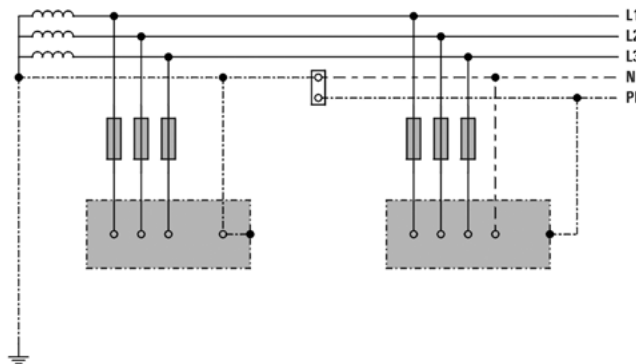
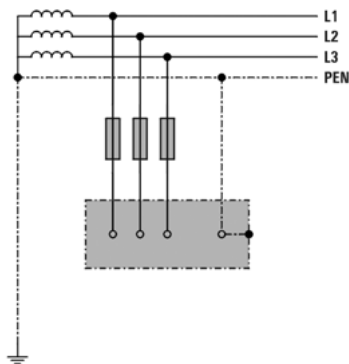

W



Five-conductor systems:

The neutral point of the supply source is earthed (N and PE). Both conductors must be laid separately and insulated from the incoming supply onwards. In these systems the PE (protective earth conductor) does not carry any operating current but instead only discharge currents.

TN-S systems

Neutral conductor and protective earth conductor are separated throughout the network.

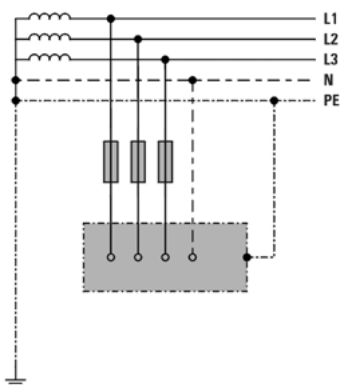

TT systems

One point is earthed directly (operational earth). The exposed conductive parts of the electrical installation are connected to earth lines separate from the operational earth.

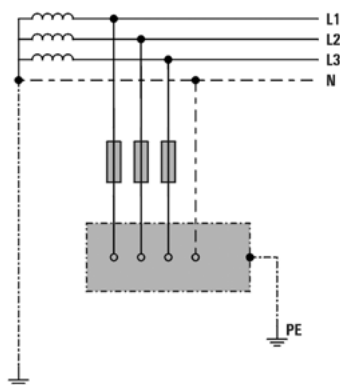

Special system:

Used, for example, in medical applications

IT systems

There is no direct connection between active conductors and earthed parts. The exposed conductive parts of the electrical installation are earthed.

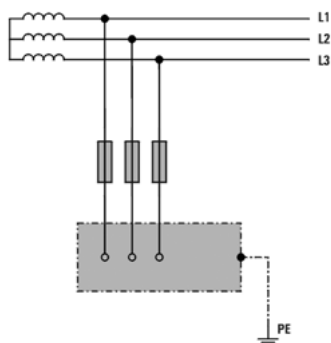

Surge protection with 3+1 circuitry in consumer loads with TT power systems

3+1 does not always equal 4! At least not in the case of protective circuits with arresters in a TT system.

In a TT system the supply is via the three phase conductors L1, L2 and L3 and the neutral conductor N, i.e. without an additional integral PE conductor. The equipotential bonding is then made separately within the consumer installation through the earthing. The outcome of this is that the neutral conductor can accommodate a higher voltage compared to the earth potential. Therefore, to protect against overvoltages between neutral conductor and earth potential, an arrester must be incorporated here as well.

The "four-arrester circuit" does not satisfy all safety aspects. Up to now, four arresters, i.e. one each between earth potential and L1, L2, L3 and N, were installed in consumer installations with TT systems. However, this "four-arrester circuit" is no longer regarded as the optimum solution because the physical characteristics of the varistors used may lead to unacceptably high touch voltages at the PE conductor in the consumer installation. Depending on the age of the system, leakage currents can flow through varistors and cause overvoltages via the earthing resistance.

The downstream RCD-(Fi) circuit breaker found in TT systems cannot detect such leakage currents. Therefore it cannot trigger. Furthermore, a failed, i.e. low-resistance, varistor would create a connection between N and PE. One remedy is to install an arrester disconnecter in sequence with the varistors. But an arrester disconnecter that monitors the varistors takes up space and costs extra.

If instead of varistors, sparkover gaps were to be arranged between the conductors and the equipotential bonding, then that, too, would not be an ideal solution. The longer time to sparkover and the characteristics of the sparkover gaps result in higher residual voltages.

The 3+1 circuit includes varistors with the three L conductors and the N conductor, and a sparkover gap between the base of the three varistors at the N conductor and the equipotential bonding rail (PE). The size of the sparkover gap must be such that it can accommodate the total current of the three phase conductors and the neutral conductor. The sparkover voltage of the sparkover gap in 230 V systems should be 1.5...2 kV.

TN-S system

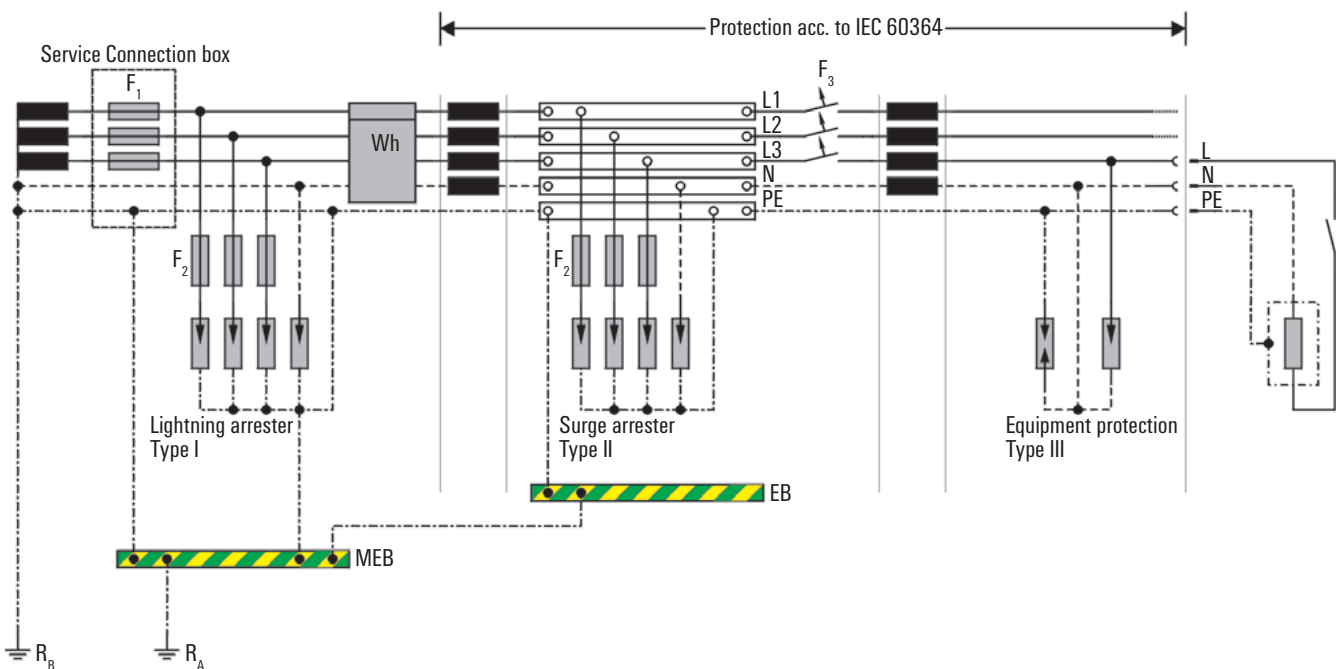

The sparkover gap isolates the three varistors electrically from the PE so that leakage currents through the varistors cannot cause voltage increases at the PE. The residual-current circuit-breaker behind the 3+1 circuit then provides reliable protection against hazardous touch voltages in all situations.

In terms of its relevance for safety aspects, the 3+1 circuit described in VDE 0100 part 534 (section 534.2.2) (HD 60364-5-534) can therefore be regarded as a solution for surge protection in TT systems.

Note: Although the "four-arrester circuit", i.e. with one varistor each between earth potential and L1, L2, L3 and N, is prescribed in VDE 0100 part 534 (section 524.2.1) for consumer installations in TN-S systems, the 3+1 circuit would also be possible here without increasing the risk.

TT system

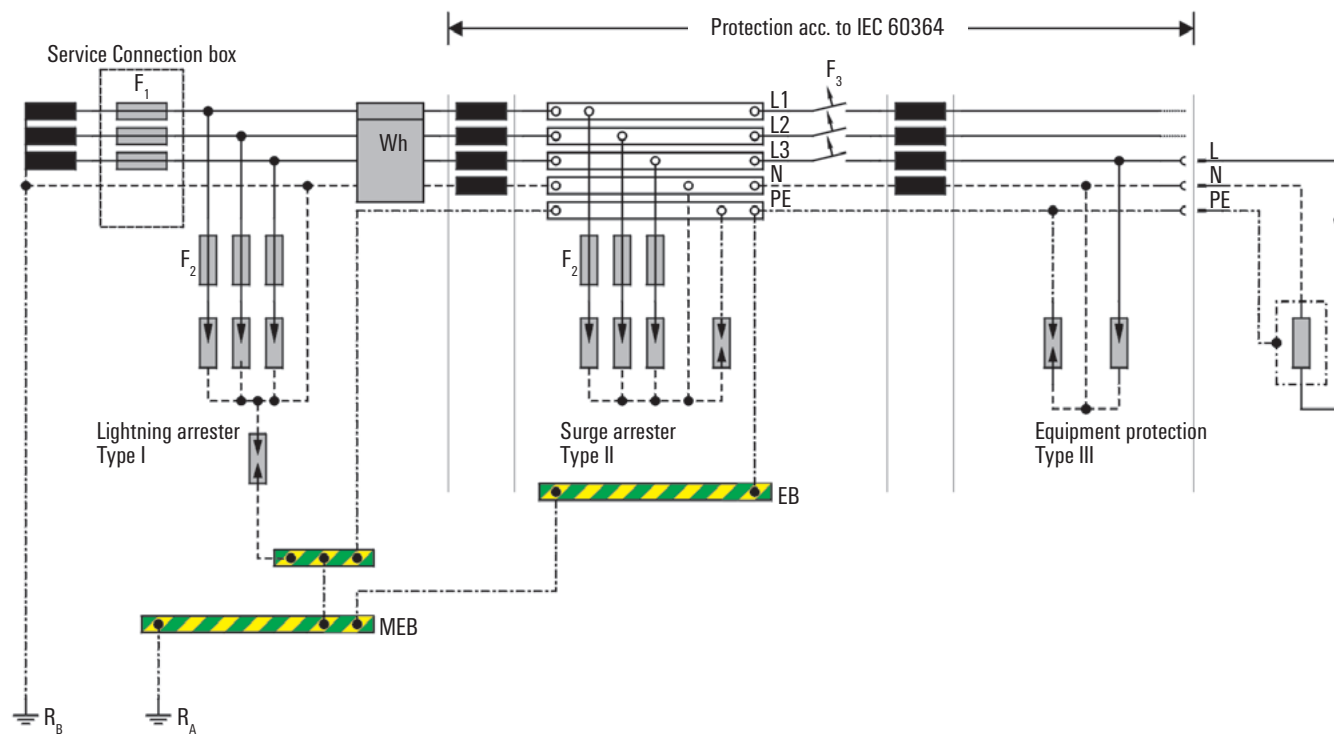

Important installation information

Lightning and Surge Protection (SPD = Surge Protective Device) must only be installed, put into operation and maintained by qualified electricians who are familiar with national and international laws, provisions and standards.

During installation, the national regulations and safety instructions in accordance with IEC 60364-5-53 or DIN VDE 0100-534, as well as country-specific standards and application-relevant standards / rules must be observed. It is forbidden to install an SPD after an RCD (Residual Current Device).

Never install a damaged or otherwise defective VPU AC II surge protection module. If the status window is red, the device must be replaced by a specialist. Do not open the surge protection module.

During an insulation test, the SPDs must be disconnected from the system for the entirety of the measurement, e. g. by pulling the pluggable arrester or completely disconnecting the product from the network.

For this purpose, Weidmüller offers special information sticker for the control cabinet (order no. 1287670000). After the insulation test, the arrester that matches the nominal voltage must be reinstalled. Incorrect insertion of the wrong arrester is prevented by voltage-dependent coding elements.



- New: Individuals - e.g., in residential buildings and small offices when surge category I or II equipment (e.g., household appliances, portable tools, and sensitive electronic equipment) is installed in these buildings.

As a result of this revised standard, surge protection must now be installed in all newly planned buildings, i.e. private residential construction, residential building communities, functional buildings, etc.

Another important requirement of the new regulation states that as soon as an overhead power line is routed to or near the building, surge protection (Type I) must be installed.

For the first time, self-generated switching surges are also considered in the standard. Self-generated switching surges can be generated by the following devices:

- Switching high inductive, capacitive loads such as air conditioners, inverters, elevators, etc.
- Switching high load currents such as instantaneous water heaters, corridor lighting, crane systems, charging stations for e-mobiles, etc.
- Connection of a generator feed, CHP, etc.

How lightning and surge protection has to be installed is described in DIN VDE 0100-534 (IEC 60364-5-53).

The most important installation instructions for installing SPDs are explained below:

1. Installation locations
2. Line connection and line routing
3. Cable lengths and effective protection area
4. Cable cross-sections
5. Fuse protection of SPDs
6. Status display and function control

W With the new regulation of DIN VDE 0100-443 (IEC 60364-4-44), the installation of surge protective devices in Germany is now also required for transient overvoltages that have an effect on:

- New: Large gatherings of people - e.g. in large (residential) buildings, churches, schools and offices.

1. Installation locations

Type I arresters are required by standard as soon as the building has external lightning protection or an overhead line feed. In this case, a type I arrester (VPU I) must be installed in the main distribution / infeed before or after the electricity meter. It should be noted, however, that only leakage current-free arresters are permitted for installations in front of the electricity meter. You can recognize these arresters by the designation „LCF - Leakage Current Free“ in the product name.

Furthermore, in Germany, the application rules VDE-AR-N 4100 must be observed when connecting and operating customer installations to the low-voltage network.

Type II arresters are installed in the main distribution if the building has no external lightning protection and no overhead line feed. In this case, installation is only allowed after the electricity meter. In addition, type II arresters are installed in sub-distribution boards or distribution boards.

Type III arresters are installed directly in front of the end device to be protected, if required. There are both DIN rail solutions and products that can be installed directly behind the socket in the cable duct.

In general, SPDs are always installed where the lines and cables enter the control cabinet. This is usually the lowest mounting rail, directly above the cable entries. This prevents

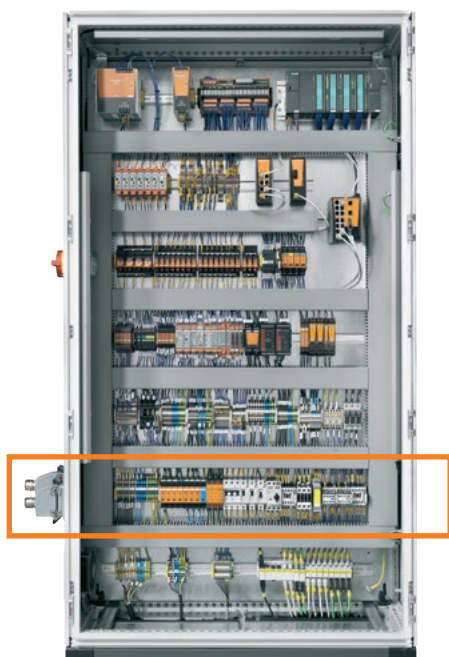

interference from being coupled into the control cabinet. The interference is diverted right at the beginning of the control cabinet. If shielded cables are used, they can be connected via the Weidmüller clamping bracket.

2. Line connection and line routing

All SPDs have a ground connection terminal. The ground line of the associated equipotential bonding rail must be connected to this terminal. The ground line must be as short as possible with the largest possible cross-section, since every centimeter of line length increases the residual voltage of the SPD (rule of thumb: 1 m line = 1 kV voltage drop). For type I arresters, both ground connection terminals must be connected. In this case, one line leads to the equipotential bonding terminal of the building and the second line must be connected to the PE conductor of the installation.

In addition to the ground connection terminal, the SPDs from the I&C range offer the option of establishing grounding via a mounting rail contact to the DIN rail (TS 35). To achieve optimum grounding, the mounting rail should be mounted on a grounded metal backplane. It is advantageous to ground the I&C SPDs and the mounting rail every 60 cm. In addition, SPDs for I&C applications have a protected side and an unprotected side. This is indicated on the printing and must be taken into account when connecting the cables.

For external status monitoring, product variants with „R“ in the product name offer a remote signalling contact. The status information is designed as a changeover contact and is connected via terminals 11 and 14.

In normal operation (green status display), connection terminals 11/12 are closed and terminals 11/14 are open. In the event of a fault (red status display), terminals 11/14 are closed and 11/12 are open.

When **laying the lines**, unprotected and protected lines must be routed separately. The ground line is to be regarded as an unprotected line. If signal lines are laid parallel to power lines, a distance of at least 0.5 m must be maintained. Metallic cable ducts with a corresponding metallic cover and separators provide ideal shielding.

3. Cable lengths and effective protection area

The **length of the connecting leads** of an SPD are an essential and important factor for correct installation and functionality of the SPD. Due to the inductive conductor resistance, a voltage drop of several 1,000 V can quickly occur in the event of a transient overvoltage. This would degrade the effective protection level of the SPD to such an extent that the dielectric strength of the installation or the device to be protected would probably be exceeded despite the use of an SPD. In the worst case, the device could be damaged, destroyed or even a fire could be generated. For this reason, the standard requires a maximum cable length of the connecting lines of an SPD of ≤ 0.5 m. This can be realized by means of the so-called V-connection or a connection to the PE carried along.

Furthermore, the standard regulates the maximum permissible distance between an SPD and the device to be protected (**effective protected area**). Accordingly, the cable length should be ≤ 10 m. If this distance cannot be maintained, an additional SPD must be installed as close as possible to the device to be protected.

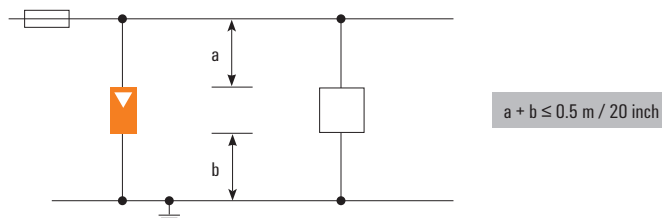

Branch wiring

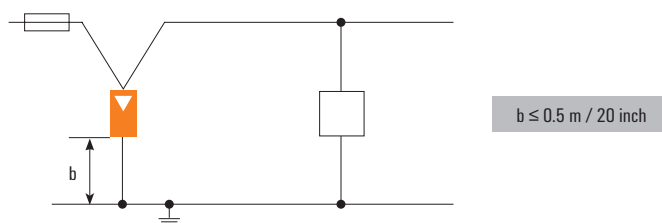

V-wiring

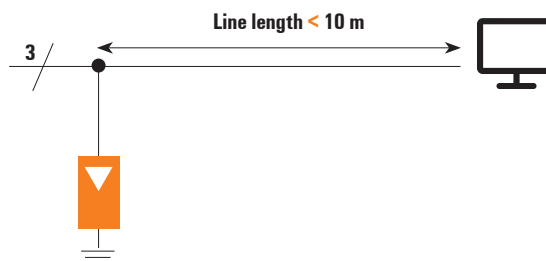
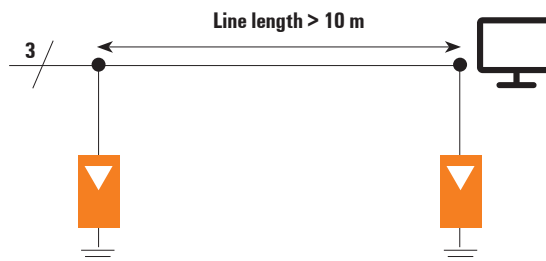

4. cable cross sections

As a rule, the same cable cross-section is selected for the connecting cables to the SPD as for the outer conductor (L1, L2, L3) and the neutral conductor (N).

The remote signalling contact (for variants with „R“ in the product name) is connected with a maximum cable cross-section of 1.5 mm²

IEC 60364-5-53 / VDE 0100-534 requires the minimum cable cross-sections shown in the table for type I and type II SPDs.

Type	Connection lines between SPD and line conductor	Connection lines between SPD and main grounding busbar or protective earth (PE or PEN)
I	6 mm ² Cu	16 mm ² Cu
II	2.5 mm ² Cu	6 mm ² Cu

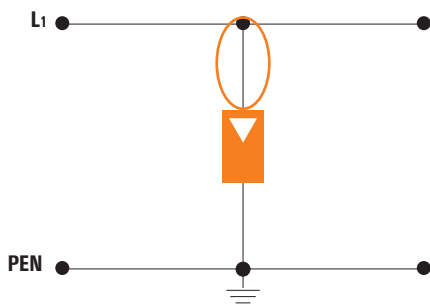

Line conductor wiring

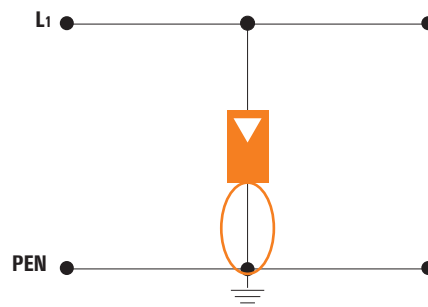

Protective earth wiring

5. Fuse protection of SPDs

SPDs behave like passive, non-conductive components in normal operation. Only in the event of an overvoltage or at the end of the life of the protective components does a current flow occur. SPDs must be protected against short circuit or overload by means of a fuse (F2) designed for the type of installation and the cross-section of the connected line. The fuses must be selected taking into account the rated currents shown in the installation instructions by the manufacturer of the SPD.

It must be ensured that the string fuse (F2) is actually also capable of carrying lightning currents and that the fuse is not selected too small so that the SPD is ineffective in the event of an overvoltage event.

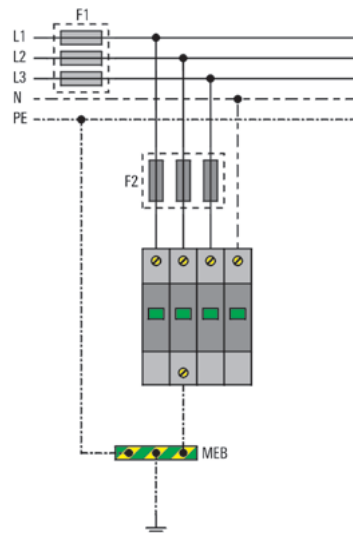

Fuse protection of SPDs

Important installation information

When dimensioning, it is important to use the maximum back-up fuse if possible. The figure clearly shows that the lightning current carrying capacity of the small fuses in particular is severely limited. Only the design according to the maximum value also offers the unrestricted protection by an SPD.

Nominal current and fuse ratings

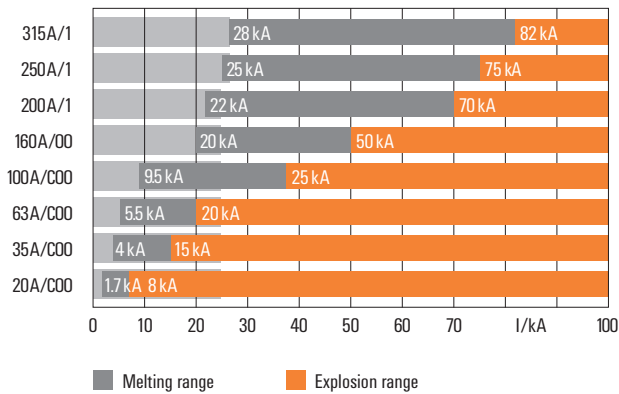

Behaviour of NH fuses under lightning impulse current (10/350 µs)

The VPU AC series can be operated up to a (main) fuse F1 of 315 A gG in the active conductor without additional back-up fuse F2. With this dimensioning, we recommend a conductor cross-section of 35 mm² for a short-circuit-proof installation.

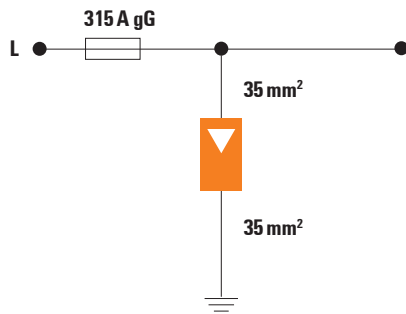

SPD wiring with 350 A main fuse

Notes:

- When using the VPU AC products in DC applications, please use the fuse from SIBA Type NH2XL aR/ aSF DC 1500 V.
- Instead of the fuse, an equivalent circuit breaker (MCB – Main Circuit Breaker) can also be used. If a circuit breaker or a main circuit breaker is used, the tripping

characteristics must be taken into account. Normatively, however, only one test is performed in combination of SPD and fuse.

SPD with integrated fuse

The **VPU AC F series** has an integrated fuse in the pluggable arrester. This simplifies planning and installation, since no additional back-up fuse F2 is required upstream of the SPD, regardless of the main fuse value F1 (even greater than 315 A). Both the state of the fuse and the state of the SPD are monitored here. The VPU AC F series is available in all multiple variants.

Lightning current strength of NH fuses for surge currents 10/350 µs

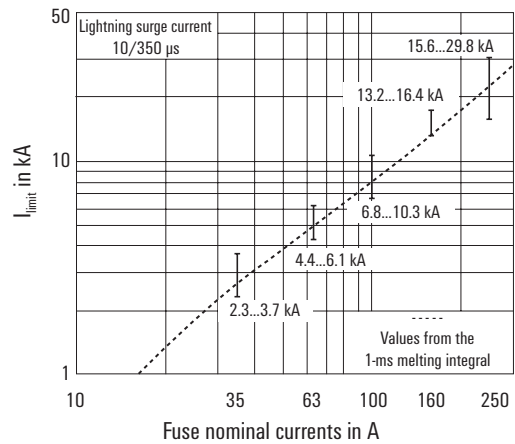

Lightning current strength of NH fuses for surge currents 8/20 µs

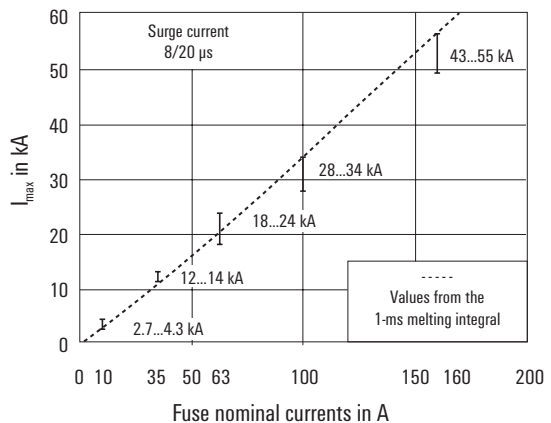

6. Status display and function control

All products of the VPU series have an optical **status display** which visualizes the function of the SPD. In addition, the functionality can also be passed on to a central control system via a remote signalling contact (for product variants with „R“ in the name).

In general, the full functionality of the SPD is given with a green status display. In case of a red status indication, the protective function of the SPD is no longer given and the arrester must be replaced by a qualified electrician.

Furthermore, there are individual product variants that also have a yellow status display (VPU AC II Y). This is a prewarning stage, i.e. the products have a redundant design. A yellow status display signals that the protective function of the SPD is still given, but that a possible failure will become possible with the next overvoltage. This means that the arrester can be replaced at an early stage during a regular service inspection.

The **function control** and test intervals are regulated in the lightning protection standard IEC/EN 62305-3. Depending on the protection class (LPL) of the application, a visual inspection must be performed annually or every two years. Furthermore, a comprehensive (technical) inspection of the SPDs must be performed at least every two or four years. For this purpose, all VPU AC modules can be functionally tested with the V-TEST II test instrument. In addition, the standard requires a visual inspection of all arresters after a thunderstorm event.

Ensures timely testing intervals

The portable V-TEST can be used to carry out repeated testing in compliance with IEC 62305-3.

DIN EN 63205-3 Bbl 3 (VDE 0185-305-3 Bbl 3): 2012-10

Largest time intervals between tests of lightning protection systems

Lightning protection level	Visual inspection	Extensive check	Extensive check in critical situations ^{a), b)}
	Year	Year	Year
I and II	1	2	1
III and IV	2	4	1

a) Lightning protection systems for explosive structural facilities should be visually inspected every six months. The installation should be metrologically tested once per year. To obtain findings about the seasonal fluctuations, it is permissible to take measurements at 14 to 15-month intervals so as to determine the earth wire circuit resistance at different times of the year.

b) "Critical situations" could refer to structural facilities containing systems that are sensitive to interference or to office buildings, commercial properties or places where a large number of people may reside.

Planning aids

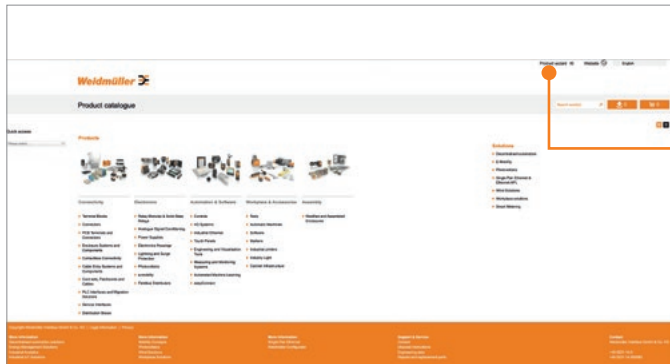

VPU product selection assistant

Simply and quickly find the suitable VPU products for your application using our product selection assistant. You will find the product selection assistant at galaxy.weidmueller.com.

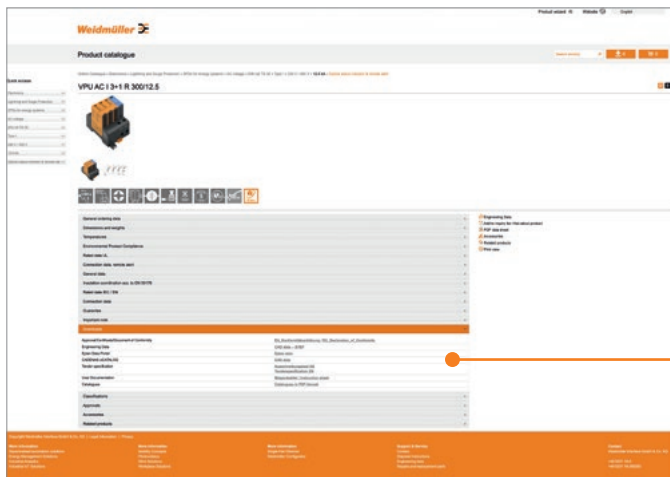
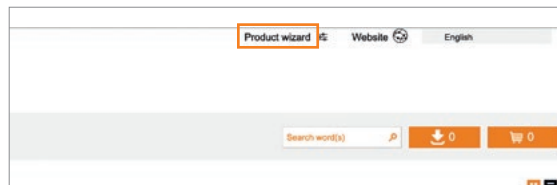

Tender specification sheets for surge protection

You will find current tender specification sheets at eshop.weidmueller.com. You are shown current specifications and data for your planning activities in the product view of the "Downloads" menu item.

Downloads	
Approval/Certificate/Document of Conformity	EU_Konformitätsklärung / EU_Declaration_of_Conformity
Engineering Data	CAD data - STEP
Edin Data Portal	Edin data
CADENAS eCATALOG	CAX data
Tender specification	Anschreibungsprotokoll DE Tenderspecification EN
User Documentation	Beleuchtungs- / Installationsanleitung
Catalogue	Catalogue in PDF format





Applications, installation positions: Application Office building

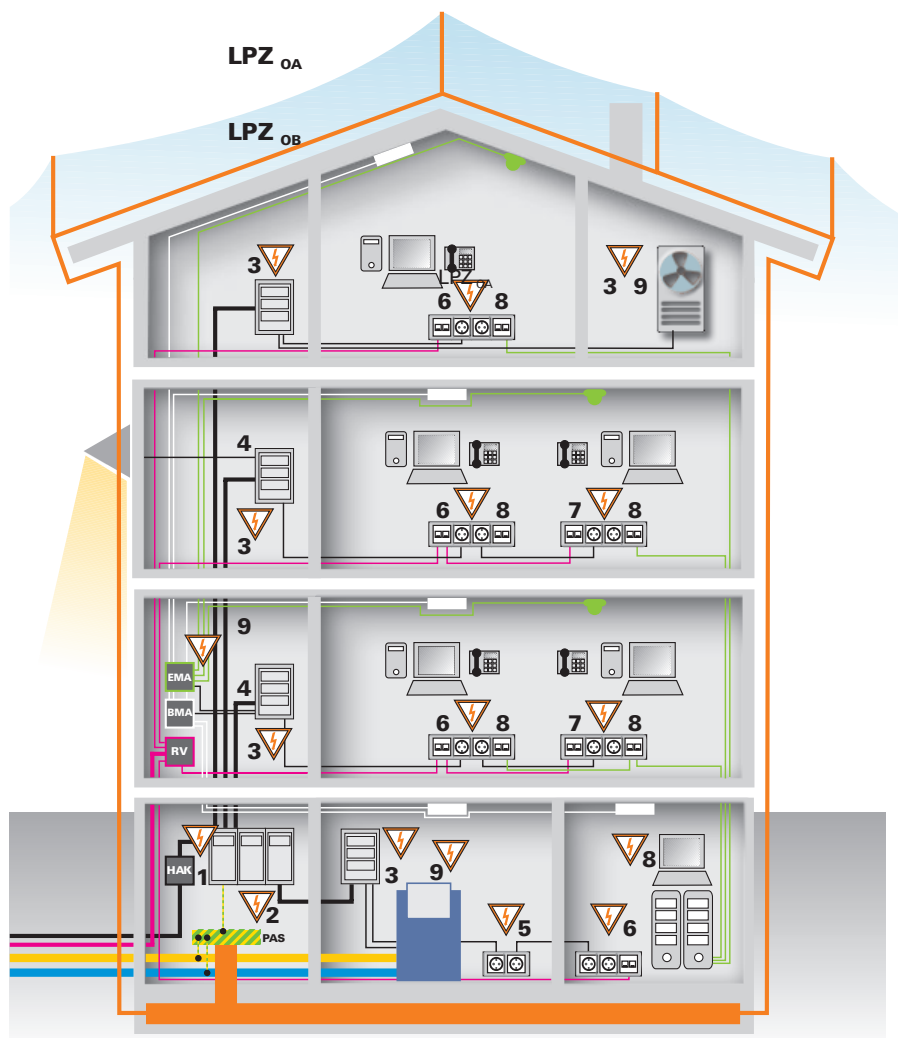

Power (low-voltage supply)

- 1 Type I Arresters with sparkover gaps with/without high-power varistors, VPU AC I S Line
- 2 Type I Arresters with high-power varistors, VPU AC I series
- 3 Type II Arresters with high-power varistors, VPU AC II series
- 4 Type III Arresters for installing in subdistribution boards, VPU III series
- 5 Type III Arresters in the form of plug-in surge protectors, VPU III SO

Data

- 8 Surge protection for data lines, e.g. VDATA for Ethernet CAT.6

Power and data

- 6 Type III Arrester VSPC
- 7 Type III Arrester VSPC

Instrumentation and control equipment

- 9 Surge protection for measurement and control circuits, e.g. VSPC or VSSC

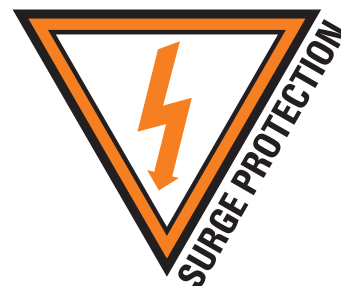

Applications, installation positions: Application Industrial building

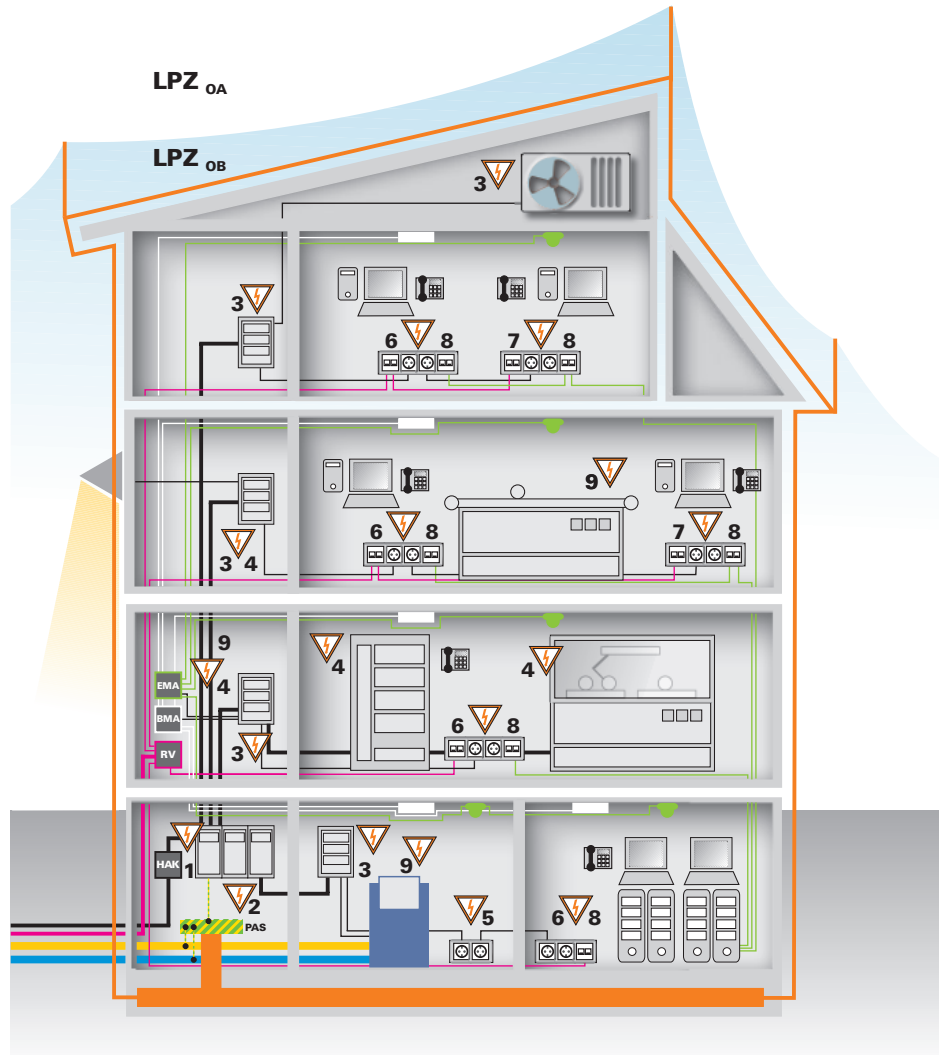

Standards

IEC/EN 61643-11, SPDs connected to low-voltage power distribution systems. According to this standard, all type I, type II and type III energy arresters (VPU) are tested.

IEC/EN 62305-1 until 4, Protection against lightning.

This lightning protection standard defines everything to do with internal and external lightning protection. It includes four sections:

- "Protection against Lightning – Part 1: General principles"
- "Protection against Lightning – Part 2: Risk management: assessing the damage risk for buildings and structures"
- "Protection against Lightning – Part 3: Physical damage to structures and life hazard"
- "Protection against Lightning – Part 4: Electrical and electronic systems within structures"

Regulations for installation

IEC 60364-5-53, Electrical installations of buildings – Part 5-53. (Content in VDE 0100-534). Standard for the installation of low-voltage facilities.

VDE 0800-2, **VDE 0839-6**, **VDE 0845** describe the selection and installation for communication electronics.

Guidelines for the SEV lightning protection system SN 4022 and the SEV 4113 foundation earth

Current
Telecom
Gas
Water

LPZ_{OA}

Unprotected area outside of the building. Direct lightning strike; no shielding against electro-magnetic interference.

LPZ_{OB}

Area protected by lightning protection system. No shielding against LEMP.

W



Components for Surge protection

Surge protection devices (SPDs)

There is no ideal component that can fulfil all the technical requirements of surge protection equally effectively. Instead, we use a variety of components with different physical methods of operation that complement each other; these possess distinct protective effects. Super-fast reaction time, high current-carrying capacity, low residual voltage and long service life cannot be found in one single component.

In practice we use three principal components:

1. Spark gaps (GDT)
2. Varistors (MOV)
3. Suppression diodes (TAZ)

Therefore, to optimise the surge protection solution, carefully matched groups of these components are often combined in one protective module.

1. Spark gaps / GDT



Possible types:
Blow-out spark gap
Encapsulated spark gap
Gas-filled spark gap

Pulse form shape without GDT

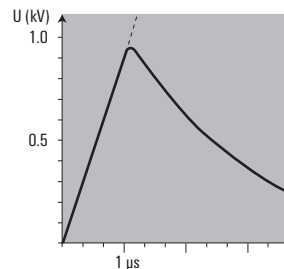

Pulse form shape with GDT

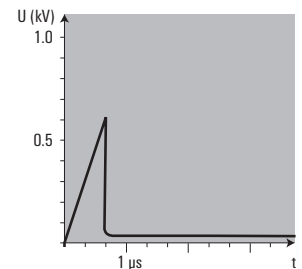

The name says it all. High voltages are discharged to earth via a spark gap (e.g. gas discharge tube) that has been fired. The discharge capacity of sparkover gaps is very high – up to 100 kA depending on type.

Gas sparkover gaps are incorporated in insulating glass or ceramic (aluminium oxide) housings. The electrodes of the sparkover gap are made from a special alloy and placed in housings which are vacuum sealed and filled with a noble gas such as argon or neon. They are aligned with respect to shape and clearance distance, so that the applied voltage produces a distribution of field strengths. This results in a fairly precise voltage value for the complete ignition of the spark gap. The housings are vacuum-tight and filled with an inert gas such as argon or neon. The spark gap has a bipolar function. The ignition voltage value, however, is dependent on the steepness of the applied surge voltage.

The ignition characteristic curve for gas-filled spark gaps reveals that the ignition voltages increase for those surge voltages which climb more steeply. The consequence is that, for very steep surge voltages, the ignition voltage (that is, the protection level) is relatively high and can be well in excess of the rated voltage for the spark gap (approx. 600–800 V). The problematic quenching behaviour of the fired sparkover gap can be a disadvantage. The arc has a very low voltage and is only extinguished when the value drops below this. Therefore, when designing the geometry of a sparkover gap, care is taken to ensure that – through long distances and also through cooling – the voltage of the arc remains as high as possible and so is quenched relatively quickly. Nevertheless, a longer follow current can ensue. This can draw its energy, in addition, from the incoming supply of the circuit to be protected. One effective solution is to wire a sparkover gap and a fast-acting fusible link in series.

2. Varistors / MOV

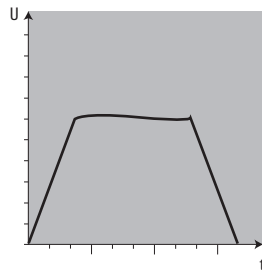
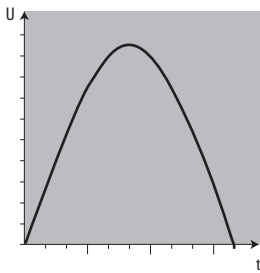

The varistors used with surge protection (MOV-Metal Oxide Varistors) have resistance which depends on the voltage. This is implemented with metal-oxide (zinc-oxide) discs. There is a low-ohm resistance in the range above the rated voltage. The surge voltage is limited since a current flows through the varistor. The varistor works bi-directionally. Depending on the type, varistors have either a middle or high discharging capacity. It is in the range from 40 kA to 80 kA. The response time is less than 25 ns. However there are also disadvantages when using varistors. Two factors that must be taken into account are the relatively high capacitance and the aging characteristics.

Leakage currents occur over time, depending on the frequency of the triggering, because individual resistance elements break down. This can cause temperature rise or even destroy them completely.

This is one reason for thermal fuses being built into Weidmüller products. The high capacity of the varistors is problematic for circuits with high frequencies. Some signal attenuation should be expected at frequencies above 100 kHz. We therefore recommend that they are not used in data transmission systems.

3. Suppression diodes / TAZ

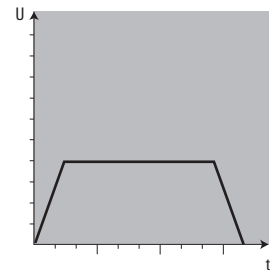
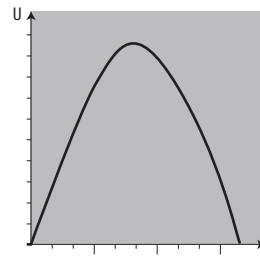

Suppressor diodes function in a similar fashion as Zener diodes. There are uni-directional and bi-directional versions. Uni-directional suppressor diodes are often used in DC circuits. Compared to standard Zener diodes, suppressor diodes have a higher current-carrying capacity and are significantly quicker. At a certain breakdown voltage level, they become conductive very quickly. They therefore discharge the surge voltage. However their current-carrying capacity is not very high. It is only a few hundred amps. Instead, they feature a very quick reaction time which lies in the picosecond range.

Unfortunately, suppression diodes possess a significant inherent capacitance. Therefore, like with varistors, their possible attenuation effect on high frequencies must be taken into account.

4. Combination circuits

Combining the components described above results in surge protection products that can match individual requirements. If a voltage pulse reaches the input of such a combination circuit, then the gas discharge tube is fired and discharges high current. The residual pulse is attenuated by a downstream inductance and subsequently received and limited by the varistor and/or suppression diode. If the gas discharge tube is not triggered, i.e. in the case of a slower voltage rise, then the pulse is discharged by the varistor or the suppression diode alone.

The sequence of the individual components results in an increasing response sensitivity towards the output. An interference voltage with a rise of $1 \text{ kV}/\mu\text{s}$ and a peak value of 10 kV at the input is limited by a gas-filled surge arrester to approx. $600\text{--}700 \text{ V}$. The second stage, decoupled from the first by means of an inductance, suppresses this value to approx. 100 V . This voltage pulse is then reduced to approx. 35 V (in a 24 V protective combination) by the suppression diode. Therefore, the downstream electronics need only be able to cope with a voltage pulse of approx. $1.5 \times U_B$.

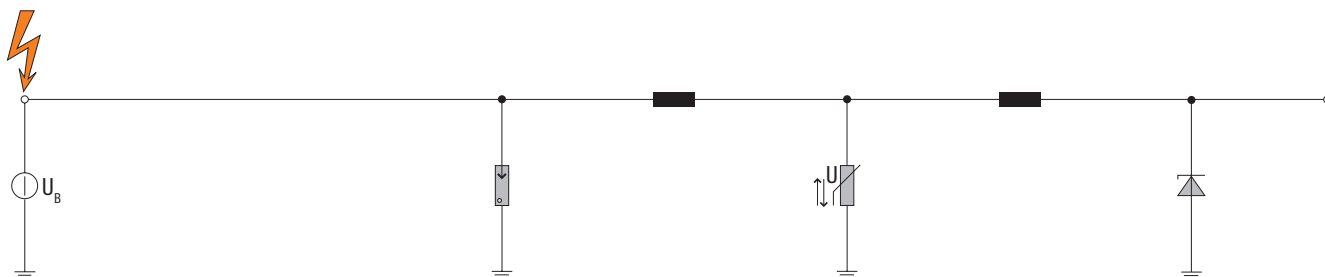
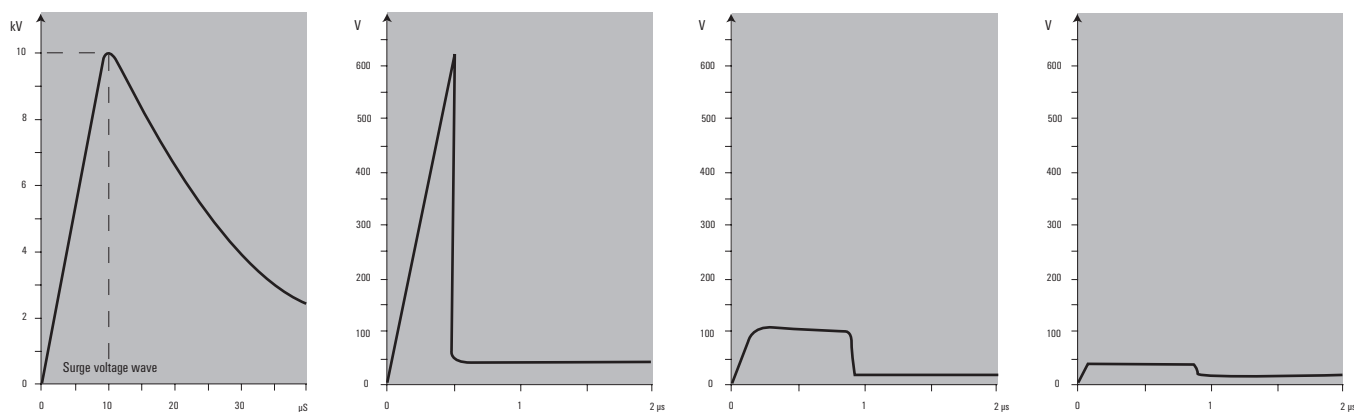

Test criteria

The classification is based on the experience that type I arresters could be overloaded under extremely high loads, and also on more recent investigations of lightning discharges. This resulted in the standardised form of the current curve 10/350 μ s for type I arresters under test. The test parameters are between 12.5 and 25 kA I_{peak} or I_{imp} . The specification „10/350 μ s“ means that the surge current has reached 90% of the maximum after 10 μ s and then drops to half its value after 350 μ s. The area under this curve corresponds to the current energy used for testing. Type II arresters (formerly „C“ arresters) are still tested with the current curve 8/20. The rated discharge current for our arresters is up to 75 kA for a 2-pole supply and up to 100 kA for a 4-pole supply. „Type III“ arresters (formerly „D“ arresters) are used for device protection. The test applies for them with a 2-Ohm hybrid surge current generator having a maximum

loading voltage of 0.1 kV to max. 20 kV, which, in the case of a short circuit delivers 0.05 kA to 10 kA for 8/20 μ s.

Classification	formerly		Test values	Application
	VDE IEC 0675	37A		
Coarse protection	B-arrester	Type I	$I_{imp} = 25$ kA 10/350 μ s curve	Protection against direct lightning strike (incoming supply, main distribution board, etc.)
Medium protection	C-arrester	Type II	single pole $I_{sp} = 20$ kA 8/20 μ s curve 3 or 4-pole $I_{sp} = 100$ kA 8/20 μ s curve	Protection for permanent installations (electricity distribution etc.)
Fine protection	D-arrester	Type III	$U_{oc} = 20$ kV max. $I_s = 10$ kA max. hybrid generator	Protection for devices (sockets etc.)

Relationship between 10/350 μ s and 8/20 μ s

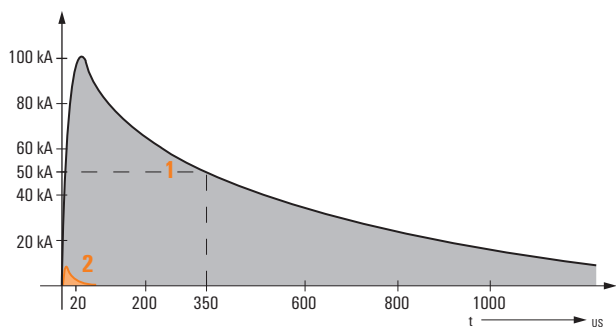

	1	2
Wave form [μ s]	10/350	8/20
I_{max} [kA]	100	5
Q [As]	50	0.1
W/R [J/ Ω]	$2.5 - 10^6$	$0.4 - 10^3$
Norm	DIN V VDE V 0185-1	DIN V VDE 0432 T.2

■ Simulated surge pulse 8/20 μ s
■ Simulated lightning impulse 10/350 μ s

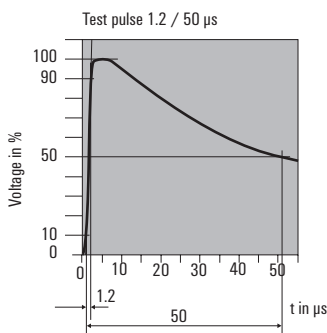
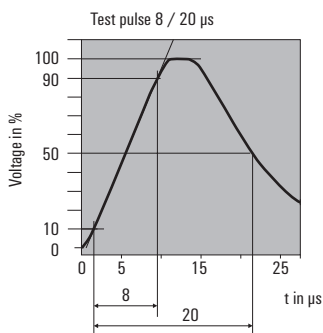
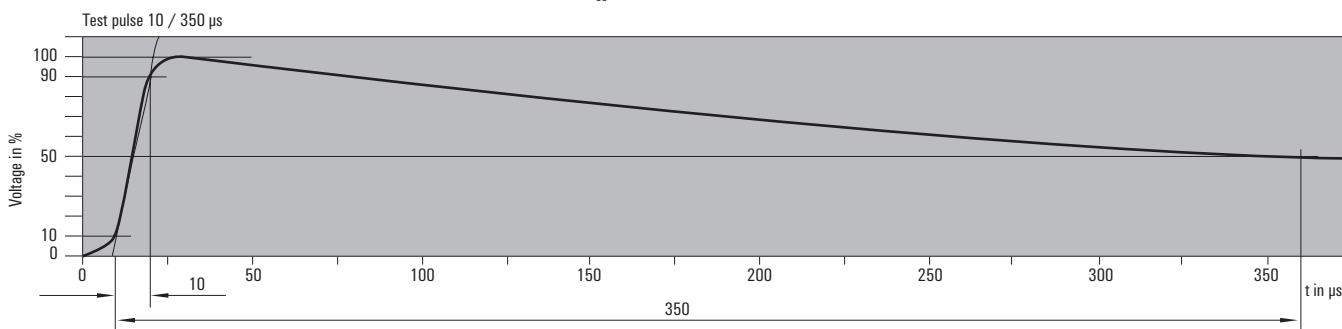

Electromagnetic compatibility

EMC – electromagnetic compatibility – means the trouble-free interaction between electrical and electronic systems and devices without mutual interference. In this respect, any electrical item can act both as transmitter (source of interference) and receiver (potentially susceptible device) simultaneously.

Normally it is not sufficient to construct an EMC-compliant electrical or electronic system using EMC-compliant components and to then expect that everything will operate smoothly. Only when you use the proper surge protection devices in the proper places in the facility, can you operate without outages using coupled surge voltages. The method for using surge protection devices is also linked to the influence of interference sinks and interference sources. It integrates with the lightning protection zone strategy and insulation coordination to form a complete protection system.

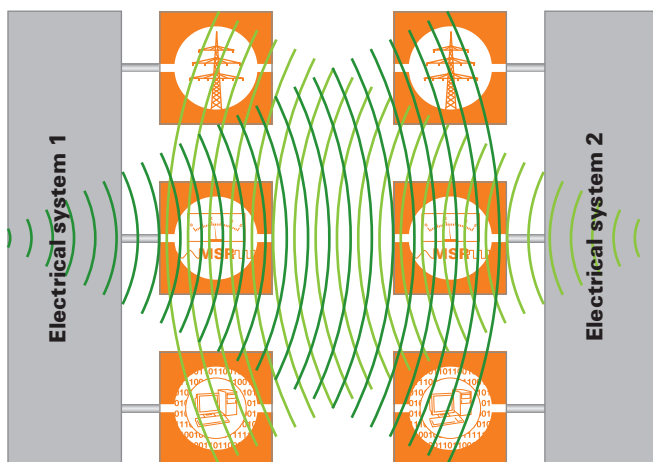

EMC laws and directives

There are a multitude of standards and statutory requirements aimed at controlling mutual interference-free operation. With the establishment of the unified European market in 1989, the EEC Directive (EN 50-370 part 1+2) on electromagnetic compatibility was adopted and then implemented into national law. In Germany, the law on the electromagnetic compatibility (EMVG) was endorsed in 1992. The current version of this law was passed in 2017 as was the international standard IEC 61000-6-x. Electromagnetic influences can be caused by natural processes, e.g. a lightning strike, and also technical processes, e.g. high-speed changes in the status of currents and voltages.

We distinguish between periodic interference (system hum, RF irradiation), transient interference (brief, often high-energy pulses) and noise (broad distribution of interference energy across the frequency range).

The model used in EMC observations designates the transmitter as the **source of interference emission** and the receiver as the **interference sink**. The transmission of the interference takes place via line-bound and/or field-bound (H-field/E-field) coupling mechanisms.

When considered as a source of interference, a device or a system may not exceed emissions thresholds specified in the EMC standards.

When considered as a potentially susceptible device, the same system must exhibit the immunity to interference specified in the standards.

However, the arrangement of various electrical systems within a complex plant or in a room and the many lines for power supplies, inputs and outputs to controls and bus systems give rise to diverse potential influences. Surges can be introduced by lightning, switching operations, etc. via the various coupling paths. This can lead to the following effects:

- Reduced functionality
- Malfunctions
- Failure of functions
- Damage

These last two functional interferences result in stoppages for entire production facilities and cause high breakdown costs.

The following points must be taken into account in order to achieve a system or plant that operates according to EMC guidelines:

- Lightning protection
- Earthing
- Routing of cables
- Cable shielding
- Panel construction
- Sensors and actuators
- Transmitters and receivers
- Frequency converters
- Bus and field devices
- ESD

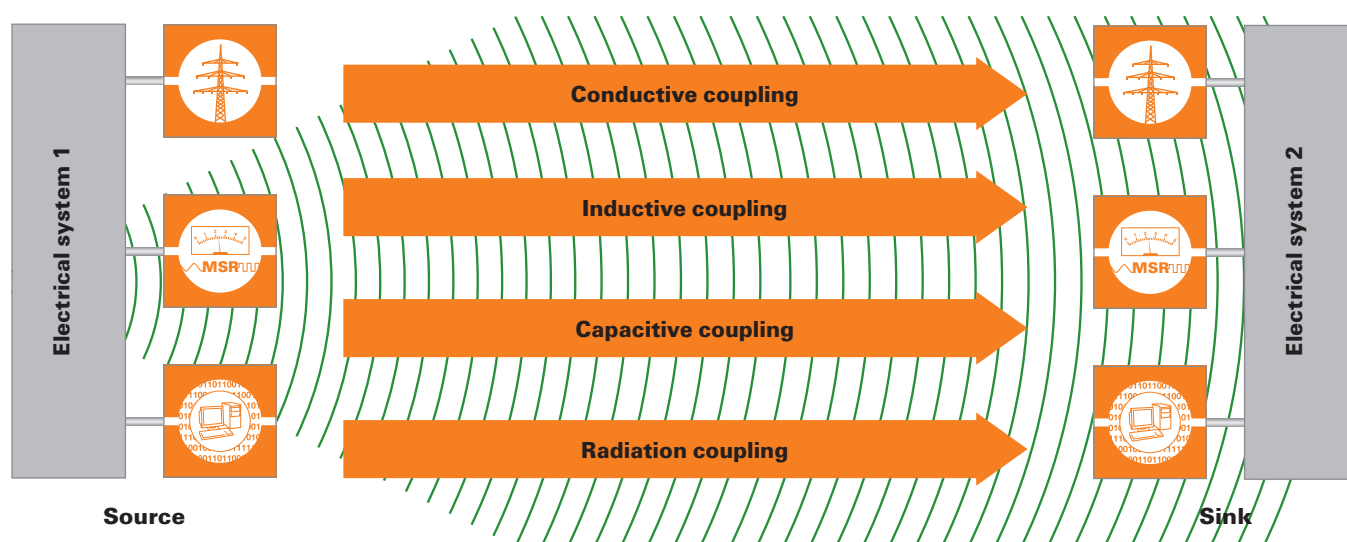

FAQ list

When do I need a Type I arrester, when a Type II arrester?

Type I is normatively required as soon as the building has external lightning protection or an overhead line feed. Type II is normatively required as soon as a type I arrester is installed in the main distribution or if equipment of overvoltage category I or II (e.g. household appliances, portable tools and sensitive electrical devices) are installed (new regulation of DIN VDE 0100-443). DIN VDE 0100-443 also requires the installation of a type II arrester in buildings with large crowds of people, e.g. in large (residential) buildings, churches, schools and offices.

When is a decoupling inductance needed?

When using Weidmüller arresters of Type I and II, no decoupling inductance is needed.

Why are there 3- and 4-pole versions?

Various arresters are used depending on the network structure. A widely used network structure is the TN system. In the TN-C system, the electricity supply company routes the potential of the operational earth of the low-voltage source (transformer) to the consumer installation via the integral PEN conductor. The PE conductor has the same potential as the N conductor in this case. A 3-pole arrester is used here. Every rule has an exception: in the TN-S system, PE and N are separate. This means there can be a potential shift between PE and N. A 4-pole PU is used in this case. In addition, a combination of 3- or 4-pole modules reduces the amount of wiring.

What do I have to consider with the TT- or IT-System?

TT-System

In the TT system, surge protection Type I/II arresters are not used between the active conductor and the earth potential like in TN systems. Instead they are used between phases L1, L2 and L3 and the neutral conductor. In a "classic" arrangement of surge protection devices between the phases and the earth potential, the devices may not be capable of extinguishing mains follow currents at the end of their lifespan. They could even create a short circuit. Depending on the earth resistance that exists for the consumer installation, a fault current could flow back to the supply source. Usually, because of the relatively high loop resistances in TT systems, the fuses which conduct the operating current do not detect this fault current as a fault and thus do not isolate promptly. This can lead to increases in potential in the building's entire equipotential bonding system. Dangerous parasitic voltages can be transferred if more distant buildings are being supplied from these consumer systems or if consumer loads are being operated via portable cables beyond the range of the building's equipotential bonding system. For these reasons, the 3+1 circuit is used in the TT-System.

IT-System

An IT system is set up in some consumer installations for reasons of availability. A single-phase earth fault practically creates a TN system. The power supply is not interrupted but instead maintained. IT systems are used in medical applications, for example. A device for monitoring insulation provides information on the quality of the insulation of active conductors and connected consumers in relation to the earth potential. Surge

protection devices are incorporated between the active conductors and the main equipotential bonding. The fuses, conductor cross-section and conductor routes are handled as for T systems. Likewise, all active conductors are protected against local earth potential in sub-circuit distribution boards. Type III surge protection for end devices are used (such as VPU III or VPU III SO) to protect sensitive consumer loads. The arrester must be sized for the voltage of the phase conductor. The VPU variants 1+1 and 3+1 are suitable for IT network systems in which the ground on the distribution transformer is connected to the ground on the customer side (RE=RA in Figure 44.A1 of IEC 60634-4-44:2018).

How does the 3+1 circuit work?

If Type II arresters are now being led to a neutral conductor instead of a local earth in a TT system, then, for an arrester that has become low ohm, only the wire resistance of the neutral wire limits the incipient follow-on current. Immediately after the fault, this is isolated from the spur line fuses or from the main fuses that are carrying the operating current. A pure short-circuit current has emerged out of a fault current that was subject to an earthing facility and resistor. The connection between the neutral conductor and the main equipotential bonding is established using a spark gap. This conducts the total surge currents occurring at the installation site without overloading. This 3+1 circuitry is also implemented for the circuit distributors. The phase conductors L1, L2 and L3 are connected via the neutral conductor. From there, a spark gap link is established with the PE rail. The same information on the TN system applies when working with local equipotential bonding systems, when there is a separate discharge to the equipotential bonding, and when the surge protection components are



being arranged ahead of the fault-current protective circuits.

How does monitoring work with VPU arresters?

Each individual element of the PU arrester is equipped with a thermal monitoring mechanism. This state-of-the-art design isolates the aged arrester from the power supply network. This helps to prevent fires. This thermal monitoring mechanism functions using a special solder which separates itself within 30 seconds when a current of about 0.2 A flows through the varistor. The functionality is indicated when the viewing window is green, or for the VPU series with arresters marked R, using a remote alert output with a CO contact.

Does a lightning/surge protection system continue to operate after a surge voltage?

Yes, if the leakage current on, for example, the class II remains below the nominal leakage current for each individual disk. However the varistor does age during each discharge. The ageing accumulates over its lifetime and then leads to the failure of the arrester after several years. This can be monitored using remote signalling. Another method, which is required by IEC 62305-3, is a periodic check of the lightning protection system. The V-TEST 2 can help by allowing you to test the function of each individual module.

How are the VPU modules tested?

The VPU I, VPU II and VPU III products are tested according to the valid product standard for lightning and surge protection, IEC / EN 61643-1 1.

Where are the VPU modules installed?

The dimensions of the VPU modules for installation distributors, comply with DIN 43 880 A1 draft 6/81.

The Type I arresters are installed in the vicinity of the power feed and main equipotential bonding. The Type II arresters are installed in the distributor and the VPU III are installed in the sub-distributions, closer to the end device being protected. The insulation co-ordination in DIN VDE 0110 requires that facility components have certain insulation strengths. This can be achieved through the gradual application of arresters in Type I, II and III.

What must be considered when installing the VPU modules?

IEC 60364-5-53 describes the selection and installation of surge protection in buildings worldwide. The German standard VDE 0100-534 describes the selection and set-up of surge protection systems. VDE 0100-443 describes when surge protection must be installed.

What is the difference between a spark gap and a varistor?

A varistor is a voltage-dependent resistor which switches off the surge voltage "softly". A spark gap is a mechanical component or an encapsulated, gas-filled ceramic unit whereby the spark gap switches through immediately, and after the spark, only the ignition voltage is present (80 – 120 V). Depending on the type of spark gap, the capability to suppress the 50-Hz mains follow-on current must also be considered. The varistors, however, do not draw any mains follow-on current.

With the VPU AC S series, the follow current is limited in such a way that a 16 A fuse at 50 kArms does not trip.

When should I use CL or SL circuits with surge protection components for measurement and control systems?

The difference between the switching in the CL (current loop) and SL (symmetrical loop) is the integration of the suppressor diodes. The CL circuit has a diode between the lines. This system is used for current loops and offers direct protection at the input or output of the analogue sensor. The SL circuit operates symmetrically to earth, i.e. two Transzorb diodes are connected to earth. If this is used in a current loop instead of the CL circuit, the residual voltage is twice as high because there are two diodes instead of just the one of the CL circuit.

2 CL protective circuit

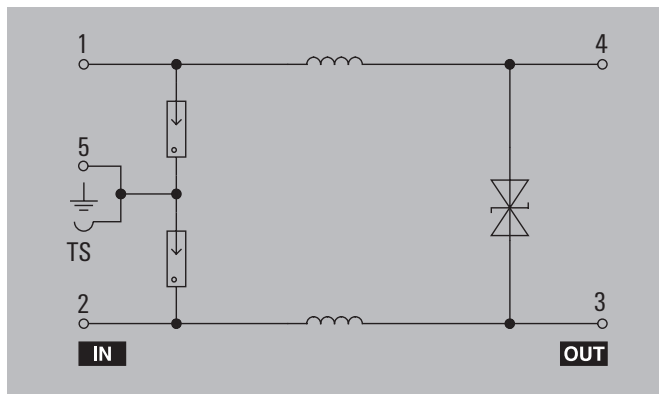

2 SL protective circuit

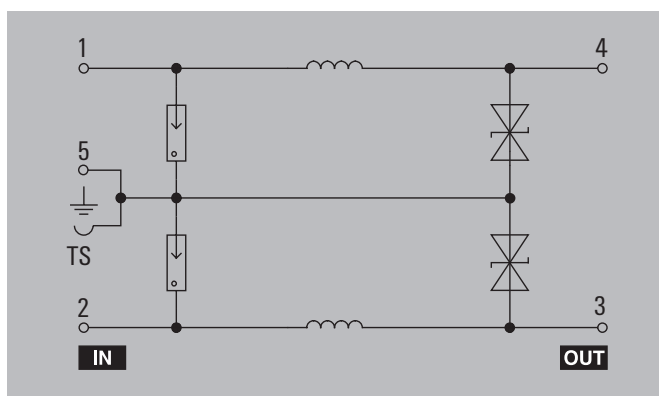

Surge protection standards and regulations

In the case of national and international standards and specifications on the same subject, the document with the widest scope takes precedence (e.g. international "IEC", European "CENELEC" or "CNC", national (Germany) "DIN VDE" or Austria "ÖVE" (Similar to TÜV Germany, also valid in Austria.)).

IEC	EN	VDE	others	
	EN 60728-11	VDE 0855-1		Cable distribution systems for television and sound signals – Part 11: Safety requirements
	HD 60364-5-53	VDE 0100-534		Electrical installations of buildings – Part 5-53: Selection and erection of electrical equipment – Isolation, switching and control – Part: 534: Surge protection device
	HD 60364-5-54	VDE 0100-540		Electrical installations of buildings – Part 5-54: Selection and erection of electrical equipment – Earthing arrangements, protective conductors and protective bonding conductors
IEC 60664-1	EN 60664-1	VDE 0110-1		Insulation coordination for equipment within low-voltage systems – Part 1: Principles, requirements and tests
IEC 60079-11	EN 60079-14	VDE 0165 Part 1		Electrical apparatus for use in the presence of combustible dust – Part 14: Selection and installation
IEC 60079-11	EN 60079-11	VDE 0170 Part 7		Explosive atmospheres – Part 11: Equipment protection by intrinsic safety "I"
IEC 62305-1	EN 62305-1	VDE 0185-305-1		Protection against lightning – Part 1: General principles
IEC 62305-2	EN 62305-2	VDE 0185-305-2		Protection against lightning – Part 2: Risk management
IEC 62305-3	EN 62305-3	VDE 0185-305-3		Protection against lightning – Part 3: Physical damage to structures and life hazard
IEC 62305-4	EN 62305-4	VDE 0185-305-4		Protection against lightning – Part 4: Electrical and electronic systems within structures
IEC 60529	EN 60 529	VDE 0470-1		Degrees of protection provided by enclosures (IP code)
IEC 60099-4	EN 60099-4	VDE 0675, Part 4		Surge arresters – Part 4: Metal-oxide surge arresters without gaps for A.C. systems
IEC 60099-5	EN 60099-5	VDE 0675, Part 5		Surge arresters – Part 5: Selection and application recommendations
IEC 61643-11	EN 61643-11	VDE 0675-6-11		Low-voltage surge protective devices – Part 11: Surge protective devices connected to low-voltage power systems – Requirements and tests
IEC 61643-12	EN 61643-12	VDE 0675-6-12		Surge protection devices for low voltage – Part 12: Selection and reasons for use
IEC 61643-21	EN 61643-21	VDE 845-3-1		Surge protection devices for low voltages – part 21: Surge protective devices for use in telecommunications and signal conditioning networks - Performance requirements and testing methods
IEC 61643-22	TS 61643-22	VDE V 845-3-2		Surge protection devices for low voltages – part 22: Surge protective devices for use in telecommunications and signal conditioning networks - Selection and application strategies
IEC 60038	EN 60038	VDE 0175-1		IEC standard voltages
			KTA 2206, 2009-11	Lightning protection standard for nuclear power plants
			VDE publication 44	Lightning protection systems, explanations to DIN 57 185/VDF 01 85, published by VDE
			DIN-VDE publication	Publication No. 519; Lightning protection systems 1, external lightning protection, published by VDE
			DKE publication No. 520	Publication No. 520; Lightning protection systems 2, internal lightning protection, published by VDE
			ÖVE 8001 §18	Protection of electrical systems from transient overvoltages

The above list is not exhaustive.

Summary of standards and regulations

IEC	EN	VDE	others	
IEC 61400-24	EN 61400-24	VDE 0127-24	IEC 61400-24	Wind power facilities - part 24: Lightning protection for wind turbines
			VdS 2010	Risk-oriented lightning and surge protection
The above list is not exhaustive.				

Risk-based lightning and surge protection, guidelines for damage prevention; VdS damage prevention in the German General Association of Property Insurers Association (GDV)

			VdS 2019	Surge protection in residential buildings
			VdS 2258	Protection against surge voltages
			VdS 2031	Lightning and surge protection in electrical facilities
			VdS 3428: 2005-04	Directives for electrical equipment – surge protection devices (arresters)
			UTE C 61-740-51	French standard for testing SPDs in photovoltaic applications
			DIN CLC/TS 50539-12 VDE V 0675-39-12	Surge protection for low voltage – Surge protection devices for special applications including DC – part 12: Selection and application strategies – Surge protection devices for use in photovoltaic installations
IEC 61643-31	EN 61643-31	VDE 0675-6-31		Standard for testing SPDs in photovoltaic applications
IEC 61643-32	EN 61643-32	VDE 0675-6-32		SPO for use in PV installations
The above list is not exhaustive.				

UL Approvals

UL497B	UL Standard for measurement and control protection
UL94	UL Standard for plastic material
UL1449 Ed.4	UL standard for power protection
NFPA79	Control cabinet planning in the USA



Index

Index	Index Type	X.2
	Index Order No.	X.6
	Addresses worldwide	X.10

Table with 3 columns: Type, Order No., Page. Contains a list of VPU AC II US 1+1 R 240/50 Y and similar entries.

Table with 3 columns: Type, Order No., Page. Contains a list of VPU AC II-HII 3+1 440/20 S and similar entries.

Table with 3 columns: Type, Order No., Page. Contains a list of VPU ZPA S1 3+1 R 300/7,5 and similar entries.

Table with 3 columns: Type, Order No., Page. Contains a list of VSPC 4SL 12VDC and similar entries.



Type	Order No.	Page
VSPC BASE 4SL	8924700000	C.34
VSPC BASE 4SL	8924700000	C.52
VSPC BASE 4SL FG	8924260000	C.34
VSPC BASE 4SL FG	8924260000	C.53
VSPC BASE 4SL FG EX	8951840000	C.140
VSPC BASE 4SL FG EX	8951840000	C.144
VSPC BASE 4SL FG R	8951760000	C.36
VSPC BASE 4SL FG R	8951760000	C.55
VSPC BASE 4SL R	8951750000	C.36
VSPC BASE 4SL R	8951750000	C.54
VSPC CONTRL UNIT 24VDC	8972270000	C.57
VSPC GDT 2CH 150VAC/230VDC	8924590000	C.41
VSPC GDT 2CH 90V	8924570000	C.2
VSPC GDT 2CH 90V	8924570000	C.3
VSPC GDT 2CH 90V	8924570000	C.41
VSPC GROUND	8924680000	C.56
VSPC LOCKING CLIP	1317340000	F.7
VSPC MOV 2CH 230V	8924610000	C.43
VSPC MOV 2CH 230V R	8951660000	C.43
VSPC MOV 2CH 24V	8924600000	C.43
VSPC MOV 2CH 24V R	8951650000	C.43
VSPC RS485 2CH	8924670000	C.2
VSPC RS485 2CH	8924670000	C.3
VSPC RS485 2CH	8924670000	C.49
VSPC RS485 2CH	8924670000	D.9
VSPC RS485 2CH R	8951670000	C.51
VSPC RS485 2CH R	8951670000	D.11
VSPC TAZ 4CH 24V	8924650000	C.45
VSPC TELE UKO 2WIRE	8924660000	C.3
VSPC TELE UKO 2WIRE	8924660000	C.4
VSPC TELE UKO 2WIRE	8924660000	C.47
VSSC4 CL 12VDC 0.5A	1063720000	C.91
VSSC4 CL 24VAC/DC 0.5A	1063730000	C.2
VSSC4 CL 24VAC/DC 0.5A	1063730000	C.3
VSSC4 CL 24VAC/DC 0.5A	1063730000	C.64
VSSC4 CL 24VAC/DC 0.5A	1063730000	C.91
VSSC4 CL 48VAC/DC 0.5A	1063740000	C.3
VSSC4 CL 48VAC/DC 0.5A	1063740000	C.91
VSSC4 CL FG 12VDC 0.5A	1063760000	C.91
VSSC4 CL FG 24VAC/DC EX	1063810000	C.151
VSSC4 CL FG 48VAC/DC EX	1063820000	C.151
VSSC4 CL FG24VAC/DC0.5A	1063770000	C.3
VSSC4 CL FG24VAC/DC0.5A	1063770000	C.64
VSSC4 CL FG24VAC/DC0.5A	1063770000	C.91
VSSC4 CL FG48VAC/DC0.5A	1063780000	C.91
VSSC4 GDT 110VAC/DC20KA	1064050000	C.97
VSSC4 GDT 240VAC/DC20KA	1064060000	C.97
VSSC4 GDT55VUC 20KA EX	1064040000	C.155
VSSC4 MOV 120VAC/DC	1063990000	C.95
VSSC4 MOV 12VDC	1063950000	C.95
VSSC4 MOV 150VAC/DC	1064010000	C.95
VSSC4 MOV 240VAC/DC	1064020000	C.95
VSSC4 MOV 24VAC/DC	1063960000	C.95
VSSC4 MOV 48VAC/DC	1063970000	C.95
VSSC4 MOV 60VAC/DC	1063980000	C.95
VSSC4 RC 240VAC/DC	1064130000	C.101
VSSC4 RC 24VAC/DC	1064120000	C.101
VSSC4 SL 12VDC 0.5A	1063830000	C.93
VSSC4 SL 24VAC/DC 0.5A	1063840000	C.2
VSSC4 SL 24VAC/DC 0.5A	1063840000	C.93
VSSC4 SL 48VAC/DC 0.5A	1063860000	C.93
VSSC4 SL 60VAC/DC 0.5A	1063870000	C.93
VSSC4 SL FG 12VDC 0.5A	1063880000	C.93
VSSC4 SL FG 24VAC/DC EX	1063930000	C.153
VSSC4 SL FG 48VAC/DC EX	1063940000	C.153
VSSC4 SL FG24VAC/DC0.5A	1063890000	C.93
VSSC4 TAZ 12VDC	1064070000	C.99
VSSC4 TAZ 24VAC/DC	1064080000	C.99
VSSC4 TAZ 48VAC/DC	1064090000	C.99
VSSC6 CL FG 12VDC 0.5A	1064260000	C.67
VSSC6 MOV 120VAC/DC	1064610000	C.75
VSSC6 MOV 12VDC	1064530000	C.75
VSSC6 MOV 240VAC/DC	1064630000	C.75
VSSC6 MOV 24VAC/DC	1064540000	C.75
VSSC6 MOV 48VAC/DC	1064570000	C.75
VSSC6 MOV 60VAC/DC	1064600000	C.75
VSSC6 RS232	1064990000	C.3
VSSC6 RS232	1064990000	C.64
VSSC6 RS232	1064990000	C.85
VSSC6 RS232	1064990000	D.15
VSSC6 RS485	1064980000	C.2
VSSC6 RS485	1064980000	C.64
VSSC6 RS485	1064980000	C.85
VSSC6 RS485	1064980000	D.15
VSSC6 RS485 DP	1065010000	C.3
VSSC6 RS485 DP	1065010000	C.64
VSSC6 RS485 DP	1065010000	C.85
VSSC6 RS485 DP	1065010000	D.15
VSSC6 RS485 PA EX	1065020000	C.159
VSSC6 TAZ 12VDC	1064730000	C.83
VSSC6 TAZ 24VAC/DC	1064740000	C.83
VSSC6 CL 12VDC 0.5A	1064150000	C.64
VSSC6 CL 12VDC 0.5A	1064150000	C.67
VSSC6 CL 24VAC/DC 0.5A	1064170000	C.64
VSSC6 CL 24VAC/DC 0.5A	1064170000	C.67
VSSC6 CL 48VAC/DC 0.5A	1064190000	C.3
VSSC6 CL 48VAC/DC 0.5A	1064190000	C.64
VSSC6 CL 48VAC/DC 0.5A	1064190000	C.67
VSSC6 CL 60VAC/DC 0.5A	1064210000	C.67

Type	Order No.	Page
VSSC6 CLFG24VAC/DC0.5A	1064270000	C.64
VSSC6 CLFG24VAC/DC0.5A	1064270000	C.67
VSSC6 CLFG48VAC/DC0.5A	1064280000	C.67
VSSC6 CLFG60VAC/DC0.5A	1064290000	C.67
VSSC6 GDT 110VAC/DC10KA	1064690000	C.64
VSSC6 GDT 110VAC/DC10KA	1064690000	C.79
VSSC6 GDT 110VAC/DC20KA	1064700000	C.64
VSSC6 GDT 110VAC/DC20KA	1064700000	C.79
VSSC6 GDT 240VAC/DC10KA	1064710000	C.79
VSSC6 GDT 240VAC/DC20KA	1064720000	C.64
VSSC6 GDT 240VAC/DC20KA	1064720000	C.79
VSSC6 GDT 24VAC/DC 10KA	1064640000	C.3
VSSC6 GDT 24VAC/DC 10KA	1064640000	C.64
VSSC6 GDT 24VAC/DC 10KA	1064640000	C.79
VSSC6 RTD	1139710000	C.2
VSSC6 RTD	1139710000	C.64
VSSC6 RTD	1139710000	C.87
VSSC6 RTD EX	1130670000	C.161
VSSC6 TR CL 12VDC 0.5A	1064220000	C.69
VSSC6 TR SL FG 24VAC/DC EX	1421440000	C.157
VSSC6 TRCL24VAC/DC0.5A	1064230000	C.69
VSSC6 TRCL48VAC/DC0.5A	1064240000	C.69
VSSC6 TRCL60VAC/DC0.5A	1064250000	C.69
VSSC6 TRLDMOV 12VDC	1064800000	C.77
VSSC6 TRLDMOV 24VAC/DC	1064810000	C.77
VSSC6 TRLDMOV 48VAC/DC	1064820000	C.77
VSSC6 TRLDMOV120VAC/DC	1064840000	C.77
VSSC6 TRLDMOV240VAC/DC	1064860000	C.77
VSSC6 TRLDTAZ 24VAC/DC	1064950000	C.83
VSSC6SL FG LD12VDC0.5A	1064420000	C.71
VSSC6SL LD 12VDC 0.5A	1064340000	C.64
VSSC6SL LD 24VAC/DC0.5A	1064350000	C.71
VSSC6SLFGLD24VAC/DC0.5A	1064430000	C.71
VSSC6SLFGLD48VAC/DC0.5A	1064440000	C.71
VSSC6TRCLFG12VDC0.5A	1064300000	C.64
VSSC6TRCLFG12VDC0.5A	1064300000	C.69
VSSC6TRCLFG24VAC/DC EX	1066490000	C.157
VSSC6TRCLFG24VAC/DC0.5A	1064310000	C.64
VSSC6TRCLFG24VAC/DC0.5A	1064310000	C.69
VSSC6TRCLFG48VAC/DC0.5A	1064320000	C.69
VSSC6TRCLFG60VAC/DC0.5A	1064330000	C.69
VSSC6TRGDT110VAC/DC10KA	1064890000	C.81
VSSC6TRGDT240VAC/DC10KA	1064920000	C.81
VSSC6TRGDT24VAC/DC10KA	1064870000	C.81
VSSC6TRSL24VAC/DC0.5A	1354790000	C.73
VSSC6TRSLFG24VAC/DC0.5A	1354800000	C.73
VSSC6TRSLFGLD12VDC0.5A	1064490000	C.73
VSSC6TRSLFGLD24VUC 0.5A	1064500000	C.73
VSSC6TRSLLD12VDC0.5A	1064380000	C.73
VSSC6TRSLLD24VAC/DC0.5A	1064390000	C.73
VSSC6TRSLLD48VAC/DC0.5A	1064400000	C.73

W

WAVEFILTER 3A	8614780000	E.4
WAVEFILTER 6A	8614800000	E.4
WAVEFILTER 10A	8614770000	E.5

Order No.	Type	Page
-----------	------	------

106000000

1063720000	VSSC4 CL 12VDC 0.5A	C.91
1063730000	VSSC4 CL 24VAC/DC 0.5A	C.2
1063730000	VSSC4 CL 24VAC/DC 0.5A	C.3
1063730000	VSSC4 CL 24VAC/DC 0.5A	C.64
1063730000	VSSC4 CL 24VAC/DC 0.5A	C.91
1063740000	VSSC4 CL 48VAC/DC 0.5A	C.3
1063740000	VSSC4 CL 48VAC/DC 0.5A	C.91
1063760000	VSSC4 CL FG 12VDC 0.5A	C.91
1063770000	VSSC4 CL FG24VAC/DC0.5A	C.3
1063770000	VSSC4 CL FG24VAC/DC0.5A	C.64
1063770000	VSSC4 CL FG24VAC/DC0.5A	C.91
1063780000	VSSC4 CL FG48VAC/DC0.5A	C.91
1063810000	VSSC4 CL FG 24VAC/DC EX	C.151
1063820000	VSSC4 CL FG 48VAC/DC EX	C.151
1063830000	VSSC4 SL 12VDC 0.5A	C.93
1063840000	VSSC4 SL 24VAC/DC 0.5A	C.2
1063840000	VSSC4 SL 24VAC/DC 0.5A	C.93
1063860000	VSSC4 SL 48VAC/DC 0.5A	C.93
1063870000	VSSC4 SL 60VAC/DC 0.5A	C.93
1063880000	VSSC4 SL FG 12VDC 0.5A	C.93
1063890000	VSSC4 SL FG24VAC/DC0.5A	C.93
1063930000	VSSC4 SL FG 24VAC/DC EX	C.153
1063940000	VSSC4 SL FG 48VAC/DC EX	C.153
1063950000	VSSC4 MOV 12VDC	C.95
1063960000	VSSC4 MOV 24VAC/DC	C.95
1063970000	VSSC4 MOV 48VAC/DC	C.95
1063980000	VSSC4 MOV 60VAC/DC	C.95
1063990000	VSSC4 MOV 120VAC/DC	C.95
1064010000	VSSC4 MOV 150VAC/DC	C.95
1064020000	VSSC4 MOV 240VAC/DC	C.95
1064040000	VSSC4 GDT55VUC 20KA EX	C.155
1064050000	VSSC4 GDT 110VAC/DC20KA	C.97
1064060000	VSSC4 GDT 240VAC/DC20KA	C.97
1064070000	VSSC4 TAZ 12VDC	C.99
1064080000	VSSC4 TAZ 24VAC/DC	C.99
1064090000	VSSC4 TAZ 48VAC/DC	C.99
1064120000	VSSC4 RC 24VAC/DC	C.101
1064130000	VSSC4 RC 240VAC/DC	C.101
1064150000	VSSC6 CL 12VDC 0.5A	C.64
1064150000	VSSC6 CL 12VDC 0.5A	C.67
1064170000	VSSC6 CL 24VAC/DC 0.5A	C.64
1064170000	VSSC6 CL 24VAC/DC 0.5A	C.67
1064190000	VSSC6 CL 48VAC/DC 0.5A	C.64
1064190000	VSSC6 CL 48VAC/DC 0.5A	C.67
1064190000	VSSC6 CL 48VAC/DC 0.5A	C.64
1064190000	VSSC6 CL 48VAC/DC 0.5A	C.67
1064210000	VSSC6 CL 60VAC/DC 0.5A	C.67
1064220000	VSSC6 TR CL 12VDC 0.5A	C.69
1064230000	VSSC6 TRCL 24VAC/DC0.5A	C.69
1064240000	VSSC6 TRCL48VAC/DC0.5A	C.69
1064250000	VSSC6 TRCL60VAC/DC0.5A	C.69
1064260000	VSSC6 CL FG 12VDC 0.5A	C.67
1064270000	VSSC6 CLFG24VAC/DC0.5A	C.64
1064270000	VSSC6 CLFG24VAC/DC0.5A	C.67
1064280000	VSSC6 CLFG48VAC/DC0.5A	C.67
1064290000	VSSC6 CLFG60VAC/DC0.5A	C.67
1064300000	VSSC6TRCLFG12VDC0.5A	C.64
1064300000	VSSC6TRCLFG12VDC0.5A	C.69
1064310000	VSSC6TRCLFG24VAC/DC0.5A	C.64
1064310000	VSSC6TRCLFG24VAC/DC0.5A	C.69
1064320000	VSSC6TRCLFG48VAC/DC0.5A	C.69
1064330000	VSSC6TRCLFG60VAC/DC0.5A	C.69
1064340000	VSSC6SL LD 12VDC 0.5A	C.64
1064340000	VSSC6SL LD 12VDC 0.5A	C.71
1064350000	VSSC6SL LD24VAC/DC0.5A	C.71
1064380000	VSSC6TRSLD12VDC0.5A	C.73
1064390000	VSSC6TRSLD24VAC/DC0.5A	C.73
1064400000	VSSC6TRSLD48VAC/DC0.5A	C.73
1064420000	VSSC6SL FG LD12VDC0.5A	C.71
1064430000	VSSC6SLFGLD24VAC/DC0.5A	C.71
1064440000	VSSC6SLFGLD48VAC/DC0.5A	C.71
1064490000	VSSC6TRSLFGLD12VDC0.5A	C.73
1064500000	VSSC6TRSLFGLD24VAC 0.5A	C.73
1064530000	VSSC6 MOV 12VDC	C.75
1064540000	VSSC6 MOV 24VAC/DC	C.75
1064570000	VSSC6 MOV 48VAC/DC	C.75
1064600000	VSSC6 MOV 60VAC/DC	C.75
1064610000	VSSC6 MOV 120VAC/DC	C.75
1064630000	VSSC6 MOV 240VAC/DC	C.75
1064640000	VSSC6 GDT 24VAC/DC 10KA	C.3
1064640000	VSSC6 GDT 24VAC/DC 10KA	C.64
1064640000	VSSC6 GDT 24VAC/DC 10KA	C.79
1064690000	VSSC6 GDT 110VAC/DC10KA	C.64
1064690000	VSSC6 GDT 110VAC/DC10KA	C.79
1064700000	VSSC6 GDT 110VAC/DC20KA	C.64
1064700000	VSSC6 GDT 110VAC/DC20KA	C.79
1064710000	VSSC6 GDT 240VAC/DC10KA	C.79
1064720000	VSSC6 GDT 240VAC/DC20KA	C.64
1064720000	VSSC6 GDT 240VAC/DC20KA	C.79
1064730000	VSSC6 TAZ 12VDC	C.83
1064740000	VSSC6 TAZ 24VAC/DC	C.83
1064800000	VSSC6 TRLDMOV 12VDC	C.77
1064810000	VSSC6 TRLDMOV 24VAC/DC	C.77
1064820000	VSSC6 TRLDMOV 48VAC/DC	C.77
1064840000	VSSC6 TRLDMOV120VAC/DC	C.77
1064860000	VSSC6 TRLDMOV240VAC/DC	C.77
1064870000	VSSC6TRGDT24VAC/DC10KA	C.81
1064890000	VSSC6TRGDT110VAC/DC10KA	C.81

Order No.	Type	Page
-----------	------	------

1064920000	VSSC6TRGDT240VAC/DC10KA	C.81
1064950000	VSSC6 TRLDTAZ 24VAC/DC	C.83
1064980000	VSSC6 RS485	C.2
1064980000	VSSC6 RS485	C.64
1064980000	VSSC6 RS485	C.85
1064980000	VSSC6 RS485	D.15
1064990000	VSSC6 RS232	C.3
1064990000	VSSC6 RS232	C.64
1064990000	VSSC6 RS232	C.85
1064990000	VSSC6 RS232	D.15
1065100000	VSSC6 RS485 DP	C.3
1065100000	VSSC6 RS485 DP	C.64
1065100000	VSSC6 RS485 DP	C.85
1065100000	VSSC6 RS485 DP	D.15
1065020000	VSSC6 RS485 PA EX	C.159
1066490000	VSSC6TRCLFG24VAC/DC EX	C.157

107000000

1070230000	VSPC BASE 1CL PW	C.28
1070230000	VSPC BASE 1CL PW	C.52
1070470000	VSPC BASE 1CL PW FG EX	C.136
1070470000	VSPC BASE 1CL PW FG EX	C.144

109000000

1093400000	VSPC 2CL 24VAC R	C.23
------------	------------------	------

110000000

1105700000	VSPC BASE 1CL PW FG	C.28
1105700000	VSPC BASE 1CL PW FG	C.53

113000000

1130670000	VSSC6 RTD EX	C.161
1139710000	VSSC6 RTD	C.2
1139710000	VSSC6 RTD	C.64
1139710000	VSSC6 RTD	C.87

116000000

1161150000	VSPC 4SL 12VAC EX	C.141
1161170000	VSPC 4SL 12VDC EX	C.141
1161180000	VSPC 4SL 24VAC EX	C.141
1161190000	VSPC 4SL 24VDC EX	C.141

130000000

1309470000	QB 17,8/2	F.7
------------	-----------	-----

131000000

1317340000	VSPC LOCKING CLIP	F.7
------------	-------------------	-----

134000000

1348590000	VDATA CAT6	C.3
1348590000	VDATA CAT6	D.13

135000000

1351550000	VPV III R 12V/4KV AC/DC	A.9
1351550000	VPV III R 12V/4KV AC/DC	A.108
1351580000	VPV III R 24V/4KV AC/DC	A.9
1351580000	VPV III R 24V/4KV AC/DC	A.108
1351600000	VPV III R 48V/4KV AC/DC	A.9
1351600000	VPV III R 48V/4KV AC/DC	A.109
1351630000	VPV III R 120V/6KV AC/DC	A.9
1351630000	VPV III R 120V/6KV AC/DC	A.109
1351650000	VPV III R 230V/6KV AC	A.9
1351650000	VPV III R 230V/6KV AC	A.110
1351680000	VPV III SO LD	A.9
1351680000	VPV III SO LD	A.111
1351700000	VPV III SO LD+A	A.9
1351700000	VPV III SO LD+A	A.111
1354790000	VSSC6TRSL24VAC/DC0.5A	C.73
1354800000	VSSC6TRSLFG24VAC/DC0.5A	C.73

142000000

1421440000	VSSC6 TR SL FG 24VAC/DC EX	C.157
------------	----------------------------	-------

147000000

1473440000	VPV II 1 1000V/40KA AC	A.7
1473440000	VPV II 1 1000V/40KA AC	A.70

253000000

2530180000	VPV PV II 3 R 1000	B.2
2530180000	VPV PV II 3 R 1000	B.11
2530190000	VPV PV I+II 3 R 1000 E	B.2
2530190000	VPV PV I+II 3 R 1000 E	B.8
2530520000	VPV PV I+II 3 1000 E	B.2
2530520000	VPV PV I+II 3 1000 E	B.8
2530550000	VPV PV II 3 1000	B.2
2530550000	VPV PV II 3 1000	B.11
2530580000	VPV PV I+II 3 1500	B.2

Order No.	Type	Page
-----------	------	------

2530580000	VPV PV I+II 3 1500	B.9
2530590000	VPV PV I+II 3 R 1500	B.2
2530590000	VPV PV I+II 3 R 1500	B.9
2530610000	VPV PV I+II 3 1000	B.2
2530610000	VPV PV I+II 3 1000	B.9
2530620000	VPV PV I+II 3 R 1000	B.2
2530620000	VPV PV I+II 3 R 1000	B.9
2530640000	VPV PV II 3 1500	B.2
2530640000	VPV PV II 3 1500	B.12
2530650000	VPV PV II 3 R 1500	B.2
2530650000	VPV PV II 3 R 1500	B.12

259000000

2591000000	VPV AC II 4 R 150/50	A.6
2591000000	VPV AC II 4 R 150/50	A.56
2591020000	VPV AC II 1 300/50	A.6
2591020000	VPV AC II 1 300/50	A.57
2591030000	VPV AC II 1 R 300/50	A.6
2591030000	VPV AC II 1 R 300/50	A.57
2591040000	VPV AC II 2 300/50	A.6
2591040000	VPV AC II 2 300/50	A.58
2591050000	VPV AC II 2 R 300/50	A.6
2591050000	VPV AC II 2 R 300/50	A.58
2591060000	VPV AC II 1+1 300/50	A.6
2591060000	VPV AC II 1+1 300/50	A.57
2591070000	VPV AC II 1+1 R 300/50	A.6
2591070000	VPV AC II 1+1 R 300/50	A.57
2591080000	VPV AC II 3+1 300/50	A.6
2591080000	VPV AC II 3+1 300/50	A.59
2591090000	VPV AC II 3+1 R 300/50	A.6
2591090000	VPV AC II 3+1 R 300/50	A.59
2591100000	VPV AC II 3 350/50	A.6
2591100000	VPV AC II 3 350/50	A.64
2591110000	VPV AC II 3 R 350/50	A.6
2591110000	VPV AC II 3 R 350/50	A.64
2591120000	VPV AC II 4 350/50	A.6
2591120000	VPV AC II 4 350/50	A.65
2591130000	VPV AC II 4 R 350/50	A.6
2591130000	VPV AC II 4 R 350/50	A.65
2591140000	VPV AC II 4 300/50	A.6
2591140000	VPV AC II 4 300/50	A.59
2591150000	VPV AC II 4 R 300/50	A.6
2591150000	VPV AC II 4 R 300/50	A.59
2591160000	VPV AC I 3 300/50	A.6
2591160000	VPV AC I 3 300/50	A.58
2591170000	VPV AC I 3 R 300/50	A.6
2591170000	VPV AC I 3 R 300/50	A.58
2591180000	VPV AC I 1 N-PE 305/65	A.7
2591180000	VPV AC II 1 N-PE 305/65	A.71
2591210000	VPV AC I 1 480/50	A.6
2591210000	VPV AC I 1 480/50	A.66
2591220000	VPV AC I 1 R 480/50	A.6
2591220000	VPV AC I 1 R 480/50	A.66
2591230000	VPV AC II 2 480/50	A.6
2591230000	VPV AC II 2 480/50	A.66
2591240000	VPV AC I 2 R 480/50	A.6
2591240000	VPV AC I 2 R 480/50	A.66
2591250000	VPV AC I 3 480/50	A.6
2591250000	VPV AC I 3 480/50	A.67
2591260000	VPV AC II 3 R 480/50	A.6
2591260000	VPV AC II 3 R 480/50	A.67
2591270000	VPV AC I 4 480/50	A.6
2591270000	VPV AC I 4 480/50	A.67
2591280000	VPV AC I 4 R 480/50	A.6
2591280000	VPV AC I 4 R 480/50	A.67
2591300000	VPV AC II 1 R 750/35	A.6
2591300000	VPV AC II 1 R 750/35	A.68
2591310000	VPV AC II 2 R 750/35	A.6
2591310000	VPV AC II 2 R 750/35	A.68
2591320000	VPV AC I 3 R 750/35	A.6
2591320000	VPV AC I 3 R 750/35	A.69
2591350000	VPV AC II 1 350/50	A.6
2591350000	VPV AC II 1 350/50	A.63
2591360000		

Order No.	Type	Page
2685690000	VPCB PV II R 1000	B.16
2685700000	VPCB PV I+II 1000 E	B.2
2685700000	VPCB PV I+II 1000 E	B.13
2685730000	VPCB PV I+II 1000 E	B.2
2685730000	VPCB PV I+II 1000 E	B.13
2685740000	VPCB PV I+II 1000	B.2
2685740000	VPCB PV I+II 1000	B.14
2685750000	VPCB PV I+II M 1000	B.2
2685750000	VPCB PV I+II M 1000	B.14
2685760000	VPCB PV I+II R 1000	B.2
2685760000	VPCB PV I+II R 1000	B.14
2685770000	VPCB PV I+II R M 1000	B.2
2685770000	VPCB PV I+II R M 1000	B.14

2720000000

2726620000	VPU AC I 1 275/25 LCF S	A.4
2726620000	VPU AC I 1 275/25 LCF S	A.16
2726660000	VPU AC I 1 R 275/25 LCF S	A.4
2726660000	VPU AC I 1 R 275/25 LCF S	A.16
2726680000	VPU AC I 1+1 275/25 LCF S	A.4
2726680000	VPU AC I 1+1 275/25 LCF S	A.16
2726700000	VPU AC I 1+1 R 275/25 LCF S	A.4
2726700000	VPU AC I 1+1 R 275/25 LCF S	A.16
2726720000	VPU AC I 2 275/25 LCF S	A.4
2726720000	VPU AC I 2 275/25 LCF S	A.17
2726730000	VPU AC I 2 R 275/25 LCF S	A.4
2726730000	VPU AC I 2 R 275/25 LCF S	A.17
2726740000	VPU AC I 3 275/25 LCF S	A.4
2726740000	VPU AC I 3 275/25 LCF S	A.17
2726750000	VPU AC I 3 R 275/25 LCF S	A.4
2726750000	VPU AC I 3 R 275/25 LCF S	A.17
2726760000	VPU AC I 3+1 275/25 LCF S 2PE	A.4
2726760000	VPU AC I 3+1 275/25 LCF S 2PE	A.18
2726770000	VPU AC I 3+1 R 275/25 LCF S 2PE	A.4
2726770000	VPU AC I 3+1 R 275/25 LCF S 2PE	A.18
2726780000	VPU AC I 4 275/25 LCF S	A.4
2726780000	VPU AC I 4 275/25 LCF S	A.19
2726790000	VPU AC I 4 R 275/25 LCF S	A.4
2726790000	VPU AC I 4 R 275/25 LCF S	A.19
2726800000	VPU AC I 1 N-PE 305/100 S	A.5
2726800000	VPU AC I 1 N-PE 305/100 S	A.32

2730000000

2730280000	VPU AC I 3+1 275/25 LCF S 2N	A.4
2730280000	VPU AC I 3+1 275/25 LCF S 2N	A.18
2730290000	VPU AC I 3+1 R 275/25 LCF S 2N	A.4
2730290000	VPU AC I 3+1 R 275/25 LCF S 2N	A.18
2730450000	VPU AC II US 1 120/50	A.7
2730450000	VPU AC II US 1 120/50	A.81
2730460000	VPU AC II US 1 R 120/50	A.7
2730460000	VPU AC II US 1 R 120/50	A.81
2730470000	VPU AC II US 2 120/50	A.7
2730470000	VPU AC II US 2 120/50	A.81
2730480000	VPU AC II US 2 R 120/50	A.7
2730480000	VPU AC II US 2 R 120/50	A.81
2730490000	VPU AC II US 4 120/50	A.7
2730490000	VPU AC II US 4 120/50	A.82
2730500000	VPU AC II US 4 R 120/50	A.7
2730500000	VPU AC II US 4 R 120/50	A.82
2730510000	VPU AC II US 3 120/50	A.7
2730510000	VPU AC II US 3 120/50	A.82
2730520000	VPU AC II US 3 R 120/50	A.7
2730520000	VPU AC II US 3 R 120/50	A.82
2730540000	VPU AC II US 3 240/50	A.7
2730540000	VPU AC II US 3 240/50	A.84
2730550000	VPU AC II US 3 R 240/50	A.7
2730550000	VPU AC II US 3 R 240/50	A.84
2730570000	VPU AC II US 1 277/50	A.8
2730570000	VPU AC II US 1 277/50	A.89
2730580000	VPU AC II US 1 R 277/50	A.8
2730580000	VPU AC II US 1 R 277/50	A.89
2730590000	VPU AC II US 1+1 277/50	A.8
2730590000	VPU AC II US 1+1 277/50	A.89
2730600000	VPU AC II US 3 277/50	A.8
2730600000	VPU AC II US 3 277/50	A.90
2730610000	VPU AC II US 3 R 277/50	A.8
2730610000	VPU AC II US 3 R 277/50	A.90
2730620000	VPU AC II US 4 277/50	A.8
2730620000	VPU AC II US 4 277/50	A.91
2730630000	VPU AC II US 2 277/50	A.8
2730630000	VPU AC II US 2 277/50	A.90
2730640000	VPU AC II US 2 R 277/50	A.8
2730640000	VPU AC II US 2 R 277/50	A.90
2730690000	VPU AC II US 3+1 277/50	A.8
2730690000	VPU AC II US 3+1 277/50	A.91
2730700000	VPU AC II US 1 400/50	A.8
2730700000	VPU AC II US 1 400/50	A.92
2730710000	VPU AC II US 1 R 400/50	A.8
2730710000	VPU AC II US 1 R 400/50	A.92
2730720000	VPU AC II US 3 400/50	A.8
2730720000	VPU AC II US 3 400/50	A.92

Order No.	Type	Page
2730730000	VPU AC II US 3 R 400/50	A.8
2730730000	VPU AC II US 3 R 400/50	A.92
2730740000	VPU AC II US 4 400/50	A.8
2730740000	VPU AC II US 4 400/50	A.93
2730750000	VPU AC II US 4 R 400/50	A.8
2730750000	VPU AC II US 4 R 400/50	A.93
2730780000	VPU AC II US 3 R 600/35	A.8
2730780000	VPU AC II US 3 R 600/35	A.95
2730790000	VPU AC II US 2 R 60/50	A.7
2730790000	VPU AC II US 2 R 60/50	A.80
2730800000	VPU AC II US 2 R 60/65	A.7
2730800000	VPU AC II US 1 N-PE 240/65	A.71
2730800000	VPU AC II US 1 N-PE 240/65	A.13
2735070000	VPU LOCKING CLIP L	B.7
2735070000	VPU LOCKING CLIP L	F.2
2735080000	VPU LOCKING CLIP S	A.13
2735080000	VPU LOCKING CLIP S	A.53
2735080000	VPU LOCKING CLIP S	B.7
2735080000	VPU LOCKING CLIP S	F.2
2735900000	VPU IOT AC II 3+1 300/50	A.9
2735900000	VPU IOT AC II 3+1 300/50	A.114
2736210000	VPU AC II US 1 60/50	A.7
2736210000	VPU AC II US 1 60/50	A.80
2736270000	VPU AC II US 1 R 60/50	A.7
2736270000	VPU AC II US 1 R 60/50	A.80
2736280000	VPU AC II US 2 60/50	A.7
2736280000	VPU AC II US 2 60/50	A.80
2736300000	VPU AC II US 2 240/50	A.7
2736300000	VPU AC II US 1 240/50	A.83
2736310000	VPU AC II US 1 R 240/50	A.7
2736310000	VPU AC II US 1 R 240/50	A.83
2736320000	VPU AC II US 2 240/50	A.7
2736320000	VPU AC II US 2 240/50	A.84
2736330000	VPU AC II US 2 R 240/50	A.7
2736330000	VPU AC II US 2 R 240/50	A.84
2736340000	VPU AC II US 1+1 240/50	A.7
2736340000	VPU AC II US 1+1 240/50	A.83
2736350000	VPU AC II US 1+1 R 240/50	A.7
2736350000	VPU AC II US 1+1 R 240/50	A.83
2736360000	VPU AC II US 3+1 240/50	A.7
2736360000	VPU AC II US 3+1 240/50	A.85
2736390000	VPU AC II US 3+1 R 240/50	A.7
2736390000	VPU AC II US 3+1 R 240/50	A.85
2736400000	VPU AC II US 4 240/50	A.7
2736400000	VPU AC II US 4 240/50	A.85
2736410000	VPU AC II US 4 R 240/50	A.7
2736410000	VPU AC II US 4 R 240/50	A.85
2736420000	VPU AC II US 1 R 600/35	A.8
2736420000	VPU AC II US 1 R 600/35	A.94
2736430000	VPU AC II US 2 R 600/35	A.8
2736430000	VPU AC II US 2 R 600/35	A.94
2736440000	VPU AC II US 3+1 R 240/50 Y	A.7
2736440000	VPU AC II US 3+1 R 240/50 Y	A.88
2736450000	VPU AC II US 3+1 R 240/50 Y	A.7
2736450000	VPU AC II US 3+1 R 240/50 Y	A.87
2736460000	VPU AC II US 1+1 R 240/50 Y	A.7
2736460000	VPU AC II US 1+1 R 240/50 Y	A.86
2736470000	VPU AC II US 1 R 240/50 Y	A.7
2736470000	VPU AC II US 1 R 240/50 Y	A.86
2736480000	VPU AC II US 2 R 240/50 Y	A.7
2736480000	VPU AC II US 2 R 240/50 Y	A.87
2736490000	VPU AC II US 4 R 240/50 Y	A.7
2736490000	VPU AC II US 4 R 240/50 Y	A.88

2750000000

2755950000	VPUM1I1SXFV200TPXP10	B.2
2755950000	VPUM1I1SXFV200TPXP10	B.22
2755960000	VPUM2I2SXFV200TPXP10	B.2
2755960000	VPUM2I2SXFV200TPXP10	B.22
2755970000	VPUM1I1SXFV100TPXP10	B.2
2755970000	VPUM1I1SXFV100TPXP10	B.20
2755980000	VPUM2I2SXFV100TPXP10	B.2
2755980000	VPUM2I2SXFV100TPXP10	B.20
2755990000	VPUM1I1SXFV200TPXP15	B.2
2755990000	VPUM1I1SXFV200TPXP15	B.23
2756000000	VPUM2I2SXFV200TPXP15	B.2
2756000000	VPUM2I2SXFV200TPXP15	B.23

2760000000

2764110000	VPUM1I1SXFV201TPXP10	B.2
2764110000	VPUM1I1SXFV201TPXP10	B.24
2764130000	VPUM2I2SXFV201TPXP10	B.2
2764130000	VPUM2I2SXFV201TPXP10	B.24
2764140000	VPUM1I1SXFV101TPXP10	B.2
2764140000	VPUM1I1SXFV101TPXP10	B.21
2764150000	VPUM2I2SXFV101TPXP10	B.2
2764150000	VPUM2I2SXFV101TPXP10	B.21
2764160000	VPUM1I1SXFV201TPXP15	B.2
2764160000	VPUM1I1SXFV201TPXP15	B.25
2764180000	VPUM2I2SXFV201TPXP15	B.2
2764180000	VPUM2I2SXFV201TPXP15	B.25

2770000000

2774940000	VPU AC I 1 R 275/25 LCF MB	A.5
2774940000	VPU AC I 1 R 275/25 LCF MB	A.36
2774950000	VPU AC I 2 R 275/25 LCF MB	A.5

Order No.	Type	Page
2774950000	VPU AC I 2 R 275/25 LCF MB	A.37
2774960000	VPU AC I 3 R 275/25 LCF MB	A.5
2774960000	VPU AC I 3 R 275/25 LCF MB	A.37
2774990000	VPU AC I 4 R 275/25 LCF MB	A.5
2774990000	VPU AC I 4 R 275/25 LCF MB	A.38
2775000000	VPU AC I 1+1 R 275/25 LCF MB	A.5
2775000000	VPU AC I 1+1 R 275/25 LCF MB	A.36

2800000000

2807390000	VPU AC II F 1 R 300/40	A.7
2807390000	VPU AC II F 1 R 300/40	A.74
2807400000	VPU AC II F 2 R 300/40	A.7
2807400000	VPU AC II F 2 R 300/40	A.75
2807410000	VPU AC II F 3 R 300/40	A.7
2807410000	VPU AC II F 3 R 300/40	A.75
2807420000	VPU AC II F 4 R 300/40	A.7
2807420000	VPU AC II F 4 R 300/40	A.76
2807430000	VPU AC II F 1+1 R 300/40	A.7
2807430000	VPU AC II F 1+1 R 300/40	A.74
2807440000	VPU AC II F 3+1 R 300/40	A.7
2807440000	VPU AC II F 3+1 R 300/40	A.76

2810000000

2811930000	VPU II 1 R 1000V/40KA AC	A.7
2811930000	VPU II 1 R 1000V/40KA AC	A.70

2820000000

2827580000	VPU AC II F 1 300/40	A.7
2827580000	VPU AC II F 1 300/40	A.74
2827590000	VPU AC II F 2 300/40	A.7
2827590000	VPU AC II F 2 300/40	A.75
2827600000	VPU AC II F 3 300/40	A.7
2827600000	VPU AC II F 3 300/40	A.75
2827610000	VPU AC II F 4 300/40	A.7
2827610000	VPU AC II F 4 300/40	A.76
2827620000	VPU AC II F 1+1 300/40	A.7
2827620000	VPU AC II F 1+1 300/40	A.74
2827630000	VPU AC II F 3+1 300/40	A.7
2827630000	VPU AC II F 3+1 300/40	A.76

2830000000

2830870000	VPU ZPA S 13 300/12,5	A.5
2830870000	VPU ZPA S 13 300/12,5	A.46
2830880000	VPU ZPA S 13 R 300/12,5	A.5
2830880000	VPU ZPA S 13 R 300/12,5	A.46
2830890000	VPU ZPA S 13 RA 300/12,5	A.5
2830890000	VPU ZPA S 13 RA 300/12,5	A.46
2830900000	VPU AC II F 1+1 300/7,5	A.5
2830900000	VPU AC II F 1+1 300/7,5	A.47
2830910000	VPU ZPA S 13+1 300/7,5	A.5
2830910000	VPU ZPA S 13+1 300/7,5	A.47
2830920000	VPU ZPA S 13+1 RA 300/12,5	A.5
2830920000	VPU ZPA S 13+1 RA 300/12,5	A.46
2830930000	VPU ZPA S 13 300/7,5	A.5
2830930000	VPU ZPA S 13 300/7,5	A.47
2830940000	VPU ZPA S 13 R 300/7,5	A.5
2830940000	VPU ZPA S 13 R 300/7,5	A.47
2830950000	VPU ZPA S 13 RA 300/7,5	A.5
2830950000	VPU ZPA S 13 RA 300/7,5	A.47
2830960000	VPU ZPA S 13+1 300/7,5	A.5
2830960000	VPU ZPA S 13+1 300/7,5	A.47
2830970000	VPU ZPA S 13+1 R 300/7,5	A.5
2830970000	VPU ZPA S 13+1 R 300/7,5	A.47
2830980000	VPU ZPA S 13+1 RA 300/7,5	A.5
2830980000	VPU ZPA S 13+1 RA 300/7,5	A.47

2840000000

2845570000	VPU AC I 3+MOV R 950/12,5	A.4
2845570000	VPU AC I 3+MOV R 950/12,5	A.29

2850000000

2855300000	PLUG VPU AC	A.13
2855300000	PLUG VPU AC	A.53
2855300000	PLUG VPU AC	B.7
2855300000	PLUG VPU AC	F.2
2856440000	VPU PV I+II S 1000	B.2
2856440000	VPU PV I+II S 1000	B.10
2856490000	VPU PV I+II S R 1000	B.2
2856490000	VPU PV I+II S R 1000	B.10
2856500000	VPU PV II S 1000	B.2

Order No.	Type	Page
2983550000	VPU AC1 2 R 300/12.5 LH	A.27
2983560000	VPU AC1 3 R 300/12.5 LH	A.4
2983560000	VPU AC1 3 R 300/12.5 LH	A.27
2983570000	VPU AC1 3 300/12.5 LH	A.4
2983570000	VPU AC1 3 300/12.5 LH	A.27
2983580000	VPU AC13+1 300/12.5 LH	A.4
2983580000	VPU AC13+1 300/12.5 LH	A.28
2983590000	VPU AC13+1 R 300/12.5 LH	A.4
2983590000	VPU AC13+1 R 300/12.5 LH	A.28
2983600000	VPU AC1 4 300/12.5 LH	A.4
2983600000	VPU AC1 4 300/12.5 LH	A.28
2983610000	VPU AC1 4 R 300/12.5 LH	A.4
2983610000	VPU AC1 4 R 300/12.5 LH	A.28

3010000000

3012980000	VPU PVI+II 5 1500	B.2
3012980000	VPU PVI+II 5 1500	B.10
3012990000	VPU PVI+II 5 R 1500	B.2
3012990000	VPU PVI+II 5 R 1500	B.10

3020000000

3022890000	VPU AC1 F 3 275/25	A.4
3022890000	VPU AC1 F 3 275/25	A.22
3022900000	VPU AC1 F 3 R 275/25	A.4
3022900000	VPU AC1 F 3 R 275/25	A.22
3022910000	VPU AC1 F 3+1 275/25	A.4
3022910000	VPU AC1 F 3+1 275/25	A.23
3022920000	VPU AC1 F 3+1 R 275/25	A.4
3022920000	VPU AC1 F 3+1 R 275/25	A.23

3030000000

3037010000	VPU AC1 1 N-PE 305/50 LH	A.5
3037010000	VPU AC1 1 N-PE 305/50 LH	A.33
3038720000	V-ZPA FUSE HOLDER E	A.5
3038720000	V-ZPA FUSE HOLDER E	A.48

8440000000

8448920000	MC2 OVP CL 24VDC 0,5A	C.108
8448940000	MC2 OVP SL 24VDC 0,5A	C.109
8448960000	MC2 OVP CL 24VUC 1,25A	C.109
8448970000	MC2 OVP SL 24VUC 1,25A	C.110
8449000000	MC2 OVP CL 48VUC 0,5A	C.110
8449030000	MC2 OVP SL 48VUC 0,5A	C.111
8449040000	MC2 OVP CL 48VUC 1,25A	C.111
8449050000	MC2 OVP SL 48VUC 1,25A	C.112

8470000000

8472880000	MC2 OVP CL 24VAC 0,5A	C.108
------------	-----------------------	-------

8610000000

8614770000	WAVEFILTER 10A	E.5
8614780000	WAVEFILTER 3A	E.4
8614800000	WAVEFILTER 6A	E.4

8700000000

8704240000	MC2 OVP CL FG 24VUC 0,5A	C.113
------------	--------------------------	-------

8820000000

8823280000	MC2 OVP SL FG 24VUC 0,5A	C.112
------------	--------------------------	-------

8920000000

8924200000	VSPC 4SL 5VDC	C.35
8924210000	VSPC 2SL 5VDC	C.3
8924210000	VSPC 2SL 5VDC	C.31
8924220000	VSPC 4SL 12VDC	C.35
8924230000	VSPC 2SL 12VDC	C.31
8924260000	VSPC BASE 4SL FG	C.34
8924260000	VSPC BASE 4SL FG	C.53
8924270000	VSPC BASE 2CL FG	C.2
8924270000	VSPC BASE 2CL FG	C.3
8924270000	VSPC BASE 2CL FG	C.4
8924270000	VSPC BASE 2CL FG	C.20
8924270000	VSPC BASE 2CL FG	C.24
8924270000	VSPC BASE 2CL FG	C.46
8924270000	VSPC BASE 2CL FG	C.48
8924270000	VSPC BASE 2CL FG	C.52
8924270000	VSPC BASE 2CL FG	C.53
8924270000	VSPC BASE 2CL FG	D.4
8924270000	VSPC BASE 2CL FG	D.8
8924280000	VSPC BASE 2SL FG	C.3
8924280000	VSPC BASE 2SL FG	C.30
8924280000	VSPC BASE 2SL FG	C.53
8924280000	VSPC BASE 2SL FG	C.53
8924290000	VSPC BASE 1CL FG	C.2
8924290000	VSPC BASE 1CL FG	C.3
8924290000	VSPC BASE 1CL FG	C.16
8924290000	VSPC BASE 1CL FG	C.53
8924300000	VSPC BASE 2/4CH FG	C.2
8924300000	VSPC BASE 2/4CH FG	C.3
8924300000	VSPC BASE 2/4CH FG	C.38
8924300000	VSPC BASE 2/4CH FG	C.40
8924300000	VSPC BASE 2/4CH FG	C.42

Order No.	Type	Page
8924300000	VSPC BASE 2/4CH FG	C.44
8924300000	VSPC BASE 2/4CH FG	C.53
8924320000	VSPC 4SL 24VDC	C.35
8924330000	VSPC 2SL 24VDC	C.31
8924340000	VSPC 4SL 24VAC	C.35
8924350000	VSPC 2SL 24VAC	C.31
8924360000	VSPC 4SL 48VAC	C.35
8924370000	VSPC 2SL 48VAC	C.31
8924380000	VSPC 4SL 60VAC	C.35
8924400000	VSPC 2CL 5VDC	C.21
8924420000	VSPC 1CL 5VDC	C.3
8924420000	VSPC 1CL 5VDC	C.17
8924430000	VSPC 2CL HF 5VDC	C.3
8924430000	VSPC 2CL HF 5VDC	C.4
8924430000	VSPC 2CL HF 5VDC	C.25
8924430000	VSPC 2CL HF 5VDC	D.5
8924440000	VSPC 2CL 12VDC	C.3
8924440000	VSPC 2CL 12VDC	C.21
8924450000	VSPC 1CL 12VDC	C.2
8924450000	VSPC 1CL 12VDC	C.3
8924450000	VSPC 1CL 12VDC	C.17
8924460000	VSPC 2CL HF 12VDC	C.2
8924460000	VSPC 2CL HF 12VDC	C.3
8924460000	VSPC 2CL HF 12VDC	C.24
8924460000	VSPC 2CL HF 12VDC	C.45
8924460000	VSPC 2CL HF 12VDC	D.5
8924470000	VSPC 2CL 24VDC	C.2
8924470000	VSPC 2CL 24VDC	C.4
8924470000	VSPC 2CL 24VDC	C.21
8924480000	VSPC 1CL 24VDC	C.2
8924480000	VSPC 1CL 24VDC	C.3
8924480000	VSPC 1CL 24VDC	C.17
8924490000	VSPC 2CL 24VAC	C.21
8924500000	VSPC 1CL 24VAC	C.17
8924510000	VSPC 2CL HF 24VDC	C.3
8924510000	VSPC 2CL HF 24VDC	C.25
8924510000	VSPC 2CL HF 24VDC	D.5
8924520000	VSPC 1CL 48VAC	C.3
8924520000	VSPC 1CL 48VAC	C.17
8924530000	VSPC 1CL 60VAC	C.17
8924540000	VSPC 3/4WIRE 5VDC	C.39
8924550000	VSPC 3/4WIRE 24VDC	C.39
8924570000	VSPC GDT 2CH 90V	C.2
8924570000	VSPC GDT 2CH 90V	C.3
8924570000	VSPC GDT 2CH 90V	C.41
8924580000	VSPC GDT 2CH 150VAC/230VDC	C.41
8924600000	VSPC MOV 2CH 24V	C.43
8924610000	VSPC MOV 2CH 230V	C.43
8924650000	VSPC TAZ 4CH 24V	C.45
8924660000	VSPC TELE UKO 2WIRE	C.3
8924660000	VSPC TELE UKO 2WIRE	C.4
8924660000	VSPC TELE UKO 2WIRE	C.47
8924670000	VSPC RS485 2CH	C.2
8924670000	VSPC RS485 2CH	C.3
8924670000	VSPC RS485 2CH	C.49
8924670000	VSPC RS485 2CH	D.9
8924680000	VSPC GROUND	C.56
8924700000	VSPC BASE 4SL	C.34
8924700000	VSPC BASE 4SL	C.52
8924710000	VSPC BASE 2CL	C.2
8924710000	VSPC BASE 2CL	C.3
8924710000	VSPC BASE 2CL	C.4
8924710000	VSPC BASE 2CL	C.20
8924710000	VSPC BASE 2CL	C.24
8924710000	VSPC BASE 2CL	C.46
8924710000	VSPC BASE 2CL	C.48
8924710000	VSPC BASE 2CL	C.52
8924710000	VSPC BASE 2CL	D.4
8924710000	VSPC BASE 2CL	D.8
8924720000	VSPC BASE 2SL	C.3
8924720000	VSPC BASE 2SL	C.30
8924720000	VSPC BASE 2SL	C.52
8924730000	VSPC BASE 1CL	C.2
8924730000	VSPC BASE 1CL	C.3
8924730000	VSPC BASE 1CL	C.16
8924740000	VSPC BASE 2/4CH	C.2
8924740000	VSPC BASE 2/4CH	C.3
8924740000	VSPC BASE 2/4CH	C.38
8924740000	VSPC BASE 2/4CH	C.40
8924740000	VSPC BASE 2/4CH	C.42
8924740000	VSPC BASE 2/4CH	C.44
8924740000	VSPC BASE 2/4CH	C.52

8940000000

8948600000	MC2 OVP HF 24V 0,3A	C.2
8948600000	MC2 OVP HF 24V 0,3A	C.3
8948600000	MC2 OVP HF 24V 0,3A	C.107
8948610000	MC2 OVP HF 12V 0,3A	C.2
8948610000	MC2 OVP HF 12V 0,3A	C.3
8948610000	MC2 OVP HF 12V 0,3A	C.106
8948620000	MC2 OVP HF 5V 0,3A	C.2
8948620000	MC2 OVP HF 5V 0,3A	C.3
8948620000	MC2 OVP HF 5V 0,3A	C.106

8950000000

8951460000	VSPC 2CL 5VDC R	C.23
------------	-----------------	------

Order No.	Type	Page
8951470000	VSPC 2CL 12VDC R	C.23
8951480000	VSPC 2CL 24VDC R	C.23
8951490000	VSPC 2CL 48VAC	C.21
8951510000	VSPC 1CL PW 24V	C.29
8951530000	VSPC 1CL 5VDC R	C.19
8951540000	VSPC 1CL 12VDC R	C.19
8951550000	VSPC 1CL 24VDC R	C.19
8951560000	VSPC 1CL 24VAC R	C.19
8951570000	VSPC 4SL 5VDC R	C.37
8951580000	VSPC 4SL 12VDC R	C.37
8951590000	VSPC 4SL 24VDC R	C.37
8951600000	VSPC 4SL 24VAC R	C.37
8951610000	VSPC 2SL 5VDC R	C.33
8951620000	VSPC 2SL 12VDC R	C.33
8951630000	VSPC 2SL 24VDC R	C.33
8951640000	VSPC 2SL 24VAC R	C.33
8951650000	VSPC MOV 2CH 24V R	C.43
8951660000	VSPC MOV 2CH 230V R	C.43
8951670000	VSPC RS485 2CH R	C.51
8951670000	VSPC RS485 2CH R	D.11
8951680000	VSPC 2CL HF 5VDC R	C.27
8951680000	VSPC 2CL HF 5VDC R	D.7
8951690000	VSPC 2CL HF 12VDC R	C.27
8951690000	VSPC 2CL HF 12VDC R	D.7
8951700000	VSPC 2CL HF 24VDC R	C.27
8951700000	VSPC 2CL HF 24VDC R	D.7
8951710000	VSPC BASE 2CL R	C.22
8951710000	VSPC BASE 2CL R	C.26
8951710000	VSPC BASE 2CL R	C.50
8951710000	VSPC BASE 2CL R	C.55
8951710000	VSPC BASE 2CL R	D.6
8951730000	VSPC BASE 1CL R	C.18
8951730000	VSPC BASE 1CL R	C.54
8951740000	VSPC BASE 1CL FG R	C.18
8951740000	VSPC BASE 1CL FG R	C.55
8951750000	VSPC BASE 4SL R	C.36
8951750000	VSPC BASE 4SL R	C.54
8951760000	VSPC BASE 4SL FG R	C.36
8951760000	VSPC BASE 4SL FG R	C.55
8951770000	VSPC BASE 2SL R	C.32
8951770000	VSPC BASE 2SL R	C.54
8951780000	VSPC BASE 2SL FG R	C.32
8951780000	VSPC BASE 2SL FG R	C.55
8951790000	VSPC BASE 2/4CH R	C.42
8951790000	VSPC BASE 2/4CH R	C.54
8951790000	VSPC BASE 2/4CH R	D.10
8951800000	VSPC BASE 2/4CH FG R	C.42
8951800000	VSPC BASE 2/4CH FG R	C.55
8951800000	VSPC BASE 2/4CH FG R	D.10
8951810000	VSPC BASE 1CL FG EX	C.132
8951810000	VSPC BASE 1CL FG EX	C.144
8951820000	VSPC BASE 2CL FG EX	C.134
8951820000	VSPC BASE 2CL FG EX	C.144
8951830000	VSPC BASE 2SL FG EX	C.138
8951830000	VSPC BASE 2SL FG EX	C.144
8951840000	VSPC BASE 4SL FG EX	C.140
8951840000	VSPC BASE 4SL FG EX	C.144
8951850000	VSPC BASE 2/4CH FG EX	C.142
8951850000	VSPC BASE 2/4CH FG EX	C.144
8951860000	V-TEST	F.10
8953590000	VSPC 1CL 12VDC EX	C.133
8953600000	VSPC 1CL 24VDC EX	C.133
8953610000	VSPC 1CL PW 24V EX	C.137
8953620000	VSPC 2SL 12VDC EX	C.139
8953630000	VSPC 2SL 12VAC EX	C.139
8953640000	VSPC 2SL 48VAC EX	C.139
8953650000	VSPC 3/4WIRE 5VDC EX	C.143
8953660000	VSPC 1CL 5VDC EX	C.133
8953670000	VSPC 2SL 24VDC EX	C.139
8953720000	VSPC 2CL 24VDC EX	C.135

8970000000

8972270000	VSPC CONTROL UNIT 24VDC	C.57
------------	-------------------------	------

Addresses worldwide

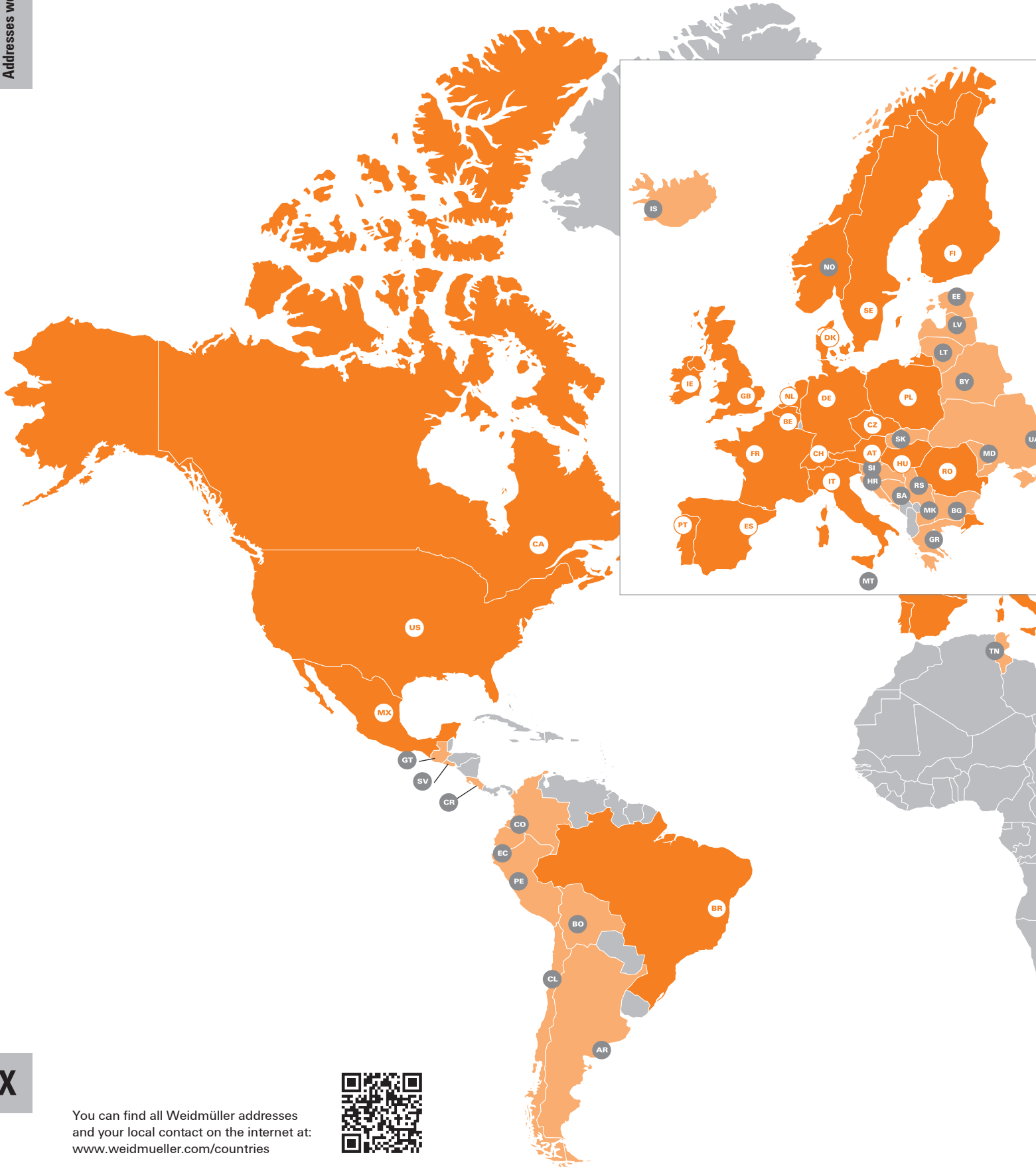

X

You can find all Weidmüller addresses and your local contact on the internet at: www.weidmueller.com/countries



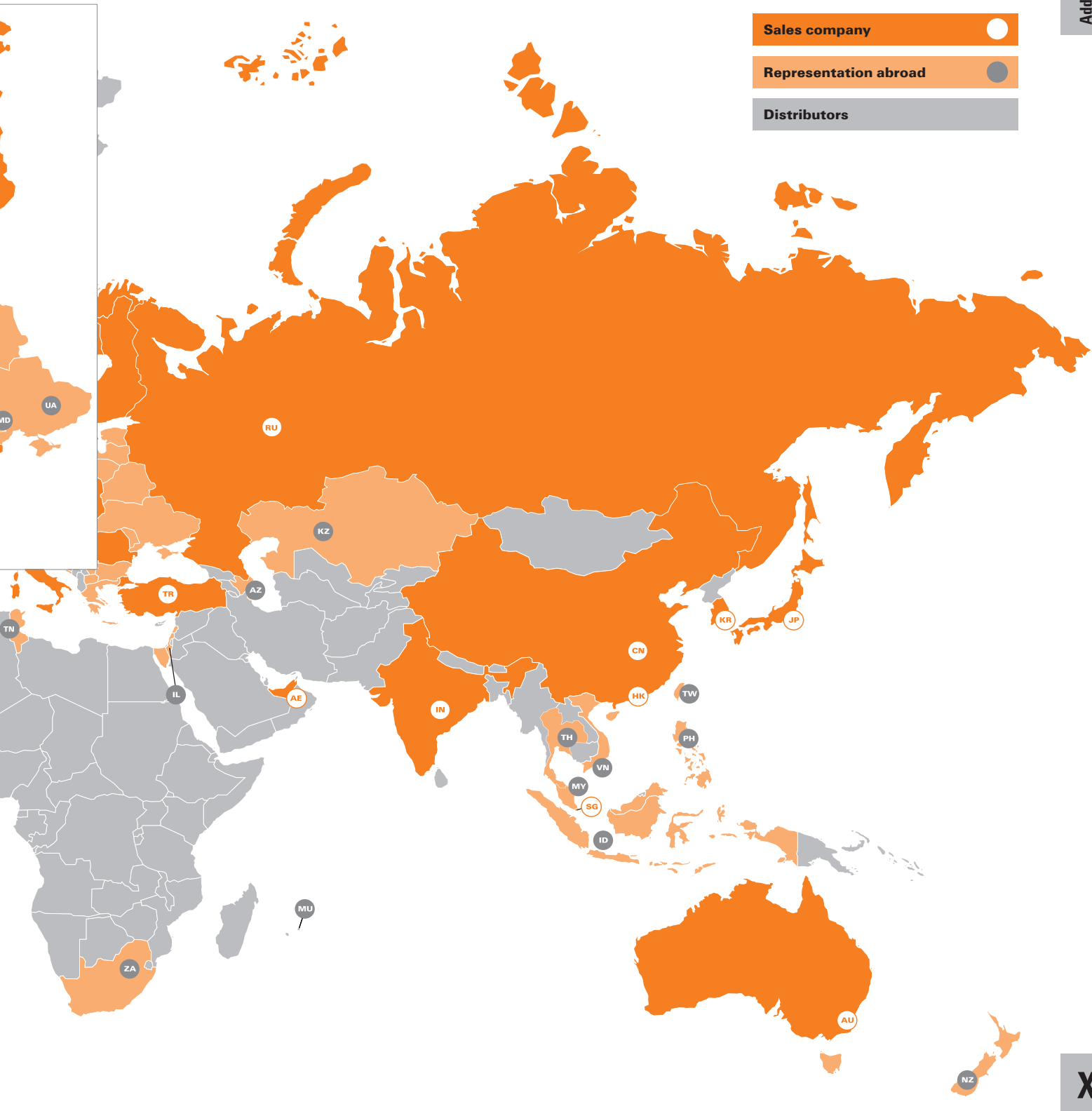

We cannot guarantee that there are no mistakes in the publications or software provided by us to the customer for the purpose of making orders. We try our best to quickly correct errors in our printed media.

X

All orders are based on our general terms of delivery, which can be reviewed on the websites of our group companies where you place your order. On demand we can also send the general terms of delivery to you.

Weidmüller – Your partner in Smart Industrial Connectivity

As experienced experts we support our customers and partners around the world with products, solutions and services in the industrial environment of power, signal and data. We are at home in their industries and markets and know the technological challenges of tomorrow. We are therefore continuously developing innovative, sustainable and useful solutions for their individual needs. Together we set standards in Smart Industrial Connectivity.

Weidmüller Interface GmbH & Co. KG
Klingenbergstraße 26
32758 Detmold, Germany
T +49 5231 14-0
F +49 5231 14-292083
www.weidmueller.com

Personal support can
be found on our website:
www.weidmueller.com/contact

Made in Germany



Order number: 3016790000/08/2024/SMD