

Analogue signal conditioning

Version 2024



Weidmüller 

Analogue signal processing

Catalogue 4.1

Analogue signal processing

Network-compatible current measuring transducers – ACT20C

Intrinsically safe signal converters – ACT20X

Signal converters and monitoring components – ACT20P

Space-saving signal converters – ACT20M

Signal converters in terminal format – MCZ

Compact signal converter – PicoPak

Process value displays

Configuration software

Accessories

Appendix

Service and support

Technical appendix/Glossary

Index

Index type / Order No.

Analogue signal processing

Network-compatible current measuring transducers – ACT20C

Page A.2



- Separation and conversion of current or voltage signals
- Limit value monitoring, diagnosis, monitoring via Ethernet network
- PC configuration with FDT/DTM software

Intrinsically safe signal converters – ACT20X

Page B.2



- Analogue and binary signal interfaces to Ex Zone 0 / Division 1
- FDT/DTM software configurable
- 2 channel modules in 22.5 mm housing

Signal converters and monitoring components – ACT20P

Page C.2



- Separation and conversion of temperature and DC signals (3-way isolation, supply isolators and passive isolators)
- Strain gauge transmitter for reading from load cells
- High levels of galvanic isolation and accuracy

Space-saving signal converters – ACT20M

Page D.2



- Isolating and converting of temperature signals and DC signals (3-way isolation, supply isolators and passive isolators)
- Up to 2 channels with a width of 6 mm
- Power supply via the CH20M DIN rail bus

Signal converters in terminal format – MCZ

Page E.2



- Signal converter in terminal format
- Passive isolator, temperature/frequency converter and threshold monitoring
- Simple wiring with pluggable cross-connection channels

Compact signal converter – PicoPak

Page F.2



- Saves space in the panel thanks to the narrow 6 mm width
- Passive insulator, loop spliced at the input and output
- Increased operating temperature range -40°C ...+70°C

Process value displays

Page G.2



- Large four-character LED display
- 1/8"-DIN-standard front-panel with IP 65 protection
- Integrated signal converter and trip amplifier

Configuration software

Page H.2



- Supports FDT and FDT2
- Central data management
- Integrated safety
- Device configurator

Accessories

Page I.2



- Configuration adapter
- Power-feed modules
- Calibrators

Service and support

Service connects – worldwide

Page V.2



- Service connects – worldwide
- Engineering services and customised products
- easyConnect – Your Industrial Service Platform
- Support Center
- Additional support services
- Weidmüller Configurator

Digital ordering options

Page V.10



Purchasing made easy:

- Weidmüller eShop
- OCI interface
- EDI interface

Quick select – Analogue Signal Conditioning

Selection table

Order No.	Product	Input										Width
		Number of channels	0...20 mA	4...20 mA	0...10 V	0...5 V	TC	RTD	Frequency	Miscellaneous	sensor feed	
Network-compatible current measuring transducers – ACT20C												
Gateway												
1510370000	ACT20C-GTW-100-MTCP-S	1									RJ45, Modbus TCP	22.5 mm
Current and voltage transformers												
1510240000	ACT20C-CMT-10-AO-RC-S	1									0...5/10 A AC/DC	22.5 mm
1510420000	ACT20C-CMT-60-AO-RC-S	1									0...40/50/60 A AC/DC	22.5 mm
2044840000	ACT20C-CML-10-AO-RC-S	1									0...1/5/10 A AC/DC	22.5 mm
Bus termination terminal												
1510340000	ACT20C-LBT-10	0										20.6 mm
Intrinsically safe signal converters – ACT20X												
Supply isolator												
8965430000	ACT20X-HAI-SAO-S	1	X	X							HART® transparent	X 22.5 mm
2456140000	ACT20X-HAI-SAO-P	1	X	X							HART® transparent	X 22.5 mm
8965440000	ACT20X-2HAI-2SAO-S	2	X	X							HART® transparent	X 22.5 mm
2456150000	ACT20X-2HAI-2SAO-P	2	X	X							HART® transparent	X 22.5 mm
Output driver												
8965450000	ACT20X-SAI-HAO-S	1		X							HART® transparent	22.5 mm
2456160000	ACT20X-SAI-HAO-P	1		X							HART® transparent	22.5 mm
8965460000	ACT20X-2SAI-2HAO-S	2		X							HART® transparent	22.5 mm
2456170000	ACT20X-2SAI-2HAO-P	2		X							HART® transparent	22.5 mm
Temperature transducer												
8965470000	ACT20X-HTI-SAO-S	1	X	X			X	X			Temperature + mA	22.5 mm
2456180000	ACT20X-HTI-SAO-P	1	X	X			X	X			Temperature + mA	22.5 mm
8965480000	ACT20X-2HTI-2SAO-S	2	X	X			X	X			Temperature + mA	22.5 mm
2456190000	ACT20X-2HTI-2SAO-P	2	X	X			X	X			Temperature + mA	22.5 mm
Switching amplifier												
8965340000	ACT20X-HDI-SDO-RNO-S	1									Namur, switching signal	X 22.5 mm
2456050000	ACT20X-HDI-SDO-RNO-P	1									Namur, switching signal	X 22.5 mm
8965350000	ACT20X-HDI-SDO-RNC-S	1									Namur, switching signal	X 22.5 mm
2456060000	ACT20X-HDI-SDO-RNC-P	1									Namur, switching signal	X 22.5 mm
8965370000	ACT20X-2HDI-2SDO-RNO-S	2									Namur, switching signal	X 22.5 mm
2456080000	ACT20X-2HDI-2SDO-RNO-P	2									Namur, switching signal	X 22.5 mm
8965380000	ACT20X-2HDI-2SDO-RNC-S	2									Namur, switching signal	X 22.5 mm
2456090000	ACT20X-2HDI-2SDO-RNC-P	2									Namur, switching signal	X 22.5 mm
8965360000	ACT20X-HDI-SDO-S	1									Namur, switching signal	X 22.5 mm
2456070000	ACT20X-HDI-SDO-P	1									Namur, switching signal	X 22.5 mm
8965390000	ACT20X-2HDI-2SDO-S	2									Namur, switching signal	X 22.5 mm
2456100000	ACT20X-2HDI-2SDO-P	2									Namur, switching signal	X 22.5 mm
Solenoid drivers												
8965400000	ACT20X-SDI-HDO-L-S	1									NPN / PNP switching signal	22.5 mm
2456100000	ACT20X-SDI-HDO-L-P	1									NPN / PNP switching signal	22.5 mm
8965420000	ACT20X-2SDI-2HDO-S	2									NPN / PNP switching signal	22.5 mm
2456120000	ACT20X-2SDI-2HDO-P	2									NPN / PNP switching signal	22.5 mm
8965410000	ACT20X-SDI-HDO-H-S	1									NPN / PNP switching signal	22.5 mm
2456120000	ACT20X-SDI-HDO-H-P	1									NPN / PNP switching signal	22.5 mm
Universal measurement transducers												
8965490000	ACT20X-HUI-SAO-S	1	X	X	X	X	X	X			Temperature + mA + V	X 22.5 mm
2456200000	ACT20X-HUI-SAO-P	1	X	X	X	X	X	X			Temperature + mA + V	X 22.5 mm

Number outputs	Output						Configuration	Auxiliary power	Rated insulation voltage	Isolation			Special characteristics
	0...20 mA	4...20 mA	0...10 V	Switching signal	Limit value, digital	Status, digital				Miscellaneous	Rail bus	Ex approval	
0							Software	24 V DC	30 V	3-way	X	X	Modbus TCP Gateway
1	X	X	X	X	X	± 20 mA, 1 x CO	Software	24 V DC	300 V	4-way	X	X	Through hole current converter
1	X	X	X	X	X	± 20 mA, 1 x CO	Software	24 V DC	300 V	4-way	X	X	Through hole current converter
1	X	X	X	X	X	± 20 mA, 1 x CO	Software	24 V DC	300 V	4-way	X	X	Current carrying conductor at the terminals
0											X	X	Electrical termination on mounting rail bus, ACT20C station
1		X				X 1 x NC	Software	24 V DC	300 V	3-way		X	X
1		X				X 1 x NC	Software	24 V DC	300 V	3-way		X	X
2		X				X 1 x NC	Software	24 V DC	300 V	3-way		X	X
2		X				X 1 x NC	Software	24 V DC	300 V	3-way		X	X
1		X				X 1 x NC	Software	24 V DC	300 V	3-way		X	X
1		X				X 1 x NC	Software	24 V DC	300 V	3-way		X	X
2		X				X 1 x NC	Software	24 V DC	300 V	3-way		X	X
2		X				X 1 x NC	Software	24 V DC	300 V	3-way		X	X
1	X	X				X 1 x NC	Software	24 V DC	300 V	3-way		X	X
1	X	X				X 1 x NC	Software	24 V DC	300 V	3-way		X	X
2	X	X				X 1 x NC	Software	24 V DC	300 V	3-way		X	X
2	X	X				X 1 x NC	Software	24 V DC	300 V	3-way		X	X
1				X	X	1 x NO, 1 x NC	Software	24 V DC	300 V	3-way		X	X
1				X	X	1 x NO, 1 x NC	Software	24 V DC	300 V	3-way		X	X
1				X	X	1 x NO, 1 x NC	Software	24 V DC	300 V	3-way		X	X
1				X	X	1 x NO, 1 x NC	Software	24 V DC	300 V	3-way		X	X
2				X	X	1 x NO, 1 x NC	Software	24 V DC	300 V	3-way		X	X
2				X	X	1 x NO, 1 x NC	Software	24 V DC	300 V	3-way		X	X
2				X	X	1 x NO, 1 x NC	Software	24 V DC	300 V	3-way		X	X
2				X	X	1 x NO, 1 x NC	Software	24 V DC	300 V	3-way		X	X
1				X	X	1 x NPN, 1 x NC	Software	24 V DC	300 V	3-way		X	X
1				X	X	1 x NPN, 1 x NC	Software	24 V DC	300 V	3-way		X	X
2				X	X	1 x NPN, 1 x NC	Software	24 V DC	300 V	3-way		X	X
2				X	X	1 x NPN, 1 x NC	Software	24 V DC	300 V	3-way		X	X
1				X	X	1 x NPN/PNP, 1 x NC	Software	24 V DC	300 V	3-way		X	X
1				X	X	1 x NPN/PNP, 1 x NC	Software	24 V DC	300 V	3-way		X	X
2				X	X	1 x NPN/PNP, 1 x NC	Software	24 V DC	300 V	3-way		X	X
2				X	X	1 x NPN/PNP, 1 x NC	Software	24 V DC	300 V	3-way		X	X
1				X	X	1 x NPN/PNP, 1 x NC	Software	24 V DC	300 V	3-way		X	X
1				X	X	1 x NPN/PNP, 1 x NC	Software	24 V DC	300 V	3-way		X	X
1	X	X			X	1 x NO, 1 x NC	Software	24 V DC	300 V	3-way		X	X
1	X	X			X	1 x NO, 1 x NC	Software	24 V DC	300 V	3-way		X	X

Connection system: S = screw / Z = tension clamp / P = Push In, ILP = Input Loop Powered, OLP = Output Loop Powered, *) = in preparation

Quick select – Analogue Signal Conditioning

Selection table

Order No.	Product	Input										Width
		Number of channels	0...20 mA	4...20 mA	0...10 V	0...5 V	TC	RTD	Frequency	Miscellaneous	sensor feed	
Signalwandler und Prozessüberwachung – ACT20P												
Supply isolator												
7760054114	ACT20P-CI-CO-S	1	X	X							2-/3-/4-wire sensor, HART® transparent	X 12.5 mm
2489680000	ACT20P-CI-CO-P	1	X	X							2-/3-/4-wire sensor, HART® transparent	X 12.5 mm
1506200000	ACT20P-CI-CO-P-S	1	X	X							2-/3-/4-wire sensor, HART® transparent	X 12.5 mm
2514620000	ACT20P-CI-CO-P-P	1	X	X							2-/3-/4-wire sensor, HART® transparent	X 12.5 mm
1540010000	ACT20P-CI-VO-S	1	X	X							2-/3-/4-wire sensor	X 12.5 mm
2489740000	ACT20P-CI-VO-P	1	X	X							2-/3-/4-wire sensor	X 12.5 mm
1537750000	ACT20P-CI-VO-P-S	1	X	X							2-/3-/4-wire sensor	X 12.5 mm
2514640000	ACT20P-CI-VO-P-P	1	X	X							2-/3-/4-wire sensor	X 12.5 mm
7760054115	ACT20P-CI-2CO-S	1	X	X							2-/3-/4-wire sensor, HART® transparent	X 12.5 mm
2489710000	ACT20P-CI-2CO-P	1	X	X							2-/3-/4-wire sensor, HART® transparent	X 12.5 mm
1506220000	ACT20P-CI-2CO-P-S	1	X	X							2-/3-/4-wire sensor, HART® transparent	X 12.5 mm
2514630000	ACT20P-CI-2CO-P-P	1	X	X							2-/3-/4-wire sensor, HART® transparent	X 12.5 mm
Isolation amplifier												
7760054117	ACT20P-2CI-2CO-12-S	2	X	X							4-wire sensor, HART® transparent	12.5 mm
2489730000	ACT20P-2CI-2CO-12-P	2	X	X							4-wire sensor, HART® transparent	12.5 mm
1506210000	ACT20P-2CI-2CO-12P-S	2	X	X							4-wire sensor, HART® transparent	12.5 mm
2514650000	ACT20P-2CI-2CO-12-P-P	2	X	X							4-wire sensor, HART® transparent	12.5 mm
Standard converter												
1477420000	ACT20P-AI-AO-DC-S	1	X	X	X	X						X 12.5 mm
2456860000	ACT20P-AI-AO-DC-P	1	X	X	X	X						X 12.5 mm
1545720000	ACT20P-AI-AO-AC-S	1	X	X	X	X						X 12.5 mm
2495700000	ACT20P-AI-AO-ACP	1	X	X	X	X						X 12.5 mm
Passive isolators												
7760054123	ACT20P-CI-CO-IHP-S	1	X	X							4-wire sensor	12.5 mm
7760054357	ACT20P-CI-CO-IHP-P	1	X	X							4-wire sensor	12.5 mm
7760054124	ACT20P-2CI-2CO-IHP-S	2	X	X							4-wire sensor	12.5 mm
7760054358	ACT20P-2CI-2CO-IHP-P	2	X	X							4-wire sensor	12.5 mm
7760054118	ACT20P-CI1-CO-DLP-S	1	X								4-wire sensor	12.5 mm
7760054353	ACT20P-CI1-CO-DLP-P	1	X								4-wire sensor	12.5 mm
7760054119	ACT20P-CI2-CO-DLP-S	1		X							4-wire sensor	12.5 mm
7760054354	ACT20P-CI2-CO-DLP-P	1		X							4-wire sensor	12.5 mm
7760054121	ACT20P-VI-CO-DLP-S	1			X						4-wire sensor	12.5 mm
7760054356	ACT20P-VI-CO-DLP-P	1			X						4-wire sensor	12.5 mm
7760054120	ACT20P-VI1-CO-DLP-S	1				X					4-wire sensor	12.5 mm
7760054355	ACT20P-VI1-CO-DLP-P	1				X					4-wire sensor	12.5 mm
7760054122	ACT20P-CI-2CO-DLP-S	1		X							4-wire sensor	12.5 mm
2619390000	ACT20P-CI-2CO-DLP-P	1		X							4-wire sensor	12.5 mm
Temperature transducer												
2448100000	ACT20P-PRO-RTCI-AO-D0-S	1					X	X			RTD, Thermocouple, Pot, mV, resistance	12.5 mm
2448110000	ACT20P-PRO-RTCI-AO-D0-P	1					X	X			RTD, Thermocouple, Pot, mV, resistance	12.5 mm
2489890000	ACT20P-PRO-RTC-AO-D0S-S	1					X	X			RTD, Thermocouple, Pot, mV, resistance	12.5 mm
2490030000	ACT20P-PRO-RTC-AO-D0S-P	1					X	X			RTD, Thermocouple, Pot, mV, resistance	12.5 mm
7760054233	ACT20P-RTI-AO-S	1						X			PT100 (3 Conductor), Cu50, Cu100	12.5 mm
7760054183	ACT20P-RTI-AO-P	1						X			PT100 (3 Conductor), Cu50, Cu100	12.5 mm
7760054236	ACT20P-RTI-2AO-S	1						X			PT100 (3 Conductor), Cu50, Cu100	12.5 mm
7760054187	ACT20P-RTI-2AO-P	1						X			PT100 (3 Conductor), Cu50, Cu100	12.5 mm
7760054234	ACT20P-TCI-AO-S	1					X				Thermocouple type T,E,J,K,N,R,S,B	12.5 mm
7760054184	ACT20P-TCI-AO-P	1					X				Thermocouple type T,E,J,K,N,R,S,B	12.5 mm
7760054237	ACT20P-TCI-2AO-S	1					X				Thermocouple type T,E,J,K,N,R,S,B	12.5 mm
7760054188	ACT20P-TCI-2AO-P	1					X				Thermocouple type T,E,J,K,N,R,S,B	12.5 mm

Number outputs	Output						Configuration	Auxiliary power	Rated insulation voltage	Isolation	Rail bus	Ex approval	Shipbuilding approval	Special characteristics
	0...20 mA	4...20 mA	0...10 V	Switching signal	Limit value, digital	Status, digital								
1	X	X					-	24 V DC	300 V	3-way		X		
1	X	X					-	24 V DC	300 V	3-way		X		
1	X	X					-	24 V DC	300 V	3-way	X	X		
1	X	X					-	24 V DC	300 V	3-way	X	X		
1			X				-	24 V DC	300 V	3-way		X		
1			X				-	24 V DC	300 V	3-way	X	X		
1	X	X	X				-	24 V DC	300 V	3-way	X	X		
2	X	X					-	24 V DC	300 V	4-way		X	Splitter	
2	X	X					-	24 V DC	300 V	4-way		X	Splitter	
2	X	X					-	24 V DC	300 V	4-way	X	X	Splitter	
2	X	X					-	24 V DC	300 V	4-way	X	X	Splitter	
2	X	X					-	24 V DC	300 V	3-way		X		
2	X	X					-	24 V DC	300 V	3-way		X		
2	X	X					-	24 V DC	300 V	3-way	X	X		
2	X	X					-	24 V DC	300 V	3-way	X	X		
1	X	X	X				DIP switch, button LED	12...60 V DC	300 V	3-way				
1	X	X	X				DIP switch, button LED	12...60 V DC	300 V	3-way				
1	X	X	X				DIP switch, button LED	90...264 V AC	300 V	3-way				
1	X	X	X				DIP switch, button LED	90...264 V AC	300 V	3-way				
1	X	X					-	input loop	300 V	2-way		X		
1	X	X					-	input loop	300 V	2-way		X		
2	X	X					-	input loop	300 V	2-way		X		
2	X	X					-	input loop	300 V	2-way		X		
1		X					-	output loop	300 V	2-way		X		
1		X					-	output loop	300 V	2-way		X		
1		X					-	output loop	300 V	2-way		X		
1		X					-	output loop	300 V	2-way		X		
1		X					-	output loop	300 V	2-way		X		
1		X					-	output loop	300 V	2-way		X		
1		X					-	output loop	300 V	2-way		X		
1		X					-	output loop	300 V	2-way		X		
2	X	X					-	output loop	300 V	3-way		X	Splitter	
2	X	X					-	output loop	300 V	3-way		X	Splitter	
1	X	X	X	X		1 x NPN	Display, button	24...240 V UC	300 V	4-way		*)	X	
1	X	X	X	X		1 x NPN	Display, button	24...240 V UC	300 V	4-way		*)	X	
1	X	X	X	X		1 x NPN	Display, button	24...240 V UC	300 V	4-way		*)	X with SIL function *)	
1	X	X	X	X		1 x NPN	Display, button	24...240 V UC	300 V	4-way		*)	X with SIL function *)	
1	X	X					Software	24 V DC	300 V	3-way				
1	X	X					Software	24 V DC	300 V	3-way				
2	X	X					Software	24 V DC	300 V	4-way			Splitter	
2	X	X					Software	24 V DC	300 V	4-way			Splitter	
1	X	X					Software	24 V DC	300 V	3-way				
1	X	X					Software	24 V DC	300 V	3-way				
2	X	X					Software	24 V DC	300 V	4-way			Splitter	
2	X	X					Software	24 V DC	300 V	4-way			Splitter	

Connection system: S = screw / Z = tension clamp / P = Push In, ILP = Input Loop Powered, OLP = Output Loop Powered, *) = in preparation

Quick select – Analogue Signal Conditioning

Selection table

Order No.	Product	Input								Miscellaneous	sensor feed	Width
		Number of channels	0...20 mA	4...20 mA	0...10 V	0...5 V	TC	RTD	Frequency			
Limit switch												
7760054305	ACT20P-TMR-RT-I-S	1						X		PT100		22.5 mm
7760054352	ACT20P-TMR-RT-I-P	1						X		PT100		22.5 mm
7940045760	ACT20P-UI-2R2CO-DC-S	1	X	X	X	X	X	X		± 25 mA, ± 5 A DC, ± 30 V DC, ± 300 V DC, potentiometer, resistance	X	22.5 mm
2456840000	ACT20P-UI-2R2CO-DC-P	1	X	X	X	X	X	X		± 25 mA, ± 5 A DC, ± 30 V DC, ± 300 V DC, potentiometer, resistance	X	22.5 mm
1238910000	ACT20P-UI-2R2CO-AC-S	1	X	X	X	X	X	X		± 25 mA, ± 5 A DC, ± 30 V DC, ± 300 V DC, potentiometer, resistance	X	22.5 mm
2495690000	ACT20P-UI-2R2CO-AC-P	1	X	X	X	X	X	X		± 25 mA, ± 5 A DC, ± 30 V DC, ± 300 V DC, potentiometer, resistance	X	22.5 mm
7760054164	ACT20P-VMR-1PH-H-S	1								1 phase 0...400 V AC/DC		22.5 mm
7760054359	ACT20P-VMR-1PH-H-P	1								1 phase 0...400 V AC/DC		22.5 mm
7760054165	ACT20P-VMR-3PH-I-LP-H-S	1								3 phases 180...500 V AC		22.5 mm
7760054361	ACT20P-VMR-3PH-I-LP-H-P	1								3 phase 180...500 V AC		22.5 mm
Current and voltage transformers												
2044850000	ACT20P-CML-10-AO-RC-S	1								0...1/5/10 A AC/DC		17.5 mm
2489910000	ACT20P-CML-10-AO-RC-P	1								0...1/5/10 A AC/DC		17.5 mm
1510470000	ACT20P-CMT-10-AO-RC-S	1								0...5/10 A AC/DC		22.5 mm
1510330000	ACT20P-CMT-10-AO-RC-P	1								0...5/10 A AC/DC		22.5 mm
1510540000	ACT20P-CMT-30-AO-RC-S	1								0...20/25/30 A AC/DC		22.5 mm
1510320000	ACT20P-CMT-30-AO-RC-P	1								0...20/25/30 A AC/DC		22.5 mm
1510440000	ACT20P-CMT-60-AO-RC-S	1								0...40/50/60 A AC/DC		22.5 mm
1510290000	ACT20P-CMT-60-AO-RC-P	1								0...40/50/60 A AC/DC		22.5 mm
1510390000	ACT20P-CMT-60-RC-S	1								0...40/50/60 A AC/DC		22.5 mm
1510280000	ACT20P-CMT-60-RC-P	1								0...40/50/60 A AC/DC		22.5 mm
7760054306	ACT20P-VM-AO-S	1								0...440 V AC, 0...660 V DC		22.5 mm
7760054360	ACT20P-VM-AO-P	1								0...440 V AC, 0...660 V DC		22.5 mm
Bridge measuring transducers												
1067250000	ACT20P-BRIDGE-S	1								4-, 6-wire strain gauge	X	22.5 mm
2456820000	ACT20P-BRIDGE-P	1								4-, 6-wire strain gauge	X	22.5 mm
Universal transducers												
1481970000	ACT20P-PRO DCDC II-S	1	X	X	X	X				± 100 mA, ± 300 V DC	X	12.5 mm
1481960000	ACT20P-PRO DCDC II-P	1	X	X	X	X				± 100 mA, ± 300 V DC	X	12.5 mm
2816690000	ACT20P-PRO DCDC II-24-S	1	X	X	X	X				± 100 mA, ± 300 V DC	X	12.5 mm
2816700000	ACT20P-PRO DCDC II-24-P	1	X	X	X	X				± 100 mA, ± 300 V DC	X	12.5 mm
1453210000	ACT20P-UI-AO-DO-LP-S	1	X	X	X	X	X	X		DC: ± 25 mA, ± 5 A, ± 60 mV, ± 28 V, ± 300 V, AC: 1V, 300 V		12.5 mm
2456850000	ACT20P-UI-AO-DO-LP-P	1	X	X	X	X	X	X		DC: ± 25 mA, ± 5 A, ± 60 mV, ± 28 V, ± 300 V, AC: 1V, 300 V		12.5 mm
Frequency transducers												
2447940000	ACT20P-PRO-FI-AO-DO-S	1						X		Namur, Switch, tacho, TTL, NPN/PNP, PWM	X	12.5 mm
2447950000	ACT20P-PRO-FI-AO-DO-P	1						X		Namur, Switch, tacho, TTL, NPN/PNP, PWM	X	12.5 mm
2490010000	ACT20P-PRO-FI-AO-DOS-S	1						X		Namur, Switch, tacho, TTL, NPN/PNP, PWM	X	12.5 mm
2490020000	ACT20P-PRO-FI-AO-DOS-P	1						X		Namur, Switch, tacho, TTL, NPN/PNP, PWM	X	12.5 mm
Space-saving signal converters – ACT20M												
Supply isolator												
1176000000	ACT20M-AI-AO-S	1	X	X	X	X				2-, 4-wire sensor	X	6.1 mm
2825370000	ACT20M-AI-AO-P	1	X	X	X	X				2-, 4-wire sensor	X	6.1 mm
2825050000	ACT20M-AI-AO-X-S	1	X	X	X	X				2-, 4-wire sensor	X	6.1 mm
2825180000	ACT20M-AI-AO-X-P	1	X	X	X	X				2-, 4-wire sensor	X	6.1 mm
1176020000	ACT20M-AI-2AO-S	1	X	X	X	X				2-, 4-wire sensor	X	6.1 mm
2825350000	ACT20M-AI-2AO-P	1	X	X	X	X				2-, 4-wire sensor	X	6.1 mm
2825030000	ACT20M-AI-2AO-X-S	1	X	X	X	X				2-, 4-wire sensor	X	6.1 mm
2825160000	ACT20M-AI-2AO-X-P	1	X	X	X	X				2-, 4-wire sensor	X	6.1 mm

Output							Miscellaneous	Configuration	Auxiliary power	Rated insulation voltage	Isolation	Rail bus	Ex approval	Shipbuilding approval	Special characteristics
Number outputs	0...20 mA	4...20 mA	0...10 V	Switching signal	Limit value, digital	Status, digital									
2					X	2 x CO	Software, Display	20...264 V UC	300 V	3-way		X			
2					X	2 x CO	Software, Display	20...264 V UC	300 V	3-way		X			
1					X	2 x CO	Software	9...60 V DC	300 V	4-way					
1					X	2 x CO	Software	9...60 V DC	300 V	4-way					
1					X	2 x CO	Software	90...264 V AC	300 V	4-way					
1					X	2 x CO	Software	90...264 V AC	300 V	4-way					
2					X	2 x CO	DIP switch, Pot.	20...240 V UC	300 V	3-way					
2					X	2 x CO	DIP switch, Pot.	20...240 V UC	300 V	3-way					
2					X	2 x CO	DIP switch, Pot.	input loop	600 V	3-way					
2					X	2 x CO	DIP switch, Pot.	input loop	600 V	3-way					
1	X	X	X		X	± 10 V, ± 20 mA, 1 x CO	DIP switch, potentiometer	24 V DC	300 V	4-way			X		Current carrying conductor at the terminals
1	X	X	X		X	± 10 V, ± 20 mA, 1 x CO	DIP switch, potentiometer	24 V DC	300 V	4-way			X		Current carrying conductor at the terminals
1	X	X	X		X	± 10 V, ± 20 mA, 1 x CO	DIP switch, potentiometer	24 V DC	300 V	4-way			X		Through hole current converter
1	X	X	X		X	± 10 V, ± 20 mA, 1 x CO	DIP switch, potentiometer	24 V DC	300 V	4-way			X		Through hole current converter
1	X	X	X		X	± 10 V, ± 20 mA, 1 x CO	DIP switch, potentiometer	24 V DC	300 V	4-way			X		Through hole current converter
1	X	X	X		X	± 10 V, ± 20 mA, 1 x CO	DIP switch, potentiometer	24 V DC	300 V	4-way			X		Through hole current converter
1	X	X	X		X	± 10 V, ± 20 mA, 1 x CO	DIP switch, potentiometer	24 V DC	300 V	4-way			X		Through hole current converter
1					X	1 x CO	DIP switch, potentiometer	24 V DC	300 V	3-way			X		Through hole current converter
1					X	1 x CO	DIP switch, potentiometer	24 V DC	300 V	3-way			X		Through hole current converter
1	X	X	X				Software	24 V - 230 V AC/DC	600 V	3-way					
1	X	X	X				Software	24 V - 230 V AC/DC	600 V	3-way					
1	X	X	X			Reset button (TARE)	DIP switch, button	10...60 V DC	300 V	3-way					
1	X	X	X			Reset button (TARE)	DIP switch, button	10...60 V DC	300 V	3-way					
1	X	X	X			± 10 V, ± 20 mA	Display, DIP switch, button	24 V - 230 V AC/DC	600 V	3-way		X	X		active or passive output
1	X	X	X			± 10 V, ± 20 mA	Display, DIP switch, button	24 V - 230 V AC/DC	600 V	3-way		X	X		active or passive output
1	X	X	X			± 10 V, ± 20 mA	Display, DIP switch, button	24 V DC	600 V	3-way		X	X		active or passive output
1	X	X	X			± 10 V, ± 20 mA	Display, DIP switch, button	24 V DC	600 V	3-way		X	X		active or passive output
1		X			X	1 x NPN	Software	output loop	300 V	3-way					
1		X			X	1 x NPN	Software	output loop	300 V	3-way					
1	X	X	X		X	1 x NPN	Display, button	24...240 V UC	300 V	4-way		*	X		
1	X	X	X		X	1 x NPN	Display, button	24...240 V UC	300 V	4-way		*	X		
1	X	X	X		X	1 x NPN	Display, button	24...240 V UC	300 V	4-way		*	X		with SIL function *)
1	X	X	X		X	1 x NPN	Display, button	24...240 V UC	300 V	4-way		*	X		with SIL function *)
1	X	X	X				DIP switch	24 V DC	300 V	3-way	X	X	X		
1	X	X	X				DIP switch	24 V DC	300 V	3-way	X	X	X		
1	X	X	X				DIP switch	24 V DC	300 V	3-way		X	X		
1	X	X	X				DIP switch	24 V DC	300 V	3-way		X	X		
2	X	X	X				DIP switch	24 V DC	300 V	3-way	X	X	X		Splitter
2	X	X	X				DIP switch	24 V DC	300 V	3-way	X	X	X		Splitter
2	X	X	X				DIP switch	24 V DC	300 V	3-way		X	X		Splitter
2	X	X	X				DIP switch	24 V DC	300 V	3-way		X	X		Splitter

Connection system: S = screw / Z = tension clamp / P = Push In, ILP = Input Loop Powered, OLP = Output Loop Powered, *) = in preparation

Quick select – Analogue Signal Conditioning

Selection table

Order No.	Product	Input										Width	
		Number of channels	0...20 mA	4...20 mA	0...10 V	0...5 V	TC	RTD	Frequency	Miscellaneous	sensor feed		
Isolation amplifier													
1175980000	ACT20M-CI-CO-S	1	X	X								4-wire sensor	6.1 mm
2825410000	ACT20M-CI-CO-P	1	X	X								4-wire sensor	6.1 mm
2825090000	ACT20M-CI-CO-X-S	1	X	X								4-wire sensor	6.1 mm
2825240000	ACT20M-CI-CO-X-P	1	X	X								4-wire sensor	6.1 mm
1175990000	ACT20M-CI-2CO-S	1	X	X								4-wire sensor	6.1 mm
2825400000	ACT20M-CI-2CO-P	1	X	X								4-wire sensor	6.1 mm
2825080000	ACT20M-CI-2CO-X-S	1	X	X								4-wire sensor	6.1 mm
2825210000	ACT20M-CI-2CO-X-P	1	X	X								4-wire sensor	6.1 mm
1176010000	ACT20M-AI-AO-E-S	1	X	X	X	X						4-wire sensor	6.1 mm
2825360000	ACT20M-AI-AO-E-P	1	X	X	X	X						4-wire sensor	6.1 mm
2825040000	ACT20M-AI-AO-E-X-S	1	X	X	X	X						4-wire sensor	6.1 mm
2825170000	ACT20M-AI-AO-E-X-P	1	X	X	X	X						4-wire sensor	6.1 mm
1375450000	ACT20M-BAI-AO-S	1										-10(20)...+10(20) mA, -5(10)...+5(10) V	6.1 mm
1375470000	ACT20M-BAI-2AO-S	1										-10(20)...+10(20) mA, -5(10)...+5(10) V	6.1 mm
2825060000	ACT20M-BAI-2AO-X-S	1										-10(20)...+10(20) mA, -5(10)...+5(10) V	6.1 mm
Passive isolator													
1176070000	ACT20M-CI-CO-ILP-S	1	X	X			X					4-wire sensor	6.1 mm
2825220000	ACT20M-CI-CO-ILP-P	1	X	X			X					4-wire sensor	6.1 mm
1176080000	ACT20M-2CI-2CO-ILP-S	2	X	X								4-wire sensor	6.1 mm
2825140000	ACT20M-2CI-2CO-ILP-P	2	X	X								4-wire sensor	6.1 mm
2825000000	ACT20M-CI-CO-OLP2-S	1		X			X					4-wire sensor	X 6.1 mm
2825320000	ACT20M-CI-CO-OLP2-P	1		X			X					4-wire sensor	X 6.1 mm
2825010000	ACT20M-2CI-2CO-OLP2-S	2		X			X					4-wire sensor	X 6.1 mm
2825330000	ACT20M-2CI-2CO-OLP2-P	2		X			X					4-wire sensor	X 6.1 mm
1176040000	ACT20M-CI-CO-OLP-S	1	X	X			X					2-wire transmitter	X 6.1 mm
2825230000	ACT20M-CI-CO-OLP-P	1	X	X			X					2-wire transmitter	X 6.1 mm
1176050000	ACT20M-2CI-2CO-OLP-S	2	X	X								2-wire transmitter	X 6.1 mm
2825150000	ACT20M-2CI-2CO-OLP-P	2	X	X								2-wire transmitter	X 6.1 mm
Temperature transducer													
1435590000	ACT20M-RTCI-CO-OLP-S	1					X	X				PT100 type: J,K	6.1 mm
2825250000	ACT20M-RTCI-CO-OLP-P	1					X	X				PT100 type: J,K	6.1 mm
1435610000	ACT20M-RTI-CO-EOLP-S	1						X				PT100	6.1 mm
2825280000	ACT20M-RTI-CO-EOLP-P	1					X	X				PT100	6.1 mm
2830480000	ACT20M-RTCI-CO-H-S	1					X	X				PT100 type: J,K	6.1 mm
2830490000	ACT20M-RTCI-CO-H-P	1					X	X				PT100 type: J,K	6.1 mm
2830500000	ACT20M-RTCI-CO-H-X-S	1					X	X				PT100 type: J,K	6.1 mm
2830510000	ACT20M-RTCI-CO-H-X-P	1					X	X				PT100 type: J,K	6.1 mm
2830460000	ACT20M-RTCI-CO-HOLP-S	1					X	X				PT100 type: J,K	6.1 mm
2830470000	ACT20M-RTCI-CO-HOLP-P	1					X	X				PT100 type: J,K	6.1 mm
1375510000	ACT20M-RTI-AO-S	1						X				PT100	6.1 mm
2825420000	ACT20M-RTI-AO-P	1						X				PT100	6.1 mm
2825100000	ACT20M-RTI-AO-X-S	1						X				PT100	6.1 mm
2825270000	ACT20M-RTI-AO-X-P	1						X				PT100	6.1 mm
1375520000	ACT20M-RTI-AO-E-S	1						X				PT100	6.1 mm
2825260000	ACT20M-RTI-AO-E-P	1						X				PT100	6.1 mm
1375480000	ACT20M-TCI-AO-S	1					X					type J,K	6.1 mm
2825430000	ACT20M-TCI-AO-P	1					X					type J,K	6.1 mm
2825110000	ACT20M-TCI-AO-X-S	1					X					type J,K	6.1 mm
2825300000	ACT20M-TCI-AO-X-P	1					X					type J,K	6.1 mm
1375500000	ACT20M-TCI-AO-E-S	1					X					type J,K	6.1 mm
2825290000	ACT20M-TCI-AO-E-P	1					X					type J,K	6.1 mm

Quick select – Analogue Signal Conditioning

Selection table

Order No.	Product	Input										Miscellaneous	sensor feed	Width	
		Number of channels	0...20 mA	4...20 mA	0...10 V	0...5 V	TC	RTD	Frequency						
Universal measuring transducers															
1176030000	ACT20M-UI-A0-S	1	X	X	X	X	X	X					PT50/100/250/300/400/1000, Ni50/100/1000 type: B/C/E/J/K/L/N/R/S/T	X	6.1 mm
2825440000	ACT20M-UI-A0-P	1	X	X	X	X	X	X					PT50/100/250/300/400/1000, Ni50/100/1000 type: B/C/E/J/K/L/N/R/S/T	X	6.1 mm
2825120000	ACT20M-UI-A0-X-S	1	X	X	X	X	X	X					PT50/100/250/300/400/1000, Ni50/100/1000 type: B/C/E/J/K/L/N/R/S/T	X	6.1 mm
2825310000	ACT20M-UI-A0-X-P	1	X	X	X	X	X	X					PT50/100/250/300/400/1000, Ni50/100/1000 type: B/C/E/J/K/L/N/R/S/T	X	6.1 mm
Frequency transducers															
2825020000	ACT20M-FRQ-A0-S	1									X		Namur, switch, tachometer, TTL, NPN/PNP, current/voltage	X	6.1 mm
2825450000	ACT20M-FRQ-A0-P	1									X		Namur, switch, tachometer, TTL, NPN/PNP, current/voltage	X	6.1 mm
2825130000	ACT20M-FRQ-A0-X-S	1									X		Namur, switch, tachometer, TTL, NPN/PNP, current/voltage	X	6.1 mm
2825340000	ACT20M-FRQ-A0-X-P	1									X		Namur, switch, tachometer, TTL, NPN/PNP, current/voltage	X	6.1 mm
Signal converters in terminal format – MCZ															
Frequency transducer															
8461470000	MCZ VFC 0-10V	1			X								4-wire sensor		6 mm
8461480000	MCZ CFC 0-20mA	1	X										4-wire sensor		6 mm
8461490000	MCZ CFC 4-20mA	1		X									4-wire sensor		6 mm
Limit switches															
8260280000	MCZ SC 0-10V	1			X										6 mm
8227350000	MCZ SC 0-20mA	1	X										4-wire sensor		6 mm
Passive isolator															
8411190000	MCZ CCC 0-20mA/0-20mA	1	X										4-wire sensor		6 mm
Temperature transducer															
8425720000	MCZ PT100/3 CLP 0...100C	1								X			Measuring range 0...100°C		6.1 mm
8483680000	MCZ PT100/3 CLP 0...120C	1								X			Measuring range 0...120°C		6.1 mm
8604420000	MCZ PT100/3 CLP 0...150C	1								X			Measuring range 0...150°C		6.1 mm
8473010000	MCZ PT100/3 CLP 0...200C	1								X			Measuring range 0...200°C		6.1 mm
8473020000	MCZ PT100/3 CLP 0...300C	1								X			Measuring range 0...300°C		6.1 mm
8473000000	MCZ PT100/3 CLP -50C...+150C	1								X			Measuring range -50...150°C		6.1 mm
8604430000	MCZ PT100/3 CLP -40C...100C	1								X			Measuring range -40...100°C		6.1 mm
Compact signal converter – PicoPak															
Passive isolator															
2517450000	PICOPAK-CI-C0-LP-S	1		X									4-wire sensor		6.1 mm
2501110000	PICOPAK-CI-C0-LP-P	1		X									4-wire sensor		6.1 mm
Process value displays															
Process value displays with LCD display															
2920000000	ACT20D-LCD-CI-LP	1		X									4-wire sensor		96.6 mm
Process value displays with LED display															
2920050000	ACT20D-LED-UI-AC-DC	1	X	X	X	X	X	X					Temperature (RTD / TC), current / voltage, potentiometer		96.6 mm
2920060000	ACT20D-LED-UI-A0-4RC-AC-D	1	X	X	X	X	X	X					Temperature (RTD / TC), current / voltage, potentiometer		96.6 mm
2920070000	ACT20D-LED-FI-A0-2RC-AC-DC	1									X		Namur, SO, switch, tachometer, TTL, NPN/PNP, current / voltage	X	96.6 mm
2964330000	Protective cover														96.6 mm
Accessories															
Programming adapter															
8978580000	CBX200 USB	1											24 V DC		
2907490000	ADAPTER CBX200 - MINI US	1											Adapter for ACT20P-TCI... / ACT20P-RTD...		
ACT20 power supply modules for rail bus															
8965500000	ACT20-FEED-IN-PRO-S	1											2 x 24V		22.5 mm
2456870000	ACT20-FEED-IN-PRO-P	1											2 x 24V		22.5 mm
1282490000	ACT20-FEED-IN-BASIC-S	1											24 V		6.1 mm
2825460000	ACT20-FEED-IN-BASIC-P	1											24 V		6.1 mm

Circuit symbols and their meaning

ACT20M - AI - AO - E - X - S

Series
ACT20P
ACT20M
ACT20X
ACT20D
MCZ

Connection type
S Screw
P Push In

Additional designation
ILP Current input, loop powered and passive („Input loop powered“)
OLP Current output, loop powered and passive („Output loop powered“)
LP Loop powered
X Power supply without CH20M mounting rail bus
E Limited functionality
DC Direct current supply 24 V dc
AC Alternating current supply 230V ac
RC Relay output („Relay contact“)
DO Digital output, transistor („Digital output“)

Output designation
CO Current output
VO Voltage output
AO Current/voltage output
RCO Relay contact output
DO Digital output, transistor („Digital output“)
SAO Current output, non-Ex („Safe analogue output“)
SDO Digital output, non-Ex („Safe analogue output“)
HDO Digital output, Ex („Hazardous digital output“)

Input designation
CI Current input
UI Universal input
VI Voltage input
RTI Temperature input (RTD resistance sensor)
RTCI Temperature input resistance und thermocouple (RTD & TC)
TCI Temperature input for thermocouple
FRQ, FI Frequency input
AI Current/voltage input
BAI Bipolar current/voltage input
HAI Current input, Ex („Hazardous analog input“)
SAI Analogue input, not Ex („Safe analog input“)
SDI Digital input, not Ex („Safe digital input“)
CMT Current input, with cable routing („through-hole“)
CML Current input, cable can be connected to the terminals („in-line“)

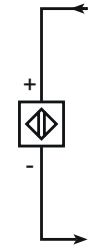
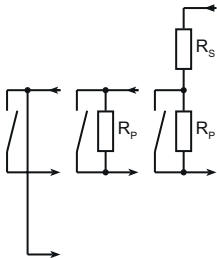
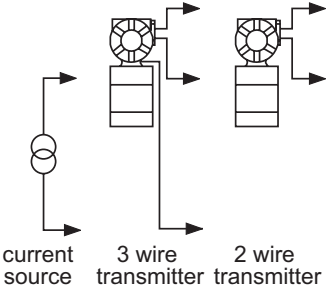
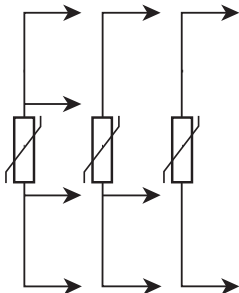
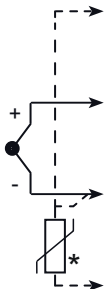
<p>NAMUR</p> 	<p>Sensor according to DIN EN 60947-5-6 (NAMUR)</p>
<p>Mechanical switch</p> 	<p>For sensors that do not have corresponding internal resistors, the following resistors can be added externally:</p> <ul style="list-style-type: none"> • Parallel resistor for line break monitoring (not possible with NPN sensors and push-pull amplifier) • Series resistor for line short-circuit monitoring. These should be connected as close as possible to the sensor.
 <p>current source 3 wire transmitter 2 wire transmitter</p>	<p>Sensor types</p> <ul style="list-style-type: none"> • Current Source: Sensor is an active current source • 3-wire sensor: Sensor is an active current source with additional supply via the converter • 2-wire sensor: Sensor is a passive current source with supply via the 4..20mA signal
	<p>RTD resistance temperature sensor (e.g. PT100) 2, 3, 4-wire measuring method</p>
	<p>Thermocouple (TC) with optional external cold junction compensation resistor (CJC, typ.PT100 sensor)</p>

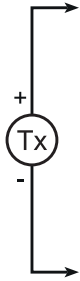
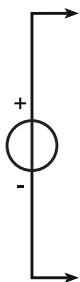
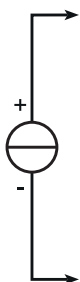
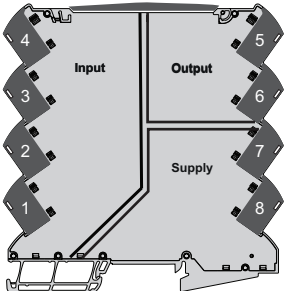
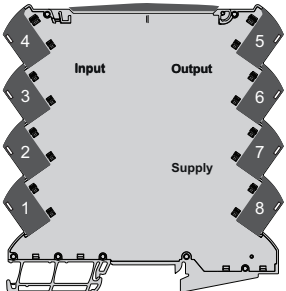
	<p>Sensor types TX: 2-wire sensor: Sensor is a passive current source with supply via the 4..20mA signal</p>
	<p>Sensor is active voltage source</p>
	<p>Sensor is active current source</p>
	<p>Converter with galvanic isolation, 3-way, between input, output and supply unit</p>
	<p>Converter without galvanic isolation</p>

Network-compatible current measuring transducers – ACT20C

Network-compatible current measuring transducers – ACT20C	Introduction	A.2
	Selection table	A.4
	Gateway	A.6
	Current transformers	A.7
	Bus termination terminal	A.9

ACT20C signal conditioner with Ethernet interface

Comprehensive process transparency is provided by the transfer of diagnostics information, signals and data

To be able to control systems and processes optimally, you require a constant flow of information on the current states of individual applications, devices and functions.

Our ACT20C signal conditioner not only monitors the signal conversion, but also communicates precise information on device status, signals and data directly to connected computer and control systems.

Our Ethernet interface enables an event-controlled transfer of diagnostics information, which in turn supports the elimination of faults in, for example, plant operation.



Universal signal conversion

Can be used in a multitude of applications thanks to customer and application specific defined conversion methods with just one single module.

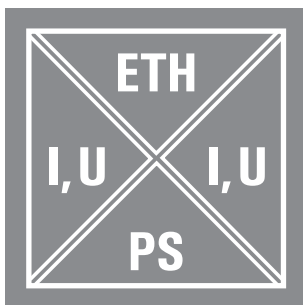

Simple operation and configuration

Software supported configuration allows a fast application of settings and simple operation.



Simple remote access

Continuous monitoring of device and system functions, simple and affordable integration of existing Ethernet networks.



Condition monitoring

Preventative maintenance strategies using automation-independent information about operating conditions and process data for connected devices.

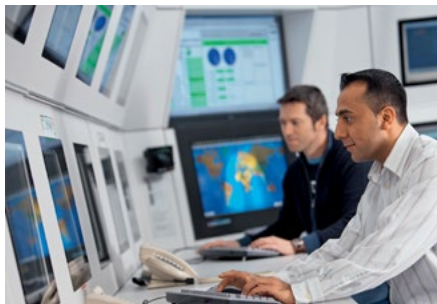
**Multiple limit value monitoring**

The main alarm and auxiliary alarm permit precise identification of all alarm situations.

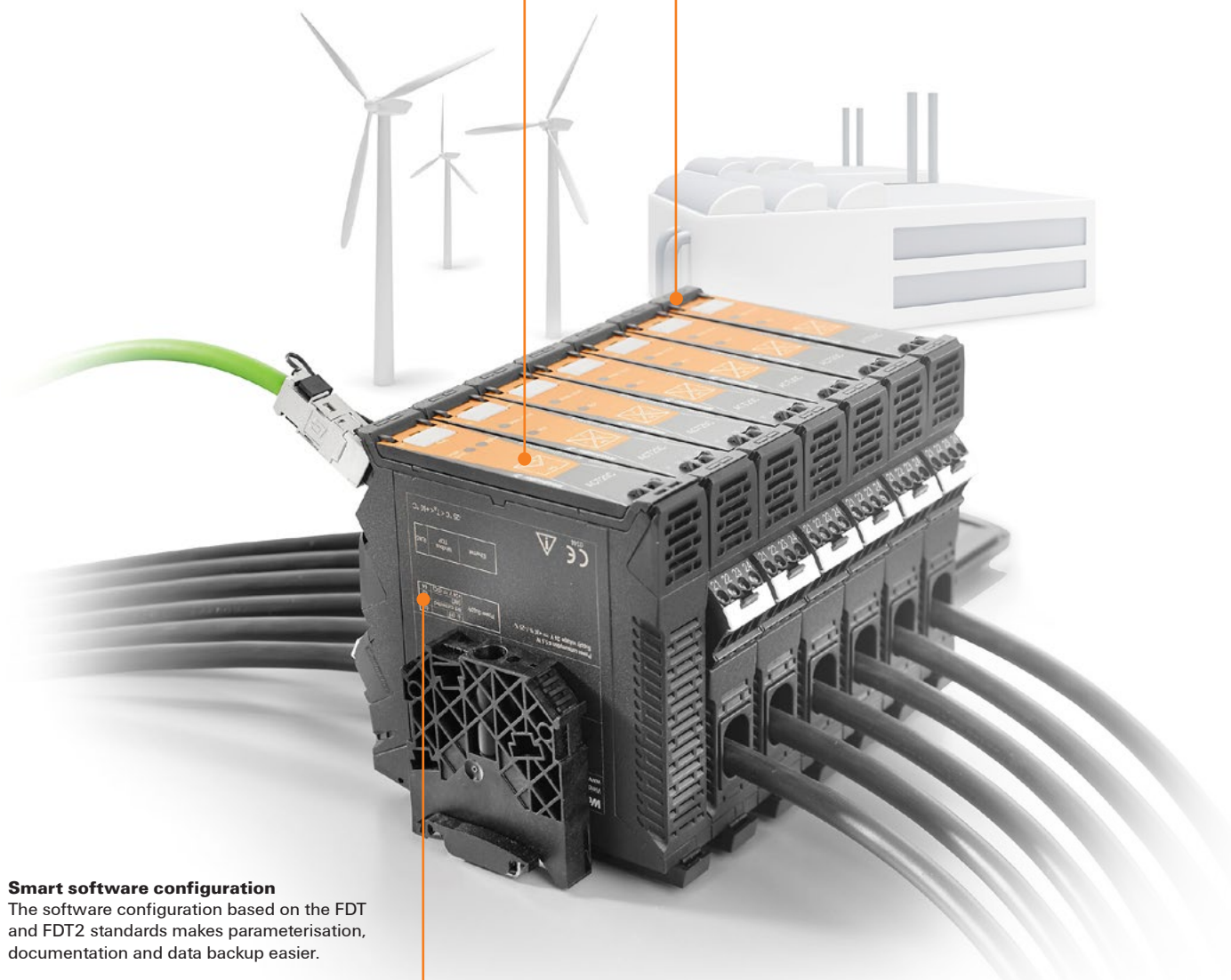
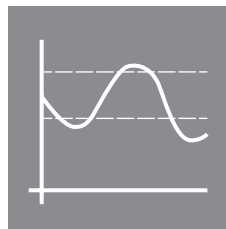
**Smart software configuration**

The software configuration based on the FDT and FDT2 standards makes parameterisation, documentation and data backup easier.

High process reliability

A galvanic four-way isolation and an impulse withstand voltage of 6.4 kV pursuant to IEC 61010-2-201 guarantee optimum fusing.

Selection table

Selection table

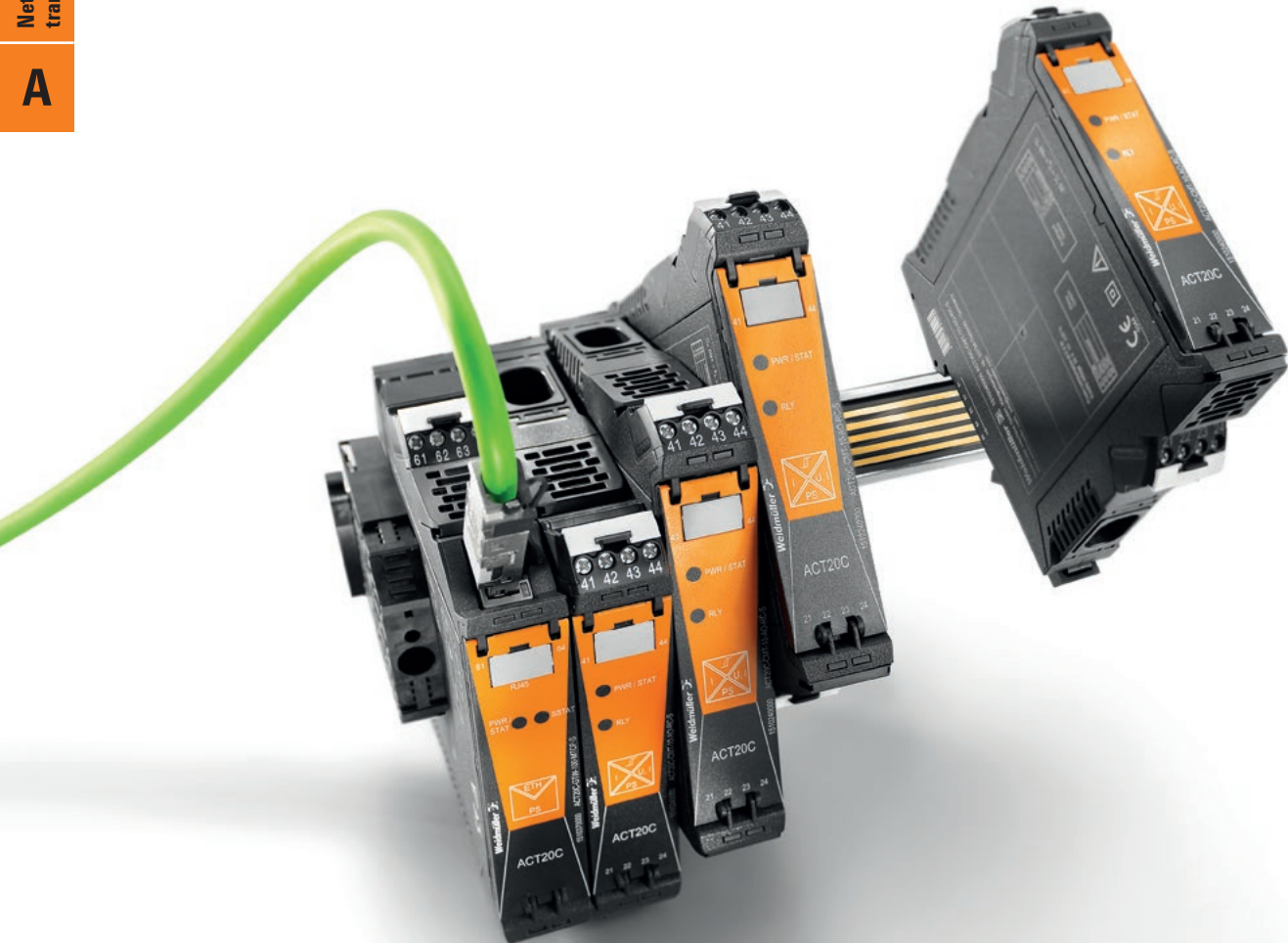

Selection table

Order No.	Product	Input							Miscellaneous	sensor feed	Width
		Number of channels	0...20 mA	4...20 mA	0...10 V	0...5 V	TC	RTD			

Network-compatible current measuring transducers – ACT20C

Gateway

1510370000	ACT20C-GTW-100-MTCP-S	1							RJ45, Modbus TCP	22.5 mm
Current and voltage transformers										
1510240000	ACT20C-CMT-10-AQ-RC-S	1							0...5/10 A AC/DC	22.5 mm
1510420000	ACT20C-CMT-60-AQ-RC-S	1							0...40/50/60 A AC/DC	22.5 mm
2044840000	ACT20C-CML-10-AQ-RC-S	1							0...1/5/10 A AC/DC	22.5 mm
Bus termination terminal										
1510340000	ACT20C-LBT-10	0								20.6 mm

	Output						Miscellaneous	Configuration	Auxiliary power	Rated insulation voltage	Isolation			Special characteristics
	Number outputs	0...20 mA	4...20 mA	0...10 V	Switching signal	Limit value, digital					Status, digital	Rail bus	Ex approval	
0								Software	24 V DC	30 V	3-way	X	X	Modbus TCP Gateway
1	X	X	X		X		± 20 mA, 1 x CD	Software	24 V DC	300 V	4-way	X	X	Through hole current converter
1	X	X	X		X		± 20 mA, 1 x CD	Software	24 V DC	300 V	4-way	X	X	Through hole current converter
1	X	X	X		X		± 20 mA, 1 x CD	Software	24 V DC	300 V	4-way	X	X	Current carrying conductor at the terminals
0												X	X	Electrical termination on mounting rail bus, ACT20C station

Connection system: S = screw / Z = tension clamp / P = Push In, ILP = Input Loop Powered, OLP = Output Loop Powered, *) = in preparation

Gateway

Gateway for ACT20C station

- Access to all data from the devices connected to an ACT20C station
- RJ45 port with Ethernet TCP/IP
- Configuration by means of the FDT/DTM standard
- Station management with "Plug & Produce" and "Hot Swapping"

ACT20C-GTW-100-MTCP

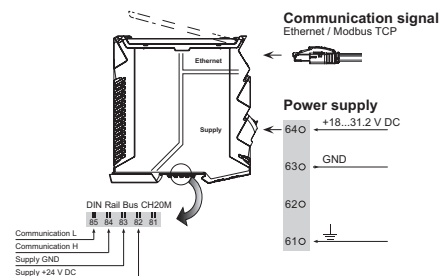
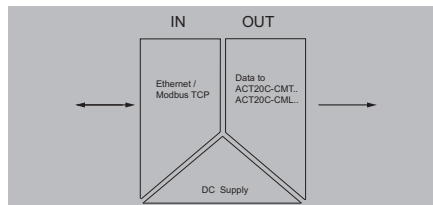

Technical data

Communication	
Addressing	
Configuration	
RJ45 ports	
Interface	
General data	
Configuration	
Power consumption, max.	
Voltage supply	
Insulation coordination	
Rated voltage / test voltage: Ethernet interface to supply / functional earth to supply / Ethernet interface	
Standards	
Test voltage	
Impulse withstand voltage	
Pollution degree	
Overtoltage category	

DHCP or manual adjustment	
With FDT/DTM software, DHCP	
10/100BaseT(X), auto negotiation	
Communication via CH20M rail bus with all current measuring transducers (ACT20C-CMT-x)	
General data	
With FDT/DTM software, DHCP	
1.5 W	
18.0 ... 31.2 V DC	
Insulation coordination	
30 V AC RMS	
IEC 61010-1, IEC 61010-2-201:2013, 1st Edition	
1.1 kV	
0,5 kV (1.2/50 µs)	
2	
II	

Dimensions	
Clamping range (nominal / min. / max.)	mm ²
Depth / Height / Width	
Note	

Screw connection, RJ45 plug-in connector	
1.5 / 0.5 / 2.5	
113.6 / 117.2 / 22.5 mm	
Note	

Ordering data

Type		
ACT20C-GTW-100-MTCP-S	Qty.	Order No.
	1	1510370000
Note		

Type		
ACT20C-GTW-100-MTCP-S	Qty.	Order No.
	1	1510370000
Note		

Accessories

Note	
------	--

Note	
------	--

Note	
------	--

Current transformer with limit value monitoring

- Measuring and monitoring of AC/DC current
- Input and output ranges are adjustable
- Contact-free through-hole technology
- Relay output for limit value alarm with switching threshold, delay, hysteresis
- Monitoring/configuration via ACT20C station/gateway

ACT20C-CMT

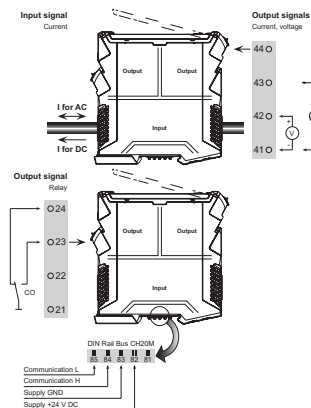
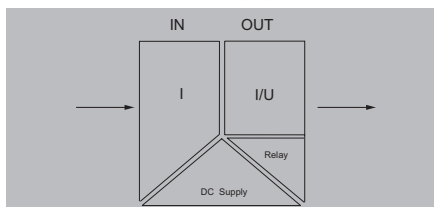

Technical data

Input	
Input measurement range	1510240000: configurable, 0...5/10 A AC (RMS) or DC; 1510420000: configurable, 0...40/50/60 A AC (RMS) or DC Current-carrying cable in feed-through hole, Diameter 10.5 mm
Input signal	
Input frequency	AC: 15...700 Hz
Output (analogue)	
Output voltage	Adjustable, 0...10 V, 2...10 V, 0...5 V, 1...5 V, -5...+5 V, -10...+10 V
Output current	Adjustable, 0...20 mA, 4...20 mA, -20...+20 mA
Load resistance current	≤ 600 Ω
Load resistance voltage	≥ 10 kΩ
Output (digital)	
Type	Relay, 1 CO contact, Process alarms (4x) with hysteresis, with alarm delay (configurable) 0...180 s
Rated switching current	6 A
Max. switching voltage, AC	250 V
General data	
Configuration	With FDT/DTM software, via gateway (ACT20C-GTW-100-MTCP-S), Addressing via DIP switches
Step response time	<300 ms
Temperature coefficient	typ. 0.04 % / K, max. 0.09 % / K
Voltage supply	via the system bus
Insulation coordination	
Rated voltage	300 V AC _{max}
EMC standards	IEC 61326-1
Galvanic isolation	4-way isolator, between input/output/supply/relay
Test voltage	4 kV
Impulse withstand voltage	6.4 kV (1.2/50 μs)
Pollution degree	2
Overvoltage category	III
Dimensions	
Clamping range (nominal / min. / max.)	mm ²
Depth / Height / Width	
Note	

Ordering data

- Input measurement range 0...5/10 A
- Input measurement range 0...40/50/60 A

Note

Accessories

Note

Screw connection		
	1.5 / 0.5 / 2.5	
	113.6 / 117.2 / 22.5 mm	
Type		
ACT20C-CMT-10-AD-RC-S	Qty. 1	Order No. 1510240000
ACT20C-CMT-60-AD-RC-S	Qty. 1	Order No. 1510420000

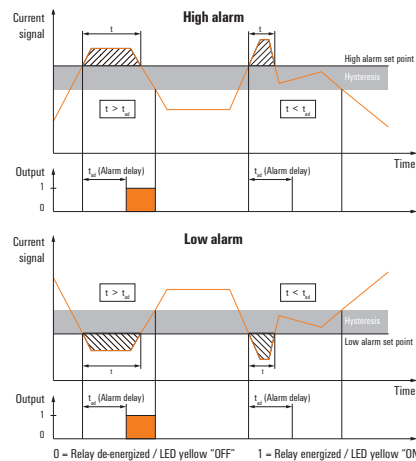

0 = Relay de-energized / LED yellow "OFF" 1 = Relay energized / LED yellow "ON"

User address	DIP switch S1					
	1	2	3	4	5	6
2		■				
3	■					
4				■		
5	■					
6		■	■	■		
7	■	■	■			
8					■	
...						
16						■
...						
32						■
33	■					■

■ = ON

Current transformer

Current transformer with limit value monitoring

- Measurement and monitoring of AC/DC currents
- Input/output electrically isolated
- Measurement range extension via passive current transformers
- A component of the ACT20C station
- Relay output for limit value alarm with switching threshold, delay, hysteresis

ACT20C-CML-10-A0-RC

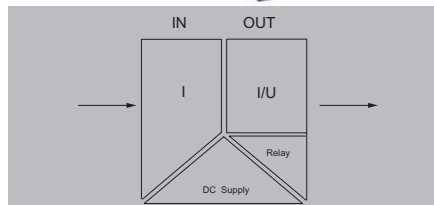

Technical data

Input

Input measurement range
Input signal
Input frequency

Output (analogue)

Output voltage
Output current
Load resistance current
Load resistance voltage

Output (digital)

Type

Rated switching current
Max. switching voltage, AC

General data

Configuration

Step response time
Temperature coefficient
Voltage supply

Insulation coordination

Rated voltage
EMC standards
Galvanic isolation
Test voltage
Impulse withstand voltage
Pollution degree
Overvoltage category

Dimensions

Clamping range (nominal / min. / max.) mm²
Depth / Height / Width

Note

Ordering data



Note

Accessories



Input

configurable, 0...1/5/10 A AC (RMS) or DC
Power cable can be connected to the terminals
AC: 15...400 Hz (true root mean square), AC: 50 Hz (arithmetic average)

Adjustable, 0...10 V, 2...10 V, 0...5 V, 1...5 V, -5...+5 V, -10...+10 V
Adjustable, 0...20 mA, 4...20 mA, -20...+20 mA

≤ 600 Ω

≥ 10 kΩ

Relay, 1 CO contact, Process alarms (4x) with hysteresis, with alarm delay (configurable) 0...180 s

2 A

250 V

for thresholds (overcurrent / undercurrent), delay and hysteresis, via gateway (ACT20C-GTW-100-MTCP-S), With FDT/DTM software, DIP switch and potentiometer

≤ 300 ms (RMS), ≤ 60 ms (AA)

≤ ±100 ppm/K @ -25...+55 °C, ≤ ±200 ppm/K @ +55...+70 °C

24 V DC ± 30 %

300 V AC_{max}

IEC 61326-1

4-way isolator, between input/output/supply/relay

4 kV

6 kV (1.2/50 μs)

2

III

Screw connection

1.5 / 0.5 / 2.5
113.6 / 117.2 / 17.5 mm

Type	Qty.	Order No.
ACT20C-CML-10-A0-RC-S	1	2044840000

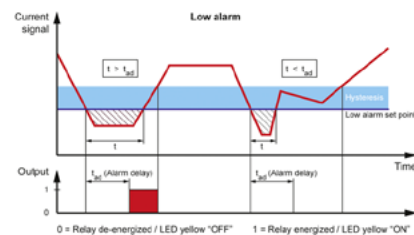
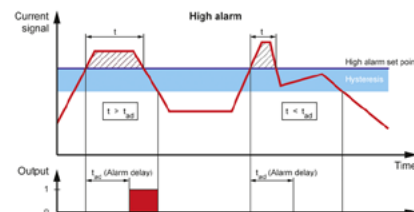
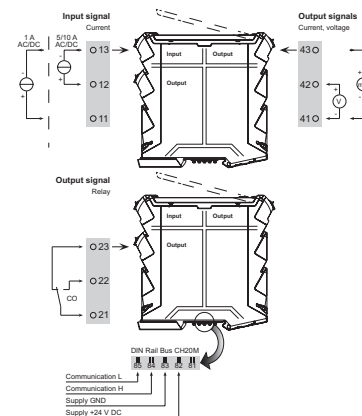

0 = Relay de-energized / LED yellow "OFF" 1 = Relay energized / LED yellow "ON"

Configuration

User address	DIP switch S1					
	1	2	3	4	5	6
2						
3						
4						
5						
6						
7						
8						
...						
16						
...						
32						
33						

■ = ON

Bus termination terminal

- Electrical termination of the CH20M rail bus of an ACT20C station
- Acts as a mechanical end bracket at the same time

ACT20C-LBT-10



Technical data

Humidity
Ambient temperature
General data
Rail

5...95 %, no condensation
-25 °C...+60 °C
TS 35

Dimensions
Depth / Width / Height

socket / socket
63 / 20.6 / 56

Note

--

Ordering data

--

Type	Qty.	Order No.
ACT20C-LBT-10	1	1510340000

Note

--

Accessories

Note

--

Intrinsically safe signal converters – ACT20X

Intrinsically safe signal converters – ACT20X	Introduction	B.2
	Selection table	B.4
	Supply isolator	B.6
	Output driver	B.8
	Temperature transducer	B.10
	Switching amplifier	B.12
	Solenoid drivers	B.16
	Universal measurement transducers	B.20

Secure isolation of signals from hazardous areas

Intrinsically safe ACT20X Ex-signal converters

B

Your application requires signals to be routed to or from hazardous areas. Our intrinsically safe ACT20X signal isolating converters meet the strict standards of the process industry and process signals from a wide range of Ex-zones (Zones 0, 1, 2) for control purposes.

ACT20X can be used universally. On the input side, the converter can process HART® input signals, or DC, RTD, thermocouple or NAMUR signals from the Ex-zone. On the output side, the ACT20X controls field devices with analogue or digital signals. All ACT20X products are characterised by high insulation, high accuracy and high temperature stability.

The 2-channel versions with width of 22.5 mm are available with either transistor or relay output. Because of this highly integrated design, the ACT20X helps you to reduce installation costs and use less space.

Intrinsically safe signal converters with SIL approval are available for safety functions, e.g. switching aggregates on/off, monitoring actuators or temperature/pressure. Our ACT20X complies with these stringent standards of the process industry, as well as mining industry requirements.



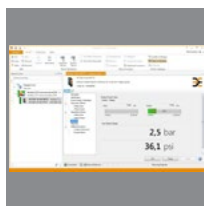

Configuration via WI Manager

All modules can be quickly and conveniently configured with manufacturer-independent FDT/DTM software.

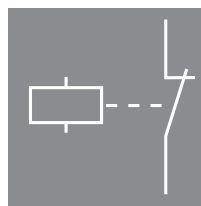

Alarm function

No laborious troubleshooting. Alarm function integrated for cable or sensor errors. In case of failures, a diagnostic signal is sent to the control system.



Worldwide application

Fulfills the strict standards and requirements of the process industry. Can be used worldwide due to international and local approvals.

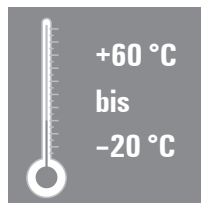

Robust

Wide ambient temperature range from - 20 °C ... + 60 °C.



Intelligent connection system

Pluggable, coded, with release lever. The release lever simplifies maintenance and allows disconnection without damaging the cables.



SIL certification according 61508

Available for safety functions, e.g. switching aggregates on/off, monitoring actuators or temperature/pressure.

Selection table

Selection table

Order No.	Product	Input										Miscellaneous	sensor feed	Width
		Number of channels	0...20 mA	4...20 mA	0...10 V	0...5 V	TC	RTD	Frequency					

Intrinsically safe signal converters – ACT20X														
Supply isolator														
8965430000	ACT20X-HAI-SAO-S	1	X	X								HART® transparent	X	22.5 mm
2456140000	ACT20X-HAI-SAO-P	1	X	X								HART® transparent	X	22.5 mm
8965440000	ACT20X-2HAI-2SAO-S	2	X	X								HART® transparent	X	22.5 mm
2456150000	ACT20X-2HAI-2SAO-P	2	X	X								HART® transparent	X	22.5 mm
Output driver														
8965450000	ACT20X-SAI-HAO-S	1		X								HART® transparent		22.5 mm
2456160000	ACT20X-SAI-HAO-P	1		X								HART® transparent		22.5 mm
8965460000	ACT20X-2SAI-2HAO-S	2		X								HART® transparent		22.5 mm
2456170000	ACT20X-2SAI-2HAO-P	2		X								HART® transparent		22.5 mm
Temperature transducer														
8965470000	ACT20X-HTI-SAO-S	1	X	X			X	X				Temperature + mA		22.5 mm
2456180000	ACT20X-HTI-SAO-P	1	X	X			X	X				Temperature + mA		22.5 mm
8965480000	ACT20X-2HTI-2SAO-S	2	X	X			X	X				Temperature + mA		22.5 mm
2456190000	ACT20X-2HTI-2SAO-P	2	X	X			X	X				Temperature + mA		22.5 mm
Switching amplifier														
8965340000	ACT20X-HDI-SDO-RNO-S	1										Namur, switching signal	X	22.5 mm
2456050000	ACT20X-HDI-SDO-RNO-P	1										Namur, switching signal	X	22.5 mm
8965350000	ACT20X-HDI-SDO-RNC-S	1										Namur, switching signal	X	22.5 mm
2456060000	ACT20X-HDI-SDO-RNC-P	1										Namur, switching signal	X	22.5 mm
8965370000	ACT20X-2HDI-2SDO-RNO-S	2										Namur, switching signal	X	22.5 mm
2456080000	ACT20X-2HDI-2SDO-RNO-P	2										Namur, switching signal	X	22.5 mm
8965380000	ACT20X-2HDI-2SDO-RNC-S	2										Namur, switching signal	X	22.5 mm
2456090000	ACT20X-2HDI-2SDO-RNC-P	2										Namur, switching signal	X	22.5 mm
8965360000	ACT20X-HDI-SDO-S	1										Namur, switching signal	X	22.5 mm
2456070000	ACT20X-HDI-SDO-P	1										Namur, switching signal	X	22.5 mm
8965390000	ACT20X-2HDI-2SDO-S	2										Namur, switching signal	X	22.5 mm
2456100000	ACT20X-2HDI-2SDO-P	2										Namur, switching signal	X	22.5 mm
Solenoid drivers														
8965400000	ACT20X-SDI-HDO-L-S	1										NPN / PNP switching signal		22.5 mm
2456100000	ACT20X-SDI-HDO-L-P	1										NPN / PNP switching signal		22.5 mm
8965420000	ACT20X-2SDI-2HDO-S	2										NPN / PNP switching signal		22.5 mm
2456120000	ACT20X-2SDI-2HDO-P	2										NPN / PNP switching signal		22.5 mm
8965410000	ACT20X-SDI-HDO-H-S	1										NPN / PNP switching signal		22.5 mm
2456120000	ACT20X-SDI-HDO-H-P	1										NPN / PNP switching signal		22.5 mm
Universal measurement transducers														
8965490000	ACT20X-HUI-SAO-S	1	X	X	X	X	X	X				Temperature + mA + V	X	22.5 mm
2456200000	ACT20X-HUI-SAO-P	1	X	X	X	X	X	X				Temperature + mA + V	X	22.5 mm

Number outputs	Output						Miscellaneous	Configuration	Auxiliary power	Rated insulation voltage	Isolation	Rail bus	Ex approval	Shipbuilding approval	Special characteristics
	0...20 mA	4...20 mA	0...10 V	Switching signal	Limit value, digital	Status, digital									
1	X				X	1 x NC	Software	24 V DC	300 V	3-way		X	X		
1	X				X	1 x NC	Software	24 V DC	300 V	3-way		X	X		
2	X				X	1 x NC	Software	24 V DC	300 V	3-way		X	X		
2	X				X	1 x NC	Software	24 V DC	300 V	3-way		X	X		
1	X				X	1 x NC	Software	24 V DC	300 V	3-way		X	X		
1	X				X	1 x NC	Software	24 V DC	300 V	3-way		X	X		
2	X				X	1 x NC	Software	24 V DC	300 V	3-way		X	X		
2	X				X	1 x NC	Software	24 V DC	300 V	3-way		X	X		
1	X	X			X	1 x NC	Software	24 V DC	300 V	3-way		X	X		
1	X	X			X	1 x NC	Software	24 V DC	300 V	3-way		X	X		
2	X	X			X	1 x NC	Software	24 V DC	300 V	3-way		X	X		
2	X	X			X	1 x NC	Software	24 V DC	300 V	3-way		X	X		
1				X	X	1 x NO, 1 x NC	Software	24 V DC	300 V	3-way		X	X		
1				X	X	1 x NO, 1 x NC	Software	24 V DC	300 V	3-way		X	X		
1				X	X	1 x NO, 1 x NC	Software	24 V DC	300 V	3-way		X	X		
1				X	X	1 x NO, 1 x NC	Software	24 V DC	300 V	3-way		X	X		
2				X	X	1 x NO, 1 x NC	Software	24 V DC	300 V	3-way		X	X		
2				X	X	1 x NO, 1 x NC	Software	24 V DC	300 V	3-way		X	X		
2				X	X	1 x NO, 1 x NC	Software	24 V DC	300 V	3-way		X	X		
2				X	X	1 x NO, 1 x NC	Software	24 V DC	300 V	3-way		X	X		
1				X	X	1 x NPN, 1 x NC	Software	24 V DC	300 V	3-way		X	X		
1				X	X	1 x NPN, 1 x NC	Software	24 V DC	300 V	3-way		X	X		
2				X	X	1 x NPN, 1 x NC	Software	24 V DC	300 V	3-way		X	X		
2				X	X	1 x NPN, 1 x NC	Software	24 V DC	300 V	3-way		X	X		
1				X	X	1 x NPN/PNP, 1 x NC	Software	24 V DC	300 V	3-way		X	X		
1				X	X	1 x NPN/PNP, 1 x NC	Software	24 V DC	300 V	3-way		X	X		
2				X	X	1 x NPN/PNP, 1 x NC	Software	24 V DC	300 V	3-way		X	X		
2				X	X	1 x NPN/PNP, 1 x NC	Software	24 V DC	300 V	3-way		X	X		
1				X	X	1 x NPN/PNP, 1 x NC	Software	24 V DC	300 V	3-way		X	X		
1				X	X	1 x NPN/PNP, 1 x NC	Software	24 V DC	300 V	3-way		X	X		
1	X	X			X	1 x NO, 1 x NC	Software	24 V DC	300 V	3-way		X	X		
1	X	X			X	1 x NO, 1 x NC	Software	24 V DC	300 V	3-way		X	X		

Connection system: S = screw / Z = tension clamp / P = Push In, ILP = Input Loop Powered, OLP = Output Loop Powered, *) = in preparation

Supply isolator

Supply isolator, HART® transparent

The ACT20X-HAI-SAO current supply isolator is a HART®-protocol transparent signal isolator for analogue input signals from Ex zone 0. It provides an analogue signal for the safe zone on the output side. It is available in a single-channel or double-channel version.

EX area Zone 0, 1, 2, 20, 21, 22

Safe area Zone 2 / FM Class 1, Division 2

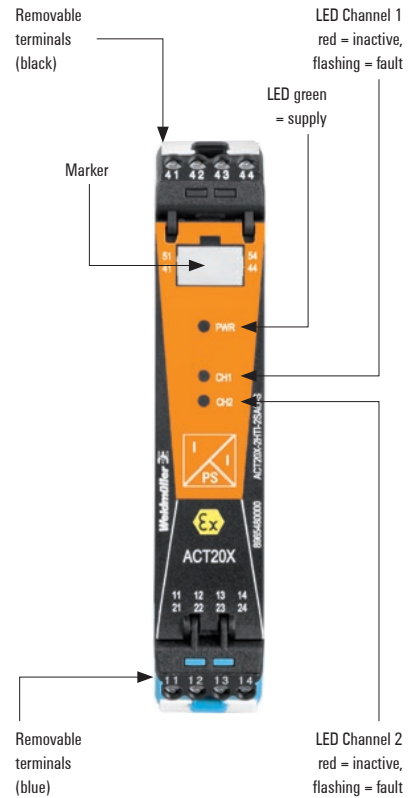
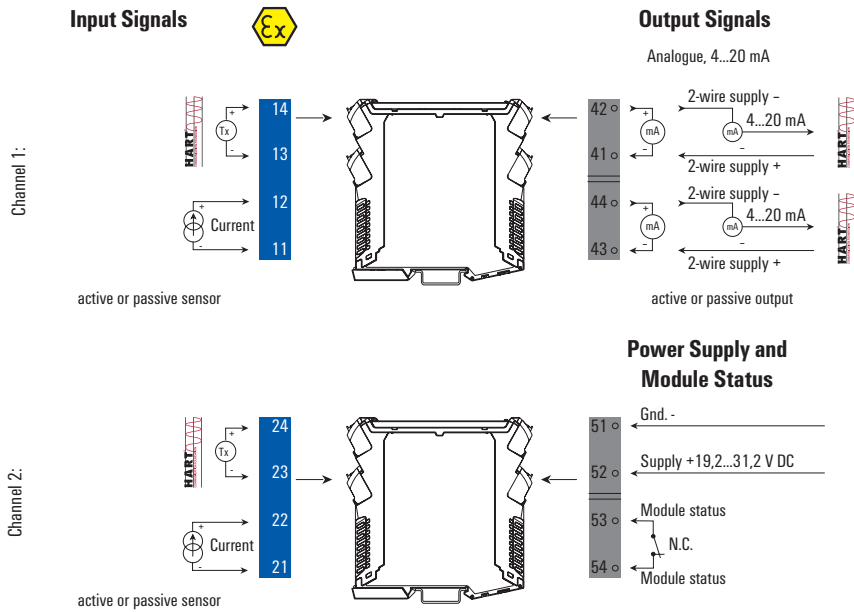

Ex label (excerpt)

ATEX	FM	U_o/U_i	0 V / 30 V
II 3 G Ex nA nC IIC T4 Gc	Installation in CL I DIV2 GP A-D T4	I_o/I_i	0 mA / 120 mA
II (1) G [Ex ia Ga] IIC/IIB/IIA	KI. III ABT 1/2 GP A-G or	P_o/P_i	0 mW / 0,85 W
II (1) D [Ex ia Da] IIIC	KI. I Zn2 AEx/Ex nA nC [ia] IIC T4	L_i	0 μ H
	Example:	C_i	2 nF
IECEX	ATEX version,	IIC	$C_o = 0,08 \mu$ F, $L_o = 3$ mH
Ex nA nC IIC T4 Gc	Ex input, External Current Source:	IIB	$C_o = 0,6 \mu$ F, $L_o = 12$ mH
[Ex ia Ga] IIC/IIB/IIA	(More details in ATEX certificate)	IIA	$C_o = 2,15 \mu$ F, $L_o = 25$ mH

Application example:

Measuring temperature with a head transmitter, signal transmission with HART®

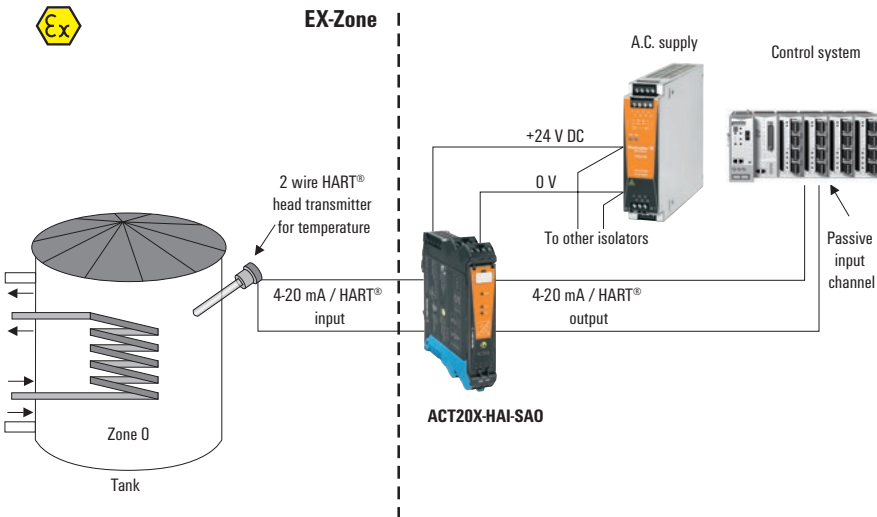

Supply isolator, HART® transparent

- Converts analogue signals from Ex zone 0 into analogue output signals for safe zones.
- Active and passive current inputs/outputs
- HART® - transparent
- PC configuration with FDT/DTM software, download at www.weidmuller.com
- Relay output for failure alarm
- 2-channel module, can also be used as a signal splitter

ACT20X-HAI-SAO / 2HAI-2SAO

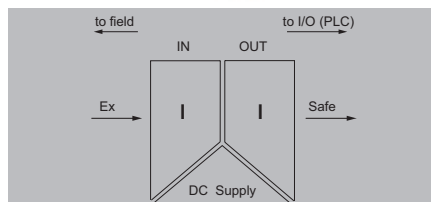

Technical data

Input	
Input current	4...20mA
Sensor supply	> 16 V DC
Residual ripple (current loop)	<7.5 mV _{eff}
Output analogue	
Output current	4...20 mA
Output signal limit	<28 mA
Load impedance current	≤ 600 Ω
Accuracy	<0.1% span
Step response time	≤ 5 ms
Cut-off frequency (-3 dB)	
Alarm output	
Type	Status relay, 1 NC (voltage-free)
Nominal switching voltage	≤ 125 V AC / 110 V DC (safe area) ≤ 32 V AC / 32 V DC (zone 2)
Continuous current	≤ 0.5 A AC / 0.3 A DC (safe zone), ≤ 0.5 A AC / 1 A DC (zone 2)
Power rating	≤ 62.5 VA / 32 W (safe area) ≤ 16 VA / 32 W (Zone 2)
General data	
Voltage supply	19.2...31.2 V DC
Power consumption	≤ 1.0 W
Ambient temperature / Storage temperature	-20 °C...60 °C / -20 °C...85 °C
Approvals	
Approvals	CE; cULus; DEKRAATEX; DETNORVER; FMEX; FUSAFETY; IECEXDEK
Insulation coordination	
Insulation voltage	2.6 kV (input / output)
Rated voltage	300 V
EMC standards	EN 61326-1

Dimensions

Clamping range (nominal / min. / max.)	mm ²
Depth x width x height	mm

Note

Screw connection	PUSH IN
2.5 / 0.25 / 2.5	
113.6 / 22.5 / 119.2	114.6 / 22.5 / 127.3

Ordering data

1-channel version	Type	Qty.	Order No.
Screw connection	ACT20X-HAI-SAO-S	1	8965430000
PUSH IN connection	ACT20X-HAI-SAO-P	1	2456140000
2-channel version	Type	Qty.	Order No.
Screw connection	ACT20X-2HAI-2SAO-S	1	8965440000
PUSH IN connection	ACT20X-2HAI-2SAO-P	1	2456150000

Note

CBX200 USB configuration adapter - 8978580000

Output driver

Output driver, HART® transparent

The ACT20X-SAI-HAO current output isolator is HART®-transparent. The input is connected to the safe area controller or PLC, and the output is connected to an analog actuator in a hazardous area, e.g. Zone 0. It is available in a single-channel or double-channel version.

EX area Zone 0, 1, 2, 20, 21, 22

Safe area Zone 2 / FM Class 1, Division 2

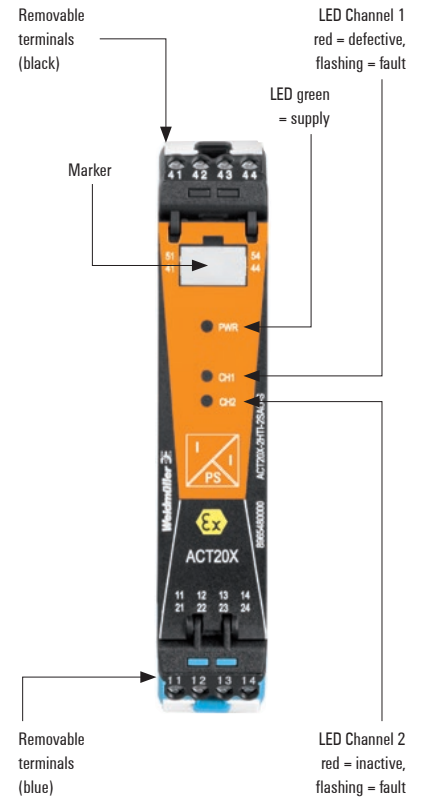
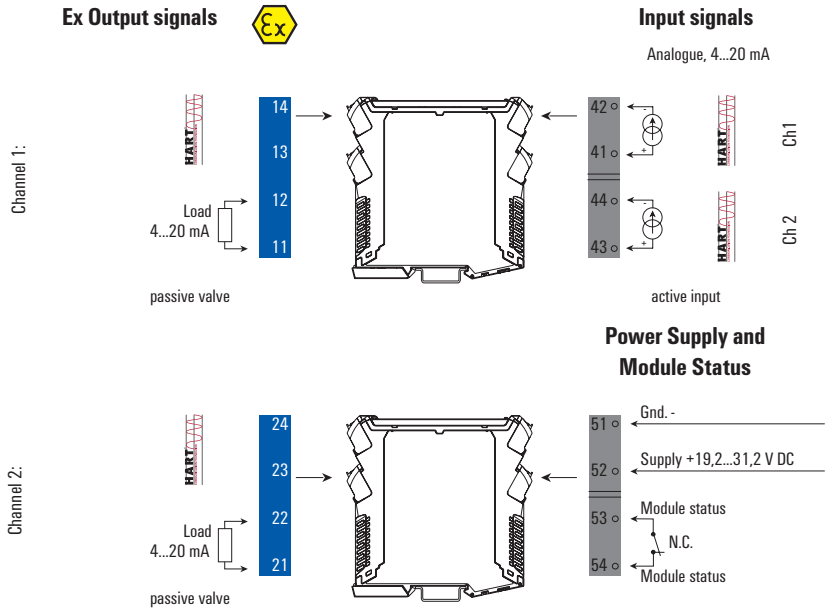

Ex label (excerpt)

ATEX	FM	U_o	28 V
II 3 G Ex nA nC IIC T4 Gc	Installation in CL I DIV2 GP A-D T4	I_o	93 mA
II (1) G [Ex ia Ga] IIC/IIB/IIA	KI. III ABT 1/2 GP A-G or	P_o	0.65 W
II (1) D [Ex ia Da] IIIC	KI. I Zn2 AEx/Ex nA nC [ia] IIC T4	IIC	$C_o = 0.08 \mu F, L_o = 4 mH$
IECEX	Example:	IIB	$C_o = 0.65 \mu F, L_o = 16 mH$
Ex nA nC IIC T4 Gc	ATEX version,	IIA	$C_o = 2.15 \mu F, L_o = 32 mH$
[Ex ia Ga] IIC/IIB/IIA	Ex output,		
[Ex ia Da] IIIC	(More details in ATEX certificate)		



Application example: controlling an actuator in the Ex zone.

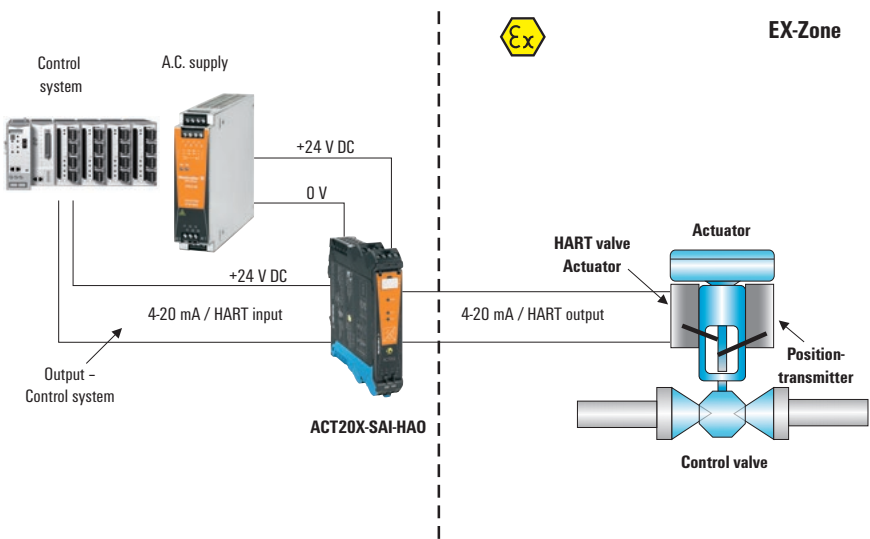

Output driver, HART® transparent

- For controlling field devices located in explosion risk zones
- HART® Transparent
- Relay output for error alarm
- PC configuration with FDT/DTM software, download at www.weidmueller.com
- 1 or 2 channels in one module

ACT20X-SAI-HAO / 2SAI-2HAO

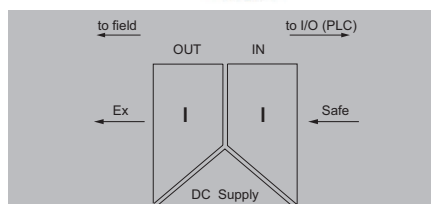

Technical data

Input	
Input current	4...20mA
Voltage drop	<2 V
Output analogue	
Output current	4...20 mA (max. 23 mA)
Output signal limit	<28 mA
Load impedance current	≤ 725 Ω
2-wire supply	> 14.5 V @ 20 mA
Residual ripple (current loop)	<7.5 mV _{eff}
Accuracy	<0.1% span
Step response time	≤ 5 ms
Cut-off frequency (-3 dB)	
Alarm output	
Nominal switching voltage	≤ 125 V AC / 110 V DC (safe area) ≤ 32 V AC / 32 V DC (zone 2)
Continuous current	≤ 0,5 A AC / 1 A DC (zone 2)
Power rating	≤ 62.5 VA / 32 W (safe area) ≤ 16 VA / 32 W (Zone 2)
General data	
Voltage supply	19.2...31.2 V DC
Power consumption	≤ 1.0 W
Ambient temperature / Storage temperature	-20 °C...60 °C / -20 °C...85 °C
Approvals	
Approvals	CE; cULus; DEKRAATEX; DETNORVER; FMEX; FUSAFETY; IECEXDEK
Insulation coordination	
Insulation voltage	2.6 kV (input / output)
Rated voltage	300 V
EMC standards	EN 61326-1
Type	Status relay, 1 NC (voltage-free)
Dimensions	
Clamping range (nominal / min. / max.)	mm ²
Depth x width x height	mm
Note	
Dimensions	
Screw connection	PUSH IN
	2.5 / 0.25 / 2.5
	113.6 / 22.5 / 119.2 114.6 / 22.5 / 127.3
Ordering data	
1-channel version	
	Screw connection
	PUSH IN connection
2-channel version	
	Screw connection
	PUSH IN connection
Note	
	CBX200 USB configuration adapter - 8978580000

Temperature transducer

Temperature transducer RTD / TC sensors + current input

The ACT20X-HTI-SAO temperature transducer processes temperature signals from PT100 sensors and thermocouples originating in the Ex zone. A current signal (mA) can also be connected as the input signal. The input is part of an intrinsically safe circuit (Zone 0). The isolated milliamp analogue output is the input to the receiver or controller in the safe area. It is available in a single-channel or double-channel version.

EX area Zone 0, 1, 2, 20, 21, 22

Safe area Zone 2 / FM Class 1, Division 2

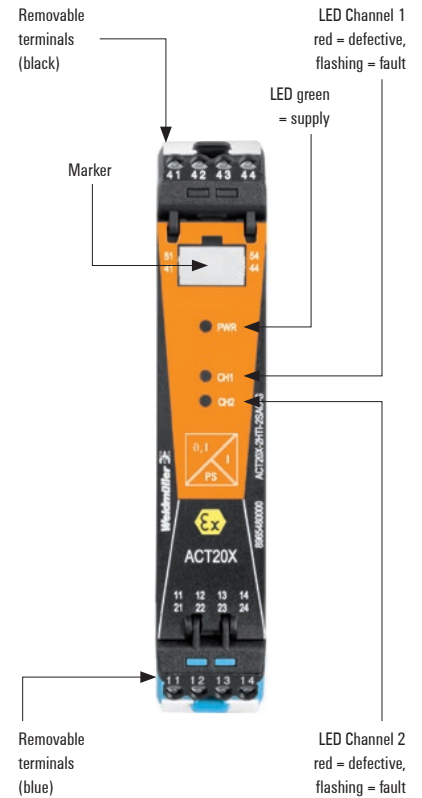
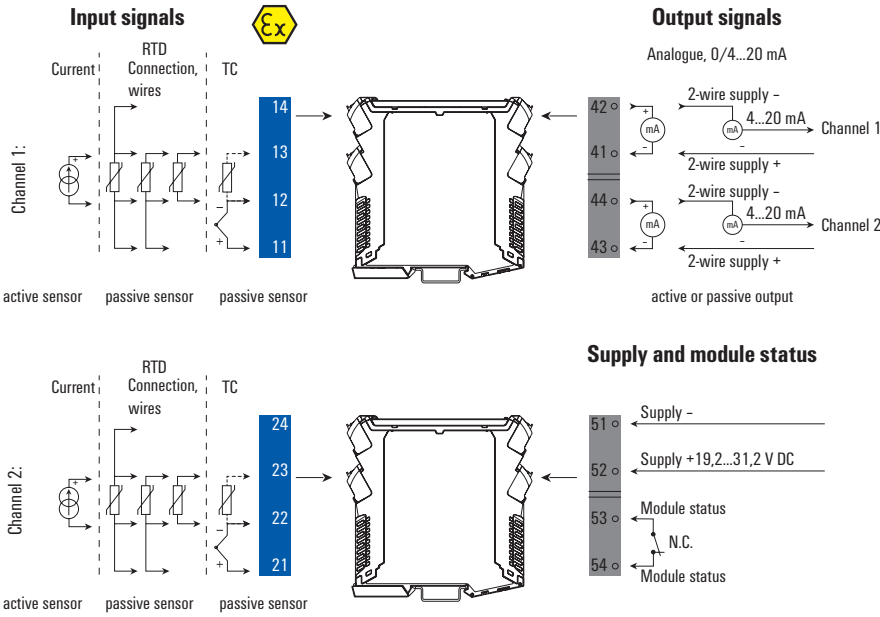

Ex label (excerpt)

ATEX	FM	U_o/U_i	8.7 V / 10 V
II 3 G Ex nA nC IIC T4	Installation in CL I DIV2 GP A-D T4	I_o/I_i	18.4 mA / 30 mA
II (1) G [Ex ia] IIC/IIB/IIA	KI. III ABT 1/2 GP A-G or	P_o	400 mW
II (1) D [Ex iaD]	KI. I Zn2 AEx/Ex nA nC [ia] IIC T4	$L_o/R_o/L_i$	892 μ H/ Ω / 820 nH
	Example:	C_i	30 nF
IECEX	ATEX version,	IIC	$C_o = 5 \mu$ F, $L_o = 100$ mH
Ex nA nC IIC T4 Gc	Ex input Temperature,	IIB	$C_o = 50 \mu$ F, $L_o = 300$ mH
[Ex ia Ga] IIC/IIB/IIA	(More details in ATEX certificate)	IIA	$C_o = 1000 \mu$ F, $L_o = 700$ mH

Application example: temperature measurements in the Ex zone

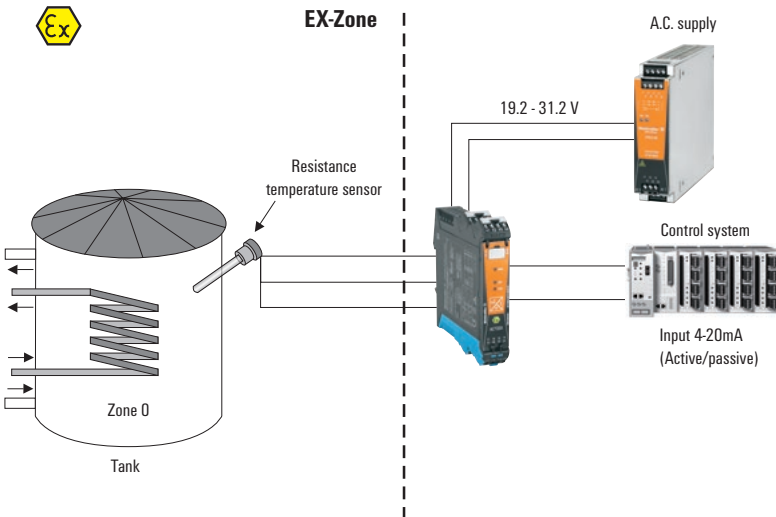

Accuracy / temperature coefficients ACT20X-HTI-SAO

Input	Accuracy	Temperature coefficient
Input mA	$\leq \pm 4 \mu$ A	$\leq \pm 4 \mu$ A / °C
Input RTD		
Pt100	$\leq \pm 0.2$ °C	$\leq \pm 0.02$ °C / °C
Ni100	$\leq \pm 0.3$ °C	$\leq \pm 0.03$ °C / °C
Input TC		
Type B	$\leq \pm 4.5$ °C	$\leq \pm 0.45$ °C / °C
Type E, J, K, L, N, T, U	$\leq \pm 1$ °C	$\leq \pm 0.1$ °C / °C
Type R, S, W3, W5, LR	$\leq \pm 2$ °C	$\leq \pm 0.2$ °C / °C
Note		

Temperature transducer RTD / TC sensors + current input

- Converts intrinsically safe RTD, thermocouple and mA signals into analogue signals for safe zones.
- PC configuration with FDT/DTM software, download link at www.weidmuller.com
- Relay output for failure alarm
- 1 or 2 channels in one module
- 2-channel module, can also be used as a signal splitter

ACT20X-HTI-5AO / 2HTI-2SAO

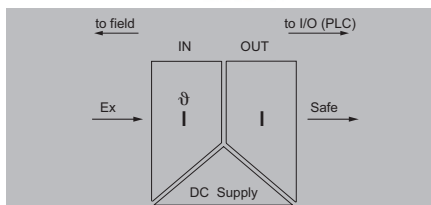

Usable as:

- Safety barrier (insulator)
- Signal conversion
- 2-wire measuring transducer
- Amplifier, repeater
- Limit switch

Technical data

Input	
Type	Temperature input range
Line resistance in measuring circuit	Input current
Input resistance, current	
Output	
Output current	Output signal limit
Load impedance current	Influence of load resistance
Alarm output	
Type	Nominal switching voltage
Continuous current	Power rating
General data	
Voltage supply	Power consumption
Tightening torque, min. / Tightening torque, max.	Ambient temperature / Storage temperature
Approvals	
Approvals	
Insulation coordination	
Insulation voltage	Rated voltage
EMC standards	
Dimensions	
Clamping range (nominal / min. / max.)	mm ²
Length x width x height	mm
Note	

intrinsically safe circuit, RTD, TC, DC (mA)	
Configurable, PT100: -200...+850 °C, PT200: -200...+850 °C, PT1000: -200...+850 °C, NI100: -60°C...+250 °C, Ni120: -80 °C...+320 °C, NI1000: -60°C...+250 °C, B: +100...+1820 °C, E: (-100...+1000 °C), J: (-100...+1200 °C), K: (-180...+1372 °C), L: (-200...+900 °C), N: (-180...+1300 °C), R: (-50...+1760 °C), S: (-50...+1760 °C), T: (-200...+400 °C), U: (-200...+600 °C), W3: (0...+2300 °C), W5: (0...+2300 °C), LR: (-200...+800 °C)	
≤ 50 Ω	0...20 mA, 4...20mA
	20 Ω + PTC 50 Ω
	0...23 mA, configurable: 0...20 / 4...20 / 20...0 / 20...4 mA, configurable downscale (3.5 mA) / upscale (23 mA) @ error
	3.8...20.5 mA / 0...20.5 mA (dependent on range)
≤ 600 Ω	≤ 0.01% of span / 100 Ω
	Status relay, 1 NC (voltage-free)
≤ 125 V AC / 110 V DC (safe area)	≤ 32 V AC / 32 V DC (zone 2)
≤ 0.5 A AC / 0.3 A DC (safe zone), ≤ 0.5 A AC / 1 A DC (zone 2)	≤ 62.5 VA / 32 W (safe area)
≤ 16 VA / 32 W (Zone 2)	
19.2...31.2 V DC	≤ 0.8 W
0.4 Nm / 0.6 Nm	-20 °C...60 °C / -20 °C...85 °C
	CE; cULus; DETNORVER; FMEX; FUSAFETY; IECEXKEM; KEMAATEX
Screw connection PUSH IN	
2.5 / 0.25 / 2.5	22.5 / 119.2
	22.5 / 127.3

Type	Temperature-range	Accuracy
Metal PTC		
Pt100	-200...850 °C	± (0.15 + 0.02 x T) Class A ± (0.30 °C + 0.005 x T) Class B
Pt500	-200...850 °C	
Pt1000	-200...850 °C	
Ni50		
Ni100	-60...0 °C	± (0.4 + 0.007 x T)
Ni120	0...180 °C	± (0.4 + 0.028 x T)
Ni1000		
TC-Type according to IEC60584-1		
B	50...250 °C	± 25 K
	250...500 °C	± 10 K
E	500...1820 °C	± 6 K
	-200...-150 °C	± 4 K
J	-150...1000 °C	± 3 K
	-200...-150 °C	± 4 K
K	-150...1200 °C	± 3 K
	-200...-150 °C	± 5 K
N	-150...1200 °C	± 3 K
	-200...-150 °C	± 6 K
R	-150...1300 °C	± 3 K
	-50...200 °C	± 10 K
S	200...1780 °C	± 6 K
	-50...200 °C	± 10 K
T	200...1780 °C	± 6 K
	-200...-150 °C	± 5 K
	-150...400 °C	± 3 K
according to DIN43710		
U	0...600 °C	± 3 °C
L	0...900 °C	± 3 °C

Ordering data

1-channel version	
	Screw connection
	PUSH IN connection
2-channel version	
	Screw connection
	PUSH IN connection
Note	

Type	Qty.	Order No.
ACT20X-HTI-5AO-S	1	8965470000
ACT20X-HTI-5AO-P	1	2456180000
ACT20X-2HTI-2SAO-S	1	8965480000
ACT20X-2HTI-2SAO-P	1	2456190000
CBX200 USB configuration adapter - 8978580000		

Switching amplifier

Switching amplifier with relay output

The ACT20X-HDI-SDO-RNO (NC) isolating switching amplifier is a specialised signal isolating converter for NAMUR sensor signals or for volt-free contacts from a Zone 0 hazardous area. A single relay, available optionally as NC or NO, provides the output signal in the safe zone. Single-channel or double-channel versions are also available.

EX area Zone 0, 1, 2, 20, 21, 22

Safe area Zone 2 / FM Class 1, Division 2

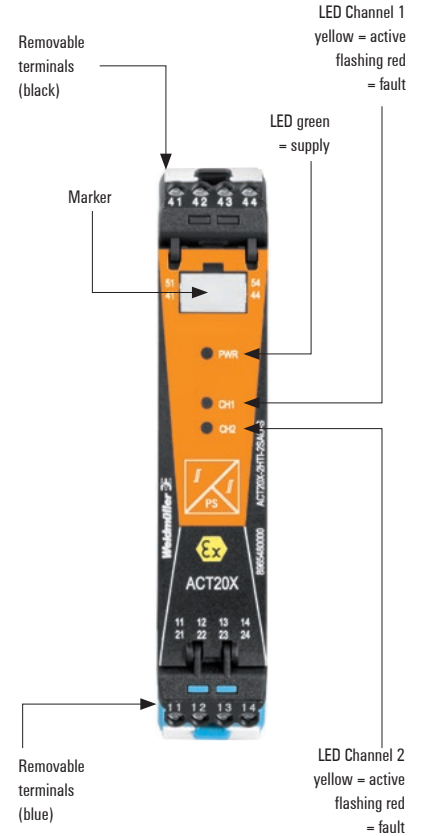
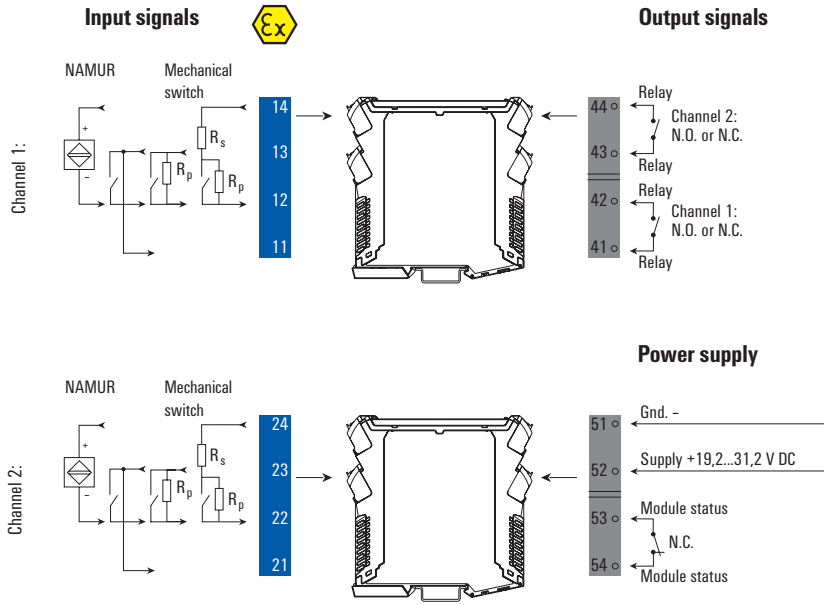

Ex label (excerpt)

ATEX	FM	U_o	10.6 V
II 3 G Ex nA nC IIC T4	Installation in CL I DIV2 GP A-D T4	I_o	12 mA
II (1) G [Ex ia Ga] IIC/IIB/IIA	KI. III ABT 1/2 GP A-G oder	P_o	32 mW
II (1) D [Ex iaD]	KI. I Zn2 AEx/Ex nA nC [ia] IIC T4	L_s / R_s	1150 μ H/ Ω
IECEX	Example:	IIC	$C_o = 2 \mu$ F, $L_s = 260$ mH
Ex nA nC IIC T4 Gc	ATEX version,	IIB	$C_o = 6 \mu$ F, $L_s = 780$ mH
[Ex ia Ga] IIC/IIB/IIA	Ex input	IIA	$C_o = 18 \mu$ F, $L_s = 1000$ mH
[Ex ia Da] IIIC	(More details in ATEX certificate)		



Application: monitoring of fill level with the ACT20X HDI-SDO-RNO (relay output)

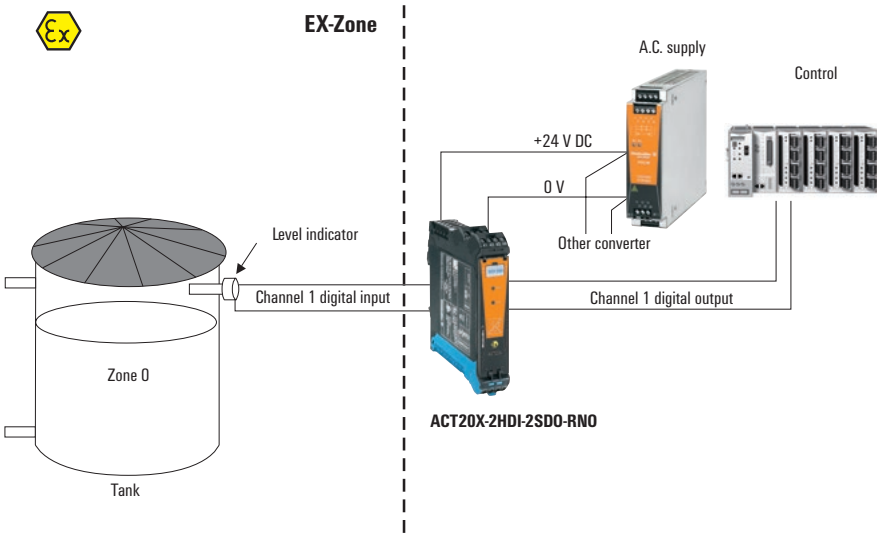

Switching amplifier with relay output

- Converts intrinsically safe digital signals (NAMUR / switching contact) from EX Zone 0 into digital output signals (relay output) for the safe zone
- PC configuration with FDT/DTM software, download at www.weidmueller.com
- Relay output for error alarm, cable break, short-circuit
- 1 or 2 channels in one module

ACT20X-HDI-SDO-RNO, RNC / 2HDI-2SDO-RNO, RNC

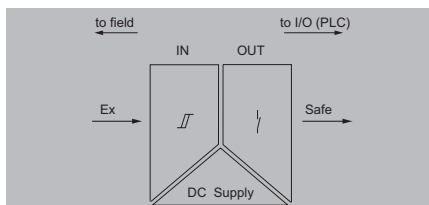

Technical data

Input	
Sensor	
Sensor supply	
Resistance	
Input frequency	
Trigger level low / Trigger level high	
Output signal in case of wire break	
Output	
Type	
Nominal switching voltage	
Alarm output	
Type	
Nominal switching voltage	
General data	
Voltage supply	
Power consumption	
Ambient temperature / Storage temperature	
Approvals	
Approvals	
Insulation coordination	
Insulation voltage	
Rated voltage	
EMC standards	
Dimensions	
Clamping range (nominal / min. / max.)	mm ²
Length x width x height	mm
Note	

NAMUR sensor, according to EN60947-5-6, switch with or without RS, RP	
8 V DC / 8 mA	
RP = 750 Ω / RS = 15kΩ	
<20 Hz	
<1.2 mA / > 2.1 mA	
<0.1 mA, > 6.5 mA (in case of wire break)	
Relay, 1 NO, Switching frequency 20 Hz	
≤ 250 V AC / 30 V DC (safe area)	
≤ 32 V AC / 32 V DC (zone 2)	
Status relay, 1 NC (voltage-free)	
≤ 125 V AC / 110 V DC (safe area)	
≤ 32 V AC / 32 V DC (zone 2)	
19.2...31.2 V DC	
≤ 1.3 W	
-20 °C...60 °C / -20 °C...85 °C	
CE; cULus; DETNORVER; FMEX; FUSAFETY; IECEXKEM; KEMAATEX	
2.6 kV (input / output)	
300 V	
EN 61326-1	
Screw connection	
PUSH IN	
2.5 / 0.25 / 2.5	
22.5 / 119.2	22.5 / 127.3

Ordering data

1-channel version, NO	
	Screw connection
	PUSH IN connection
1-channel version, NC	
	Screw connection
	PUSH IN connection
2-channel version, NO	
	Screw connection
	PUSH IN connection
2-channel version, NC	
	Screw connection
	PUSH IN connection
Note	

Type	Qty.	Order No.
ACT20X-HDI-SDO-RNO-S	1	8965340000
ACT20X-HDI-SDO-RNO-P	1	2456050000
ACT20X-HDI-SDO-RNC-S	1	8965350000
ACT20X-HDI-SDO-RNC-P	1	2456060000
ACT20X-2HDI-2SDO-RNO-S	1	8965370000
ACT20X-2HDI-2SDO-RNO-P	1	2456080000
ACT20X-2HDI-2SDO-RNC-S	1	8965380000
ACT20X-2HDI-2SDO-RNC-P	1	2456090000
Note		
CBX200 USB configuration adapter - 8978580000		

Switching amplifier

Switching amplifier with transistor output

The ACT20X-HDI-SDO isolating switching amplifier is a digital pulse signal isolator for Namur sensors or volt-free contacts from a Zone 0 hazardous area. A transistor (NPN) output is provided for the receiver or controller in the safe area. Single-channel or double-channel versions are also available.

EX area Zone 0, 1, 2, 20, 21, 22

Safe area Zone 2 / FM Class 1, Division 2

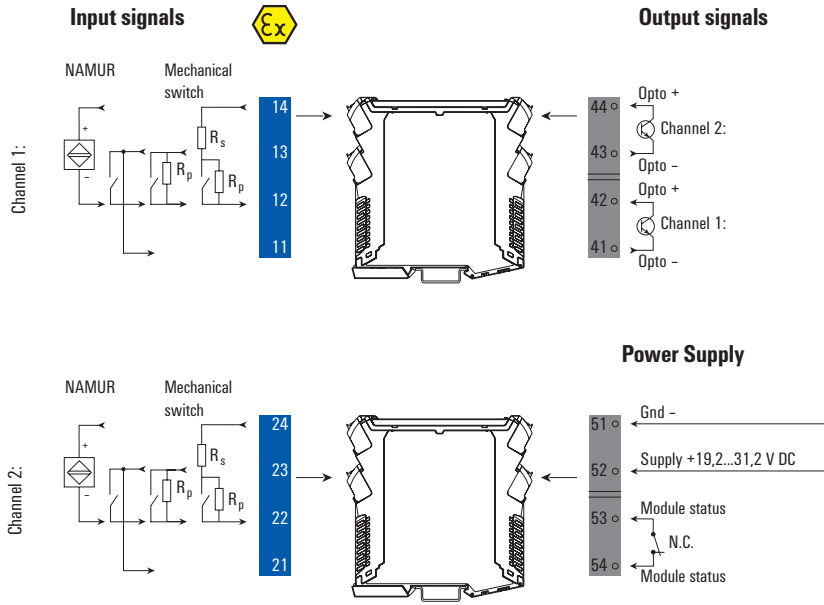

Ex label (excerpt)

ATEX	FM	U_o	10.6 V
II 3 G Ex nA nC IIC T4	Installation in CL I DIV2 GP A-D T4	I_o	12 mA
II (1) G [Ex ia Ga] IIC/IIB/IIA	KI. III ABT 1/2 GP A-G oder	P_o	32 mW
II (1) D [Ex iaD]	KI. I Zn2 AEx/Ex nA nC [ia] IIC T4	L_s / R_s	1150 μ H/ Ω
IECEX	Example:	IIC	$C_o = 2 \mu$ F, $L_s = 260$ mH
Ex nA nC IIC T4 Gc	ATEX version	IIB	$C_o = 6 \mu$ F, $L_s = 780$ mH
[Ex ia Ga] IIC/IIB/IIA	Ex input	IIA	$C_o = 18 \mu$ F, $L_s = 1000$ mH
[Ex ia Da] IIIC	(More details in ATEX certificate)		



Application: monitoring the fill level with isolating switching amplifier

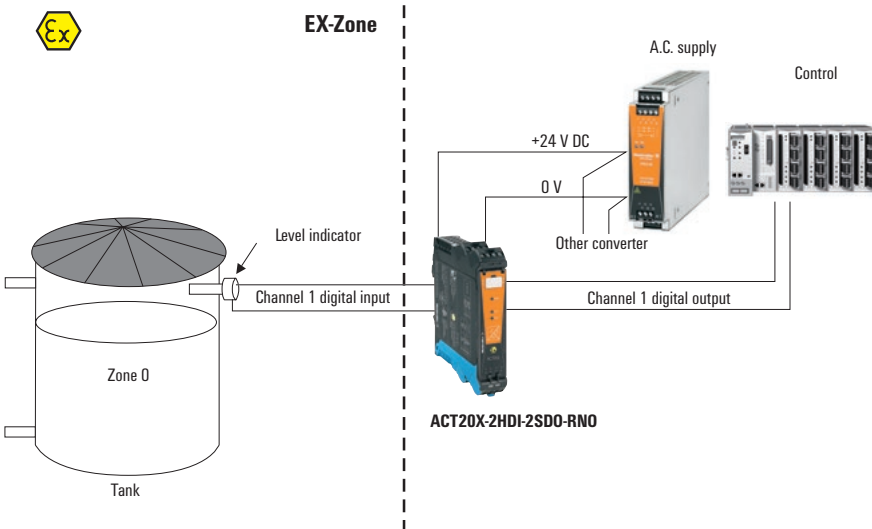

Switching amplifier with transistor output

- Converts intrinsically safe signals (NAMUR / switching contact) from EX Zone 0 into digital output signals (relay output) for the safe zone
- PC configuration with FDT/DTM software, download at www.weidmueller.com
- Relay output for error alarm
- 1 or 2 channels in one module

ACT20X-HDI-SDO / 2HDI-2SDO

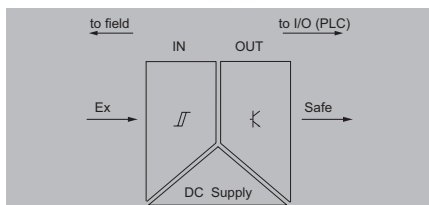

Technical data

Input	
Sensor	
Sensor supply	
Resistance	
Input frequency	
Pulse duration	
Input resistance	
Trigger level low / Trigger level high	
Output signal in case of wire break	
Output	
Type	
Pulse duration	
Nominal switching voltage	
Alarm output	
Type	
Nominal switching voltage	
Continuous current	
Power rating	
General data	
Power consumption	
Voltage supply	
Power consumption	
Tightening torque, min. / Tightening torque, max.	
Ambient temperature / Storage temperature	
Approvals	
Approvals	
Insulation coordination	
Insulation voltage	
Rated voltage	
EMC standards	
Dimensions	
Clamping range (nominal / min. / max.)	mm ²
Length x width x height	mm
Note	

NAMUR sensor, according to EN60947-5-6, switch with or without RS, RP	
8 V DC / 8 mA	
Series resistor 750Ω, Parallel resistor 15kΩ	
0...5 kHz	
> 0.1 ms	
1 kΩ	
<1.2 mA / > 2.1 mA	
<0.1 mA, > 6.5 mA (in case of wire break)	
NPN-Transistor	
> 0.1 ms	
30 V DC	
Status relay, 1 NC (voltage-free)	
≤ 125 V AC / 110 V DC (safe area)	
≤ 32 V AC / 32 V DC (zone 2)	
≤ 0.5 A AC / 0.3 A DC (safe zone), ≤ 0.5 A AC / 1 A DC (zone 2)	
≤ 62.5 VA / 32 W (safe area)	
≤ 16 VA / 32 W (Zone 2)	
≤ 1.1 W	
19.2...31.2 V DC	
≤ 1.1 W	
0.4 Nm / 0.6 Nm	
-20 °C...60 °C / -20 °C...85 °C	
CE; cULus; DETNORVER; FMEX; FUSAFETY; IECEXKEM; KEMAATEX	
2.6 kV (input / output)	
300 V	
EN 61326-1	
Screw connection	
PUSH IN	
2.5 / 0.25 / 2.5	
22.5 / 119.2	
22.5 / 127.3	

Ordering data

1-channel version	
	Screw connection
	PUSH IN connection
2-channel version	
	Screw connection
	PUSH IN connection
Note	

Type	Qty.	Order No.
ACT20X-HDI-SDO-S	1	8965360000
ACT20X-HDI-SDO-P	1	2456070000
ACT20X-2HDI-2SDO-S	1	8965390000
ACT20X-2HDI-2SDO-P	1	2456100000
Note		
CBX200 USB configuration adapter - 8978580000		



Solenoid drivers

Solenoid driver for gas group IIC, 35 mA

The ACT20X-SDI-HAO-S solenoid/actuator driver takes a switched input from e.g. a safe area controller and delivers an corresponding output to operate an actuator in a hazardous area, e.g. Zone 0. It is available in a single-channel or double-channel version.

EX area Zone 0, 1, 2, 20, 21, 22

Save area Zone 2 /FM KI. 1 Abt. 2

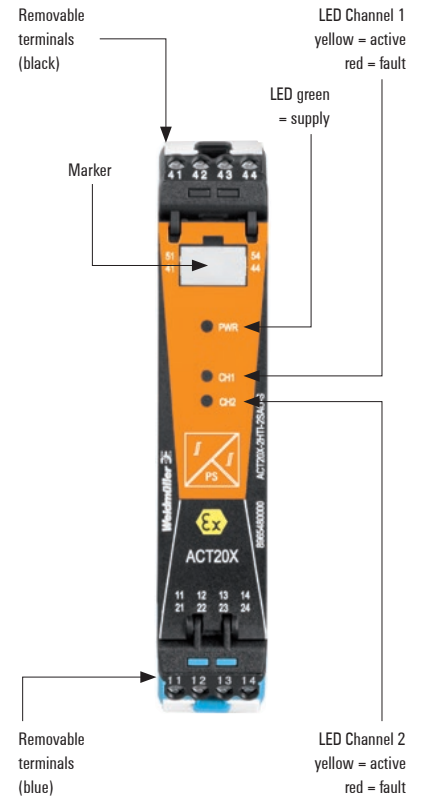
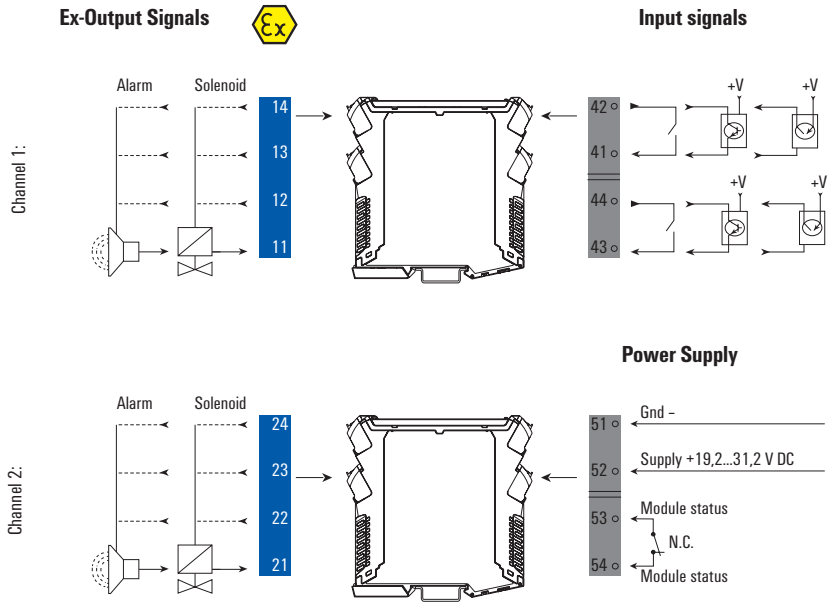

Ex label (excerpt)

ATEX	FM	U_o	28 V
II 3 G Ex nA nC IIC T4	Installation in CL I DIV2 GP A-D T4	I_o	100 mA
II (1) G [Ex ia Ga] IIC/IIB/IIA	KI. HII ABT 1/2 GP A-G oder	P_o	0.70 mW
II (1) D [Ex iaD]	KI. I Zn2 AEx/Ex nA nC [ia] IIC T4	IIC	$C_o = 0.08 \mu F, L_o = 2.9 mH$
IECEX	Example:	IIB	$C_o = 0.64 \mu F, L_o = 12.8 mH$
Ex nA nC IIC T4 Gc	ATEX version	IIA	$C_o = 2.1 \mu F, L_o = 22.8 mH$
[Ex ia Ga] IIC/IIB/IIA	Ex Output Terminal (11-14)		
[Ex ia Da] IIIC	(More details in ATEX certificate)		



Application: Inflow control in Ex zone with gas group IIC

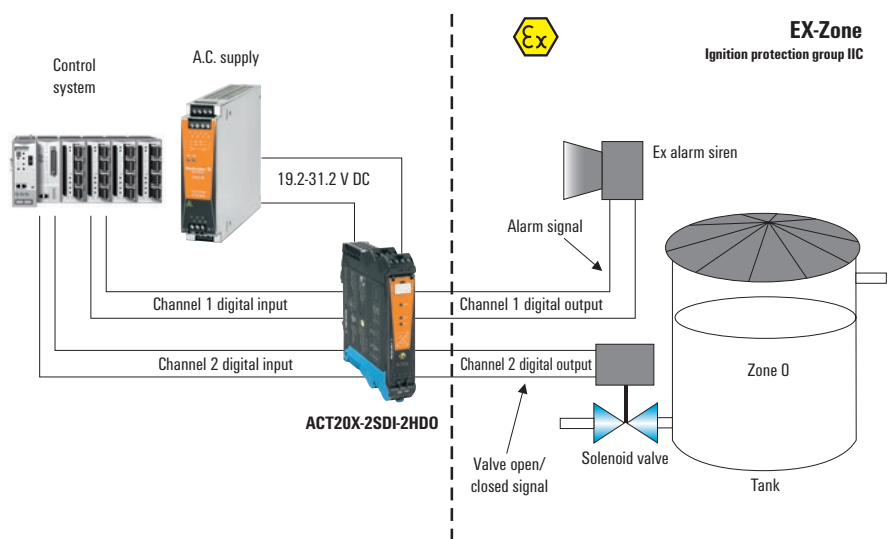

Output data

For gas group IIC (≤ 35 mA)

Connection terminal			
Channel 1	U without load	U with load	I max
11-12	Min. 24 V	Min. 12.5 V	35 mA
11-13	Min. 24 V	Min. 13.5 V	35 mA
11-14	Min. 24 V	Min. 14.5 V	35 mA
Note			

For gas group IIC (≤ 35 mA)

Connection terminal			
Channel 2	U without load	U with load	I max
21-22	Min. 24 V	Min. 12.5 V	35 mA
21-23	Min. 24 V	Min. 13.5 V	35 mA
21-24	Min. 24 V	Min. 14.5 V	35 mA
Note			

Solenoid driver for gas group IIC, 35 mA

- Valve control component for control of intrinsically safe valves, LEDs, acoustic alarms, etc.
- PC configuration with FDT/DTM software, download at www.weidmueller.com
- Output current is limited to 35 mA for ignition group IIC
- 1 or 2 channels in one module
- Relay output for error alarm

ACT20X-SDI-HDO / 2SDI-2HDO

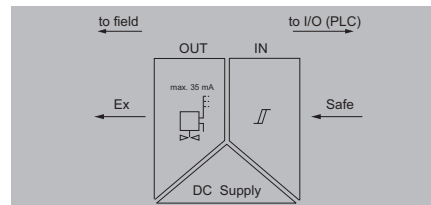

Technical data

Input	
Type	NPN, PNP transistor, switching signal (input safe-side valve component)
Input voltage	≤ 28 V DC, Trigger level low: ≤ 2.0 V DC (NPN), ≤ 8.0 V DC (PNP), Trigger level high: ≥ 4.0 V DC (NPN), ≥ 10.0 V DC (PNP)
Input resistance, voltage	3.5 k Ω
Ex-output	
Type	intrinsically safe circuit, digital, output = input, direct or inverse (configurable)
Output current	max. 35 mA
Output values	depending on terminal assignment
Alarm output	
Type	Status relay, 1 NC (voltage-free)
Nominal switching voltage	≤ 125 V AC / 110 V DC (safe area) ≤ 32 V AC / 32 V DC (zone 2)
Continuous current	≤ 0.5 A AC / 0.3 A DC (safe zone), ≤ 0.5 A AC / 1 A DC (zone 2)
Power rating	≤ 62.5 VA / 32 W (safe area) ≤ 16 VA / 32 W (Zone 2)
General data	
Voltage supply	19.2...31.2 V DC
Power consumption	≤ 1.9 W
Tightening torque, min. / Tightening torque, max.	0.4 Nm / 0.6 Nm
Ambient temperature / Storage temperature	-20 °C...60 °C / -20 °C...85 °C
Approvals	
Approvals	CE; cULus; DETNORVER; FMEX; FUSAFETY; IECEXKEM; KEMAATEX
Insulation coordination	
Insulation voltage	2.6 kV (input / output)
Rated voltage	300 V
EMC standards	EN 61326-1
Dimensions	
Clamping range (nominal / min. / max.)	mm ²
Length x width x height	mm
Note	
Ordering data	
1-channel version	
Screw connection	
PUSH IN connection	
2-channel version	
Screw connection	
PUSH IN connection	
Note	

Screw connection	PUSH IN
2.5 / 0.25 / 2.5	
22.5 / 119.2	22.5 / 127.1

Type	Qty.	Order No.
ACT20X-SDI-HDO-L-S	1	8965400000
ACT20X-SDI-HDO-L-P	1	2456110000
ACT20X-2SDI-2HDO-S	1	8965420000
ACT20X-2SDI-2HDO-P	1	2456130000

CBX200 USB configuration adapter - 8978580000

Solenoid drivers

Solenoid driver for gas group IIC, 60 mA

The ACT20X-SDI-HAO-S solenoid/actuator driver takes a switched input from e.g. a safe area controller and delivers an corresponding output to operate an actuator in a hazardous area, e.g. Zone. This driver is suitable for switching solenoid valves or alarm devices.

EX area Zone 0, 1, 2, 20, 21, 22

Safe area Zone 2 / FM Class 1, Division 2

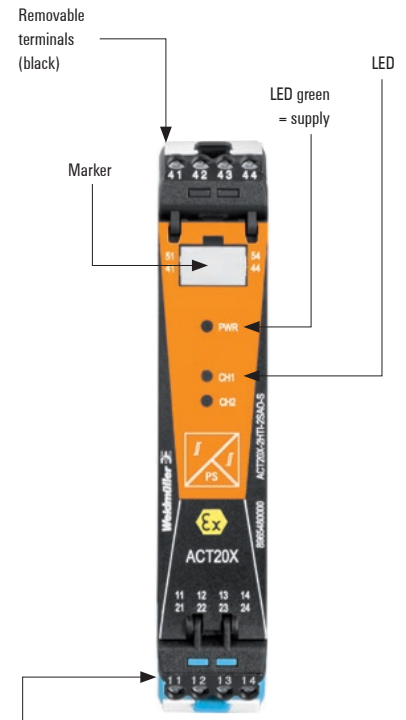
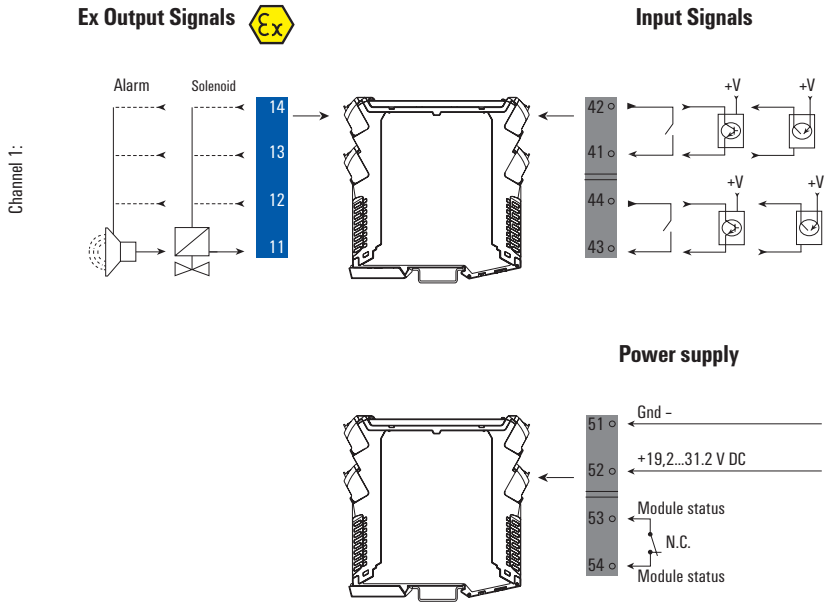

Ex label (excerpt)

ATEX	FM	U_o	28 V
II 3 G Ex nA nC IIC T4	Installation in CL I DIV2 GP A-D T4	I_o	135 mA
II (1) G [Ex ia Ga] IIC/IIB/IIA	KI. III ABT 1/2 GP A-G oder	P_o	0.95 W
II (1) D [Ex iaD]	KI. I Zn2 AEx/Ex nA nC [ia] IIC T4	IIC	$C_o = -$, $L_o = -$
IECEX	Example:	IIB	$C_o = 0.64 \mu F$, $L_o = 7.8 mH$
Ex nA nC IIC T4 Gc	ATEX version,	IIA	$C_o = 2.1 \mu F$, $L_o = 15.1 mH$
[Ex ia Ga] IIC/IIB/IIA	Ex Output Terminal (11-14)		
[Ex ia Da] IIIC	(More details in ATEX certificate)		



Application: Inflow control in Ex zone with gas group IIB

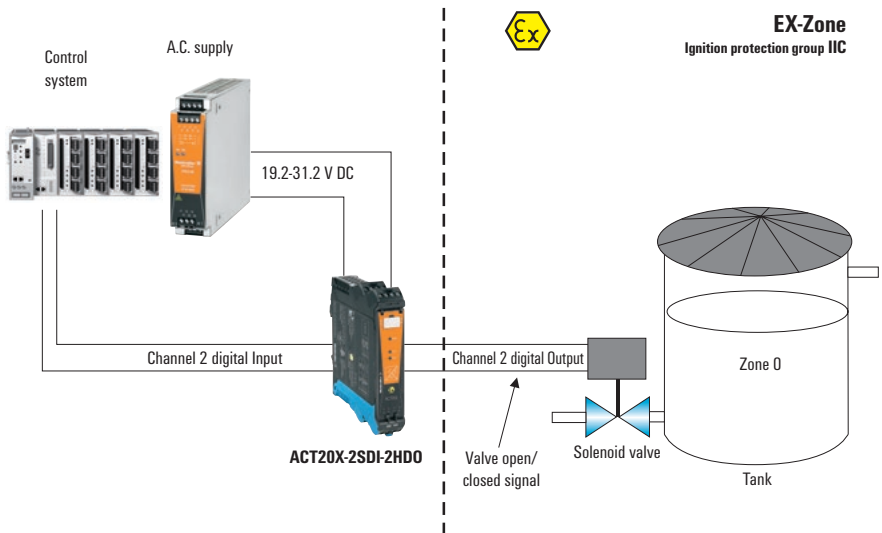

Output data For gas group IIB (≤ 60 mA)

Connection terminal	Channel 1	U without load	U with load	I max
11-12		Min. 24 V	Min. 9 V	60 mA
			Min. 11.5 V	50 mA
11-13		Min. 24 V	Min. 12.5 V	60 mA
			Min. 10 V	50 mA
11-14		Min. 24 V	Min. 11 V	60 mA
			Min. 13 V	50 mA

Note

Solenoid driver for gas group IIC, 60 mA

- Valve control component for control of intrinsically safe valves, LEDs, acoustic alarms, etc.
- PC configuration with FDT/DTM software, download at www.weidmueller.com
- Output current is limited to 35 mA for ignition group IIC
- 1 or 2 channels in one module
- Relay output for error alarm

ACT20X-SDI-HD0-H

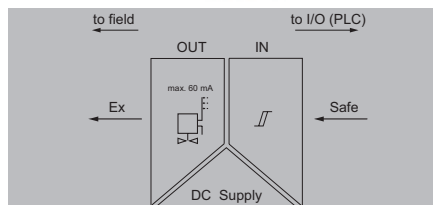

Technical data

Input		
Type	NPN, PNP transistor, switching signal (input safe-side valve component)	
Input voltage	≤ 28 V DC, Trigger level low: ≤ 2.0 V DC (NPN), ≤ 8.0 V DC (PNP), Trigger level high: ≥ 4.0 V DC (NPN), ≥ 10.0 V DC (PNP)	
Input resistance, voltage	3.5 k Ω	
Ex-output		
Type	intrinsically safe circuit, digital, output = input, direct or inverse (configurable)	
Output current	max. 60 mA	
Output values	depending on terminal assignment	
Alarm output		
Type	Status relay, 1 NC (voltage-free)	
Nominal switching voltage	≤ 125 V AC / 110 V DC (safe area) ≤ 32 V AC / 32 V DC (zone 2)	
Continuous current	≤ 0.5 A AC / 0.3 A DC (safe zone), ≤ 0.5 A AC / 1 A DC (zone 2)	
Power rating	≤ 62.5 VA / 32 W (safe area) ≤ 16 VA / 32 W (Zone 2)	
General data		
Voltage supply	19.2...31.2 V DC	
Power consumption	≤ 2.5 W	
Tightening torque, min. / Tightening torque, max.	0.4 Nm / 0.6 Nm	
Ambient temperature / Storage temperature	-20 °C...60 °C / -20 °C...85 °C	
Approvals		
Approvals	CE; cULus; DETNORVER; FMEX; FUSAFETY; IECEXKEM; KEMAATEX	
Insulation coordination		
Insulation voltage	2.6 kV (input / output)	
Rated voltage	300 V	
EMC standards	EN 61326-1	
Dimensions		
Clamping range (nominal / min. / max.)	mm ²	
Length x width x height	mm	
Note		
Screw connection	PUSH IN	
	2.5 / 0.25 / 2.5	
	22.5 / 119.2 22.5 / 127.1	
Ordering data		
1-channel version		
	Screw connection	
	PUSH IN connection	
Type	Qty.	Order No.
ACT20X-SDI-HD0-H-S	1	8965410000
ACT20X-SDI-HD0-H-P	1	2456120000
Note	CBX200 USB configuration adapter - 8978580000	

Universal measurement transducers

Universal measurement transducers for temperature, standard and potentiometer signals

The ACT20X-HUI-SA0-S is a universal input signal isolator/converter. This model processes temperature signals from PT100 sensors and thermocouples as well as DC voltage and current signals (mA) from the hazardous area. On the output side, an isolated milliamp signal is passed to the receiver or controller in the safe area. The module also has a safe relay output for which the switching threshold can be configured.

EX area Zone 0, 1, 2, 20, 21, 22

Safe area Zone 2 / FM Class 1, Division 2

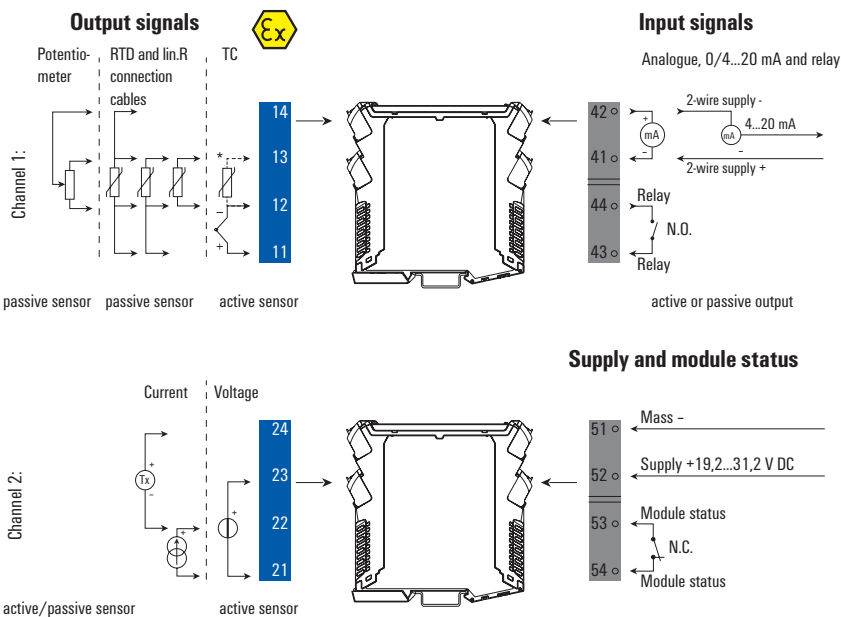

Ex label (excerpt)

ATEX	FM	U_i / U_o	30 V / 8.3 V
II 3 G Ex nA nC IIC T4	Installation in CL I DIV2 GP A-D T4	I_i / I_o	120 mA / 0.2 mA
II (1) G [Ex ia] IIC/IIB/IIA	KI, III ABT 1/2 GP A-G or	P_i / P_o	900 mW / 0.4 mW
II (1) D [Ex iaD]	KI, I Zn2 AEx/Ex nA nC [ia] IIC T4	C_i	3 nF
IECEX	Example:	L_i	1 μ H
Ex nA nC IIC T4 Gc	ATEX version,	IIC	$C_o = 7 \mu$ F $L_o = 1000$ mH
[Ex ia Ga] IIC/IIB/IIA	Ex input External Current Source	IIB	$C_o = 73 \mu$ F $L_o = 1000$ mH
[Ex ia a] IIC	(More details in ATEX certificate)	IIA	$C_o = 1000 \mu$ F $L_o = 1000$ mH



Application example: position measurement of an actuator

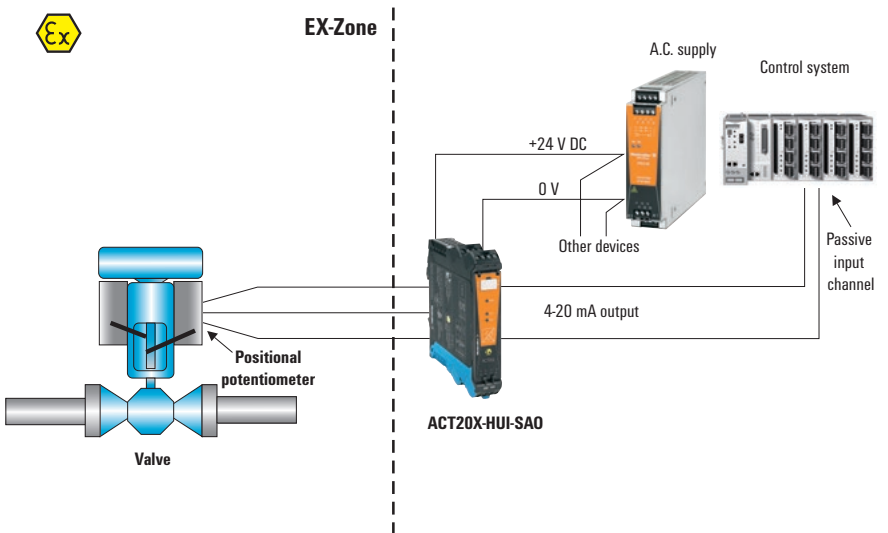

**Accuracy / temperature coefficients
ACT20X-HUI-SA0**

Input	Accuracy	Temperature coefficient
Input mA	$\leq \pm 4 \mu$ A	$\leq \pm 4 \mu$ A / °C
Input Volt	$\leq \pm 20 \mu$ V	$\leq \pm 2 \mu$ V / °C
Input RTD		
Pt100	$\leq \pm 0.2$ °C	$\leq \pm 0.02$ °C / °C
Ni100	$\leq \pm 0.3$ °C	$\leq \pm 0.03$ °C / °C
Input TC		
Type B	$\leq \pm 4.5$ °C	$\leq \pm 0.45$ °C / °C
Type E, J, K, L, N, T, U	$\leq \pm 1$ °C	$\leq \pm 0.1$ °C / °C
Type R, S, W3, W5, LR	$\leq \pm 2$ °C	$\leq \pm 0.2$ °C / °C
Note		

Universal measurement transducers

- Universal isolator for intrinsically safe RTD signals, thermal sensor signals, resistor signals, potentiometer signals and DC signals (mA,V)
- PC configuration with FDT/DTM software, download at www.weidmueller.com
- Digital relay output adjustable as threshold switch
- Relay output for error alarm

ACT20X-HUI-SA0

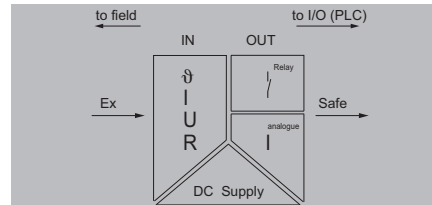

Usable as:

- Safety barrier (insulator)
- Signal conversion
- 2-wire measuring transducer
- Amplifier, repeater
- Limit switch

Technical data

Input	
Type	
Temperature input range	
Line resistance in measuring circuit	
Input current	
Input voltage	
Potentiometer	
Input resistance, voltage/current	
Output analogue	
Output current	
Output signal limit	
Load impedance current	
Output digital	
Type	
Function	
Nominal switching voltage	
Continuous current	
Alarm output	
Type	
Nominal switching voltage	
General data	
Voltage supply	
Power consumption	
Ambient temperature / Storage temperature	
Approvals	
Approvals	
Insulation coordination	
Insulation voltage / Rated voltage	
EMC standards	
Dimensions	
Clamping range (nominal / min. / max.)	mm ²
Length x width x height	mm
Note	

intrinsically safe circuit, active (as current source) or passive (as current sink)	
Configurable, PT100: -200...+850 °C, PT200: -200...+850 °C, PT1000: -200...+850 °C, NI100: -60°C...+250 °C, Ni120: -80 °C...+320 °C, NI1000: -60°C...+250 °C, B: +100...+1820 °C, E: (-100...+1000 °C), J: (-100...+1200 °C), K: (-180...+1372 °C), L: (-200...+900 °C), N: (-180...+1300 °C), R: (-50...+1760 °C), S: (-50...+1760 °C), T: (-200...+400 °C), U: (-200...+600 °C), W3: (0...+2300 °C), W5: (0...+2300 °C), LR: (-200...+800 °C)	
≤ 50 Ω	
0...20 mA, 4...20 mA	
configurable, 0...1 V DC, 0,2...1 V DC, 1...5 V DC, 0...(5)10 V, 2...10 V DC	
10 Ω...10 kΩ	
> 10 MΩ @ 600 mV, 2 MΩ @ 28 V / 20 Ω + PTC 50 Ω	
0...23 mA, configurable: 0...20 / 4...20 / 20...0 / 20...4 mA, configurable downscale (3.5 mA) / upscale (23 mA) @ error	
3.8...20.5 mA / 0...20.5 mA (dependent on range)	
≤ 600 Ω	
Relay, 1 NO	
Configurable switching thresholds, Window function, Sensor error	
≤ 250 V AC / 30 V DC (safe area)	
≤ 32 V AC / 32 V DC (zone 2)	
≤ 2 A AC/DC (safe area, Zone 2 area)	
Status relay, 1 NC (voltage-free)	
≤ 125 V AC / 110 V DC (safe area)	
≤ 32 V AC / 32 V DC (zone 2)	
19.2...31.2 V DC	
≤ 2.1 W	
-20 °C...60 °C / -20 °C...85 °C	
CE; cULus; DETNORVER; FMEX; FUSAFETY; IECEXKEM; KEMAATEX	
2.6 kV (input / output) / 300 V	
EN 61326-1	
Screw connection PUSH IN	
2.5 / 0.25 / 2.5	
22.5 / 119.2	22.5 / 127.3

Type	Temperature-range	Accuracy
Metal PTC		
Pt100	-200...850 °C	± (0.15 + 0.02 x T) Class A ± (0.30 °C + 0.005 x T) Class B
Pt500	-200...850 °C	
Pt1000	-200...850 °C	
Ni50		
Ni100	-60...0 °C	± (0.4 + 0.007 x T) ± (0.4 + 0.028 x T)
Ni120	0...180 °C	
Ni1000		
TC-Type according to IEC60584-1		
B	50...250 °C	± 25 K
	250...500 °C	± 10 K
	500...1820 °C	± 6 K
E	-200...-150 °C	± 4 K
	-150...1000 °C	± 3 K
J	-200...-150 °C	± 4 K
	-150...1200 °C	± 3 K
K	-200...-150 °C	± 5 K
	-150...1200 °C	± 3 K
N	1200...1372 °C	± 4 K
	-200...-150 °C	± 6 K
R	-150...1300 °C	± 3 K
	-50...200 °C	± 10 K
S	200...1780 °C	± 6 K
	-50...200 °C	± 10 K
T	200...1780 °C	± 6 K
	-200...-150 °C	± 5 K
U	-150...400 °C	± 3 K
according to DIN43710		
U	0...600 °C	± 3 °C
L	0...900 °C	± 3 °C

Ordering data

1-channel version	
Screw connection	
PUSH IN connection	
Note	

Type	Qty.	Order No.
ACT20X-HUI-SA0-S	1	8965490000
ACT20X-HUI-SA0-P	1	2456200000
CBX200 USB configuration adapter - 8978580000		

Signal converters and monitoring components – ACT20P

Signal converters and monitoring components – ACT20P	Introduction	C.2
	Selection table	C.4
	Supply isolator	C.9
	Isolation amplifier	C.12
	Standard converter	C.13
	Passive isolators	C.14
	Temperature transducer	C.18
	Limit switch	C.21
	Current and voltage transformers	C.25
	Measuring bridge transducers	C.28
	Universal transducers	C.29
	Frequency transducers	C.31

Your practical requirements are many Just like our ACT20P signal isolating converters

C The reliable isolation and specific conversion of analogue signals plays an increasingly important role in many areas of industry and technology. When we developed the ACT20P signal converter we took full account of various technical requirements of machine engineering, the process industry and energy technology. In particular, the specifications of EN61010-1 provided important basic parameters for the technology of the equipment.



Perfectly equipped for the machine engineering sector

Filling systems and packaging machines used in the food or pharmaceutical industry, for example, are a classic area of application for signal converters. They convert analogue signals such as temperature, pressure, fill level, flow, weight, etc. directly into standard signals for processing by the PLC. And best of all: a signal converter solution usually costs much less than an input module in the remote-i/o-system adapted to the specific requirements of the sensor.



Ideally suited for the process industry and energy technology

In water treatment plants, conveyor technology, gas and coal-fired power plants, energy distribution stations and in many other types of plant in the process and energy technology sector signal converters have two main functions: on the one hand, they provide reliable galvanic isolation – especially if the cables of the sensors from the field are several hundred meters in length. On the other hand, our signal converters enable individual signals such as potentiometer signals from rotary encoders or TC type J signals from temperature sensors to be adapted for the standardised inputs of DCS- or Remote-i/o-systems.

Can be integrated in HART® communication

Signal converters are suitable for HART®, transparent communication.



Reliable connection

Individually customisable protection against mismatching.



Rapid device replacement

Practical release lever for simple removal of the female connector.



More space in the cabinet

Two channels measure a mere 12.5 mm wide.



Variants for different applications

The range of products is rounded off by the intrinsically safe ACT20X signal converter and the high-performance ACT20M signal converter, which is just 6 mm across.



Selection table

Selection table

Order No.	Product	Input										Width
		Number of channels	0...20 mA	4...20 mA	0...10 V	0...5 V	TC	RTD	Frequency	Miscellaneous	sensor feed	

Signalwandler und Prozessüberwachung – ACT20P

Supply isolator												
7760054114	ACT20P-CI-CO-S	1	X	X							2-/3-/4-wire sensor, HART® transparent	X 12.5 mm
2489680000	ACT20P-CI-CO-P	1	X	X							2-/3-/4-wire sensor, HART® transparent	X 12.5 mm
1506200000	ACT20P-CI-CO-P-S	1	X	X							2-/3-/4-wire sensor, HART® transparent	X 12.5 mm
2514620000	ACT20P-CI-CO-P-P	1	X	X							2-/3-/4-wire sensor, HART® transparent	X 12.5 mm
1540010000	ACT20P-CI-VO-S	1	X	X							2-/3-/4-wire sensor	X 12.5 mm
2489740000	ACT20P-CI-VO-P	1	X	X							2-/3-/4-wire sensor	X 12.5 mm
1537750000	ACT20P-CI-VO-P-S	1	X	X							2-/3-/4-wire sensor	X 12.5 mm
2514640000	ACT20P-CI-VO-P-P	1	X	X							2-/3-/4-wire sensor	X 12.5 mm
7760054115	ACT20P-CI-2CO-S	1	X	X							2-/3-/4-wire sensor, HART® transparent	X 12.5 mm
2489710000	ACT20P-CI-2CO-P	1	X	X							2-/3-/4-wire sensor, HART® transparent	X 12.5 mm
1506220000	ACT20P-CI-2CO-P-S	1	X	X							2-/3-/4-wire sensor, HART® transparent	X 12.5 mm
2514630000	ACT20P-CI-2CO-P-P	1	X	X							2-/3-/4-wire sensor, HART® transparent	X 12.5 mm
Isolation amplifier												
7760054117	ACT20P-2CI-2CO-12-S	2	X	X							4-wire sensor, HART® transparent	12.5 mm
2489730000	ACT20P-2CI-2CO-12-P	2	X	X							4-wire sensor, HART® transparent	12.5 mm
1506210000	ACT20P-2CI-2CO-12P-S	2	X	X							4-wire sensor, HART® transparent	12.5 mm
2514650000	ACT20P-2CI-2CO-12-P-P	2	X	X							4-wire sensor, HART® transparent	12.5 mm
Standard converter												
1477420000	ACT20P-AI-AO-DC-S	1	X	X	X	X						X 12.5 mm
2456860000	ACT20P-AI-AO-DC-P	1	X	X	X	X						X 12.5 mm
1545720000	ACT20P-AI-AO-AC-S	1	X	X	X	X						X 12.5 mm
2495700000	ACT20P-AI-AO-ACP	1	X	X	X	X						X 12.5 mm
Passive isolators												
7760054123	ACT20P-CI-CO-IHP-S	1	X	X							4-wire sensor	12.5 mm
7760054357	ACT20P-CI-CO-IHP-P	1	X	X							4-wire sensor	12.5 mm
7760054124	ACT20P-2CI-2CO-IHP-S	2	X	X							4-wire sensor	12.5 mm
7760054358	ACT20P-2CI-2CO-IHP-P	2	X	X							4-wire sensor	12.5 mm
7760054118	ACT20P-CI1-CO-DLP-S	1	X								4-wire sensor	12.5 mm
7760054353	ACT20P-CI1-CO-DLP-P	1	X								4-wire sensor	12.5 mm
7760054119	ACT20P-CI2-CO-DLP-S	1		X							4-wire sensor	12.5 mm
7760054354	ACT20P-CI2-CO-DLP-P	1		X							4-wire sensor	12.5 mm
7760054121	ACT20P-VI-CO-DLP-S	1			X						4-wire sensor	12.5 mm
7760054356	ACT20P-VI-CO-DLP-P	1			X						4-wire sensor	12.5 mm
7760054120	ACT20P-VI1-CO-DLP-S	1				X					4-wire sensor	12.5 mm
7760054355	ACT20P-VI1-CO-DLP-P	1				X					4-wire sensor	12.5 mm
7760054122	ACT20P-CI-2CO-DLP-S	1		X							4-wire sensor	12.5 mm
2619390000	ACT20P-CI-2CO-DLP-P	1		X							4-wire sensor	12.5 mm
Temperature transducer												
2448100000	ACT20P-PRO-RTCI-AO-D0-S	1					X	X			RTD, Thermocouple, Pot, mV, resistance	12.5 mm
2448110000	ACT20P-PRO-RTCI-AO-D0-P	1					X	X			RTD, Thermocouple, Pot, mV, resistance	12.5 mm
2489890000	ACT20P-PRO-RTC-AO-D0S-S	1					X	X			RTD, Thermocouple, Pot, mV, resistance	12.5 mm
2490030000	ACT20P-PRO-RTC-AO-D0S-P	1					X	X			RTD, Thermocouple, Pot, mV, resistance	12.5 mm
7760054233	ACT20P-RTI-AO-S	1						X			PT100 (3 Conductor), Cu50, Cu100	12.5 mm
7760054183	ACT20P-RTI-AO-P	1						X			PT100 (3 Conductor), Cu50, Cu100	12.5 mm
7760054236	ACT20P-RTI-2AO-S	1						X			PT100 (3 Conductor), Cu50, Cu100	12.5 mm
7760054187	ACT20P-RTI-2AO-P	1						X			PT100 (3 Conductor), Cu50, Cu100	12.5 mm
7760054234	ACT20P-TCI-AO-S	1					X				Thermocouple type T,E,J,K,N,R,S,B	12.5 mm
7760054184	ACT20P-TCI-AO-P	1					X				Thermocouple type T,E,J,K,N,R,S,B	12.5 mm
7760054237	ACT20P-TCI-2AO-S	1					X				Thermocouple type T,E,J,K,N,R,S,B	12.5 mm
7760054188	ACT20P-TCI-2AO-P	1					X				Thermocouple type T,E,J,K,N,R,S,B	12.5 mm

Number outputs	Output						Configuration	Auxiliary power	Rated insulation voltage	Isolation	Rail bus	Ex approval	Shipbuilding approval	Special characteristics
	0...20 mA	4...20 mA	0...10 V	Switching signal	Limit value, digital	Status, digital								
1	X	X					-	24 V DC	300 V	3-way		X		
1	X	X					-	24 V DC	300 V	3-way		X		
1	X	X					-	24 V DC	300 V	3-way	X	X		
1	X	X					-	24 V DC	300 V	3-way	X	X		
1			X				-	24 V DC	300 V	3-way		X		
1			X				-	24 V DC	300 V	3-way	X	X		
1	X	X	X				-	24 V DC	300 V	3-way	X	X		
2	X	X					-	24 V DC	300 V	4-way		X	Splitter	
2	X	X					-	24 V DC	300 V	4-way		X	Splitter	
2	X	X					-	24 V DC	300 V	4-way	X	X	Splitter	
2	X	X					-	24 V DC	300 V	4-way	X	X	Splitter	
2	X	X					-	24 V DC	300 V	3-way		X		
2	X	X					-	24 V DC	300 V	3-way		X		
2	X	X					-	24 V DC	300 V	3-way	X	X		
2	X	X					-	24 V DC	300 V	3-way	X	X		
1	X	X	X				DIP switch, button LED	12...60 V DC	300 V	3-way				
1	X	X	X				DIP switch, button LED	12...60 V DC	300 V	3-way				
1	X	X	X				DIP switch, button LED	90...264 V AC	300 V	3-way				
1	X	X	X				DIP switch, button LED	90...264 V AC	300 V	3-way				
1	X	X					-	input loop	300 V	2-way		X		
1	X	X					-	input loop	300 V	2-way		X		
2	X	X					-	input loop	300 V	2-way		X		
2	X	X					-	input loop	300 V	2-way		X		
1		X					-	output loop	300 V	2-way		X		
1		X					-	output loop	300 V	2-way		X		
1		X					-	output loop	300 V	2-way		X		
1		X					-	output loop	300 V	2-way		X		
1		X					-	output loop	300 V	2-way		X		
1		X					-	output loop	300 V	2-way		X		
1		X					-	output loop	300 V	2-way		X		
1		X					-	output loop	300 V	2-way		X		
2	X	X					-	output loop	300 V	3-way		X	Splitter	
2	X	X					-	output loop	300 V	3-way		X	Splitter	
1	X	X	X	X		1 x NPN	Display, button	24...240 V UC	300 V	4-way		*)	X	
1	X	X	X	X		1 x NPN	Display, button	24...240 V UC	300 V	4-way		*)	X	
1	X	X	X	X		1 x NPN	Display, button	24...240 V UC	300 V	4-way		*)	X with SIL function *)	
1	X	X	X	X		1 x NPN	Display, button	24...240 V UC	300 V	4-way		*)	X with SIL function *)	
1	X	X					Software	24 V DC	300 V	3-way				
1	X	X					Software	24 V DC	300 V	3-way				
2	X	X					Software	24 V DC	300 V	4-way			Splitter	
2	X	X					Software	24 V DC	300 V	4-way			Splitter	
1	X	X					Software	24 V DC	300 V	3-way				
1	X	X					Software	24 V DC	300 V	3-way				
2	X	X					Software	24 V DC	300 V	4-way			Splitter	
2	X	X					Software	24 V DC	300 V	4-way			Splitter	

Connection system: S = screw / Z = tension clamp / P = Push In, ILP = Input Loop Powered, OLP = Output Loop Powered, *) = in preparation

Selection table

Selection table

Order No.	Product	Input								Miscellaneous	sensor feed	Width
		Number of channels	0...20 mA	4...20 mA	0...10 V	0...5 V	TC	RTD	Frequency			
Limit switch												
7760054305	ACT20P-TMR-RTI-S	1						X		PT100		22.5 mm
7760054352	ACT20P-TMR-RTI-P	1						X		PT100		22.5 mm
7940045760	ACT20P-UI-2RCO-DC-S	1	X	X	X	X	X	X		± 25 mA, ± 5 A DC, ± 30 V DC, ± 300 V DC, potentiometer, resistance	X	22.5 mm
2456840000	ACT20P-UI-2RCO-DC-P	1	X	X	X	X	X	X		± 25 mA, ± 5 A DC, ± 30 V DC, ± 300 V DC, potentiometer, resistance	X	22.5 mm
1238910000	ACT20P-UI-2RCO-AC-S	1	X	X	X	X	X	X		± 25 mA, ± 5 A DC, ± 30 V DC, ± 300 V DC, potentiometer, resistance	X	22.5 mm
2495690000	ACT20P-UI-2RCO-AC-P	1	X	X	X	X	X	X		± 25 mA, ± 5 A DC, ± 30 V DC, ± 300 V DC, potentiometer, resistance	X	22.5 mm
7760054164	ACT20P-VMR-1PH-H-S	1								1 phase 0...400 V AC/DC		22.5 mm
7760054359	ACT20P-VMR-1PH-H-P	1								1 phase 0...400 V AC/DC		22.5 mm
7760054165	ACT20P-VMR-3PH-I-LP-H-S	1								3 phases 180...500 V AC		22.5 mm
7760054361	ACT20P-VMR-3PH-I-LP-H-P	1								3 phase 180...500 V AC		22.5 mm
Current and voltage transformers												
2044850000	ACT20P-CML-10-AO-RC-S	1								0...1/5/10 A AC/DC		17.5 mm
2489910000	ACT20P-CML-10-AO-RC-P	1								0...1/5/10 A AC/DC		17.5 mm
1510470000	ACT20P-CMT-10-AO-RC-S	1								0...5/10 A AC/DC		22.5 mm
1510330000	ACT20P-CMT-10-AO-RC-P	1								0...5/10 A AC/DC		22.5 mm
1510540000	ACT20P-CMT-30-AO-RC-S	1								0...20/25/30 A AC/DC		22.5 mm
1510320000	ACT20P-CMT-30-AO-RC-P	1								0...20/25/30 A AC/DC		22.5 mm
1510440000	ACT20P-CMT-60-AO-RC-S	1								0...40/50/60 A AC/DC		22.5 mm
1510290000	ACT20P-CMT-60-AO-RC-P	1								0...40/50/60 A AC/DC		22.5 mm
1510390000	ACT20P-CMT-60-RC-S	1								0...40/50/60 A AC/DC		22.5 mm
1510280000	ACT20P-CMT-60-RC-P	1								0...40/50/60 A AC/DC		22.5 mm
7760054306	ACT20P-VM-AO-S	1								0...440 V AC, 0...660 V DC		22.5 mm
7760054360	ACT20P-VM-AO-P	1								0...440 V AC, 0...660 V DC		22.5 mm
Bridge measuring transducers												
1067250000	ACT20P-BRIDGE-S	1								4-, 6-wire strain gauge	X	22.5 mm
2456820000	ACT20P-BRIDGE-P	1								4-, 6-wire strain gauge	X	22.5 mm
Universal transducers												
1481970000	ACT20P-PRO DCDC II-S	1	X	X	X	X				± 100 mA, ± 300 V DC	X	12.5 mm
1481960000	ACT20P-PRO DCDC II-P	1	X	X	X	X				± 100 mA, ± 300 V DC	X	12.5 mm
2816690000	ACT20P-PRO DCDC II-24-S	1	X	X	X	X				± 100 mA, ± 300 V DC	X	12.5 mm
2816700000	ACT20P-PRO DCDC II-24-P	1	X	X	X	X				± 100 mA, ± 300 V DC	X	12.5 mm
1453210000	ACT20P-UI-AO-DO-LP-S	1	X	X	X	X	X	X		DC: ± 25 mA, ± 5 A, ± 60 mV, ± 28 V, ± 300 V, AC: 1V, 300 V		12.5 mm
2456850000	ACT20P-UI-AO-DO-LP-P	1	X	X	X	X	X	X		DC: ± 25 mA, ± 5 A, ± 60 mV, ± 28 V, ± 300 V, AC: 1V, 300 V		12.5 mm
Frequency transducers												
2447940000	ACT20P-PRO-FI-AO-DO-S	1						X		Namur, Switch, tachometer, TTL, NPN/PNP, PWM	X	12.5 mm
2447950000	ACT20P-PRO-FI-AO-DO-P	1						X		Namur, Switch, tachometer, TTL, NPN/PNP, PWM	X	12.5 mm
2490010000	ACT20P-PRO-FI-AO-DOS-S	1						X		Namur, Switch, tachometer, TTL, NPN/PNP, PWM	X	12.5 mm
2490020000	ACT20P-PRO-FI-AO-DOS-P	1						X		Namur, Switch, tachometer, TTL, NPN/PNP, PWM	X	12.5 mm

Number outputs	Output						Configuration	Auxiliary power	Rated insulation voltage	Isolation			Special characteristics
	0...20 mA	4...20 mA	0...10 V	Switching signal	Limit value, digital	Status, digital				Miscellaneous	Rail bus	Ex approval	
2					X	2 x CO	Software, Display	20...264 V UC	300 V	3-way		X	
2					X	2 x CO	Software, Display	20...264 V UC	300 V	3-way		X	
1					X	2 x CO	Software	9...60 V DC	300 V	4-way			
1					X	2 x CO	Software	9...60 V DC	300 V	4-way			
1					X	2 x CO	Software	90...264 V AC	300 V	4-way			
1					X	2 x CO	Software	90...264 V AC	300 V	4-way			
2					X	2 x CO	DIP switch, Pot.	20...240 V UC	300 V	3-way			
2					X	2 x CO	DIP switch, Pot.	20...240 V UC	300 V	3-way			
2					X	2 x CO	DIP switch, Pot.	input loop	600 V	3-way			
2					X	2 x CO	DIP switch, Pot.	input loop	600 V	3-way			
1	X	X	X		X	± 10 V, ± 20 mA, 1 x CO	DIP switch, potentiometer	24 V DC	300 V	4-way		X	Current carrying conductor at the terminals
1	X	X	X		X	± 10 V, ± 20 mA, 1 x CO	DIP switch, potentiometer	24 V DC	300 V	4-way		X	Current carrying conductor at the terminals
1	X	X	X		X	± 10 V, ± 20 mA, 1 x CO	DIP switch, potentiometer	24 V DC	300 V	4-way		X	Through hole current converter
1	X	X	X		X	± 10 V, ± 20 mA, 1 x CO	DIP switch, potentiometer	24 V DC	300 V	4-way		X	Through hole current converter
1	X	X	X		X	± 10 V, ± 20 mA, 1 x CO	DIP switch, potentiometer	24 V DC	300 V	4-way		X	Through hole current converter
1	X	X	X		X	± 10 V, ± 20 mA, 1 x CO	DIP switch, potentiometer	24 V DC	300 V	4-way		X	Through hole current converter
1	X	X	X		X	± 10 V, ± 20 mA, 1 x CO	DIP switch, potentiometer	24 V DC	300 V	4-way		X	Through hole current converter
1					X	1 x CO	DIP switch, potentiometer	24 V DC	300 V	3-way		X	Through hole current converter
1					X	1 x CO	DIP switch, potentiometer	24 V DC	300 V	3-way		X	Through hole current converter
1	X	X	X				Software	24 V - 230 V AC/DC	600 V	3-way			
1	X	X	X				Software	24 V - 230 V AC/DC	600 V	3-way			
1	X	X	X			Reset button (TARE)	DIP switch, button	10...60 V DC	300 V	3-way			
1	X	X	X			Reset button (TARE)	DIP switch, button	10...60 V DC	300 V	3-way			
1	X	X	X			± 10 V, ± 20 mA	Display, DIP switch, button	24 V - 230 V AC/DC	600 V	3-way		X	active or passive output
1	X	X	X			± 10 V, ± 20 mA	Display, DIP switch, button	24 V - 230 V AC/DC	600 V	3-way		X	active or passive output
1	X	X	X			± 10 V, ± 20 mA	Display, DIP switch, button	24 V DC	600 V	3-way		X	active or passive output
1	X	X	X			± 10 V, ± 20 mA	Display, DIP switch, button	24 V DC	600 V	3-way		X	active or passive output
1		X			X	1 x NPN	Software	output loop	300 V	3-way			
1		X			X	1 x NPN	Software	output loop	300 V	3-way			
1	X	X	X		X	1 x NPN	Display, button	24...240 V UC	300 V	4-way		*	X
1	X	X	X		X	1 x NPN	Display, button	24...240 V UC	300 V	4-way		*)	X
1	X	X	X		X	1 x NPN	Display, button	24...240 V UC	300 V	4-way		*)	X with SIL function *)
1	X	X	X		X	1 x NPN	Display, button	24...240 V UC	300 V	4-way		*)	X with SIL function *)

Connection system: S = screw / Z = tension clamp / P = Push In, ILP = Input Loop Powered, OLP = Output Loop Powered, *) = in preparation

ACT20P

C



Reliable connection

Individually configurable protection against mismatching with release lever



Simple signal conditioning

Devices configured for converting standard sensor signals to standard DC signals.

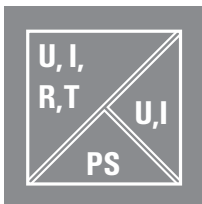

High level of galvanic isolation

The galvanic isolation of 2 kV (300 V rated voltage) ensures high process reliability

Supply isolator

- Isolation of DC- signals
- Passive transmitter or active current input
- 3-way isolation
- HART® - transparent

ACT20P-CI-CO

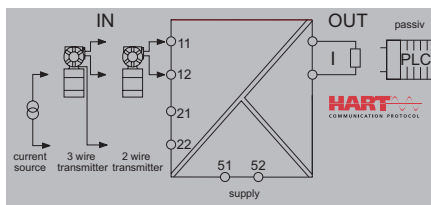

Technical data

Input
Input signal
Input current
Voltage drop
Sensor supply

current source, HART® signal bidirectional
0...20 mA, 4...20mA
≤ 1 V
> 17 V DC at 20 mA

Output
Output current
Load impedance current

0...20 mA (if input: 0...20 mA), 4...20 mA (if input: 4...20 mA), HART® digital signal
≤ 550 Ω

General data
Configuration
Voltage supply
Accuracy
Step response time
Current consumption
Temperature coefficient

none
20...30 V DC
<0.1 % of end value
≤ 0,5 ms
≤60 mA (24V power supply, 20mA output)
80 ppm/K

Insulation coordination
EMC standards
Insulation voltage
Test voltage
Impulse withstand voltage
Pollution degree
Overvoltage category

EN 61326-1, EN 61000-6-2, EN 61000-6-4
2 kV inputs / outputs / power supply
0.3 kV
4 kV (1.2/50 μs)
2
III

Dimensions	
Clamping range (nominal / min. / max.)	mm ²
Depth x width x height	mm

Screw connection	PUSH IN
2.5 / 0.5 / 2.5	2.5 / 0.5 / 2.5
113.7 / 12.5 / 117.2	113.7 / 12.5 / 127.1

Note

Ordering data

Connection type
Screw connection without mounting rail bus supply
PUSH IN connection without mounting rail bus supply
Screw connection with mounting rail bus supply
PUSH IN connection with mounting rail bus supply

Type	Qty.	Order No.
ACT20P-CI-CO-S	1	7760054114
ACT20P-CI-CO-P	1	2489680000
ACT20P-CI-CO-P-S	1	1506200000
ACT20P-CI-CO-P-P	1	2514620000

Note

Supply isolator

Signal converters Supply isolator with voltage output

- Passive 3-wire transmitter and active current input
- 3-way isolation
- Removable terminals
- Supply also possible via mounting rail bus

ACT20P-CI-V0

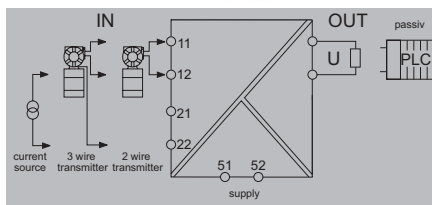

Technical data

Input	
Input current	0...20 mA, 4...20mA
Input signal	2-/3-wire transmitter, Current source
Number of inputs	1
Sensor supply	> 17 V DC at 20 mA
Output	
Number of outputs	1
Output voltage	0...10 V (if input: 0...20 mA), 2...10 V (if input: 4...20 mA)
load impedance voltage	≥ 600 kΩ
General data	
Accuracy	±0,1 % FSR max., 0,05 % FSR typ.
Configuration	none
Current consumption	≤60 mA (24V power supply, 20mA output)
Step response time	≤ 0,5 ms
Temperature coefficient	80 ppm/K
Voltage supply	20...30 V DC
Insulation coordination	
EMC standards	EN 61326-1, EN 61000-6-2, EN 61000-6-4
Galvanic isolation	3-way isolator, between input/output/supply
Impulse withstand voltage	4 kV (1.2/50 μs)
Insulation voltage	2 kV (Input/Output), 1 min, 50 Hz
Test voltage	0.3 kV
Overvoltage category	III
Standards	EN 61010-1, UL 61010-1
Pollution degree	2

Input current	0...20 mA, 4...20mA
Input signal	2-/3-wire transmitter, Current source
Number of inputs	1
Sensor supply	> 17 V DC at 20 mA
Number of outputs	1
Output voltage	0...10 V (if input: 0...20 mA), 2...10 V (if input: 4...20 mA)
load impedance voltage	≥ 600 kΩ
Accuracy	±0,1 % FSR max., 0,05 % FSR typ.
Configuration	none
Current consumption	≤60 mA (24V power supply, 20mA output)
Step response time	≤ 0,5 ms
Temperature coefficient	80 ppm/K
Voltage supply	20...30 V DC
EMC standards	EN 61326-1, EN 61000-6-2, EN 61000-6-4
Galvanic isolation	3-way isolator, between input/output/supply
Impulse withstand voltage	4 kV (1.2/50 μs)
Insulation voltage	2 kV (Input/Output), 1 min, 50 Hz
Test voltage	0.3 kV
Overvoltage category	III
Standards	EN 61010-1, UL 61010-1
Pollution degree	2

Dimensions	
Clamping range (nominal / min. / max.)	mm ²
Depth / Width / Height	mm
Note	

Screw connection	PUSH IN
0.6 / 0.5 / 2.5	2.5 / 0.5 / 2.5
113.7 / 12.5 / 117.2	113.7 / 12.5 / 127.1

Ordering data

Connection type	
Screw connection without mounting rail bus supply	
PUSH IN connection without mounting rail bus supply	
Screw connection with mounting rail bus supply	
PUSH IN connection with mounting rail bus supply	

Type	Qty.	Order No.
ACT20P-CI-V0-S	1	1540010000
ACT20P-CI-V0-P	1	2489740000
ACT20P-CI-V0-P-S	1	1537750000
ACT20P-CI-V0-P-P	1	2514640000

Note

Note

Supply isolator with splitter function

- Removable terminals
- Passive transmitter or active current input
- 3-way isolation
- HART® - transparent

ACT20P-CI-2CO

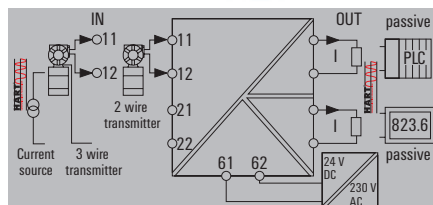

Technical data

Input	
Sensor supply	> 17 V DC at 20 mA
Input signal	HART® signal bidirectional
Input current	0...20 mA, 4...20mA
Voltage drop	ca. 3.8 V @ $R_{L,load} = 0 \Omega$; ca. 15 V @ $R_{L,load} = 600 \Omega$; ($I_{input} = 20 \text{ mA}$)
Output	
Output current	0...20 mA (if input: 0...20 mA), 4...20 mA (if input: 4...20 mA), HART® digital signal
Load impedance current	<300 Ω
General data	
Configuration	none
Voltage supply	20...30 V DC
Accuracy	<0.1 % of end value
Step response time	≤ 0,5 ms
Temperature coefficient	80 ppm/K
Insulation coordination	
EMC standards	EN 61326-1, EN 61000-6-2, EN 61000-6-4
Insulation voltage	2 kV inputs / outputs / power supply
Test voltage	0.3 kV
Impulse withstand voltage	4 kV (1.2/50 μs)
Pollution degree	2
Overvoltage category	III

Dimensions

Clamping range (nominal / min. / max.)	mm ²
Depth x width x height	mm

Note

Screw connection PUSH IN

2.5 / 0.5 / 2.5	2.5 / 0.5 / 2.5
113.7 / 12.5 / 117.2	113.7 / 12.5 / 127.1

Ordering data

Connection type	Type	Qty.	Order No.
Screw connection without mounting rail bus supply	ACT20P-CI-2CO-S	1	7760054115
PUSH IN connection without mounting rail bus supply	ACT20P-CI-2CO-P	1	2489710000
Screw connection with mounting rail bus supply	ACT20P-CI-2CO-P-S	1	1506220000
PUSH IN connection with mounting rail bus supply	ACT20P-CI-2CO-P-P	1	2514630000

Note

Isolation amplifier

Isolation amplifier

- Passive input
- 2 channels in one module
- 3-way isolation
- Supply also possible via mounting rail bus

ACT20P-2CI-2CO-12

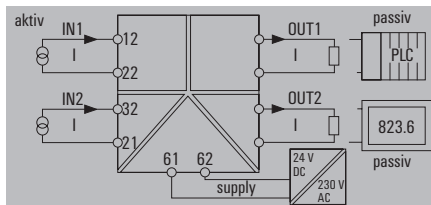

Technical data

Input

Input current
Voltage drop

Output

Output current

Load impedance current

General data

Configuration
Voltage supply
Accuracy
Step response time
Temperature coefficient

Insulation coordination

EMC standards
Insulation voltage
Test voltage
Impulse withstand voltage
Pollution degree
Overvoltage category

0...20 mA, 4...20mA

≤ 1 V

0...20 mA (if input: 0...20 mA), 4...20 mA (if input: 4...20 mA), HART® digital signal

<300 Ω, per channel

none

20...30 V DC

<0.1 % of end value

≤ 0,5 ms

80 ppm/K

EN 61010-1:2011, UL 61010-1, EN 61326-1

2 kV inputs / outputs / power supply

0.3 kV

4 kV (1.2/50 μs)

2

III

Dimensions

Clamping range (nominal / min. / max.) mm²
Depth x width x height mm

Note

Screw connection

2.5 / 0.5 / 2.5 2.5 / 0.5 / 2.5
113.7 / 12.5 / 117.2 113.7 / 12.5 / 127.1

PUSH IN

Ordering data

Connection type

Screw connection without mounting rail bus supply
PUSH IN connection without mounting rail bus supply
PUSH IN connection with mounting rail bus supply

Type

Type	Qty.	Order No.
ACT20P-2CI-2CO-12-S	1	7760054117
ACT20P-2CI-2CO-12-P	1	2489730000
ACT20P-2CI-2CO-12-P-P	1	2514650000

Note

Standard transducer with sensor supply

- Isolation and conversion of DC signals
- 24 V - sensor supply
- Configuration via DIP switch/button
- Supply 12-60 V DC
- 3-way isolation

ACT20P-AI-A0-DC

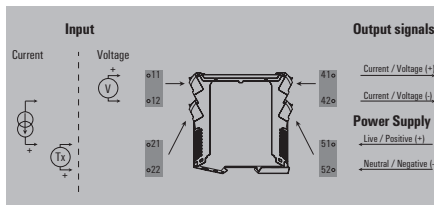

Technical data

Input	
Input voltage	configurable, 0-11 V (min. measurement range 2 V)
Input current	configurable, 0-22 mA (min. measurement range 4 mA)
Input resistance, current	100 Ω
Input resistance, voltage	≥ 1 MΩ
Sensor supply	24 V DC
Output	
Output voltage	Adjustable, 0...11 V, Output range, min, 2 V
Output current	Adjustable, 0...22 mA, Output range, min, 4 mA
load impedance voltage	> 600 Ω @ 10 V
Load impedance current	1 kΩ @ 20 mA
Offset voltage	≤ 20 mV
General data	
Galvanic isolation	3-way isolator, between input/output/supply
Linearity	≤ ± 0.1 % of signal range, Typ. ± 0.05 % of signal range
Temperature coefficient	< 0.05 % / °C
Configuration	DIP switch, Keys and LED display, with reference voltage/current sources
Step response time	350 ms
Voltage supply	12...60 V DC
Insulation coordination	
Standards	IEC 61326-1:2012, UL 61010-1:2012, 3rd Edition
EMC standards	EN 61326-1
Insulation voltage	2 kV inputs / outputs
Impulse withstand voltage	4 kV (1.2/50 μs)
Overvoltage category	III

Dimensions	
Clamping range (nominal / min. / max.)	mm ²
Depth / Height / Width	
Note	
Screw connection	
1.5 / 0.5 / 2.5	
113.7 / 119.2 / 12.5 mm	
PUSH IN	
2.5 / 0.5 / 2.5	
113.7 / 127.1 / 12.5 mm	
Ordering data	
DC supply voltage	
Screw connection	ACT20P-AI-A0-DC-S
PUSH IN connection	ACT20P-AI-A0-DC-P
AC supply voltage	
Screw connection	ACT20P-AI-A0-AC-S
PUSH IN connection	ACT20P-AI-A0-AC-P
Note	

Dimensions	
Clamping range (nominal / min. / max.)	mm ²
Depth / Height / Width	
Note	

Screw connection		PUSH IN	
1.5 / 0.5 / 2.5		2.5 / 0.5 / 2.5	
113.7 / 119.2 / 12.5 mm		113.7 / 127.1 / 12.5 mm	
Ordering data		Type	
DC supply voltage		Qty.	Order No.
Screw connection	ACT20P-AI-A0-DC-S	1	1477420000
PUSH IN connection	ACT20P-AI-A0-DC-P	1	2456860000
AC supply voltage			
Screw connection	ACT20P-AI-A0-AC-S	1	1545720000
PUSH IN connection	ACT20P-AI-A0-AC-P	1	2495700000
Note			

Ordering data

DC supply voltage	
Screw connection	ACT20P-AI-A0-DC-S
PUSH IN connection	ACT20P-AI-A0-DC-P
AC supply voltage	
Screw connection	ACT20P-AI-A0-AC-S
PUSH IN connection	ACT20P-AI-A0-AC-P
Note	

DC supply voltage		Type	
Qty.	Order No.		
1	1477420000	ACT20P-AI-A0-DC-S	
1	2456860000	ACT20P-AI-A0-DC-P	
AC supply voltage			
1	1545720000	ACT20P-AI-A0-AC-S	
1	2495700000	ACT20P-AI-A0-AC-P	
Note			

Note	
-------------	--

Passive isolators

Passive isolators, input loop powered

- Power supply via the input circuit (input loop powered)
- 1 or 2 channels in one module
- 2-way isolation

ACT20P-CI-CO-ILP

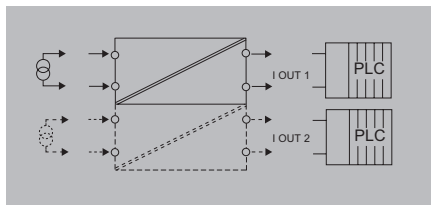

Technical data

Input	
Input current	0(4)...20 mA current loop
Voltage drop, current input	3.8 V
Sensor	4-wire sensor (with own power supply), Current source
Number of inputs	1
Output	
Load impedance current	≤ 600 Ω
Output current	0...20 mA (if input: 0...20 mA), 4...20 mA (if input: 4...20 mA)
Number of outputs	1
General data	
Accuracy	<0.1 % of end value
Temperature coefficient	≤ 100 ppm/K
Voltage supply	Loop powered, via 4...20 mA input
Insulation coordination	
EMC standards	EN 61326-1, EN 61000-6-2, EN 61000-6-4
Galvanic isolation	2-way isolator
Impulse withstand voltage	3 kV (1.2/50µs)
Insulation voltage	2.5 kV (input / output)
Rated voltage	300 V
Overvoltage category	III
Pollution degree	2

Dimensions	
Clamping range (nominal / min. / max.)	mm ²
Depth / Width / Height	mm
Note	

Screw connection	PUSH IN
2.5 / 0.5 / 2.5	2.5 / 0.5 / 2.5
114 / 12.5 / 117.2	114 / 12.5 / 127.1

Ordering data

Channel	
	Screw connection, 1 channel
	PUSH IN connection, 1 channel
	Screw connection, 2 channel
	PUSH IN connection, 2 channel

Type	Qty.	Order No.
ACT20P-CI-CO-ILP-S	1	7760054123
ACT20P-CI-CO-ILP-P	1	7760054357
ACT20P-2CI-2CO-ILP-S	1	7760054124
ACT20P-2CI-2CO-ILP-P	1	7760054358

Note

Note

Passive isolators, output loop powered

- Removable terminals
- Power supply via the output circuit (output loop powered)
- 2-way isolation

ACT20P-CI-CO-OLP

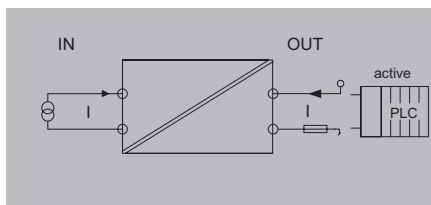

Technical data

Input	
Sensor	
Number of inputs	
Input current	
Output	
Load impedance current	
Output current	
Number of outputs	
General data	
Accuracy	
Configuration	
Step response time	
Temperature coefficient	
Voltage supply	
Insulation coordination	
EMC standards	
Galvanic isolation	
Impulse withstand voltage	
Insulation voltage	
Rated voltage	
Overvoltage category	
Pollution degree	

Current source, 4-wire sensor (with own power supply)	
	1
7760054118:	0...20 mA;
7760054353:	0...20 mA;
7760054119:	4...20mA;
7760054354:	4...20 mA
	≤ 600 Ω
	4...20 mA, loop-powered
	1
	<0.1 % of end value
	none
	≤ 1 ms
	≤ 100 ppm/K
	via output current loop, min. 12 V DC/ max. 30 V DC
EN 61326-1, EN 61000-6-2, EN 61000-6-4	
	2-way isolator
	4 kV (1.2/50 μs)
	2 kV inputs / outputs
	300 V
	III
	2

Dimensions	
Clamping range (nominal / min. / max.)	mm ²
Depth / Width / Height	mm
Note	

Screw connection	PUSH IN
2.5 / 0.5 / 2.5	2.5 / 0.5 / 2.5
114 / 12.5 / 117.2	114 / 12.5 / 127.1

Ordering data

Input current	
	Screw connection, 0...20 mA
	Screw connection, 4...20 mA
	PUSH IN connection, 0...20 mA
	PUSH IN connection, 4...20 mA

Type	Qty.	Order No.
ACT20P-CI1-CO-OLP-S	1	7760054118
ACT20P-CI2-CO-OLP-S	1	7760054119
ACT20P-CI1-CO-OLP-P	1	7760054353
ACT20P-CI2-CO-OLP-P	1	7760054354

Note

--

Passive isolators

Passive isolator with voltage input, output loop powered

- Removable terminals
- Power supply via the output circuit (output loop powered)
- 2-way isolation

ACT20P-VI-CO-OLP

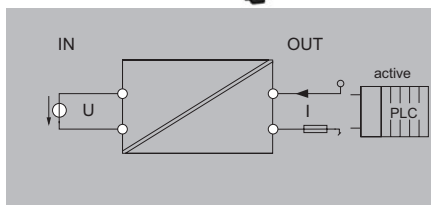

Technical data

Input	
Sensor	
Input voltage	
Output	
Output current	
General data	
Configuration	
Accuracy	
Voltage supply	
Power consumption, typ.	
Galvanic isolation	
Step response time	
Ambient temperature (operational)	
Insulation coordination	
Insulation voltage	
Rated voltage	
EMC standards	
Pollution degree	
Overvoltage category	
Approvals	
Approvals	

Voltage source	0...10 V
Output current	4...20 mA, loop-powered
Configuration	none
Accuracy	<0.2 % of end value
Voltage supply	via output current loop, min. 12 V DC/ max. 30 V DC
Power consumption, typ.	2 W
Galvanic isolation	2-way isolator
Step response time	≤ 1 ms
Ambient temperature (operational)	-20 °C...60 °C
Insulation voltage	2 kV inputs / outputs
Rated voltage	300 V
EMC standards	EN 61326-1, EN 61000-6-2, EN 61000-6-4
Pollution degree	2
Overvoltage category	III
Approvals	CE; cULus; cURusEX; DEMKOATEX; IECExULD; UKEX

Dimensions	
Clamping range (nominal / min. / max.)	mm ²
Depth / Width / Height	mm
Note	

	PUSH IN	Screw connection
	2.5 / 0.5 / 2.5	2.5 / 0.5 / 2.5
	114 / 12.5 / 127.1	114 / 12.5 / 117.2

Ordering data

Input voltage	
	Screw connection, 0...10 V
	Screw connection, 0...5 V
	PUSH IN connection, 0...10 V
	PUSH IN connection, 0...5 V

Type	Qty.	Order No.
ACT20P-VI-CO-OLP-S	1	7760054121
ACT20P-VI1-CO-OLP-S	1	7760054120
ACT20P-VI-CO-OLP-P	1	7760054356
ACT20P-VI1-CO-OLP-P	1	7760054355

Note	
-------------	--

Note	
-------------	--

Passive isolators, output loop powered with splitter function

- Removable terminals
- Doubling of the signal
- Power supply via the output circuit (output loop powered)
- 3-way isolation

ACT20P-CI-2CO-OLP

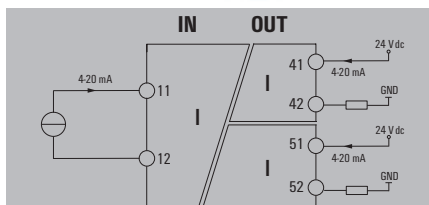

Technical data

Input	
Number of inputs	1
Input current	4...20mA
Sensor	Current source, 4- wire sensor (with own power supply)
Output	
Number of outputs	2
Output current	4...20 mA, loop-powered
Load impedance current	$R_L = (U_S - 12 \text{ V}) / 20 \pm 20 \text{ mA}$, e.g. 600 Ω at 24 V
General data	
Configuration	none
Galvanic isolation	3-way isolator
Accuracy	<0.1 % of end value
Temperature coefficient	$\leq 100 \text{ ppm/K}$
Voltage supply	via output current loop, min. 12 V DC/ max. 30 V DC
Insulation coordination	
EMC standards	EN 61326-1, EN 61000-6-2, EN 61000-6-4
Insulation voltage	2 kV (Input /Output), 1 min, 50 Hz
Rated voltage	300 V
Impulse withstand voltage	4 kV (1.2/50 μs)
Pollution degree	2
Overvoltage category	III

Dimensions	
Clamping range (nominal / min. / max.)	mm ²
Depth / Width / Height	mm
Note	

Dimensions	
Clamping range (nominal / min. / max.)	mm ²
Depth / Width / Height	mm
Note	

Screw connection	PUSH IN
2.5 / 0.5 / 2.5	2.5 / 0.5 / 2.5
114 / 12.5 / 117.2	114 / 12.5 / 127.1

Ordering data

Input current	
	Screw connection, 4...20 mA
	PUSH IN connection, 4...20 mA

Type	Qty.	Order No.
ACT20P-CI-2CO-OLP-S	1	7760054122
ACT20P-CI-2CO-OLP-P	1	2619390000

Note

Note

Temperature transducer

Temperature transducer

- For thermocouples
- Configurable with software
- Adjustable temperature range
- Splitting of the signal

ACT20P-TCI-A0

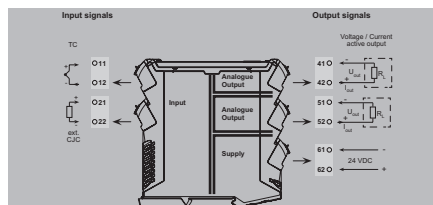

Technical data

Input

Number of inputs
Sensor
Temperature input range

Output

Number of outputs
Output current
Load impedance current

General data

Accuracy
Configuration

Step response time
Temperature coefficient
Voltage supply
Ambient temperature (operational)
Humidity

Insulation coordination

EMC standards
Impulse withstand voltage
Galvanic isolation
Insulation voltage
Rated voltage
Overvoltage category

Number of inputs	1
Sensor	Thermocouple Type T,E,J,K,N,R,S,B
Temperature input range	Configurable, T: (-200...+400 °C), E: (-100...+1000 °C), J: (-100...+1200 °C), K: (-180...+1372 °C), N: (-180...+1300 °C), R: (-50...+1760 °C), S: (-50...+1760 °C), B: +100...+1820 °C, min. measurement range 50°C (TC)
Number of outputs	1
Output current	0(4)...20 mA
Load impedance current	≤ 550 Ω
Accuracy	0.5°C / 0.1% of end value
Configuration	With free software ACT20P TOOL PACK, Requires configuration adapter 8978580000 CBX200 USB, + 2907490000 ADAPTER CBX200 - MINI USB
Step response time	≤ 1s
Temperature coefficient	≤ 100 ppm/K
Voltage supply	24 V DC ± 20 %
Ambient temperature (operational)	-20 °C...60 °C
Humidity	5...95 %, no condensation
EMC standards	EN 61326-1
Impulse withstand voltage	4 kV (1.2/50 μs)
Galvanic isolation	between input/output/supply
Insulation voltage	2 kV inputs / outputs / power supply
Rated voltage	300 V
Overvoltage category	III

Dimensions

Clamping range (nominal / min. / max.) mm²
Depth / Width / Height mm

Note

Screw connection	PUSH IN
2.5 / 0.5 / 2.5	2.5 / 0.5 / 2.5
114 / 12.5 / 117	

Ordering data

Connection type

Screw connection, 1 x output
PUSH IN connection, 1 x output
Screw connection, 2 x output
PUSH IN connection, 2 x output

Type	Qty.	Order No.
ACT20P-TCI-A0-S	1	7760054234
ACT20P-TCI-A0-P	1	7760054184
ACT20P-TCI-2A0-S	1	7760054237
ACT20P-TCI-2A0-P	1	7760054188

Note

CBX200 USB configuration interface adapter - 8978580000 + ADAPTER CBX200 - MINI USB 2907490000

Temperature transducer

- For PT100 resistance sensors
- Configurable with software
- Adjustable temperature range
- Splitting of the signal

ACT20P-RTI-AO

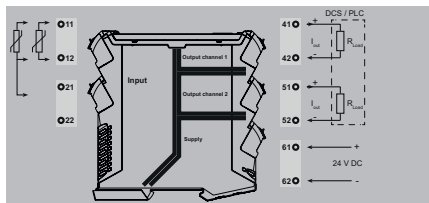

Technical data

Input	
Number of inputs	1
Sensor	PT100 (3 wire), Cu50, Cu100
Temperature input range	Configurable, PT100: -200...+850 °C, min. measurement range 10°C (RTD)
Output	
Number of outputs	1
Output current	Adjustable, 0(4)...20 mA
General data	
Accuracy	0.2 °C/0.1% of end value
Configuration	With free software ACT20P TOOL PACK, Requires configuration adapter 8978580000 CBX200 USB, + 2907490000 ADAPTER CBX200 - MINI USB
Step response time	≤1s
Temperature coefficient	≤ 100 ppm/K
Voltage supply	24 V DC ± 20 %
Ambient temperature (operational)	-20 °C...60 °C
Humidity	5...95 %, no condensation
Insulation coordination	
EMC standards	EN 61326-1
Impulse withstand voltage	4 kV (1.2/50 µs)
Galvanic isolation	between input / output / supply
Insulation voltage	2 kV inputs / outputs / power supply
Rated voltage	300 V
Overvoltage category	III

Dimensions	
Clamping range (nominal / min. / max.)	mm ²
Depth / Width / Height	mm
Note	

Screw connection	PUSH IN
2.5 / 0.5 / 2.5	2.5 / 0.5 / 2.5
114 / 12.5 / 117	114 / 12.5 / 117

Ordering data

Connection type	
Screw connection, 1 x output	
PUSH IN connection, 1 x output	
Screw connection, 2 x output	
PUSH IN connection, 2 x output	

Type	Qty.	Order No.
ACT20P-RTI-AO-S	1	7760054233
ACT20P-RTI-AO-P	1	7760054183
ACT20P-RTI-2AO-S	1	7760054236
ACT20P-RTI-2AO-P	1	7760054187

Note	
-------------	--

CBX200 USB configuration interface adapter - 8978580000 + ADAPTER CBX200 - MINI USB 2907490000

Temperature transducer

Temperature transducer with limit switch

- Configurable from buttons and display
- Monitoring of resistance changes (e.g.: motor winding / heating resistors)
- Analog and digital output
- Removable terminals
- Available with SIL 2 for Safty applications

ACT20P-PRO-RTCI-AO-DO

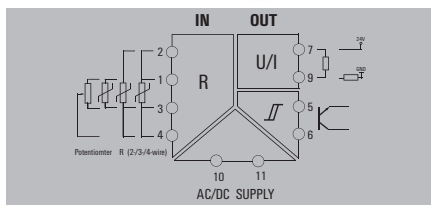

Technical data

Input
Number of inputs
Potentiometer
Resistance
Sensor

Output (digital)
Alarm function

Rated switching voltage
Type

Output (analogue)
Output current

Output voltage

Load resistance current

General data
Accuracy
Configuration
Step response time
Temperature coefficient
Voltage supply

Insulation coordination
EMC standards
Impulse withstand voltage
Galvanic isolation
Insulation voltage
Rated voltage
Overvoltage category

Dimensions	
Clamping range (nominal / min. / max.)	mm ²
Depth / Width / Height	mm

Note

Ordering data

Connection type
Screw connection with SIL
PUSH IN connection with SIL
Screw connection without SIL
PUSH IN connection without SIL

Note

1
500 Ω...120 kΩ
0...15 kΩ

RTD: PT100, PT200, PT500, PT1000, Ni50, Ni100, Ni120, Ni1000, Cu10, Cu25, Cu50, Cu100, RTD (2-wire): KTY83/110, KTY83/120, KTY83/150, KTY83/121, KTY83/122, KTY83/210, KTY83/220, KTY83/221, KTY83/250, KTY82/110, KTY82/120, KTY82/150, KTY82/121, KTY82/122, KTY82/210, KTY82/220, KTY82/221, KTY82/250, KTY84/130, KTY16, KTY19, ST13, ST20, Thermocouples: B, E, J, K, L, N, R, S, T, U, L

configurable, Top and bottom limit values, window range, Short circuit at input

24 VDC ±30%
NPN-Transistor, Switching frequency 5 kHz

configurable, 0(4)...20 mA, -20...+20 mA, ± 10mA, upscale (23 mA), downscale (3,5 mA)

configurable, 0(1)...5 V, 0(2)...10 V, downscale (0 V), upscale (11 V), -5...+5 V, -10...+10 V

≤ 600 Ω

<±0.1 % of span, ≤0.2 °C (PT100)

with push-buttons and display

10 ms, 2- / 4- wire: 320 ms; 3- wire / Poti: 640 ms

≤ 0.01 % / °C

24...230 V DC ±15%, 110 - 230 V AC / 60-50 Hz

EN 61326-1

5 kV (1.2/50 μs)

4-way isolator, between input/ output/ supply

4 kV_{eff} / 1 min.

600 V

II

Screw connection	PUSH IN
2.5 / 0.5 / 2.5	2 / 0.5 / 2
113.7 / 12.5 / 119.2	113.7 / 12.5 / 127.1

Type	Qty.	Order No.
ACT20P-PRO-RTC-AO-DOS-S	1	2489890000
ACT20P-PRO-RTC-AO-DOS-P	1	2490030000
ACT20P-PRO-RTCI-AO-DOS-S	1	2448100000
ACT20P-PRO-RTCI-AO-DOS-P	1	2448110000

Note

Temperature transducer with limit switch

- Temperature monitoring of PT100 sensors or PTC
- Temperature range can be selected
- 2 relays with CO contacts
- Limit value can be set with software configuration

ACT20P-TMR-RTI

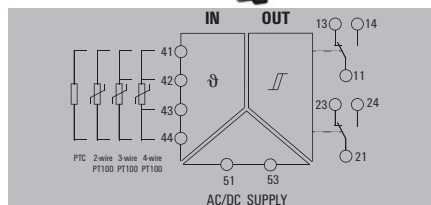

Technical data

Input	
Number of inputs	1
Sensor	PT100 (2-/3-/4-wire), PTC resistor (2-wire)
Temperature input range	Configurable, PT100: -200°C...850 °C
Output (digital)	
Number of digital outputs	1
Type	2 x 1 - or 1 x 2 changeover contact relay
Alarm function	Alarm range: -200...850 °C, Limit values: high, low, window, Hysteresis: 2 °C (adjustable), Window range: min. 20 °C, Alarm delay: 0...10 s
Rated switching current	5 A
Max. switching voltage, AC	250 V
Max. switching voltage, DC	30 V
General data	
Configuration	With FDT/DTM software, Requires configuration adapter 8978580000 CBX200 USB
Accuracy	0.2% FSR, ≤ 2 °C (PT100), ≤ 8 Ω (PTC)
Power consumption	≤ 100 mA @ 24 VDC, ≤ 120 mA @ 24V AC
Step response time	≤ 500 ms
Temperature coefficient	≤ 100 ppm/K
Voltage supply	20...264 VUC
Insulation coordination	
EMC standards	EN 61326-1
Galvanic isolation	3-way isolator, between input/output/supply
Insulation voltage	2 kV (Input /Output), 1 min, 50 Hz
Impulse withstand voltage	4 kV (1.2/50 μ s)
Pollution degree	2
Overvoltage category	III
Rated voltage	300 V
Standards	IEC 61010-1

Dimensions

Clamping range (nominal / min. / max.)	mm ²
Depth / Width / Height	mm

Note

Ordering data

Connection type	
	Screw connection
	PUSH IN connection

Note

Accessories

Note	CBX200 USB 8978580000
-------------	-----------------------

Screw connection

Screw connection	PUSH IN
1.5 / 0.5 / 2.5	2.5 / 0.5 / 2.5
114.3 / 22.5 / 119.2	114.3 / 22.5 / 127.1

Type	Qty.	Order No.
ACT20P-TMR-RTI-S	1	7760054305
ACT20P-TMR-RTI-P	1	7760054352

Limit switch

Universal limit switch

- Universally configurable input for temperature, voltage, current, potentiometer, resistance
- 2 independent relay outputs with multiple limit value functions: window alarm, upper/lower limits, hysteresis, delay, etc.
- Configuration on the device from 7-segment display or via FDT/DTM software
- External power supply DC or AC

ACT20P-UI-2RCO-DC

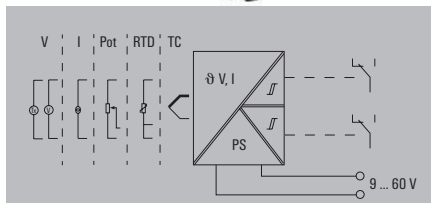

Technical data

Input	
Number of inputs	1
Sensor	RTD (2,3-wire): Pt100, Pt200, Pt1000, Ni120, Cu10, Thermocouples: B, E, J, K, L, N, R, S, T, U
Temperature input range	B: +100...+1820 °C, E: -270...+1000 °C, J: (-210...+1200 °C), K: -270...+1372 °C, L: +100...+900 °C, N: (-180...+1300 °C), R: -50...+1768 °C, S: -50...+1768 °C, T: -270...+400 °C, U: -200...+600 °C
Output (digital)	
Alarm function	configurable, Top and bottom limit values, window range, Alarm delay: 0...99 s, Hysteresis adjustable, auto / manual reset
Rated switching current	200mA @ 110Vdc, 6A @ 24Vdc / 240Vac
Number of digital outputs	2
Type	2 CO contacts, normal / inverse adjustment, Switching frequency 20 Hz
Max. switching voltage, AC	250 V
General data	
Accuracy	<0.1 % of measuring range
Configuration	With FDT/DTM software, or via 7-segment display, push-buttons and rotary encoder on the device itself, Requires configuration adapter 8978580000 CBX200 USB
Step response time	450 ms
Power consumption	≤ 3.5 W, <2 W
Temperature coefficient	<0.02 °C of measuring range / °C, 350 ppm/K
Voltage supply	9...60 V DC
Insulation coordination	
Standards	EN 61010-1
Pollution degree	2
Ambient temperature (operational)	-20 °C...65 °C

Dimensions	
Clamping range (nominal / min. / max.)	mm ²
Depth / Width / Height	mm
Note	
Screw connection	
2.5 / 0.5 / 2.5	PUSH IN
113.6 / 22.5 / 119.2	113.6 / 22.5 / 127.1

Ordering data	
DC supply voltage	
Screw connection	ACT20P-UI-2RCO-DC-S
PUSH IN connection	ACT20P-UI-2RCO-DC-P
AC supply voltage	
Screw connection	ACT20P-UI-2RCO-AC-S
PUSH IN connection	ACT20P-UI-2RCO-AC-P
Note	
CBX200 USB 8978580000	

Ordering data	
DC supply voltage	
Screw connection	ACT20P-UI-2RCO-DC-S
PUSH IN connection	ACT20P-UI-2RCO-DC-P
AC supply voltage	
Screw connection	ACT20P-UI-2RCO-AC-S
PUSH IN connection	ACT20P-UI-2RCO-AC-P
Note	
CBX200 USB 8978580000	

Ordering data	
DC supply voltage	
Screw connection	ACT20P-UI-2RCO-DC-S
PUSH IN connection	ACT20P-UI-2RCO-DC-P
AC supply voltage	
Screw connection	ACT20P-UI-2RCO-AC-S
PUSH IN connection	ACT20P-UI-2RCO-AC-P
Note	
CBX200 USB 8978580000	

Note	
CBX200 USB 8978580000	

Voltage monitoring, 1-phase

- Monitoring of single-phase systems up to 400 V AC/DC
- 3 input ranges can be selected
- 2 relays with CO contacts
- Holding function can be activated
- Rotary switch for setting limit values

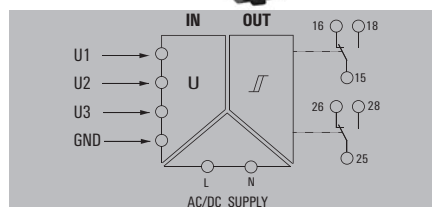
ACT20P-VMR-1PH-H**Technical data**

Input	
Number of inputs	1
Input voltage	Channel 1: (U1-E): 110V AC/DC, Channel 2: (U2-E): 240V AC/DC, Channel 3 1: (U3-E): 400V AC/DC
Input measurement range	50...120% $U_{\text{rated voltage}}$
Input frequency	40...60 Hz, DC
Input resistance, voltage	1 M Ω ±5%
Output (digital)	
Number of digital outputs	2
Type	2 x 1 - or 1 x 2 changeover contact relay, Relay polarity can be inverted
Alarm function	Top and bottom limit values, window range, Holding function can be activated, Alarm delay: 0...10 s
Rated switching current	5 A
Max. switching voltage, AC	250 V
Max. switching voltage, DC	30 V
General data	
Configuration	DIP switch and potentiometer
Accuracy	3% * $U_{\text{rated voltage}}$
Measurement calibration	max: 70...120% * $U_{\text{rated voltage}}$, min: 50...100% * $U_{\text{rated voltage}}$
Power consumption	≤ 100 mA @ 24 VDC, ≤ 120mA @ 24V AC, <2 W
Step response time	<220 ms (10...90 %)
Temperature coefficient	350 ppm/K
Repeat accuracy	2% * $U_{\text{rated voltage}}$
Voltage supply	24...240 VUC ±10%
Insulation coordination	
Galvanic isolation	3-way isolator, between input / output / supply, yes
Rated voltage	300 VAC (output 1 - output 2), 300 VAC (supply-output), 500 VAC (supply-input, input-output)
Insulation voltage	2.5 kV (input / output), 2 kV input / output/ power supply
Impulse withstand voltage	Supply/output: 4 kV; input/output, input/output: 6 kV, 1.2/50 μ s
Pollution degree	2
Overvoltage category	III
EMC standards	EN 61326-1
Dimensions	
Clamping range (nominal / min. / max.)	mm ²
Depth / Width / Height	mm
Note	

Screw connection		PUSH IN, Screw connection	
1.5 / 0.5 / 2.5		2.5 / 0.5 / 2.5	
114.3 / 22.5 / 117		114.3 / 22.5 / 117	

Ordering data

Connection type	
	Screw connection
	PUSH IN connection
Note	

Type	Qty.	Order No.
ACT20P-VMR-1PH-H-S	1	7760054164
ACT20P-VMR-1PH-H-P	1	7760054359

Accessories

Note

Limit switch

Voltage monitoring, 3-phase

- Voltage monitoring of single-phase network up to 500 V AC
- 3 input ranges can be selected
- 2 relays with CO contacts
- Holding function can be activated
- Rotary switch for setting limit values

ACT20P-VMR-3PH-ILP-H

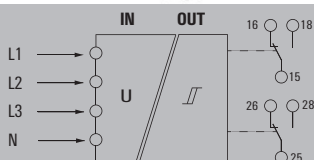

Technical data

Input

Number of inputs
Input frequency
Input measurement range
Input voltage
Input resistance, voltage

Output (digital)

Number of digital outputs
Type

Alarm function

Rated switching current
Max. switching voltage, AC
Max. switching voltage, DC

General data

Configuration
Accuracy
Measurement calibration
Repeat accuracy
Step response time
Temperature coefficient
Voltage supply

Insulation coordination

EMC standards
Galvanic isolation

Rated voltage
Insulation voltage
Impulse withstand voltage
Pollution degree
Overvoltage category
Standards

Dimensions

Clamping range (nominal / min. / max.) mm²
Depth / Width / Height mm

Note

Ordering data

Connection type

Screw connection
PUSH IN connection

Note

Accessories

Note

1
40...60 Hz
200...480 VAC
180...500 VAC
≥1,8MΩ
2
2 x 1 - or 1 x 2 changeover contact relay, Relay polarity can be inverted
Top and bottom limit values, window range, Holding function can be activated, Phase error, Phase sequence, Asymmetry, Alarm delay: 0...10 s
5 A
250 V
30 V
DIP switch and potentiometer
3% *U _{rated voltage}
max: 70...120% *U _{rated voltage} , min: 50...100% *U _{rated voltage}
2% *U _{rated voltage}
≤ 100 ms
350 ppm/K
supplied from voltage measurement inputs
EN 61326-1
2-way isolator, between input/output, yes, between input / output / supply
600 VAC (input - output), 300 VAC (output 1 - output 2)
2.5 kV (input / output)
6 kV (input - output), 4 kV (output 1 - output 2), 1.2/50 μs
2
III
EN 61010-1

Screw connection

1.5 / 0.5 / 2.5

PUSH IN

2.5 / 0.5 / 2.5

114.3 / 22.5 / 117

114.3 / 22.5 / 117

Type	Qty.	Order No.
ACT20P-VMR-3PH-ILP-H-S	1	7760054165
ACT20P-VMR-3PH-ILP-H-P	1	7760054361

Current measuring transducers

- Measuring and monitoring AC/DC currents
- Input/output electrically isolated
- Input and output ranges are adjustable
- Measurement range extension via external current transformer
- Relay output for limit value alarm with switching threshold, delay, hysteresis

ACT20P-CML-10-AO-RC

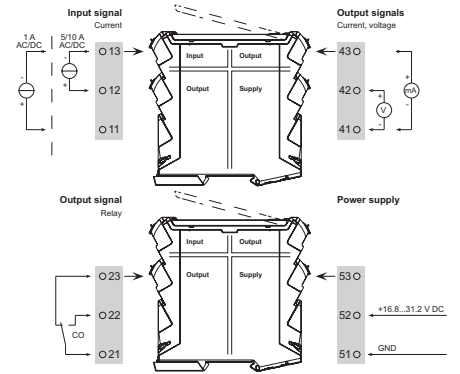
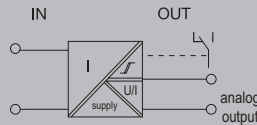

Technical data

Input

Number of inputs
Input frequency
Input measurement range

1
AC: 15...400 Hz (true root mean square) configurable, 0...1/5/10 A AC (RMS) or DC, max. peak current $10 \times I_{input}$ (1 s). For DC current measurement (AA): Current direction display at the output (+/- analog value)

Output (digital)

Alarm function

Surge current, Under-current, Alarm limit setting: 2 - 105 %, Hysteresis 5% / 10%, Alarm delay: 0...10 s

Output (analogue)

Rated switching current
Number of digital outputs
Type
Max. switching voltage, AC
Load resistance current
Load resistance voltage
Number of analogue outputs
Output current
Output voltage

2 A
1
Relay, 1 CO contact, normal / inverse adjustment
250 V
 $\leq 600 \Omega$
 $\geq 10 k\Omega$
1
Adjustable, 0...20 mA, 4...20 mA, -20...+20 mA
Adjustable, 0...10 V, 2...10 V, 0...5 V, 1...5 V, -5...+5 V, -10...+10 V

General data

Accuracy
Configuration
Step response time
Power consumption, max.
Temperature coefficient
Voltage supply

$\leq \pm 0.3 \% @ 1 A / 5 A, \leq \pm 0.6 \% @ 10 A$
DIP switch and potentiometer
 $\leq 300 \text{ ms (RMS)}, \leq 60 \text{ ms (AA)}$
2.2 W
 $\leq \pm 100 \text{ ppm/K @ } -25...+55 \text{ }^\circ\text{C}, \leq \pm 200 \text{ ppm/K @ } +55...+70 \text{ }^\circ\text{C}$
16,8 V...31,2 V

Insulation coordination

EMC standards
Impulse withstand voltage
Galvanic isolation
Insulation voltage
Test voltage
Overvoltage category

EN 61326-1
6 kV (1.2/50 μs)
4-way isolator, between input / output / supply / relay
4 kV_{eff} / 1 min.
4 kV
III

Dimensions

Clamping range (nominal / min. / max.) mm²
Depth / Width / Height mm

Screw connection **PUSH IN**

1.5 / 0.5 / 2.5 2.5 / 0.5 / 2.5
113.6 / 17.5 / 119.2 114 / 17.5 / 127.1

Note

Ordering data

Connection type

Screw connection
PUSH IN connection

Type	Qty.	Order No.
ACT20P-CML-10-AO-RC-S	1	2044850000
ACT20P-CML-10-AO-RC-P	1	2489910000

Note

Accessories

Note

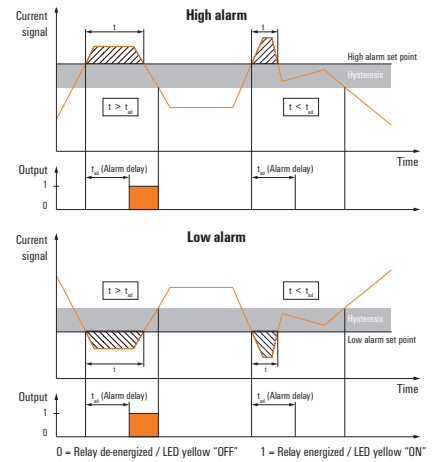

Current and voltage transformers

Current transformer with through-hole technology

- Measuring and monitoring of AC/DC current
- Input/output electrically isolated
- Input and output ranges are adjustable
- Contact-free through-hole technology
- Relay output for limit value alarm with switching threshold, delay, hysteresis

ACT20P-CMT

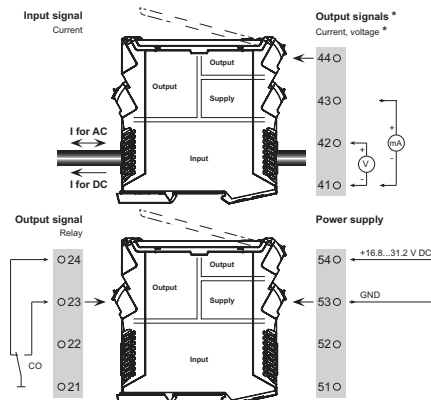
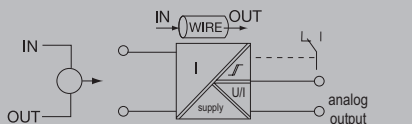

Technical data

Input	
Input measurement range	configurable, 0...5/10 A AC (RMS) or DC, max. peak current $10 \times I_{input}$ (1 s), max. peak current $2 \times I_{input}$ (1 s) @ 5/10 A DC, For DC current measurement (AA): Current direction display at the output (-/+ analog value), max. peak current $2 \times I_{input}$ (1 s)
Input signal	Current-carrying cable in feed-through hole
Input frequency	AC: 15...700 Hz (true root mean square)
Output (analogue)	
Output voltage	Adjustable, 0...10 V, 2...10 V, 0...5 V, 1...5 V, -5...+5 V, -10...+10 V
Output current	Adjustable, 0...20 mA, 4...20 mA, -20...+20 mA
Load resistance voltage	$\geq 10 \text{ k}\Omega$
Load resistance current	$\leq 600 \Omega$
Output (digital)	
Type	Relay, 1 CO contact, normal / inverse adjustment
Alarm function	Surge current, Under-current, Alarm limit setting: 2 - 105 %, Hysteresis 5% / 10%, Alarm delay: 0...10 s
Rated switching current	6 A
Max. switching voltage, AC	250 V
General data	
Galvanic isolation	4-way isolator, between input / output / supply / relay
Accuracy	$< 0.75 \%$ FSR
Configuration	DIP switch and potentiometer
Step response time	$\leq 300 \text{ ms}$ (RMS), $\leq 60 \text{ ms}$ (AA)
Temperature coefficient	$\leq \pm 100 \text{ ppm/K}$ @ -25...+55 °C, $\leq \pm 200 \text{ ppm/K}$ @ +55...+70 °C
Voltage supply	16.8 V...31.2 V
Insulation coordination	
Rated voltage	300 V AC _{max}
Standards	EN 61010-2-01
Impulse withstand voltage	6.4 kV (1.2/50 μs)
Test voltage	4 kV
Pollution degree	2
Overvoltage category	III
Dimensions	
Clamping range (nominal / min. / max.)	mm ²
Depth / Width / Height	mm
Note	

Current input range	
0...5 A	1) <input type="checkbox"/>
0...10 A	<input type="checkbox"/>
0...20 A	2) <input type="checkbox"/>
0...25 A	<input type="checkbox"/>
0...30 A	<input type="checkbox"/>
0...40 A	<input type="checkbox"/>
0...50 A	3) <input type="checkbox"/>
0...80 A	<input type="checkbox"/>
Measuring method	
True RMS	<input type="checkbox"/>
Arithmetic average	<input type="checkbox"/>
Alarm delay time	
0 s	<input type="checkbox"/>
2 s	<input type="checkbox"/>
5 s	<input type="checkbox"/>
10 s	<input type="checkbox"/>
Measuring range monitoring	
Yes	<input type="checkbox"/>
No	<input type="checkbox"/>
Output error action	
Upscale	<input type="checkbox"/>
Downscale	<input type="checkbox"/>
Transfer function	
Normal	<input type="checkbox"/>
Inverse	<input type="checkbox"/>

Ordering data

Connection type	Type
Input measurement range 0...5/10 A	Screw connection
Input measurement range 0...20/25/30 A	Screw connection
Input measurement range 0...40/50/60 A	Screw connection
Input measurement range: 0 to 40/50/60 A	Screw connection
Input measurement range 0...5/10 A	PUSH IN connection
Input measurement range 0...20/25/30 A	PUSH IN connection
Input measurement range 0...40/50/60 A	PUSH IN connection
Input measurement range: 0 to 40/50/60 A	PUSH IN connection
Note	

Type	Qty.	Order No.
ACT20P-CMT-10-AD-RC-S	1	1510470000
ACT20P-CMT-30-AD-RC-S	1	1510540000
ACT20P-CMT-60-AD-RC-S	1	1510440000
ACT20P-CMT-60-RC-S	1	1510390000
ACT20P-CMT-10-AD-RC-P	1	1510330000
ACT20P-CMT-30-AD-RC-P	1	1510320000
ACT20P-CMT-60-AD-RC-P	1	1510290000
ACT20P-CMT-60-RC-P	1	1510280000

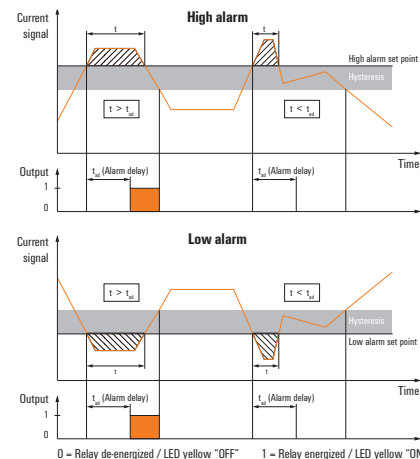

DIP switch S1		DIP switch S2	
Current input range	1 2 3 4 5 6 7 8	Output range	1 2 3 4 5 6 7 8
0...5 A	<input type="checkbox"/>	0...10 V	<input type="checkbox"/>
0...10 A	<input type="checkbox"/>	2...10 V	<input type="checkbox"/>
0...20 A	<input type="checkbox"/>	0...5 V	<input type="checkbox"/>
0...25 A	<input type="checkbox"/>	1...5 V	<input type="checkbox"/>
0...30 A	<input type="checkbox"/>	-5...+5 V	<input type="checkbox"/>
0...40 A	<input type="checkbox"/>	-10...+10 V	<input type="checkbox"/>
0...50 A	<input type="checkbox"/>	0...20 mA	<input type="checkbox"/>
0...80 A	<input type="checkbox"/>	4...20 mA	<input type="checkbox"/>
		-20...+20 mA	<input type="checkbox"/>
Measuring method		Alarm relay action	
True RMS	<input type="checkbox"/>	Energized	<input type="checkbox"/>
Arithmetic average	<input type="checkbox"/>	De-energized	<input type="checkbox"/>
Alarm delay time		Alarm hysteresis	
0 s	<input type="checkbox"/>	5 %	<input type="checkbox"/>
2 s	<input type="checkbox"/>	10 %	<input type="checkbox"/>
5 s	<input type="checkbox"/>		
10 s	<input type="checkbox"/>	Alarm type	
Measuring range monitoring		High alarm	<input type="checkbox"/>
Yes	<input type="checkbox"/>	Low alarm	<input type="checkbox"/>
No	<input type="checkbox"/>		
Output error action			
Upscale	<input type="checkbox"/>		
Downscale	<input type="checkbox"/>		
Transfer function			
Normal	<input type="checkbox"/>		
Inverse	<input type="checkbox"/>		

■ ON
1) ACT20P-CMT-10-AD-RC-S
2) ACT20P-CMT-30-AD-RC-S
3) ACT20P-CMT-60-AD-RC-S, ACT20P-CMT-60-RC-S

Voltage transformer 1 phase

- Voltage measurement of single-phase network up to 500 V AC
- 10 input ranges can be selected
- AC/DC power supply

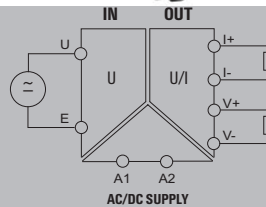
ACT20P-VM-A0**Technical data**

Input	
Input resistance	1 MΩ±5%
Input signal	U _{DC} , U _{AC} Effective value (sinusoidal only) 40-60 Hz
Input voltage	0...30 V DC, 0...60 V DC, 0...150 V DC, 0...300 V DC, 0...440 V DC, 0...660 V DC, 0...60 V AC, 0...144 V AC, 0...300 V AC, 0...440 V AC, configurable
Number of inputs	1
Output	
Load impedance current	≤ 500 Ω
Output current	0...20 mA, 4...20 mA
Output voltage	0...10 V
load impedance voltage	≥ 10 kΩ
General data	
Accuracy	0.5 % FSR
Configuration	With FDT/DTM software, Requires configuration adapter 8978580000 CBX200 USB
Power consumption	≤ 100 mA @ 24 VDC, ≤ 120mA @ 24V AC
Step response time	<300 ms
Temperature coefficient	≤ 200 ppm/K
Voltage supply	24...240 VUC (±10%)
Insulation coordination	
EMC standards	EN 61326-1, EN 61000-6-2, EN 61000-6-4
Galvanic isolation	3-way isolator, between input / output / supply
Impulse withstand voltage	4 kV (1.2/50 μs) input - output, 4 kV (1.2/50 μs) input / supply, 2.5 kV (1.2/50 μs) output / supply
Insulation voltage	1.5 kV AC output / supply, 2 kV AC input / output, 2 kV AC input / supply
Rated voltage	600 V input / output, 600 V input / supply, 300 V output / supply
Overvoltage category	III
Pollution degree	2
Standards	EN 50178

Dimensions		Screw connection	PUSH IN
Clamping range (nominal / min. / max.)	mm ²	1.5 / 0.5 / 2.5	2.5 / 0.5 / 2.5
Depth / Width / Height	mm	114.3 / 22.5 / 119.2	114.3 / 22.5 / 119.2
Note			

Ordering data

Connection type	Type	Qty.	Order No.
Screw connection	ACT20P-VM-A0-S	1	7760054306
PUSH IN connection	ACT20P-VM-A0-P	1	7760054360

Note**Accessories**

Note	
	CBX200 USB 8978580000

Measuring bridge transducers

Measuring bridge transducers, configurable

Bridge measuring transducer for reading from load cells

- 3-way isolation
- Supplies measuring bridges up to 4 x 350 Ω
- Simple calibration of the tare weight using external switch or PLC input
- Input and output ranges adjustable via DIP switch

ACT20P-BRIDGE

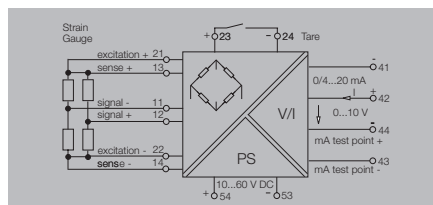

Technical data

Input	
Bridge sensitivity	1.0 mV / V to 5.0 mV / V
Sensor	Strain gauge resistance, Resistance measurement, Total resistance of all parallel resistance measuring bridges: min. 87 Ω
Sensor supply	120 mA @ 10 V (= 4 x 350 Ω bridge resistors)
Bridge supply voltage	5 V or 10 V
Output	
Type	active, connected control must be passive
Output voltage / Output current	0...11 V (adjustable) / 0...22 mA (adjustable)
Load impedance, voltage/current	600 Ω / ≤ 600 Ω
General data	
Configuration	DIP switch and button
Voltage supply	10...60 V DC
Power consumption	3 W @ 24 V DC
Linearity	Typically ± 0.05 % of signal range
Repeat accuracy	10...90 %, no condensation
Humidity	typ. 0.005 % / °C
Temperature coefficient	0.1 % / 10.000 h
Long-term drift	<400 ms (10...90 %)
Step response time	-40 °C...70 °C
Ambient temperature	CE
Approvals	
Insulation coordination	
Standards	DIN EN 61010-1
EMC standards	EN 61326
Rated voltage	300 V
Pollution degree	2
Overtoltage category	III
Insulation voltage	5.7 kV (input / output, input / supply)

Dimensions	
Clamping range (nominal / min. / max.)	mm ²
Depth x width x height	mm
Note	

Ordering data

Connection type	
	Screw connection
	PUSH IN connection
Note	

Accessories

Note	

Screw connection		PUSH IN	
	2.5 / 0.5 / 2.5		2.5 / 0.5 / 2.5
	113.6 / 22.5 / 119.2		113.6 / 22.5 / 127.1
Type			
ACT20P BRIDGE	Qty. 1	Order No. 1067250000	
ACT20P-BRIDGE-P	Qty. 1	Order No. 2456820000	

Front panel DIP Switch settings

Switch	Action if On	Action if Off
1	10 V Excitation	5 V Excitation
2	mA Output	Voltage Output
3	10 mV Span	Turn off for other ranges
4	20 mV Span	
5	30 mV Span	
6	50 mV Span	
7	4-wire Measurement	6-wire Measurement
8		

Connections

Terminal	Signal	
11	Signal -	Input signal
12	Signal +	
13	Sense +	Bridge Excitation Voltage
14	Sense -	
21	Excitation +	External Tare switch
22	Excitation -	
23	Tare +	Output signal
24	Tare -	
41	mA Output -	Power Supply
42	Output +	
43	mA-Test Point -	Output signal
44	Voltage Output -	
44	mA-Test Point +	Power Supply
54	+	
53	-	

Universal transducers

- Universally configurable input and output for voltage/ current
- Active or passive output
- Universal voltage supply 24...230 V AC/DC
- 3-way isolation
- Convenient configuration on the device with DIP switches or by means of clear-text display + buttons, without reference source.

ACT20P-PRO DCDC II

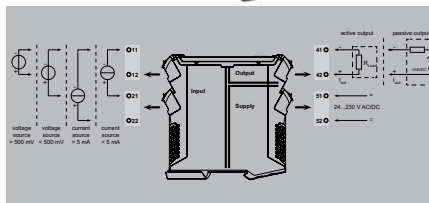

Technical data

Input	
Input voltage	configurable, ±40 mV...±300 V, Measuring range. min 40 mV
Input current	configurable, ± 0.1mA...± 100 mA
Input resistance, current	<5 mA: approx. 100 Ω; >5 mA: approx. 5 Ω
Input resistance, voltage	approx. 1 MΩ
Output	
Output voltage	Adjustable, 0...±10 V
Output current	configurable, 0...±20 mA
load impedance voltage	≥ 1 kΩ
Load impedance current	≤ 600 Ω
Offset voltage	<10 mV
Cut-off frequency (-3 dB)	> 10 kHz/ <10 Hz
General data	
Galvanic isolation	3-way isolator, between input/output/supply
Accuracy	<0.05 % of measuring range
Temperature coefficient	≤0,01% des Messbereichs°C
Configuration	DIP switch, or via display and push-buttons
Power consumption	≤2.3 W
Step response time	≤50 μs
Voltage supply	24...230 V DC ±20 %, 24...230 V AC ±10 % @ 48...62 Hz
Insulation coordination	
Rated voltage	600 V
Standards	EN 61010-1
Insulation voltage	4 kV _{eff} , input / output / power supply
Impulse withstand voltage	5 kV (1.2/50 μs)
Pollution degree	2
Overvoltage category	II

Dimensions	
Clamping range (nominal / min. / max.)	mm ²
Length x width x height	mm
Note	
Screw connection	
2.5 / 0.5 / 2.5	PUSH IN
12.5 / 119.2	12.5 / 127.1
Ordering data	
AC/DC supply voltage	
Screw connection	Type
PUSH IN connection	Qty.
	Order No.
	ACT20P-PRO DCDC II-S
	ACT20P-PRO DCDC II-P
DC supply voltage	
Screw connection	ACT20P-PRO DCDC II-24-S
PUSH IN connection	ACT20P-PRO DCDC II-24-P
Note	

Ordering data

Universal transducers

Universal transducers with limit switch

- Independent of external supply thanks to output loop-powered supply
- All-purpose usage thanks to versatile input functions
- Simple software configuration
- Digital output for versatile limit value setting

ACT20P-UI-A0-DO-LP

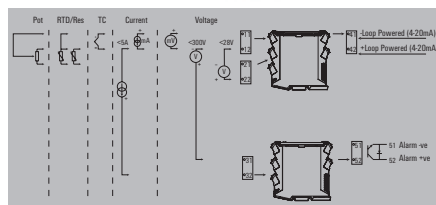

Technical data

Input	
Sensor	
Input voltage	
Input current	
Potentiometer	
Output (analogue)	
Output current	
Signal output	
Output (digital)	
Alarm function	
Hysteresis	
Type	
Rated switching voltage	
Rated switching current	
General data	
Galvanic isolation	
Accuracy	
Configuration	
Step response time	
Voltage supply	
Insulation coordination	
Rated voltage	
Standards	
Insulation voltage	
Impulse withstand voltage	
Pollution degree	
Overvoltage category	

PT100 (2-/3- wire), PT1000 (2-/3- wire), PT200, Ni120, Cu 10, Thermocouples: B, E, J, K, L, N, R, S, T, U	
configurable, ± 150 mV DC (min. measurement range 15 mV), ± 600 mV DC (min. measurement range 50 mV), ± 12 V DC (min. measurement range 1 V), ± 28 V DC (min. measurement range 2 V), ± 300 V DC (min. measurement range 100 V), 0...300 V AC	
configurable, ± 5 A DC (min. measurement range 0.5 A)	
1.2...500 k Ω	
4...20 mA (current loop)	
direct or inverted	
configurable, Top and bottom limit values, window range, Alarm delay: 0...99 s	
≥ 0.1 % of FS	
Transistor, open collector	
≤ 30 V DC	
20 mA	
2-way isolator, between input/output	
< 0.1 % of measuring range	
With FDT/DTM software, Requires configuration adapter 8978580000 CBX200 USB	
450 ms	
Output loop powered, (10...45 V)	
300 V _{eff}	
EN 61010-1	
3.51 kV between input and output	
4 kV (1.2/50 μ s)	
2	
III	

Dimensions	
Clamping range (nominal / min. / max.)	mm ²
Depth / Width / Height	
Note	

Screw connection	PUSH IN
2.5 / 0.5 / 2.5	2.5 / 0.5 / 2.5
113.6 / 12.5 / 119.2 mm	113.7 / 12.5 / 127.1 mm

Ordering data

Connection type	
	Screw connection
	PUSH IN connection
Note	

Type	Qty.	Order No.
ACT20P-UI-A0-DO-LP	1	1453210000
ACT20P-UI-A0-DO-LP-P	1	2456850000

Accessories

Note

CBX200 USB configuration adapter - 8978580000

CBX200 USB 8978580000

Frequency transducers

- Digital output with multiple limit value
- Universal voltage supply 24...230 V AC/DC
- Convenient configuration on the device with DIP switches or by means of clear-text display + buttons

ACT20P-PRO-FI-A0-D0

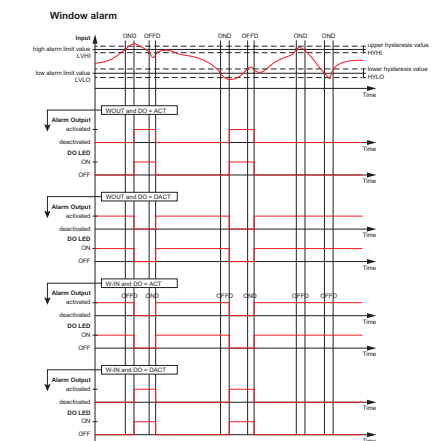
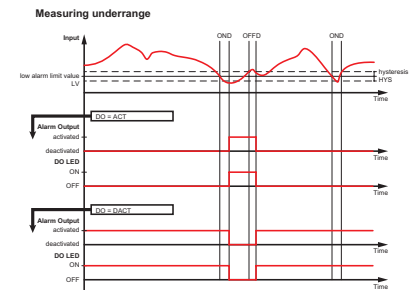
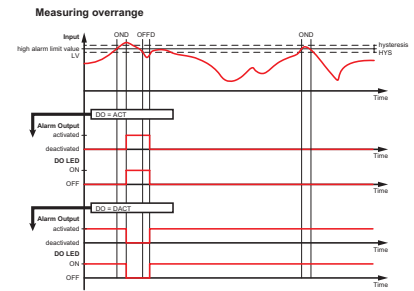
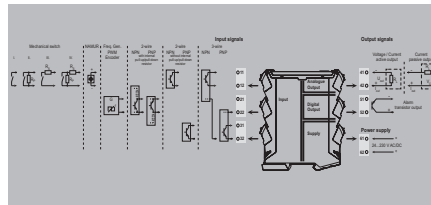

Technical data

Input	
Number of inputs	1
Sensor	NPN / PNP transistor (trig-level low: ≤4 V high: ≥7 V), NAMUR sensor, according to EN60947-5-6, switch with or without RS, RP, 2-wire transmitter (without own power supply), 3 wire NPN/PNP-transistor, frequency generator, PDM
Input frequency	0,01 Hz...200 kHz
Type	frequency or PWM
Output (analogue)	
Number of analogue outputs	1
Output current	-20...+20 mA, ± 10mA, 0(4)...20 mA, configurable downscale (3.5 mA) / upscale (23 mA) @ error
Output (digital)	
Number of digital outputs	1
Rated switching voltage	24 VDC ±30%
Type	NPN-Transistor, Switching frequency 5 kHz
Alarm function	configurable, Top and bottom limit values, window range, Short circuit at input, Alarm delay: 0...10 s, Hysteresis adjustable
General data	
Galvanic isolation	4-way isolator;
Accuracy	<±0.1 % of span
Configuration	with push-buttons and display
Step response time	40 ms + period
Voltage supply	24...230 V DC ±15%, 24...230 V AC ±15% @48...62 Hz
Ambient temperature (operational)	-40 °C...60 °C
Humidity	0...95 % (no condensation)
Insulation coordination	
Rated voltage	600 V
Standards	EN 61010-1
Insulation voltage	4 kV _{eff} / 1 min.
Impulse withstand voltage	5 kV (1.2/50 µs)
Pollution degree	2
Overvoltage category	II
Dimensions	
Clamping range (nominal / min. / max.)	mm ²
Depth / Width / Height	
Note	
Screw connection	PUSH IN
	113.7 / 12.5 / 117.2 mm 113.7 / 12.5 / 117.2 mm

Ordering data

Connection type	Type	Qty.	Order No.
Screw connection	ACT20P-PRO-FI-A0-D0-S	1	2447940000
PUSH IN connection	ACT20P-PRO-FI-A0-D0-P	1	2447950000
Screw connection, safety function	ACT20P-PRO-FI-A0-D0S-S	1	2490010000
PUSH IN connection, safety function	ACT20P-PRO-FI-A0-D0S-P	1	2490020000

Note

Space-saving signal converters – ACT20M

Space-saving signal converters – ACT20M	Introduction	D.2
	Selection table	D.4
	Supply isolator	D.8
	Isolation amplifier	D.10
	Passive isolator	D.15
	Temperature transducer	D.18
	Universal measuring transducers	D.26
	Frequency transducers	D.27

Reliable conversion and isolation of signals in confined spaces

With ACT20M signal converters with 6 mm wide design

The new dimension for converting and isolating – housed in a 6 mm width

D The ACT20M series of products combines innovative technology with maximum functionality in an electronics housing measuring just 6 mm in width. The ACT20-FEED-IN-PRO-S power-feed unit eliminates the need to wire the power supply to the modules. This reduces the installation time by at least 30%. The ACT20-FEED-IN-PRO-S can supply and monitor up to 120 devices, which are mounted on the CH20 terminal rail bus.

The product line consists of Input Loop Powered, Output Loop Powered and Auxiliary Powered analog isolators and converters, including a universal input converter.

The eight-connection housing allows additional functionality such as 2 channel ILP, 2 channel OLP isolation and signal splitting with input powering option.

The configuration is carried out via DIP switches or the FDT/ DTM software. The ACT20M modules are supplied via direct wiring or a rail bus.



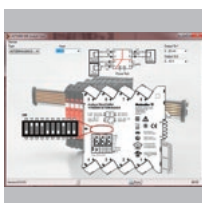
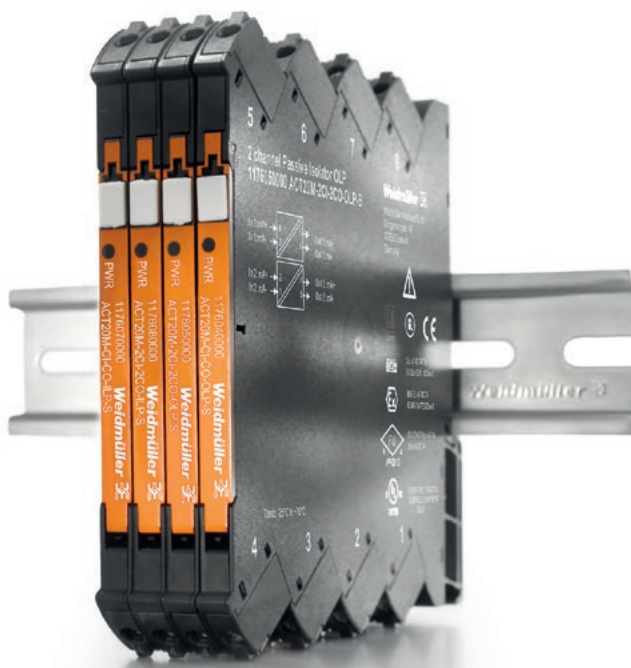

The DIP switch can be configured simply on the module

In the “ACT20M Tool” software, simply select the type of input and output, and set the DIP switch configuration as displayed.



Installation is simple and quick

The power supply is simply snapped onto the rail bus for fast and easy installation. The supply can be through any ACT20M module or a separate power-feed unit.



Easy configuration

DIP switches on the side are used to configure the input and output parameters, as well as the response time.



Approvals

Fulfills the strict standards and requirements of the process industry. Can be used worldwide due to international and local approvals.

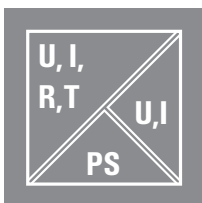

High level of galvanic isolation

2.5 kV of electrical isolation (300 V rated voltage) ensures excellent process reliability.

Selection table



Selection table

Order No.	Product	Input										Miscellaneous	sensor feed	Width
		Number of channels	0...20 mA	4...20 mA	0...10 V	0...5 V	TC	RTD	Frequency					

Space-saving signal converters - ACT20M

Supply isolator

117600000	ACT20M-AI-AO-S	1	X	X	X	X						2, 4-wire sensor	X	6.1 mm
2825370000	ACT20M-AI-AO-P	1	X	X	X	X						2, 4-wire sensor	X	6.1 mm
2825050000	ACT20M-AI-AO-X-S	1	X	X	X	X						2, 4-wire sensor	X	6.1 mm
2825180000	ACT20M-AI-AO-X-P	1	X	X	X	X						2, 4-wire sensor	X	6.1 mm
1176020000	ACT20M-AI-2AO-S	1	X	X	X	X						2, 4-wire sensor	X	6.1 mm
2825350000	ACT20M-AI-2AO-P	1	X	X	X	X						2, 4-wire sensor	X	6.1 mm
2825030000	ACT20M-AI-2AO-X-S	1	X	X	X	X						2, 4-wire sensor	X	6.1 mm
2825160000	ACT20M-AI-2AO-X-P	1	X	X	X	X						2, 4-wire sensor	X	6.1 mm

Isolation amplifier

1175980000	ACT20M-CI-CO-S	1	X	X								4-wire sensor		6.1 mm
2825410000	ACT20M-CI-CO-P	1	X	X								4-wire sensor		6.1 mm
2825090000	ACT20M-CI-CO-X-S	1	X	X								4-wire sensor		6.1 mm
2825240000	ACT20M-CI-CO-X-P	1	X	X								4-wire sensor		6.1 mm
1175990000	ACT20M-CI-2CO-S	1	X	X								4-wire sensor		6.1 mm
2825400000	ACT20M-CI-2CO-P	1	X	X								4-wire sensor		6.1 mm
2825080000	ACT20M-CI-2CO-X-S	1	X	X								4-wire sensor		6.1 mm
2825210000	ACT20M-CI-2CO-X-P	1	X	X								4-wire sensor		6.1 mm
1176010000	ACT20M-AI-AO-E-S	1	X	X	X	X						4-wire sensor		6.1 mm
2825360000	ACT20M-AI-AO-E-P	1	X	X	X	X						4-wire sensor		6.1 mm
2825040000	ACT20M-AI-AO-E-X-S	1	X	X	X	X						4-wire sensor		6.1 mm
2825170000	ACT20M-AI-AO-E-X-P	1	X	X	X	X						4-wire sensor		6.1 mm
1375450000	ACT20M-BAI-AO-S	1										-10(20)...+10(20) mA, -5(10)...+5(10) V		6.1 mm
1375470000	ACT20M-BAI-2AO-S	1										-10(20)...+10(20) mA, -5(10)...+5(10) V		6.1 mm
2825060000	ACT20M-BAI-2AO-X-S	1										-10(20)...+10(20) mA, -5(10)...+5(10) V		6.1 mm

	Output						Configuration	Auxiliary power	Rated insulation voltage	Isolation	Rail bus	Ex approval	Shipbuilding approval	Special characteristics
	Number outputs	0...20 mA	4...20 mA	0...10 V	Switching signal	Limit value, digital								
1	X	X	X				DIP switch	24 V DC	300 V	3-way	X	X	X	
1	X	X	X				DIP switch	24 V DC	300 V	3-way	X	X	X	
1	X	X	X				DIP switch	24 V DC	300 V	3-way		X	X	
1	X	X	X				DIP switch	24 V DC	300 V	3-way		X	X	
2	X	X	X				DIP switch	24 V DC	300 V	3-way	X	X	X	Splitter
2	X	X	X				DIP switch	24 V DC	300 V	3-way	X	X	X	Splitter
2	X	X	X				DIP switch	24 V DC	300 V	3-way		X	X	Splitter
2	X	X	X				DIP switch	24 V DC	300 V	3-way		X	X	Splitter
1	X	X						24 V DC	300 V	3-way	X	X	X	
1	X	X						24 V DC	300 V	3-way	X	X	X	
1	X	X						24 V DC	300 V	3-way		X	X	
1	X	X						24 V DC	300 V	3-way		X	X	
2	X	X					-	24 V DC	300 V	3-way	X	X	X	Splitter
2	X	X					-	24 V DC	300 V	3-way	X	X	X	Splitter
2	X	X					-	24 V DC	300 V	3-way		X	X	Splitter
2	X	X					-	24 V DC	300 V	3-way		X	X	Splitter
1	X	X	X				DIP switch	24 V DC	300 V	3-way	X	X	X	
1	X	X	X				DIP switch	24 V DC	300 V	3-way	X	X	X	
1	X	X	X				DIP switch	24 V DC	300 V	3-way		X	X	
1	X	X	X				DIP switch	24 V DC	300 V	3-way		X	X	
1	X	X	X				DIP switch	24 V DC	300 V	3-way	X	X	X	
2	X	X	X				DIP switch	24 V DC	300 V	3-way	X	X	X	Splitter
2	X	X	X				DIP switch	24 V DC	300 V	3-way		X	X	Splitter

Connection system: S = screw / Z = tension clamp / P = Push In, ILP = Input Loop Powered, OLP = Output Loop Powered, *) = in preparation

Selection table

Selection table

Order No.	Product	Input										Miscellaneous	sensor feed	Width
		Number of channels	0...20 mA	4...20 mA	0...10 V	0...5 V	TC	RTD	Frequency					
Passive isolator														
1176070000	ACT20M-CH-CO-ILP-S	1	X	X				X				4-wire sensor		6.1 mm
2825220000	ACT20M-CI-CO-ILP-P	1	X	X				X				4-wire sensor		6.1 mm
1176080000	ACT20M-2CI-2CO-ILP-S	2	X	X								4-wire sensor		6.1 mm
2825140000	ACT20M-2CI-2CO-ILP-P	2	X	X								4-wire sensor		6.1 mm
2825000000	ACT20M-CH-CO-OLP2-S	1		X				X				4-wire sensor	X	6.1 mm
2825320000	ACT20M-CI-CO-OLP2-P	1		X				X				4-wire sensor	X	6.1 mm
2825010000	ACT20M-2CI-2CO-OLP2-S	2		X				X				4-wire sensor	X	6.1 mm
2825330000	ACT20M-2CI-2CO-OLP2-P	2		X				X				4-wire sensor	X	6.1 mm
1176040000	ACT20M-CH-CO-OLP-S	1		X				X				2-wire transmitter	X	6.1 mm
2825230000	ACT20M-CI-CO-OLP-P	1		X				X				2-wire transmitter	X	6.1 mm
1176050000	ACT20M-2CI-2CO-OLP-S	2		X								2-wire transmitter	X	6.1 mm
2825150000	ACT20M-2CI-2CO-OLP-P	2		X								2-wire transmitter	X	6.1 mm
Temperature transducer														
1435590000	ACT20M-RTCI-CO-OLP-S	1						X	X			PT100 type: J,K		6.1 mm
2825250000	ACT20M-RTCI-CO-OLP-P	1						X	X			PT100 type: J,K		6.1 mm
1435610000	ACT20M-RTI-CO-EOLP-S	1							X			PT100		6.1 mm
2825280000	ACT20M-RTI-CO-EOLP-P	1						X	X			PT100		6.1 mm
2830480000	ACT20M-RTCI-CO-H-S	1						X	X			PT100 type: J,K		6.1 mm
2830490000	ACT20M-RTCI-CO-H-P	1						X	X			PT100 type: J,K		6.1 mm
2830500000	ACT20M-RTCI-CO-H-X-S	1						X	X			PT100 type: J,K		6.1 mm
2830510000	ACT20M-RTCI-CO-H-X-P	1						X	X			PT100 type: J,K		6.1 mm
2830460000	ACT20M-RTCI-CO-HOLP-S	1						X	X			PT100 type: J,K		6.1 mm
2830470000	ACT20M-RTCI-CO-HOLP-P	1						X	X			PT100 type: J,K		6.1 mm
1375510000	ACT20M-RTI-AO-S	1							X			PT100		6.1 mm
2825420000	ACT20M-RTI-AO-P	1							X			PT100		6.1 mm
2825100000	ACT20M-RTI-AO-X-S	1							X			PT100		6.1 mm
2825270000	ACT20M-RTI-AO-X-P	1							X			PT100		6.1 mm
1375520000	ACT20M-RTI-AO-E-S	1							X			PT100		6.1 mm
2825260000	ACT20M-RTI-AO-E-P	1							X			PT100		6.1 mm
1375480000	ACT20M-TCI-AO-S	1						X				type J,K		6.1 mm
2825430000	ACT20M-TCI-AO-P	1						X				type J,K		6.1 mm
2825110000	ACT20M-TCI-AO-X-S	1						X				type J,K		6.1 mm
2825300000	ACT20M-TCI-AO-X-P	1						X				type J,K		6.1 mm
1375500000	ACT20M-TCI-AO-E-S	1						X				type J,K		6.1 mm
2825290000	ACT20M-TCI-AO-E-P	1						X				type J,K		6.1 mm
Universal measuring transducers														
1176030000	ACT20M-UI-AO-S	1	X	X	X	X	X	X				PT50/100/250/300/400/1000, Ni50/100/1000 type: B/C/E/J/K/L/N/R/S/T	X	6.1 mm
2825440000	ACT20M-UI-AO-P	1	X	X	X	X	X	X				PT50/100/250/300/400/1000, Ni50/100/1000 type: B/C/E/J/K/L/N/R/S/T	X	6.1 mm
2825120000	ACT20M-UI-AO-X-S	1	X	X	X	X	X	X				PT50/100/250/300/400/1000, Ni50/100/1000 type: B/C/E/J/K/L/N/R/S/T	X	6.1 mm
2825310000	ACT20M-UI-AO-X-P	1	X	X	X	X	X	X				PT50/100/250/300/400/1000, Ni50/100/1000 type: B/C/E/J/K/L/N/R/S/T	X	6.1 mm
Frequency transducers														
2825020000	ACT20M-FRQ-AO-S	1								X		Namur, switch, tachometer, TTL, NPN/PNP, current/voltage	X	6.1 mm
2825450000	ACT20M-FRQ-AO-P	1								X		Namur, switch, tachometer, TTL, NPN/PNP, current/voltage	X	6.1 mm
2825130000	ACT20M-FRQ-AO-X-S	1								X		Namur, switch, tachometer, TTL, NPN/PNP, current/voltage	X	6.1 mm
2825340000	ACT20M-FRQ-AO-X-P	1								X		Namur, switch, tachometer, TTL, NPN/PNP, current/voltage	X	6.1 mm

	Output							Configuration	Auxiliary power	Rated insulation voltage	Isolation	Rail bus	Ex approval	Shippbuilding approval	Special characteristics
	Number outputs	0...20 mA	4...20 mA	0...10 V	Switching signal	Limit value, digital	Status, digital								
1	X	X						input loop	300 V	2-way		X	X		
1	X	X						input loop	300 V	2-way		X	X		
2	X	X						input loop	300 V	2-way		X	X		
2	X	X						input loop	300 V	2-way		X	X		
1		X						output loop	300 V	2-way		X	-		
1		X						output loop	300 V	2-way		X	-		
2		X						output loop	300 V	2-way		X	-		
2		X						output loop	300 V	2-way		X	-		
1		X						output loop	300 V	2-way		X	X		
1		X						output loop	300 V	2-way		X	X		
2		X						output loop	300 V	2-way		X	X		
2		X						output loop	300 V	2-way		X	X		
2		X						output loop	300 V	2-way		X	X		
1		X					20...4 mA	DIP switch	output loop	300 V	2-way		X	X	
1		X					20...4 mA	DIP switch	output loop	300 V	2-way		X	X	
1		X					20...4 mA	DIP switch	output loop	-	-		X	X	
1		X					20...4 mA	DIP switch	output loop	-	-		X	X	
1		X						DIP switch / HART	24 V DC	300 V	3-way	X	X		
1		X						DIP switch / HART	24 V DC	300 V	3-way	X	X		
1		X						DIP switch / HART	24 V DC	300 V	3-way				
1		X						DIP switch / HART	24 V DC	300 V	3-way				
								DIP switch / HART	output loop	300 V	2-way		X	-	
								DIP switch / HART	output loop	300 V	2-way		X	-	
1	X	X	X				0(1)...5 V	DIP switch	24 V DC	300 V	3-way	X	X	X	
1	X	X	X				0(1)...5 V	DIP switch	24 V DC	300 V	3-way	X	X	X	
1	X	X	X				0(1)...5 V	DIP switch	24 V DC	300 V	3-way		X	X	
1	X	X	X				0(1)...5 V	DIP switch	24 V DC	300 V	3-way		X	X	
1	X	X	X				0(1)...5 V	DIP switch	24 V DC		-		X	X	
1	X	X	X				0(1)...5 V	DIP switch	24 V DC		-		X	X	
1	X	X	X				internal CJC, external CJC	DIP switch	24 V DC	300 V	3-way	X	X	X	
1	X	X	X				internal CJC, external CJC	DIP switch	24 V DC	300 V	3-way	X	X	X	
1	X	X	X				internal CJC, external CJC	DIP switch	24 V DC	300 V	3-way		X	X	
1	X	X	X				internal CJC, external CJC	DIP switch	24 V DC	300 V	3-way		X	X	
1	X	X	X				internal CJC, external CJC	DIP switch	24 V DC	-	-		X	X	
								DIP switch	24 V DC	-	-		X	X	
1	X	X	X					Software	24 V DC	300 V	3-way	X	X	X	
1	X	X	X					Software	24 V DC	300 V	3-way	X	X	X	
1	X	X	X					Software	24 V DC	300 V	3-way		X	X	
1	X	X	X					Software	24 V DC	300 V	3-way		X	X	
1	X	X	X				filter possible	Software	24 V DC	300 V	3-way	X	X	-	Sensor supply and Trigger level adjustable
1	X	X	X				filter possible	Software	24 V DC	300 V	3-way	X	X	-	Sensor supply and Trigger level adjustable
1	X	X	X				filter possible	Software	24 V DC	300 V	3-way		X	-	Sensor supply and Trigger level adjustable
1	X	X	X				filter possible	Software	24 V DC	300 V	3-way		X	-	Sensor supply and Trigger level adjustable

Connection system: S = screw / Z = tension clamp / P = Push In, ILP = Input Loop Powered, OLP = Output Loop Powered, *) = in preparation

Supply isolator

Supply isolator with standard signals

- Input for current/voltage source
- Sensor supply
- Output for current/voltage source
- 3-way isolation
- Configuration via DIP switches
- Power supply via the mounting rail bus

ACT20M-AI-A0

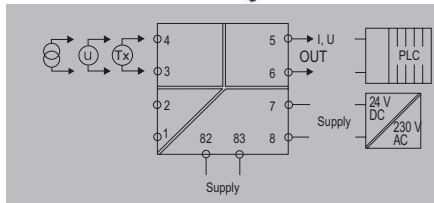
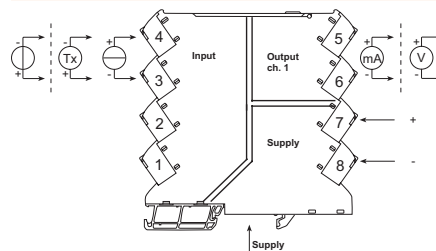

Technical data

Input	Sensor
Input current	configurable, 0...20 mA, 4...20mA
Input voltage	configurable, 0(2)...10 V, 0(1)...5 V
Sensor supply	> 17 V DC at 20 mA
Input resistance, voltage	>500 kΩ
Voltage drop, current input	<1,5 V
Output	
Output current	configurable, 0...20 mA, 4...20 mA
Output voltage	configurable, 0(2)...10 V, 0(1)...5 V
Load impedance current	≤ 600 Ω, @ max 23mA
load impedance voltage	≥ 10 kΩ
General data	
Configuration	DIP switch
Voltage supply	24 V DC ±30 % at terminal or via CH20M rail bus
Ambient temperature	-25 °C...70 °C
Accuracy	<0.05 % of measuring range
Temperature coefficient	≤ 0.01 % / °C
Cut-off frequency (-3 dB)	100 Hz
Power consumption, typ.	0.84 W
Power consumption, max.	1.2 W
Step response time	≤ 7 ms
Insulation coordination	
Insulation voltage	2.5 kV _{eff} / 1 min.
Rated voltage	300 V _{eff}
EMC standards	IEC 61326-1, NE 21
Pollution degree	2
Overvoltage category	II
Approvals	CCCEX; CE; cULus; DETNORVER; FMEX; IECCEXKEM; KEMAATEX; UKEX

Dimensions	
Clamping range (nominal / min. / max.)	mm ²
Depth x width x height	mm
Note	

Ordering data

Screw connection without mounting rail bus supply	ACT20M-AI-A0-X-S	1	2825050000
PUSH IN connection without mounting rail bus supply	ACT20M-AI-A0-X-P	1	2825180000
Screw connection with mounting rail bus supply	ACT20M-AI-A0-S	1	1176000000
PUSH IN connection with mounting rail bus supply	ACT20M-AI-A0-P	1	2825370000

Note	
-------------	--

Electrical connections	
Terminal	ACT20M-AI-A0-S
	Input (V, mA, mA Loop), Power supply, Output 1 (V, mA)
1	
2	
3	■ □ ■
4	□ ■ □
5	
6	
7	■ □
8	□
■ = +	
□ = -	
DIP switch settings	
Range	Input (1-4), Output (5-10)
0 ... 20 mA	□ □ □ □ □ □
4 ... 20 mA	□ ■ □ □ □ ■ □
0 ... 10 V	■ □ □ □ ■ □ □
2 ... 10 V	■ ■ □ □ ■ ■ □
0 ... 5 V	■ □ ■ ■ □ ■ ■
1 ... 5 V	■ ■ □ □ ■ ■ ■ ■
0 ... 20 mA loop	■ □ □ □
4 ... 20 mA loop	■ □ ■ □
■ = on	
□ = off	

Screw connection	PUSH IN
2.5 / 0.5 / 2.5	2.5 / 0.5 / 2.5
114.3 / 6.1 / 112.5	114.3 / 6.1 / 112.5
Power supply optionally over the DIN mounting rail CH20M	

Type	Qty.	Order No.
ACT20M-AI-A0-X-S	1	2825050000
ACT20M-AI-A0-X-P	1	2825180000
ACT20M-AI-A0-S	1	1176000000
ACT20M-AI-A0-P	1	2825370000

Note	
-------------	--

Supply isolator with standard signals and splitter function

- Isolation, conversion and doubling of DC signals
- Configuration via DIP switches
- Supply possible via the mounting rail bus
- 4-way isolation

ACT20M-AI-2A0

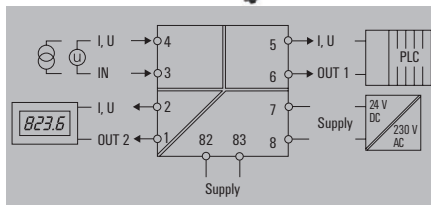
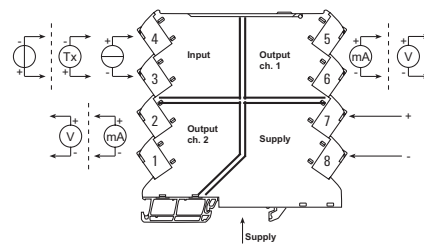

Technical data

Input	
Sensor	
Number of inputs	1
Input current	configurable, 0...20 mA, 4...20mA
Input voltage	configurable, 0(2)...10 V, 0(1)...5 V
Sensor supply	17...28 V DC (@ 20 mA)
Input resistance, voltage	500 kΩ
Voltage drop, current input	<1.5 V
Output	
Number of outputs	2
Output current	configurable, 0...20 mA, 4...20 mA
Output voltage	configurable, 0(2)...10 V, 0(1)...5 V
Load impedance current	<300 Ω, per channel, @ max 23mA
load impedance voltage	≥ 10 kΩ
General data	
Configuration	DIP switch
Voltage supply	24 V DC ±30 % at terminal or via CH20M rail bus
Ambient temperature	-25 °C...70 °C
Accuracy	<0.05 % of measuring range
Temperature coefficient	≤ 0.01 % / °C
Cut-off frequency (-3 dB)	100 Hz
Power consumption, typ.	0.84 W
Power consumption, max.	1.2 W
Step response time	≤ 7 ms
Insulation coordination	
Insulation voltage	2.5 kV _{eff} / 1 min.
Rated voltage	300 V _{eff}
EMC standards	IEC 61326-1, NE 21
Pollution degree	2
Overtoltage category	II
Approvals	CE; cULus; DETNORVER; FMEX; IECEXKEM; KEMAATEX; UKEX

Dimensions	
Clamping range (nominal / min. / max.)	mm ²
Depth x width x height	mm
Note	

Ordering data

Screw connection without mounting rail bus supply	ACT20M-AI-2A0-X-S	1	2825030000
PUSH IN connection without mounting rail bus supply	ACT20M-AI-2A0-X-P	1	2825160000
Screw connection with mounting rail bus supply	ACT20M-AI-2A0-S	1	1176020000
PUSH IN connection with mounting rail bus supply	ACT20M-AI-2A0-P	1	2825350000

Note	
-------------	--

Electrical connections								
	ACT20M-AI-2A0-S							
Terminal	Input			Power supply	Output 1		Output 2	
	V	mA	mA Loop		V	mA	V	mA
1							<input type="checkbox"/>	<input type="checkbox"/>
2							<input checked="" type="checkbox"/>	<input checked="" type="checkbox"/>
3	<input checked="" type="checkbox"/>	<input type="checkbox"/>	<input checked="" type="checkbox"/>					
4	<input type="checkbox"/>	<input checked="" type="checkbox"/>	<input type="checkbox"/>					
5						<input checked="" type="checkbox"/>	<input checked="" type="checkbox"/>	
6						<input type="checkbox"/>	<input type="checkbox"/>	
7				<input checked="" type="checkbox"/>				
8				<input type="checkbox"/>				
	<input checked="" type="checkbox"/> = + <input type="checkbox"/> = -							

Screw connection	PUSH IN
2.5 / 0.5 / 2.5	2.5 / 0.5 / 2.5
114.3 / 6.1 / 112.5	
Power supply optionally over the DIN mounting rail CH20M	

Range	Input				Output 1		Output 2	
	1	2	3	4	5	6	7	8
0 ... 20 mA	<input type="checkbox"/>	<input type="checkbox"/>	<input type="checkbox"/>	<input type="checkbox"/>	<input type="checkbox"/>	<input type="checkbox"/>	<input type="checkbox"/>	<input type="checkbox"/>
4 ... 20 mA	<input type="checkbox"/>	<input checked="" type="checkbox"/>	<input type="checkbox"/>	<input type="checkbox"/>	<input checked="" type="checkbox"/>	<input type="checkbox"/>	<input type="checkbox"/>	<input checked="" type="checkbox"/>
0 ... 10 V	<input checked="" type="checkbox"/>	<input type="checkbox"/>	<input type="checkbox"/>	<input type="checkbox"/>	<input type="checkbox"/>	<input type="checkbox"/>	<input type="checkbox"/>	<input type="checkbox"/>
2 ... 10 V	<input checked="" type="checkbox"/>	<input type="checkbox"/>	<input type="checkbox"/>	<input type="checkbox"/>	<input type="checkbox"/>	<input type="checkbox"/>	<input type="checkbox"/>	<input type="checkbox"/>
0 ... 5 V	<input checked="" type="checkbox"/>	<input type="checkbox"/>	<input checked="" type="checkbox"/>	<input checked="" type="checkbox"/>	<input type="checkbox"/>	<input checked="" type="checkbox"/>	<input checked="" type="checkbox"/>	<input checked="" type="checkbox"/>
1 ... 5 V	<input checked="" type="checkbox"/>	<input type="checkbox"/>	<input checked="" type="checkbox"/>	<input checked="" type="checkbox"/>	<input checked="" type="checkbox"/>	<input checked="" type="checkbox"/>	<input checked="" type="checkbox"/>	<input checked="" type="checkbox"/>
0 ... 20 mA loop	<input checked="" type="checkbox"/>	<input type="checkbox"/>	<input type="checkbox"/>	<input type="checkbox"/>				
4 ... 20 mA loop	<input checked="" type="checkbox"/>	<input type="checkbox"/>	<input checked="" type="checkbox"/>	<input type="checkbox"/>				
	<input checked="" type="checkbox"/> = on <input type="checkbox"/> = off							

Isolation amplifier

Isolation amplifier

- Input for power source (active)
- Output current source (active)
- Supply possible via the mounting rail bus
- 3-way isolation

ACT20M-CI-CO

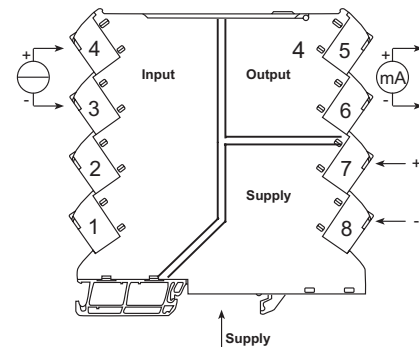
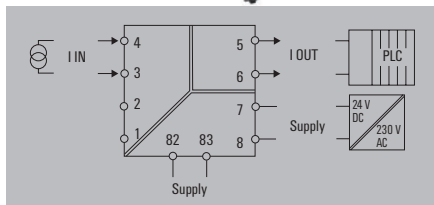

D

Technical data

Input	
Sensor	Current source, Sensor with own supply, 4-wire sensor
Number of inputs	1
Input current	0...20 mA, 4...20mA
Voltage drop, current input	<1.5 V
Output	
Number of outputs	1
Output current	0...20 mA, 4...20 mA
Load impedance current	≤ 600 Ω, @ max 23mA
General data	
Configuration	none
Voltage supply	24 V DC ±30 % at terminal or via CH20M rail bus
Ambient temperature	-25 °C...70 °C
Accuracy	<0.05 % of measuring range
Temperature coefficient	≤ 0.01 % / °C
Cut-off frequency (-3 dB)	100 Hz
Power consumption, typ.	0.45 W
Power consumption, max.	0.8
Step response time	≤ 7 ms
Insulation coordination	
Insulation voltage	2.5 kV _{eff} / 1 min.
Rated voltage	300 V _{eff}
EMC standards	IEC 61326-1, NE 21
Pollution degree	2
Overvoltage category	II
Approvals	CCCEX; CE; cULus; DETNORVER; FMEX; IECExKEM; KEMAATEX; UKEX

Dimensions	
Clamping range (nominal / min. / max.)	mm ²
Depth x width x height	mm
Note	

Ordering data

Type	Qty.	Order No.
Screw connection without mounting rail bus supply	1	2825090000
PUSH IN connection without mounting rail bus supply	1	2825240000
Screw connection with mounting rail bus supply	1	1175980000
PUSH IN connection with mounting rail bus supply	1	2825410000

Note

Electrical connections			
Terminal	ACT20M-CI-CO-S		
	Input mA	Power Supply	Output 1 mA
1			
2			
3	□		
4	■		
5			■
6			□
7		■	
8		□	

■ = +
□ = -

Screw connection	PUSH IN
2.5 / 0.5 / 2.5	2.5 / 0.5 / 2.5
114.3 / 6.1 / 112.5	
Power supply optionally over the DIN mounting rail CH20M	

Type	Qty.	Order No.
ACT20M-CI-CO-X-S	1	2825090000
ACT20M-CI-CO-X-P	1	2825240000
ACT20M-CI-CO-S	1	1175980000
ACT20M-CI-CO-P	1	2825410000

Note

Isolation amplifier with splitter function

- Isolation and doubling of DC signals
- Supply possible via the mounting rail bus
- 4-way isolation

ACT20M-CI-2CO

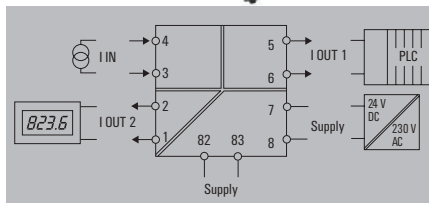
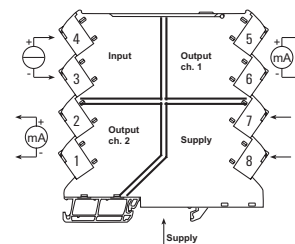

Technical data

Input	
Sensor	Current source, Sensor with own supply, 4-wire sensor
Number of inputs	1
Input current	0...20 mA, 4...20 mA
Voltage drop, current input	<1.5 V
Output	
Number of outputs	2
Output current	0...20 mA, 4...20 mA
Load impedance current	<300 Ω, per channel, @ max 23mA
General data	
Configuration	none
Voltage supply	24 V DC ±30 % at terminal or via CH20M rail bus
Ambient temperature	-25 °C...70 °C
Accuracy	<0.05 % of measuring range
Temperature coefficient	≤ 0.01 % / °C
Cut-off frequency (-3 dB)	100 Hz
Power consumption, typ.	0.45 W
Power consumption, max.	0.8 W
Step response time	≤ 7 ms
Insulation coordination	
Insulation voltage	2.5 kV _{eff} / 1 min.
Rated voltage	300 V _{eff}
EMC standards	IEC 61326-1, NE 21
Pollution degree	2
Overvoltage category	II
Approvals	CCCEX; CE; cULus; DETNORVER; FMEX; IECXKEM; KEMAATEX; UKEX

Dimensions	
Clamping range (nominal / min. / max.)	mm ²
Depth x width x height	mm
Note	

Ordering data

Screw connection without mounting rail bus supply	ACT20M-CI-2CO-X-S	1	2825080000
PUSH IN connection without mounting rail bus supply	ACT20M-CI-2CO-X-P	1	2825210000
Screw connection with mounting rail bus supply	ACT20M-CI-2CO-S	1	1175990000
PUSH IN connection with mounting rail bus supply	ACT20M-CI-2CO-P	1	2825400000

Note

Screw connection	PUSH IN
2.5 / 0.5 / 2.5	2.5 / 0.5 / 2.5
114.3 / 6.1 / 112.5	
Power supply optionally over the DIN mounting rail CH20M	

Type	Qty.	Order No.
ACT20M-CI-2CO-X-S	1	2825080000
ACT20M-CI-2CO-X-P	1	2825210000
ACT20M-CI-2CO-S	1	1175990000
ACT20M-CI-2CO-P	1	2825400000

Electrical connections

Terminal	ACT20M-CI-2CO-S			
	Input mA	Power Supply	Output 1 mA	Output 2 mA
1				□
2				■
3	□			
4	■			
5			■	
6			□	
7		■		
8		□		

■ = +
□ = -

Isolation amplifier

Isolating amplifier for standard signals

- Input for current/voltage source
- Sensor supply
- Output current/voltage source
- 3-way isolation
- Configuration via DIP switches
- Supply possible via the mounting rail bus

ACT20M-AI-AO-E

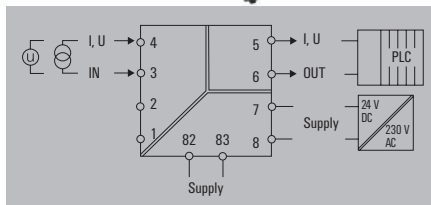
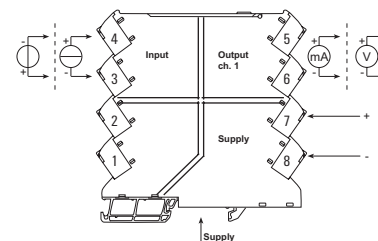

Technical data

Input	
Sensor	
Input current	
Input voltage	
Input resistance, voltage	
Voltage drop, current input	
Output	
Output current	
Output voltage	
Load impedance current	
load impedance voltage	
General data	
Configuration	
Voltage supply	
Ambient temperature	
Accuracy	
Temperature coefficient	
Cut-off frequency (-3 dB)	
Power consumption, typ.	
Power consumption, max.	
Step response time	
Insulation coordination	
Insulation voltage	
Rated voltage	
EMC standards	
Pollution degree	
Overtoltage category	
Approvals	

Voltage source, Current source
configurable, 0(4)...20 mA
configurable, 0(2)...10 V, 0(1)...5 V
>500 kΩ
<1,5 V
configurable, 0...20 mA, 4...20 mA
configurable, 0(2)...10 V, 0(1)...5 V
≤ 600 Ω, @ max 23mA
≥ 10 kΩ
DIP switch
24 V DC ± 30 %
0 °C...70 °C
<0.2 % of measuring range
≤ 0.015 % / °C
100 Hz
0.56 W
0.8 W
≤ 7 ms
2.5 kV _{eff} / 1 min.
300 V _{eff}
IEC 61326-1, NE 21
2
II

Dimensions	
Clamping range (nominal / min. / max.)	mm ²
Depth x width x height	mm
Note	

Screw connection	PUSH IN
2.5 / 0.5 / 2.5	2.5 / 0.5 / 2.5
114.3 / 6.1 / 112.5	114.3 / 6.1 / 112.5
Power supply optionally over the DIN mounting rail CH20M	

Ordering data

Type	Qty.	Order No.
Screw connection without mounting rail bus supply	1	2825040000
PUSH IN connection without mounting rail bus supply	1	2825170000
Screw connection with mounting rail bus supply	1	1176010000
PUSH IN connection with mounting rail bus supply	1	2825360000

Type	Qty.	Order No.
ACT20M-AI-AO-E-X-S	1	2825040000
ACT20M-AI-AO-E-X-P	1	2825170000
ACT20M-AI-AO-E-S	1	1176010000
ACT20M-AI-AO-E-P	1	2825360000

Note

Electrical connections

Terminal	ACT20M-AI-AO-E-S				
	Input		Power supply	Output 1	
	V	mA		V	mA
1					
2					
3	■	□			
4	□	■			
5				■	■
6				□	□
7			■		
8			□		

■ = +
□ = -

DIP switch settings

Range	Input				Output					
	1	2	3	4	5	6	7	8	9	10
0 ... 20 mA	□	□	□	□	□	□	□	□	□	□
4 ... 20 mA	□	■	□	□	■	□	□	□	□	□
0 ... 10 V	■	□	□	□	■	□	□	□	□	□
2 ... 10 V	■	□	□	□	■	□	□	□	□	□
0 ... 5 V	■	□	■	■	□	■	■	■	■	■
1 ... 5 V	■	■	■	■	■	■	■	■	■	■

■ = on
□ = off

Isolation amplifier, bipolar

- Input for bipolar current/voltage source
- Output current/voltage source
- 3-way isolation
- Configuration via DIP switches
- Supply possible via the mounting rail bus

ACT20M-BAI-AO

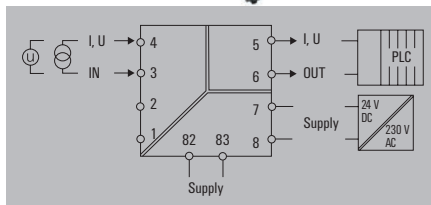
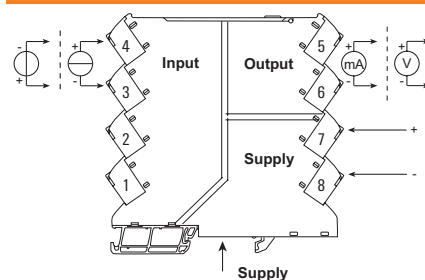

Technical data

Input	
Sensor	
Input current	
Input voltage	
Output	
Output current	
Output voltage	
Load impedance current	
load impedance voltage	
General data	
Configuration	
Voltage supply	
Ambient temperature	
Storage temperature	
Accuracy	
Temperature coefficient	
Cut-off frequency (-3 dB)	
Insulation coordination	
Insulation voltage	
Rated voltage	
EMC standards	
Pollution degree	
Overvoltage category	
Approvals	
Approvals	

Input	
Voltage source, Current source	
configurable, -10 mA...0...+10 mA, -20 mA...0...+20 mA	
configurable, -5 V...0...+5 V, -10 V...0...+10 V	
Output	
configurable, 0...20 mA, 4...20 mA	
configurable, 0(2)...10 V, 0(1)...5 V	
≤ 600 Ω	
≥ 10 kΩ	
General data	
DIP switch	
24 V DC ±30 % at terminal or via CH20M rail bus	
-25 °C...70 °C	
-40 °C...85 °C	
<0.05 % of measuring range	
<0.01 % of span/°C (TU)	
≥ 100 Hz, 10 Hz	
Insulation coordination	
2.5 kV _{eff} /1 min.	
300 V _{eff}	
IEC 61326-1, NE 21	
2	
II	
Approvals	
CCCEX; cULus; DETNORVER; FMEX; IECEXKEM; KEMAATEX; UKEX	

Dimensions	
Clamping range (nominal / min. / max.)	mm ²
Depth x width x height	mm
Note	

Screw connection	
2.5 / 0.5 / 2.5	
114.3 / 6.1 / 112.5	
Power supply optionally via mounting rail bus CH20M	

Ordering data

Screw connection with mounting rail bus supply	
--	--

Type	Qty.	Order No.
ACT20M-BAI-AO-S	1	1375450000

Note

Electrical connections

Terminal	ACT20M-BAI-AO-S				
	Input		Power supply	Output 1	
	V	mA		V	mA
1					
2					
3	■	□			
4	□	■			
5				■	■
6				□	□
7			■		
8			□		

■ = +
□ = -

DIP switch settings

Range	Bandwidth	Input				Output					
		1	2	3	4	5	6	7	8	9	10
10 Hz		■									
100 Hz		□									
-10...+10 mA			■	■	■						
-20...+20 mA			■	■	□						
-5...+5 V			□	□	■						
-10...+10 V			□	□	□						
0...20 mA						□	□	□			
4...20 mA						□	■	□			
0...10 V						■	□	□			
2...10 V						■	■	□			
0...5 V						■	□	■			
1...5 V						■	■	■			
±20 mA set-up											
±10 mA set-up											

■ = on
□ = off

Isolation amplifier

Isolation amplifier, bipolar,

- Isolation and conversion of bipolar DC signals
- Splitting into standard signal or bipolar output
- Configuration via DIP switches
- Supply possible via the mounting rail bus
- 4-way isolation

ACT20M-BAI-2A0

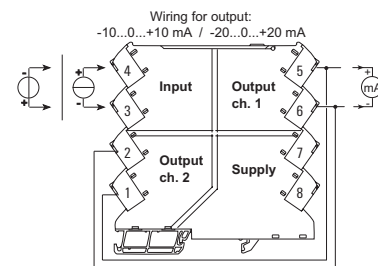
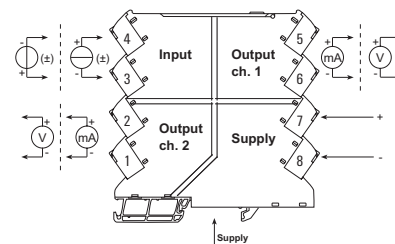
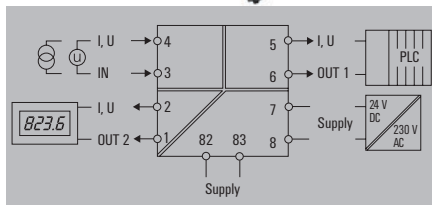

Technical data

Input	
Sensor	
Number of inputs	1
Input current	configurable, -10 mA...0...+10 mA, -20 mA...0...+20 mA
Input voltage	configurable, -5 V...+5 V, -10 V...0...+10 V
Output	
Number of outputs	2
Output current	configurable, 0...20 mA, 4...20 mA, 1 channel -10...0...+10 mA, 1 channel -20...0...+20 mA
Output voltage	configurable, 0(2)...10 V, 0(1)...5 V
Load impedance current	<300 Ω, per channel
load impedance voltage	≥ 10 kΩ
General data	
Voltage supply	24 V DC ±30 % at terminal or via CH20M rail bus
Ambient temperature	-25 °C...70 °C
Storage temperature	-40 °C...85 °C
Accuracy	<0.05 % of measuring range
Temperature coefficient	<0.01 % of span/°C (TU)
Cut-off frequency (-3 dB)	≥ 100 Hz, 10 Hz
Insulation coordination	
Insulation voltage	2.5 kV _{eff} / 1 min.
Rated voltage	300 V _{eff}
EMC standards	IEC 61326-1, NE 21
Pollution degree	2
Overvoltage category	II
Approvals	
Approvals	CCCEX; cULus; DETNORVER; FMEX; IECExKEM; KEMAATEX; UKEX
Dimensions	
Clamping range (nominal / min. / max.)	mm ²
Depth x width x height	mm
Note	

Input		Power supply		Output 1		Output 2	
Terminal	Input	Power supply	Output 1	Output 2	Terminal	Input	Power supply
	V	mA	V	mA	V	mA	V
1							
2					■	■	
3	■	□					
4	□	■					
5			■	■			
6			□	□			
7					■		
8					□		
■ = +							
□ = -							

Electrical connections

Terminal	ACT20M-BAI-2A0-S							
	Input		Power supply	Output 1		Output 2		
	V	mA		V	mA	V	mA	
1							□	□
2							■	■
3	■	□						
4	□	■						
5			■	■				
6			□	□				
7					■			
8					□			
■ = +								
□ = -								

DIP switch settings

Range	Bandwidth	Input				Output 1				Output 2	
		1	2	3	4	5	6	7	8	9	10
10 Hz		■									
100 Hz		□									
-10...+10 mA			■	■	■						
-20...+20 mA			■	■	□						
-5...+5 V			□	□	■						
-10...+10 V			□	□	□						
0...20 mA						□	□	□	□	□	□
4...20 mA						□	■	□	□	■	□
0...10 V						■	□	□	■	□	□
2...10 V						■	□	□	■	□	□
0...5 V						■	□	□	■	□	■
1...5 V						■	■	■	■	■	■
±20 mA set-up						□	□	■	□	□	■
±10 mA set-up						□	■	■	□	■	■
■ = on											
□ = off											

Ordering data

Type	Qty.	Order No.
Screw connection without mounting rail bus supply	1	2825060000
Screw connection with mounting rail bus supply	1	1375470000

Type	Qty.	Order No.
ACT20M-BAI-2A0-X-S	1	2825060000
ACT20M-BAI-2A0-S	1	1375470000

Note

Passive isolator, input loop powered

- Isolation of DC signals without additional voltage supply
- Supply from the input measuring circuit
- Optionally available as a 1-channel / 2-channel version
- 2-way isolation

ACT20M-CI-CO-ILP

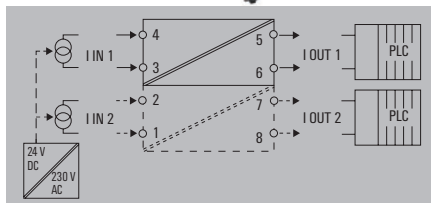
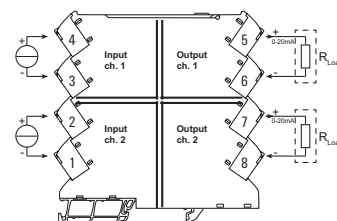

Technical data

Input	
Sensor	
Voltage drop, current input	
Input current	
Output	
Output current	
Load impedance current	
General data	
Configuration	none
Ambient temperature	-25 °C...70 °C
Accuracy	<0.1 % of measuring range
Temperature coefficient	≤ 0.01 % / °C
Cut-off frequency (-3 dB)	100 Hz
Power consumption	30 mW
Voltage supply	Loop powered, via 4...20 mA input
Step response time	≤ 5 ms
Insulation coordination	
Insulation voltage	2.5 kV _{eff} / 1 min.
Rated voltage	300 V _{eff}
EMC standards	IEC 61326-1, NE 21
Pollution degree	2
Overvoltage category	II
Approvals	CCCEX; cULus; DETNORVER; FMEX; IECEXKEM; KEMAATEX; UKEX

Current source	
1.25 V + 0.015 V _{reg} @25°C	
0...20 mA, 4...20mA	
Output	
0...20 mA, 4...20 mA	
≤ 600 Ω, @ max 23mA	
General data	
Configuration	none
Ambient temperature	-25 °C...70 °C
Accuracy	<0.1 % of measuring range
Temperature coefficient	≤ 0.01 % / °C
Cut-off frequency (-3 dB)	100 Hz
Power consumption	30 mW
Voltage supply	Loop powered, via 4...20 mA input
Step response time	≤ 5 ms
Insulation coordination	
Insulation voltage	2.5 kV _{eff} / 1 min.
Rated voltage	300 V _{eff}
EMC standards	IEC 61326-1, NE 21
Pollution degree	2
Overvoltage category	II
Approvals	CCCEX; cULus; DETNORVER; FMEX; IECEXKEM; KEMAATEX; UKEX

Dimensions	
Clamping range (nominal / min. / max.)	mm ²
Depth x width x height	mm
Note	

Screw connection		PUSH IN	
2.5 / 0.5 / 2.5		2.5 / 0.5 / 2.5	
114.3 / 6.1 / 112.5		114.3 / 6.1 / 112.5	
Power supply optionally over the DIN mounting rail CH20M			

Ordering data

	Screw connection, 1 channel
	PUSH IN connection, 1 channel
	Screw connection, 2 channel
	PUSH IN connection, 2 channel

Type	Qty.	Order No.
ACT20M-CI-CO-ILP-S	1	1176070000
ACT20M-CI-CO-ILP-P	1	2825220000
ACT20M-2CI-2CO-ILP-S	1	1176080000
ACT20M-2CI-2CO-ILP-P	1	2825140000

Note

Electrical connections

Terminal	ACT20M-CI-2CO-S			
	Input 1	Output 1	Input 2	Output 2
	mA	mA	mA	mA
1			□	
2			■	
3	□			
4	■			
5		■		
6		□		
7				■
8				□

Electrical connections

Terminal	ACT20M-CI-CO-ILP-S	
	Input 1	Output 1
	mA	mA
1		
2		
3	□	
4	■	
5		■
6		□
7		
8		

■ = +
□ = -

Passive isolator

Passive isolator, output loop powered

- Disconnection of DC signals without additional power supply
- Supply from the output measuring circuit
- Optionally available as 1-channel / 2-channel version
- 2-way isolation
- For sensors with own power supply

ACT20M-CI-CO-OLP2

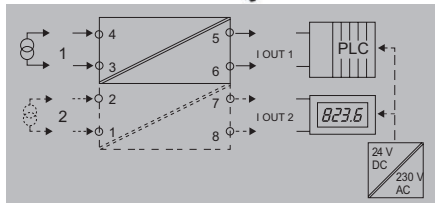
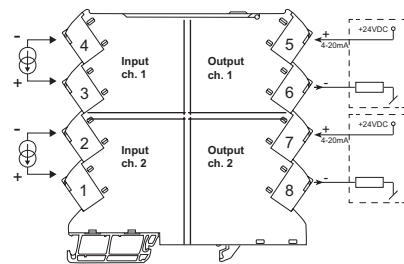

D

Technical data

Input
Sensor
Input current
Output
Output current
General data
Configuration
Accuracy
Voltage supply
Power consumption, typ.
Galvanic isolation
Step response time
Insulation coordination
Insulation voltage
Rated voltage
EMC standards
Pollution degree
Overvoltage category
Approvals
Approvals

4-wire sensor (with own power supply)
4...20 mA
4...20 mA
none
<0.05 % of measuring range
Output loop powered
50 mW
2-way isolator
≤ 5 ms
2.5 kV _{eff} / 1 min.
300 V _{eff}
IEC 61326-1, NE 21
2
II

Dimensions	
Clamping range (nominal / min. / max.)	mm ²
Depth / Width / Height	mm
Note	

Screw connection	PUSH IN
2.5 / 0.5 / 2.5	2.5 / 0.5 / 2.5
114.3 / 61 / 112.5	114.3 / 61 / 112.5

Ordering data

Screw connection, 1 channel
PUSH IN connection, 1 channel
Screw connection, 2 channel
PUSH IN connection, 2 channel

Type	Qty.	Order No.
ACT20M-CI-CO-OLP2-S	1	2825000000
ACT20M-CI-CO-OLP2-P	1	2825320000
ACT20M-2CI-2CO-OLP2-S	1	2825010000
ACT20M-2CI-2CO-OLP2-P	1	2825330000

Note

Passive isolator with sensor supply, output loop powered

- Isolation of DC signals without additional voltage supply
- Supply from the output measurement circuit
- Optionally available as a 1-channel / 2-channel version
- 2-way isolation
- For sensors without own power supply
- 2-way separation

ACT20M-CI-CO-OLP

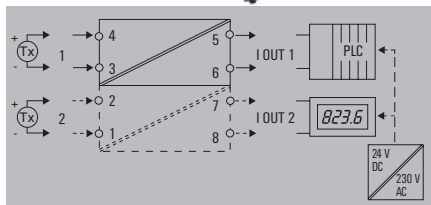
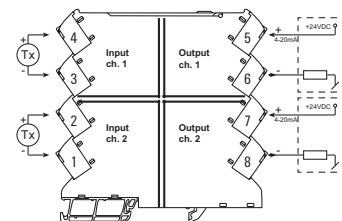

Technical data

Input	
Sensor	
Sensor supply	
Voltage drop, current input	
Input current	
Output	
Output current	
General data	
Configuration	
Ambient temperature	
Accuracy	
Temperature coefficient	
Cut-off frequency (-3 dB)	
Power consumption, max.	
Voltage supply	
Step response time	
Insulation coordination	
Insulation voltage	
Rated voltage	
EMC standards	
Pollution degree	
Overvoltage category	
Approvals	

2-wire transmitter (without own power supply)
6...35 V (@ 20 mA)
Typical 2.5 V
4...20mA
4...20 mA
none
-25 °C...70 °C
<0.05 % of measuring range
≤±0.02 µA x (Δ °C x V _{supply}) @ Tamb > 25 °C
100 Hz
50 mW
Output loop powered
≤ 5 ms
2.5 kV _{eff} / 1 min.
300 V _{eff}
IEC 61326-1, NE 21
2
II
CCCEX; cULus; DETNORVER; FMEEX; IECEXKEM; KEMAATEX; UKEX

Dimensions	
Clamping range (nominal / min. / max.)	mm ²
Depth x width x height	mm
Note	

Screw connection	PUSH IN
2.5 / 0.5 / 2.5	2.5 / 0.5 / 2.5
114.3 / 6.1 / 112.5	114.3 / 6.1 / 112.5
Power supply optionally over the DIN mounting rail CH20M	

Ordering data

Screw connection, 1 channel
PUSH IN connection, 1 channel
Screw connection, 2 channel
PUSH IN connection, 2 channel

Type	Qty.	Order No.
ACT20M-CI-CO-OLP-S	1	1176040000
ACT20M-CI-CO-OLP-P	1	2825230000
ACT20M-2CI-2CO-OLP-S	1	1176050000
ACT20M-2CI-2CO-OLP-P	1	2825150000

Note

Electrical connections

Terminal	ACT20M-2CI-2CO-OLP-S			
	Input 1	Output 1	Input 2	Output 2
	mA	mA	mA	mA
1			□	
2			■	
3	□			
4	■			
5		■		
6		□		
7				■
8				□

Electrical connections

Terminal	ACT20M-CI-CO-OLP-S	
	Input 1	Output 1
	mA	mA
1		
2		
3	□	
4	■	
5		■
6		□
7		
8		

■ = +
□ = -

Temperature transducer

Temperature transducer, output loop powered

- Isolation and conversion of temperature signals, (RTD and thermocouple)
- Configuration via DIP switches
- Power supply via the output circuit
- 2-way isolation

ACT20M-RTCI-CO-OLP

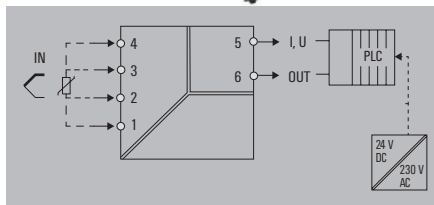
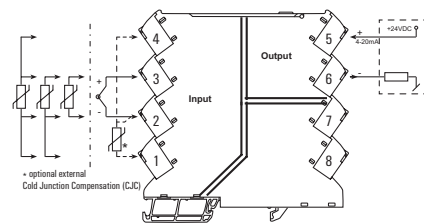

Technical data

Input	Sensor Temperature input range
Output	Output current Sensor error detection
General data	Configuration Voltage supply Power consumption, max. Storage temperature Accuracy
	Galvanic isolation Step response time Ambient temperature
Insulation coordination	Insulation voltage Rated voltage EMC standards Pollution degree Overvoltage category
Approvals	Approvals

PT100 (2-/3-/4- wire), Thermocouples: J, K
Configurable, PT100: -200...+850 °C, min. measurement range 10°C (RTD), J: (-100...+1200 °C), K: (-180...+1372 °C), min. measurement range 50°C (TC)
configurable, 4...20 mA, 20...4 mA
Yes, Configurable, 3.5 mA / 23 mA / none
DIP switch
Output loop powered, 6...35 V
0.8 W
-40 °C...85 °C
absolute accuracy: $\leq \pm 0.05\%$ of the measurement range, RTD (PT100) Basic accuracy: $\leq \pm 0.1\%$ of the measurement range, TC (J,K) Basic accuracy: $\leq \pm 0.5\%$ of the measurement range
2-way isolator
Configurable, ≤ 30 ms, ≤ 300 ms
-25 °C...+70 °C
2.5 kV _{eff} / 1 min.
300 V _{eff}
IEC 61326-1, NE 21
2
II
cULus; DETNORVER; FMEX; IECEXKEM; KEMAATEX; UKEX

Dimensions	Clamping range (nominal / min. / max.) Depth x width x height	mm ² mm
Note		

Screw connection	PUSH IN
2.5 / 0.5 / 2.5	2.5 / 0.5 / 2.5
114.3 / 6.1 / 112.5	114.3 / 6.1 / 112.5

Ordering data

	Screw connection
	PUSH IN connection

Type	Qty.	Order No.
ACT20M-RTCI-CO-OLP-S	1	1435590000
ACT20M-RTCI-CO-OLP-P	1	2825250000

Note	
-------------	--

Accessories

Note	
-------------	--

DIN mounting rail, see accessories

Electrical connections

Terminal	ACT20M-RTCI-CO-OLP-S				
	Input				Output 1
	2 wire	3 wire	4 wire	TC	mA
1		Sense-	Sense-	CJC+*	
2	R	R-	R-	TC/CJC*	
3	R	R+	R+	TC+	
4			Sense+	CJC*	
5					■
6					□
7					
8					

* optional

■ = +

□ = -

Configuration

Temp.	Temperature range [°C]										
	Pt100: -200...+850 °C // TC J: -100...+1200 °C					TC K: -180...+1372 °C					
	Min.	S2	Max.	S2	Max.	S2	Min.	S2	Max.	S2	
-200			0							170	
-180			5							180	
-150			10							190	
-100			15							200	
-50			20							225	
-25			25							250	
-10			30							275	
-5			35							300	
0			40							325	
5			45							350	
10			50							375	
20			55							400	
25			60							450	
50			65							500	
100			70							550	
200			75							600	
			80							650	
			85							700	
			90							750	
			95							800	
			100							850	
			105							900	
			110							950	
			115							1000	
			120							1050	
			125							1100	
			130							1150	
			135							1200	
			140							1250	
			145							1300	
			150							1350	
			160							1372	

■ = On

Temperature transducer, output loop powered

- Conversion of temperature signals, RTD
- Configuration via DIP switches
- Power supply via the output circuit
- Without galvanic isolation

ACT20M-RTI-CO-EOLP

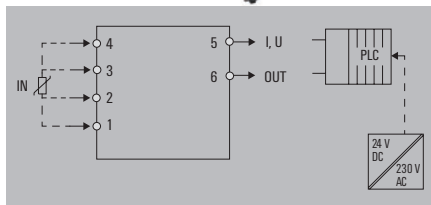
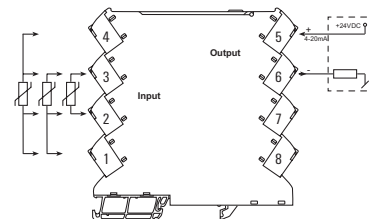

Technical data

Input
Sensor
Temperature input range
Output
Output current
Sensor error detection
General data
Configuration
Voltage supply
Power consumption, max.
Storage temperature
Accuracy
Galvanic isolation
Step response time
Ambient temperature
EMC standards
Approvals
Approvals

PT100 (2-/3-/4- wire)
Configurable, PT100: -200...+850 °C, min. measurement range 10°C (RTD)
4...20 mA, loop-powered
Yes, Configurable, 3.5 mA / 23 mA / none
DIP switch
Output loop powered, 6...35 V
0.8 W
-40 °C...85 °C
absolute accuracy: $\leq \pm 0.1\%$ of the measurement range, Basic accuracy: $\leq \pm 0.2^\circ\text{C}$
Without isolation
Configurable, ≤ 30 ms, ≤ 300 ms
-25 °C...+70 °C
IEC 61326-1, NE 21
cULus; DETNORVER; FMEx; IECExKEM; KEMAATEX; UKEX

Electrical connections

Terminal	ACT20M-RTCI-CO-OPLS			
	Input			Output 1
	RTD			mA
	2 wire	3 wire	4 wire	
1		Sense-	Sense-	
2	R	R-	R-	
3	R	R+	R+	
4		Sense+		
5				■
6				□
7				
8				

* optional

■ = +

□ = -

Configuration

Temp.	Temperature range [°C]									
	Pt100: -200...+850 °C // TC J: -100...+1200 °C					TC K: -180...+1372 °C				
Min.	S2	Max.	S2	Max.	S2	Min.	S2	Max.	S2	
-200		0				170	■			
-180	■	5				180	■		■	
-150	■	10			■	190	■		■	
-100	■	15			■	200	■		■	
-50	■	20			■	225	■		■	
-25	■	25			■	250	■		■	
-10	■	30			■	275	■		■	
-5	■	35			■	300	■		■	
0	■	40			■	325	■		■	
5	■	45			■	350	■		■	
10	■	50			■	375	■		■	
20	■	55			■	400	■		■	
25	■	60			■	450	■		■	
50	■	65			■	500	■		■	
100	■	70			■	550	■		■	
200	■	75			■	600	■		■	
		80			■	650	■		■	
		85			■	700	■		■	
		90			■	750	■		■	
		95			■	800	■		■	
		100			■	850	■		■	
		105			■					
		110			■					
		115			■					
		120			■					
		125			■					
		130			■					
		135			■					
		140			■					
		145			■					
		150			■					
		160			■					

■ = 0n

Dimensions	
Clamping range (nominal / min. / max.)	mm ²
Depth x width x height	mm
Note	

DimensionsScrew connection	DimensionsPUSH IN
2.5 / 0.5 / 2.5	2.5 / 0.5 / 2.5
114.3 / 6.1 / 112.5	114.3 / 6.1 / 112.5

Ordering data

	Screw connection
	PUSH IN connection

Type	Qty.	Order No.
ACT20M-RTI-CO-EOLP-S	1	1435610000
ACT20M-RTI-CO-EOLP-P	1	2825280000

Note

Accessories

Note

Note

DIN mounting rail, see accessories

Temperature transducer

Temperature transducer, with HART®-function

- Conversion of temperature signals
- Configuration via DIP switch or HART®
- HART® read/write capability
- Supply also possible via mounting rail bus
- 3-way isolation

ACT20M-RTCI-CO-H

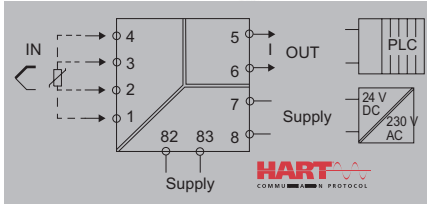
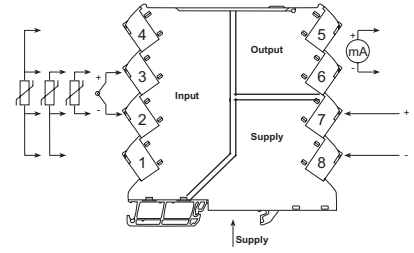

Technical data

Input
Sensor
Temperature input range
Output
Output current
General data
Configuration
Accuracy
Voltage supply
Power consumption, typ.
Galvanic isolation
Step response time
Insulation coordination
Insulation voltage
Rated voltage
EMC standards
Pollution degree
Overtoltage category
Approvals
Approvals

PT100 (2-/3-/4- wire), Thermocouples: J, K
Configurable, PT100: -200...+850 °C, min. measurement range 10°C (RTD), J: (-100...+1200 °C), K: (-180...+1372 °C), min. measurement range 50°C (TC)
configurable, 4...20 mA, 20...4 mA
DIP switch, or with HART®
<0.05 % of measuring range
24 V DC ±30 % at terminal or via CH20M rail bus
0.5 W
3-way isolator
Configurable, ≤ 30 ms, <300 ms
2.5 kV _{eff} / 1 min.
300 V _{eff}
IEC 61326-1, NE 21
2
II

Dimensions	
Clamping range (nominal / min. / max.)	mm ²
Depth / Width / Height	mm
Note	

Screw connection	PUSH IN
2.5 / 0.5 / 2.5	2.5 / 0.5 / 2.5
114.3 / 6.1 /	114.3 / 6.1 /

Ordering data

Screw connection without mounting rail bus supply
PUSH IN connection without mounting rail bus supply
Screw connection with mounting rail bus supply
PUSH IN connection with mounting rail bus supply

Type	Qty.	Order No.
ACT20M-RTCI-CO-H-X-S	1	2830500000
ACT20M-RTCI-CO-H-X-P	1	2830510000
ACT20M-RTCI-CO-H-S	1	2830480000
ACT20M-RTCI-CO-H-P	1	2830490000

Note

CBX200 USB 8978580000 Mounting rail bus see accessories

Temperature transducer, with HART®- function, output loop powered

- Conversion of temperature signals, (RTD)
- Configuration via DIP switch or HART®
- HART® read / write capability
- Supply via output loop
- 2-way isolation

ACT20M-RTCI-CO-HOLP

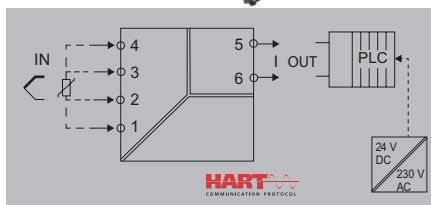
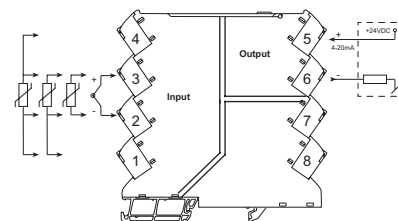

Technical data

Input
Sensor
Temperature input range
Output
Output current
General data
Configuration
Accuracy
Voltage supply
Power consumption, typ.
Galvanic isolation
Step response time
Insulation coordination
Insulation voltage
Rated voltage
EMC standards
Pollution degree
Overvoltage category
Approvals
Approvals

PT100 (2-/3-/4- wire), Thermocouples: J, K
PT100: -200...+850 °C, J: (-100...+1200 °C), K: (-180...+1372 °C)
4...20 mA, loop-powered
DIP switch, or with HART®
<0.05 % of measuring range
Output loop powered, 6...35 V
0.8 W
2-way isolator
Configurable, ≤ 30 ms, <300 ms
2.5 kV _{eff} / 1 min.
300 V _{eff}
IEC 61326-1, NE 21
2
II

Dimensions	
Clamping range (nominal / min. / max.)	mm ²
Depth / Width / Height	mm
Note	

Screw connection	PUSH IN
2.5 / 0.5 / 2.5	2.5 / 0.5 / 2.5
114.3 / 6.1 / 112.5	114.3 / 6.1 / 112.5

Ordering data

	Screw connection
	PUSH IN connection

Type	Qty.	Order No.
ACT20M-RTCI-CO-HOLP-S	1	2830460000
ACT20M-RTCI-CO-HOLP-P	1	2830470000

Note

Accessories

Note

CBX200 USB 8978580000

Temperature transducer

Temperature transducer, RTD

- For resistance thermometers (RTD)
- Configuration via DIP switches
- Supply possible via the mounting rail bus
- 3-way isolation

ACT20M-RTI-AO

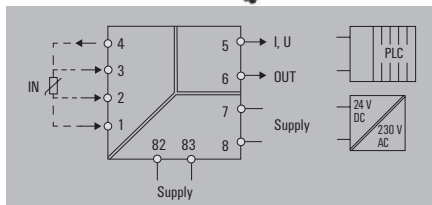
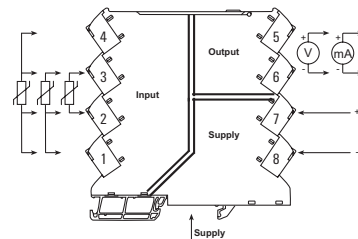

Technical data

Input	
Sensor	PT100 (2-/3-/4- wire)
Temperature input range	Configurable, PT100: -200...+850 °C, min. measurement range 10°C (RTD)
Output	
Output current	configurable, 0...20 mA, 4...20 mA
Output voltage	configurable, 0(2)...10 V, 0(1)...5 V
Load impedance current	≤ 600 Ω
load impedance voltage	≥ 10 kΩ
Sensor error detection	Yes, Configurable, 3.5 mA / 23 mA / none
General data	
Configuration	DIP switch
Voltage supply	24 V DC ±30 % at terminal or via CH20M rail bus
Power consumption, max.	0.7 W
Accuracy	absolute accuracy: <±0.05 % of the measurement range, Basic accuracy: <±0.1°C
Galvanic isolation	3-way isolator
Temperature coefficient	≤0.01 % of the measurement range/°C or 0.02 °C/°C
Step response time	Configurable, ≤ 30 ms, <300 ms
Ambient temperature	-20 °C...+70 °C
Insulation coordination	
Insulation voltage	2.5 kV _{eff} / 1 min.
Rated voltage	300 V _{eff}
EMC standards	IEC 61326-1, NE 21
Pollution degree	2
Overvoltage category	II
Approvals	
Approvals	cULus; DETNORVER; FMEx; IECEXKEM; KEMAATEX; UKEX

Dimensions	
Clamping range (nominal / min. / max.)	mm ²
Depth x width x height	mm
Note	

Ordering data

Type	Qty.	Order No.
Screw connection without mounting rail bus supply	1	2825100000
PUSH IN connection without mounting rail bus supply	1	2825270000
Screw connection with mounting rail bus supply	1	1375510000
PUSH IN connection with mounting rail bus supply	1	2825420000
Note		
DIN mounting rail, see accessories		

Screw connection		PUSH IN	
2.5 / 0.5 / 2.5	114.3 / 6.1 / 112.5	2.5 / 0.5 / 2.5	114.3 / 6.1 / 112.5

Screw connection		PUSH IN	
2.5 / 0.5 / 2.5	114.3 / 6.1 / 112.5	2.5 / 0.5 / 2.5	114.3 / 6.1 / 112.5

Type	Qty.	Order No.
ACT20M-RTI-AO-X-S	1	2825100000
ACT20M-RTI-AO-X-P	1	2825270000
ACT20M-RTI-AO-S	1	1375510000
ACT20M-RTI-AO-P	1	2825420000

Electrical connections

Terminal	ACT20M-RTI-AO-S					
	Input			Power supply	Output 1	
	RTD				V	mA
	2 wire	3 wire	4 wire			
1		Sense-	Sense-			
2	R	R-	R-			
3	R	R+	R+			
4		Sense+				
5					■	■
6					□	□
7				■		
8					□	

■ = +
□ = -

Configuration

Temperature range [°C]																		
Pt100: -200...+850 °C																		
Min.	S2				Max.	S2				Max.	S2							
Temp.	1	2	3	4	Temp.	5	6	7	8	9	10	Temp.	5	6	7	8	9	10
-200					0							170						
-180				■	5							180						■
-150			■		10							190						■
-100			■	■	15							200						■
-50			■	■	20							225						■
-25			■	■	25							250						■
-10			■	■	30							275						■
-5			■	■	35							300						■
0		■			40							325						■
5		■			45							350						■
10		■			50							375						■
20		■			55							400						■
25		■			60							450						■
50		■			65							500						■
100		■			70							550						■
200		■			75							600						■
					80							650						■
					85							700						■
					90							750						■
					95							800						■
					100							850						■
					105													■
					110													■
					115													■
					120													■
					125													■
					130													■
					135													■
					140													■
					145													■
					150													■
					160													■

■ = On

Temperature transducer, RTD

- For resistance thermometers (RTD)
- Configuration via DIP switches
- No galvanic isolation

ACT-20M-RTI-A0-E

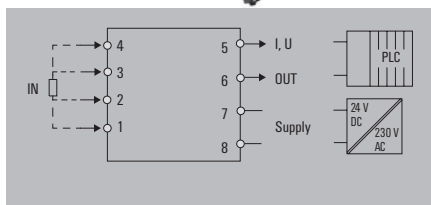
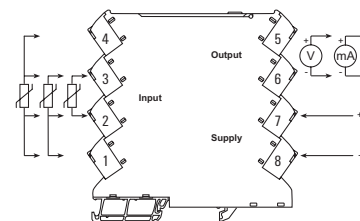

Technical data

Input

Sensor
Temperature input range

Output

Output current
Output voltage
Load impedance current
load impedance voltage
Sensor error detection

General data

Configuration
Voltage supply
Power consumption, max.
Accuracy
Galvanic isolation
Temperature coefficient
Step response time
Ambient temperature
EMC standards

Approvals

Approvals

PT100 (2-/3-/4- wire)

Configurable, PT100: -200...+850 °C, min. measurement range 10°C (RTD)

configurable, 0...20 mA, 4...20 mA

configurable, 0(2)...10 V, 0(1)...5 V

≤ 600 Ω

≥ 10 kΩ

Yes, Configurable, 3.5 mA / 23 mA / none

DIP switch

24 V DC ± 30 %

0.5 W

absolute accuracy: $\leq \pm 0.1\%$ of the measurement range

Without isolation

$\leq 0.01\%$ of the measurement range/°C or 0.02 °C/°C

Configurable, ≤ 30 ms, <math>< 300</math> ms

-25 °C...+70 °C

IEC 61326-1, NE 21

cULus; DETNORVER; FMEX; IECEKEM; KEMAATEX; UKEX

Dimensions

Clamping range (nominal / min. / max.) mm²
Depth x width x height mm

Note

Ordering data

Screw connection
PUSH IN connection

Note

Accessories

Note

Screw connection

2.5 / 0.5 / 2.5
114.3 / 6.1 / 112.5

PUSH IN

2.5 / 0.5 / 2.5
114.3 / 6.1 / 112.5

Type	Qty.	Order No.
ACT20M-RTI-A0-E-S	1	1375520000
ACT20M-RTI-A0-E-P	1	2825260000

DIN mounting rail, see accessories

Electrical connections

Terminal	ACT20M-RTI-A0-E-S					
	Input			Power supply	Output 1	
	RTD				V	mA
	2 wire	3 wire	4 wire			
1		Sense-	Sense-			
2	R	R-	R-			
3	R	R+	R+			
4		Sense+				
5					■	■
6					□	□
7				■		
8					□	

■ = +
□ = -

Configuration

Temp.	Temperature range [°C]									
	Pt100: -200...+850 °C									
	Min.	S2	Max.	S2	Max.	S2	Max.	S2	Max.	S2
-200			0				170			
-180		■	5			■	180			■
-150		■	10			■	190			■
-100		■	15			■	200			■
-50		■	20			■	225			■
-25		■	25			■	250			■
-10		■	30			■	275			■
-5		■	35			■	300			■
0		■	40			■	325			■
5		■	45			■	350			■
10		■	50			■	375			■
20		■	55			■	400			■
25		■	60			■	450			■
50		■	65			■	500			■
100		■	70			■	550			■
200		■	75			■	600			■
			80			■	650			■
			85			■	700			■
			90			■	750			■
			95			■	800			■
			100			■	850			■
			105			■				
			110			■				
			115			■				
			120			■				
			125			■				
			130			■				
			135			■				
			140			■				
			145			■				
			150			■				
			160			■				

■ = On

Temperature transducer

Temperature transducer, TC

- For thermocouples (TC)
- Configuration via DIP switches
- Supply possible via the mounting rail bus
- 3-way isolation

ACT20M-TCI-AO

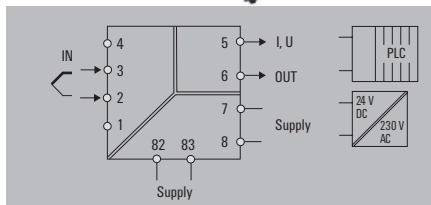
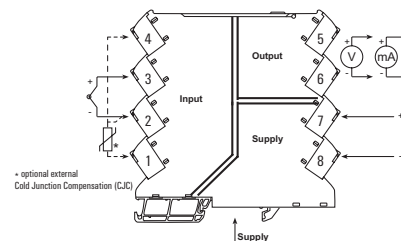

Technical data

Input	
Sensor	Temperature input range
Output	
Output current	Output voltage
Load impedance current	load impedance voltage
Sensor error detection	
General data	
Configuration	Voltage supply
Power consumption, max.	Accuracy
Galvanic isolation	Temperature coefficient
Step response time	Ambient temperature
Insulation coordination	
Insulation voltage	Rated voltage
EMC standards	Pollution degree
Overvoltage category	
Approvals	
Approvals	

Thermocouples: J, K
Configurable, J: (-100...+1200 °C), K: (-180...+1372 °C), min. measurement range 50°C (TC)
configurable, 0...20 mA, 4...20 mA
configurable, 0(2)...10 V, 0(1)...5 V
≤ 600 Ω
≥ 10 kΩ
Yes, Configurable, 3.5 mA / 23 mA / none
DIP switch
24 V DC ±30 % at terminal or via CH20M rail bus
0.7 W
absolute accuracy: < ±0.05 % of the measurement range, Basic accuracy: < ±0.5°
3-way isolator
0,1 °C/°C, or, ≤0,01% des Messbereichs°C
Configurable, ≤ 30 ms, < 300 ms
-25 °C...+70 °C
2.5 kV _{eff} / 1 min.
300 V _{eff}
IEC 61326-1, NE 21
2
II
cULus; DETNORVER; FMEx; IECEKEM; KEMAATEX; UKEX

Dimensions	
Clamping range (nominal / min. / max.)	mm ²
Depth x width x height	mm
Note	

Screw connection	PUSH IN
2.5 / 0.5 / 2.5	2.5 / 0.5 / 2.5
114.3 / 6.1 / 112.5	114.3 / 6.1 / 112.5

Ordering data

Screw connection without mounting rail bus supply	
PUSH IN connection without mounting rail bus supply	
Screw connection with mounting rail bus supply	
PUSH IN connection with mounting rail bus supply	

Type	Qty.	Order No.
ACT20M-TCI-AO-X-S	1	2825110000
ACT20M-TCI-AO-X-P	1	2825300000
ACT20M-TCI-AO-S	1	1375480000
ACT20M-TCI-AO-P	1	2825430000

Note

Electrical connections

Terminal	ACT20M-TCI-AO-S		
	Input TC	Power supply	Output 1 V mA
1	CJC+ ^{1,2)}		
2	TC/CJC ^{1,2)}		
3	TC+		
4	CJC ^{1,2)}		
5		■	■
6		□	□
7		■	
8		□	

1) only 2) optional
 ■ = +
 □ = -

Configuration

		Temperature range [°C]																	
		TC J: -100...+1200 °C					TC K: -180...+1372 °C												
Min.	S2	Max.	S2	Max.	S2	Temp.	5	6	7	8	9	10	Temp.	5	6	7	8	9	10
-200		0		170															
-180		5		180															
-150		10		190															
-100		15		200															
-50		20		225															
-25		25		250															
-10		30		275															
-5		35		300															
0		40		325															
5		45		350															
10		50		375															
20		55		400															
25		60		450															
50		65		500															
100		70		550															
200		75		600															
		80		650															
		85		700															
		90		750															
		95		800															
		100		850															
		105		900															
		110		950															
		115		1000															
		120		1050															
		125		1100															
		130		1150															
		135		1200															
		140		1250															
		145		1300															
		150		1350															
		160		1372															

■ = On

Temperature transducer, TC

- For thermocouples (TC)
- Configuration via DIP switches
- Without galvanic isolation

ACT20M-TCI-A0-E

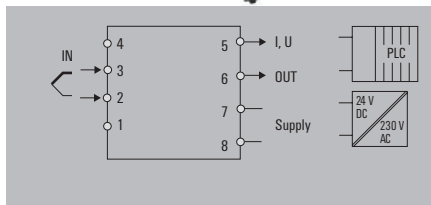
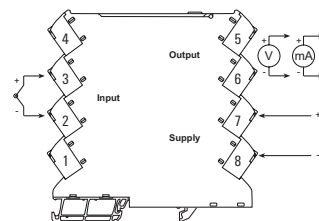

Technical data

Input

Sensor
Temperature input range

Output

Output current
Output voltage
Load impedance current
load impedance voltage
Sensor error detection

General data

Configuration
Voltage supply
Power consumption, max.
Accuracy

Galvanic isolation
Temperature coefficient
Step response time
Ambient temperature
EMC standards

Approvals

Approvals

Thermocouples: J, K

Configurable, J: (-100...+1200 °C), K: (-180...+1372 °C), min. measurement range 50°C (TC)

configurable, 0...20 mA, 4...20 mA

configurable, 0(2)...10 V, 0(1)...5 V

≤ 600 Ω

≥ 10 kΩ

Yes, Configurable, 3.5 mA / 23 mA / none

DIP switch

24 V DC ± 30 %

0.5 W

absolute accuracy: < ±0.1 % of the measurement range, Basic accuracy: < ±1 °C

Without isolation

0,1 °C/°C, or, ≤0,01% des Messbereichs°C

Configurable, ≤ 30 ms, < 300 ms

-25 °C...+70 °C

IEC 61326-1, NE 21

cULus; DETNORVER; FMEX; IECEKEM; KEMAATEX; UKEX

Dimensions

Clamping range (nominal / min. / max.) mm²
Depth x width x height mm

Note

Ordering data

Screw connection
PUSH IN connection

Note

Accessories

Note

Screw connection

2.5 / 0.5 / 2.5
114.3 / 6.1 / 112.5

PUSH IN

2.5 / 0.5 / 2.5
114.3 / 6.1 / 112.5

Type	Qty.	Order No.
ACT20M-TCI-A0-E-S	1	1375500000
ACT20M-TCI-A0-E-P	1	2825290000

DIN mounting rail, see accessories

Electrical connections

Terminal	ACT20M-TCI-A0-E-S			
	Input TC	Power supply	Output 1	
			V	mA
1	CJC+ ^{1,2)}			
2	TC-/CJC- ^{1,2)}			
3	TC+			
4	CJC- ^{1,2)}			
5			■	■
6			□	□
7		■		
8		□		

1) only 2) optional

■ = +

□ = -

Configuration

Temp.	Temperature range [°C]									
	TC J: -100...+1200 °C // TC K: -180...+1372 °C									
	Min.	S2	Max.	S2	Max.	S2	Min.	S2	Max.	S2
-200			0				170			
-180		■	5			■	180			■
-150		■	10			■	190			■
-100		■	15			■	200			■
-50		■	20			■	225			■
-25		■	25			■	250			■
-10		■	30			■	275			■
-5		■	35			■	300			■
0		■	40			■	325			■
5		■	45			■	350			■
10		■	50			■	375			■
20		■	55			■	400			■
25		■	60			■	450			■
50		■	65			■	500			■
100		■	70			■	550			■
200		■	75			■	600			■
			80			■	650			■
			85			■	700			■
			90			■	750			■
			95			■	800			■
			100			■	850			■
			105			■	900			■
			110			■	950			■
			115			■	1000			■
			120			■	1050			■
			125			■	1100			■
			130			■	1150			■
			135			■	1200			■
			140			■	1250			■
			145			■	1300			■
			150			■	1350			■
			160			■	1372			■

■ = On

Universal measuring transducers

Universal measuring transducers

- Isolation and conversion of temperature signals and DC signals
- Configuration using FDT/DTM software
- Supply possible via the mounting rail bus
- 3-way isolation

ACT20M-UI-AO

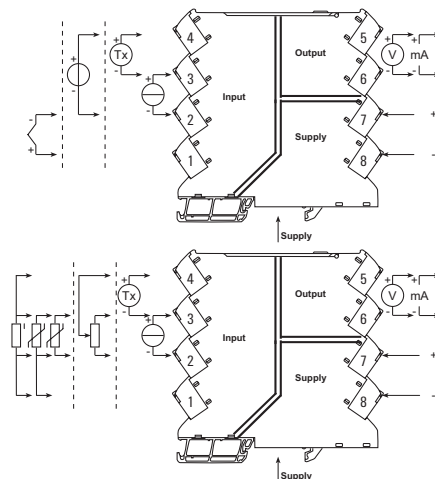
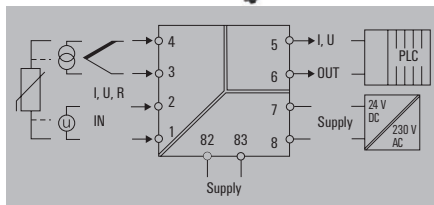

Technical data

Input	
Sensor	
Potentiometer	
Resistance	
Input current	
Input voltage	
Input resistance, voltage	
Voltage drop, current input	
Sensor supply	
Output	
Output current	
Output voltage	
Load impedance current	
load impedance voltage	
General data	
Configuration	
Voltage supply	
Ambient temperature	
Accuracy	
Temperature coefficient	
Power consumption, typ.	
Power consumption, max.	
Step response time	
Insulation coordination	
Insulation voltage	
Rated voltage	
EMC standards	
Pollution degree	
Overvoltage category	
Dimensions	
Clamping range (nominal / min. / max.)	mm ²
Depth x width x height	mm
Note	

Technical data	
Thermocouples: B / C / E / J / K / L / N / R / S / T / W3 / W5 - 200...+ 2300 °C depending on thermocouple, RTD: PT10, PT20, PT50, PT100, PT250, PT300, PT400, PT500, PT1000, Ni50, Ni100, Ni120, Ni1000, 2-/3-/4-wire	
10...100 kΩ	
0...10 kΩ	
configurable, 0...20 mA, 4...20mA	
configurable, 0(2)...10 V, 0(1)...5 V, 0...1 V DC, 0,2...1 V DC	
<3 V	
> 15 V DC at 20 mA	
General data	
configurable, 0...20 mA, 4...20 mA, 20...0 mA, 20...4 mA, downscale (3,5 mA), upscale (23 mA), in case of sensor error	
configurable, 0(2)...10 V, 0(1)...5 V, 0(0,2)...1 V, 1...(0,2)0 V, 5...(1)0 V, 10...(2)0 V, downscale (0 V), upscale (11 V), in case of sensor error	
≤ 600 Ω, @ max 28mA	
≥ 10 kΩ	
Configuration	
With FDT/DTM software, Requires configuration adapter 8978580000 CBX200 USB	
24 V DC ±30 % at terminal or via CH20M rail bus	
-25 °C...70 °C	
<0.1 % of measuring range	
≤ 0.01 % / °C	
0.84 W	
1.2 W	
400 ms (10...90%) @ U/I, 1 s @ temp	
Insulation coordination	
2.5 kV _{eff} / 1 min.	
300 V _{eff}	
IEC 61326-1, NE 21	
2	
II	
Screw connection	
PUSH IN	
2.5 / 0.5 / 2.5	2.5 / 0.5 / 2.5
114.3 / 6.1 / 112.5	
Power supply optionally over the DIN mounting rail CH20M	

Electrical connections

Terminal	ACT20M-UI-AO-S										
	V	mA	mA Loop	RTD 2 wire	RTD 3 wire	RTD 4 wire	POT	TC	Power supply	Output V	Output mA
1				Sense- Sense-							
2	<input type="checkbox"/>	<input type="checkbox"/>		R	R-	R-	R	<input type="checkbox"/>			
3		<input checked="" type="checkbox"/>		R	R+	R+	R				
4	<input checked="" type="checkbox"/>			Sense+ R							
5										<input checked="" type="checkbox"/>	<input checked="" type="checkbox"/>
6										<input type="checkbox"/>	<input type="checkbox"/>
7									<input checked="" type="checkbox"/>		
8										<input type="checkbox"/>	

= +
 = -

Ordering data

Screw connection without mounting rail bus supply	
PUSH IN connection without mounting rail bus supply	
Screw connection with mounting rail bus supply	
PUSH IN connection with mounting rail bus supply	

Type	Qty.	Order No.
ACT20M-UI-AO-X-S	1	2825120000
ACT20M-UI-AO-X-P	1	2825310000
ACT20M-UI-AO-S	1	1176030000
ACT20M-UI-AO-P	1	2825440000

Note	
-------------	--

Frequency transducers

- Separation and conversion of frequencies
- Configuration via FDT/DTM software
- Supply possible via the mounting rail bus
- 3-way separation

ACT20M-FRQ-A0

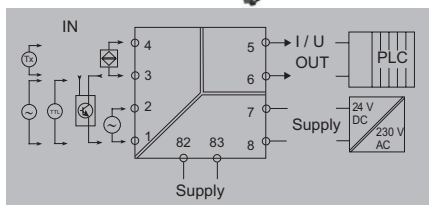
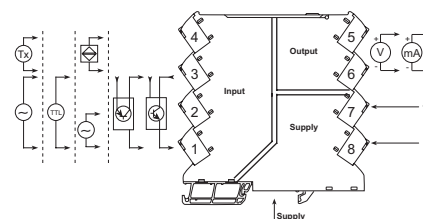

Technical data

Input	Sensor
Sensor supply	
Input frequency	
Output	
Output current	
Output voltage	
General data	
Configuration	
Accuracy	
Voltage supply	
Power consumption, typ.	
Galvanic isolation	
Step response time	
Ambient temperature (operational)	
Insulation coordination	
Insulation voltage	
Rated voltage	
EMC standards	
Pollution degree	
Overvoltage category	
Approvals	
Approvals	

NAMUR sensor, according to EN60947-5-6, NPN / PNP transistor (trig-level low: $\leq 4\text{ V}$ high: $\geq 7\text{ V}$), TTL (trig-level low: $\leq 0.8\text{ V}$ high: $\geq 2.0\text{ V}$), Tacho (trig-level low: $\leq 50\text{ mV}$ high: $\geq +50\text{ mV}$), Special current (trig-level: user-defined), Special voltage (trig-level: user-defined), SO (trig-level low: $\leq 2.2\text{ mA}$ high: $\geq 9.0\text{ mA}$)

5...17 V
adjustable, 0...100kHz
0...20 mA, 4...20 mA, in case of sensor error, downscale (3,5 mA), upscale (23 mA)
0(2)...10 V, 0(1)...5 V, 0(0,2)...1 V
DIP switch, With FDT/DTM software
Basic accuracy: 0.0002 Hz
24 V DC $\pm 30\%$ at terminal or via CH20M rail bus
0.65 W
3-way isolator
$\leq 30\text{ ms}$, (0...90% / 100...10% of input level)
-25 °C...60 °C
2.5 kV _{eff} / 1 min.
250 V
IEC 61326-1, NE 21
2
II

Dimensions	
Clamping range (nominal / min. / max.)	mm ²
Depth / Width / Height	mm
Note	

Screw connection	PUSH IN
2.5 / 0.5 / 2.5	2.5 / 0.5 / 2.5
114.3 / 6.1 / 112.5	114.3 / 6.1 / 112.5

Ordering data

Screw connection without mounting rail bus supply	
PUSH IN connection without mounting rail bus supply	
Screw connection with mounting rail bus supply	
PUSH IN connection with mounting rail bus supply	

Type	Qty.	Order No.
ACT20M-FRQ-A0-X-S	1	2825130000
ACT20M-FRQ-A0-X-P	1	2825340000
ACT20M-FRQ-A0-S	1	2825020000
ACT20M-FRQ-A0-P	1	2825450000

Note	
-------------	--

Signal converters in terminal format – MCZ

Signal converters in terminal format – MCZ	Introduction	E.2
	Selection table	E.4
	Frequency transducer	E.6
	Limit switches	E.7
	Passive isolator	E.8
	Temperature transducer	E.9

Isolate and convert signals at the interface level

MCZ signal converter in terminal format

The MCZ-SERIES signal converters have a slim terminal design and convert, isolate and monitor analogue signals. They have five tension clamp connections. The open side of the housing can be closed using a standard cover plate accessory. The housing has a low height of just 6.3 cm. It also accommodates a cross-connector for reducing the wiring of multiple module's 24 V and 0 V connections. Two WS10/6-markers can be used for labelling. These are available in MultiCard format and can be printed using Weidmüller's professional printing system.

Your special advantages:

Slim design

At the interface level signals are often connected to machine-oriented or customer-specific encoders. These should be individually adapted. The typical terminal block design of the MCZ signal converter allows it to be used on site instead of the corresponding modular terminal, thus allowing external analogue signals to be individually isolated and processed.

Saves space in the electrical cabinet
High product density (modules only 6 mm wide) reduces space taken on the DIN rail.

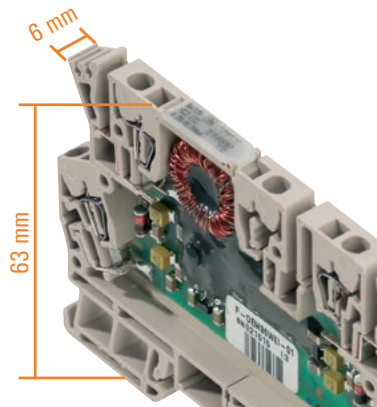

Security

Electrical isolation increases the safety of operations and reduces the risk of facility malfunctions.

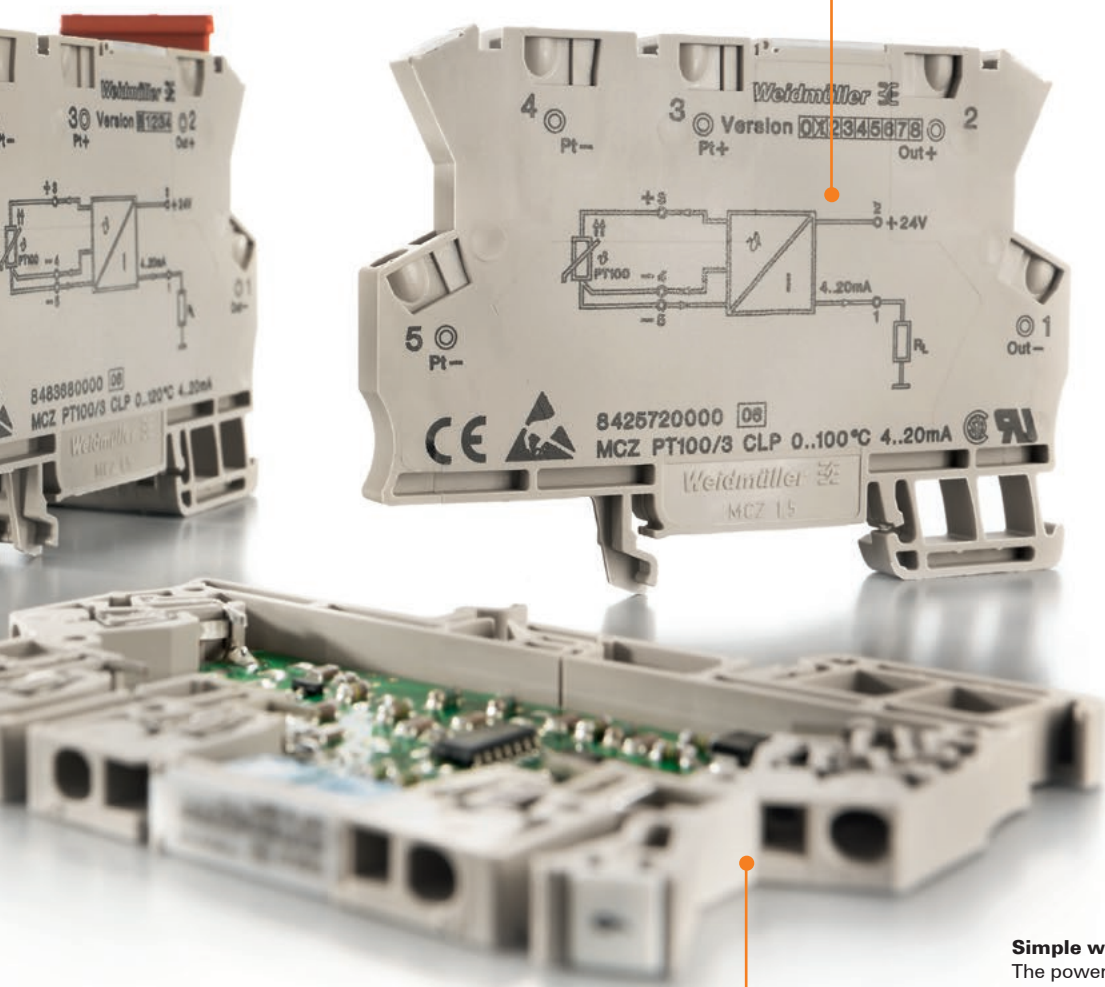
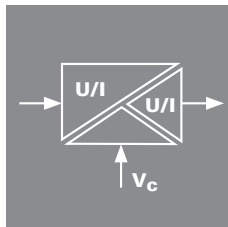

Simple wiring

The power supply can easily be bridged from one module to the next using pluggable cross-connections.

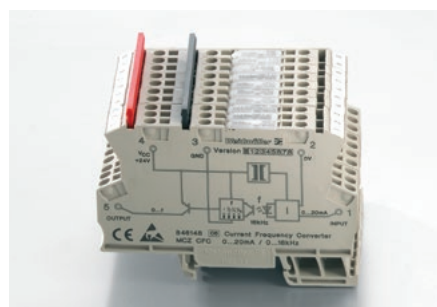

Selection table

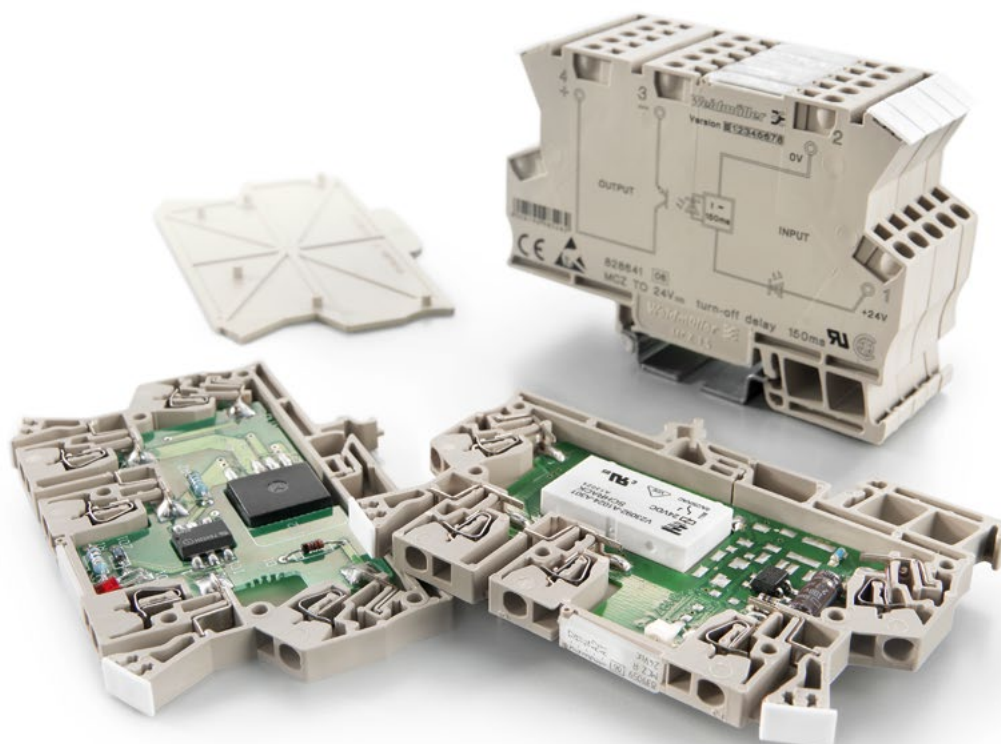

Selection table

Order No.	Product	Input								Miscellaneous	sensor feed	Width
		Number of channels	0...20 mA	4...20 mA	0...10 V	0...5 V	TC	RTD	Frequency			

Signal converters in terminal format - MCZ

Frequency transducer

8461470000	MCZ VFC 0-10V	1			X				4-wire sensor		6 mm
8461480000	MCZ CFC 0-20MA	1	X						4-wire sensor		6 mm
8461490000	MCZ CFC 4-20MA	1		X					4-wire sensor		6 mm
Limit switches											
8260280000	MCZ SC 0-10V	1			X						6 mm
8227350000	MCZ SC 0-20MA	1	X						4-wire sensor		6 mm
Passive isolator											
8411190000	MCZ CCC 0-20mA/0-20mA	1	X						4-wire sensor		6 mm
Temperature transducer											
8425720000	MCZ PT100/3 CLP 0...100C	1					X		Measuring range 0...100°C		6.1 mm
8483680000	MCZ PT100/3 CLP 0...120C	1					X		Measuring range 0...120°C		6.1 mm
8604420000	MCZ PT100/3 CLP 0...150C	1					X		Measuring range 0...150°C		6.1 mm
8473010000	MCZ PT100/3 CLP 0...200C	1					X		Measuring range 0...200°C		6.1 mm
8473020000	MCZ PT100/3 CLP 0...300C	1					X		Measuring range 0...300°C		6.1 mm
8473000000	MCZ PT100/3 CLP -50C...+150C	1					X		Measuring range -50...150°C		6.1 mm
8604430000	MCZ PT100/3 CLP -40C...100C	1					X		Measuring range -40...100°C		6.1 mm

	Output						Configuration	Auxiliary power	Rated insulation voltage	Isolation	Rail bus	Ex approval	Shipbuilding approval	Special characteristics
	Number outputs	0...20 mA	4...20 mA	0...10 V	Switching signal	Limit value, digital								
1							Frequency: 0...1/4/8/16 kHz	DIP switch	24 V DC	100 V	2-way			Frequency output
1							Frequency: 0...1/4/8/16 kHz	DIP switch	24 V DC	100 V	2-way			Frequency output
1							Frequency: 0...1/4/8/16 kHz	DIP switch	24 V DC	100 V	2-way			Frequency output
2					X		2 x NPN	potentiometer	24 V DC					
2					X		2 x NPN	potentiometer	24 V DC					
1	X							input loop	100 V	2-way				
1		X						output loop	50 V	2-way				
1		X						output loop	50 V	2-way				
1		X						output loop	50 V	2-way				
1		X						output loop	50 V	2-way				
1		X						output loop	50 V	2-way				
1		X						output loop	50 V	2-way				

Connection system: S = screw / Z = tension clamp / P = Push In, ILP = Input Loop Powered, OLP = Output Loop Powered, *) = in preparation

Frequency transducer

DC/f converter

The analogue input signal is converted into a configurable frequency signal. Thus analogue signals can be read by the PLC's counter inputs.

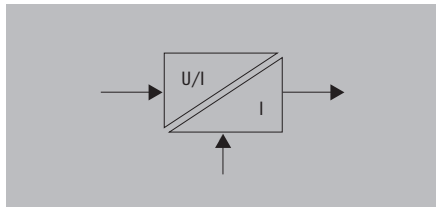

MCZ VFC

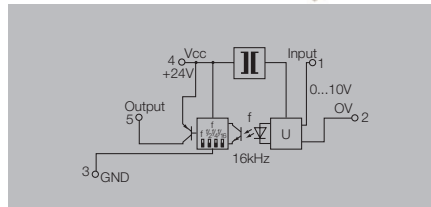
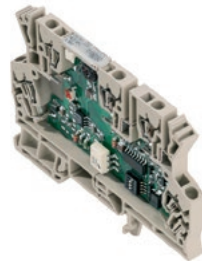

MCZ CFC

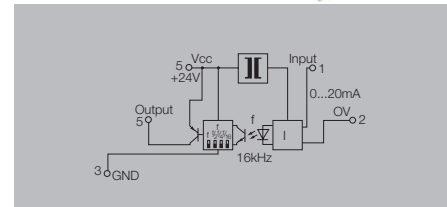
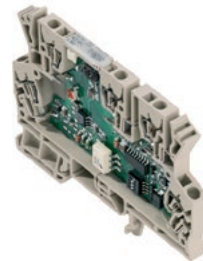

Technical data

Input

Input voltage / Input current
Input resistance, voltage/current
Voltage drop

Output

Output frequency
Output level
Output current
Accuracy
Temperature coefficient
Status indicator

General data

Configuration
Voltage supply
Current consumption
Current-carrying capacity of cross-connect.
Ambient temperature
Approvals

Insulation coordination

Standards
EMC standards
Rated voltage
Impulse withstand voltage
Insulation voltage
Overvoltage category
Pollution degree
Clearance and creepage distances

0...10 V /
100 kΩ /

0...1/ 4/ 8/ 16 kHz
PNP, Ub-0.7 V
max. 20 mA
0.2 % v. FSR
≤ 250 ppm/K
LED, pulsing

DIP switch
24 V DC ± 10 %
14 mA without load
≤ 20 A
0 °C...50 °C
CE

DIN EN 50178
EN 55011, EN 61000-6
100 V
1.5 kV
1 kV DC
III
2
≥ 1.5 mm

/ 0...20 mA
/ 50 Ω
1 V at 20 mA

0...1/ 4/ 8/ 16 kHz
PNP, Ub-0.7 V
max. 20 mA
0.2 % v. FSR
≤ 250 ppm/K
LED, pulsing

DIP switch
24 V DC ± 10 %
14 mA without load
≤ 20 A
0 °C...50 °C
CE

DIN EN 50178
EN 55011, EN 61000-6
100 V
1.5 kV
1 kV DC
III
2
≥ 1.5 mm

Dimensions

Clamping range (nominal / min. / max.) mm²
Depth x width x height mm

Note

Tension-clamp connection

1.5 / 0.5 / 1.5
63.2 / 6 /

Tension-clamp connection

1.5 / 0.5 / 1.5
63.2 / 6 /

Without DC/DC converter input
loop-powered

Ordering data

Tension-clamp connection
Tension clamp connection

Type	Qty.	Order No.
MCZ VFC 0-10V	10	8461470000

Type	Qty.	Order No.
MCZ CFC 0-20mA	10	8461480000
MCZ CFC 4-20mA	10	8461490000

Note

Accessories

Note

Cross-connectors for power supplies and markers: refer to accessories

Cross-connectors for power supplies and markers: refer to accessories

Limit switches for standard signals

- 2 digital outputs
- Monitoring of upper and lower limit values
- 3 selectable input ranges: 300 mV...10 V, 30 mV...1 V, 10 mV...100 mV

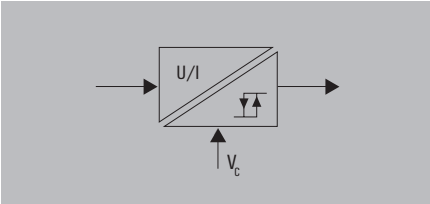

MCZ SC 0...10 V

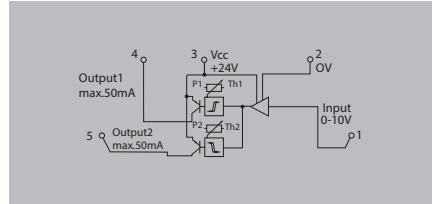
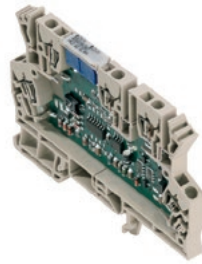

MCZ SC 0...20 mA

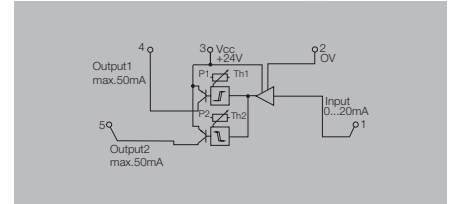
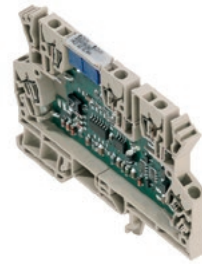

Technical data

Input	
Input voltage / Input current	0...10 V /
Input resistance, voltage/current	60 kΩ /
Voltage drop	
Output	
Contact assembly	Transistor output, double switch output PNP
Function	$U_{in} < U_{Th1}$: output 1 active / $U_{in} > U_{Th2}$: output 2 active
Switching thresholds	Via 2 potentiometers (12 turns)
Hysteresis	1% of adjusted final value
Switching current	50 mA - per channel (voltage drop at transistor: < 1.2 V at 50 mA)
Step response time	<250 μs (switching threshold at 90% of max. input signal; $R_i \leq 1$ kΩ)
Cut-off frequency (-3 dB)	100 Hz
Temperature coefficient	± 250 ppm/K
General data	
Configuration	Potentiometer
Voltage supply	24 V DC ± 20 %
Ambient temperature	0 °C...50 °C
Approvals	CE, CSA, cURus
Insulation coordination	
Standards	
EMC standards	DIN EN 50178

	/ 0.5...20 mA
	/ 50 Ω
	1 V
	Transistor output, double switch output PNP
	$I_{in} < I_{Th1}$: output 1 active; $I_{in} > I_{Th2}$: output 2 active
	Via 2 potentiometers (12 turns)
	1% of adjusted final value
	50 mA - per channel (voltage drop at transistor: < 1.2 V at 50 mA)
	<250 μs (switching threshold at 90% of max. input signal; $R_i \leq 1$ kΩ)
	100 Hz
	± 250 ppm/K
	Potentiometer
	24 V DC ± 20 %
	0 °C...50 °C
	CE, CSA, cURus
	DIN EN 50178

	/ 0.5...20 mA
	/ 50 Ω
	1 V
	Transistor output, double switch output PNP
	$I_{in} < I_{Th1}$: output 1 active; $I_{in} > I_{Th2}$: output 2 active
	Via 2 potentiometers (12 turns)
	1% of adjusted final value
	50 mA - per channel (voltage drop at transistor: < 1.2 V at 50 mA)
	<250 μs (switching threshold at 90% of max. input signal; $R_i \leq 1$ kΩ)
	100 Hz
	± 250 ppm/K
	Potentiometer
	24 V DC ± 20 %
	0 °C...50 °C
	CE, CSA, cURus
	DIN EN 50178

Dimensions	
Clamping range (nominal / min. / max.)	mm ²
Depth x width x height	mm
Note	

TOP connection	
	1.5 / 0.5 / 1.5
	63.2 / 6 /

TOP connection	
	1.5 / 0.5 / 1.5
	63.2 / 6 /

Ordering data

	Tension clamp connection
--	--------------------------

Type	Qty.	Order No.
MCZ SC 0-10V	10	8260280000

Type	Qty.	Order No.
MCZ SC 0-20MA	10	8227350000

Note	
-------------	--

--	--

--	--

Accessories

Note	
-------------	--

Cross-connectors for power supplies and markers: refer to accessories

Cross-connectors for power supplies and markers: refer to accessories

Passive isolator

Passive isolator, input current loop feed

- Passive isolators for galvanic isolation of 0/4...20 mA standard signals.
- The component draws power from the measurement signal and requires no additional auxiliary power
- Low energy consumption, pick-up current of < 100 μ A.
- 2-way isolation

MCZ CCC / ILP

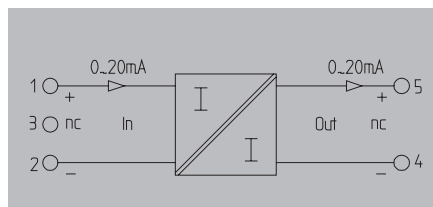
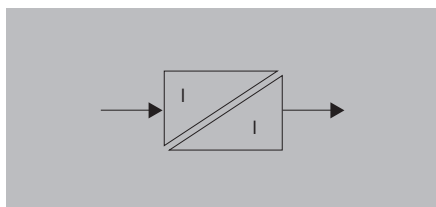

Technical data

Input
 Input voltage / Input current
 Pick-up current
 Voltage drop

Output
 Output voltage / Output current
 Load impedance, voltage/current
 Accuracy
 Temperature coefficient
 Cut-off frequency (-3 dB)

General data

Configuration
 Ambient temperature
 Approvals

Insulation coordination

Standards
 EMC standards
 Insulation voltage

/ 0(4)...20 mA current loop
 <100 μ A
 2.5...3 V at 20 mA

/ 0...20 mA
 / \leq 500 Ω
 <0.1 % of end value
 \leq 50 ppm/K of measured value at 0 Ω load resistance
 100 Hz

none
 -25 °C...60 °C
 CE, CSA, cURus

DIN EN 60529, DIN EN 61010-1
 EN 61000-6

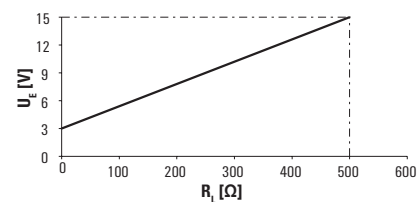

Dimensions
 Clamping range (nominal / min. / max.) mm²
 Depth x width x height mm

Note

Tension-clamp connection
 1.5 / 0.5 / 1.5
 63.2 / 6 /

Ordering data

Tension clamp connection

Type	Qty.	Order No.
MCZ CCC 0-20MA/0-20MA	10	8411190000

Note

Accessories

Note
 Cross-connectors for power supplies and markers: refer to accessories

Temperature transmitter (RTD), output loop powered

- RTD signal converter for galvanic isolation and conversion of PT100 signals
- The component draws power from the output circuit and requires no additional auxiliary power
- 2-way isolation

MCZ PT100/3 CLP / OLP

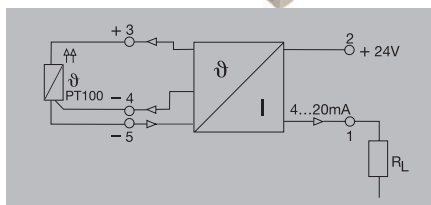
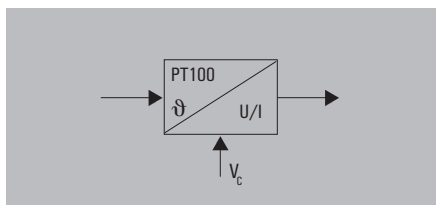

Technical data

Input
Sensor
Sensor supply
Output
Output current
Load impedance, voltage/current
General data
Configuration
Ambient temperature / Storage temperature
Accuracy
Approvals
Standards
EMC standards

PT100 (3 wire)
0.8 mA / 9...30 V DC
4...20 mA (current loop) at 9...30V DC
/ ≤ 600 Ω
none
/ -25 °C...50 °C / -25 °C...85 °C
Typ.: 0.2 %, máx. 0.5 % v. FSR
CE, CSA, cURus
DIN EN 50178, DIN EN 61000-4-2
EN 61000-6

Dimensions	
Clamping range (nominal / min. / max.)	mm ²
Depth x width x height	mm
Note	

Tension-clamp connection
1.5 / 0.5 / 1.5
63.2 / 6 /

Ordering data

0...100 °C	Tension clamp connection
0...120 °C	Tension clamp connection
0...150 °C	Tension clamp connection
0...200 °C	Tension clamp connection
0...300 °C	Tension clamp connection
-50...+150 °C	Tension clamp connection
-40...+100 °C	Tension clamp connection
Note	

Type	Qty.	Order No.
MCZ PT100/3 CLP 0...100C	10	8425720000
MCZ PT100/3 CLP 0...120C	10	8483680000
MCZ PT100/3 CLP 0...150C	10	8604420000
MCZ PT100/3 CLP 0...200C	10	8473010000
MCZ PT100/3 CLP 0...300C	10	8473020000
MCZ PT100/3 CLP -50C...+150C	10	8473000000
MCZ PT100/3 CLP -40C...100C	10	8604430000

Accessories

Note

Cross-connectors for power supplies and markers: refer to accessories

Compact signal converter – PicoPak

Compact signal converter – PicoPak	Introduction	F.2
	Selection table	F.4
	Passive isolator	F.6

Measuring and isolating without auxiliary power supply

PicoPak - the smallest standard signal isolator

Many processes are only possible with the safe conversion and reliable separation of analogue current signals. With impressive performance, our analogue signal converter PicoPak supports the simultaneous measurement and galvanic isolation of signals from active field sensors and PLC input cards. Because of their integrated input and output current loop, the module does not require any additional auxiliary power supply and can also be easily used in remote switch boxes. Being integrated into a housing that is only 6 mm wide means that the signal converters take up very little space on a terminal rail. Both the tried-and-tested screw connectors and the convenient PUSH IN connection technology designs ensure reliable connections.

Your special advantages:

- High flexibility for a variety of applications due to worldwide approvals and an extended
- temperature range from -40 to +70°C
- Loop powered to isolate active field sensors without additional auxiliary power supply from active PLC input cards
- Reliable measurement range and zero point calibration using a potentiometer

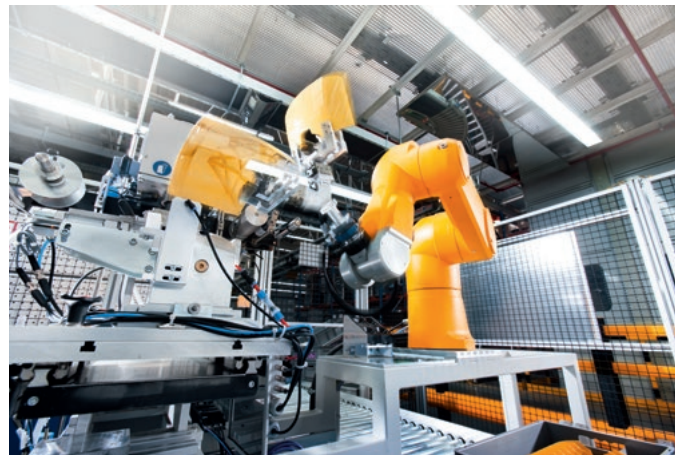

Span and Zero point calibration
Adjustable by potentiometer

Slim and compact
6 mm housing width

Connection technology
Screw or PUSHIN terminals

Extended temperature range
-40 °C...+70 °C

Approvals for world wide use
ATEX, IECEX, cULus, CI1 Div2

Passive Input and Output
for active input sensors (source)
and active input PLC cards (source)

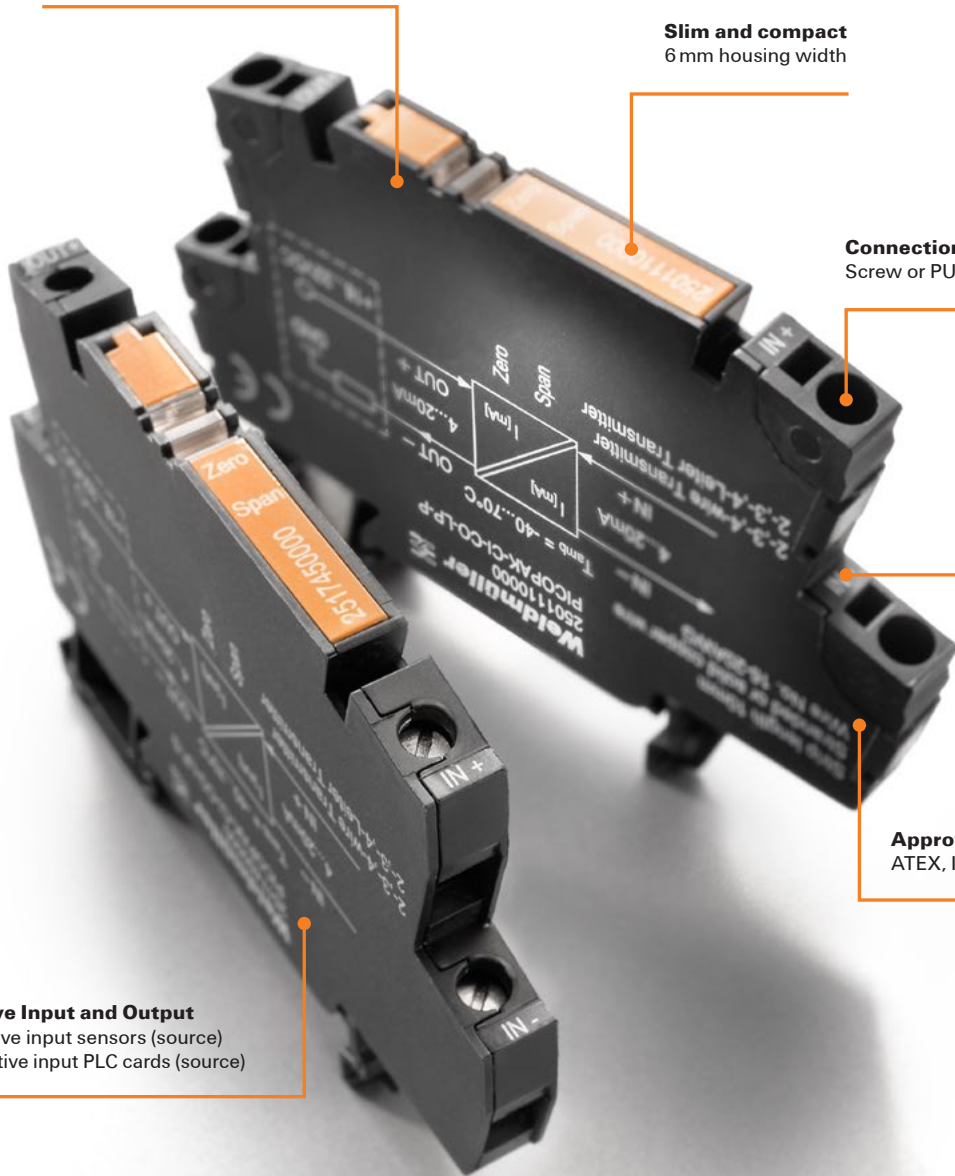

Selection table

F



Selection table

Order No.	Product	Input							Miscellaneous	sensor feed	Width
		Number of channels	0...20 mA	4...20 mA	0...10 V	0...5 V	TC	RTD			

Compact signal converter - PicoPak

Passive isolator

2517450000	PICOPAK-CH-CO-LP-S	1	X						4-wire sensor		6.1 mm
2501110000	PICOPAK-CH-CO-LP-P	1	X						4-wire sensor		6.1 mm

	Output						Configuration	Auxiliary power	Rated insulation voltage	Isolation			Special characteristics
	Number outputs	0...20 mA	4...20 mA	0...10 V	Switching signal	Limit value, digital				Miscellaneous	Rail bus	Ex approval	
1	X						potentiometer, zero/span	output loop	300 V	2-way		X	
1	X						potentiometer, zero/span	output loop	300 V	2-way		X	

Connection system: S = screw / Z = tension clamp / P = Push In, ILP = Input Loop Powered, OLP = Output Loop Powered, *) = in preparation

Passive isolator

Passive isolator, output loop powered

- Input for current source (active)
- Output current signal (passive)
- 2-way isolation
- Manual zero and span adjustment
- Increased operating temperature range -40 °C ...+70 °C

PICOPAK-CI-CO-LP

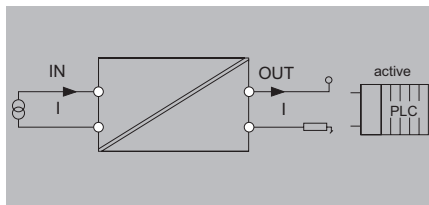

Technical data

Input

Number of inputs
Input current
Sensor
Voltage drop, current input

Analogue outputs

Load impedance current
Output current
Supply voltage (output)

General data

Accuracy
Configuration
Voltage supply
Step response time
Temperature coefficient
Power consumption, max.
Voltage supply
Long-term drift

Insulation coordination

EMC standards
Galvanic isolation
Overvoltage category
Insulation voltage
Rated voltage

Number of inputs	1
Input current	4...20 mA @ 6...35 V DC
Sensor	Current source
Voltage drop, current input	≤3,5 V
Load impedance current	≤ 600 Ω, @ max 23mA
Output current	4...20 mA, loop-powered
Supply voltage (output)	18...32 V
Accuracy	<0.1 % of measuring range
Configuration	Potentiometer, Zero / Span
Voltage supply	Output loop powered
Step response time	≤ 5 ms
Temperature coefficient	≤ 200 ppm/K
Power consumption, max.	0.8 W
Voltage supply	Output loop powered
Long-term drift	
EMC standards	EN 61326-1
Galvanic isolation	2-way isolator
Overvoltage category	II
Insulation voltage	3.5 kV
Rated voltage	300 V AC _{max}

Dimensions

Clamping range (nominal / min. / max.) mm²
Depth x width x height mm

Note

Screw connection

PUSH IN

55 / 6.1 / 79.4 55 / 6.1 / 79.4

Ordering data

Screw connection
PUSH IN connection

Type	Qty.	Order No.
PICOPAK-CI-CO-LP-S	1	2517450000
PICOPAK-CI-CO-LP-P	1	2501110000

Note

Accessories

Note

Process value displays

Process value displays	Introduction	G.2
	Process value displays with LCD display	G.4
	Process value displays with LED display	G.6

Process value displays

With its process instruments, Weidmüller offers you a comprehensive range of innovative products for analogue signal processing. This range is specially designed for the demanding and complex requirements of modern process automation. The product series ranges from simple dedicated units to complex microprocessor-controlled devices, and can therefore be used with almost all signal types and all common measurement sensors. The products also offer a wide range of integrated functions. These include time delays, adjustable thresholds, high/low trip switching behaviour and display scaling.



Selection table

Order No.	Product	Input										Width
		Number of channels	0...20 mA	4...20 mA	0...10 V	0...5 V	TC	RTD	Frequency	Miscellaneous	sensor feed	
Process value displays												
Process value displays with LCD display												
2920000000	ACT20D-LCD-CHLP	1		X							4-wire sensor	96.6 mm
Process value displays with LED display												
2920050000	ACT20D-LED-UI-AC-DC	1	X	X	X	X	X	X			Temperature (RTD / TC), current / voltage, potentiometer	96.6 mm
2920060000	ACT20D-LED-UI-A0-4RC-AC-D	1	X	X	X	X	X	X			Temperature (RTD / TC), current / voltage, potentiometer	96.6 mm
2920070000	ACT20D-LED-FI-A0-2RC-AC-DC	1							X		Namur, SO, switch, tacho, TTL, NPN/PNP, current / voltage	X 96.6 mm
2964330000	Protective cover											96.6 mm

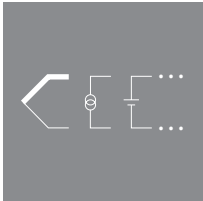

All-purpose

A fitting solution for any application – with a multitude of input ranges, external of input loop-powered supply, and analogue or digital outputs.



Saves time

Easy push-button configuration.



Security

No additional signal isolation is required since there is a high insulation voltage.



Protection

IP 65 protection allows for use in harsh industrial conditions.

	Output						Configuration	Auxiliary power	Rated insulation voltage	Isolation	Rail bus	Ex approval	Shipbuilding approval	Special characteristics
	Number outputs	0...20 mA	4...20 mA	0...10 V	Switching signal	Limit value, digital								
	1						LCD display	Buttons on the device	input loop	250V	2-way			Front built-in
	1						LCD display	Buttons on the device	24 V - 230 V AC/DC	300 V	3-way		X	Front built-in
	1	X	X		X		LED display, 4 x CO	Buttons on the device	24 V - 230 V AC/DC	300 V	7-way		X	Front built-in
	1	X	X		X		LED display, 2 x CO	Buttons on the device	24 V - 230 V AC/DC	300 V	5-way		X	Front built-in
														Cover for process value displays

Connection system: S = screw / Z = tension clamp / P = Push In, ILP = Input Loop Powered, OLP = Output Loop Powered, *) = in preparation

Process value indicators with LCD display - ACT20D

Indicator with current input, 4...20 mA, loop-powered

ACT20D-LCD-CHLP

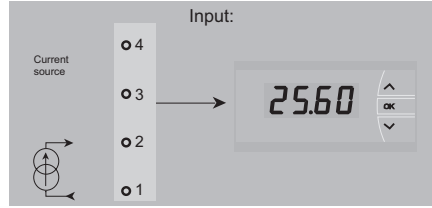

Technical data

Input	
Number of inputs	1
Input current	4...20mA
Sensor	Current source, 4- wire sensor (with own power supply)
Display	
Type	4-character, LCD display, 16 mm
Display range	-9999...9999
General data	
Accuracy	<0.1 % of measuring range
Voltage supply	Loop powered, via 4...20 mA input
Ambient temperature / Storage temperature	/ -20 °C...60 °C / -20 °C...85 °C
Humidity	0...95 % (no condensation)
Approvals	CE

Input		
Number of inputs	1	
Input current	4...20mA	
Sensor	Current source, 4- wire sensor (with own power supply)	
Display		
Type	4-character, LCD display, 16 mm	
Display range	-9999...9999	
General data		
Accuracy	<0.1 % of measuring range	
Voltage supply	Loop powered, via 4...20 mA input	
Ambient temperature / Storage temperature	/ -20 °C...60 °C / -20 °C...85 °C	
Humidity	0...95 % (no condensation)	
Approvals	CE	

Dimensions	
Depth x width x height	mm

Tension clamp connection with actuator	
120 / 96.6 / 48.8	

Note

--

Ordering data

Note

Type	Qty.	Order No.
ACT20D-LCD-CHLP	1	2920000000

Accessories

Note

--

Indicator with frequency input

- Analog output
- Setpoint limit monitoring
- Wide range power supply

ACT20D-LED-FI-A0-2RC-AC-DC

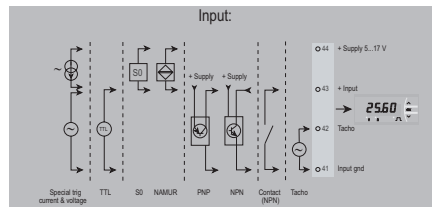

Technical data

Input	
Number of inputs	1
Input frequency	0.001...50 kHz
Sensor	SO (trig-level low: ≤ 2.2 mA high: ≥ 9.0 mA), Special current (trig-level: user-defined), Special voltage (trig-level: user-defined), TTL (trig-level low: ≤ 0.8 V high: ≥ 2.0 V), Tacho (trig-level low: ≤ 50 mV high: $\geq +50$ mV), NAMUR sensor, according to EN60947-5-6, NPN / PNP transistor (trig-level low: ≤ 4 V high: ≥ 7 V), Trigger level adjustable, Switch
Display	
Type	red LED, 4-character display, Digit size: 13.8 mm
Display range	-1999...9999
Format	14 segment (numbers + letters), Scrolling text in 8 languages in case of error (e.g. sensor wire breakage, input overrange...)
Output (digital)	
Number of digital outputs	2
Rated switching voltage	24 V AC ... 250 V AC
Type	2 x 1 CO contact (hard gold-plated)
Alarm function	Over / under frequency, Overspeed / underspeed, Holding function can be activated
Output (analogue)	
Number of analogue outputs	1
Output current	0...20 mA, 4...20 mA, 20...0 mA, 20...4 mA
General data	
Accuracy	absolute accuracy: $\leq \pm 0.1$ % of the measurement range
Power consumption	≤ 3.5 W
Voltage supply	21.6...253 VAC, (50...60 Hz) or 19.2...300 VDC
Insulation voltage	2.3 kVAC (Test) / 250 VAC (operating state)
Galvanic isolation	between input/output/supply/relay
Ambient temperature / Storage temperature	/ -20 °C...60 °C / -40 °C...80 °C
Humidity	
Approvals	CE

Dimensions	Tension clamp connection with actuator
Depth x width x height	120 / 96.6 / 48.8

Note	
-------------	--

Ordering data

Type	Qty.	Order No.
ACT20D-LED-FI-A0-2RC-AC-DC	1	2920070000

Note	
-------------	--

Accessories

Note	
-------------	--

Process value indicators with LED display - ACT20D

Display with universal input

- Analog output
- Setpoint limit monitoring
- Wide range power supply

ACT20D-LED-UI-A0-4RC-AC-DC

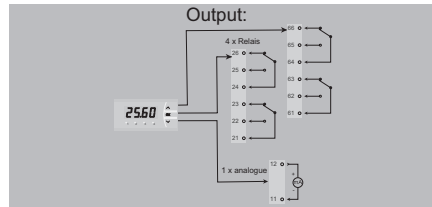
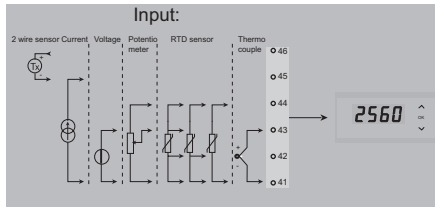

Technical data

Input

Number of inputs
Input voltage
Input current
Sensor

1
0...1 V DC, 0,2...1 V DC, 0...10 V DC, 2...10 V DC
0...20 mA, 4...20 mA
2-wire transmitter (without own power supply), 4-wire sensor (with own power supply), RTD (2,3-wire): Pt100, Pt200, Pt1000, Ni120, Cu10, Thermocouples: B / C / E / J / K / L / N / R / S / T / W3 / W5, Resistance measurement, Potentiometer: 10 Ω...10 kΩ

Display

Type
Display range
Format

red LED, 4-character display, Digit size: 13.8 mm
-1999...9999
14 segment (numbers + letters), Scrolling text in 8 languages in case of error (e.g. sensor wire breakage, input overrange...)

Output (digital)

Number of digital outputs
Rated switching voltage
Type
Alarm function

4
24...250 V AC
4 x 1 CO contact (hard gold-plated)
Under voltage, Over voltage, Under-current, Surge current, Surge voltage, Under-temperature, Over-temperature, Sensor error

Output (analogue)

Number of analogue outputs
Output current

1
0...20 mA, 4...20 mA, 20...0 mA, 20...4 mA

General data

Accuracy
Power consumption
Voltage supply
Insulation voltage
Galvanic isolation
Ambient temperature / Storage temperature
Humidity
Approvals

<0.1 % of measuring range
≤ 3.5 W
21.6...253 VAC, (50...60 Hz) or 19.2...300 VDC
2.3 kVAC (Test) / 250 VAC (operating state)
between input/output/supply/relay
/ -20 °C...60 °C /
5...95 % rel. humidity, no condensation
CE

Dimensions

Depth x width x height mm

Tension clamp connection with actuator

120 / 96.6 / 48.8

Note

Ordering data

Type	Qty.	Order No.
ACT20D-LED-UI-A0-4RC-AC-DC	1	2920060000

Note

Accessories

Note

Indicator with universal input

- Wide range power supply

ACT20D-LED-UI-AC-DC

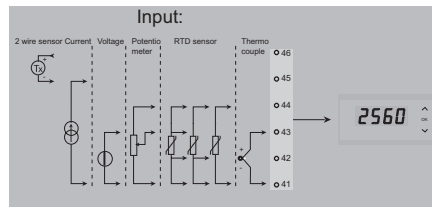

Technical data

Input

Number of inputs
Input voltage
Input current
Sensor

1
0...1 V DC, 0,2...1 V DC, 0...10 V DC, 2...10 V DC
0...20 mA, 4...20 mA
2-wire transmitter (without own power supply), 4-wire sensor (with own power supply), RTD (2,3-wire): Pt100, Pt200, Pt1000, Ni120, Cu10, Thermocouples: B / C / E / J / K / L / N / R / S / T / W3 / W5, Resistance measurement, Potentiometer: 10 Ω...10 kΩ

Display

Type
Display range
Format

red LED, 4-character display, Digit size: 13.8 mm
-1999...9999
14 segment (numbers + letters), Scrolling text in 8 languages in case of error (e.g. sensor wire breakage, input overrange...)

General data

Accuracy
Power consumption
Voltage supply
Insulation voltage
Ambient temperature / Storage temperature
Humidity
Approvals

<0.1 % of measuring range
2.2 W
21.6...253 VAC, (50...60 Hz) or 19.2...300 VDC
2.3 kVAC (Test) / 250 VAC (operating state)
/ -20 °C...60 °C /
5...95 % rel. humidity, no condensation
CE

Dimensions

Depth x width x height mm

Tension clamp connection with actuator

120 / 96.6 / 48.8

Note

Ordering data

Type	Qty.	Order No.
ACT20D-LED-UI-AC-DC	1	2920050000

Note

Accessories

Note

Protective Cover

PROTECTIVE COVER



Technical data

Version

Display, Hood,

G

Dimensions

Depth x width x height

mm

120 / 96.6 / 48.8

Note

Ordering data

Type	Qty.	Order No.
PROTECTIVE COVER	1	2964330000

Note

Accessories

Note

Configuration software

Configuration software	Introduction	H.2
	WI Manager	H.4

Device configuration for analogue signal conditioners using FDT- and FDT2-technology

The WI-Manager is a device-management frame application which supports the FDT and FDT2 (Field Device Tool) standards. The software can be used to configure and maintain all of our configurable ACT20 devices. It can manage all device drivers that are available through their DTM (Device Type Manager). The DTM permits access to device data with a graphical user interface (GUI) that offers the user a variety of functions such as configuration, operation and monitoring of devices. WI-Manager helps to reduce the costs related to planning and maintaining the devices in a facility.

Full FDT-functionality

The WI-Manager software provides total support for FDT and FDT2 functions. As such, it is both state-of-the-art and backwards compatible.

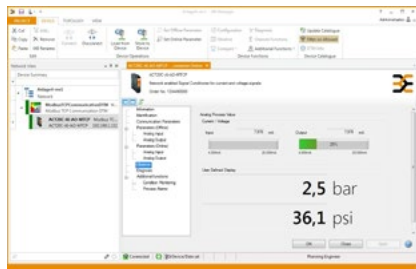
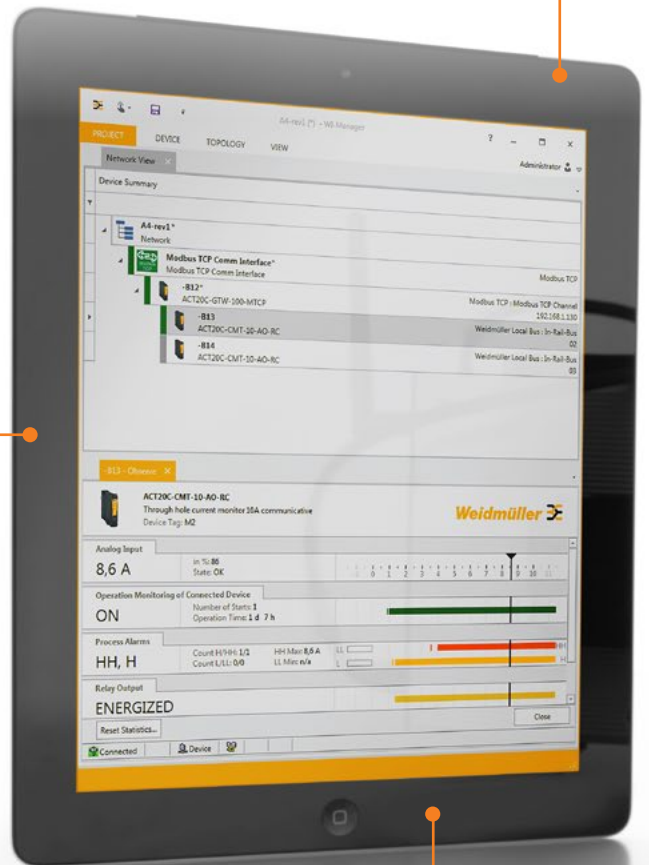

Universal network topology

WI-Manager supports all communication protocols through their corresponding DTMs.

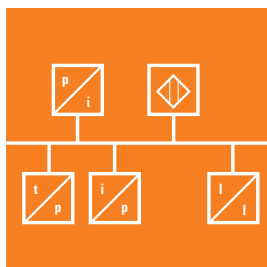

Integrated security

The WI-Manager user administration allows access to be limited to uncritical device functions. This increases the overall safety and security of the facility.

**Centralised data management**

Centralised administration of all available project and product data in one unified format – the result is reduced software management and data administration costs.

**Automated network planning**

Connected networks and products are automatically detected and displayed by means of the SCAN function. This makes planning and initial commissioning easier.

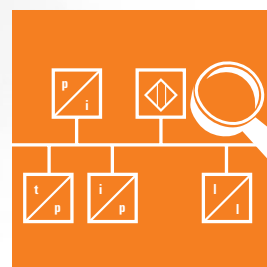

Device configuration

Software WI Manager FDT-DTM

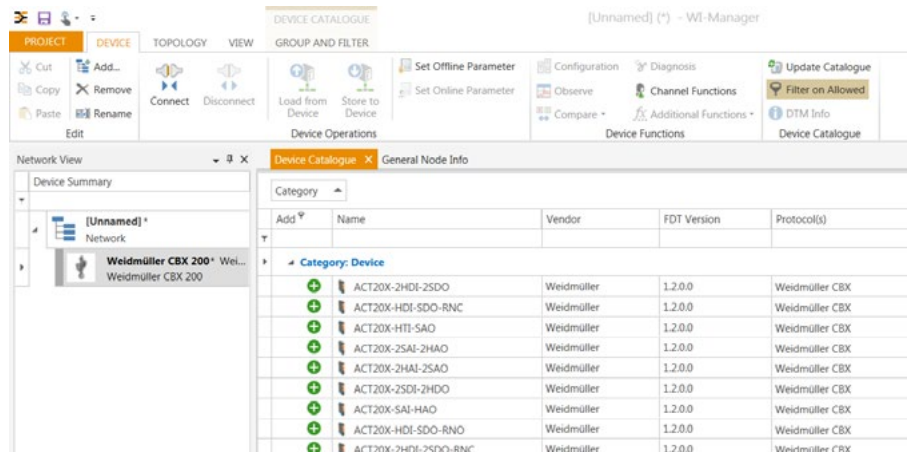

Technical Data

Function and performance features

Online constraint
 GUI
 Usage model software
 Language

System requirements

Operating system
 Required rights
 Product information

No
 Yes
 Local installation
 English, German

Windows 8, Windows 10
 Admin

With the FDT-DTM software you can configure and monitor the devices of the ACT20 series. The software includes the respective Device Type Manager (DTM) as well as the FDT2.0 Frame Application WI-Manager.

Note

Ordering Data

Note

Type	Qty.	Order No.
SW Weidmueller DTM-Library Setup	1	1466380000

Accessories

Accessories	Introduction	I.2
	Programming adapter	I.4
	CH20M DIN rail bus	I.6
	ACT20 power-feed modules for rail bus	I.8
	ACT20X/ACT20C/ACT20P - Accessories	I.10
	MICROSERIES/ACT20M - Accessories	I.11
	MCZ/WAVE - Accessories	I.12

Accessories

Configure, calibrate, mount, mark, (cross-) connect.

A comprehensive line of accessories is available for the analogue signal converter product family. The line includes configuration adapters for software-programmable products, interface modules, calibrators and mounting accessories (such as cross-connectors, end plates and terminal connectors) – all naturally in the top Weidmüller quality that you've come to expect.



Selection table

Order No.	Product	Input							Miscellaneous	sensor feed	Width
		Number of channels	0...20 mA	4...20 mA	0...10 V	0...5 V	TC	RTD			

Accessories

Programming adapter

8978580000	CBX200 USB	1							24 V DC		
2907490000	ADAPTER CBX200 - MINI US	1							Adapter for ACT20P-TCI... / ACT20P-RTD...		
ACT20 power supply modules for rail bus											
8965500000	ACT20-FEED-IN-PRO-S	1							2 x 24V		22.5 mm
2456870000	ACT20-FEED-IN-PRO-P	1							2 x 24V		22.5 mm
1282490000	ACT20-FEED-IN-BASIC-S	1							24 V		6.1 mm
2825460000	ACT20-FEED-IN-BASIC-P	1							24 V		6.1 mm



	Number outputs	Output					Configuration	Auxiliary power	Rated insulation voltage	Isolation	Rail bus	Ex approval	Shipbuilding approval	Special characteristics
		0...20 mA	4...20 mA	0...10 V	Switching signal	Limit value, digital								
	1						Software	-					Interface adapter for configuration	
	1						Software	-					Mini-USB for 8978580000 CBX200 USB	
	1					X	24 V for Rail bus	24 V DC			X	X	Redundant feed-in	
	1					X	24 V for Rail bus	24 V DC			X	X	Redundant feed-in	
	1						24 V for Rail bus	24 V DC			X	X		
	1						24 V for Rail bus	24 V DC			X	X		

Connection system: S = screw / Z = tension clamp / P = Push In, ILP = Input Loop Powered, OLP = Output Loop Powered, *) = in preparation

Programming adapter

CBX200

- Interface converter for configuration, with galvanic isolation
- USB port for connecting to PC
- TX and RX status displays
- WI-Manager and TTA Set configuration software programs, download at www.weidmueller.com

CBX200 USB



Technical data

Input	
Type	USB 2.0 (USB type A plug)
Input current	≤ 100 mA
Input resistance	22 kΩ
Input voltage	1.6...5.6 V
Output	
Type	RS232 (4-pole 2.5-mm jack plug)
Output voltage	3.3 V regulated
Level on interfaces	1.8...5.6 V (automatically adapted)
Baud rate	≤ 115 kBd
Activation signal	9...15 V typ. 12 V / 4 mA
Insulation coordination	
Insulation voltage	2.5 kV (input / output)

Type	USB 2.0 (USB type A plug)
Input current	≤ 100 mA
Input resistance	22 kΩ
Input voltage	1.6...5.6 V
Output	
Type	RS232 (4-pole 2.5-mm jack plug)
Output voltage	3.3 V regulated
Level on interfaces	1.8...5.6 V (automatically adapted)
Baud rate	≤ 115 kBd
Activation signal	9...15 V typ. 12 V / 4 mA
Insulation coordination	
Insulation voltage	2.5 kV (input / output)

The CBX200 USB is a USB2.0/RS232-interface converter with galvanic isolation. It has additional functionality for controlling and supplying the connected RS232 device. The CBX200 USB makes it possible to configure the intrinsically safe ACT20X product line. ADAPTER CBX200 - MINI USB for converting the CBX200 jack plug to mini USB.

Pin assignments for jack plug



DTR*	Vcc
0	3.3 V
1	0 V

Control input	RTS*	RS232 interface
12 V	1	active
12 V	0	active
0 V	1	active
0 V	0	not active

* RTS and DTR are internal control signals

Installation notes

The power supply to the device comes from the USB port via a USB type-A plug. The output-side of the RS232 interface uses a four-pole 2.5-mm jack plug to connect. This jack plug is also capable of activating the RS232 interface when needed with a 12-V control voltage. With the assistance of the DTM, the USB interface is diverted to a COM interface. The RS232 interface can be activated with an RTS signal (RTS = 1 → output activated) via the diverted COM interface. The jack plug is also capable of supplying the RS232 node with a regulated voltage of 3.3 V at 4 mA current. The DTR signal (DTR = 0 → supply activated) is used for control. It is also possible to query the status using the DSR signal (DSR = 0 → output activated).

The "WI-Manager" software with the DTM library can all be downloaded free of charge from www.weidmueller.com.

Note

Note

Ordering data

Adapter CBX200 jack plug to mini USB Configuration interfaces

Type	Qty.	Order No.
ADAPTER CBX200 - MINI USB	1	2907490000
CBX200 USB	1	8978580000

Note

Note

Accessories

Note

Note

CH20M DIN rail bus

Quick and safe power supply through the mounting rail.

This customer-friendly infrastructure solution brings power, signals and data to the rail in a quick and reliable manner. The DIN rail bus can replace the tedious individual wiring process with a flexible and uninterrupted system solution. As a result, the wiring overhead and the error rate are both reduced. The uninterrupted system bus is securely integrated within the 35 mm standard mounting rail. Whether 7.5 mm or 15 mm high, the custom-fit rail profiles are easy to install on all TS 35 standard rails in accordance with DIN EN 60715.

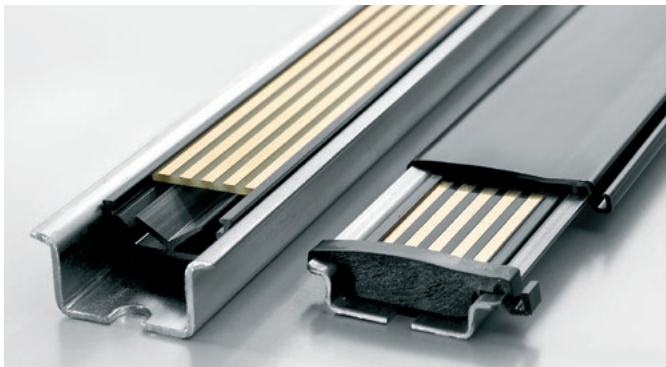

The resistant gold-plated contacts ensure a permanent and reliable contact. The ACT20M modules are simply snapped onto the mounting rail and are automatically in contact with the DIN rail bus.

The supply to the 24 V power supply can be from either one of the modules (up to 400 mA) or a separate power supply terminal (up to 4 A). The ACT20-Feed-In-Basic provides a simple and compact (6 mm width) power supply terminal solution.

The ACT20-Feed-In-Pro is a more powerful 22.5 mm wide solution. This makes a backup power supply that includes error messaging possible.

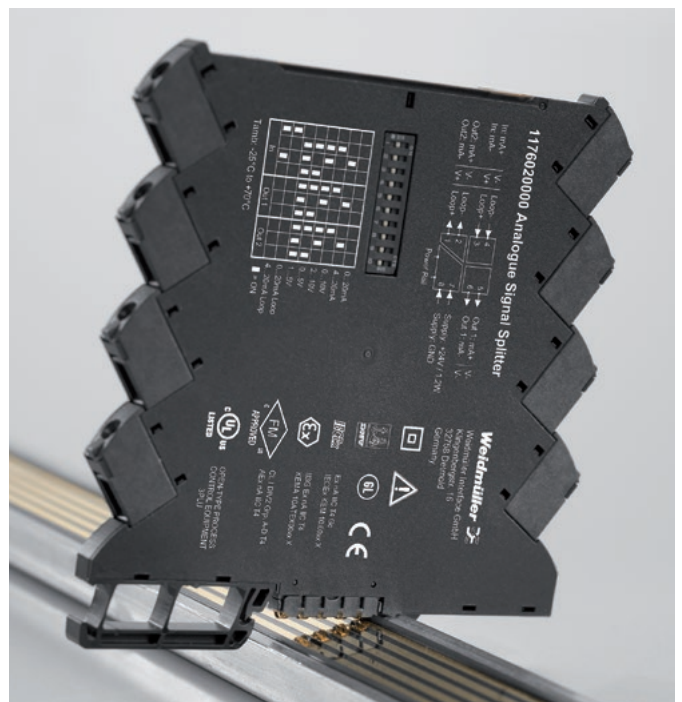

Rail bus accessories

CH20M BUS-PROFIL TS35x7.5/1000

Support section for bus circuit board



- Support section for TS 35 x 7.5
- Length: 250, 500 or 750 mm

Ordering data

Type	Qty.	Order No.
CH20M BUS-PROFIL TS35x7.5/250	10	1248150000
CH20M BUS-PROFIL TS35x7.5/500	10	1248160000
CH20M BUS-PROFIL TS35x7.5/750	5	1248170000

CH20M BUS-PROFIL TS35x15/1000

Support section for bus circuit board



- Support section for TS 35 x 15
- Length: 250, 500 or 750 mm

Ordering data

Type	Qty.	Order No.
CH20M BUS-PROFIL TS35x15/250	5	1248180000
CH20M BUS-PROFIL TS35x15/500	5	1248190000
CH20M BUS-PROFIL TS35x15/750	5	1248210000

CH20M BUS 4.50/05 AU/1000

Bus PCB



- Bus circuit board for use on TS 35 x 7.5 and TS 35 x 15
- Length: 250, 500 or 750 mm
- Five conductor paths, gold-plated
- Electrical rating: 63 V AC, 5 A/conductor path

Ordering data

Type	Qty.	Order No.
CH20M BUS 4.50/05 AU/250	10	1248220000
CH20M BUS 4.50/05 AU/500	10	1248230000
CH20M BUS 4.50/05 AU/750	5	1248240000

CH20M BUS-ADP TS35/1000

Cover plate



- Cover plate for DIN rail bus
- Length: 250, 500 or 750 mm

Ordering data

Type	Qty.	Order No.
CH20M BUS-ADP TS35/250	10	1248250000
CH20M BUS-ADP TS35/500	10	1248260000
CH20M BUS-ADP TS35/750	5	1248270000

CH20M BUS-AP LI TS35x7.5 & 15

End plate



- End plate for DIN rail bus
- Fits on TS 35 x 7.5 and TS 35 x 15
- left

Ordering data

Type	Qty.	Order No.
CH20M BUS-AP LI TS35x7.5 & 15	50	1193160000

CH20M BUS-AP RE TS35x7.5 & 15

End plate



- End plate for DIN rail bus
- Fits on TS 35 x 7.5 and TS 35 x 15
- right

Ordering data

Type	Qty.	Order No.
CH20M BUS-AP RE TS35x7.5 & 15	50	1193170000

SET CH20M BUS 250MM TS 35X15

Set

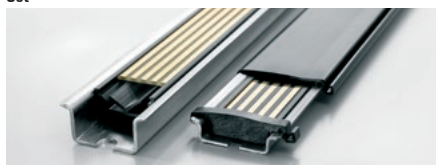

- SET consists of one each of
CH20M BUS 4.50/05 AU/250
CH20M BUS-ADP TS 35/250
CH20M BUS-AP LI TS 35X7.5 & 15
CH20M BUS-AP RE TS 35X7.5 & 15
CH20M BUS-PROFIL TS 35X15/250

Ordering data

Type	Qty.	Order No.
SET CH20M BUS 250MM TS 35X15	1	1335150000

SET CH20M BUS 250MM TS 35X7.5

Set

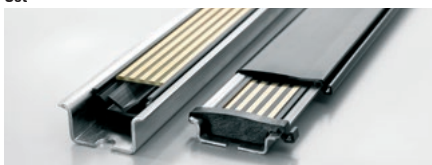

- SET consists of one each of
CH20M BUS 4.50/05 AU/250
CH20M BUS-ADP TS 35/250
CH20M BUS-AP LI TS 35X7.5 & 15
CH20M BUS-AP RE TS 35X7.5 & 15
CH20M BUS-PROFIL TS 35X7.5/250

Ordering data

Type	Qty.	Order No.
SET CH20M BUS 250MM TS 35X7.5	1	1335140000

TS 35x7.5 / TS 35x15

DIN rail

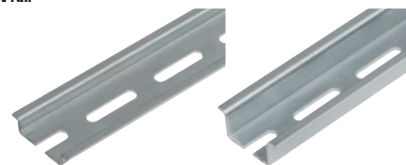

- DIN rail with slot
- Passivated galvanised steel

Ordering data

Type	Qty.	Order No.
TS 35X7.5/LL 1M/ST/ZN	10	0514510000
TS 35X15/LL 1M/ST/ZN	10	0236510000

Power-feed module for the CH20M DIN rail bus

4 A supply with backup supply and error analysis

The power-feed unit ACT20-FEED-IN-PRO-S supplies the devices on the CH20M DIN rail bus with 24 V DC. At the same time, the FEED-IN device reads the group error contact – optionally provided by the installed devices – from the CH20M rail bus and sends a message through the status relay to the external controller. Optionally, two power supplies can be connected for the primary and secondary supplies (backup). An installation in Zone 2 / Division 2 is also possible. Three LEDs show the status of the power supply and the error status.

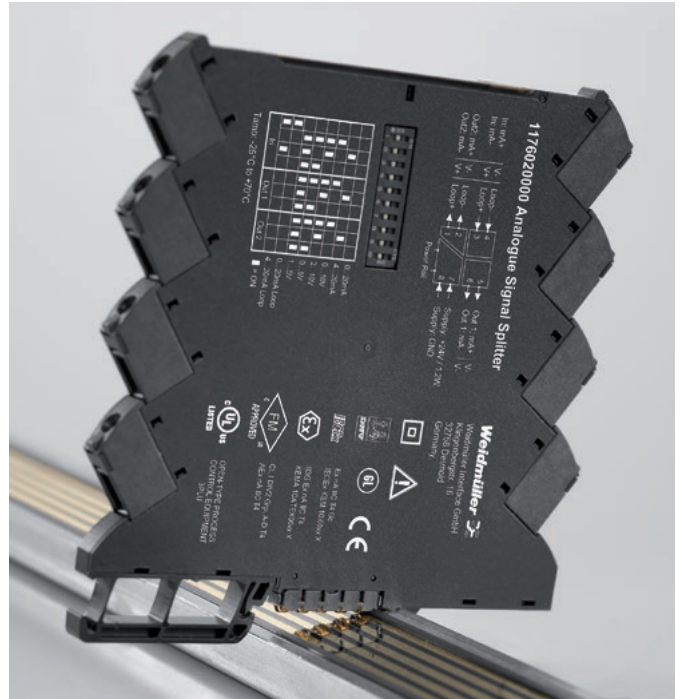
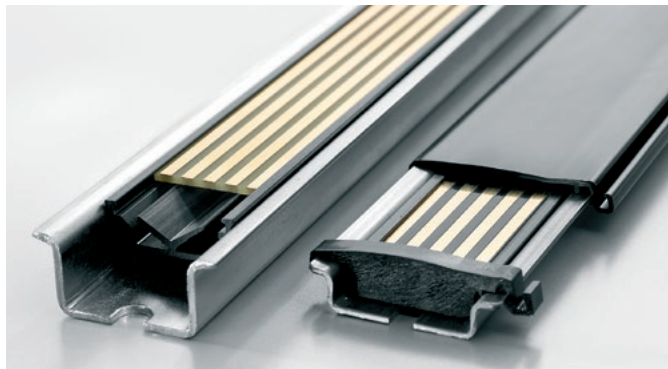

Weidmüller offers a compact and narrow 6 mm feed-in module as an alternative. This wires the terminal level directly to the DIN rail bus.

The FEED-IN-PRO can supply a maximum of 4 A to feed up to 120 devices mounted on a CH20M rail bus. Quick identification of errors on the DIN rail bus is through the internal status relay. The FEED-IN-PRO device immediately recognises and displays when a power supply has failed. The supply is then switched automatically to the redundant power supply.

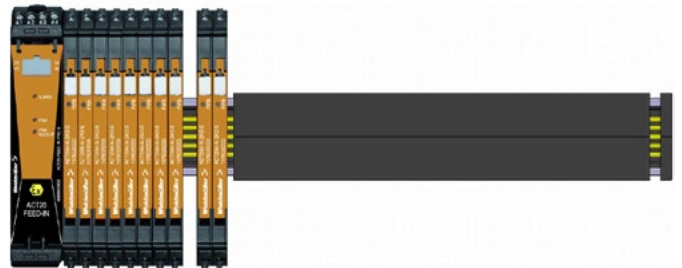

ACT20 power-feed module

- Distributes the supply onto the busbar
- Compatible with Weidmüller CH20 DIN rail bus
- Optional connection for backup supply
- Approved for use in Ex-Zone 2 /Div. 2
- Monitoring of the supply voltage
- Alarm alerts via the status relay

ACT20-Feed-In-PRO-S

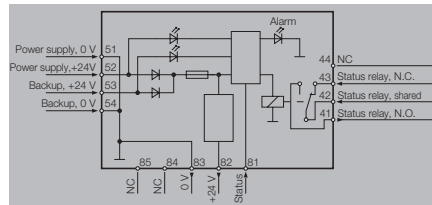

ACT20-Feed-In-BASIC-S

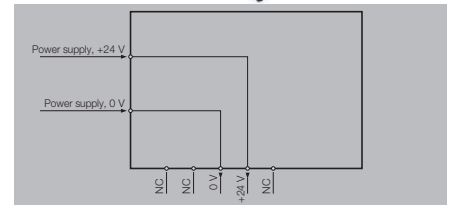

Technical data

Input	
Voltage supply	21.6...26.4 V DC
Input current	max. 4 A
Backup power supply	21.6...26.4 V DC
Trigger level for the power supply	Fault <21 V DC
Output	
Output current	Equivalent to input current, max. 4 A
Output power	96 W
Supply voltage (output)	24 V DC
Output, status relay in safe zone	
Max. switching voltage, AC / Max. switching voltage, DC	250 V /
Continuous current	2 A
AC power, max.	500 VA / 60 W
General data	
Degree of efficiency	0,976
Ambient temperature	-20...+60 °C
Power consumption	<2 W
Protection degree	IP20
Weight	140
Humidity	40 °C / 95 % rel. humidity, no condensation
Approvals	CE; cULus; DEKRAATEX; FMEX; IECExDEK

Input	
Voltage supply	21.6...26.4 V DC
Input current	max. 4 A
Backup power supply	21.6...26.4 V DC
Trigger level for the power supply	Fault <21 V DC
Output	
Output current	Equivalent to input current, max. 4 A
Output power	96 W
Supply voltage (output)	24 V DC
Output, status relay in safe zone	
Max. switching voltage, AC / Max. switching voltage, DC	250 V /
Continuous current	2 A
AC power, max.	500 VA / 60 W
General data	
Degree of efficiency	0,976
Ambient temperature	-20...+60 °C
Power consumption	<2 W
Protection degree	IP20
Weight	140
Humidity	40 °C / 95 % rel. humidity, no condensation
Approvals	CE; cULus; DEKRAATEX; FMEX; IECExDEK

Input	
Voltage supply	21.6...26.4 V DC
Input current	0.5...2.5 A DC
Backup power supply	21.6...26.4 V DC
Trigger level for the power supply	Fault <21 V DC
Output	
Output current	Equivalent to input current, 2.5 A
Output power	60 W
Supply voltage (output)	24 V DC
Output, status relay in safe zone	
Max. switching voltage, AC / Max. switching voltage, DC	250 V /
Continuous current	2 A
AC power, max.	500 VA / 60 W
General data	
Degree of efficiency	100 %
Ambient temperature	-25 °C...+70 °C
Power consumption	<2 W
Protection degree	IP20
Weight	70
Humidity	40 °C / 95 % rel. humidity, no condensation
Approvals	CCCEx; CE; cULus; DETNORVER; FMEX; IECExKEM; KEMAATEX; UKEX

Dimensions	
Clamping range (nominal / min. / max.)	mm ²
Length x width x height	mm
Note	

Screw connection		PUSH IN	
2.5 / 0.5 / 2.5	2.5 / 0.5 / 2.5	2.5 / 0.5 / 2.5	2.5 / 0.5 / 2.5
22.5 / 117.2	22.5 / 117.2	22.5 / 117.2	22.5 / 117.2
Note		Note	

Screw connection	
2.5 / 0.5 / 2.5	2.5 / 0.5 / 2.5
6.1 / 112.5	6.1 / 112.5
Note	

Ordering data

	Screw connection
	PUSH IN connection
Note	

Type	Qty.	Order No.
ACT20-FEED-IN-PRO-S	1	8965500000
ACT20-FEED-IN-PRO-P	1	2456870000

Type	Qty.	Order No.
ACT20-FEED-IN-BASIC-S	1	1282490000
ACT20-FEED-IN-BASIC-P	1	2825460000

Accessories

Note

DIN mounting rail, see Accessories

DIN mounting rail, see Accessories

ACT20X/ACT20C/ACT20P

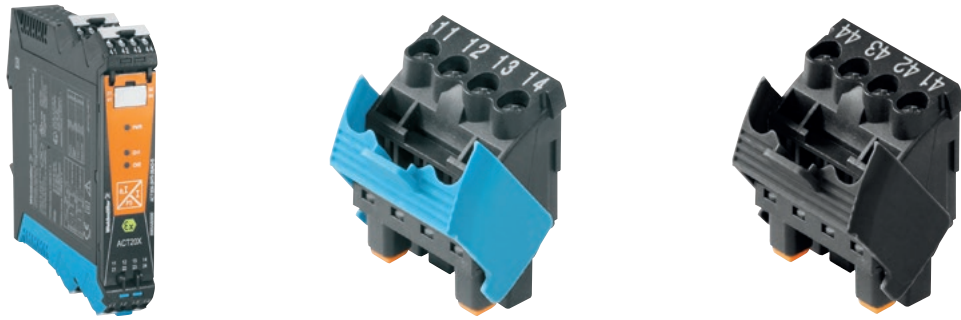

Connection terminals

Colour of housing	Release lever colour	Connection number	Printing	Type	Order No.	
black	blue	65/66/67/68	white	BHZ 5.00/04/90LH BK/BL PRT 65	1086480000	
		55/56/57/58	white	BHZ 5.00/04/90LH BK/BL PRT 55	1086470000	
		45/46/47/48	white	BHZ 5.00/04/90LH BK/BL PRT 45	1086460000	
		61/62/63/64	white	BHZ 5.00/04/90LH BK/BL PRT 61	1086420000	
		51/52/53/54	white	BHZ 5.00/04/90LH BK/BL PRT 51	1086410000	
		41/42/43/44	white	BHZ 5.00/04/90LH BK/BL PRT 41	1086400000	
	black	65/66/67/68	white	BHZ 5.00/04/90LH BK/BK PRT 65	1086240000	
		55/56/57/58	white	BHZ 5.00/04/90LH BK/BK PRT 55	1086230000	
		45/46/47/48	white	BHZ 5.00/04/90LH BK/BK PRT 45	1086220000	
		61/62/63/64	white	BHZ 5.00/04/90LH BK/BK PRT 61	1086180000	
		51/52/53/54	white	BHZ 5.00/04/90LH BK/BK PRT 51	1086170000	
		41/42/43/44	white	BHZ 5.00/04/90LH BK/BK PRT 41	1086160000	
	black	blue	35/36/37/38	white	BHZ 5.00/04/90LH BK/BL PRT 35	1086450000
			25/26/27/28	white	BHZ 5.00/04/90LH BK/BL PRT 25	1086440000
15/16/17/18			white	BHZ 5.00/04/90LH BK/BL PRT 15	1086430000	
31/32/33/34			white	BHZ 5.00/04/90LH BK/BL PRT 31	1086390000	
21/22/23/24			white	BHZ 5.00/04/90LH BK/BL PRT 21	1086380000	
11/12/13/14			white	BHZ 5.00/04/90LH BK/BL PRT 11	1086370000	
11/12			white	BHZ 5.00/02/90LH BK/BL PRT 11	1086250000	
21/22			white	BHZ 5.00/02/90LH BK/BL PRT 21	1086260000	
black		35/36/37/38	white	BHZ 5.00/04/90LH BK/BK PRT 35	1086210000	
		25/26/27/28	white	BHZ 5.00/04/90LH BK/BK PRT 25	1086200000	
		15/16/17/18	white	BHZ 5.00/04/90LH BK/BK PRT 15	1086190000	
		31/32/33/34	white	BHZ 5.00/04/90LH BK/BK PRT 31	1086150000	
		21/22/23/24	white	BHZ 5.00/04/90LH BK/BK PRT 21	1086140000	
		11/12/13/14	white	BHZ 5.00/04/90LH BK/BK PRT 11	1086130000	
41/42	white	BHZ 5.00/02/90LH BK/BK PRT 41	1086040000			

Cold-junction compensation terminals (optional for the ACT20X temperature modules)

1-channel	Release lever colour	Connection number	Printing	Order No.
black	blue	11/12/13/14	white	1160640000
2-channel				
black	blue	11/12/13/14	white	1160650000



Markers

Type	Version	Dimensions	Qty.	Order No.
ESG 66/20BHZ500/04	Individual markers	6.6 x 20 mm	200	1082540000
ESG 8/13,5/43,3 SAI AV	MultiCard (24 individual markers per MultiCard)	8 x 13.5 mm	5	1912130000

ACT20M



Ordering data markers

ACT20M marker
Note

Type	Qty.	Order No.
MS 5/7,5 MC NEUTRAL	320	1877680000
The ACT20M voltage supply is cross-connected using the CH20M rail bus. Details are available on pages C.14 and G.6		

ACT20P



Ordering data markers

ACT20P/X/C marker
Note

Type	Order No.
ESG 8/13.5/43.3 SAI AU	1912130000

Accessories MCZ



Ordering data end plates

Type	Qty.	Order No.
End plate		

Type	Qty.	Order No.
AP MCZ 1.5	50	8389030000



Ordering data cross-connection

Type	No. of poles
Plug-in cross-connection, yellow	2
Plug-in cross-connection, yellow	3
Plug-in cross-connection, yellow	4
Plug-in cross-connection, yellow	10

Type	Qty.	Order No.
ZQV 4N / 2 GE	20	1758250000
ZQV 4N / 3 GE	20	1762630000
ZQV 4N / 4 GE	20	1762620000
ZQV 4N / 10 GE	20	1758260000



Ordering data markers

Type	Qty.	Order No.
Multicard connector marker		

Type	Qty.	Order No.
WS10/6 MC	600	1828450000

Service and support

Service and support	Service connects - worldwide	V.2
	Engineering services and customised products	V.3
	easyConnect - Your Industrial Service Platform	V.4
	Support Center	V.6
	Additional support services	V.7
	Weidmüller Configurator: intuitive, uncomplicated & fast digital engineering	V.8
	Your digital ordering options at Weidmüller	V.10

Our expertise for your requirements

Service connects – worldwide



Automation technology functions are becoming more complex in a globally-oriented world facing ambitious targets in terms of energy efficiency and smart production. We are your equal partners for the best connections in Industrial Connectivity.

Our personal support answers all questions reliably and expertly. During planning, installation or operation our service and support offer is your best companion.

In short: Weidmüller's global service combines our expertise with your requirements.

V



Your way to our service
www.weidmueller.com/service

Engineering services and customised products

Automation engineering and connectivity consulting belongs to our services as well as assembly of engineered products. We also support the process from the idea to the product with our Weidmüller Configurator and the Configure-to-Order process.



Consulting and engineering

The challenge for you is reducing costs and increasing efficiency. This requires intelligent, individual solutions. Whether it is modified products, pre-fitted mounting rails or complete small cabinets – our application centres provide a highly qualified custom-made engineering and production service.



Connectivity Consulting

Increase your competitiveness - supported by our experts. Our drive is to optimise your competitiveness. That's why our team of experts supports you in significantly increasing your efficiency in electrical machine design and control cabinet construction. With proven products and services from the Weidmüller portfolio – and with the experience gained from over 300 projects worldwide.



Assembled terminal rails - Flexibly designed to suit your requirements

Your processes in panel building have to be fast, flexible and productive. This is the only way you can cut your costs and increase efficiency. Depending on the application in question, you will have different requirements with respect to the engineering service, delivery speed and flexibility to be provided.



Modified and assembled enclosures - Competitive advantages included

To compete internationally, your plants need to satisfy high standards of safety, quality and performance. The smart combination of consultation, application expertise and industry know-how is our key to finding a custom-fit solution for your application. Reduce costs and increase efficiency.

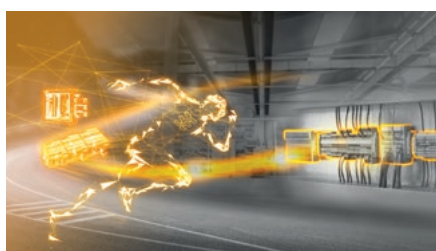

Fast Delivery Service - Your ideas deserve a quick realisation

Obtain offers 24/7 and within minutes, including directly orderable article numbers with our Fast Delivery Service. The Weidmüller Configurator (WMC) for planning and configuration is key for consistent processes. Dispatch your orders in 5 days. Assemble individual terminal strips and enclosures from batch size 1!

Your ticket to the world of digital service

easyConnect – Your Industrial Service Platform



Our cloud-based platform is your ticket to the world of digital services from Weidmüller, and the intuitive and future-proof tool for your way to the Industrial IoT. Realise your use cases easily, consistently and without any relevant prior knowledge, thanks to the perfect interaction of platform, devices and diverse software services.

As an open, modular and perfectly integrable system, the platform is your enabler for a wide range of use cases. Increase your efficiency and unleash your full innovation potential with easyConnect.

V



Interested in using easyConnect?

Learn how to get started with easyConnect step-by-step.

www.weidmueller.com/easyconnect

Why should you use easyConnect?

- You want to enter your digital transformation step-by-step?
- You want to make the step into Industrial IOT, but have no or little IT expertise?
- You want to use your digital data for smart & scalable services?
- You want to offer digital services (such as customised dashboard) to your customers?
- You want to improve your service offering and efficiency, e.g. through remote access?
- You feel Weidmüller's digital services are interesting, but you have „your cloud“ already?



Weidmüller comes up with the solution: easyConnect, the new digitalisation platform. It bundles Weidmüller's digital services at one place in the cloud and connects them with various Weidmüller devices.

With easyConnect you start digitalising your application step-by-step without ballast in a secure way.

The following services are initially available on easyConnect:

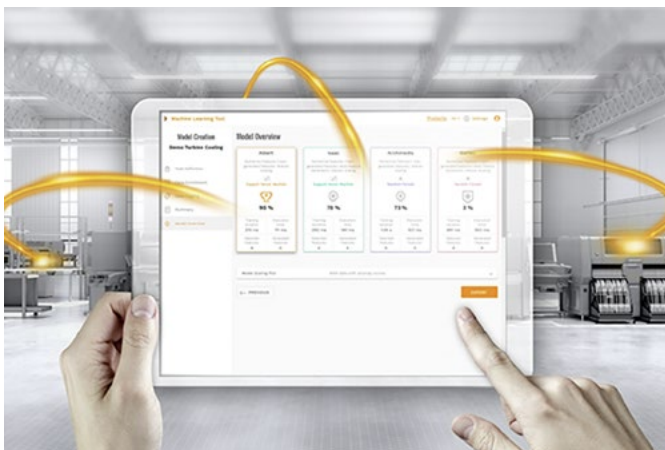

Device management

Adding and managing cloud-connected devices is typically the first step in any Industrial IoT use case.

Asset management

The asset management service is a modelling tool that allows users to model their assets and processes and link them to relevant time series data.

Remote access (u-link)

u-link guarantees a quick and secure access to machines and plants while also allowing for efficient management.

Data visualisation

easyConnect data visualisation services enable users to view, monitor and display live and historical data.

AutoML

With Weidmüller Industrial AutoML, you can optimize operations, increase product quality and develop new business models by benefiting from advanced analytics.

Expand the possibilities of our products

Our Support Center provides you with comprehensive, clear and personal assistance



Receive fast and intuitive support to get the most out of our products in your application. In our new Support Center you can search or navigate to the many application notes, product information, video tutorials or software downloads of our products.

- **Everything at a glance** – One central support hub, where all relevant information is available
- **Powerful search** – Provides filter functions for various types of information and products
- **Different views and navigations** – Content provided in views product information, engineering support or software downloads
- **More than 170,000 downloads** – Application notes, video tutorials, templates and examples, user documentation, engineering data, ...
- **Personal contact** – Direct access to your personal technical contact in your country



Explore the world of our new Support Center
support.weidmueller.com

Additional support services

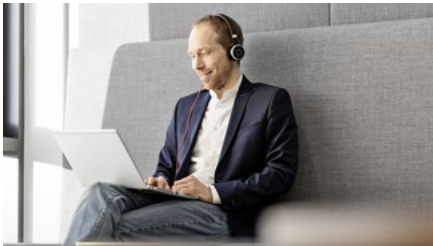

Training and Webinars

Stay tuned in a world that is accelerating. In our entertaining interactive webinars, we offer you the opportunity to learn about new products and technology topics and to interact with our experts.



Repairs and replacement parts

We offer repair and components for our Workplace Solutions as well as assistance for other Weidmüller products. Find out how our experts can help you with your repair request.



Security advisory board

Our Product Security Incident Response Team (PSIRT) continuously informs you about possible security-related vulnerabilities of our products.



Engineering data

For the quick integration of our products into your design, there are a lot of digital product data for engineering systems like EPLAN, Zuken E3.series, WSCAD and many others available for download.

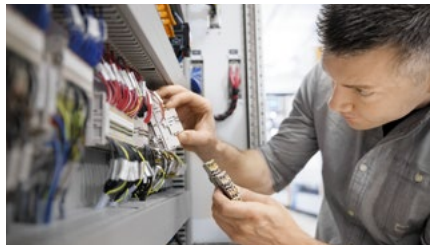

Product change notifications

Technical modifications of our products always available online.



Technical product catalogues

Technical data for our entire program in Industrial Connectivity for download in PDF-format.

From the idea to the finished solution

Weidmüller Configurator: intuitive, uncomplicated & fast digital engineering

Digital engineering can be so easy – with the Weidmüller Configurator!

It's a **free to use** software application to easily configure industrial solutions. It features more than **12,000 articles** from multiple product families including rail-mounted components, industrial and ex-certified enclosures, Heavy Duty Connectors, remote I/O-systems and PCB connectors.

Unleash the full power of digital engineering:

Our application wizards help you choose the right articles.

Place, mark or modify them to your needs and get your solution **visualized in 3D** – what you see is what you get!

Our promise: Speed up your solution planning process by up to 70%!

Your benefits:

- **Proven configuration designs in real 3D:** The plausibility and collision check with the complete digital documentation ensures that you can rely 100% on your configuration.
- **Seamless E-CAD Roundtrip:** Interfaces enable the simple exchange of product data between the WMC and all common engineering tools, such as Zuken E3 or EPLAN Electric P8.
- **Sample Service & Fast Delivery Service:** to support your design-in process, we offer a **3-day sample service** for many products. Inquire them directly online – for free!
You want your solution right away? Our **Fast Delivery Service** guarantees delivery of individually assembled terminal strips or enclosures within a few days.

Get started online now!

The Weidmüller Configurator makes solution planning easy. Visit our website for more information, tutorials and download it for free:



www.weidmueller.com/wmc



or register on easyconnect.weidmueller.com and use it online.



Wizards:

Design complete applications within few clicks – even without detailed product knowledge – for signal wiring, load monitoring, instrument transformers, enclosures, remote I/O-systems and many more.

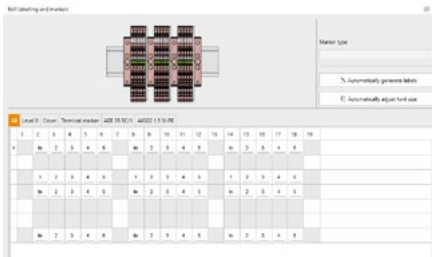

Assistants:

Finalize your solutions with supporting assistants to add cross-connectors, markers or colors and verify the faultlessness. Automatic modes save valuable time!



1-click documentation:

Get assembly drawings for production – only 1 click. Bill of material – only 1 click. The complete solution documentation including all component data sheets – you’re right, only 1 click!



Digital ordering options

Your digital ordering options at Weidmüller

Find and easily select the products you need, with convenient ordering: as your Partner in Industrial Connectivity, we know what counts in purchasing. That is why we offer you a variety of options for ordering products from us and optimising your purchasing processes to meet your individual requirements and your workflow. The choice is yours.

Order via the Weidmüller eShop

Our eShop offers you access to the complete Weidmüller product range around the clock – directly from a PC, tablet, or smartphone. The intuitive user guidance supports you as you select from over 50,000 products. Technical data, prices, and availabilities are available at any time. The shopping basket with check out function lets you place an order in seconds. Convenient additional functions like CSV upload, order history, reports, or custom order templates make your ordering processes even more efficient.

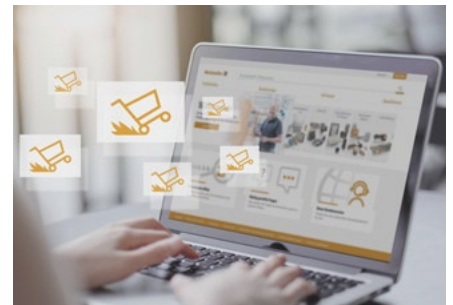

Order via the OCI interface

The Open Catalogue Interface (OCI) facilitates the exchange of data between your enterprise resource planning system and our eShop. This means that our eShop is integrated into your system via an OCI interface, so you have access to our complete product catalogue from your enterprise resource planning system. You can filter and select products, place them in your shopping basket and place direct orders without changing your software application. The open OCI standard is supported worldwide from a variety of software providers.

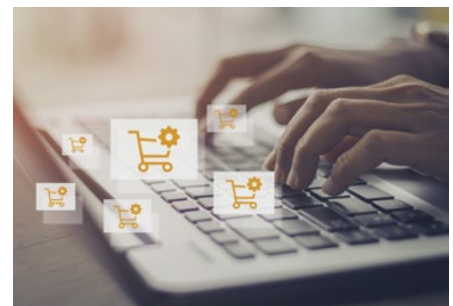

Order via the EDI interface

Our Electronic Data Interchange (EDI) also offers you the option of ordering our products directly from your enterprise resource planning system. All order data is transmitted automatically to our system and processed immediately. Orders, order confirmations, invoices, and delivery notices are transmitted lightning fast. This helps you make your purchasing processes even more efficient.



We will be glad to advise you on which solutions are suitable for you and how implementation is possible.

Get in touch with us

www.weidmueller.com/digital-order

Technical appendix/Glossary

Technical appendix/Glossary	Dimensioned drawings	W.2
	Introduction	W.3
	Technical data	W.4
	FDT/DTM - The standard solution for device configuration	W.5
	EX basics	W.7
	ATEX	W.11
	Electrical data	W.13
	Glossary	W.14

Dimensioned drawings

ACT20X/ACT20C/ACT20P

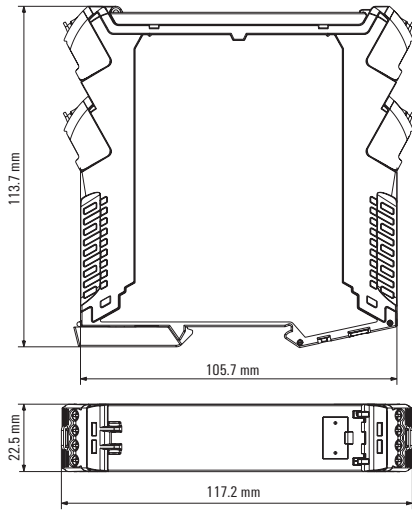

ACT20X HUI-SAO-LP-S

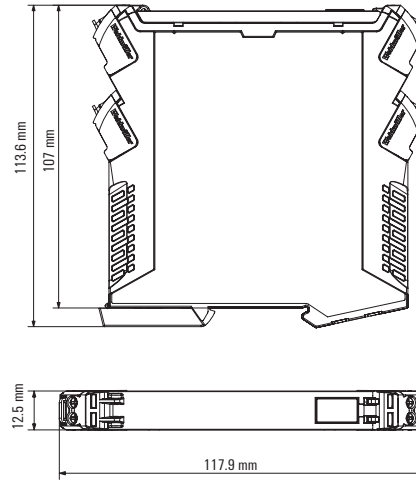

ACT20M – Dimensioned drawings

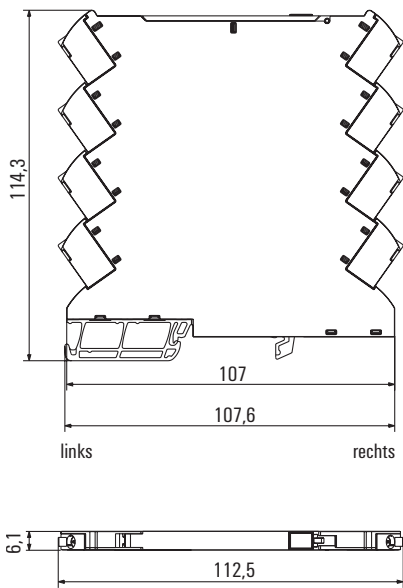

MCZ

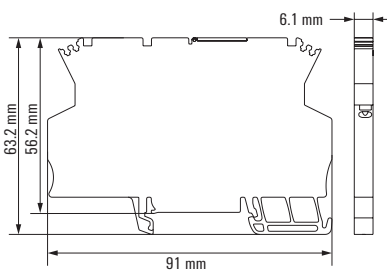

W

Different types of analogue signalling

The working environment can be measured in many different forms, e.g. in terms of temperature, humidity or air pressure. The values of these physical variables change constantly. Components that monitor the status and changes of a given environment and provide alerts of any changes must be able to continuously display the changes taking place.

In industrial and process automation, the outputs received from field sensors, switches and transmitters provides measurement and status data which becomes the analogue and digital inputs (AI and DI) for the control system. Similarly, control signals are passed from the control system to field control equipment such as analog and digital valves and actuators.

If automation processes are expected to reach certain statuses or keep them constant, then analogue signal conditioning is required. It is also important in areas where this has already been part of long established practice, e. g. in process engineering or the chemicals industry.

In process engineering, standardised electrical signals are normally used. Currents of 0 ... 20 mA, 4 ... 20 mA or voltages of 0 ... 10 V have become established as the output variables for sensors recording various different physical parameters.

Weidmüller takes account of the growing preference for automation – including and the resulting need for analogue signal conditioning – and offers a wide range of products tailor-made to the requirements involved in handling sensor signals. Units for the common signals (0 ... 20 mA, 4 ... 20 mA, 0 ... 10 V) generate an output signal as a proportional value of the variable input signal. "Protective separation", e.g. of the sensor circuit from the evaluation circuit, is also taken into account. "Protective separation" prevents mutual interference among several sensor circuits, e.g. as in the case of earth loops in interlinked measuring circuits.

The wide range of Weidmüller products completely covers the functions involved in signal conversion, signal separation and signal monitoring. The products can thus handle nearly all applications in industrial measuring technology, and safeguard elementary functions between field signals and further processing systems. The mechanical properties of the products are built up around a consistent concept.

Signal converters can be used with other Weidmüller products and combined with each other. They are designed to entail a minimum wiring workload and maintenance in both electrical and mechanical terms.

The product range contains the following functions:

- DC/DC converters
- Current converters
- Voltage converters
- Temperature converters for resistance thermometers (RTDs) and thermocouples
- Frequency converters
- Potentiometer transducers
- AC transducers
- Bridge transducers (strain gauges)
- Threshold monitoring modules
- AD/DA converters

The products are available as pure signal converters, or with 2-port or 3-port isolation and a choice of passive or output loop powered or auxiliary powered, depending on the application requirements.



Technical data



Common Mode Noise Elimination

- Generally, signals emitted by sensors have low levels and are thus susceptible to capacitive and inductive interference, such as those generated by motors, frequency changers and other change processes. This noise contents the measuring value and frequently destroys expensive analog I/O cards in the control electronics. Through the utilisation of analogue signal isolators this interference, which usually actions both signal lines in common mode (push push), is effectively eliminated through the zero potential input.

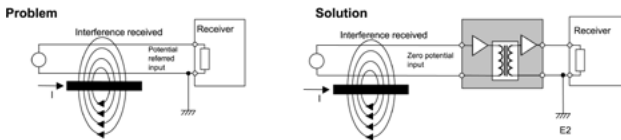

Active Isolator / Passive Isolator

- Active isolators draw their power supply from a separate supply terminal to ensure that they can operate perfectly. Depending upon the applications the input, output and additionally the power supply are isolated from each other. Only one supply is required for 3-port isolation. However, it is isolated from the input and output circuits. Thus even in the event of a short circuit, surge voltage or reverse polarity, the downstream control electronics cannot be damaged. Isolating the signals between the input and output can be conducted either optically or by transformer barrier depending upon the transfer rate. Active isolators are non interacting, i.e. a change in the load does not exert any influence on an input circuit.
- Passive isolators generate the current required for the supply from the measuring signal. The current required internally is so small that transfer problems do not occur here.
- The feed can be effected from either the input or the output side. Isolation is by transformer barrier. The advan-

tages are: cessation of network influences, outstanding accuracy, low signal delay and low potential requirement. Passive isolators are not interacting; a change in load in the output circuit will influence the input circuit.

Ground Loops

- The voltage supply's secondary side is earthed for the purpose of setting up fast and secure ground loop monitoring. If an analogue signal is fed in from a separate voltage supply or if the sensing device itself is earthed, then transient currents will flow between the ground potentials across the interconnected ground connectors, which in turn corrupts the measuring signal. Analogue signal isolating amplifiers prevent this form of measuring signal corruption and influence.

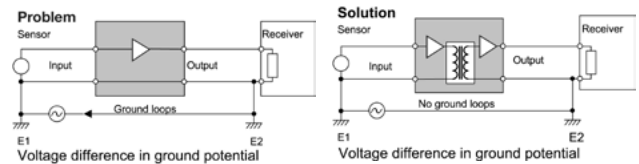

2-port Isolation

- The simplest form of analogue signal isolator is that of 2-port isolation. It serves to isolate the input circuit from the output circuit as well as the two auxiliary voltages from each other. Depending upon the isolator design and the observed isolation data one refers here to base isolation (galvanic isolation) or safe separation. ① For current signals, 4...20 mA input current loop fed modules are available. An additional auxiliary voltage for the input circuit is not required here. ② By connecting the input and output side voltage supplies, the 2-port isolation can be converted to operate as a simple signal converter. This is of particular interest where isolation is not required for an application, but a signal conversion has to be performed.



FDT/DTM – The standard solution for device configuration

Field Device Tool (FDT)

FDT technology specifies and standardises the integration of communicating devices from different manufacturers. It makes use of a superimposed device management program. The key feature is its independence from the communication protocol and software used by the device and the host system. FDT allows access to any device from any host using any protocol.

Device Type Manager (DTM)

Device manufacturers make available a Device Type Manager (DTM) software driver for each device or device group. The DTM specifies all device-specific information, functions and rules (such as the device structure, communication capabilities, internal dependencies and the human-machine interface (HMI)). DTMs define functions for access to device parameters, troubleshooting, configuration and operation of devices. DTMs are available which can be simple GUIs for setting device parameters or more complex applications that are capable of carrying out calculations for diagnostic or maintenance purposes.

There are several different types of DTMs:

- **Device DTM**
This is a “normal” field device that uses communication channels to communicate with the connected physical device.
- **Communication DTM**
This is a communications device that provides communication using communication channels. Communication channels provide access to the communications infrastructure (such as PC interface cards or modems). They are used by device DTMs or gateway DTMs for communication services.
- **Gateway DTM**
This is a gateway device. It allows data to be exchanged between two communication channels. For example, this could be a gateway between PROFIBUS-DP and PROFIBUS-PA.

The DTM is loaded and started up within a FDT container program or “frame” application.



FDT/DTM – Der Standard für die Gerätekonfiguration

FDT frame application

Frame applications can be used as a tool to configure devices, plan projects, operate consoles or administer facilities. The FDT frame application provides a PC software environment with the following functions:

- User administration
- DTM administration
- Data management
- Network configuration
- Navigation

Weidmüller offers their WI-Manager FDT frame program to the user for no cost. This certified software is compatible and works together with all certified DTMs. This screenshot shows the WI-Manager with an opened DTM for the ACT20X series.

Download at www.weidmueller.com!

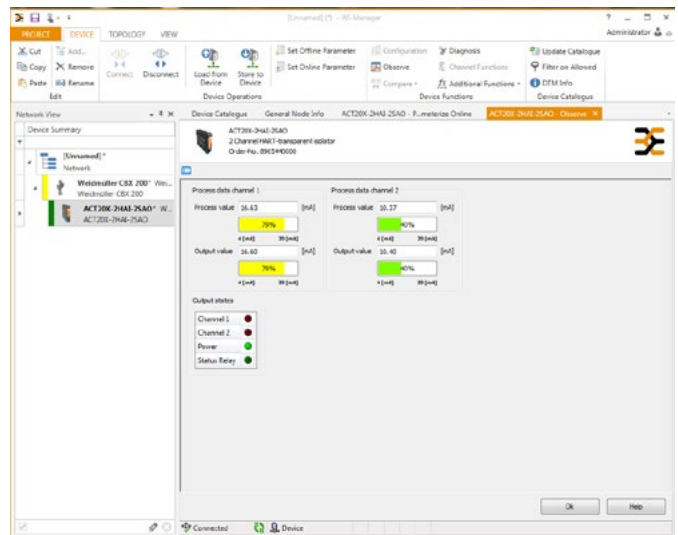

FDT User Group

The FDT User Group is an alliance of users and manufacturers interested in defining the specifications and moving the FDT/DTM technology forward. Weidmüller is a member of this group along with most process automation manufacturers and work towards advancing this standard further.

More details are available at <http://www.fdtgroup.org/>

Safety in hazardous areas

The European ATEX Regulation applies to facilities and their usage in hazardous areas.

The term "ATEX" derives from the French phrase "Atmospheres Explosive". The regulation currently includes two directives from the European Union concerning explosion protection. These are the ATEX operational directive 1999/92/EG (ATEX 137) and the ATEX product directive 94/9/EG (ATEX 95). The ATEX 137 operational directive specifies the minimum requirements for improving the protection of health and security of workers in environments at risk of explosions. The ATEX 95 product directive specifies the rules for introducing products on the market that will be used in zones where there is risk of explosion. This directive is the first to include non-electric devices within its jurisdiction.

The purpose of the directive is to protect personnel who work in hazardous areas. Appendix II of the directive contains the basic health and safety requirements. These must be followed by the manufacturer and compliance must be proven by declarations of conformity. Since June 30, 2003, all devices, components and protective systems brought to the market must be in compliance with the ATEX 95 product directive.

The ATEX 95 directive classifies devices and components for the Ex zone into two main groups:

Group I

=> Devices for use in mining, for underground and above-ground operations

- Coal dust
- Methane
- Harsh operating conditions

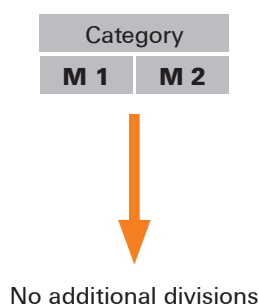

Group II

=> Devices for use in the other hazardous areas

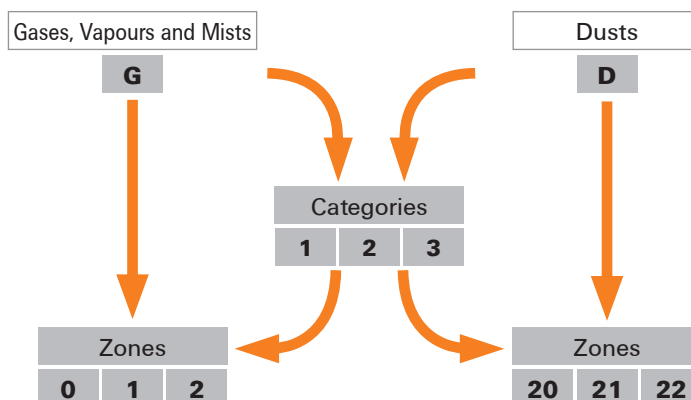

For applications in the oil, gas and chemical industries, it is particularly important to follow the Group-II "G" requirements concerning electrical or electronic devices and components.

Group II "G" divides the Ex zone into three zones with different safety requirements.

- Zone 0** This zone applies to dangerous explosive atmospheres where the risk is present often or over long time periods.
 => > 50 % of the operational time, or more than 1.000 hours per year.
- Zone 1** This zone applies to situation where explosive atmospheres may occasionally be present during normal operations.
 => Occasionally, less than 10 hours per year.
- Zone 2** This zone applies to situation where explosive atmospheres are normally not present or only briefly present during normal operations.
 => Max. 30 min/year.

Hazardous areas

	Zone 0	Zone 1	Zone 2	Safe zone
Explosion risk	Continual, long-term, often	Occasionally	Rarely	None
Spark source	None	Rarely and short-term	Occasionally	Continual, long-term, often

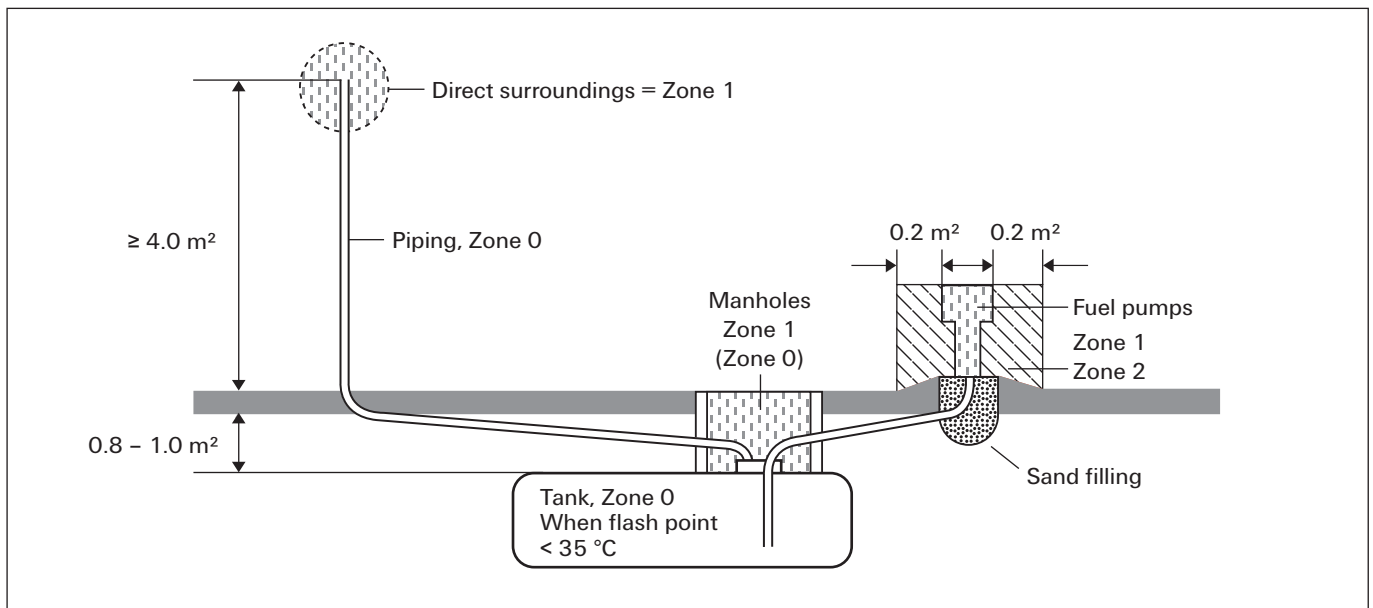

Typical division of zones at a fuelling station

W

Safety in hazardous areas

In which operations are ATEX-certified electronic devices (such as signal converters, isolation amplifier, Namur switches and switching amplifiers) used?

ATEX-certified devices are used within industrial facilities and production halls where there is the possibility that explosive gases or dusts may be released.

Transportation and production applications which require the use of such certified devices are listed below:

- Off-shore oil and gas drilling
- Tanker ships which carry oil, gas or chemicals
- Ships which carry potentially explosive materials
- Refineries and other oil or gas production plants
- Transportation and filling stations for oil and gas
- Petro-chemicals

What are the differences between standard devices and intrinsically safe devices?

For electronic devices that are being used in Zone 0(20) or 1(21), none of the components or electrical circuitry are permitted to generate unallowable high temperatures or sparks, whether during normal operations or during malfunctions. In other words: "All of the circuits in intrinsically safe electrical devices (Ex i) are safe and are not capable of igniting explosive atmospheres".

What is the device category?

The device Group II (hazardous areas not including underground or above-ground mining operations) is divided into device categories 1, 2 and 3. They have the following safety levels:

Surroundings	Device category	Occurrence and duration of explosive atmosphere	Ignitable materials	Safety levels Permitted errors	Groups and zones Comparison
Group II	1	Constantly occurring Long-term Regularly	Gases, vapours, mist, dust	Very high safety level 2 different protection classes or 2 independent errors	Group II Zone 0 (gas) Zone 20 (dust)
Group II	2	Occurrence probable over a limited time period	Gases, vapours, mist, dust	High safety level 1 protection class For which no more than one error may occur	Gruppe II Zone 1 (gas) Zone 21 (dust)
Group II	3	Occurrence improbable Only for short periods	Gases, vapours, mist, dust	Normal I safety level Required protective measures	Group II Zone 2 (gas) Zone 22 (dust)

Safety in hazardous areas

IEC (group II) Classification	Max. surface temperature	Comment
T1	450 °C (842 °F)	The temperature is relevant to all parts of the devices that can come into contact with potentially explosive materials.
T2	300 °C (572 °F)	
T3	200 °C (392 °F)	
T4	135 °C (275 °F)	
T5	100 °C (212 °F)	
T6	85 °C (185 °F)	
Tx	Max. surface temperature undefined	Valid for the closed tank systems used on container ships where the individual contents cannot be monitored in event of a fire. It is the responsibility of the operator to assess each temperature class.

What labelling is considered proper?

An example of device labelling:

CE 0539		II	2	G	Ex ia	IIA	T4
↓	↓	↓	↓	↓	↓	↓	↓
Certification authority ex. DEMKO	European Commission mark for Ex devices	Device group "Surface"	Device category zone 1	Gas	Protection explosion type: intrinsically safe category <ia>	Gas group	Surface temperature: max 135 °C

ATEX directives

Since July 1, 2003, all new facilities in hazardous areas must be certified according to ATEX Directive 94/9/EG or ATEX 95 (ATEX: ATmosphère EXplosive = explosive atmosphere). This directive is one of the “New-Approach” directives. It is valid in all European Union countries, as well as Iceland, Lichtenstein and Norway. In these countries, the directive refers to the sale and commissioning of products which have been designed particularly for high explosion risk environments (where explosive atmospheres exist due to gases, vapours, mists, or dusts). It now also covers the mining sector and purely mechanical devices.

Class of protection

Type of protection	Code	CENELEC EN	IEC	Product category explosion protect.
General requirements	-	60079-0	60079-0	-
Oil immersion	o	60079-6	60079-6	2
Pressurised apparatus	p	60079-2	60079-2	2
Powder filling	q	60079-5	60079-5	2
Flameproof enclosure	d	60079-1	60079-1	2
Increased safety	e	60079-7	60079-7	2
Intrinsic safety	ia	60079-11	60079-11	1
Intrinsic safety	ib	60079-11	60079-11	2
Intrinsic safety	ic	60079-11	60079-11	3
Typ n (Ex n)	n	60079-15	60079-15	3
Encapsulation	m	60079-18	60079-18	2

Classification for potentially hazardous areas

CENELEC classification IEC60079-10	Presence of potentially explosive atmosphere	Product-category	US classification NEC 500	Combustible media
Zone 0	permanent, long-term	1G	Class I, Div 1	gases, vapours
Zone 20	or frequently	1D	Class II, Div 1	dust
Zone 1	occasionally	2G	Class I, Div 1	gases, vapours
Zone 20		2D	Class II, Div 1	dust
Zone 2	rarely and	3G	Class I, Div 2	gases, vapours
Zone 22	briefly	3D	Class II, Div 2	dust

Explosion groups

Gas (e.g.)	CENELEC	NEC 500
Propane	IIA	D
Ethylene	IIB	C
Hydrogen	IIC	B
Acetylene	IIC	A
Methane (mining)	I	mining (MSHA)

Temperature classes

Max. surface temperatur (°C)	Temperature class CENELEC	Temperature class NEC 500-3
450	T1	T1
300	T2	T2
280	-	T2A
260	-	T2B
230	-	T2C
215	-	T2D
200	T3	T3
180	-	T3A
165	-	T3B
160	-	T3C
135	T4	T4
120	-	T4A
100	T5	T5
85	T6	T6

Labelling for ATEX approval of a signal converter

II 3 G Ex nAnCnL IIC T4

- II** = Device group 2: devices for use in hazardous areas (except for mines and above-ground mining facilities that are exposed to flammable dusts or methane)
- 3** = Device category 3: the danger occurs rarely or only for short periods. The requirement is for normal security, suitable for use in zone 2.
- G** = Intended for the gas zone
- Ex** = Explosion protection
- nA** = Non-sparking equipment
- nC** = Enclosed facility (suitable protection)
- nL** = Equipment with limited power
- IIC** = Explosion groups: typical gas for C is hydrogen
- T4** = Temperature class: The max. permitted surface temperature for T4 is 135 °C

Zone 2 a zone for which, during normal operations, there is at most, only a short-term occurrence of dangerous hazardous atmospheres (mixtures of air and flammables gases, vapours or mists).

II (1) G [Ex ia] IIC/IIB/IIA

- II** = Device group 2: devices for use in hazardous areas (except for mines and above-ground mining facilities that are exposed to flammable dusts or methane)
- (1)** = Device category (1): Equipment from category 1 can be connected to this signal converter. The signal converter must be operated in the safe zone or in zone 2 (II 3 G ...).
- G** = Intended for the gas zone.
- [Ex ia]** = Explosion protection type: protected with intrinsic safety. This signal converter, as accompanying equipment, is intended to be used for the connection of intrinsically safe circuits.
- IIC/IIB/IIA** = Explosion groups – typical gases: propane for A, Ethylene for B, and hydrogen for C.

II (1) D [Ex iaD]

- II** = Device group 2: devices for use in hazardous areas (except for mines and above-ground mining facilities that are exposed to flammable dusts or methane)
- (1)** = Device category (1): Equipment from category 1 can be connected to this signal converter. The signal converter must be operated in the safe zone or in zone 2 (II 3 G ...).
- D** = Designed for the dust zone.
- [Ex iaD]** = Explosion protection type: protected with intrinsic safety. This signal converter, as accompanying equipment, is intended to be used for the connection of intrinsically safe circuits.



Design of clearance and creepage distances in electrical equipment – influencing factors

Rated impulse withstand voltage

The rated impulse withstand voltage is derived from:

- **Voltage conductor – earth**
(the rated voltage of the network, taking into account all networks)
- **Surge category**

Table 1: Rated impulse withstand voltages for electrical equipment

Rated voltage of power supplies system *) in V		Rated impulse withstand voltage in kV			
Three-phase systems	Single-phase systems with neutral point	Electrical equipment at the supplies point of the installation (Surge category IV)	Electrical equipment as part of the permanent installation (Surge category III)	Electrical equipment to be connected to the permanent installation (Surge category II)	Specially protected electrical equipment (Surge category I)
	120 to 240	4.00	2.50	1.50	0.80
230/400					
277/480		6.00	4.00	2.50	1.50
400/690		8.00	6.00	4.00	2.50
1000		Values depend on the particular project of, if no values are available, the values of the preceding line apply.			

*) to IEC 38

Surge categories

are stipulated in accordance with the German standard DIN VDE 0110-1 (for electrical equipment fed directly from the low-voltage network).

Surge category I

- Equipment that is intended to be connected to the permanent electrical installation of a building. Measures to limit transient surges to the specific level are taken outside the equipment, either in the permanent installation or between the permanent installation and the equipment.

Surge category II

- Equipment to be connected to the permanent electrical installation of a building, e.g. household appliances, portable tools, etc.

Surge category III

- Equipment that is part of the permanent electrical installation and other equipment where a higher degree of availability is expected, e.g. distribution boards, circuit-breakers, wiring systems (including cables, busbars, junction boxes, switches, power sockets) in the permanent installation, and equipment for industrial use and some other equipment, e.g. stationary motors with permanent connections to the permanent installation.

Surge category IV

- Equipment for use at or near the power supplies in the electrical installations of buildings, between the principal distribution and the mains, e.g. electricity meters, circuit-breakers and centralised ripple controllers.

Pollution severity categories

Pollution severity category 1

- No pollution, or only dry, non-conductive pollution that has no influence.

Pollution severity category 2

- Non-conductive pollution only; occasional condensation may cause temporary conductivity.

Pollution severity category 3

- Conductive pollution, or dry, non-conductive pollution that is liable to be rendered conductive through condensation.

Pollution severity category 4

- Contamination results in constant conductivity, e.g. caused by conductive dust, rain or snow.

Unless explicitly stated otherwise, the measurement of clearance and creepage distances and the resulting rating data for electromechanical components is based on pollution severity 2 and surge category III, taking account of all network types.

Glossar

C

Cold-junction compensation	Thermocouples require a temperature reference point to compensate for unwanted "cold junctions". The usual method for achieving this is by measuring the temperature at the reference junction with a temperature sensor that can be read immediately. The interfering voltage can then be compensated for in the measurement results. This process is referred to as cold-junction compensation (CJC).
-----------------------------------	---

D

Device categories	The device category determines which equipment can be used in which zone. There are six device categories. The categories 1 G, 2 G and 3 G are classifications for gas explosion protection (G = Gas). Equipment with 1 G is suitable for zones 0, 1 and 2. Equipment with 2 G is suitable for zones 1 and 2. Equipment with 3 G is suitable for zone 2. The categories 1 D, 2 D and 3 D are classifications for dust explosion protection (D = Dust). Equipment with 1 D is suitable for zones 20, 21 and 22. Equipment with 2 D is suitable for zones 21 and 22. Equipment with 3 D is suitable for zone 22.
DTM	DTMs (D evice T ype M anager) are software drivers that are vendor- and device-neutral. DTMs define functions for access to device parameters, troubleshooting, configuration and operation of devices. The DTM specifies all device-specific information, functions and rules (such as the device structure, communication capabilities, internal dependencies and the human-machine interface (HMI)). Device manufacturers make available a Device Type Manager (DTM) software driver for each device or device group.

E

Explosion groups	Depending on the ignition protection, explosion-protected equipment intended for gases, vapours and mists are divided into three explosion groups (IIA-IIB-IIC). The explosion group provides a measure of the explosive break-through capability of gases (in an explosive atmosphere). The requirements for the equipment increase in strictness from II A to II C.
-------------------------	---

Explosion protection types	<p>The ignition protection type is a term used in explosion protection that refers to the various types of protective construction designed into the product. Ignition protection types are formulated to minimise the risk that an ignition source will be present in an explosive atmosphere.</p> <p>The following ignition protection types are specified:</p> <ul style="list-style-type: none"> • For electrical equipment in a gas <ul style="list-style-type: none"> • Intrinsic safety Ex i • Pressure-resistant Ex d encapsulation • Increased safety Ex e • Pressurization encapsulation Ex p • Oil immersion Ex o • Moulded encapsulation Ex m • Sand encapsulation Ex q • Ignition protection type for zone 2 Ex n • Special ignition protection type Ex s • For electrical equipment in dust <ul style="list-style-type: none"> • Pressurization encapsulation Ex pD • Intrinsic safety Ex iD • Moulded encapsulation Ex mD • Protection provided by housing Ex sD
-----------------------------------	--

F

FDT	<p>FDT technology (Field Device Tool) specifies and standardizes the connection of communication-capable devices from different manufacturers with a higher-level device management program. The most important feature is its independence from the communication protocol and software environment of the device and the host system. FDT allows access to any device from any host through any protocol.</p>
------------	---

G

Galvanic isolation	<p>Potential-free isolation between electrical components.</p> <p>Normally, the inputs circuit, output circuit and power supply are designed so that they are electrically isolated from each other. The isolation can be achieved using optical means (an optocoupler) or by using a transformer. The electrical isolation of measurement signals ensures that the differences in earth potentials and common-mode interference are suppressed</p>
---------------------------	---

Ground loops

A major problem for faults in process systems is the ground loop. A ground loop occurs when two or more circuits are connected together and referenced to a ground or reference point. These reference points rarely have the same electrical potential at each point. When the two ends of a line are grounded at different points, the voltage difference between the two ground potentials within the line results in a compensating current that distorts an analog measurement signal. This is true if the sensor is separately powered or grounded in the field. Analog signal isolation amplifiers prevent this influence on the measurement signals by galvanic isolation between the input and output circuits.

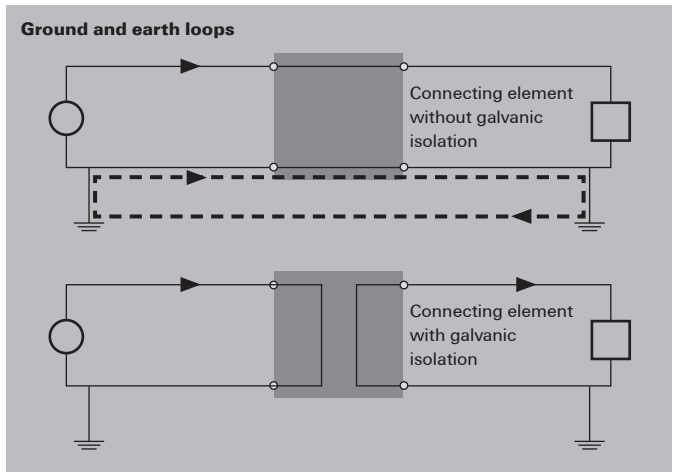

H

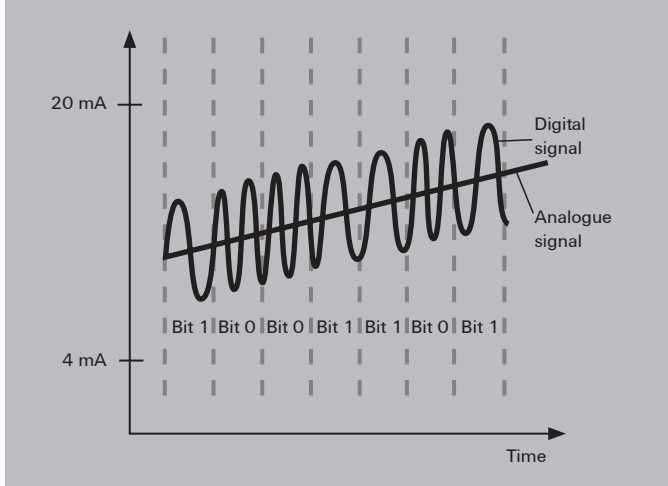
HART®	<p>HART® (Highway Addressable Remote Transducer) is a communications protocol for bus-addressed field devices used in process automation. In HART®-based communications, field devices and controllers are connected together over 4–20 mA current loops. This analogue signal is superimposed with a digital signal by using the FSK process (Frequency Shift Keying). The process allows additional measurements, configuration and device data to be transmitted without influencing the analogue signal. Ex isolators can also be used in hazardous areas.</p> 
Hazardous area	<p>According to the ATEX directive, an hazardous area is where the extent of the explosive atmosphere mandates that extra measures must be taken to safeguard health and protect surrounding machinery. Hazardous areas are classified according to the frequency and duration of the occurrence of the explosive atmosphere (refer to the sub-divided zones).</p>
<h2>I</h2>	
Insulation voltage	<p>For electronics components with electrical isolation, this is the maximum AC test voltage that can be applied for a specified time interval (5 s / 60 s) without causing a break-through.</p>
Intrinsically safe electrical equipment	<p>Equipment that is used directly in hazardous areas or that can detect signals from the hazardous area or directly control actuators there.</p>

Intrinsic safety “i”	<p>Electrical equipment for hazardous areas with the ignition protection type “Intrinsic safety Ex i” Intrinsic safety is divided into ignition protection types “ia” or “ib” The ignition protection type “intrinsic safety” is a protective strategy that requires a complex analysis of electronic devices. So it is not only important to protect intrinsically safe current from the other unsafe circuits. It is also important to limit the open-circuit voltage, short-circuit current, power, stored energy and the surface temperature of components that will be exposed to the explosive atmosphere.</p> <p>Intrinsically safe circuits are circuits where a spark or thermal effect (as may occur under the testing conditions specified by EN 60079-1 1) is not capable of igniting an explosive atmosphere (of sub-groups IIA, IIB or IIC) or a dust-air mixture. The testing conditions cover normal operations and certain error conditions as specified in the standard.</p>
Isolation amplifier (active isolator)	<p>An isolation amplifier is used to provide electrical isolation for analogue standard signals. They are designed with 2-way or 3-way isolation. The isolation of the potentials eliminates interference on the measurement signal that can be caused by earth loops or common-mode noise. The active isolator makes use of a separate voltage source for its power supply. It functions without feedback; a change on the output side load does not influence the input circuit.</p>

L

Linearisation	<p>Temperature-dependent components normally do not have a linear characteristic curve. Their characteristic curves must be linearised so that they can be evaluated as precisely as possible. The measurement curves of thermocouples and temperature-dependent resistors (NTC/ PTC), in particular, exhibit significant deviation from an “ideal curve”. In the linearisation process, the measurement signal is processed by a microprocessor and an ideal characteristic curve is generated which can then be analysed or processed further.</p>
----------------------	--

M

Measurement isolating transformer	<p>Converts electric and non-electric input signals into standard analogue signals. At the same time it provides electrical isolation between the input and output (2-way isolation) or between the input, output and supply (3-way isolation). Measurement isolators are typically used to record temperatures (RTD, thermocouples) or for measuring current, voltage, power, frequency, resistance and conductivity.</p>
Measuring bridge	<p>Sensors based on Wheatstone bridge circuitry can capture force, pressure and torque. Relatively small length changes under 10 – 4 mm can be recorded using DMS strain gauges in the form of resistance changes. A typical application is for capturing measurements in load cells.</p>

W

N

Namur sensor	<p>NAMUR-compliant sensors (The standardization commission for measuring and control technology in the German chemical industry) operate with a load-independent current. They have four modes so that an analogue evaluative unit can detect a sensor malfunction.</p> <ol style="list-style-type: none"> 1) Current of 0 mA => wire break, circuit is open 2) Current of approx. 20 % of the max. value => Sensor ready, activated 3) Current of approx. 60 % of the max. value => Sensor ready, not activated 4) Current at max. value => short circuit, max. current <p>NAMUR sensors are suited for use in hazardous areas.</p>
---------------------	--

O

Output-current loop-powered	<p>Output loop powered 2-wire transmitters have a 4 – 20 mA output. The transmitter is supplied with power via the current loop on the output side. A typical loop consists of a regulated DC power supply, the 2-wire transmitter and a receiving device.</p>
Overvoltage category	<p>The overvoltage categories are described in DIN EN 60664-1. The category dictates the insulation clearance gaps required. Category III is the default specification (EN 50178).</p> <ul style="list-style-type: none"> • Overvoltage category I Devices that are intended to be connected to the permanent electrical building installation. The measures for limiting transient surge voltages to the proper level are taken outside of the device. The protective mechanisms can either be in the permanent installation or between the permanent installation and the device. • Overvoltage category II Devices that are intended to be connected to the permanent electrical building installation (such household appliances or portable tools). • Overvoltage category III Devices that are a part of the permanent installation and other devices where a higher degree of availability is required. This includes the distributor panels, power switches, distribution systems (including cable, busbars, distributor boxes, switches and outlets) that are part of the permanent installation, devices intended for industrial use, and devices that are continually connected to the permanent installation (such as stationary motors). • Overvoltage category IV Devices that are intended to be used on or near the power feed in a building's electrical installation – ranging from the main distribution to the mains power system. This includes electrical meters, surge protection switches and ripple control equipment.

P

Passive isolator/ input loop powered	<p>Generates its power supply from the input signal (0/4–20 mA). The amount of current needed internally is so small that the measurement signal is not influenced. Transformers are used to provide the isolation between the input and the output.</p> <p>The advantages include: eliminates the influence of the mains power system, highly accurate, minimal signal delay, and minimal power used. Passive isolators do not function free from feedback; so a load change on the output circuit will automatically effect the input circuit as well.</p>
Passive sensor	<p>Contains passive components whose parameters can be changed by the measured variables. A primary electronic mechanism converts these parameters into electric signals. An auxiliary external power source is needed for the passive sensor. Passive sensors can be used to determine both static and semi-static measured variables. For this reason, the majority of sensors have a passive construction. Examples of this type include load cells and resistance thermometers.</p>

R

Rated voltage	<p>Specified by the insulation coordination – the rated voltage is the voltage level at which the product can be safely operated, in relation to the corresponding pollution severity level and the surge voltage category.</p>
----------------------	---

S

SIL	<p>Safety Integrity Level.</p> <p>The components must meet the requirements of IEC 61508 in order to reduce risk. This standard provides general requirements for avoiding and minimising device and equipment outages. It stipulates organization and technical requirements concerning device development and operation. Four safety levels are defined (from SIL1 for minimal risk to SIL4 for very high risk) for classifying facilities and risk-reduction measures. Risk-reduction measures must be more reliable when the classified risk level is higher.</p>
Step response time	<p>This is the time delay in the output signal change when there is a signal jump ranging from 10 to 90 % on the input side. The step response time is inversely proportional to the limiting frequency</p>

W

T

Temperature classes	<p>Explosion-protected equipment that is to be installed into the Ex zone is subdivided into six temperature classes (T1 to T6).</p> <p>These temperature classes define the maximum surface temperature permitted for the equipment. The definition is based on an ambient temperature of +40 °C. This temperature may not be exceeded on any part of the equipment at any point in time. In all cases, the maximum surface temperature must be lower than the ignition temperature of the surrounding medium. The requirements placed on the equipment become stricter from class T1 to T6.</p>
----------------------------	---

W

Load cell	<p>A load cell is a special type of force sensor used in weighing systems (i.e., with scales). They are calibrated in grams (g), kilograms (kg) or tons (t).</p> <p>Load cells usually have a spring mechanism used as a force sensor. The spring is a specially shaped piece of metal whose shape changes slightly when under the influence of weight. This elastic deformation is recorded by strain gauges and converted into an electrical signal. Weights can be recorded ranging from a few hundred grams to several thousand tons.</p>
------------------	---

Z

Zone division

Hazardous areas are divided into zones. These divisions take into account the various risks from explosive atmospheres. The corresponding explosion protection can then be implemented economically and safely in accordance with the particular conditions of the zone. The zone definitions in the ATEX directive provide comprehensive regulations for the European Community.

IEC 60079-10 is valid for gases and vapours. A similar classification is used for facilities in the USA which are covered by the US standard NEC 505.

IEC 61241-3 covers the division into zones according to the dust level.

Explosion risk areas are classified into zones according to likelihood of explosive atmospheres occurring and their persistence:

Zone 0: this zone has an explosive atmosphere that is a mixture of air and flammable gases, vapours or mists. The mixture is present frequently or over long periods.

Zone 1: an explosive atmosphere may occasionally occur in this zone under normal operating conditions.

Zone 2: an explosive atmosphere is not likely to occur in this zone or may only occur briefly.

Zone 20: this zone has an explosive atmosphere that is a flammable mixture of air and dust. The mixture is present often or over long periods.

Zone 21: an explosive atmosphere, in the form of a flammable dust/air mixture, may occasionally occur in this zone under normal operating conditions.

Zone 22: an explosive atmosphere, in the form of a flammable dust/air mixture, is not likely to occur in this zone or may only occur briefly.

W

Index

Index	Index Type	X.2
	Index Order No.	X.4
	Addresses worldwide	X.8

Order No.	Type	Page
-----------	------	------

0230000000

0236510000	TS 35X15/L 1M 1M/ST/ZN	I.7
------------	------------------------	-----

0510000000

0514510000	TS 35X7.5/L 1M 1M/ST/ZN	I.7
------------	-------------------------	-----

1060000000

1067250000	ACT20P BRIDGE	C.6
1067250000	ACT20P BRIDGE	C.28
1067250000	ACT20P BRIDGE	VIII

1080000000

1082540000	ESG 6.6/20 BHZ 5.00/04	L.10
1086040000	BHZ 5.00/02/90LH BK/BK PRT 41	L.10
1086130000	BHZ 5.00/04/90LH BK/BK PRT 11	L.10
1086140000	BHZ 5.00/04/90LH BK/BK PRT 21	L.10
1086150000	BHZ 5.00/04/90LH BK/BK PRT 31	L.10
1086160000	BHZ 5.00/04/90LH BK/BK PRT 41	L.10
1086170000	BHZ 5.00/04/90LH BK/BK PRT 51	L.10
1086180000	BHZ 5.00/04/90LH BK/BK PRT 61	L.10
1086190000	BHZ 5.00/04/90LH BK/BK PRT 15	L.10
1086200000	BHZ 5.00/04/90LH BK/BK PRT 25	L.10
1086210000	BHZ 5.00/04/90LH BK/BK PRT 35	L.10
1086220000	BHZ 5.00/04/90LH BK/BK PRT 45	L.10
1086230000	BHZ 5.00/04/90LH BK/BK PRT 55	L.10
1086240000	BHZ 5.00/04/90LH BK/BK PRT 65	L.10
1086250000	BHZ 5.00/02/90LH BK/BL PRT 11	L.10
1086260000	BHZ 5.00/02/90LH BK/BL PRT 21	L.10
1086370000	BHZ 5.00/04/90LH BK/BL PRT 11	L.10
1086380000	BHZ 5.00/04/90LH BK/BL PRT 21	L.10
1086390000	BHZ 5.00/04/90LH BK/BL PRT 31	L.10
1086400000	BHZ 5.00/04/90LH BK/BL PRT 41	L.10
1086410000	BHZ 5.00/04/90LH BK/BL PRT 51	L.10
1086420000	BHZ 5.00/04/90LH BK/BL PRT 61	L.10
1086430000	BHZ 5.00/04/90LH BK/BL PRT 15	L.10
1086440000	BHZ 5.00/04/90LH BK/BL PRT 25	L.10
1086450000	BHZ 5.00/04/90LH BK/BL PRT 35	L.10
1086460000	BHZ 5.00/04/90LH BK/BL PRT 45	L.10
1086470000	BHZ 5.00/04/90LH BK/BL PRT 55	L.10
1086480000	BHZ 5.00/04/90LH BK/BL PRT 65	L.10

1160000000

1160640000	ACT20X-CJC-HTS PRT 11	L.10
1160650000	ACT20X-CJC-HTS PRT 21	L.10

1170000000

1175980000	ACT20M-CH-CD-S	D.4
1175980000	ACT20M-CH-CD-S	D.10
1175980000	ACT20M-CH-CD-S	X
1175990000	ACT20M-CH-2CD-S	D.4
1175990000	ACT20M-CH-2CD-S	D.11
1175990000	ACT20M-CH-2CD-S	X
1176000000	ACT20M-AI-AO-S	D.4
1176000000	ACT20M-AI-AO-S	D.8
1176000000	ACT20M-AI-AO-S	VIII
1176010000	ACT20M-AI-AO-E-S	D.4
1176010000	ACT20M-AI-AO-E-S	D.12
1176010000	ACT20M-AI-AO-E-S	X
1176020000	ACT20M-AI-2AO-S	D.4
1176020000	ACT20M-AI-2AO-S	D.9
1176020000	ACT20M-AI-2AO-S	VIII
1176030000	ACT20M-AI-AO-S	D.6
1176030000	ACT20M-AI-AO-S	D.26
1176030000	ACT20M-AI-AO-S	XII
1176040000	ACT20M-CH-CD-OLP-S	D.6
1176040000	ACT20M-CH-CD-OLP-S	D.17
1176040000	ACT20M-CH-CD-OLP-S	X
1176050000	ACT20M-2CI-2CD-OLP-S	D.6
1176050000	ACT20M-2CI-2CD-OLP-S	D.17
1176050000	ACT20M-2CI-2CD-OLP-S	X
1176070000	ACT20M-CH-CD-ILP-S	D.6
1176070000	ACT20M-CH-CD-ILP-S	D.15
1176070000	ACT20M-CH-CD-ILP-S	X
1176080000	ACT20M-2CI-2CD-ILP-S	D.6
1176080000	ACT20M-2CI-2CD-ILP-S	D.15
1176080000	ACT20M-2CI-2CD-ILP-S	X

1190000000

1193160000	CH20M BUS-AP LI TS 35X7.5 & 15	I.7
1193170000	CH20M BUS-AP RE TS 35X7.5 & 15	I.7

1230000000

1238910000	ACT20P-UI-2RCO-ACS	C.6
1238910000	ACT20P-UI-2RCO-ACS	C.22
1238910000	ACT20P-UI-2RCO-ACS	VIII

1240000000

1248150000	CH20M BUS-PROFIL TS 35X7.5/250	I.7
1248160000	CH20M BUS-PROFIL TS 35X7.5/500	I.7
1248170000	CH20M BUS-PROFIL TS 35X7.5/750	I.7

Order No.	Type	Page
-----------	------	------

1248180000	CH20M BUS-PROFIL TS 35X15/250	I.7
1248190000	CH20M BUS-PROFIL TS 35X15/500	I.7
1248210000	CH20M BUS-PROFIL TS 35X15/750	I.7
1248220000	CH20M BUS A.50/05 AU/250	I.7
1248230000	CH20M BUS A.50/05 AU/500	I.7
1248240000	CH20M BUS A.50/05 AU/750	I.7
1248250000	CH20M BUS-ADP TS 35/250	I.7
1248260000	CH20M BUS-ADP TS 35/500	I.7
1248270000	CH20M BUS-ADP TS 35/750	I.7

1280000000

1282490000	ACT20-FEED-IN-BASIC-S	I.3
1282490000	ACT20-FEED-IN-BASIC-S	I.9
1282490000	ACT20-FEED-IN-BASIC-S	XII

1330000000

1335140000	SET CH20M BUS 250MM TS 35X7.5	I.7
1335150000	SET CH20M BUS 250MM TS 35X15	I.7

1370000000

1375450000	ACT20M-BAI-AO-S	D.4
1375450000	ACT20M-BAI-AO-S	D.13
1375450000	ACT20M-BAI-AO-S	X
1375470000	ACT20M-BAI-2AO-S	D.4
1375470000	ACT20M-BAI-2AO-S	D.14
1375470000	ACT20M-BAI-2AO-S	X
1375480000	ACT20M-TCI-AO-S	D.6
1375480000	ACT20M-TCI-AO-S	D.24
1375480000	ACT20M-TCI-AO-S	D.2
1375500000	ACT20M-TCI-AO-E-S	X
1375500000	ACT20M-TCI-AO-E-S	X.25
1375500000	ACT20M-TCI-AO-E-S	D.6
1375510000	ACT20M-RTI-AO-S	D.6
1375510000	ACT20M-RTI-AO-S	D.22
1375510000	ACT20M-RTI-AO-S	X
1375520000	ACT20M-RTI-AO-E-S	D.6
1375520000	ACT20M-RTI-AO-E-S	D.23
1375520000	ACT20M-RTI-AO-E-S	X

1430000000

1435590000	ACT20M-RTCI-CD-OLP-S	D.6
1435590000	ACT20M-RTCI-CD-OLP-S	D.18
1435590000	ACT20M-RTCI-CD-OLP-S	X
1435610000	ACT20M-RTI-CD-EOLP-S	D.6
1435610000	ACT20M-RTI-CD-EOLP-S	D.19
1435610000	ACT20M-RTI-CD-EOLP-S	X

1450000000

1453210000	ACT20P-UI-AO-DO-LP	C.6
1453210000	ACT20P-UI-AO-DO-LP	C.30
1453210000	ACT20P-UI-AO-DO-LP	VIII

1460000000

1466380000	SW Weidmüller DTM-Library Setup	H.4
------------	---------------------------------	-----

1470000000

1474200000	ACT20P-AI-AO-DC-S	C.5
1474200000	ACT20P-AI-AO-DC-S	C.13
1474200000	ACT20P-AI-AO-DC-S	VI

1480000000

1481960000	ACT20P-PRO DCDC II-P	C.6
1481960000	ACT20P-PRO DCDC II-P	C.29
1481960000	ACT20P-PRO DCDC II-P	VIII
1481970000	ACT20P-PRO DCDC II-S	C.6
1481970000	ACT20P-PRO DCDC II-S	C.29
1481970000	ACT20P-PRO DCDC II-S	VIII

1500000000

1506220000	ACT20P-CI-CD-P-S	C.5
1506220000	ACT20P-CI-CD-P-S	C.9
1506220000	ACT20P-CI-CD-P-S	VI
1506210000	ACT20P-2CI-2CD-12P-S	C.5
1506210000	ACT20P-2CI-2CD-12P-S	C.7
1506220000	ACT20P-CI-2CD-P-S	C.5
1506220000	ACT20P-CI-2CD-P-S	C.11
1506220000	ACT20P-CI-2CD-P-S	VI

1510000000

1510240000	ACT20C-CMT-10-AO-RCS	A.4
1510240000	ACT20C-CMT-10-AO-RCS	A.7
1510240000	ACT20C-CMT-10-AO-RCS	A.7
1510280000	ACT20P-CMT-60-RC-P	C.6
1510280000	ACT20P-CMT-60-RC-P	C.26
1510280000	ACT20P-CMT-60-RC-P	VI
1510290000	ACT20P-CMT-60-AO-RC-P	C.6
1510290000	ACT20P-CMT-60-AO-RC-P	C.26
1510290000	ACT20P-CMT-60-AO-RC-P	VIII
1510320000	ACT20P-CMT-30-AO-RC-P	C.6

Order No.	Type	Page
-----------	------	------

1510320000	ACT20P-CMT-30-AO-RC-P	C.26
1510320000	ACT20P-CMT-30-AO-RC-P	VIII
1510330000	ACT20P-CMT-10-AO-RC-P	C.6
1510330000	ACT20P-CMT-10-AO-RC-P	C.26
1510330000	ACT20P-CMT-10-AO-RC-P	VIII
1510340000	ACT20C-LBT-10	A.4
1510340000	ACT20C-LBT-10	A.9
1510340000	ACT20C-LBT-10	IV
1510370000	ACT20C-GTW-100-MTCP-S	A.4
1510370000	ACT20C-GTW-100-MTCP-S	A.6
1510370000	ACT20C-GTW-100-MTCP-S	A.9
1510390000	ACT20P-CMT-60-RC-S	C.6
1510390000	ACT20P-CMT-60-RC-S	C.26
1510390000	ACT20P-CMT-60-RC-S	VIII
1510420000	ACT20C-CMT-60-AO-RC-S	A.4
1510420000	ACT20C-CMT-60-AO-RC-S	A.7
1510420000	ACT20C-CMT-60-AO-RC-S	A.7
1510440000	ACT20P-CMT-60-AO-RC-S	C.6
1510440000	ACT20P-CMT-60-AO-RC-S	C.26
1510440000	ACT20P-CMT-60-AO-RC-S	VIII
1510470000	ACT20P-CMT-10-AO-RC-S	C.6
1510470000	ACT20P-CMT-10-AO-RC-S	C.26
1510470000	ACT20P-CMT-10-AO-RC-S	VIII
1510540000	ACT20P-CMT-30-AO-RC-S	C.6
1510540000	ACT20P-CMT-30-AO-RC-S	C.26
1510540000	ACT20P-CMT-30-AO-RC-S	VIII

1530000000

1537750000	ACT20P-CH-V0-P-S	C.5
1537750000	ACT20P-CH-V0-P-S	C.10
1537750000	ACT20P-CH-V0-P-S	VI

1540000000

1540010000	ACT20P-CH-V0-S	C.5
1540010000	ACT20P-CH-V0-S	C.10
1540010000	ACT20P-CH-V0-S	VI
1545720000	ACT20P-AI-AO-ACS	C.5
1545720000	ACT20P-AI-AO-ACS	C.13
1545720000	ACT20P-AI-AO-ACS	VI

1750000000

1758250000	ZDV 4N/2 GE	I.12
1758260000	ZDV 4N/10 GE	I.12

1760000000

1762620000	ZDV 4N/4 GE	I.12
1762630000	ZDV 4N/3 GE	I.12

1820000000

1828450000	WS 10/6 MC NE WS	I.12
------------	------------------	------

1870000000

1877680000	MF 5/7.5 MC NE WS	I.11
------------	-------------------	------

1910000000

1912130000	ESG 8/13.5/43.3 SAI AU	I.10
1912130000	ESG 8/13.5/43.3 SAI AU	I.11

2040000000

2044840000	ACT20C-CML-10-AO-RC-S	A.4
2044840000	ACT20C-CML-10-AO-RC-S	A.8
2044840000	ACT20C-CML-10-AO-RC-S	IV
2044850000	ACT20P-CML-10-A	

Order No.	Type	Page
2514620000	ACT20P-CI-CD-PP	C.9
2514620000	ACT20P-CI-CD-PP	VI
2514630000	ACT20P-CI-2CD-PP	C.5
2514630000	ACT20P-CI-2CD-PP	C.11
2514630000	ACT20P-CI-2CD-PP	VI
2514640000	ACT20P-CI-V0-P-P	C.5
2514640000	ACT20P-CI-V0-P-P	C.10
2514640000	ACT20P-CI-V0-P-P	C.15
2514650000	ACT20P-2CI-2CD-12-P-P	VI
2514650000	ACT20P-2CI-2CD-12-P-P	C.12
2514650000	ACT20P-2CI-2CD-12-P-P	VI
2517450000	PICOPAK-CI-CD-LP-S	F.4
2517450000	PICOPAK-CI-CD-LP-S	F.6
2517450000	PICOPAK-CI-CD-LP-S	XII

2610000000

2619390000	ACT20P-CI-2CD-OLP-P	C.5
2619390000	ACT20P-CI-2CD-OLP-P	C.17
2619390000	ACT20P-CI-2CD-OLP-P	VI

2810000000

2816690000	ACT20P-PRO DCDC II-24-S	C.6
2816690000	ACT20P-PRO DCDC II-24-S	C.29
2816690000	ACT20P-PRO DCDC II-24-S	VIII
2816700000	ACT20P-PRO DCDC II-24-P	C.6
2816700000	ACT20P-PRO DCDC II-24-P	C.29
2816700000	ACT20P-PRO DCDC II-24-P	VIII

2820000000

2825000000	ACT20M-CH-CD-OLP2-S	D.6
2825000000	ACT20M-CH-CD-OLP2-S	D.16
2825000000	ACT20M-CH-CD-OLP2-S	X
2825010000	ACT20M-2CI-2CD-OLP2-S	D.6
2825010000	ACT20M-2CI-2CD-OLP2-S	D.16
2825010000	ACT20M-2CI-2CD-OLP2-S	X
2825020000	ACT20M-FRQ-AG-S	D.6
2825020000	ACT20M-FRQ-AG-S	D.27
2825020000	ACT20M-FRQ-AG-S	XII
2825030000	ACT20M-AI-2AO-X-S	D.4
2825030000	ACT20M-AI-2AO-X-S	D.9
2825030000	ACT20M-AI-2AO-X-S	VIII
2825040000	ACT20M-AI-A0-E-X-S	D.4
2825040000	ACT20M-AI-A0-E-X-S	D.12
2825040000	ACT20M-AI-A0-E-X-S	X
2825050000	ACT20M-AI-A0-X-S	D.4
2825050000	ACT20M-AI-A0-X-S	D.8
2825050000	ACT20M-AI-A0-X-S	VIII
2825060000	ACT20M-BAI-2AO-X-S	D.4
2825060000	ACT20M-BAI-2AO-X-S	D.14
2825060000	ACT20M-BAI-2AO-X-S	X
2825080000	ACT20M-CI-2CD-X-S	D.6
2825080000	ACT20M-CI-2CD-X-S	D.11
2825080000	ACT20M-CI-2CD-X-S	X
2825090000	ACT20M-CH-CD-X-S	D.10
2825090000	ACT20M-CH-CD-X-S	X
2825100000	ACT20M-RTH-A0-X-S	D.6
2825100000	ACT20M-RTH-A0-X-S	D.22
2825100000	ACT20M-RTH-A0-X-S	X
2825110000	ACT20M-TCH-A0-X-S	D.6
2825110000	ACT20M-TCH-A0-X-S	D.24
2825110000	ACT20M-TCH-A0-X-S	X
2825120000	ACT20M-UI-A0-X-P	D.6
2825120000	ACT20M-UI-A0-X-S	D.26
2825120000	ACT20M-UI-A0-X-S	XII
2825130000	ACT20M-FRQ-AG-X-S	D.6
2825130000	ACT20M-FRQ-AG-X-S	D.27
2825130000	ACT20M-FRQ-AG-X-S	XII
2825140000	ACT20M-2CI-2CD-ILP-P	D.6
2825140000	ACT20M-2CI-2CD-ILP-P	D.15
2825140000	ACT20M-2CI-2CD-ILP-P	X
2825150000	ACT20M-2CI-2CD-OLP-P	D.6
2825150000	ACT20M-2CI-2CD-OLP-P	D.17
2825150000	ACT20M-2CI-2CD-OLP-P	X
2825160000	ACT20M-AI-2AO-X-P	D.4
2825160000	ACT20M-AI-2AO-X-P	D.9
2825160000	ACT20M-AI-2AO-X-P	VIII
2825170000	ACT20M-AI-A0-E-X-P	D.4
2825170000	ACT20M-AI-A0-E-X-P	D.12
2825170000	ACT20M-AI-A0-E-X-P	X
2825180000	ACT20M-AI-A0-X-P	D.4
2825180000	ACT20M-AI-A0-X-P	D.8
2825180000	ACT20M-AI-A0-X-P	VIII
2825210000	ACT20M-CI-2CD-X-P	D.4
2825210000	ACT20M-CI-2CD-X-P	D.11
2825210000	ACT20M-CI-2CD-X-P	X
2825220000	ACT20M-CH-CD-ILP-P	D.6
2825220000	ACT20M-CH-CD-ILP-P	D.15
2825220000	ACT20M-CH-CD-ILP-P	X
2825230000	ACT20M-CH-CD-OLP-P	D.6
2825230000	ACT20M-CH-CD-OLP-P	D.17
2825230000	ACT20M-CH-CD-OLP-P	X
2825240000	ACT20M-CH-CD-X-P	D.4
2825240000	ACT20M-CH-CD-X-P	D.10
2825240000	ACT20M-CH-CD-X-P	X
2825250000	ACT20M-RTCI-CD-OLP-P	D.6

Order No.	Type	Page
2825250000	ACT20M-RTCI-CD-OLP-P	D.18
2825250000	ACT20M-RTCI-CD-OLP-P	X
2825260000	ACT20M-RTI-A0-E-P	D.6
2825260000	ACT20M-RTI-A0-E-P	D.23
2825260000	ACT20M-RTI-A0-E-P	X
2825270000	ACT20M-RTI-A0-X-P	D.6
2825270000	ACT20M-RTI-A0-X-P	D.22
2825270000	ACT20M-RTI-A0-X-P	X
2825280000	ACT20M-RTI-CD-EOLP-P	D.6
2825280000	ACT20M-RTI-CD-EOLP-P	D.19
2825280000	ACT20M-RTI-CD-EOLP-P	X
2825290000	ACT20M-TCH-A0-E-P	D.6
2825290000	ACT20M-TCH-A0-E-P	D.25
2825290000	ACT20M-TCH-A0-E-P	X
2825300000	ACT20M-TCH-A0-X-P	D.6
2825300000	ACT20M-TCH-A0-X-P	D.24
2825300000	ACT20M-TCH-A0-X-P	X
2825310000	ACT20M-AI-A0-X-P	D.6
2825310000	ACT20M-UI-A0-X-P	D.26
2825310000	ACT20M-UI-A0-X-P	XII
2825320000	ACT20M-CI-CD-OLP2-P	D.6
2825320000	ACT20M-CI-CD-OLP2-P	D.16
2825320000	ACT20M-CI-CD-OLP2-P	X
2825330000	ACT20M-2CI-2CD-OLP2-P	D.6
2825330000	ACT20M-2CI-2CD-OLP2-P	D.26
2825330000	ACT20M-2CI-2CD-OLP2-P	X
2825340000	ACT20M-FRQ-AG-X-P	D.6
2825340000	ACT20M-FRQ-AG-X-P	D.27
2825340000	ACT20M-FRQ-AG-X-P	XII
2825350000	ACT20M-AI-2AO-P	D.4
2825350000	ACT20M-AI-2AO-P	D.9
2825350000	ACT20M-AI-2AO-P	VIII
2825360000	ACT20M-AI-A0-E-P	D.4
2825360000	ACT20M-AI-A0-E-P	D.12
2825360000	ACT20M-AI-A0-E-P	X
2825370000	ACT20M-AI-A0-P	D.4
2825370000	ACT20M-AI-A0-P	D.8
2825370000	ACT20M-AI-A0-P	VIII
2825400000	ACT20M-CI-2CD-P	D.4
2825400000	ACT20M-CI-2CD-P	D.11
2825400000	ACT20M-CI-2CD-P	X
2825410000	ACT20M-CI-CD-P	D.4
2825410000	ACT20M-CI-CD-P	D.10
2825410000	ACT20M-CH-CD-P	X
2825420000	ACT20M-RTI-A0-P	D.6
2825420000	ACT20M-RTI-A0-P	D.22
2825420000	ACT20M-RTI-A0-P	X
2825430000	ACT20M-TCH-A0-P	D.6
2825430000	ACT20M-TCH-A0-P	D.24
2825430000	ACT20M-TCH-A0-P	X
2825440000	ACT20M-UI-A0-P	D.6
2825440000	ACT20M-UI-A0-P	D.26
2825440000	ACT20M-UI-A0-P	XII
2825450000	ACT20M-FRQ-AG-P	D.6
2825450000	ACT20M-FRQ-AG-P	D.27
2825450000	ACT20M-FRQ-AG-P	X
2825460000	ACT20-FEED-IN-BASIC-P	I.3
2825460000	ACT20-FEED-IN-BASIC-P	I.9
2825460000	ACT20-FEED-IN-BASIC-P	XII

2830000000

2830460000	ACT20M-RTCI-CD-HOLP-S	D.6
2830460000	ACT20M-RTCI-CD-HOLP-S	D.21
2830460000	ACT20M-RTCI-CD-HOLP-S	X
2830470000	ACT20M-RTCI-CD-HOLP-P	D.6
2830470000	ACT20M-RTCI-CD-HOLP-P	D.21
2830470000	ACT20M-RTCI-CD-HOLP-P	X
2830480000	ACT20M-RTCI-CD-H-S	D.6
2830480000	ACT20M-RTCI-CD-H-S	D.20
2830480000	ACT20M-RTCI-CD-H-S	X
2830490000	ACT20M-RTCI-CD-H-P	D.6
2830490000	ACT20M-RTCI-CD-H-P	D.20
2830490000	ACT20M-RTCI-CD-H-P	X
2830500000	ACT20M-RTCI-CD-H-X-S	D.6
2830500000	ACT20M-RTCI-CD-H-X-S	D.20
2830500000	ACT20M-RTCI-CD-H-X-S	X
2830510000	ACT20M-RTCI-CD-H-X-P	D.6
2830510000	ACT20M-RTCI-CD-H-X-P	D.20
2830510000	ACT20M-RTCI-CD-H-X-P	X

2900000000

2907490000	ADAPTER CBX200 - MINI USB	I.3
2907490000	ADAPTER CBX200 - MINI USB	L.4
2907490000	ADAPTER CBX200 - MINI USB	XII

2920000000

2920000000	ACT20D-LCD-CHLP	G.3
2920000000	ACT20D-LCD-CHLP	G.4
2920000000	ACT20D-LCD-CHLP	G.5
2920050000	ACT20D-LED-UI-AC-DC	G.3
2920050000	ACT20D-LED-UI-AC-DC	G.7
2920050000	ACT20D-LED-UI-AC-DC	XII
2920060000	ACT20D-LED-UI-A0-4RC-AC-DC	G.3
2920060000	ACT20D-LED-UI-A0-4RC-AC-DC	G.6
2920060000	ACT20D-LED-UI-A0-4RC-AC-DC	XII
2920070000	ACT20D-LED-F-A0-2RC-AC-DC	G.3

Order No.	Type	Page
2920070000	ACT20D-LED-F-A0-2RC-AC-DC	G.5
2920070000	ACT20D-LED-F-A0-2RC-AC-DC	XII

2960000000

2964330000	PROTECTIVE COVER	G.3
2964330000	PROTECTIVE COVER	G.8
2964330000	PROTECTIVE COVER	XII

7760000000

7760054114	ACT20P-CI-CD-S	C.5
7760054114	ACT20P-CI-CD-S	C.9
7760054114	ACT20P-CI-CD-S	VI
7760054115	ACT20P-CI-2CD-S	C.5
7760054115	ACT20P-CI-2CD-S	C.11
7760054115	ACT20P-CI-2CD-S	VI
7760054117	ACT20P-2CI-2CD-12-S	C.5
7760054117	ACT20P-2CI-2CD-12-S	C.12
7760054117	ACT20P-2CI-2CD-12-S	VI
7760054118	ACT20P-CI-1-CD-OLP-S	C.5
7760054118	ACT20P-CI-1-CD-OLP-S	C.15
7760054118	ACT20P-CI-1-CD-OLP-S	VI
7760054119	ACT20P-CI-2-CD-OLP-S	C.5
7760054119	ACT20P-CI-2-CD-OLP-S	C.15
7760054119	ACT20P-CI-2-CD-OLP-S	VI
7760054120	ACT20P-VI1-CD-OLP-S	C.5
7760054120	ACT20P-VI1-CD-OLP-S	C.16
7760054120	ACT20P-VI1-CD-OLP-S	VI
7760054121	ACT20P-VI-CD-OLP-S	C.5
7760054121	ACT20P-VI-CD-OLP-S	C.16
7760054121	ACT20P-VI-CD-OLP-S	VI
7760054122	ACT20P-CI-2CD-OLP-S	C.5
7760054122	ACT20P-CI-2CD-OLP-S	C.17
7760054122	ACT20P-CI-2CD-OLP-S	VI
7760054123	ACT20P-CI-CD-ILP-S	C.5
7760054123	ACT20P-CI-CD-ILP-S	C.14
7760054123	ACT20P-CI-CD-ILP-S	VI
7760054124	ACT20P-2CI-2CD-ILP-S	C.5
7760054124	ACT20P-2CI-2CD-ILP-S	C.14
7760054124	ACT20P-2CI-2CD-ILP-S	VI
7760054164	ACT20P-VMR-1PH-H-S	C.6
7760054164	ACT20P-VMR-1PH-H-S	C.23
7760054164	ACT20P-VMR-1PH-H-S	VIII
7760054165	ACT20P-VMR-3PH-ILP-H-S	C.6
7760054165	ACT20P-VMR-3PH-ILP-H-S	C.24
7760054165	ACT20P-VMR-3PH-ILP-H-S	VIII
7760054183	ACT20P-RTI-A0-P	C.5
7760054183	ACT20P-RTI-A0-P	C.19
7760054183	ACT20P-RTI-A0-P	VI
7760054184	ACT20P-TCI-A0-P	C.5
7760054184	ACT20P-TCI-A0-P	C.18
7760054184	ACT20P-TCI-A0-P	VI
7760054187	ACT20P-RTI-2AO-P	C.5
7760054187	ACT20P-RTI-2AO-P	C.19
7760054187	ACT20P-RTI-2AO-P	VI
7760054188	ACT20P-TCI-2AO-P	C.5
7760054188	ACT20P-TCI-2AO-P	C.18
7760054188	ACT20P-TCI-2AO-P	VI
7760054233	ACT20P-RTI-A0-S	C.5
7760054233	ACT20P-RTI-A0-S	C.19
7760054233	ACT20P-RTI-A0-S	VI
7760054234	ACT20P-TCI-A0-S	C.5
7760054234	ACT20P-TCI-A0-S	C.18
7760054234	ACT20P-TCI-A0-S	VI
7760054236	ACT20P-RTI-2AO-S	C.5
7760054236	ACT20P-RTI-2AO-S	C.19
7760054236	ACT20P-RTI-2AO-S	VI
7760054237	ACT20P-TCI-2AO-S	C.5
7760054237	ACT20P-TCI-2AO-S	C.18
7760054237	ACT20P-TCI-2AO-S	VI
7760054305	ACT20P-TMR-RTI-S	C.6
7760054305	ACT20P-TMR-RTI-S	C.21
7760054305	ACT20P-TMR-RTI-S	VIII
7760054306	ACT20P-VM-AG-S	C.6
7760054306	ACT20P-VM-AG-S	C.27
7760054306	ACT20P-VM-AG-S	VIII
7760054352	ACT20P-TMR-RTI-P	C.6
7760054352	ACT20P-TMR-RTI-P	C.21
7760054352	ACT20P-TMR-RTI-P	VIII
7760054353	ACT20P-CI-1-CD-OLP-P	C.5
7760054353	ACT20P-CI-1-CD-OLP-P	C.15
7760054353	ACT20P-CI-1-CD-OLP-P	VI
7760054354	ACT20P-CI-2-CD-OLP-P	C.5
7760054354	ACT20P-CI-2-CD-OLP-P	C.15
7760054354	ACT20P-CI-2-CD-OLP-P	VI
7760054355	ACT20P-VI1-CD-OLP-P	C.5
7760054355	ACT20P-VI1-CD-OLP-P	C.16
7760054355	ACT20P-VI1-CD-OLP-P	VI
7760054356	ACT20P-VI-CD-OLP-P	C.5
7760054356		

Order No.	Type	Page
8965390000	ACT20X-2HDI-2SD0-S	B.4
8965390000	ACT20X-2HDI-2SD0-S	B.15
8965390000	ACT20X-2HDI-2SD0-S	IV
8965400000	ACT20X-SDI-HDD-L-S	B.4
8965400000	ACT20X-SDI-HDD-L-S	B.17
8965400000	ACT20X-SDI-HDD-L-S	IV
8965410000	ACT20X-SDI-HDD-H-S	B.4
8965410000	ACT20X-SDI-HDD-H-S	B.19
8965410000	ACT20X-SDI-HDD-H-S	IV
8965420000	ACT20X-2SDI-2HDD-S	B.4
8965420000	ACT20X-2SDI-2HDD-S	B.17
8965420000	ACT20X-2SDI-2HDD-S	IV
8965430000	ACT20X-HAI-SAO-S	B.4
8965430000	ACT20X-HAI-SAO-S	B.7
8965430000	ACT20X-HAI-SAO-S	IV
8965440000	ACT20X-2HAI-2SAO-S	B.4
8965440000	ACT20X-2HAI-2SAO-S	B.7
8965440000	ACT20X-2HAI-2SAO-S	IV
8965450000	ACT20X-SAHAA-S	B.4
8965450000	ACT20X-SAHAA-S	B.9
8965450000	ACT20X-SAHAA-S	IV
8965460000	ACT20X-2SAI-2HAA-S	B.4
8965460000	ACT20X-2SAI-2HAA-S	B.9
8965460000	ACT20X-2SAI-2HAA-S	IV
8965470000	ACT20X-HTI-SAO-S	B.4
8965470000	ACT20X-HTI-SAO-S	B.11
8965470000	ACT20X-HTI-SAO-S	IV
8965480000	ACT20X-2HTI-2SAO-S	B.4
8965480000	ACT20X-2HTI-2SAO-S	B.11
8965480000	ACT20X-2HTI-2SAO-S	IV
8965490000	ACT20X-HUI-SAO-S	B.4
8965490000	ACT20X-HUI-SAO-S	B.21
8965490000	ACT20X-HUI-SAO-S	IV
8965500000	ACT20-FEED-IN-PRO-S	I.3
8965500000	ACT20-FEED-IN-PRO-S	I.9
8965500000	ACT20-FEED-IN-PRO-S	XII

8970000000

8978580000	CBX200 USB	I.3
8978580000	CBX200 USB	I.4
8978580000	CBX200 USB	XII

Addresses worldwide

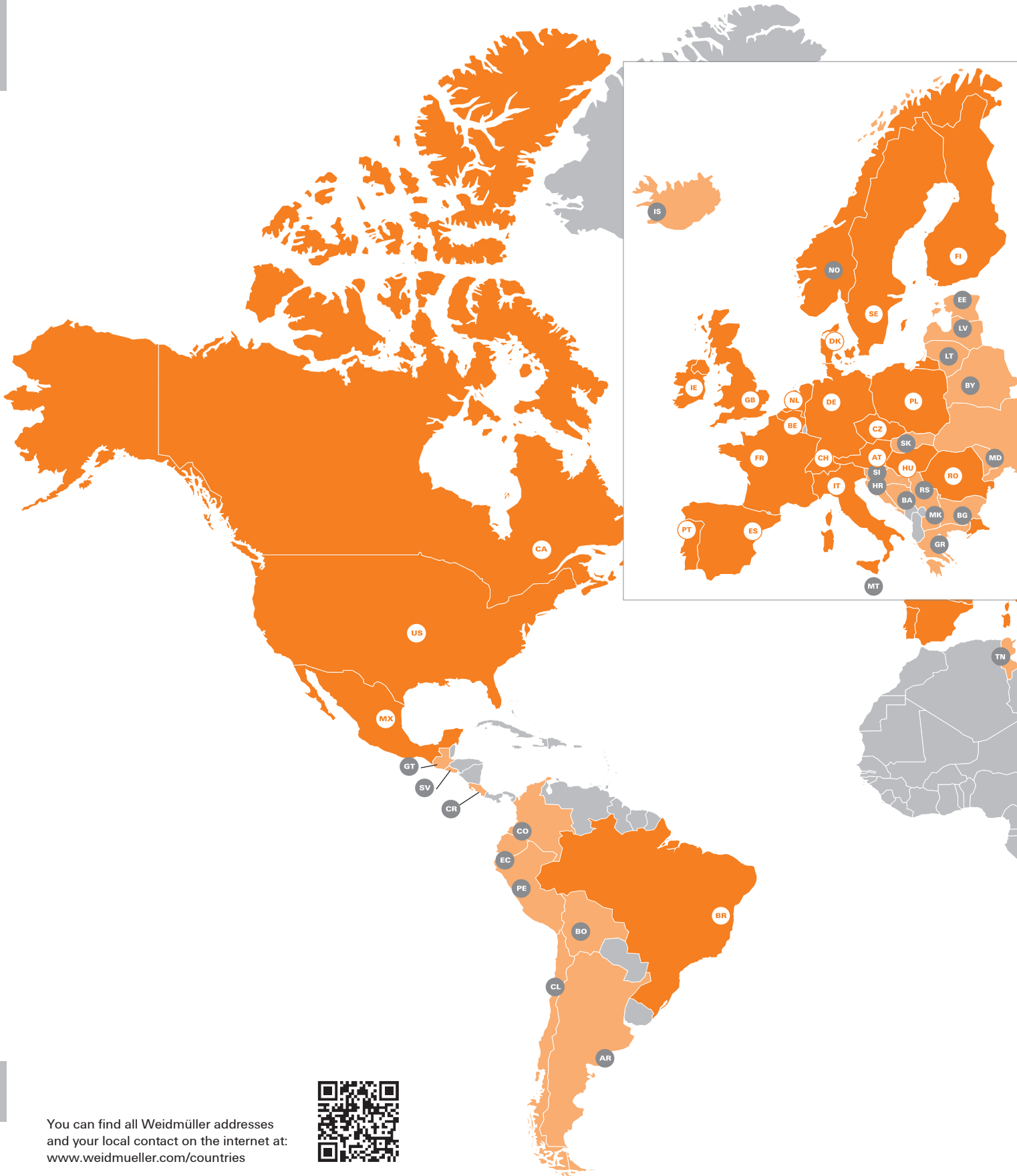

X

You can find all Weidmüller addresses and your local contact on the internet at: www.weidmueller.com/countries



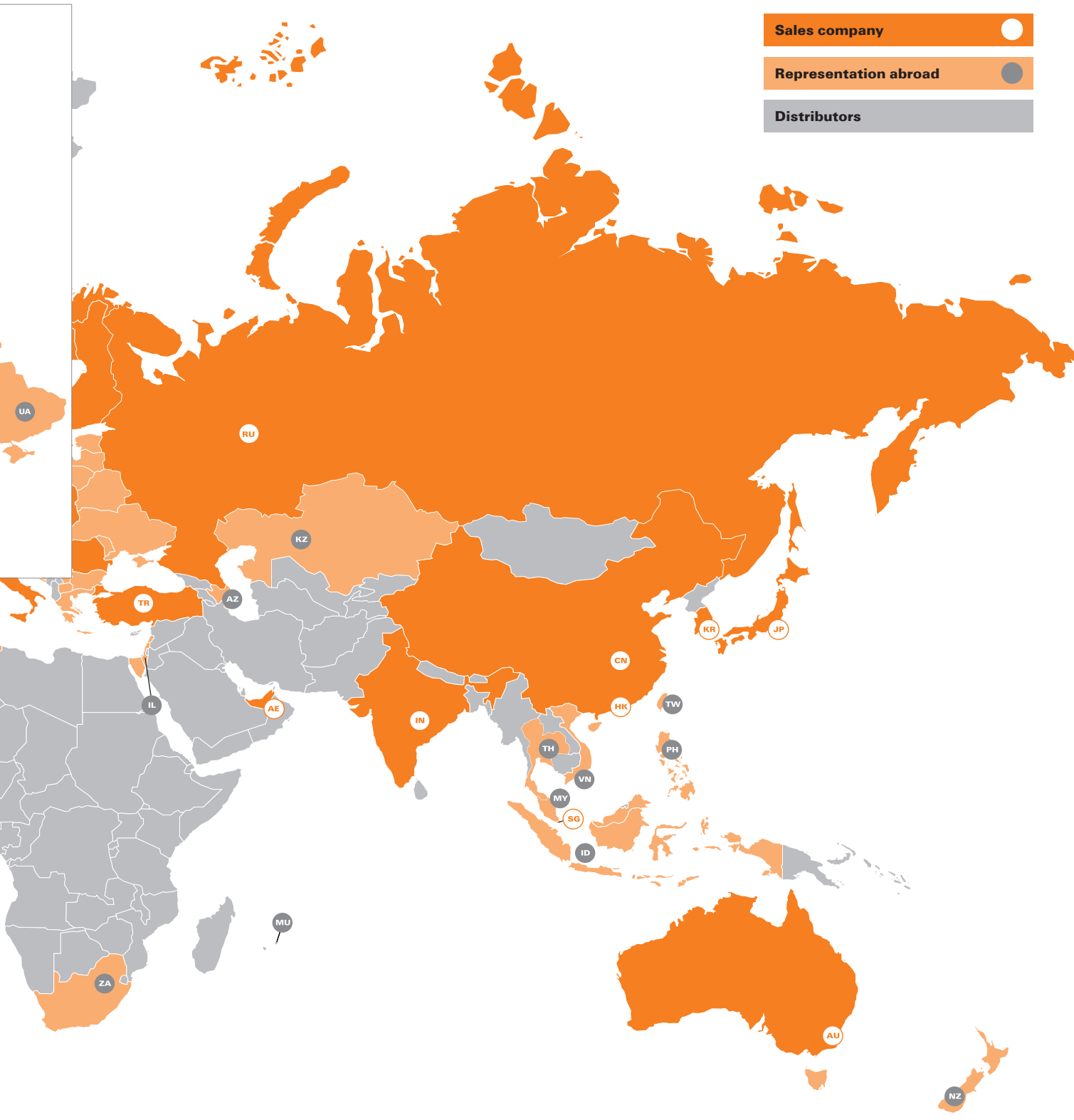

We cannot guarantee that there are no mistakes in the publications or software provided by us to the customer for the purpose of making orders. We try our best to quickly correct errors in our printed media.

X

All orders are based on our general terms of delivery, which can be reviewed on the websites of our group companies where you place your order. On demand we can also send the general terms of delivery to you.

Weidmüller – Your partner in Smart Industrial Connectivity

As experienced experts we support our customers and partners around the world with products, solutions and services in the industrial environment of power, signal and data. We are at home in their industries and markets and know the technological challenges of tomorrow. We are therefore continuously developing innovative, sustainable and useful solutions for their individual needs. Together we set standards in Industrial Connectivity.

Weidmüller Interface GmbH & Co. KG
Klingenbergstraße 26
32758 Detmold, Germany
T +49 5231 14-0
F +49 5231 14-292083
www.weidmueller.com

Personal support can
be found on our website:
www.weidmueller.com/contact

Made in Germany



Order number: 3024800000/06/2024/SMD