

AUTOMATION INTERFACES

SHORT FORM CATALOG

100% Made & Designed in Italy

**DATA ACQUISITION AND
AUTOMATION SYSTEMS**



**INDUSTRIAL COMMUNICATION
AND REMOTE CONTROL**



**POWER MONITORING AND
ELECTRICAL MEASUREMENT**



**MEASUREMENT AND CONTROL
PANEL INSTRUMENTATION**

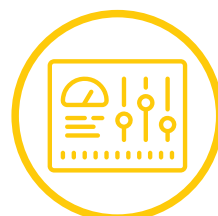

 **SENECA**
www.seneca.it

MISSION: WE HANDLE THE SIGNAL FROM THE SENSOR TO INDUSTRY 4.0

One of the leading companies in Europe to design and produce galvanic isolators and signal conditioners, SENECA offers a comprehensive catalogue of high-performance and cost-effective products and systems with which it is possible to feed, isolate, convert, capture, display and transmit safely by cable, bus or radio, most industrial signals, in other words, to ensure the integrity of the data processing cycle. In the 4.0 age, an increasing number of manufacturing companies, builders of machines, utilities, chemical and process industries must be able to rely on decentralised devices and control systems to monitor the progress of machines and systems. In this scenario the intent of SENECA is to ensure the real-time knowledge of the data available in order to offer the customer new information and concrete economic opportunities. This is the essence of the innovation process called Industry 4.0, in which the functions of data collection and interconnection are fundamental.

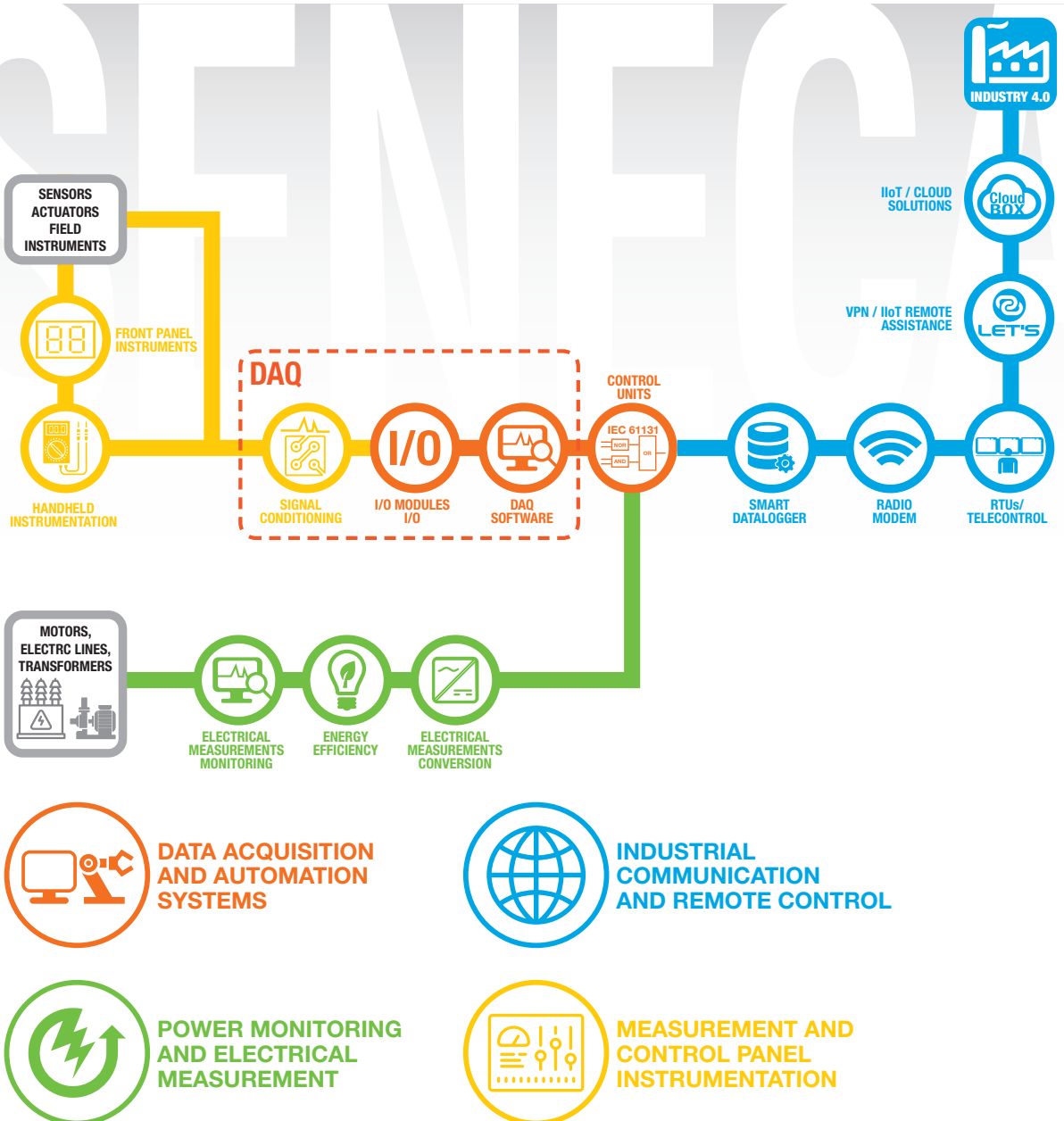

FACTS & FIGURES



Main Italian manufacturer of automation interfaces

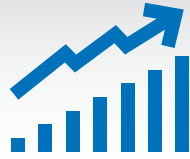

CAGR last 5 years 14%



ISO 9001 quality certification since 1997

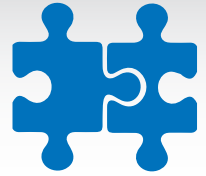

2 synergic business units



International product and process certifications



Global sales network with about 70 partners

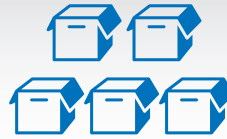

150,000 pieces sold on average each year



Latest generation Pick&Place 50.000 comp./hour



4 product lines >600 article codes



Average time for order processing 48h



Over 2,500 active customers



Multichannel technical support within 48h

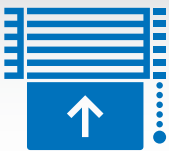

Automated warehouses with over 90,000 pieces in stock



Average MTBF over 1 million hours



High-tech headquarters of over 5,000 sqm



Customized warranty up to 60 months

INDEX

1	DATA ACQUISITION AND AUTOMATION SYSTEMS	5
	1.1 Remote IO modules Z-PC Line (Modbus RTU/ TCP-IP)	6
	1.2 Remote IO modules Z-PC Line (CANopen)	7
	1.3 Remote IO modules R-Line (Modbus RTU / TCP-IP)	8
	1.4 Remote IO modules R-Line (Profinet IO)	9
	1.5 IEC 61131-3 multifunction controllers	10
	1.6 Process Control Units	11
	1.7 HMI Oled	12
	1.8 Operator Panels	13
	1.9 HMI IIoT	14
	1.10 DAQ Software	15
	1.11 Software and accessories	16
2	INDUSTRIAL COMMUNICATION AND REMOTE CONTROL	17
	2.1 Remote Alarm Units	18
	2.2 Smart Dataloggers	19
	2.3 RTUs / Telecontrol	20
	2.4 Industrial Gateways	21
	2.5 IIoT Gateways	22
	2.6 LET'S – IIoT Remote Assistance / Telecontrol	23
	2.7 Cloud BOX –IIoT / Scada solutions	24
	2.8 USB – Serial converters	25
	2.9 Fiber optics converters	26
	2.10 Radio modules	27
	2.11 Radio measurement systems	28
3	POWER MONITORING AND ELECTRICAL MEASUREMENT	29
	3.1 Power meters - S203	30
	3.2 Power meters - R203	31
	3.3 Power meters - T203PM	32
	3.4 Power meters - S604 / S711	33
	3.5 Rogowski coils RC150 / RC190	34
	3.6 Energy counters S500	35
	3.7 Current transducers T201	36
	3.8 Electrical measurement converters	37
	3.9 IEC 61850 / IEC 60870 Energy controllers	38
4	MEASUREMENT AND CONTROL PANEL INSTRUMENTATION	39
	4.1 Multistandard signal converters / isolators – Z Line 34	40
	4.2 Compact signal converters / isolators – K Line	41
	4.3 Temperature transmitters	42
	4.4 Overvoltage protections	43
	4.5 Digital Indicators – S Line	44
	4.6 Batch Controllers – S Line	45
	4.7 Multifunction calibrators	46

1

DATA ACQUISITION AND AUTOMATION SYSTEMS



Z-PC Line is a modular automation system for managing from a single signal to thousands of I/Os. ZPC series includes the maximum variety of I/O modules: digital inputs, fast counters, digital relay and mosfet outputs, analog channels (mA, V, Ohm, mV), strain gauge, resistance thermometers, thermocouples, electrical signals, galvanically isolated and with ModBUS, CANopen, Ethernet, M-BUS communication protocols. The I/O modules support RS485 serial communication with ModBUS RTU protocol, up to 64 nodes without repeater and speeds up to 115 kbps.

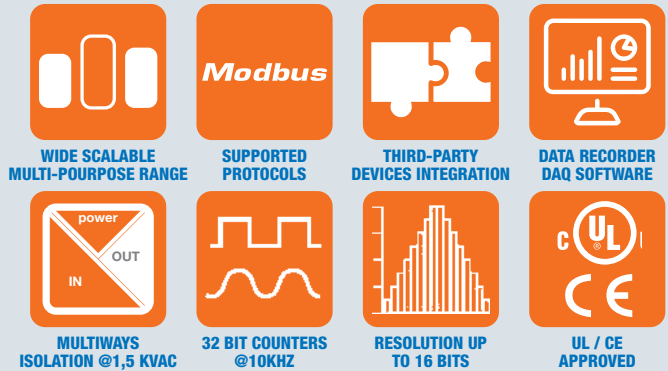

TOP SELLING PRODUCTS

Z-8AI



8-CH Analog Input module
RS485 ModBUS RTU

Z-SG



Strain gauge module
Analogue Output + ModBUS RTU

Z-10-D-IN



10-CH Digital Input module
RS485 ModBUS RTU

Z-4RTD2



4-CH RTD Input module
RS485 ModBUS RTU

APPLICATION EXAMPLES

PROCESS MEASUREMENT AND DATA RETRANSMISSION VIA MODBUS RTU

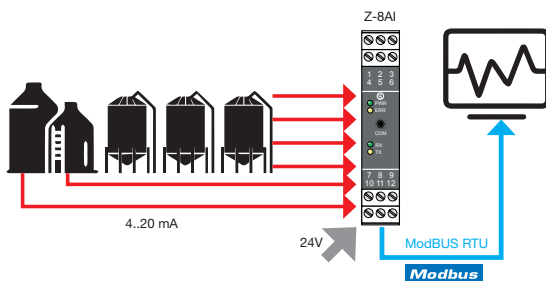

MODBUS ACQUISITION AND DISPLAY FOR WEIGHING SYSTEMS

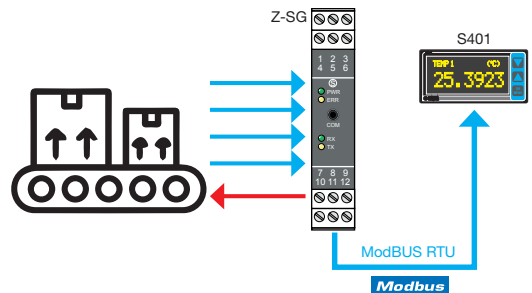







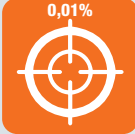

MAIN MAIN PRODUCT CODES





ORDER CODE	DESCRIPTION	ORDER CODE	DESCRIPTION
Z-10-D-IN	10-CH Digital Input module / RS485 ModBUS RTU	ZC-16DI-8DO	16 CH DI / 8 CH DO module / CANopen-RS485 ModBUS RTU
Z-10-D-OUT	10-CH Digital Output module / RS485 ModBUS RTU	ZC-24DI	24-CH digital input CANopen / ModBUS
Z-3AO	3-CH analog output module / RS485 ModBUS RTU	ZC-24DO	24-CH digital output CANopen / ModBUS
Z-4AI	4-CH analog input module / RS485 ModBUS RTU	ZE-2AI	2-CH AI Modbus RTU - Modbus RTU-Modbus TCP-IP module
Z-4RTD2	4-CH RTD input module / RS485 ModBUS RTU	ZE-4DI-2AI-2DO	CH DI / 2-CH AI, 2-CH DO Modbus RTU-Modbus TCP-IP module
Z-4TC	4-CH thermocouple input module / RS485 ModBUS RTU	Z-DAQ-PID	1 CH AI / RS485 ModBUS RTU with PID regulation
Z-5DI-2DO	5CH Digital Input - 2CH Digital Output RS485-ModBUS RTU	Z-D-IN	5 CH DI module / RS485 ModBUS RTU
Z-8AI	8-CH analog input module / RS485 ModBUS RTU	Z-D-OUT	5 CH DO Relay module / RS485 ModBUS RTU
Z-8NTC	8-CH NTC input module / RS485 ModBUS RTU	Z-SG2	Advanced strain gauge input module / RS485 ModBUS RTU
Z-8TC-1	8-CH TC input module / RS485 ModBUS RTU, Micro USB port		



CANopen Z-PC Line is a truly distributed I/O system based on IEC 61131 programming that does not require the use of couplers, controllers or repeaters for each communication line. All modules have an interface CAN communication with speeds up to 1 Mbps. CANopen Z-PC Line modules can be integrated with configurators and master controllers / network managers of third parties, even on existing machines and installations. The advantage of not needing an end-of-line coupler significantly reduces the cost factor for small to medium installations CANopen.

 HIGH ACCURACY	 ISOLATION 1,5 kVac (up to 6 ways)	 BAUD RATE UP TO 1 Mbps	 CODESYS PROGRAMMING
 UP TO 8 POWERED SENSORS PER MODULE	 DIRECT CONNECTION (NO COUPLERS)	 AC/DC POWER ON THE SAME HARDWARE	 CANOPEN/MODBUS ON DIGITAL MODULES

TOP SELLING PRODUCTS

ZC-24DI  24-CH digital inputs CANopen / ModBUS module	ZC-24DO  24-CH digital outputs CANopen / ModBUS module	ZC-16DI-8DO  16 CH DI / 8 CH DO CANopen / ModBUS module	ZC-8AI  8-CH analog input (mA, V) CANopen module
---	--	---	--

APPLICATION EXAMPLES

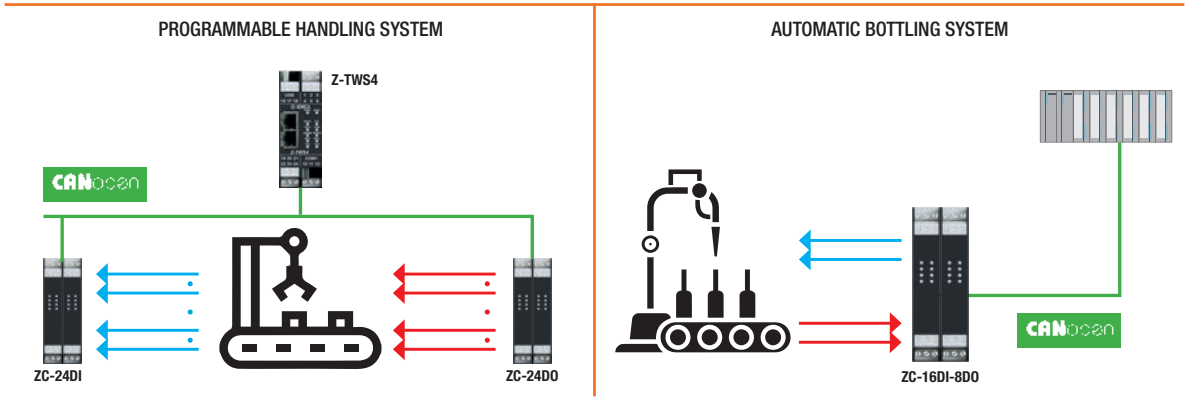

MAIN MAIN PRODUCT CODES

ORDER CODE	DESCRIPTION	ORDER CODE	DESCRIPTION
ZC-16DI-8DO	16 CH DI / 8 CH DO CANopen-ModBUS module	ZC-4RTD	4-CH RTD input CANopen module
ZC-24DI	24-CH digital input CANopen / ModBUS	ZC-8AI	8-CH analog input (mA, V) CANopen module
ZC-24DO	24-CH digital output CANopen / ModBUS	ZC-8TC	8-CH Thermocouple (J,K,E,N,S,R,B,T) CANopen module
ZC-3AO	3-CH analog output (mA, V) CANopen module	ZC-SG	1-CH strain gauge CANopen module



Additional order codes and information

R Line I/O modules are designed for flexible wiring needs, small installation spaces, high I/O density applications with integrated ModBUS / Ethernet communication. Configuration can be done through dedicated software, web server with HTML5 support and DIP switches. Capable of powering external sensors and with 1,500 Vac isolation, R Line modules can be daisy chained with fault-bypass to ensure connection even if one module in the chain fails.



FLEXIBLE AND SPACESAVING APPLICATIONS



I/O HIGH DENSITY



DOUBLE PROTOCOL



CONFIGURATION VIA WEB SERVER



EMBEDDED NETWORKING FUNCTIONS



DAISY CHAIN CONNECTIONS



MODBUS PASS-THROUGH



**RETENTIVE COUNTERS
6kHz @32bits**

TOP SELLING PRODUCTS

R-32DIDO



16-CH digital inputs / 8-CH digital relay outputs Modbus RTU / TCP-IP module

R-16DI-8DO



16-CH digital inputs / 8-CH digital relay outputs Modbus RTU / TCP-IP module

R-8AI-8DIDO



8-CH analog inputs / 8-CH digital inputs / outputs Modbus RTU / TCP-IP module

R-SG



Strain gauge Modbus TCP-IP / Modbus RTU converter module

APPLICATION EXAMPLES

ETHERNET DAISY CHAIN, MODBUS PASS-THROUGH

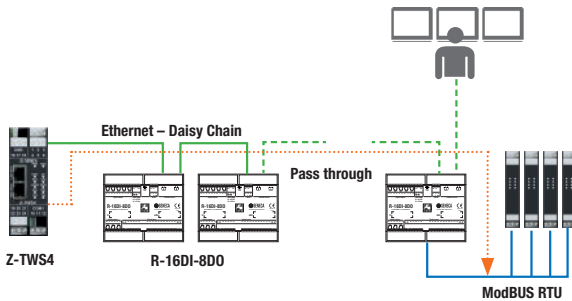

FAULT BY-PASS

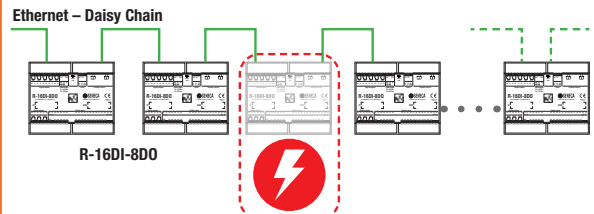

MAIN MAIN PRODUCT CODES

ORDER CODE	DESCRIPTION
R-8RTD-8DIDO	8-CH RTD inputs Modbus TCP-IP / Modbus RTU module
R-8AI-8DIDO	8-CH analog inputs / 8-CH digital inputs / outputs Modbus TCP-IP / Modbus RTU module
R-16DI-8DO	16-CH digital inputs / 8-CH digital relay outputs Modbus TCP-IP / Modbus RTU module
R-32DIDO	32-CH digital inputs / outputs Modbus TCP-IP / Modbus RTU
R-SG	Strain gauge Modbus TCP-IP / Modbus RTU converter module
R-KEY-LT	Compact industrial ModBUS gateway

Additional order codes and information



R Series I/O modules are designed for flexible wiring needs, small installation spaces, high I/O density applications with integrated Profinet IO communication. Configuration is provided via CODESYS softPLC software and Siemens TiA Portal/Step7 design environment. R Series modules can be daisy chained to ensure Ethernet connectivity even if one module in the chain fails. R Series modules support Profinet IO Class 1 (RT), a variant in which the various devices are not synchronized, each with its own cycle time.



FLEXIBLE AND SPACESAVING APPLICATIONS



I/O HIGH DENSITY



PROFINET IO REAL TIME CLASS



SETTINGS VIA STEP7/TIA PORTAL



EMBEDDED NETWORKING FUNCTIONS



DAISY CHAIN CONNECTIONS



PROGRAMMING VIA CODESYS



SHORT SCAN TIME

TOP SELLING PRODUCTS

R-32DIDO-P



32-CH digital inputs / outputs Profinet IO

R-16DI-8DO-P



16-CH digital inputs / 8-CH digital relay outputs Profinet IO module

R-8AI-8DIDO-P



8-CH analog inputs / 8-CH digital inputs / outputs Profinet IO module

R-SG-P



Strain gauge Profinet IO converter module

APPLICATION EXAMPLES

EXAMPLE OF STAR TOPOLOGY (WITH SWITCH)

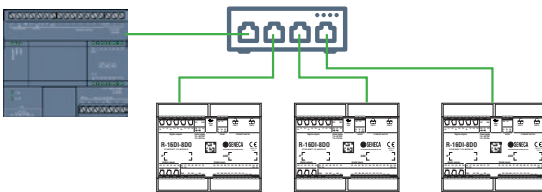

EXAMPLE OF DAISY CHAIN TOPOLOGY WITH FAULT-BY-PASS

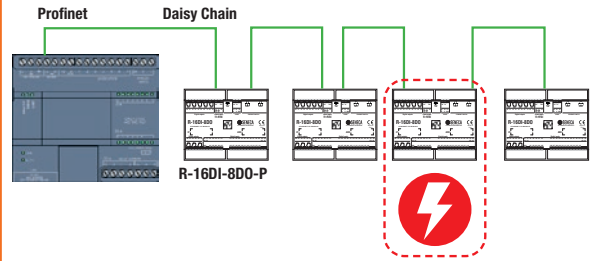

MAIN MAIN PRODUCT CODES

ORDER CODE	DESCRIPTION
R-8RTD-8DIDO-P	8-CH RTD inputs Profinet IO module
R-8AI-8DIDO-P	8-CHANalog inputs / 8-CH digital inputs / outputs Profinet IO module
R-16DI-8DO-P	16-CH digital inputs / 8 digital relay outputs Profinet IO module
R-32DIDO-P	32-CH digital inputs / outputs Profinet IO
R-SG-P	Strain gauge Profinet IO converter module
R-KEY-LT-P	Compact Industrial Gateway Profinet IO <-> ModBUS RTU / TCP-IP



Additional order codes and information

SENECA's multifunctional controllers (Z-TWS11, Z-TWS4, Z-PASS2-S, S6001-RTU) are modular / all-in-one devices with high connectivity modular / all-in-one devices. They combine PLC tasks based on the Straton IEC 61131-3, softLPLC platform with web server functionality, with web server, datalogger, remote control, remote maintenance and energy management functions (in accordance with IEC 60870-101/104, IEC 61850). The controllers can be used with different architectures and configurations depending on the complexity of the system and the hardware requirements.



**MULTIPURPOSE
CONTROLLERS**



**SOFT PLC
IEC 61131-3**

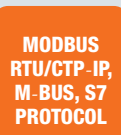

**MODBUS
RTU/CTP-IP,
M-BUS, S7
PROTOCOL**



**ENERGY
PROTOCOLS**



**UNIVERSAL
APPLICATION AREAS**



**DATALOGGER
FUNCTION**



IT PROTOCOLS



**OPC UA
STANDARD**

TOP SELLING PRODUCTS

Z-TWS11



IEC 61131 basic controller, built-in IO, Straton

Z-TWS4



IEC 61131 multifunction controller, built-in I/O, Straton

Z-PASS2-S



Remote Controller, VPN, serial device server, GPS and I/O integrated

S6001-RTU



Remote Control Unit with built-in IO and 3G+/4G modem

APPLICATION EXAMPLES

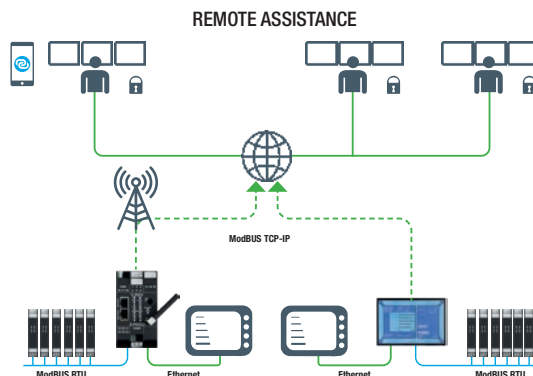
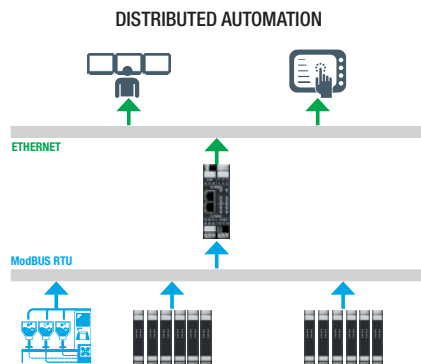

MAIN MAIN PRODUCT CODES

ORDER CODE	DESCRIPTION
Z-TWS11	IEC 61131 basic controller, built-in IO, Straton
Z-TWS4-S-IO	IEC 61131 multifunction controller, built-in I/O, Straton
Z-TWS4-E-IO	IEC 61131 Energy controller energy, built-in I/O, Straton OEM
S6001-RTU	Remote Control Unit with built-in IO and 3G+ modem
S6001-RTU-4GWW	Remote Control Unit with built-in IO and 4G WW LTE modem
S6001-RTU-E	Remote Control Unit with built-in IO, 3G+ modem, energy
S6001-RTU-E-4GWW	Remote Control Unit with built-in IO, 4G WW LTE, Energy protocols
Z-PASS2-S-4GWW	Remote Controller 4G worldwide, VPN, serial device server, GPS and I/O integrated
Z-PASS2-S-E-4GWW	Remote Controller Energy 4G worldwide, VPN, serial device server, GPS and I/O integrated



S6001-PC

S6001 Pump Controller is a controller for pumping units and pressurization systems managing from 2 to 6 pumps (with Z-D-IO expansion I/O modules), supporting three different operating modes: flow rate adjustment, level dependent control and pressure dependent control.



3G+/4G LTE



STRATON



VPN



PUMPING / PRESSURE BOOSTING SYSTEM

Z-FLOWCOMPUTER

Z-FLOWCOMPUTER is a flow computer for gas, steam and water application. The unit is equipped with nr. 4 PNP / NPN digital inputs, nr. 2 voltage / current analog inputs, nr. 1 universal analog input, nr. 2 relay digital outputs and nr. 1 analog voltage / current output.

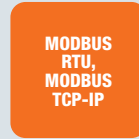

COMMUNICATION PROTOCOLS



HMI TFT TOUCHSCREEN



BUILT-IN I/O



WATER / STEAM / FLOW COMPENSATION

TOP SELLING PRODUCTS

S6001-PC



Advanced Pump Controller with 7" HMI , 3G+ modem

S6001-PC-4GWW



Advanced Pump Controller with 7" HMI, 4G/LTE modem

TOP SELLING PRODUCTS

Z-FLOWCOMPUTER



Universal water / steam flow computer with 4,3" HMI

Z-FLOWCOMPUTER-B



Universal water / steam flow computer

APPLICATION EXAMPLE

PUMP AND LEVEL CONTROL

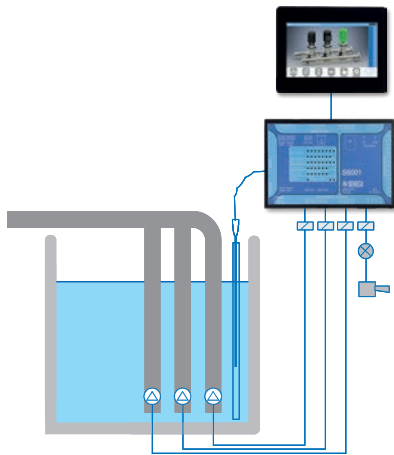

APPLICATION EXAMPLE

MASS AND STEAM CALCULATION

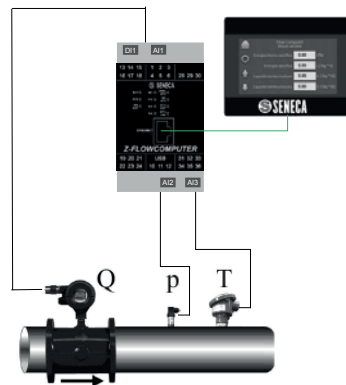

MAIN MAIN PRODUCT CODES

ORDER CODE	DESCRIPTION
S6001-PC	Advanced Pump Controller with 7" HMI
S6001-PC-4GWW	Advanced Pump Controller 4G WW LTE with 7" HMI

MAIN MAIN PRODUCT CODES

ORDER CODE	DESCRIPTION
Z-FLOWCOMPUTER	Universal energy & flow computer with 4,3" HMI
Z-FLOWCOMPUTER-B	Universal energy & flow computer



Additional order codes and information

S401-L is the first indicator with OLED display (Organic Light Emitting Diode) display on the industrial market.

This display technology is based on a series of layers of organic material that conduct current only in one direction, behaving similarly to a diode. Unlike traditional LCD and LED displays, OLED displays do not require additional additional components to be illuminated, but produce their own light. All this translates into higher brightness, greater definition and reduced footprint.



DISPLAY UP TO 30 VALUES



R/W/MATH MASTER FUNCTIONS



HIGH BRIGHTNESS 70cd/m²



COMPACT SIZE 96X48X40 mm



AUTOMATIC SCROLLING



SMART CABLING



FAST PROGRAMMING



ALARM MANAGEMENT

PRODUCT VIEWS

S401-L

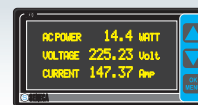
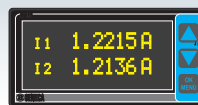

APPLICATION EXAMPLES

WIRELESS SIGNAL RETRANSMISION

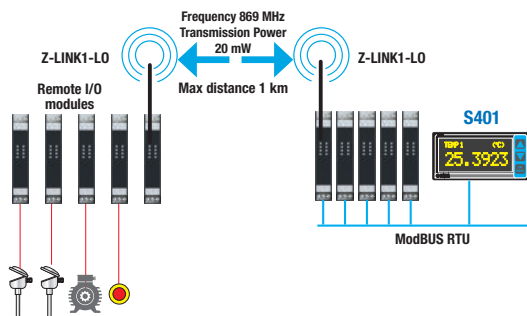

DATA ACQUISITION AND RETRANSMISSION TO PLC

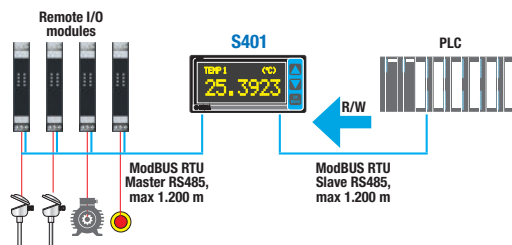

MEASUREMENT ACQUISITION AND ACTUATOR CONTROL

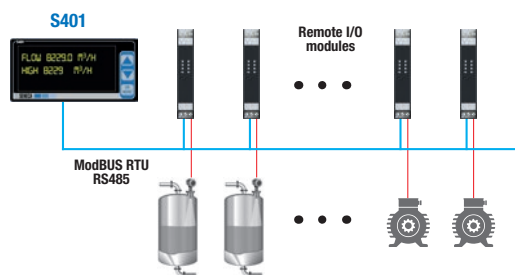

FLOW RATE MEASUREMENTS ACQUISITION AND VISUALIZATION

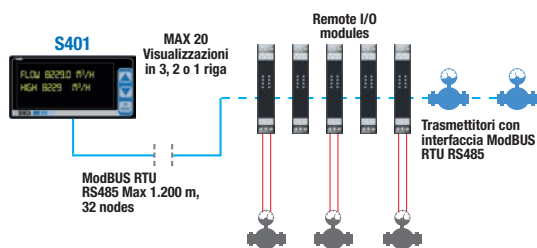







MAIN MAIN PRODUCT CODES

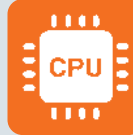
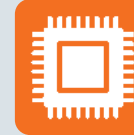



ORDER CODE	DESCRIPTION
S401-L	ModBUS RTU indicator with OLED 2,7" display



VISUAL touchscreen Operator Panels are suitable to satisfy a wide range of applications from small automation to control of complex industrial processes. With 4,3", 7", 9,7", 10,1", 15" and widescreen format display they allow the visualization of more information than a traditional display, while ensuring external compact dimension. HMI VISUAL screens can be freely horizontally or vertically oriented, depending on the needs of the application. TFT displays support up to 16 million colors with high resolution and LED backlighting.

 TFT 16M COLORS	 HIGH PERFORMANCE PROCESSOR	 FLASH MEMORY UP TO 512MB	 MODBUS
 CE/UL APPROVALS	 NEMA4/IP65 /IP66	 EASY PROGRAMMING TOOLKIT	 RESISTIVE TOUCHSCREEN

TOP SELLING PRODUCTS

<p>VISUAL2E</p>  <p>7" touch screen operator panel, Ethernet</p>	<p>VISUAL4</p>  <p>7" touch screen operator panel, 800x480, ARM 600 MHz</p>	<p>VISUAL10</p>  <p>9,7" HMI widescreen colors, Ethernet interface</p>	<p>VISUAL12</p>  <p>15" HMI widescreen colors, Ethernet interface, aluminum case</p>
--	---	--	--

APPLICATION EXAMPLES

DISTRIBUTED SERIAL NETWORK

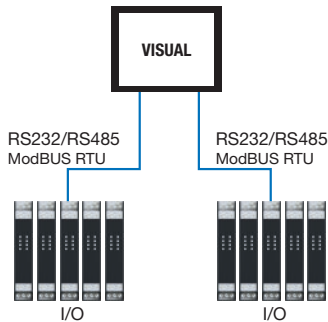

REMOTE CONTROL

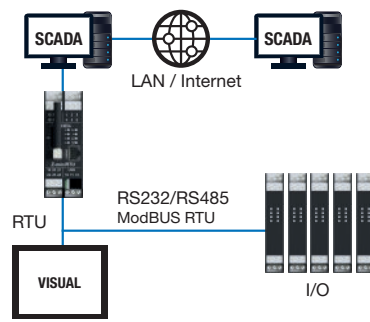

MAIN MAIN PRODUCT CODES

ORDER CODE	DESCRIPTION	ORDER CODE	DESCRIPTION
EB PRO	HMI configuration software VISUAL	VISUAL5-PC	7"HMI widescreen 64k colors, Ethernet, S6001-PC spare version
VISUAL1	4,3" touch screen operator panel, 480x272, RISC 400 MHz	VISUAL5-WB	7"HMI widescreen 64k colors, Ethernet, HMI / Web Server ver.
VISUAL1E	4,3" HMI widescreen colors, Ethernet interface	VISUAL6	7" HMI widescreen colors, double Ethernet interface
VISUAL2	7" touch screen operator panel, 800x480, RISC 400 MHz	VISUAL7N	10,1"HMI touchscreen 10,1" widescreen colors, Ethernet interface
VISUAL2E	7" touch screen operator panel, Ethernet	VISUAL8	10,1" HD HMI widescreen colors, Ethernet interface
VISUAL3	4,3" touch screen operator panel, 480x272, ARM 600 MHz	VISUAL9	10,1" HD HMI widescreen colors, Ethernet interface, WiFi
VISUAL3-FLOW	4,3" touch screen operator panel, 480x272, ARM 600 MHz, spare parts Flow Computer	VISUAL10	9,7" HMI widescreen colors, Ethernet interface
VISUAL4	7" touch screen operator panel, 800x480, ARM 600 MHz	VISUAL11	9,7" HMI widescreen colors, double Ethernet interface
VISUAL4T	7" HMI widescreen colors, Ethernet interface, aluminum case	VISUAL12	15" HMI widescreen colors, Ethernet interface, aluminum case



Additional order codes and information

SURPRISE Smart Display is a latest generation 7" touch operator terminal with powerful 800 MHz ARM microprocessor, dual Fast Ethernet port, 802.11 b/g/n Wi-Fi module, interfaces and sniffer function for serial lines. It is a multipurpose device with IloT gateway, datalogger, Wi-Fi router, microcontroller with integrated I/O, remote assistance unit and remote control on LET'S platform. Surprise Smart Display is not only a touchscreen HMI, but a multifunction device that integrates IloT gateway, Wi-Fi router, remote assistance module, datalogger, microcontroller, serial sniffer and I/O.



CLOUD SUPPORT



LAN / WAN DUAL ETHERNET



BUILT-IN LOGIC UNIT



EASY MOUNTING



WI-FI



OPC UA



MQTT



ADVANCED ROUTING

VISUALIZATION MODE

DISPLAY STANDARD WIDGET BASED 7"



REMOTE DISPLAY

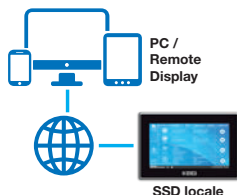

DISPLAY ON DISPLAY

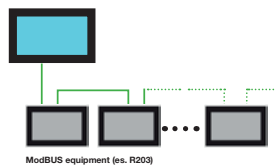

CONFIGURATION MODE

BASIC (FROM DISPLAY)



ADVANCED (FROM WEB SERVER)



APPLICATION EXAMPLES

MODBUS GATEWAY - ETHERNET TO SERIAL

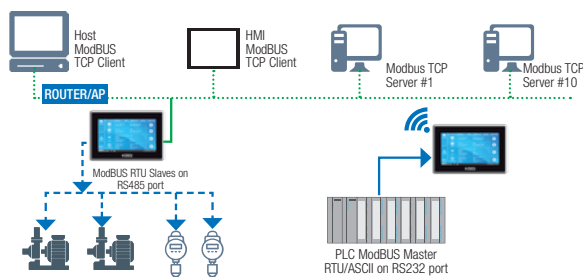

IoT/ CLOUD GATEWAY

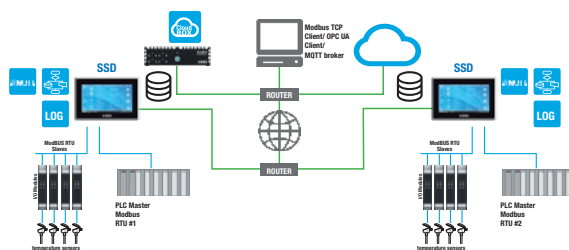

MAIN MAIN PRODUCT CODES

ORDER CODE	DESCRIPTION	ORDER CODE	DESCRIPTION
SSD-0-0-0-0	Advanced touchscreen HMI with integrated I/O	SSD-UPG-L	SSD - Upgrade "logic" functions
SSD-0-L-0-0	Advanced touchscreen HMI with integrated logic and I/O	SSD-UPG-V	SSD - Upgrade "VPN" functions
SSD-0-0-V-0	Advanced touchscreen HMI with integrated VPN and I/O	SSD-UPG-I	SSD - Upgrade "IloT/MQTT/Cloud" functions
SSD-0-0-0-1	Advanced touchscreen HMI with integrated IloT and I/O	SSD-UPG-L-V	SSD - Upgrade "logic" and "VPN" functions
SSD-0-L-V-0	Advanced touchscreen HMI with integrated logic, VPN and I/O	SSD-UPG-L-I	SSD - Upgrade "logic" and "IloT/MQTT/Cloud" functions
SSD-0-L-0-1	Advanced touchscreen HMI with integrated IloT, logic and I/O	SSD-UPG-V-I	SSD - Upgrade functions "VPN" and "IloT/MQTT/Cloud".
SSD-0-0-V-1	Advanced touchscreen HMI with integrated IloT, VPN and I/O	SSD-UPG-L-V-I	SSD - Upgrade functions "logic, "VPN" and "IloT/MQTT/Cloud
SSD-0-L-V-1	Advanced touchscreen HMI with integrated IloT, logic, VPN and I/O		



Data Recorder is an open, scalable and inexpensive Windows PC-based software recorder, ideal for professionals, maintenance engineers, students, researchers, designers and technical department managers working in the test, measurement and simulation sessions, in test benches, in electronics laboratories and for teaching, in test rooms, climatic chambers, engine rooms, industrial ovens, environmental measures, energy and plant monitoring. Physical data acquisition takes place through distributed SEENCA I/O modules and in general from any standard ModBUS RTU slave device.



REAL-TIME VISUALIZATION



HISTORICAL DATA VISUALIZATION



RECORDING SCHEDULING



MATH FUNCTIONS



ALARM FUNCTIONS



REPORTS



TEMPERATURE SENSORS CALIBRATION



MULTICLIENT OPTIONAL PACKAGE

ACQUISITION, RECORDING, DISPLAYING



Temperature sensors (RTD, TC, PTC, NTC...)



Process sensors (pressure, flow, level...)



Mechanical and kinematic measurements (speed, force, acceleration, weight...)



Pulse or digital sensors (limit switch, photocell)

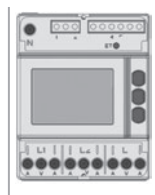

Power measurement analyzers, meters, recorders

APPLICATION EXAMPLES

MONITORING WATER QUALITY PARAMETERS

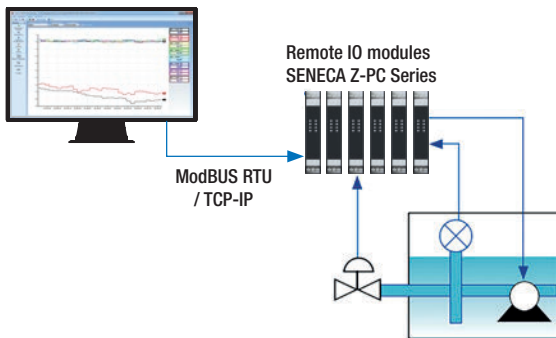

TESTS, TRIALS AND DATA ACQUISITION FOR ELECTRIC MOTORS

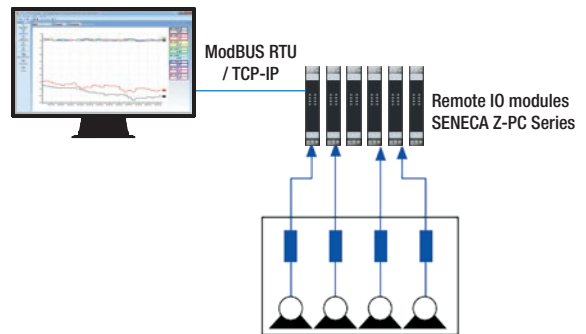

MAIN PRODUCT CODES

ORDER CODE	DESCRIPTION	ORDER CODE	DESCRIPTION
DR-02	2-CH DAQ Software	DR-04-PLUS	4-CH Data Recorder+ multi-client
DR-04	4-CH DAQ Software	DR-08-PLUS	8-CH Data Recorder+ multi-client
DR-08	8-CH DAQ Software	DR-16-PLUS	16-CH Data Recorder+multi-client
DR-16	16-CH DAQ Software	DR-32-PLUS	32-CH Data Recorder+multi-client
DR-32	32-CH DAQ Software	DR-64-PLUS	64-CH Data Recorder+multi-client
DR-64	64-CH DAQ Software	DR-UN-PLUS	Unlimited-CH Data Recorder+multi-client
DR-UN	Unlimited-CH DAQ Software	DR-UPGRADE	Data Recorder license upgrade service



Additional order codes and information

SENECA PACKAGE

SENECA Package suite includes the IEC 61131-3 configuration environment, Z-NET4, with which integrated applications are installed for the complete management of an automation project. Also available are data export interfaces to the programming environment Straton and OPC programming environment.

**Z-NET4**

System configurator: project, CPU, I/O, network communication, variables

**DATA RECORDER**

Data acquisition and registration software

**STRATON**

Interface of editing, reading and export configurations for IEC 61131-3 Straton environment

**WEB FACTOR**

Tool for creation and management of monitoring Web-HMI

**TREND VIEWER**

Software for visualization and historical analysis of data

**OPC**

Interface of variables editing and export in OPC environment

Z-PC-DIN - COMMUNICATION BUS REAR SUPPORT / POWER SUPPLY FOR Z-PC SERIES MODULES

	DESCRIPTION	SLOT	STEP	TERMINAL POWER SUPPLY/BUS	HOT SWAPPING	DIN GUIDE ASSEMBLY
	Z-PC-DINAL1-35 DIN guide rapid assembly support head +1 slot P=35mm	1	35 mm	Yes	Yes	Yes
	Z-PC-DINAL2-17.5 DIN guide rapid assembly support head +2 slot P=17,5mm	2	17,5 mm	Yes	Yes	Yes
	Z-PC-DINAL2-52.5 DIN guide rapid assembly support head +1 slot 52,5 mm + 1slot 17,5 mm	2	52,5 mm	Yes	Yes	Yes
	Z-PC-DIN1-35 DIN guide rapid assembly support 1 slot P=35mm	1	35 mm	-	Yes	Yes
	Z-PC-DIN2-17.5 DIN guide rapid assembly support 1 slot P=17,5mm	2	17,5 mm	-	Yes	Yes
	Z-PC-DIN4-35 DIN guide rapid assembly support 4 slot P=35mm	4	35 mm	-	Yes	Yes
	Z-PC-DIN8-17.5 DIN guide rapid assembly support 8 slot P=17,5mm	8	17,5 mm	-	Yes	Yes

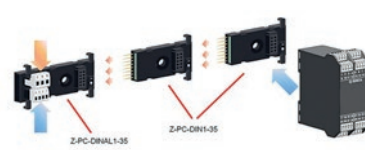
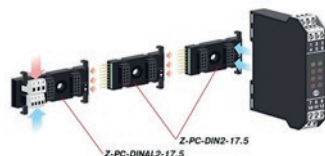

MAIN MAIN PRODUCT CODES

ORDER CODE	DESCRIPTION	ORDER CODE	DESCRIPTION
OPC-DA-SERVER	OPC Server I/O unlimited tags	STRATON-IDEUN	Straton development env. unlimited tags, USB activ. key
OPC-UA-SERVER	OPC Server I/O unlimited tags	STRATON-SNMP	SNMP agent driver Straton extension
STRATON-870-850	IEC 60870-5-101/104 Master / Slave + IEC 61850 Client / Server lic.	Z-PC-DIN1-35	DIN rail bus system 1 slot 35 mm
STRATON-870M	IEC 60870-5-101/104 Master activation license	Z-PC-DIN2-17.5	DIN rail bus system 2 slots 17.5 mm
STRATON-870S	IEC 60870-5-101/104 Slave activation license	Z-PC-DIN4-35	DIN rail bus system 4 slot 35 mm
STRATON-870S-850	IEC 60870-5-101/104 Slave license+IEC 61850 Client/Server	Z-PC-DIN8-17.5	DIN rail bus system 8 slot 17.5 mm
STRATON-D-USB	Straton activation key for IEC 61131 controllers	Z-PC-DINAL1-35	DIN rail bus system head terminal + 1 slot 35 mm
STRATON-FULL01	IEC 60870-5-101/104 Master / Slave + IEC 61850 Client / Server lic. + SNMP	Z-PC-DINAL2-17.5	DIN rail bus system head terminal + 2 slots 17.5 mm
STRATON-IDE256	Straton development env. 256 tags, USB activation key	Z-PC-DINAL2-52.5	DIN rail bus system head terminal + 2 slots 52.5 mm
STRATON-IDE512	Straton development env. 512 tags, USB activation key	Z-SUPPLY	Single-phase switching power supply 24V @ 1.5A



2

**INDUSTRIAL
COMMUNICATION
AND REMOTE CONTROL**



SENECA remote alarm and datalogging devices are designed to remotely manage, monitor and implement small automations for houses, buildings, plants, production machines through simple commands sent with SMS messages or via app. With any mobile device or smartphone you can control the switching on and off of a technical system, activate a contact, receive an anomaly or alarm signal. These professional and universal devices are easily programmable and are based on a GSM / GPRS module that acts as a phone communicator enabling intelligent way calls, commands, address books and data storage.



REMOTE CONTROL OF UNATTENDED SITES



FLEXIBLE SETTINGS



AUTOMATIC SENDING COMMANDS, DATA, ALARMS

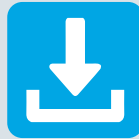

BUILT-IN MODEM AND I/O



REAL-TIME ALARM MANAGEMENT



ON-OFF TIME BASED CONTROLS



HVAC / TEMPERATURE CONTROL



RECHARGEABLE LI-ON BATTERY

TOP SELLING PRODUCTS

B-ALARM



Remote alarm unit, 1DI/1DO, basic functions

MY2B



GSM/GPRS remote alarm and datalogger unit, BASIC version

MY2S



GSM/GPRS remote alarm and datalogger unit, SECURITY AUDIO version

MYALARM3 CLOUD



App/cloud based monitoring and remote alarm unit

APPLICATION EXAMPLES

AUTOMATIC BARRIERS CONTROL



BOILER AND HVAC CONTROL

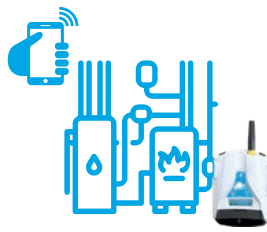

WATER CONSUMPTION AND LOSSES CONTROL



COLD ROOMS MONITORING

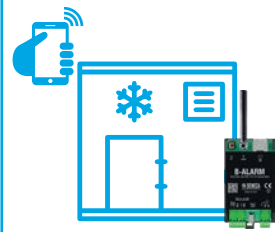

MAIN MAIN PRODUCT CODES

ORDER CODE	DESCRIPTION	ORDER CODE	DESCRIPTION
B-ALARM	Remote alarm Unit, 1DI / 1DO, basic functions	MY2G-R-0-M-B	MyALARM2 - gps version, relay, clamps, blue color
EASY LOG VIEWER	DAQ software for MY2, Z-GPRS2, Z-PC	MY2G-R-0-M-G	MyALARM2 - gps version, relay, clamps, grey color
EASY MYALARM2	MYALARM2 configurator	MY2S-0-0-M-B	MyALARM2 - security, no relay, clamps, blue color
MY2B-0-0-M-B	MyALARM2 - basic version, no relay, clamps, blue color	MY2S-0-0-M-G	MyALARM2 - security, no relay, clamps, grey color
MY2B-0-0-M-G	MyALARM2 - basic version, no relay, clamps, grey color	MY2S-R-0-M-B	MyALARM2 - security, relay, clamps, blue color
MY2-KITIP66	IP66 ABS kit enclosure for field application	MY2S-R-0-M-G	MyALARM2 - security, relay, clamps, grey color
MY2B-R-0-M-B	MyALARM2 - basic version, relay, clamps, blue color	MY3CLOUD-R-0-0-G	MyAlarm3, Cloud support, relay, grey color
MY2B-R-0-M-G	MyALARM2 - basic version, relay, clamps, grey color	MY3CLOUD-R-0-G-G	MyAlarm3, Cloud support, relay, GPS, grey color
MY2G-0-0-M-B	MyALARM2 - gps version, no relay, clamps, blue color	NTC-150	External NTC probe, 1,5 m, for MyALARM2
MY2G-0-0-M-G	MyALARM2 - gps version, no relay, clamps, grey color		



MYALARM SEAL, Z-GPRS3, Z-LOGGER3, Z-LTE advanced dataloggers represent a solution able to respond to the growing needs of data collection, real-time analysis and integration with IT systems in plant automation and monitoring. Designed to perform remote alarm, telemetry and datalogging functions, these devices are available with integrated UPS, integrated I/O channels, dedicated programming and visualization software, serial and Ethernet communication support, MQTT protocol and in most models 2G/3G+/4G modem with GNSS/GPS/GLONASS receiver.



SYNCHRONOUS / ASYNCHRONOUS



DATA REDUNDANCY



ALARM MANAGEMENT VIA SMS / DTMF



SENDING EMAIL FTP FILE



BLOCK PROGRAM ENVIRONMENT



IoT PROTOCOLS



BUILT-IN I/O



SERIAL / ETHERNET COMMUNICATION PORTS

TOP SELLING PRODUCTS

MYALARM SEAL



Remote datalogger, SEAL programming, control logic

Z-LOGGER3



Advanced datalogger, alarm module, web server with built-in IO

Z-GPRS3



Advanced GSM/GPRS datalogger, built-in IO, voice alarm

Z-LTE



4G worldwide datalogger with built-in I/O, remote control functions and voice commands

APPLICATION EXAMPLES

DATA ACQUISITION AND RETRANSMISSION

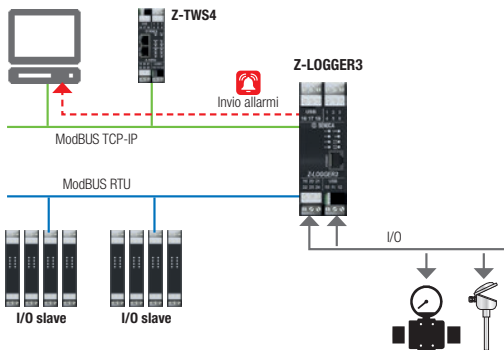

MQTT ARCHITECTURE

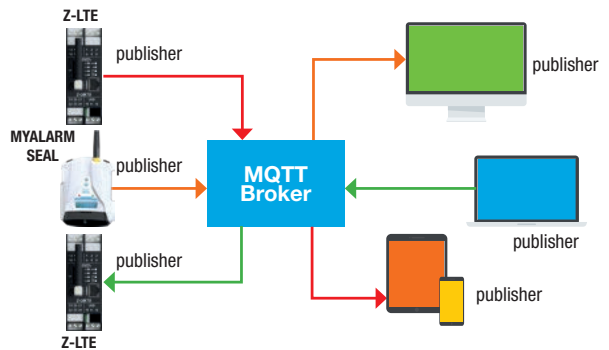

MAIN MAIN PRODUCT CODES

ORDER CODE	DESCRIPTION	ORDER CODE	DESCRIPTION
LOG FACTORY	Visualization and log data tool	MY-SEAL-R-0-0-G	Remote datalogger with SEAL control logic, relay board, grey color
MY-SEAL-0-0-0-B	Remote datalogger with SEAL control logic, blue color	MY-SEAL-0-W-0-G	Remote datalogger with SEAL control logic, radio module, grey color
MY-SEAL-R-0-0-B	Remote datalogger with SEAL control logic, relay board, blue color	MY-SEAL-0-0-G-G	Remote datalogger with SEAL control logic, GPS receiver, grey color
MY-SEAL-0-W-0-B	Remote datalogger with SEAL control logic, radio module, blue color	MY-SEAL-R-W-0-G	Remote datalogger with SEAL control logic, relay board, radio module, grey color
MY-SEAL-0-0-G-B	Remote datalogger with SEAL control logic, GPS receiver, blue color	MY-SEAL-R-0-G-G	Remote datalogger with SEAL control logic, relay board, GPS receiver, grey color
MY-SEAL-R-0-0-B	Remote datalogger with SEAL control logic, relay board, radio module, blue color	MY-SEAL-0-W-G-G	Remote datalogger with SEAL control logic, radio module, GPS receiver, grey color
MY-SEAL-R-0-G-B	Remote datalogger with SEAL control logic, relay board, GPS receiver, blue color	MY-SEAL-R-W-G-G	Remote datalogger with SEAL control logic, relay board, radio module, GPS receiver, grey color
MY-SEAL-0-W-G-B	Remote datalogger with SEAL control logic, radio module, GPS receiver, blue color	Z-GPRS3	Advanced GSM/GPRS datalogger, built-in IO, voice alarm
MY-SEAL-R-W-G-B	Remote datalogger with SEAL control logic, relay board, radio module, GPS receiver, blue color	Z-LOGGER3	Advanced datalogger, alarm module, web server with built-in IO
MY-SEAL-0-0-0-G	Remote datalogger with SEAL control logic, grey color	Z-LTE-WW	4G worldwide datalogger with built-in I/O, remote control functions and voice commands



Additional order codes and information

SENECA remote control devices are a perfect combination of the world of remote control and automation. The RTU range includes solutions for small installations, all-in-one solutions that combine I/O, control logic and communication system, equipment for special applications (unmanned sites, pumping stations, energy management).

The use of compatible platforms and of the most common technological standards offers to the user the possibility to improve the efficiency and the quality of the investments in his applications.



WIDE RTU RANGE



H24 REMOTE CONTROL



ADVANCE ALARM



REDUCED OPERATING COSTS



ENERGY MONITORING



DATA STORAGE



OPENNESS TO SCADA / OPC



COMMANDS AND NOTIFICATIONS VIA EMAIL/SMS / APP

TOP SELLING PRODUCTS

MY2B



GSM/GPRS remote alarm and datalogger unit, BASIC version

Z-LTE



4G worldwide datalogger with built-in I/O, remote control functions and voice commands

Z-PASS2-S



Remote Controller 4G worldwide, VPN, serial device server, GPS and built-in I/O

S6001-RTU



Remote Control Unit with built-in I/O and 3G+/4G modem

APPLICATION EXAMPLES

WEB-BASED REMOTE CONTROL

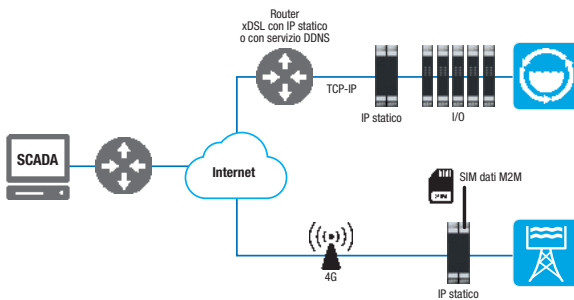

INTRANET / APN REMOTE CONTROL

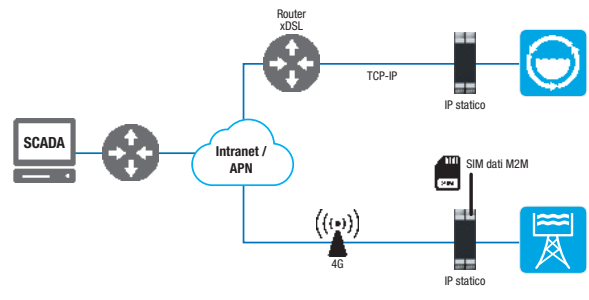

MAIN MAIN PRODUCT CODES

ORDER CODE	DESCRIPTION	ORDER CODE	DESCRIPTION
BATTHP	Micro-RTU Lithium batteries, 14,4V, 18,5 Ah	S6001-RTU	Remote Control Unit with built-in I/O and 3G+ modem
BATT-S	Single battery pack 3 cell 11,1 V - 14,5 Ah	S6001-RTU-4GWW	Remote Control Unit with built-in I/O and 4G WW LTE modem
BATT-2S	Double battery pack 3 cell 11,1 V - 14,5 Ah	Z-LTE-WW	4G worldwide datalogger with built-in I/O, remote control functions and voice commands
BOX-RTU-IP65	IP65 junction box with fixing support	S-DIN M-RTU	DIN rail guide support
EASY RTU LP	RTU-LP devices software configurator	Z-MINIRTU	GSM/GPRS telecontrol unit with built-in I/O and Straton SoftPLC
RTU-LP-ST	Low power RTU, FTP version, 4DI, 2AI, 2DO	Z-PASS2-S4GEUUPG	3G Modem upgrade and replacement → 4GLTE/EMEA c/o laboratory (Z-PASS2-S)
RTU-LP-ST1	Low power RTU, FTP version, 4DI, 2AI, 2DO, single battery pack	Z-PASS2-S4GWWUPG	Upgrade and replacement of 3G Modem → 4GLTE/WW c/o laboratory (Z-PASS2-S)
RTU-LP-ST2	Low power RTU, FTP version, 4DI, 2AI, 2DO, double battery pack		



SENECA Gateways connect new and legacy systems and enable secure, uninterrupted data flow between peripheral devices and centralized servers. Gateways establish two-way communication between the field and the supervisor, as well as offering processing and data storage capabilities to provide services with secure VPN connections and to manage field devices in real time. SENECA's new range of industrial routers / gateways includes devices that can extend networks and allow process data to pass between different levels of the network.



ETHERNET / SERIAL CONVERTER



PROTOCOL CONVERTER



SERIAL DEVICE SERVER

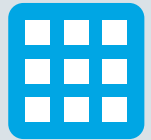

SHARED MEMORY GATEWAY



SERIAL SNIFFER

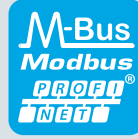

FIELDBUS SUPPORT



WI-FI STATION / ACCESS POINT



UL APPROVAL

TOP SELLING PRODUCTS



Industrial Gateway - Serial Device Server



2-port ModBUS RTU industrial gateway / serial device server with Wi-Fi access



Gateway - ModBUS RTU / TCP-IP ↔ Profinet IO protocol converter



ModBUS RTU / TCP-IP ↔ MBUS gateway

APPLICATION EXAMPLES

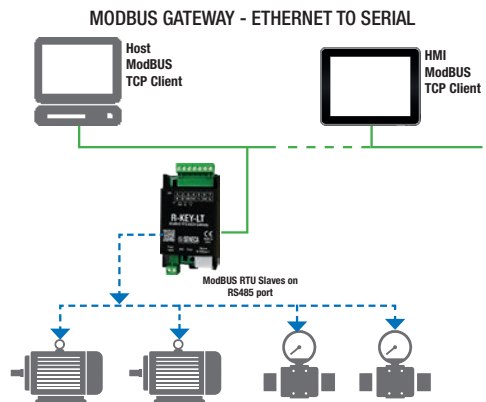
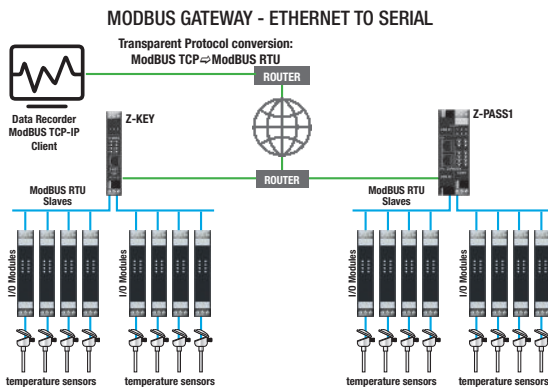





MAIN MAIN PRODUCT CODES

ORDER CODE	DESCRIPTION	ORDER CODE	DESCRIPTION
R-KEY-LT	Compact industrial ModBUS gateway	Z-KEY-0	Industrial Gateway - Serial Device Server
R-KEY-MBUS	Compact industrial M-BUS gateway	Z-KEY-2ETH	Industrial Gateway - Serial Device Server, 2xEthernet
R-KEY-LT-P	Compact Industrial Gateway Profinet IO ↔ ModBUS RTU / TCP-IP	Z-KEY-2ETH-P	Industrial Gateway - Serial Device Server, 2xProfinet IO
SDD	Discovery Device, IP scanner for Z-KEY, Z-PASS1/2	Z-KEY-ETH-IP	Industrial Gateway - Serial Device Server, Ethernet/IP
SESC	Ethernet to Serial Connection tool for Z-KEY, Z-PASS1/2	Z-KEY-MBUS	ModBUS RTU / TCP-IP M-BUS gateway
TEMP-TAG-Z-KEY	Excel template for Z-KEY tags (gateway mode)	Z-KEY-P	Gateway - ModBUS RTU / TCP-IP Profinet IO protocol converter
TEMP-WEB-Z-KEY	Web page template for Z-KEY	Z-KEY-WIFI	2-port ModBUS RTU industrial gateway / serial device server with Wi-Fi access



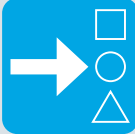
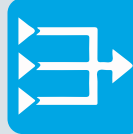
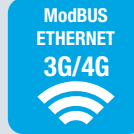
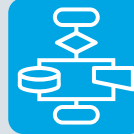



Additional order codes and information

SENECA IoT Advanced Gateways establish two-way communication between the field and supervision, as well as offering diagnostic, processing and data storage capabilities to provide services with secure VPN connections and to manage devices in the field in real time. Z-PASS1 and Z-PASS2 are multifunction devices, able allow the transfer of process data between IT and OT communication. Applications therefore range from M2M/IoT communications to remote maintenance, from network integration to protocol conversion to integration with Cloud platforms and services, in most industrial sectors.

 MULTIFUNCTION DEVICES	 NAT1:1 & ADVANCED ROUTING	 EXTENDED CONNECTIVITY	 BUILT-IN LOGIC FUNCTIONS
 MQTT SUPPORT	 OPC UA SUPPORT	 ON PREMISE CLOUD SUPPORT	 VPN REMOTE ACCESS

TOP SELLING PRODUCTS

<p>R-PASS-0</p>  <p>IloT VPN compact gateway / router</p>	<p>Z-PASS1</p>  <p>VPN Industrial Gateway - Serial Device Server, built-in I/O</p>	<p>Z-PASS2</p>  <p>VPN Industrial Gateway, Serial Device Server, Router 4G/LTE WW, GPS, built-in I/O</p>	<p>SSD</p>  <p>Multifunction IloT HMI Gateway</p>
---	--	--	---

APPLICATION EXAMPLES

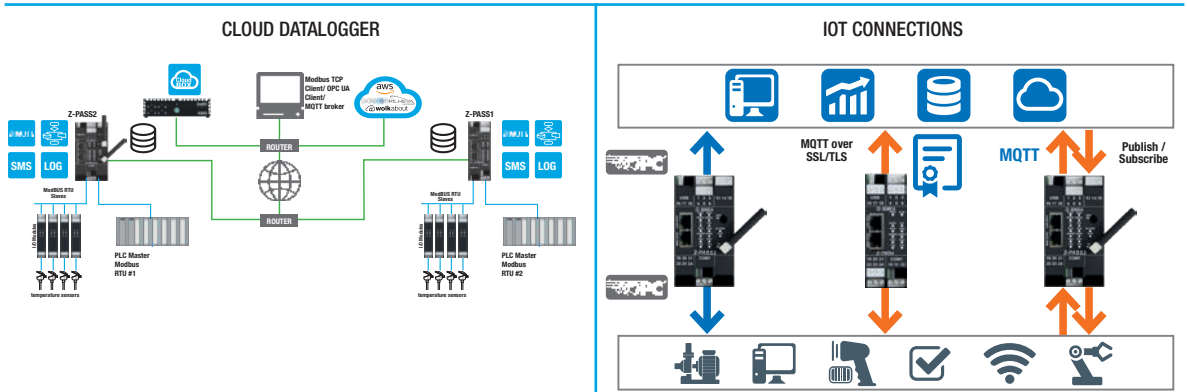

MAIN MAIN PRODUCT CODES

ORDER CODE	DESCRIPTION	ORDER CODE	DESCRIPTION
R-PASS-0	IloT VPN compact gateway / router	SSD-0-L-V-1	Advanced touchscreen HMI with built-in IloT, logic, VPN and I/O
R-PASS-W	IloT VPN WiFi compact gateway / router	Z-PASS1-10	Industrial Gateway - Serial Device Server, built-in I/O
SSD-0-0-0-0	Advanced touchscreen HMI with built-in I/O	Z-PASS2-4GWW	Gateway / Router 4G worldwide, VPN, serial device server, GPS e I/O integrati
SSD-0-L-0-0	Advanced touchscreen HMI with built-in logic and I/O	Z-PASS2-4GEU-UPG	3G Modem upgrade and replacement → 4GLTE/EMEA c/o laboratory
SSD-0-0-V-0	Advanced touchscreen HMI with built-in VPN and I/O	Z-PASS2-4GWW-UPG	Upgrade and replacement of 3G Modem → 4GLTE/WW c/o laboratory
SSD-0-0-0-1	Advanced touchscreen HMI with built-in IloT and I/O	Z-PASS2-S-4GWW	Remote Controller 4G worldwide, VPN, serial device server, GPS and I/O integrated
SSD-0-L-V-0	Advanced touchscreen HMI with built-in logic, VPN and I/O	Z-PASS2-S4GEUUPG	3G Modem upgrade and replacement → 4GLTE/EMEA c/o laboratory (Z-PASS2-S)
SSD-0-L-0-1	Advanced touchscreen HMI with built-in IloT, logic and I/O	Z-PASS2-S4GWWUPG	Upgrade and replacement of 3G Modem → 4GLTE/WW c/o laboratory (Z-PASS2-S)
SSD-0-0-V-1	Advanced touchscreen HMI with built-in IloT, VPN and I/O		



LET'S is SENECA's VPN - IIoT platform that reduces maintenance costs for automation applications and management of machines and plants, offering an integrated connectivity service on 3 levels: remote access to data, programmable control, network monitoring. Based on the Server VPN BOX module, LET'S allows "Always ON" connections (Remote Control / Single LAN mode) for plant supervision or "ON Demand" connections (Teleservice / Point-to-Point mode) to third party machines and devices and for maintenance or data collection services.

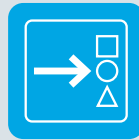

MULTIFUNCTION DEVICES



BUILT-IN I/O



PLC INTEGRATION S7 PROTOCOL



BUILT-IN CONTROL LOGIC

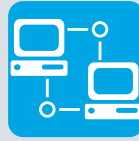

VPN SINGLE LAN / P2P

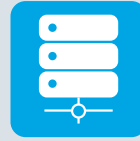

SERVER IN HOUSE



OPENVPN SUPPORT



VPN CLIENT APP MOBILE

TOP SELLING PRODUCTS

VPN BOX



VPN Server for Point-to-Point / Single LAN connections

Z-PASS1

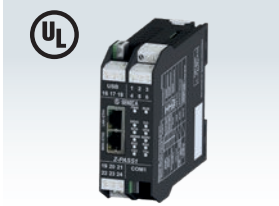

Industrial Gateway - Serial Device Server, built-in I/O

Z-PASS2



Gateway / Router 4G, VPN, serial device server, GPS, built-in I/O

Z-PASS2-S



Remote Controller 4G worldwide, VPN, serial device server, GPS and built-in I/O

APPLICATION EXAMPLES

"ALWAYS ON" CONNECTION

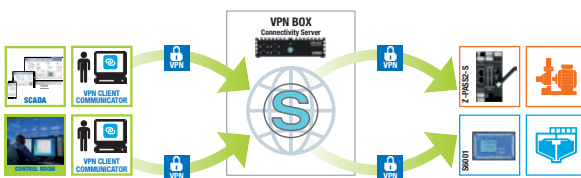

"ON DEMAND" CONNECTION

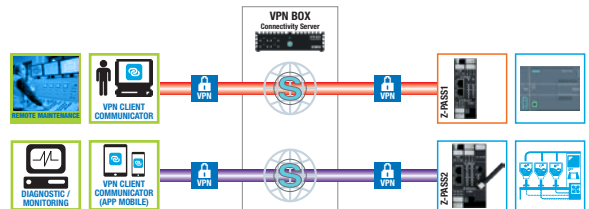

MAIN MAIN PRODUCT CODES

ORDER CODE	DESCRIPTION	ORDER CODE	DESCRIPTION
SSD-0-0-0-0	Advanced touchscreen HMI with built-in I/O	Z-PASS2-S-4GWW	Integrated 4G worldwide Remote Controller, VPN, serial device server, GPS and I/O
SSD-0-L-0-0	Advanced touchscreen HMI with built-in logic and I/O	VPN-BOX	VPN Server Point-to-Point / Single LAN Connections
SSD-0-0-V-0	Advanced touchscreen HMI with built-in VPN and I/O	VPN BOX VM	Virtual Machine VPN Server for Point-to-Point / Single LAN connections
SSD-0-0-0-1	Advanced touchscreen HMI with built-in IIoT and I/O	S6001-PC-4GWW	Pump controller with built-in I/O, 4G WW LTE, Straton programming system and 7" HMI
SSD-0-L-V-0	Advanced touchscreen HMI with built-in logic, VPN and I/O	S6001-RTU-4GWW	All-in-one RTU with built-in I/O, 4G WW LTE modem and Straton programming system
SSD-0-L-0-1	Advanced touchscreen HMI with built-in IIoT, logic and I/O	S6001-RTU-E-4GWW	All-in-one RTU with built-in I/O, 4G WW LTE modem and Straton programming system, Energy protocols
SSD-0-0-V-1	Advanced touchscreen HMI with built-in IIoT, VPN and I/O	Z-PASS2-S-E-4GWW	Energy Remote Controller 4G worldwide, VPN, serial device server, GPS and integrated I/O
SSD-0-L-V-1	Advanced touchscreen HMI with built-in IIoT, logic, VPN and I/O	Z-TWS4-S-10	Multifunction controller IEC 61131, built-in I/O, Straton workbench, OEM version
Z-PASS1-10	VPN Industrial Gateway - Serial Device Server, built-in 1DI, 2DO, 1DI/DO	Z-TWS4-E-10	Multifunction controller IEC 61131, built-in I/O, Straton workbench, OEM version, energy protocols
Z-PASS2-4GWW	Gateway / Router 4G worldwide, VPN, serial device server, built-in GPS and I/O		



Additional order codes and information

Cloud BOX is the Cloud - IIoT “on premise” solution to centralize data, manage remote connections, create customizable multi-user supervision pages. Available in physical and virtual version, Cloud BOX provides several widgets (input status, charts, bars, etc.), components that represent the status of the connected devices. Starting from these widgets it is possible to create responsive web pages (for PC, tablet, smartphone) of dashboard type (e.g. historical data, commands, event management, trend management) or synoptic supervision pages.

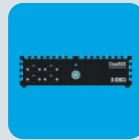

HARDWARE



VIRTUAL MACHINE



SUPERVISION



TAG MANAGEMENT



DATA STORAGE



HISTORICAL DATA/ALARMS



SENDING COMMANDS



EXPORT AND DATA RECOVERY

CLOUD BOX - INDUSTRIAL IOT BOX WITH SUPERVISORY WEB APPLIANCE

WHAT CLOUD BOX IS



IIoT - Cloud solution for data centralization, remote connections management, multi-user custom supervision pages editing.

- Sending commands **HOW IT WORKS** to dataloggers, RTUs and communication devices
- Incoming data storage from field devices into a centralized database
- Access to Cloud BOX through custom web pages
- Available in built-in version or Virtual Machine / VmWare with third parties server

HOW IT WORKS

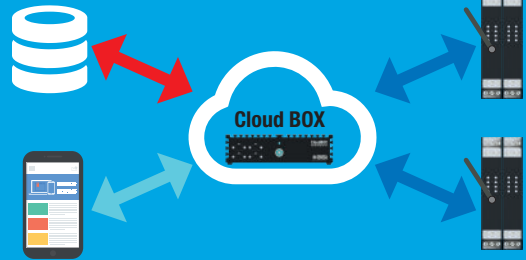

APPLICATION EXAMPLES

BUILT-IN SYSTEM

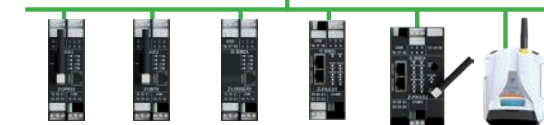
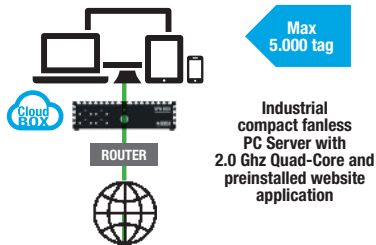

Supported devices: Z-GPRS3, Z-UMTS, Z-LOGGER3, Z-PASS1, Z-PASS2, MYALARM SEAL

VIRTUAL MACHINE

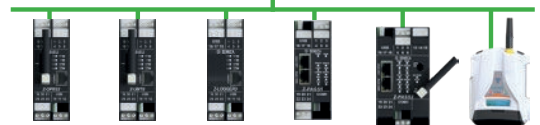
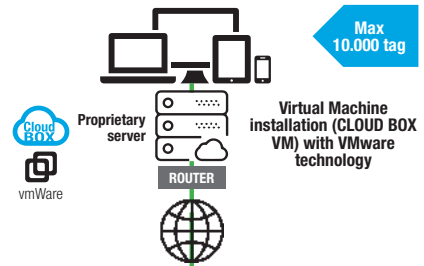

Supported devices: Z-GPRS3, Z-UMTS, Z-LOGGER3, Z-PASS1, Z-PASS2, MYALARM SEAL

MAIN MAIN PRODUCT CODES

ORDER CODE	DESCRIPTION
CLOUD BOX	Micro Scada / Industrial IIoT Box
CLOUD BOX VM-D	Virtual Server for data acquisition from SeAL RTU, up to 1 demo device
CLOUD BOX VM-1K	Virtual Server license for data acquisition from SeAL RTU, up to 1.000 tags
CLOUD BOX VM-5K	Virtual Server license for data acquisition from SeAL RTU, up to 5.000 tags
CLOUD BOX VM-10K	Virtual Server license for data acquisition from SeAL RTU, up to 10.000 tags
CLOUD BOX VM-UP1	Virtual Server license upgrade for data acquisition from 1.000 to 5.000 tags
CLOUD BOX VM-UP2	Virtual Server license upgrade for data acquisition from 5.000 to 10.000 tags
CLOUD BOX VM-UP3	Virtual Server license upgrade for data acquisition from 1.000 to 10.000 tags



Serial transmission is a mode of communication between digital devices in which information is communicated one after the other and reaches the receiver sequentially in the same order in which the sender transmitted it. Serial mode is one of the most popular in the computer field because it requires fewer wires, thus reducing costs.

It is also more tolerant of interference and transmission errors. SENECA instrumentation allows the management of RS232, TTL, RS485, USB interfaces to and from PC and control and acquisition systems.

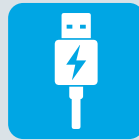

EASY WIRING



FLEXIBLE DISTANCE

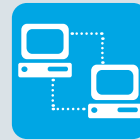

SYNCHRONOUS / ASYNCHRONOUS

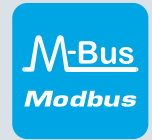

FIELDBUS SUPPORT



FAST CONFIGURATION



PORTABLE VERSIONS



ADAPTABLE ARCHITECTURES



EXISTING DEVICES/ NETWORKS INTEGRATION

TOP SELLING PRODUCTS



K107USB
USB <-> RS485 converter / Isolator



S117P1
RS232/USB, TTL/USB, RS485/USB serial converter



Z-MBUS
M-BUS <-> RS232-RS485 adapter



Z-4TC-D
Thermocouples A/D converter

APPLICATION EXAMPLES

CONNECTION OF SEVERAL RS485 SERIAL LINES (MODBUS) WITH ELECTRICAL ISOLATION

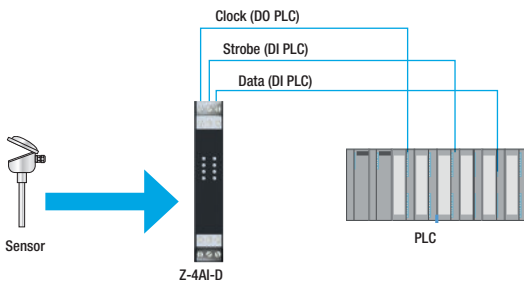

MULTIPLE CONNECTION AND DATA TRANSMISSION WITH USB/RS485 ELECTRICAL ISOLATION

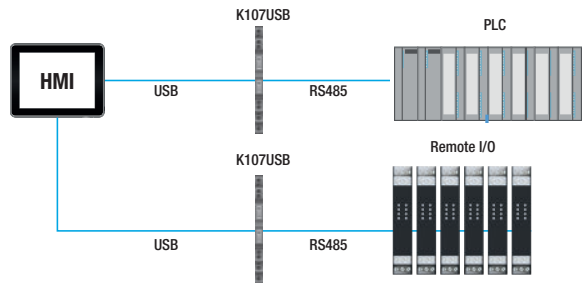

MAIN MAIN PRODUCT CODES

ORDER CODE	DESCRIPTION
EASY-USB	USB - UART TTL converter
S107P	RS232 - RS485/422 serial converter, portable version
S107USB	RS485/USB serial converter, portable version
S117P1	RS232/USB, TTL/USB, RS485/USB serial converter
Z107	DIN rail RS232 - RS485/422 serial converter
Z-MBUS	M-BUS ↔ RS232-RS485 adapter



Additional order codes and information

SENECA S232, S485, SETH and SCAN fiber optic converters give the possibility to extend over fiber optics any type of network / bus (LAN / Ethernet, CAN or serial) at the same time.

They also ensure high levels of security and reliability. The modules make it possible to use both mono-modal and multi-modal fiber, ensuring a solid communication, reliable and very high speed communication. The application of fiber optics ranges from industrial environments to civil environments, energy production plants and telecommunications and control systems.



HIGH SPEED COMMUNICATION

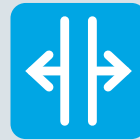

DATA / POWER LINES NOT SEPARATED



ELECTRIC DISCHARGE PROTECTION



EASY DIAGNOSTIC



REAL-TIME DATA TRANSMISSION



RELIABLE MEDIUM



HIGH COVERAGE DISTANCES



NOISE IMMUNITY

TOP SELLING PRODUCTS

S232-FO



RS232 - Fiber Converter single mode / multi mode single / double loop

S485-FO



RS485 - Fiber Converter single mode / multi mode single / double loop

SETH-FO



Ethernet - Fiber Converter single mode / multi mode single / double loop

SCAN-FO



CAN - Fiber Converter single mode / multi mode single / double loop

APPLICATION EXAMPLES

POINT TO POINT (LINKED DIRECTLY)

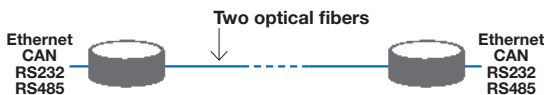

RING (SINGLE LOOP)

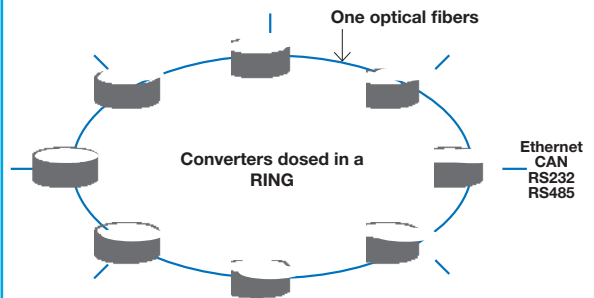

MAIN PRODUCT CODES

ORDER CODE	DESCRIPTION	ORDER CODE	DESCRIPTION
FO TEST	Fiber optics automatic test software	SCAN-FO-MONO-SL	CAN - single mode fiber, single loop converter
S232-FO-MONO-SL	RS232 - single mode fiber, single loop converter	SCAN-FO-MONO-DL	CAN - single mode fiber, double loop converter
S232-FO-MONO-DL	RS232 - single mode fiber, double loop converter	SCAN-FO-MULTI-SL	CAN - multimode fiber, single loop converter
S232-FO-MULTI-SL	RS232 - multi mode fiber, single loop converter	SCAN-FO-MULTI-DL	CAN - multimode fiber, double loop converter
S232-FO-MULTI-DL	RS232 - multi mode fiber, double loop converter	SETH-FO-MONO-SL	Ethernet - single mode fiber, single loop converter
S485-FO-MONO-DL	RS485 single mode fiber, double loop converter	SETH-FO-MONO-DL	Ethernet - single mode fiber, double loop converter
S485-FO-MULTI-DL	Multidrop fiber optic - RS485 double loop converter	SETH-FO-MULTI-SL	Ethernet - multimode fiber, single loop converter
S485-FO-MONO-SL	RS485 - single mode fiber, single loop converter	SETH-FO-MULTI-DL	Ethernet - multimode fiber, double loop converter
S485-FO-MULTI-SL	Multidrop fiber optic - RS485 single loop converter		



Strong experience in interface technology, SENECA's proposal of radio modules and radio modems is one of the key elements of automation and communication systems, particularly in the transport of signals from a few meters to tens of kilometers.

The use of UHF / VHF / LoRa technologies allows you to reach distances of several kilometers with maximum reliability.

It also allows you to perform functions of remote control, remote interrogation and diagnostics of devices in the field through connections point-to-point, multi-point, broadcasting, signal repetition.



NBFM / GFSK MODULATION



RS232 / RS485 INTERFACE



Vac7dc WIDE RANGE



BUILT-IN I/O



TRANSMISSION POWER 25..500mW



ModBUS / LoRa TECHNOLOGIES



OPERATING BANDWIDTH 169 / 869 MHz



OUTDOOR VERSIONS

TOP SELLING PRODUCTS



Simplex/half duplex radiomodem, 868 - 870 MHz



Radiomodem 869 MHz with LoRa technology



169MHz Radiomodem RS232/RS485 interface, RED directive



169MHz Radiomodem with built-in I/O, RS485

APPLICATION EXAMPLES

POINT-TO-POINT DATA TRANSMISSION (E.G. I/O REPETITION)

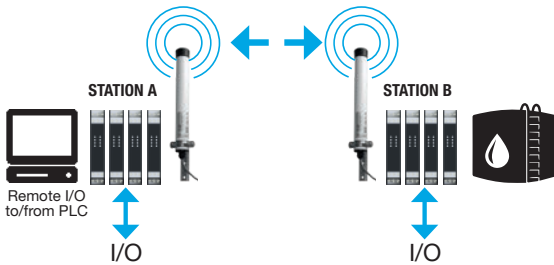

SHORT RANGE SIGNAL REPETITION

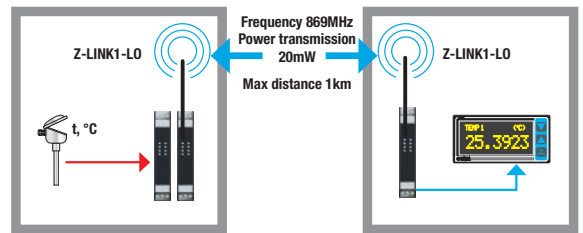

MAIN PRODUCT CODES

ORDER CODE	DESCRIPTION	ORDER CODE	DESCRIPTION
A-169DV12	169MHz vert.Dip. lambda/2 ant, BNC M, 5mt, low loss cable	RTURADIO-169	Radiomodem 169MHZ, 4DI, 2DO, 2AO, 2AI, RS485
A-169DV14	169MHz vert.Dip. lambda/4 ant, BNC M, L=450 mm	RTURADIO-169DV14	Radiomodem 169MHZ, 4DI, 2DO, 2AO, 2AI, RS485, vertical
A-169DV16	169MHz vert.Dip. lambda/4 ant, BNC M	RTURADIO-169DV12	Radiomodem 169MHZ, 4DI, 2DO, 2AO, 2AI, RS485, dipole
A-169YAGI	169MHz 3 elem. Yagi Ant., BNC M, 10 mt, low loss cable	RTURADIO-169YAGI	Radiomodem 169MHZ, 4DI, 2DO, 2AO, 2AI, RS485, yagi
RADIO SETUP	Configuration software Z-AIR-1, RM169-1, RTURADIO 169	Z-AIR-1	Radiomodem 868MHz with omnidir. antenna, RED compl. 5 mt cable
RM169-1	169MHZ Radiomodem, 1DI,1DO,1RS485, BNC-F connector, RED directive	Z-AIR-1-10	Radiomodem 868MHz with omnidir. antenna, RED compl. 10 mt cable
RM169-1-169DV12	169MHZ Radiomodem, 1DI,1DO,1RS485, vertical dipole antenna, RED directive	Z-LINK1-LO	Adattapre M-BUS ↔ RS232-RS485
RM169-1-169YAGI	169MHZ Radiomodem, 1DI,1DO,1RS485, 3 elements Yagi antenna, RED directive	Z-LINK1-NM	869 MHz radiomodem with RS232/RS485 interface
RM169-1-169DV14	169MHZ Radiomodem, 1DI,1DO,1RS485, vertical stilo antenna, RED directive		



Additional order codes and information

R-GWR is an interface and measurement system for industrial, civil or environmental variables. In fact, the device creates a network of remote sensors connected with LoRa radio technology (863-865 MHz) and accessible via ModBUS RTU/TCP-IP protocol. R-GWR operates as a radio hub capable of managing up to 32 sensors, each capable of acquiring 1) a temperature signal/ humidity integrated, 2) a generic digital input / analog (0-30 Vdc) terminal or alternatively a counter @16bit with maximum frequency 1Hz.



ENVIRONMENTAL
MEASUREMENTS



BATTERY POWERED
SENSORS



UP TO 32 LORA
NODES / SENSORS

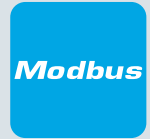

MODBUS

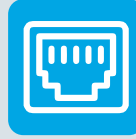

ETHERNET



EXT RADIO
ANTENNA



BUILDING
MONITORING



LOW COST
INSTALLATION

TOP SELLING PRODUCTS

R-GWR



Gateway / Radio Hub
for wireless sensors

R-GWR-S



Home automation sensor with
digital / analog input and antiflooding

R-GWR-IP



Industrial sensor with digital /
analog input

R-BT1



Single battery pack

APPLICATION EXAMPLES

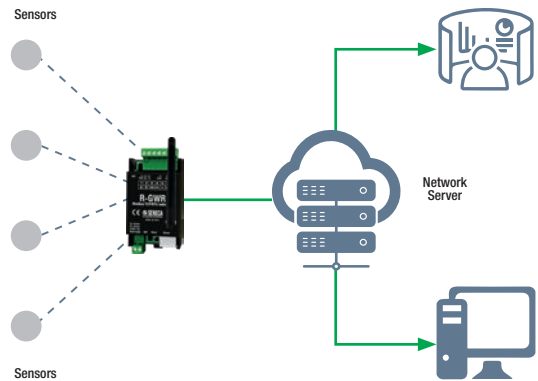
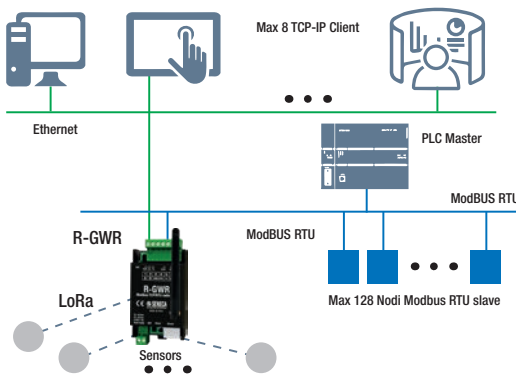

MAIN PRODUCT CODES

ORDER CODE	DESCRIPTION
R-BT1	Single battery pack
R-BT2	Double battery pack 3.6V
R-GWR	ModBUS gateway for wireless sensors
R-GWR-IP-1	LoRa industrial sensor with analog/digital input
R-GWR-IP-2	Sensore industriale LoRa con ingresso analogico/digitale, batteria doppia
R-GWR-S-1	LoRa home automation sensor with analog/digital input and anti flooding
R-GWR-AF	Anti-Flooding Sensor



3

**POWER MONITORING
AND ELECTRICAL
MEASUREMENT**



S203 Power Meters are specifically designed to detect the features of power supply in networks and in single-phase or three-phase users. They allow energy and power analysis and therefore the control of power quality. At the same time in many versions are also used to continuously record the trend of the available alternating variables. The measurement and event reporting functions provide a basis of useful information for controlling the right operation of a machine, maximizing energy efficiency.

600
VacVOLTAGE
INPUT100 mA
5 Arms
4.000 ACURRENT
INPUTEMBEDDED
COUNTER METER

Modbus

MODBUS
COMMUNICATIONSOFTWARE / APP
PROGRAMMINGLCD
DISPLAYMULTIPLE OPTION
CONNECTIONSMAX
ISOLATION

TOP SELLING PRODUCTS

S203T



AC triple phase network analyzer,
100 mA input

S203TA-D



AC three phase network analyzer with
energy meter

S203RC-D



Three-phase Network Analyzer for
Rogowski's sensor

TA100

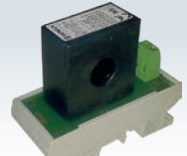

CT for S203T, 100A/100mA, 0,1% of
accuracy

APPLICATION EXAMPLES

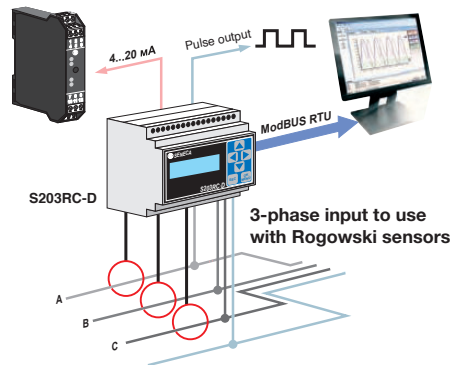
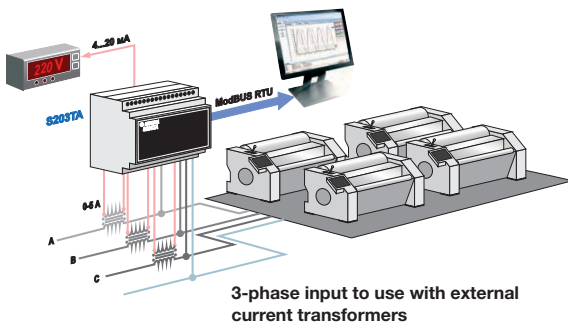

MAIN PRODUCT CODES

ORDER CODE	DESCRIPTION	ORDER CODE	DESCRIPTION
RC-V250-100	Rogowski coil, 100 mv/kA output, 50-60 Hz, 65 mm	S203TA AC	three phase network analyzer up to 5 Arms input
RC-V400-050	Rogowski coil, 50 mv/kA output, 50-60 Hz, 115 mm	S203TA-D AC	three phase network analyzer with energy meter
RC-V400-100	Rogowski coil, 100 mv/kA output, 50-60 Hz, 115 mm	TA100 CT	for S203T, 100A/100mA, 0,1% of accuracy
RC-V500-100	Rogowski coil, 100 mv/kA output, 50-60 Hz, 147 mm	TA15 CT	for S203T, 15A/100mA, 0,1% of accuracy
S203RC-D	Three-phase Network Analyzer for Rogowski's sensor	TA25	Current transf. for S203T, 25A/100mA, 0,1% of accuracy
S203T AC	triple phase network analyzer, 100 mA input		



R203 three-phase power meter family accepts current measurement inputs for CTs with current/voltage output, TVs and Rogowski sensors with single-phase, three-phase, 3/4 wire supporting ModBUS RTU, ModBUS TCP-IP protocols, Peer-To-Peer. R203 offers also the measurement and recording of harmonics in voltage / current up to 55th order with THD (total harmonic distortion) calculation. distortion).



UNIVERSAL ANALOG INPUT



HARMONICS UP TO 55TH ORDER WITH THD



HIGH ACCURACY



SMART PROGRAMMING



ENERGY COUNTER



EMBEDDED DATALOGGER



DUAL ETHERNET / DAISY CHAIN



FAULT-BY PASS / MODBUS PASSTHROUGH

TOP SELLING PRODUCTS



R203
Three-phase power meter with Ethernet port and universal inputs



R203-ROG-025
Power meter Kit, 2xETH, univ. Input, 3xROG L25 Ø12, 100mV/1KA 3mt



R203-ROG-040
Power meter Kit, 2xETH, univ. Input, 3xROG L40 Ø12, 100mV/1KA 3mt



R203TA-50
Power meter kit, 2xETH, univ. input, 3xTA 50/5A, cl.0,5/1, D23mm

APPLICATION EXAMPLES

CONNESSIONE DAISY CHAIN

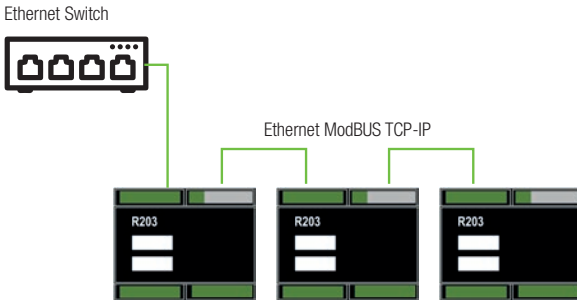

MODBUS PASS THROUGH

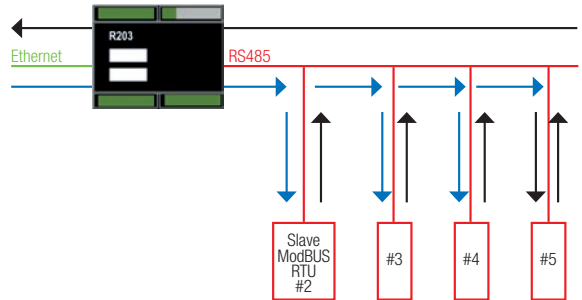

MAIN PRODUCT CODES

ORDER CODE	DESCRIPTION	ORDER CODE	DESCRIPTION
R203	Three-phase power meter with Ethernet port and universal inputs	R203-ROG-040-10	Power meter Kit, 2xETH, univ. Input, 3xROG L40 12, 100mV/1KA 10mt
R203-ROG-025	Power meter Kit, 2xETH, univ. Input, 3xROG L25 12, 100mV/1KA 3mt	R203-ROG-060	Power meter Kit, 2xETH, univ. Input, 3xROG L60 12, 100mV/1KA 3mt
R203-ROG-025-5	Power meter Kit, 2xETH, univ. Input, 3xROG L25 12, 100mV/1KA 5mt	R203-ROG-060-5	Power meter Kit, 2xETH, univ. Input, 3xROG L60 12, 100mV/1KA 5mt
R203-ROG-025-10	Power meter Kit, 2xETH, univ. Input, 3xROG L25 12, 100mV/1KA 10mt	R203-ROG-060-10	Power meter Kit, 2xETH, univ. Input, 3xROG L60 12, 100mV/1KA 5mt
R203-ROG-040	Power meter Kit, 2xETH, univ. Input, 3xROG L40 12, 100mV/1KA 3mt	R203-ROG-090	Power meter Kit, 2xETH, univ. Input, 3xROG L90 12, 100mV/1KA 3mt
R203-ROG-040-5	Power meter Kit, 2xETH, univ. Input, 3xROG L40 12, 100mV/1KA 5mt	R203-TA50	Power meter kit, 2xETH, univ. input, 3xTA 50/5A, cl.0,5/1, D23mm



Additional order codes and information

T203PM is a series of single-phase AC/DC TRMS power meter, ModBUS interface, analog and digital output, inputs with 3 current measurement ranges: 100, 300 or 600 Aac/dc depending on the version (T203PM100-MU, T203PM300-MU, T203PM600-MU) and for voltage 290 Vac. 1000 Vdc. The instruments carry out the direct measurement of current and energy without using external CTs. T203PMs measure voltage values, AC/DC current, active/reactive/apparent power, power factor, frequency, voltage, current, reactive apparent power, power factor, frequency, harmonic distortion (THD).



DIRECT MEASUREMENT



ANALOG VOLTAGE OUTPUT



HARMONIC ANALYSIS



DIGITAL OUTPUT



MODBUS RTU INTERFACE



MICRO USB PORT



SETTINGS VIA EASY SETUP 2



EMBEDDED ENERGY METER

TOP SELLING PRODUCTS

T203PM100-MU

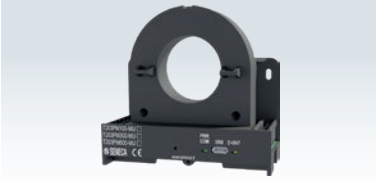

Single-phase AC/DC TRMS power meter, inputs up to 100 Vac/dc, ModBUS, analog and digital output

T203PM300-MU



Single-phase AC/DC TRMS power meter, inputs up to 300 Vac/dc, ModBUS, analog and digital output

T203PM600-MU



Single-phase AC/DC TRMS power meter, inputs up to 600 Vac/dc, ModBUS, analog and digital output

TYPICAL APPLICATION

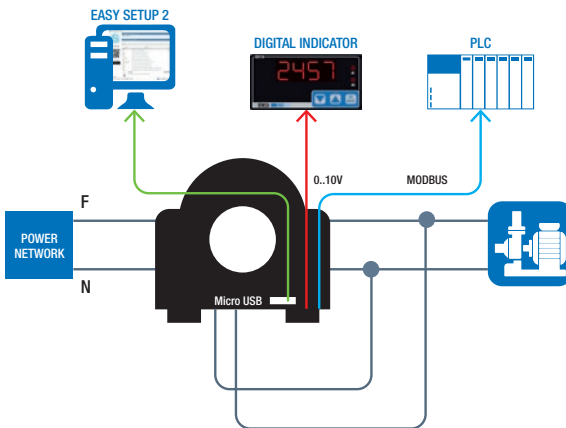

AVAILABLE MEASURES VIA SERIAL

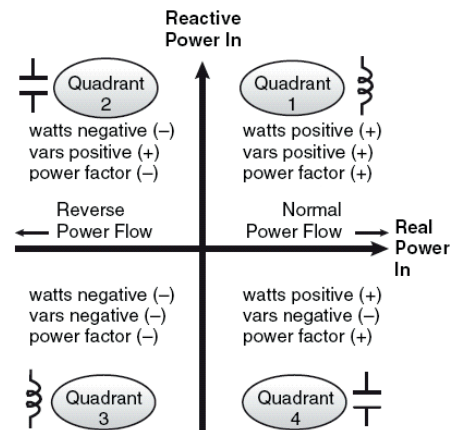

MAIN PRODUCT CODES

ORDER CODE	DESCRIPTION
T203PM100-MU	Single-phase power meter AC/DC TRMS, inputs up to 100 Vac/dc, ModBUS, analog and digital output
T203PM300-MU	Single-phase AC/DC TRMS power meter, inputs up to 300 Vac/dc, ModBUS, analog and digital output
T203PM600-MU	Single-phase AC/DC TRMS power meter, inputs up to 600 Vac/dc, ModBUS, analog and digital output
CU-A-MICROB	Micro USB-A USB-B cable 5 P



The multifunctional network analyzers Series S604 and S711 are innovative instruments for measuring and storing electrical parameters. They are particularly suitable when you need a device for the analysis and control of consumption control, with an excellent price/performance ratio. At versions with Rogowski current transducers, they offer extreme ease of connection and can be used in applications with high currents, linear measurements, retrofitting, audits, etc. The instruments can communicate via the RS485 serial port with ModBUS RTU/ ASCII protocol or LAN port.



SINGLE PHASE / THREE PHASE INSERTION



DATA STORAGE



BUILT-IN DIGITAL I/Os



SMART PROGRAMMING



MODBUS / ETHERNET COMMUNICATION



EMBEDDED ENERGY COUNTERS



THD / HARMONICS (UP to 15%)



CT / ROGOWSKI / DIRECT CURRENT

TOP SELLING PRODUCTS



S604B
Three phase power meter, BASIC, Modbus,1MB



S604E
Power Meter, Energy PLUS, 8MB log. Harm.



S604E-ROG
Kit Energy PLUS RS485 Modbus+3 Rog. RC150



S711B
Three-phase network analyzer LCD 96x96 BASIC version

APPLICATION EXAMPLES

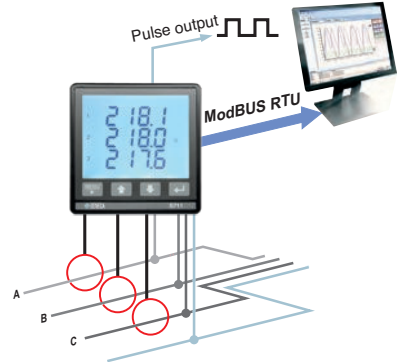
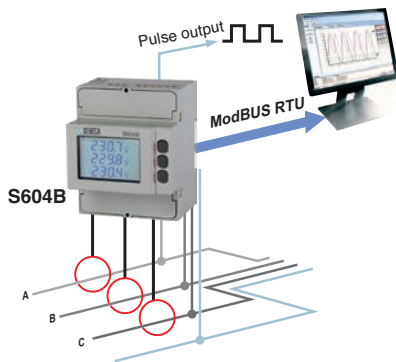

MAIN PRODUCT CODES

ORDER CODE	DESCRIPTION	ORDER CODE	DESCRIPTION
S604B-6-MOD	Three phase power meter, BASIC, for CT/5A, Modbus, 1MB	S711B6MOD	LCD 96x96 BASIC Power Meter, TA1/5A, Modbus, I/O
S604B-6-ETH	Three-phase power meter, BASIC, CT/5A, Ethernet, 1MB log	S711E6MOD	LCD 96x96 Energy PLUS Power Meter, TA1/5A, Modbus
S604B-80-MOD	Three phase power meter, BASIC, 80A, Modbus, 1MB log	S711E6MODAO	LCD 96x96 Energy PLUS Power Meter, TA1/5A, Modbus, AO
S604E-6-MOD	Power Meter, Energy PLUS x TA1/5A-RS485 Modbus, 8MB log. Harm.	S711E6ETH	LCD 96x96 Energy PLUS Power Meter, TA1/5A-Eth., 1DI 2DO
S604E-6-ETH	Power Meter Energy PLUS x TA1/5A-Ethernet,8MB log. Harmonics	S711EROGMOD30	LCD 96x96 Energy PLUS Kit, Modbus,N.3 RC150 (30cm)
S604E-80-ETH	Power Meter Energy PLUS 80A-Ethernet,8MB log. Harmonics	S711EROGMOD45	LCD 96x96 Energy PLUS Kit, Modbus,N.3 RC150 (45cm)
S604E-80-MOD	Power Meter, Energy PLUS 80A-RS485 Modbus,8MB log. harmonics	S711EROGMOD70	LCD 96x96 Energy PLUS Kit, Modbus,N.3 RC150 (70cm)
S604E-ROG-MOD-30	Kit Energy PLUS RS485 Modbus+3 Rog. RC150 L= 30cm int.9,5cm	S711EROGETH30	LCD 96x96 Energy PLUS Kit , Ethernet, N.3 RC150 (30cm)
S604E-ROG-MOD-45	Kit Energy PLUS RS485 +3 Rog. RC150 L= 45cm int.14cm	S711EROGETH45	LCD 96x96 Energy PLUS Kit , Ethernet, N.3 RC150 (45cm)
S604E-ROG-MOD-70	Kit Energy PLUS RS485 Modbus+3 Rog. RC150 L= 70cm int.22cm	S711EROGETH70	LCD 96x96 Energy PLUS Kit, Ethernet, N.3 RC150 (70cm)



Additional order codes and information

S203/R203/T203 Series power meters are devices A flexible coil without a magnetic core, in the shape of a toroid, is placed around the current conductor. The varying magnetic field produced by the current induces a voltage in the coil. The output voltage is proportional to the rate of change of the current and, after an integrating circuit, is proportional to the value of the current itself (as for a current transformer). The length of the coil varies from 25 to 300 cm for a rope diameter reduced to about 8 mm.



FULL SHIELDING



NON-INTRUSIVE MEASURING



OVERLOAD TOLERANCE



LIGHTWEIGHT AND HANGABLE



mA/kA MEASURING



HIGH LINEARITY



BIG CONDUCTORS



LIMITED ACCESS

INSTALLATION

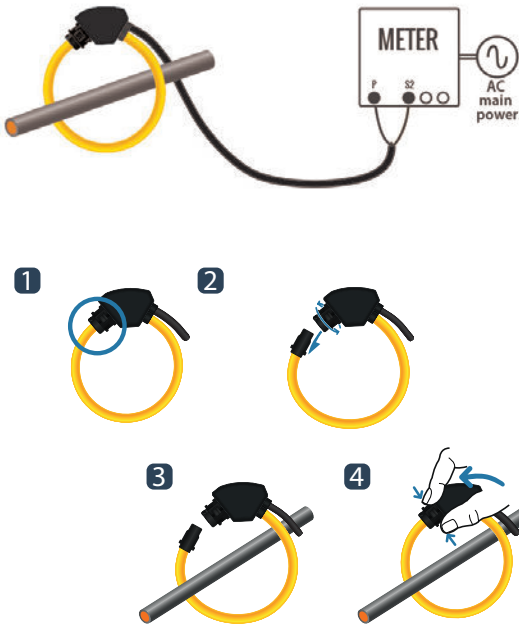

DIMENSION

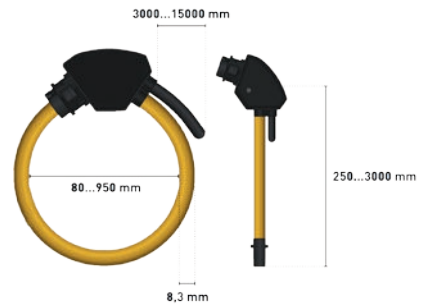

ACCURACY RANGE

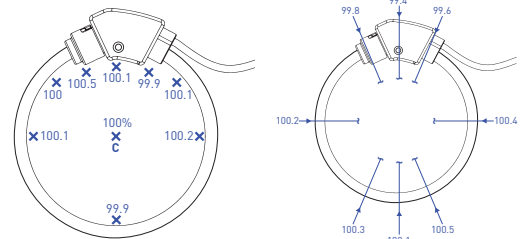

C (center based conductor)







Technical data, diagrams and drawings in this catalog are indicative only and not binding

MAIN PRODUCT CODES

ORDER CODE	DESCRIPTION	ORDER CODE	DESCRIPTION
RC150-025-100-3M	Rogowski Coil L=25cm Øint.8cm, 100mV/1KA-50Hz, cable L=3mt.	RC150-090-100-5M	Rogowski Coil L=90cm Øint.28cm, 100mV/1KA-50Hz, cable L=5mt.
RC150-025-100-5M	Rogowski Coil L=25cm Øint.8cm, 100mV/1KA-50Hz, cable L=5mt.	RC150-090-100-10	Rogowski Coil L=90cm Øint.28cm, 100mV/1KA-50Hz, cable L=10mt.
RC150-025-100-10	Rogowski Coil L=25cm Øint.8cm, 100mV/1KA-50Hz, cable L=10mt.	RC150-120-100-3M	Rogowski Coil L=120cm Øint.38cm, 100mV/1KA-50Hz, cable L=3mt.
RC150-035-100-3M	Rogowski Coil L=35cm Øint.11cm, 100mV/1KA-50Hz, cable L=3mt.	RC150-180-100-3M	Rogowski Coil L=180cm Øint.57cm, 100mV/1KA-50Hz, cable L=3mt.
RC150-040-100-3M	Rogowski Coil L=40cm Øint.12cm, 100mV/1KA-50Hz, cable L=3mt.	RC150-RIC-KIT30	Rogowski Coil Kit Spare Parts RC150 L= 30cm
RC150-040-100-5M	Rogowski Coil L=40cm Øint.11cm, 100mV/1KA-50Hz, cable L=5mt.	RC150-RIC-KIT45	Rogowski Coil Kit Spare Parts RC150 L= 45cm
RC150-040-100-10	Rogowski Coil L=40cm Øint.11cm, 100mV/1KA-50Hz, cable L=10mt.	RC150-RIC-KIT70	Rogowski Coil Kit Spare Parts RC150 L= 70cm
RC150-060-100-3M	Rogowski Coil L=60cm Øint.19cm, 100mV/1KA-50Hz, cable L=3mt.	RC190-030-333-3M	Rogowski sensor L-coil=30cm, Øint. 9cm, 333mV/1KA-50Hz, L-cable=3mt
RC150-060-100-5M	Rogowski Coil L=60cm Øint.19cm, 100mV/1KA-50Hz, cable L=5mt.	RC190-035-333-3M	Rogowski sensor L-coil=35cm, Øint. 9cm, 333mV/1KA-50Hz, L-cable=3mt
RC150-060-100-10	Rogowski Coil L=60cm Øint.19cm, 100mV/1KA-50Hz, cable L=10mt.	RC190-060-333-3M	Rogowski sensor L-coil=60cm, Øint. 9cm, 333mV/1KA-50Hz, L-cable=3mt
RC150-090-100-3M	Rogowski Coil L=90cm Øint.28cm, 100mV/1KA-50Hz, cable L=3mt.	RC190-090-333-3M	Rogowski sensor L-coil=90cm, Øint. 9cm, 333mV/1KA-50Hz, L-cable=3mt



S500 Series DIN format energy meters are used for energy measurement in industrial and civil environments. They are available with integrated, remote and MID certified communication. Totals and instantaneous powers are shown on the LCD display. For remote management are available the tools ENERGY MODBUS PACK for meters with ModBUS interface and ENERGY M-BUS PACK for meters with M-BUS interface as well as the Web Server for versions with Ethernet interface. S500 meters are manufactured in full compliance with EN 50470-1.

 M-BUS COMMUNICATION	 MID CERTIFICATION	 S0 OUTPUT / TARIFF INPUT	 MULTI-PROTOCOL SUPPORT
 CLASS B / CLASS 2 ACCURACY	 MULTIPLE TYPES OF CONNECTION	 SW / WEB SERVER / FRONT KEYS	 POWER CONSUMPTION MONITORING

TOP SELLING PRODUCTS

S501-40  40A single phase energy counter 2 wires 1 DIN	S501-40  80A single phase energy counter 2 wires 2 DIN	S504C  6A 3-phase energy counter 4 wires 4 DIN	S504C  6/80A three phase energy counter 3/4 wires 4 DIN
--	--	--	---

APPLICATION EXAMPLES

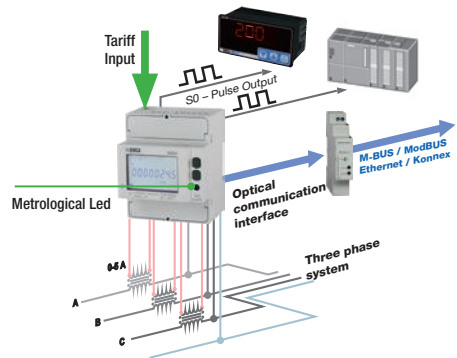
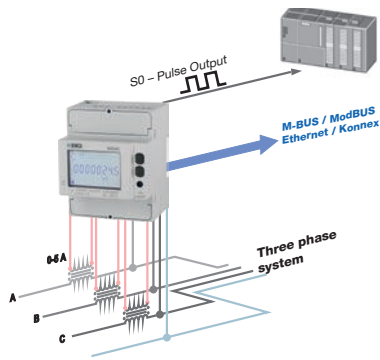

MAIN PRODUCT CODES

ORDER CODE	DESCRIPTION	ORDER CODE	DESCRIPTION
S500-MOD	RS485 Modbus RTU optical interface module	S504C-6-MOD-MID	6A 3-phase energy counter 4 wires 4 DIN, Modbus, MID
S501-40-0	40A single phase energy counter 2 wires 1 DIN	S504C-6-MBU-MID	6A 3-phase energy counter 4 wires 4 DIN, M-BUS, MID
S501-40-0-MID	40A single phase energy counter 2 wires 1 DIN, MID certified	S504C-6-ETH-MID	6A 3-phase energy counter 4 wires 4 DIN, Ethernet, MID
S501-40-MOD-MID	40A single phase energy counter 2 wires 1 DIN, RS485 Modbus MID	S504C-80-MOD-MID	80A 3-phase energy counter 4 wires 4 DIN, Modbus, MID
S501-40-MBU-MID	40A single phase energy counter 2 wires 1 DIN, RS485 M-Bus, MID	S504C-80-MBU-MID	80A 3-phase energy counter 4 wires 4 DIN, M-BUS, MID
S502-80-MOD	80A single phase energy counter 2 wires 2 DIN, RS485 Modbus	S504C-80-ETH-MID	80A 3-phase energy counter 4 wires 4 DIN, Ethernet, MID
S502-80-MBU	80A single phase energy counter 2 wires 2 DIN, M-BUS	S534-6-MID	6A three phase energy counter 3/4 wires 4 DIN, MID
S502-80-ETH	80A single phase energy counter 2 wires 2 DIN, Ethernet	S534-80-MID	80A three phase energy counter 3/4 wires 4 DIN, MID
S502-80-MID	80A Single Phase Energy Counter, 2 wires, 1 DIN, MID		



Additional order codes and information

The T201 Series AC/DC Current Transducers are devices capable of converting the measured current value (up to 600 A) into a standardized industrial 4...20 mA or 0...10 V signal. Most models of the T201 Series are UL certified and feature low power consumption, convenient DIP-switch-settable measurement scales and high accuracy guaranteed by the absence of thermal drift. 15 models are available with different measuring principles: rectified average, magnetic balance (with patented technology), Hall Effect or TRMS with bipolar input range.



UP TO 600A
INPUT



mA / V / PNP
OUTPUT



DIP SWITCH /
SOFTWARE SETTINGS



Modbus

MODBUS
INTERFACE



MULTIPLE MEASURING
PRINCIPLES



HIGH ACCURACY
CLASS



LOW POWER
CONSUMPTION



UL APPROVAL

TOP SELLING PRODUCTS

T201



AC Current Transducer 5-40 A
to 4..20 mA (Loop powered)

T201DC



PATENTED
TECHNOLOGY



DC Current Transducer 5-40 A
to 4..20 mA (Loop powered)

T201DCH



AC/DC Current Transducer 0-
50 A to 0..10V, auxiliary power

T201DCH100-LP



AC/DC C.T. (100 A), Hall
Effect, Loop Powered, 4-20 mA

APPLICATION EXAMPLES

DIRECT CURRENT TRANSDUCTION WITH 4-20 mA DIRECT OUTPUT

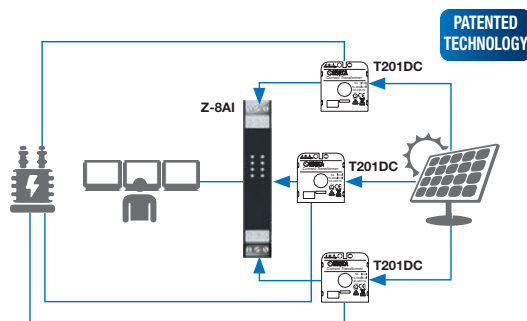

TRANSDUCTION OUTPUT CURRENT FROM ELECTRIC MOTOR IN 0-10V SIGNAL

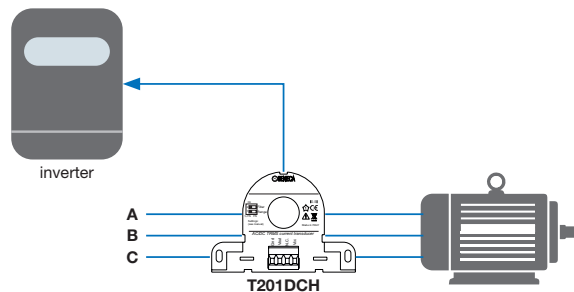

MAIN PRODUCT CODES

ORDER CODE	DESCRIPTION	ORDER CODE	DESCRIPTION
A-DIN-T201	DIN rail plastic clip for T201 Series	T201DCH300-LP	AC/DC C.T. (300 A), Hall Effect, Loop Powered, 4-20 mA
T201	AC Current Transf. 5-40 A to 4..20 mA (Loop powered);	T201DCH50-M	AC/DC C.T. (50 A), Hall Effect, Loop Powered, 0-10V, Modbus
T201DC DC	Current Transf. 5-40 A to 4..20 mA (Loop powered);	T201DCH100-M	AC/DC C.T. (100 A), Hall Effect, Loop Powered, 0-10V, Modbus
T201DC100	DC Current Transf 0-100A to 4..20 mA (Loop powered);	T201DCH300-M	AC/DC C.T. (300 A), Hall Effect, loop Powered, 0-10V, Modbus
T201DCH	AC/DC Current Transf. 0-50 A to 0..10V, Auxiliary Power	T201DCH50-MU	AC/DC C.T. (50 A), TRMS, 0..10V, Pnp alarm, Modbus, USB
T201DCH100	AC/DC CT with Hall effect INP 0-300Aac/dc OUT 0-10Vdc	T201DCH100-MU	AC/DC C.T. (100 A), TRMS 0..10V, Pnp alarm, Modbus, USB
T201DCH300	AC/DC CT with Hall effect INP 0-300Aac/dc OUT 0-10Vdc	T201DCH300-MU	AC/DC C.T. (300 A), TRMS 0..10V, Pnp alarm, Modbus, USB
T201DCH50-LP	AC/DC C.T. (50 A), Hall Effect, Loop Powered, 4-20 mA	T201DCH600-MU	AC/DC C.T. (600 A), TRMS 0..10V, Pnp alarm, Modbus, USB
T201DCH100-LP	AC/DC C.T. (100 A), Hall Effect, Loop Powered, 4-20 mA		



The converter modules for electrical measurements measure voltage and current values (alternating and / or continuous) converting them into a signal normalized in current or in voltage at the output terminals, proportional to the input value. The scaling parameters of the inputs and outputs are selectable via software or DIP switches. The modules ensure a high accuracy class (0.1 to 0.5%) and a very high multiple ways galvanic isolation, up to 4,000 Vac. In addition to power or error signalling, ModBUS modules equipped offer RS485 LED indication on the front panel.



WIDE MEASURING RANGE



EASY CONNECTIONS



FLEXIBLE SETTINGS



FULL POWER SUPPLY OPTIONS



COMPACT SIZE



INTERNATIONAL APPROVALS



HIGH LEVEL ISOLATION



FIELDBUS INTERFACE

TOP SELLING PRODUCTS



Z201

Alternate current converter
10..40 Vdc; 19..28 Vac



Z202-LP

Alternate voltage converter
loop powered



Z203-2

Single Phase
Power Meter



S201RC-LP

Loop-powered converter for
Rogowski sensors

APPLICATION EXAMPLES

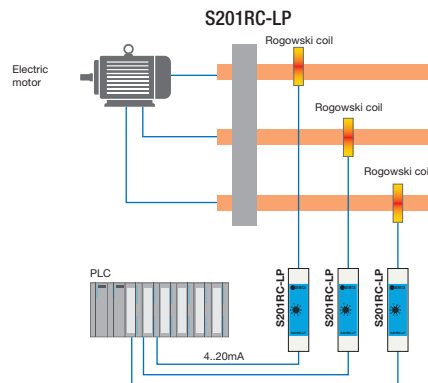
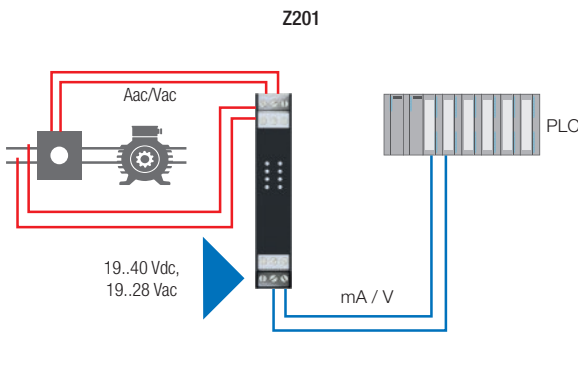

MAIN PRODUCT CODES

ORDER CODE	DESCRIPTION
S201RC-LP	Loop powered current converter for Rogowski Coils
Z201 AC	Current to DC I/V Conv.19..40Vdc - 19..28 Vac
Z201-H	AC Current to DC I/V Isolator/Conv.85..265Vac/dc
Z202	AC Voltage(500 A);to DC I/V Conv.19..40 Vdc-19..28 Vac
Z202-H	AC Voltage(500 A);to DC I/V Isolator/Conv.85..265Vac/dc
Z202-LP	500 VAC- 540 VDC to 4..20 mA Converter, loop pow.
Z203-2	AC single phase advanced network analyzer, Micro USB port
Z204-1	AC/DC high voltage converter, analog out, ModBUS RTU



Additional order codes and information

For Energy Management applications SENECA offers different types of controllers, Z-TWS4-E, Z-PASS2-SE, S6001-RTU-E with the support of IEC 60870-101/104 and IEC 61850 communication protocols. These units can be used as redundant controllers for plant automation, energy management, management of renewable energy systems (biomass, photovoltaic, wind, etc.), development of smart grids, etc.. They are also configurable as web servers and TCP-IP nodes and can be integrated with SCADA, EMS and Web supervision platforms.



ENERGY MANAGEMENT APPLICATIONS



SOFT PLC IEC 61131-3



VPN SUPPORT

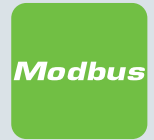

MODBUS RTU / TCP/IP SUPPORT



IEC 60870-101-104 SLAVE



IEC 61850 CLIENT / SERVER



SUBSTATION CONTROLS



SCADA INTEGRATION

TOP SELLING PRODUCTS

Z-TWS4-E



Energy controller, built-in I/O, Straton

Z-PASS2-S-E



Energy Remote Controller 4G, VPN, GPS, built-in I/O, Straton

S6001-RTU-E



Energy Remote Control Unit, built-in I/O, 4G, Straton

R-PASS-W-4-E



Multifunction Controller / Gateway, WiFi, 4 LAN ports, Straton, energy protocols

APPLICATION EXAMPLES

REMOTE CONTROL OF ELECTRICAL SUBSTATIONS

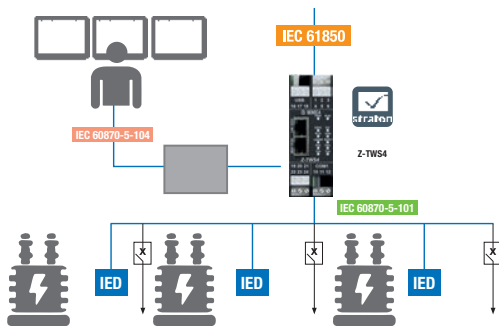

ENERGY MANAGEMENT SMART GATEWAY

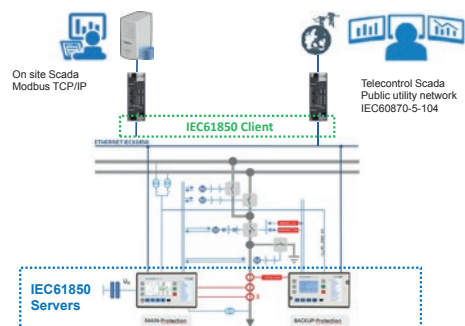

MAIN PRODUCT CODES

ORDER CODE	DESCRIPTION	ORDER CODE	DESCRIPTION
EASY CEI	MYALARM2 CEI software manager	Z-PASS2SE4GEUUPG	3G Modem upgrade and replacement → 4GLTE/EMEA c/o laboratory (Z-PASS2-S-E)
MY2CEI-016-0-220	MY2-CEI, built-in antenna, 220 Vac - 12 Vdc	Z-PASS2SE4GWWUPG	Upgrade and replacement of 3G Modem → 4GLTE/WW c/o laboratory (Z-PASS2-S-E)
MY2CEI-016-0-24	MY2-CEI, built-in antenna, 24 Vac - 12 Vdc	Z-TWS4-E-IO	IEC 61131 Energy controller energy, built-in I/O, Straton OEM
MY2CEI-016-A-220	MY2-CEI, A-GSM, 220 Vac - 12 Vdc	R-PASS-0-2-E	Multifunction Controller / Gateway, 2 LAN ports, Straton, energy protocols
MY2CEI-016-A-24	MY2-CEI, A-GSM, 24 Vac - 12 Vdc	R-PASS-0-4-E	Multifunction Controller / Gateway, 4 LAN ports, Straton, energy protocols
S6001-RTU-E	Remote Control Unit with built-in I/O, 3G+ modem, energy	R-PASS-W-2-E	Multifunction Controller / Gateway, WiFi, 2 LAN ports, Straton, energy protocols
S6001-RTU-E-4GWW	Remote Control Unit with built-in I/O, 4G WW LTE, Energy protocols	R-PASS-W-4-E	Multifunction Controller / Gateway, WiFi, 4 LAN ports, Straton, energy protocols
Z-PASS2-S-E-4GWW	Remote Controller Energy 4G worldwide, VPN, serial device server, GPS and I/O integrated		



4

MEASUREMENT AND CONTROL PANEL INSTRUMENTATION



Z Line modules are reliable signal conditioners that are geared toward ease of use and installation. Most models features are characterized by 3-way galvanic isolation equal to 1.5 kVac, reduced overall dimensions (standard width 17.5 mm), installation on DIN 42677, extended temperature range, high accuracy, possibility to power the sensors connected to them. Z Line is the ideal solution for analog, electrical, from temperature sensors, load cells, serial, digital, impulsive signal conditioning.



UNIVERSAL POWER SUPPLY

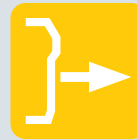

POWER TRANSDUCER



LOW POWER CONSUMPTION

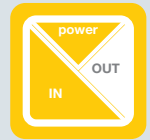

MULTIWAYS ISOLATION @1,5 KVAC



HIGH LEVEL ACCURACY



UNIVERSAL I/O STANDARD SIGNALS



INDUSTRIAL RELIABILITY



INTERNATIONAL CERTIFICATIONS

TOP SELLING PRODUCTS

Z170REG-1

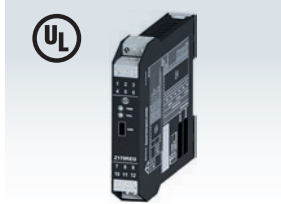

DC duplicator / isolator prog. Via MicroUSB/App

Z109S



DC current isolator

Z109REG2-1



High performance universal converter, prog. via MicroUSB/App

Z111



Frequency to DC isolator / converter

APPLICATION EXAMPLES

ISOLATION AND CONVERSION WITH ALARM THRESHOLD ON ANALOG INPUT AND OUTPUT RETRANSMISSION ON INDICATOR

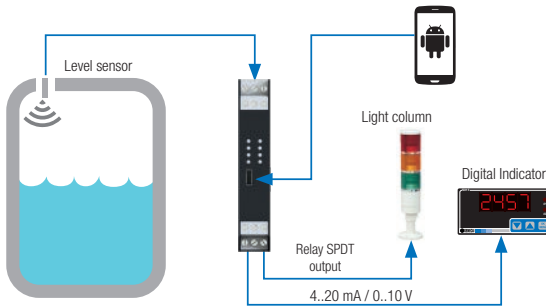

ISOLATION AND ANALOG CONVERSION WITH FUNCTION OF MULTIPLEXER ON RETRANSMITTED OUTPUT

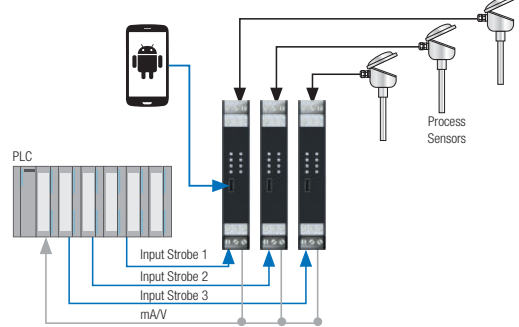









MAIN PRODUCT CODES









ORDER CODE	DESCRIPTION	ORDER CODE	DESCRIPTION
Z102	Potentiometer to DC Current/Voltage isolator/converter	Z109UI2-1	DC current / voltage converter, prog. via Micro USB/App
Z104	DC V/I to frequency isolator / converter	Z110D	DC current isolator (self-powered) double channel
Z109PT2-1	RTD to DC V/I isolator converter, prog. via MicroUSB/App	Z110S	DC current isolator (self-powered) single channel
Z109REG	Analog universal converter with galvanic isolation	Z111	Frequency to DC isolator / converter
Z109REG-BP	Universal converter with bipolar mA / V output	Z112A	On/Off sensors digital amplifier, single channel
Z109REG2-1	High perf. universal converter, prog. via MicroUSB/App	Z112D	On/Off sensors amplifier, double channel
Z109REG2-H	High performance universal converter, 85-265 Vac/dc	Z113-1	Double threshold with universal analog input
	DC current isolator for 0/4..20mA loops		DC current / voltage single alarm trip module
	DC wide range current isolator for 0/4..20mA loops		DC duplicator / isolator prog. Via MicroUSB/App
	TC to DC isolator / converter, prog. via MicroUSB/App		DC Current/Voltage Adder/subtractor



SENECA K Line converter modules are characterized by isolation 1.5 kVac 3-way digital technology, accuracy class 0.1%, power supply range from 19.2 to 30 Vdc, compact size (102.5x93.1x6.2 mm), low power consumption, Mtbf over 500.000 hours. The configuration of the signals is immediate by DIP switch or software. The power supply technique is standard (on the spring clamp) or with distributed system, based on expandable connector (K-BUS) that can be snapped onto the 35 mm DIN rails according to EN 60715.

 >500.000 h HIGH RELIABILITY	 -20...+65°C WIDE RANGE OPERATING TEMPERATURE	 <25mA LOW POWER CONSUMPTION	 MULTIWAYS ISOLATION @1,5 KVAC
 6,2 mm COMPACT DIMENSION	 0,1% HIGH ACCURACY CLASS	 FLEXIBLE SETTINGS VIA DIP SWITCHES	 EASY SETUP PROGRAMMING VIA PC

TOP SELLING PRODUCTS

K109S   DC Current/Voltage to DC Current/Voltage Converter	K109UI   DC Current/Volt. to DC Current/Volt. Isolator/Converter	K109PT   PT100 to DC Current/Voltage Isolator/Converter	K121   Universal isolator converter loop powered
--	--	---	---

APPLICATION EXAMPLES

CONVERSION AND TRANSMISSION TO THE PLC OF A UNIVERSAL ANALOGUE SIGNAL

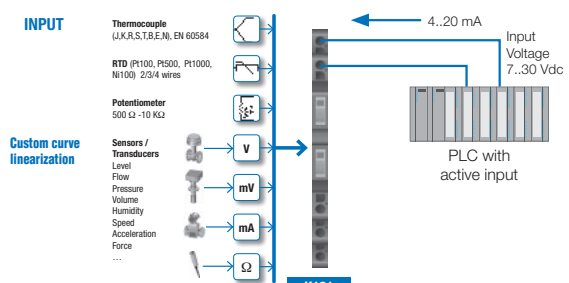

INPUT: Thermocouple (J,K,R,S,T,B,E,N, EN 60584), RTD (Pt100, Pt500, Pt1000, Ni100, 2/3/4 wires), Potentiometer (500 Ω - 10 KΩ), Sensors / Transducers (Level, Flow, Pressure, Volume, Humidity, Speed, Acceleration, Force, ...)

Output: 4..20 mA, Input Voltage 7..30 Vdc, PLC with active input

MONITORING OF THE BATTERY CHARGE VOLTAGE

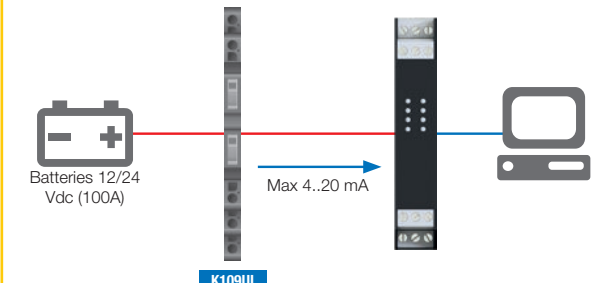

Batteries 12/24 Vdc (100A), Max 4..20 mA

MAIN PRODUCT CODES

ORDER CODE	DESCRIPTION	ORDER CODE	DESCRIPTION
K107A	RS485 <-> RS485 serial amplifier/Isolator	K111-C	Isolated dual output frequency trip amplifier - config.
K107B	RS232 <-> RS485 serial converter/Isolator	K111D	2-CH frequency divider-repeater with 2 isolated outputs
K107USB	USB <-> RS485 converter / Isolator	K111D-C	2-CH frequency divider-repeater with 2 isolated outputs, config.
K109LV	mV to DC Current/Voltage Isolator/Converter	K112	Universal digital Coupler/Isolator
K109PT	PT100 to DC Current/Voltage Isolator/Converter	K120RTD	Pt100, Ni100 loop powered converter
K109PT1000	PT1000 to DC Current/Voltage Isolator/Converter	K120RTD-C	Pt100, Ni100 loop powered converter, config.
K109PT-HPC	PT100 to DC Current/Volt. Isol/Conv. High prec.	K121	Universal isolator converter loop powered
K109S	DC Current/Voltage to DC Current/Voltage Converter	K121-C	Universal isolator converter loop powered - config.
K109TC	TC to DC Current/Volt. Isolator/Converter-with alarm	K-BUS	Expandable power supply connector
K109UI	DC Current/Volt. to DC Current/Volt. Isolator/Converter	K-SUPPLY	Redundant power supply module for K-Line modules
K111	Isolated dual output frequency trip amplifier		



Additional order codes and information

The high-accuracy head-mounted temperature transmitters, T120 and T121, are designed for universal use in machines, plants, installations and the process industry. They convert input signals and transmit them back into a normalized current signal current through a 4-20 milliAmpere loop. Input signals can come from 2-, 3-, 4-wire RTD sensors such as Pt100 (EN 60751) and Ni100 (DIN 43760). T121 model also acquires Cu50, Cu100, Ni121 and Ni1000 RTDs and signals from thermocouples type J, K, R, S, T, B, E, N, L (EN 60584), voltage and resistance.

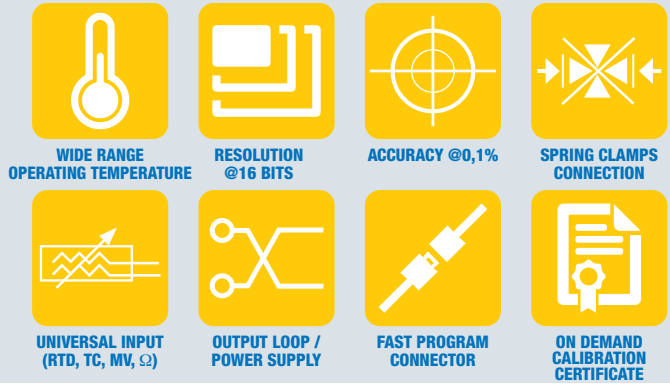

TOP SELLING PRODUCTS

T120



Pt100/Ni100 to 4-20mA out (non-isolated)

T121



Universal Input to 4-20mA out (Isolated)

PT100-100-MA



Pt100 std length 100 mm, 4-20 mA output

PT100-50



Pt100 std length 50 mm

APPLICATION EXAMPLES

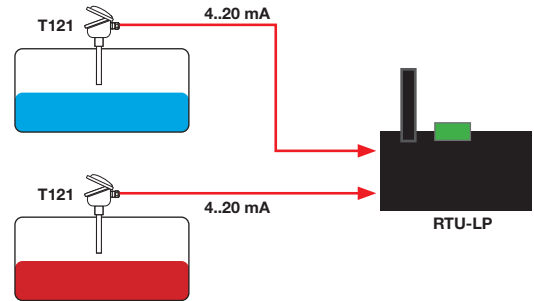
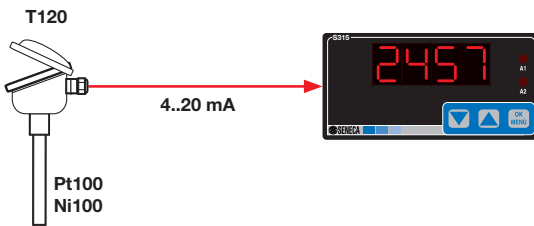

MAIN PRODUCT CODES

ORDER CODE	DESCRIPTION	ORDER CODE	DESCRIPTION
PT100-100	Pt100 std length 100 mm	PT100-50	Pt100 std length 50 mm
PT100-100-MA	Pt100 std length 100 mm, 4-20 mA output	PT100-50-MA	Pt100 std length 50 mm, 4-20 mA output
PT100-150	Pt100 std length 150 mm	PT100-A	Atmosphere PT100
PT100-150-MA	Pt100 std length 150 mm, 4-20 mA output	PT100-A-MA	Atmosphere Pt100, 4-20 mA output
PT100-200	Pt100 std length 200 mm	PT100-SOLAR	Single element 3 wires Pt100 for photovoltaic modules
PT100-200-MA	Pt100 std length 200 mm, 4-20 mA output	PT100-SOLAR-MA	Single element Pt100 for PV modules, out 4-20 mA
PT100-250	Pt100 std length 250 mm	T120	Pt100/Ni100 to 4-20mA out (non-Isolated)
PT100-250-MA	Pt100 std length 250 mm, 4-20 mA output	T120-C	Pt100/Ni100 to 4-20mA out (non-Isolated), configured
PT100-300	Pt100 std length 300 mm	T121	Universal Input to 4-20mA out (Isolated)
PT100-300-MA	Pt100 std length 300 mm, 4-20 mA output	T121-C	Universal Input to 4-20mA out (Isolated), configured



SENECA S400 surge protectors are designed to protect electrical systems and equipment against transient and impulsive overvoltages caused by atmospheric phenomena and electrical switching. The S400 range includes: type 2 and 3 surge arresters for industrial power systems; protection for control and systems used in binary and analog circuits, such as pulse, 0..10 Vdc signals and 0/4..20 mA current loops; surge protections for computer and communication networks (token ring, ISDN, DS1, Ethernet, Power over Ethernet, RS232/422/485 etc.)

 MULTIPLE FIELD APPLICATIONS	 DIFFERENT DESIGNS	 HIGH SECURITY INTERRUPTION LEVEL	 FRONT STATUS SIGNALLING
 COST SAVING	 REMOTE SIGNALLING	 EASY CONNECTION	 VOLTAGE SUPPRESSION

TOP SELLING PRODUCTS

<p>S400CL-1</p>  <p>Analog and Digital Signals Surge Protection with knife disconnecter</p>	<p>S400HV-2</p>  <p>Type 2 230 Vac Surge Protection at 3 conductors (L, N, PE)</p>	<p>K400CL</p>  <p>Analog and Digital Signals Surge Protection, 6,2 slim</p>	<p>S400NET-1</p>  <p>Ethernet, serial, fieldbus networks Surge Protections, 5 wires</p>
--	--	---	--

APPLICATION EXAMPLES

PROTECTION AND ISOLATION FOR POWER SUPPLY TYPE 2 AND 3

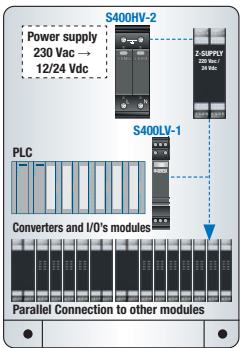

Automation Panels, Marshalling Panels, Panel of PLC & DCS command and machines control, Distribution Panels, Electrical Panels Power Center, MCC Panels

PROTECTION OF A PULSE MEASUREMENT DEVICE (REED, NAMUR, PNP, NPN, HALL EFFECT, ETC)

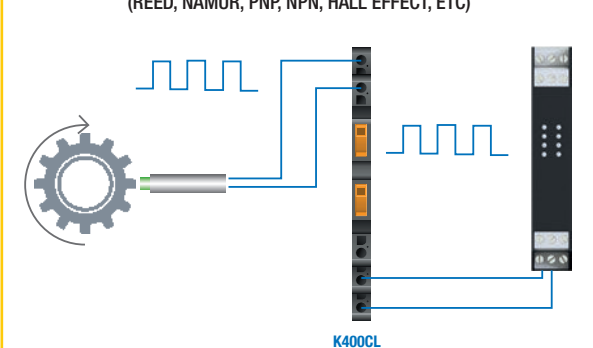

K400CL

MAIN PRODUCT CODES

ORDER CODE	DESCRIPTION	ORDER CODE	DESCRIPTION
K400CL	Analog and Digital Signals Surge Protection, 6,2 slim	S400CL-1	Analog and Digital Signals SPD with knife disconnecter
K400CL-10	K400CL-1 10 pieces kit	S400CL-1-15	S400CL-1 10 pieces kit
S400HV-2	Type 2 230 Vac SPD at 3 conductors (L, N, PE)	S400CL-1-P5	S400CL-1 closing side (5 pieces)
S400HV-2-RIC-SL	S400HV2 plug spare 1L-NPE, no FM contact	S400NET-1	Ethernet, serial, fieldbus networks SPD, 5 wires
S400HV-2-RIC-SN	S400HV2 plug spare N/PE	S400NET1-RIC	S400NET-1 plug spare
S400LV-1	Type 3 24 Vac/dc SPD with FM contact at 3 conductors	S400ETH-DSK	Ethernet Networks SPD, Class.D/Cat.5 (100 Mbps)/5e
S400LV-1-RIC-SL	S400LV-1 plug spare, with contact FM		



Additional order codes and information

S-Line is a high performance compact/modular indicators / totalizers family. This series offers display choice with 4, 6, 8, 4+7 digits in multiple visualization mode (real-time, integrated, totalized measured values). S-Line indicators support universal input (analog, digital, by sensor) and re-transmitted output mA, V standard.

Concerning power supply they ensure an extended range of options: 80-265 Vac; 10-40 Vdc / 19-28 Vac; loop powered. Accuracy class reach 0,1% with 14-16 bit A/D conversion.



UNIVERSAL
INPUT



RE-TRANSMITTED
OUTPUT

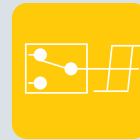

ALARM (RELAY)
ENABLING

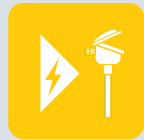

POWER
TRANSDUCERS



TOTALIZER



SIGNAL
GENERATOR

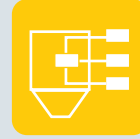

BATCH
COUNTER



MULTIWAYS
ISOLATION @1,5 KVAC

TOP SELLING PRODUCTS

S311AK



4-digit display indicator with mA/V analog input

S312A



4-digit display indicator with universal analog input, nr.4 relay output, Modbus interface

S315



4-digit display loop powered indicator, 4-20 mA input

S311A-4



4-digit display indicator - totalizer with universal analog input

APPLICATION EXAMPLES

ANALOG SIGNAL VISUALIZATION AND PLC RE-TRANSMISSION

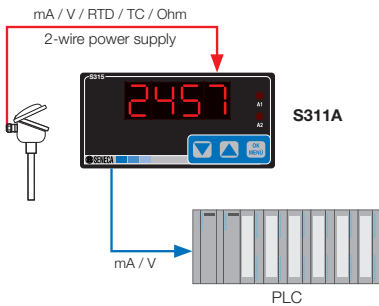

CONSUMPTION METERING

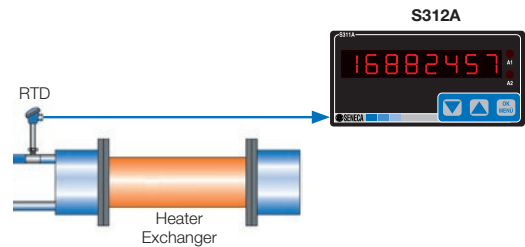

MAIN PRODUCT CODES

ORDER CODE	DESCRIPTION	ORDER CODE	DESCRIPTION
S311A-11-H	11 digit indicator, universal analog input, 80-265 Vac	S311A-6-H-0	6 digit indicator, universal AI, 80-265 Vac, opt. board
S311A-11-H-0	11 digit indicator, univ. AI, 80-265 Vac, opt. board	S311A-6-L	6 digit indicator, universal AI, 10-40 Vdc/19-28 Vac
S311A-11-L	11 digit analog input indicator, 10-40 Vdc/19-28 Vac	S311A-6-L-0	6 digit indicator, 10-40 Vdc / 19-28 Vac, opt. board
S311A-11-L-0	11-digit input indicator, 10-40Vdc/19-28Vac, opt. board	S311A-8-H	8-digit indicator, universal analog input, 80-265 Vac
S311A-4-H	4 digit indicator, universal analog input, 80-265 Vac	S311A-8-H-0	8-digit indicator, universal AI, 80-265 Vac, opt. board
S311A-4-H-0	4 digit indicator, 80-265 Vac, opt. board	S311A-8-L	8-digit indicator, universal AI 0-40 Vdc/19-28 Vac
S311A-4-L	4 digit indicator, universal AI, 10-40Vdc/19-28 Vac	S311A-8-L-0	8-digit indicator, 10-40 Vdc/19-28 Vac, opt. board
S311A-4-L-0	4-digit indicator, 10-40 Vdc/19-28 Vac, opt. Board	S311D-8-L-0	8-digit dig. input ind., 10-40Vdc/19-28 Vac, opt. board
S311A-6-H	6 digit indicator, universal analog input, 80-265 Vac	S311G-4-L	4-digit universal input indicator/signal generator, 10-40 Vdc, 19-28 Vac



SENECA S20N1 and S21N1 batch controllers are cost-effective, simple and safe solutions for process automation. Equipped with polycarbonate front membrane from 72x144 mm with 2 Numeric 5-digit LED high brightness displays, 7 status indicators LED and 6 programming buttons, S20N1 and S21N1 get digital signals from free contact, Reed, NPN, NAMUR, Hall effect and photoelectric sensors. The units are designed to control the measuring probes and activate valves or motors so to manage metering, batch& blending, filling and regeneration processes for fluids, in automatic, time-based and accurated way.



BATCH MODES

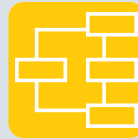

FLEXIBLE RECIPES



PULSE INPUT



SPDT RELAY



RS485 ModBUS



IMPACT PRINTER



EX / IP65 VERSIONS



SELF-POWERED INPUT ADAPTER BOARD

TOP SELLING PRODUCTS

S20N1

Basic batch controller

S21N1

Advanced batch controller

S20N1IP65

Basic batch controller in IP65 case

S20N1EX

Basic batch controller in Eexd case

APPLICATION EXAMPLES

BATCH PROCESS CONTROL WITH PLC

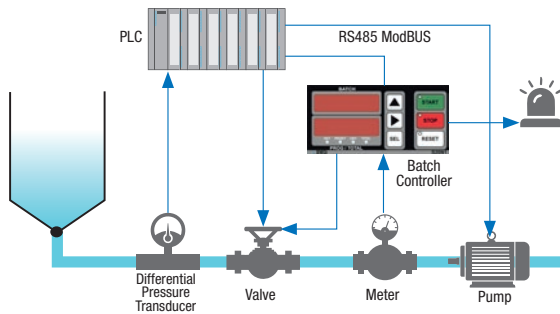

MULTIPLE RECIPES FROM REMOTE COMMAND (PLC) OR LOCAL (AUTO-MAN STATION)

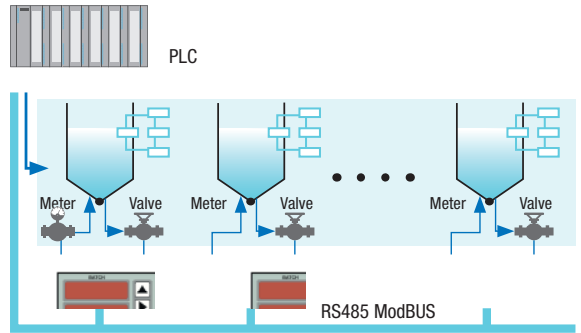

MAIN PRODUCT CODES

CODE	DESCRIPTION	PRODUCT CODE	DESCRIPTION
F	Impact printer, 9-40 Vdc, for S20N1 e S21N1	11P65-23-ST	Batch controller in IP65 case, 24 Vac/dc
S	Self-powered input adapter board for S20N1, S21N1, S20N1IP65	1-KIT-1-ST	S20N1 / S21N1 remote board, 115 / 230 Vac
S	Self-powered input adapter board for S20N1, S21N1, S20N1IP65	S20N1-KIT-23-ST	S20N1 / S21N1 remote board, 24 Vac/dc
S20ADP-IP65	IP65 self-powered input adapter board	S21N1-1-ST	Batch controller with advanced functions, 115 / 230 Vac
S20N1-1-ST	Batch controller, 115 / 230 Vac	S21N1-23-ST	Batch controller with advanced functions, 24 Vac / dc
S20N1-23-ST	Batch controller, 24 Vac / dc	S21N1EX-1-ST	Batch controller EExd, advanced functions, 115/230 Vac
S20N1EX-1-ST	Batch controller in EExd case, 115 / 230 Vac	S21N1EX-23-ST	Batch controller Eexd, advanced functions, 24 Vac/dc
S20N1EX-23-ST	Batch controller in EExd case, 24 Vac/dc	S21N1IP65-1-ST	Batch controller IP65, advanced functions, 115/230 Vac
S20N1IP65-1-ST	Batch controller in IP65 case, 115 / 230 Vac	S21N1IP65-23-ST	Batch controller IP65, advanced functions, 24 Vac/dc



Additional order codes and information

MSC

MSC (Multifunction Smart Calibrator) is a flexible device for maintenance and testing of sensors and process meters. With best-in-class accuracy at 0.05% for each type of input / output, MSC offers measurement, generation and simulation of analog and digital signals, temperature sensors and load cells.



SIGNAL MEASUREMENT



SIGNAL GENERATOR SIMULATOR



RAMP FUNCTION



DATALOGGER

Test-4

Test-4 is a reliable support for calibration sessions, laboratory tests and of analog measurements simulation controlled by industrial devices (controllers, DAQ systems etc.). With a total accuracy better than 0.1%, and a whole resolution of 1 μA / 1 mV, Test-4 achieve accurate calibration results.



RAMP GENERATOR



INPUT / OUTPUT mA / V



LOW CONSUMPTION DISPLAY



MULTIFUNCTION ENCODER BUTTON

PACKAGE CONTENT**MSC**

- 1) Transport case
- 2) MSC calibrator (battery included)
- 3) Power plug
- 4) USB charging / data cable
- 5) User manuals
- 6) Seneca calibration report
- 7) Test cable, 4 mm plug

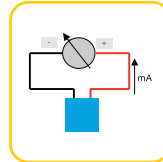
PACKAGE CONTENT**TEST-4****APPLICATION / USE****CONNECTIONS****SIGNAL GENERATION**

Active Current

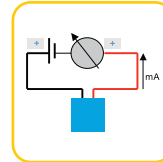

Passive Current

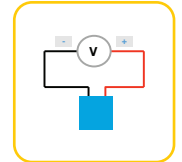

Voltage

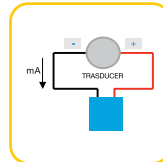
SIGNAL MEASUREMENT

Active Current

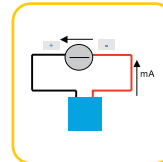

Passive Current

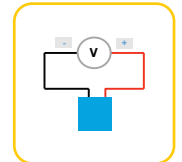

Voltage

MAIN PRODUCT CODES

ORDER CODE	DESCRIPTION
MSC	Multifunction bluetooth calibrator
MSC-POWER	MSC Power Supply
MSC-T	MSC Calibration Report
MSC TOOL	MSC data export and firmware update

MAIN PRODUCT CODES

ORDER CODE	DESCRIPTION
TEST-4-C	TEST-4 transport and protection case
TEST-4-PWR	Test-4 power supply
TEST-4-PK	Precision kit for Test-4
TEST-4-R	Precision test leads for Test-4
TEST-4-T	ISO 9001 calibration certificate for Test-4
TEST-4	V/I handheld multimeter with ramps simulation
USB-ISO	USB galvanic isolator





Visit our website
and you will discover a world
of efficient product
and solutions for automation
www.seneca.it



CONTACT AND INFORMATION

Address

Headquarter: Via Austria 26 - 35127 Padova (I)
Tel. +39 049 8705 359 (408)
Fax +39 049 8706287

Web

Website: www.seneca.it
Documentation: www.seneca.it/cataloghi-flyers/
Tech Support: www.seneca.it/supporto-e-assistenza/
E-commerce: www.seneca.it/vetrina/

E-mail

General information: info@seneca.it
Sales Office: sales@seneca.it
Quality Assurance: qualita@seneca.it
Product technical support: support@seneca.it

Follow us on social network

