

2024



Industrial identification

Marking systems and marking materials,
software, and services

Marking system

Simply easy!

We simplify your daily work – that's the promise backing every industrial marking and identification solution from Phoenix Contact. The Marking system portfolio provides a comprehensive system solution for simple and efficient marking processes – consisting of intuitive marking software, powerful marking systems, versatile identification solutions, and comprehensive services.



1 Marking systems

Marking system offers three identification technologies for different durability requirements as well as devices for stationary and mobile use. Whether manual or automated identification, all systems provide intuitive support when creating markings.

> More information starting on page 4

2 Marking materials

Marking system covers every application with a variety of marking materials. When it comes to marking terminals, wires and cables, equipment, and plants, versions are available to meet every requirement.

> More information starting on page 84

4

Service

Expert support for any pre-sales, sales, or after-sales issues. Whether by email, phone, or directly on site – we are here to assist you at any time with our individual services.

➤ More information starting on page 180



Contents

Marking systems	4
Direct laser marking system	10
UV inkjet printing systems	16
Thermal transfer printers	22
Mobile printers	48
Marking plotter and engraving unit	68
Automated industrial identification	76
Marking material	84
Terminal identification	90
Wire and cable identification	104
Equipment identification	124
Plant identification	146
Marking software	170
Marking system software	172
Marking system app	176
Services	180

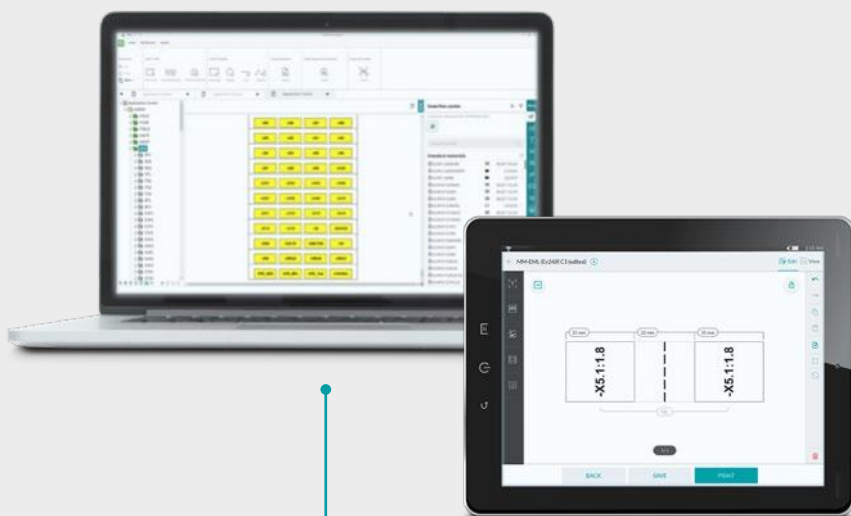

3

Marking software

User-friendly marking software for all target groups with application-specific functions – from fully comprehensive desktop software to identification directly on site with the Marking system app.

➤ More information starting on page 170

Marking systems

1

There are numerous and varied requirements for markings that are used in industrial applications. Whatever your marking requirements, we have the right system for you. Whether manual or automated identification, all systems provide intuitive support when creating markings. Choose from resilient direct laser marking, versatile UV inkjet printing, or flexible thermal transfer printing. For identification directly in the application environment, we recommend our mobile printers.



Laser marker

Create resilient markings for particularly exacting demands with the TOPMARK NEO.

> More information starting on page 10



UV inkjet printers

The BLUEMARK ID printing systems are versatile. They mark in monochrome or in CMYK multicolor printing.

> More information starting on page 16



Thermal transfer printers

Flexible identification with the THERMOMARK CARD 2.0, THERMOMARK ROLL 2.0, THERMOMARK E.300 (D)/E.600 (D), and THERMOMARK E.300 DOUBLE thermal transfer printers.

> More information starting on page 22



Mobile thermal transfer printers

With the THERMOMARK PRIME 2.0 and the THERMOMARK GO SERIES devices, you can create your markings directly in the application environment.

> More information starting on page 48

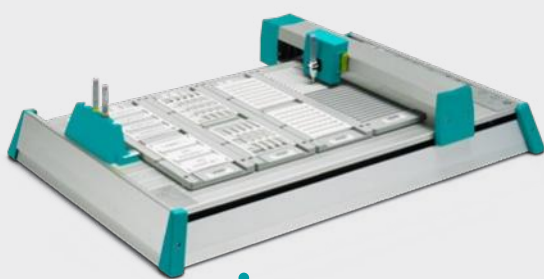

Plotters and engraving systems

Create professional markings with the PLOTMARK and ENGRAVING UNIT.

> More information starting on page 68



























Automated identification

Print and apply in just a single, efficient process step with the THERMOMARK E SERIES.

> More information starting on page 76

Selection guide for marking systems

	Identification technology	Marking material	Marking system
Automated identification			
	Thermal transfer printing	Material off the roll	Applicators: THERMOMARK ... E.WIRE, E.WRAP, E.SLEEVE
			THERMOMARK E.VARIO applicator
			THERMOMARK E SERIES: combination of THERMOMARK E.300 (D) / E.600 (D) standard thermal transfer printer and one of four applicators for efficient terminal identification and wire and cable identification
Manual identification – stationary			
	Thermal transfer printing	Material off the roll	THERMOMARK E.300 (D) THERMOMARK E.600 (D)
	Thermal transfer printing	Material off the roll	THERMOMARK E.300 DOUBLE
	Thermal transfer printing	Material off the roll	THERMOMARK ROLL 2.0
	Thermal transfer printing	Card material	THERMOMARK CARD 2.0
	UV inkjet printing	Card material	BLUEMARK ID / BLUEMARK ID COLOR
	Direct laser marking	Card material	TOPMARK NEO
	Plotter	Card material	PLOTMARK
	Engraving	Card material	ENGRAVING UNIT
Manual identification – mobile			
	Thermal transfer printing	Card material	THERMOMARK PRIME 2.0
	Thermal transfer printing	Cartridge material	THERMOMARK GO
	Thermal transfer printing	Cartridge material	THERMOMARK GO.K

Main identification areas	Print volumes	Number of compatible marking materials
	Large	44
		4
	Large	753
	Large	667
	Medium	711
	Small	577
	Large	1047
	Medium/large	466
	Small	594
	Small	72
	Small	577
	Small	108
	Small	83



Marking systems

Marking systems for manual industrial identification

Industrial markings must enable clear identification. Therefore, depending on the application and the associated ambient conditions, there are numerous and different requirements. We offer a wide selection of marking systems for stationary and mobile

manual identification. Make your workflows even more effective. Decide which system best suits your requirements.

Marking systems for stationary identification

Stationary marking systems are particularly suitable for processing large quantities of orders. Our extensive identification portfolio offers a solution for every requirement. Choose from three different technologies: flexible thermal

transfer printing, versatile UV inkjet printing, and resilient direct laser marking. Find the system that best suits your application.

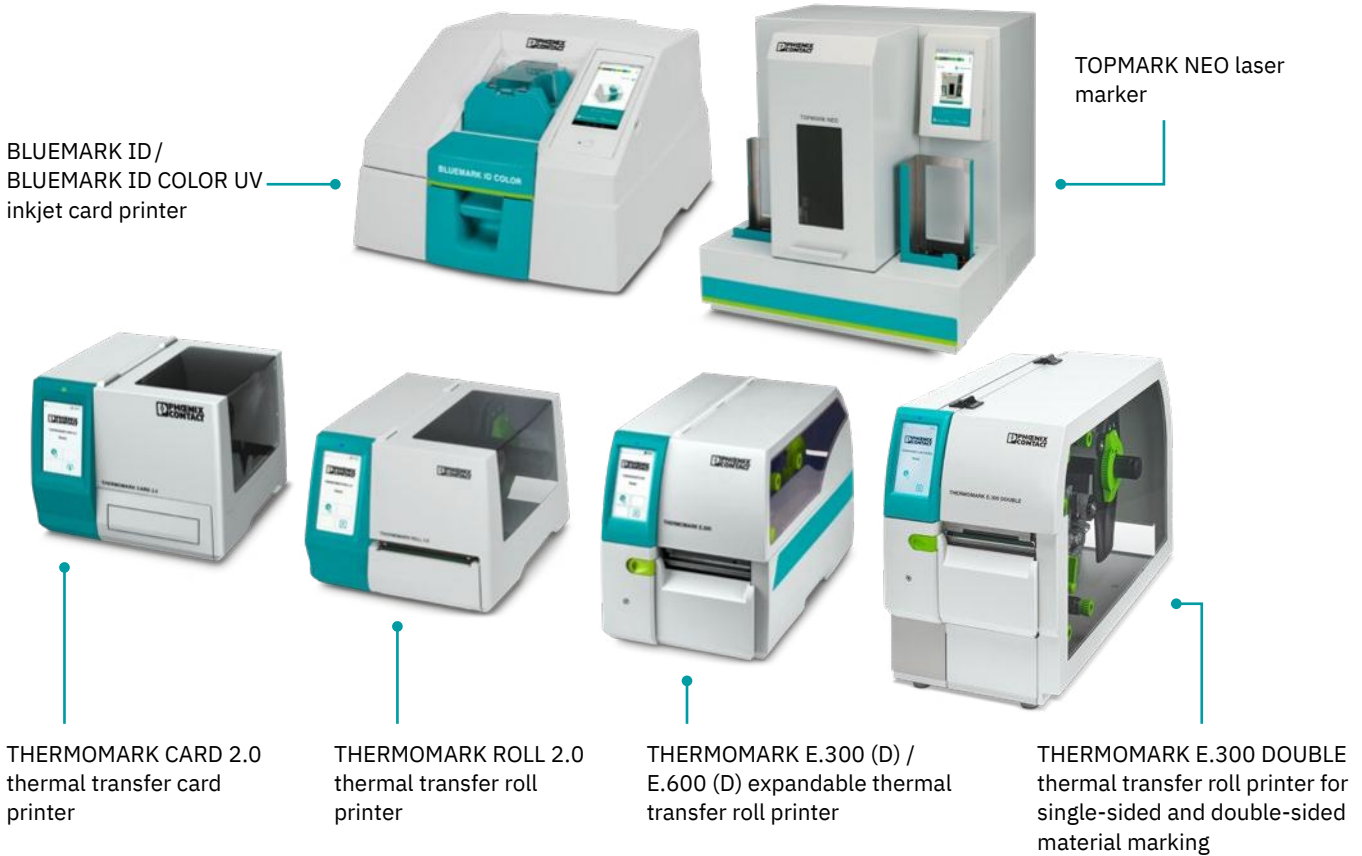

Marking systems for mobile identification

In addition to the printers for stationary, centrally organized identification processes, we also offer solutions for technical supply units in the application environment with our mobile thermal

transfer printers. Featuring integrated marking software and wireless control via app, the battery-powered printers are ready for use exactly where you need them.



THERMOMARK PRIME 2.0
mobile card printer



THERMOMARK GO
app-controlled label
printer



THERMOMARK GO.K
compact handheld printer

Direct laser marking system

TOPMARK NEO

The TOPMARK NEO uses direct laser marking to create markings that meet very stringent requirements. With almost 500 different materials, the innovative system processes the largest laser portfolio on the market for the identification of various applications. Numerous intelligent functions make operation so easy and intuitive that there is no need for any in-depth knowledge of lasers.



Information about the TOPMARK NEO

Laser marker

The TOPMARK NEO marking system enables you to flexibly implement the requirements of challenging identification applications. With modern laser technology, the integrated marking software, and a de-stacking and stacking function, you

can quickly and easily create marking materials for use in industrial applications. The laser marker processes a diverse range of materials in card and sheet format. The laser marking results achieved with the TOPMARK NEO impress with their

excellent resilience against a wide range of environmental and mechanical influences. Preset parameters mean that no specialist knowledge of lasers is required to operate the device.

Resilient direct laser marking

The TOPMARK NEO uses a fiber laser to generate the laser beam. The advantage of this technology is the high beam quality, and therefore a high resolution, since the laser

beam is generated directly in the glass fiber. The selection of the appropriate marking method for the respective application is crucial. If all the parameters are well

matched, this results in markings that meet very stringent requirements.

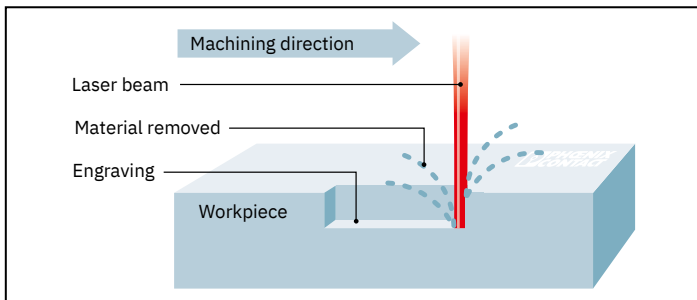

Engraving solid material through abrasion

During the engraving process, the laser beam hits the surface of the solid material. The heat generated vaporizes the material and thus removes it – thereby creating the engraving.

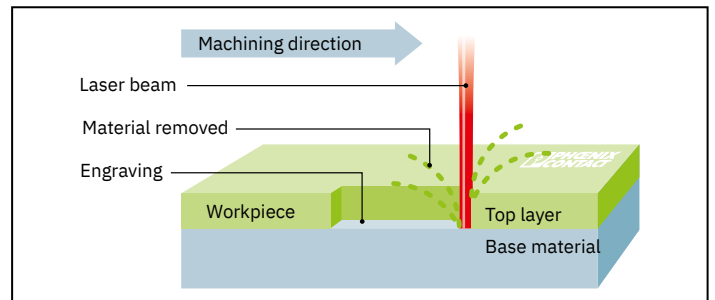

Engraving through abrasion of the top layer

The engraving process, in which the base material becomes visible as the top layer is removed, is typically used for anodized aluminum, coating layers, or special laser marking films. The different visible materials create the color contrast for the marking.

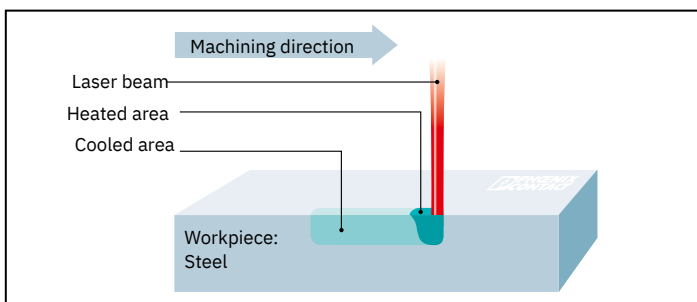

Annealing marking

In annealing marking, the laser applies an oxide layer in the workpiece. The color of the layer depends on the temperature. No material is removed in this case, so the surface of the workpiece remains smooth and even.

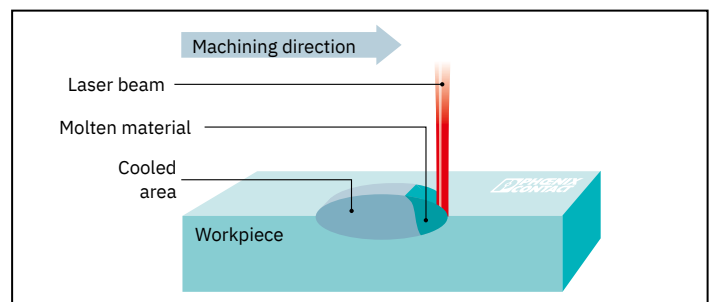





















Carbonization and foaming

This method generates a marking by melting the material. Carbonization is suitable for light-colored plastics because it causes a darkening of the material.

By contrast, foaming forms small gas bubbles in plastic that reflect the light and thus create light-colored markings on dark plastic.

Possible applications of the laser marker

Possible applications			
Product group	Feature image	Description	Page
Terminal identification			
UCT-TM		Markers made of PC (polycarbonate) in sheet format for latching into terminal blocks with tall marking groove, can be marked with thermal transfer, UV inkjet, and laser technology	97
UCT-TMF		Markers made of PC (polycarbonate) in sheet format for latching into terminal blocks with flat marking groove, can be marked with thermal transfer, UV inkjet, and laser technology	96
Wire and cable identification			
UCT-WMTBA...		Angled cable markers made of PC (polycarbonate) in sheet format for marking wires and cables by means of assembly with cable ties	112
LS-WMTB-AL		Aluminum cable markers in sheet format for marking wires and cables by means of assembly with cable ties	114
LS-WMTB-V4A		Stainless steel cable markers in sheet format for marking wires and cables by means of assembly with cable ties	114
UC-WMTBA .../PP...		Highly durable, angled cable markers made of PP (polypropylene) in sheet format for marking wires and cables by means of assembly with cable ties	112
Equipment identification			
UCT-EM		Snap-in markers made of PC (polycarbonate) in sheet format for latching into marker carriers and components for equipment marking	134
UCT-EMNP		Insert labels made of PC (polycarbonate) in sheet format for the identification of the Festo CPX-AP-I automation system	136
UCT-EMP		Markers made of PC (polycarbonate) in sheet format for insertion into KMK... marker carriers for equipment marking	136
LS-EMP-AL		Aluminum labels in sheet format for latching into CARRIER-EMP... marker carriers for equipment marking	135

Possible applications			
Product group	Feature image	Description	Page
Equipment identification			
LS-EMP		Preassembled markers attached by means of insertion in marker carriers, easily legible due to high contrast between the white top layer and black marking	135
LS-EMP 22		For marking command and signaling devices with a diameter of 22 mm, easily legible due to high contrast between the white top layer and black marking	139
LS-EMLP		Self-adhesive ABS labels in sheet format for equipment marking	131
LS-EMLP 24		Self-adhesive ABS labels in sheet format for marking command and signaling devices with a diameter of 24 mm	140
LS-EMLP-AL		Self-adhesive aluminum labels in sheet format for equipment marking	133
LS-EMLP-V4A		Self-adhesive stainless steel labels in sheet format for equipment marking	133
LS-EMSP-AL		Aluminum labels in sheet format for screwing or riveting for equipment marking	132
LS-EMSP-V4A		Stainless steel labels in sheet format for screwing or riveting for equipment marking	133
LS-EML		Self-adhesive laser foil in sheet format for equipment marking	131
LS-EMSP-AL 2L		Coated aluminum markers attached to devices by means of screwing/riveting or to cables and hoses with cable ties, improved legibility due to high contrast	133
Plant identification			
UCT-PMP		Labels made of PC (polycarbonate) in sheet format for latching into marker carriers for the identification of machines and systems	155
UCT-PMLP		Self-adhesive labels made of PC (polycarbonate) in sheet format for the identification of machines and systems	154

TOPMARK NEO



TOPMARK NEO laser marker



Type	Item no.	TOPMARK NEO	1012015	TOPMARK NEO SET	1012018
Description		Laser marking system for the efficient marking of metal and plastic marking materials from the LS..., UCT..., UC.../PP..., and UM... product families.		Equipment set consisting of the TOPMARK NEO laser marking system and the TMN-EXTRACTION extraction marking unit for the efficient marking of metal and plastic marking materials from the LS..., UCT..., UC.../PP..., and UM... product families.	
Interfaces		10/100 Mbps Ethernet (P2P), dynamic IP RS-232 USB host for USB stick		10/100 Mbps Ethernet (P2P), dynamic IP RS-232 USB host for USB stick	
Ambient temperature		5°C ... 35°C		5°C ... 35°C	
Print resolution		Max. 500 dpi		Max. 500 dpi	
CW laser power		20 W		20 W	
Weight		45 kg		100 kg	

Accessories for the TOPMARK NEO

Accessories		
	Type	TMN-EXTRACTION
	Item no.	1012102
Filter and extraction unit for the efficient extraction of fumes and dust caused by TOPMARK NEO laser emissions.		
	Type	TMN-PRE FILTER
	Item no.	1012100
Replacement prefilter for TOPMARK NEO		
	Type	TOPMARK LASER HEPA FILTER
	Item no.	0803305
Replacement HEPA filter		
	Type	TOPMARK LASER CARBON FILTER
	Item no.	0803306
Replacement activated carbon filter		
	Type	TMN-EXTRACTION HOSE
	Item no.	1012101
Replacement suction tube, length: 2.5 m		
	Type	TOPMARK LASER CLEANING NOZZLE
	Item no.	0803310
Cleaning nozzle, for plugging onto the suction tube of the extraction unit.		
	Type	TMN-ADAPTER PLATE-LS
	Item no.	1012104
Adapter plate for LS materials incl. 4 magnets for spot securing of lightweight marking materials		
	Type	TMN-HANDLE SET
	Item no.	1012105
Carrying handles for carrying the laser marker more easily		
	Type	TMN-BP
	Item no.	1012081
Bypass plug, D-SUB connector, 25-pos. for simulating an extraction unit		

Accessories		
	Type	TMN-FRAME-LS
	Item no.	0803478
Retaining plate for circumferentially securing lightweight marking materials		
	Type	TOPMARK LASER STATION
	Item no.	0831835
Unit for accommodating the TOPMARK LASER or TOPMARK NEO with space for an extraction unit and a notebook		
	Type	TMN-TRANSPORT BOX
	Item no.	1012103
Original packaging for transportation		

UV inkjet printing systems

BLUEMARK ID and BLUEMARK ID COLOR

With the BLUEMARK ID marking systems, you can process high print volumes and create high-quality markings. The intuitive operating software guides you through the entire printing process, automates maintenance, and helps prevent printing errors. The UV inkjet printing technology achieves pin-sharp typefaces in black and white and even in color with the BLUEMARK ID COLOR.



Information about the BLUEMARK ID and BLUEMARK ID COLOR

1

2

3

4

Marking systems

UV inkjet printers

Choose innovative UV inkjet technology in a space-saving device. The BLUEMARK ID printing systems are the all-in-one solution for processing high print volumes in industrial identification. Materials in card and sheet format as well as aluminum markers are printed quickly and easily by the versatile printers. The materials are instantly wipe- and scratch-proof, so are ready for immediate use. In addition to the BLUEMARK ID for monochrome printing, the BLUEMARK ID COLOR system also prints CMYK multicolor markings. Both printing systems have a stacking and de-stacking function. This enables the processing of up to 11,000 markers per hour for monochrome printing and 8,000 markers per hour for color printing.



Versatile UV inkjet printing

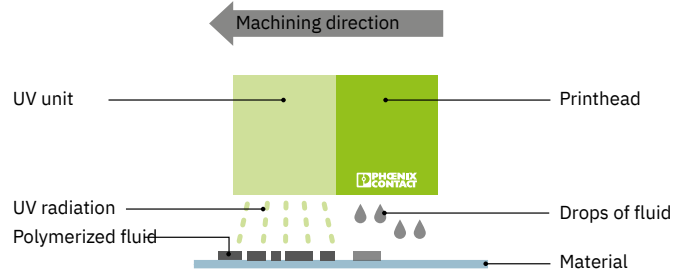

UV inkjet printing technology is based on the rapid curing process of a printing fluid with UV light. The printhead creates individual drops of ink from the fluid and propels them in the direction of the marking material. The drops are applied in lines below the printhead through the movement of the marking material. In the same step, UV radiation cures the fluid in an area of 1 cm² with very high intensity. No heat is generated during this process, so the resulting markings can be used immediately. The printed plastic or metal markings have high wipe and scratch resistance and are especially resistant to chemicals.











Your advantages

- ✓ The integrated marking software supports the entire printing process via an intuitive 7" touch display
- ✓ Automatic material feed-in and the stacking and de-stacking function speed up the processing of large quantities of material
- ✓ Additional front feed-in is integrated along with magazine insertion. This enables the flexible printing of individual UC/UCT sheets, metal labels, and US cards
- ✓ Over 1,000 materials for industrial identification are available for both printing systems

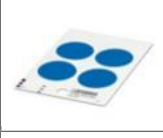

Possible applications of the UV inkjet printer

Possible applications			
Product group	Feature image	Description	Page
Terminal identification			
UC-TM		Markers made of PA (polyamide) in sheet format for latching into terminal blocks with tall marking groove	97
UC-TMF		Markers made of PA (polyamide) in sheet format for latching into terminal blocks with flat marking groove	96
UCT-TM		Markers made of PC (polycarbonate) in sheet format for latching into terminal blocks with tall marking groove, can be marked with thermal transfer, UV inkjet, and laser technology	97
UCT-TMF		Markers made of PC (polycarbonate) in sheet format for latching into terminal blocks with flat marking groove, can be marked with thermal transfer, UV inkjet, and laser technology	96
Wire and cable identification			
UC-WMT		Cable markers made of PA (polyamide) in sheet format for insertion on wires and cables with marking tags from the PATG (HF) / PATO... system	110
UCT-WMT		Cable markers made of PC (polycarbonate) in sheet format for insertion on wires and cables with marking tags from the PATG (HF) / PATO... system	110
UC-WMC		Wire markers made of PA (polyamide) in sheet format for clipping onto wires and cables, even after wiring has already been completed	118
UC-WMCO		Wire markers made of PA (polyamide) in sheet format for sliding onto wires and cables using the UC-WMCO...TOOL	118
UCT-WMCO		Wire markers made of PC (polycarbonate) in sheet format for subsequent marking by simply clipping onto wires and cables	118
UC-WMTBA		Angled cable marker made of PA (polyamide) in sheet format for marking and bundling wires and cables by means of assembly with cable ties	112
UCT-WMTBA		Angled cable marker made of PC (polycarbonate) in sheet format for marking and bundling wires and cables by means of assembly with cable ties	112
US-WMT		Prepunched cable markers made of PVC (polyvinyl chloride) in card format for insertion into marking tags from the PATG (HF) / PATO... system	113
WMTB-AL		Aluminum cable markers for marking wires and cables by means of assembly with cable ties	114

BLUEMARK ID (COLOR)

Possible applications			
Product group	Feature image	Description	Page
Equipment identification			
UC-EMP		Snap-in markers made of PA (polyamide) in sheet format for latching into existing CARRIER-EMP label frames	134
UC-EMLP		Self-adhesive device markers made of PA (polyamide) in sheet format with high adhesive strength	131
UCT-EM		Snap-in markers made of PC (polycarbonate) in sheet format for latching into marker carriers and components for equipment marking	134
US-EMLP		Self-adhesive device markers made of PVC (polyvinyl chloride) in card format with high adhesive strength	130
US-EMP		Snap-in markers made of PVC (polyvinyl chloride) in card format for latching into existing CARRIER-EMP... label frames	134
EMLP-AL		Self-adhesive aluminum label for equipment marking	141
EMSP-AL		Aluminum label for screwing or riveting for equipment marking	141
Plant identification			
US-PML-M		Self-adhesive mandatory sign made of PVC (polyvinyl chloride) in card format in accordance with ISO 7010	149
US-PML-GHS		Self-adhesive hazardous substance label made of polyester in card format in accordance with the international standard (GHS)	152
US-PML-W		Self-adhesive warning label made of PVC (polyvinyl chloride) in card format in accordance with ISO 7010	150



BLUEMARK ID / BLUEMARK ID COLOR and printer accessories



UV inkjet printers			
			
Type	Item no.	BLUEMARK ID COLOR 1002329	BLUEMARK ID 1003334
Description	CMYK multicolor printer with UV inkjet technology, with integrated "Marking system app" identification software, 7" color touch display for printing plastic labels in UC, UCT, US, and UM format, as well as metal labels.		Monochrome printer with UV inkjet technology and integrated "Marking system app" identification software. 7" color touch display for printing plastic labels in UC, UCT, US, and UM format, as well as metal labels.
Interfaces	10/100 Mbps Ethernet, 1 x USB 2.0 device, 1 x USB 2.0 host		10/100 Mbps Ethernet, 1 x USB 2.0 device, 1 x USB 2.0 host
Ambient temperature	5°C ... 35°C		5°C ... 35°C
Print resolution	300 dpi, 600 dpi		300 dpi, 600 dpi
Weight	21 kg		21 kg

Accessories		
	Type	BM ID-MAG20
	Item no.	1044356
Input magazine for holding max. 20 UniCard sheets		
	Type	BM ID-MAG40
	Item no.	1044357
Input magazine for holding max. 40 UniCard sheets		
	Type	BM ID-ADAPTER PLATE-US
	Item no.	1044355
Adapter plate for holding US sheets		
	Type	BM ID CASE
	Item no.	1049953
Transport case, with aluminum edges, for BLUEMARK ID and accessories		
	Type	BM ID-CARDBOARD BOX
	Item no.	1044361
Original packaging for transportation		

Accessories: Magazines		
	Type	BLUEMARK MAG EM-M (100X60)
	Item no.	0802742
Magazine for BLUEMARK printer, for holding EMLP-AL (100x60) and EMSP-AL (90x60)		
	Type	BLUEMARK MAG UM-TM
	Item no.	0803335
Magazine for BLUEMARK printer, for holding UM materials		
	Type	BLUEMARK MAG WM-M (40X15)
	Item no.	0802744
Magazine for BLUEMARK printer, for holding WMTB-AL (40x15)		
	Type	BLUEMARK MAG AI-WM
	Item no.	5146567
Magazine for BLUEMARK printer, for holding 0.5 mm² ... 1.5 mm² ferrules with insulating collar that can be marked		
	Type	BLUEMARK MAG ZB 8/27
	Item no.	5146558
Magazine for BLUEMARK, only for ZB 8/27 UV-100 - 0829102		

Accessories for the BLUEMARK ID and BLUEMARK ID COLOR

Accessories: BLUEMARK ID COLOR cartridges		
	Type	BM ID-CARTR. BK
	Item no.	1044345
	Replacement UV fluid, 23 ml, color: black	
	Type	BM ID-CARTR. CY
	Item no.	1044346
	Replacement UV fluid, 23 ml, color: cyan	
	Type	BM ID-CARTR. MA
	Item no.	1044347
	Replacement UV fluid, 23 ml, color: magenta	
	Type	BM ID-CARTR. YE
	Item no.	1044348
	Replacement UV fluid, 23 ml, color: yellow	
	Type	BM ID-DUMMY CARTR. BK
	Item no.	1044351
	Dummy cartridge for transportation, color: black	
	Type	BM ID-DUMMY CARTR. CY
	Item no.	1044352
	Dummy cartridge for transportation, color: cyan	
	Type	BM ID-DUMMY CARTR. MA
	Item no.	1044353
	Dummy cartridge for transportation, color: magenta	
	Type	BM ID-DUMMY CARTR. YE
	Item no.	1044354
	Dummy cartridge for transportation, color: yellow	
	Type	BM ID-CLEANING CARTR.
	Item no.	1044350
	Replacement cleaning cartridge	

Accessories: BLUEMARK ID cartridges		
	Type	BM ID-CARTR. BK
	Item no.	1044345
	Replacement UV fluid, 23 ml, color: black	
	Type	BM ID-DUMMY CARTR. BK
	Item no.	1044351
	Dummy cartridge for transportation, color: black	
	Type	BM ID-CLEANING CARTR.
	Item no.	1044350
	Replacement cleaning cartridge	

Thermal transfer printers

The printers in the THERMOMARK series are characterized by the proven, low-maintenance thermal transfer printing technology – providing a particularly cost-effective marking solution even for large order volumes. The various printers for marking materials in card, sheet, and roll format process a wide range of materials for terminal, wire and cable, equipment, and plant identification.



THERMOMARK CARD 2.0

The THERMOMARK CARD 2.0 marks plastic labels in card and sheet format for applications in terminal, wire and cable, equipment, and plant marking.

➤ More information starting on page 24



THERMOMARK ROLL 2.0

The THERMOMARK ROLL 2.0 prints labels, shrink sleeves, and marking sleeves in roll format for applications in terminal, wire and cable, equipment, and plant marking.

➤ More information starting on page 30



THERMOMARK E.300 (D)/E.600 (D)

The THERMOMARK E.300 (D)/E.600 (D) is suitable for long-term industrial use and the processing of large print volumes. It is the basic printer for the THERMOMARK E SERIES modular printing system.

➤ More information starting on page 36



THERMOMARK E.300 DOUBLE

The THERMOMARK E.300 DOUBLE marks marking materials in roll format on one or both sides, thereby ensuring optimum legibility of the markings.

➤ More information starting on page 42



THERMOMARK CARD 2.0

Thermal transfer printer for card and sheet format

The THERMOMARK CARD 2.0 is the efficient solution for printing plastic labels in card and sheet format. You can control the THERMOMARK CARD 2.0 directly via the marking software. The proven thermal

transfer printing technology offers a high level of efficiency and low-maintenance operation.

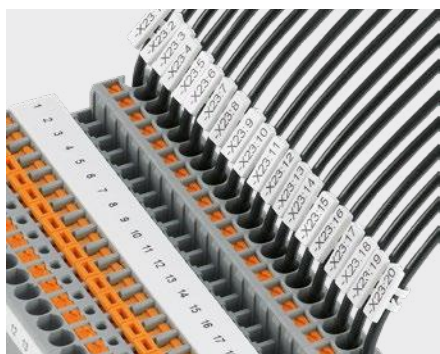

With the THERMOMARK CARD 2.0, you can mark polycarbonate UniCard materials (UCT) quickly, easily, and cost-effectively. The material is characterized by its high mechanical strength and chemical resistance.



For high-quality component, equipment, and plant identification using thermal transfer printing, the THERMOMARK CARD 2.0 marks UniSheet materials (US) made of various plastics.



The Marking system software enables you to implement your custom-designed marking solutions easily and conveniently. Control and manage your THERMOMARK CARD 2.0 with the Marking system software.

Information about the THERMOMARK CARD 2.0

Thermal transfer card printer

Delivering fast and high-quality results, the THERMOMARK CARD 2.0 thermal transfer printer prints marking materials in card and sheet format. This printer makes it easy for you to produce terminal, wire and cable, equipment, and plant markings of incredibly high quality. Automatic material detection ensures that the optimum print settings are used and lowers the risk of printing errors. The marking systems in the THERMOMARK series are characterized by the proven, low-maintenance thermal transfer printing method as well as their compact design, which enables space-saving stationary operation. The touch display enables intuitive printer operation.



Flexible thermal transfer printing

During the thermal transfer printing process, the desired print image is generated through a spot heat generation of the ink ribbon without greater mechanical influence of the marking material (Greek thermós = warm). As the ink ribbon is fed along the printhead in synchronization with the marking material, the heating elements of the printhead are heated according to the desired print image. The heat and contact pressure initiate precise ink transfer to the marking material. The three components comprising the printer, marking material, and thermal transfer ink ribbon determine the print quality. If their interaction is optimally coordinated, this ensures high-quality and durable printing results.

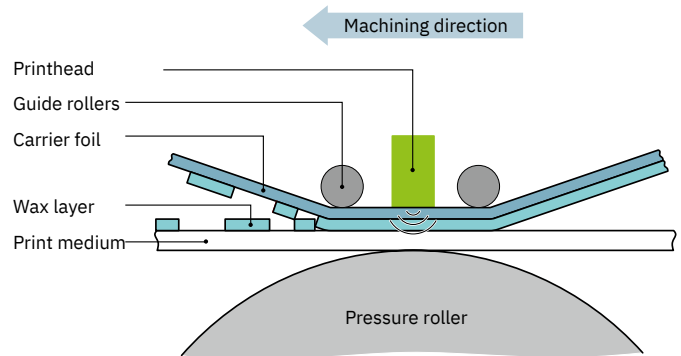











Your advantages

- ✔ High-quality, durable, and fast printing
- ✔ Particularly easy and error-free handling with automatic material detection
- ✔ Intuitive operation via color touch display
- ✔ Easy to control with the marking software
- ✔ USB and Ethernet ports as well as optional control via Marking system app and separate Bluetooth adapter

Possible applications of the thermal transfer printer

Possible applications			
Product group	Feature image	Description	Page
Terminal identification			
UCT-TM		Markers made of PC (polycarbonate) in sheet format for latching into terminal blocks with tall marking groove, can be marked with thermal transfer, UV inkjet, and laser technology	97
UCT-TMF		Markers made of PC (polycarbonate) in sheet format for latching into terminal blocks with flat marking groove, can be marked with thermal transfer, UV inkjet, and laser technology	96
UM...-TM...		Markers made of PC (polycarbonate) in strip format for latching into terminal blocks from other manufacturers with tall marking groove	Online shop
UM...-TMF...		Markers made of PC (polycarbonate) in strip format for latching into terminal blocks from other manufacturers with flat marking groove	
US-TML		Self-adhesive marking strips made of polyester in card format for marking terminal blocks without marking groove	98
Wire and cable identification			
UCT-WMTBA		Angled cable markers made of PC (polycarbonate) in sheet format for marking and bundling wires and cables by means of assembly with cable ties	112
UCT-WMCO		Wire markers made of PC (polycarbonate) in sheet format for subsequent marking by simply clipping onto wires and cables	118
UCT-WMT		Cable markers made of PC (polycarbonate) in sheet format for insertion into marking tags from the PATG (HF) / PATO... system	110
UCT-WMS		Wire markers made of PC (polycarbonate) in sheet format for sliding onto wires and cables	119
US-WML		Durable, self-adhesive wrap-around labels made of PVC (polyvinyl chloride) with a transparent protective foil in card format, for marking wires and cables in indoor and outdoor installations	115
US-WMTB		Cable markers made of PVC (polyvinyl chloride) in card format for marking and bundling wires and cables by means of assembly with cable ties	113
US-WMT		Prepunched cable markers made of PVC (polyvinyl chloride) in card format for insertion on wires and cables with marking tags from the PATG / PATO... system	113

THERMOMARK CARD 2.0

Possible applications			
Product group	Feature image	Description	Page
Equipment identification			
UCT-EM		Snap-in markers made of PC (polycarbonate) in sheet format for latching into a marking groove	134
US-EML		Self-adhesive, prepunched labels made of polyester in card format for the identification of components and equipment	130
US-EMLF		Self-adhesive, prepunched, and highly flexible labels made of PVC (polyvinyl chloride) in card format for equipment marking in indoor and outdoor installations	131
US-EMT		Prepunched snap-in markers made of polyester in card format for the identification of Siemens S7-300 controllers	134
US-EMLP		Self-adhesive device markers made of PVC (polyvinyl chloride) in card format for the identification of components and equipment	130
US-EMLP-HA		Self-adhesive labels made of PVC (polyvinyl chloride) with high adhesive strength in card format for equipment marking of components with rough, textured, and low-energy surfaces	138
US-EMP		Snap-in markers made of PVC (polyvinyl chloride) in card format for latching into existing CARRIER-EMP... marker carriers	134
US-EMSP		Individual markers in card format made of PVC (polyvinyl chloride) for screwing or riveting for equipment marking	132
Plant identification			
US-PML-ESS		Self-adhesive labels made of PVC (polyvinyl chloride) in card format for the identification of emergency stop buttons	153
US-PML-P		Self-adhesive prohibition signs made of PVC (polyvinyl chloride) in card format in accordance with ISO 7010	149
US-PML-W		Self-adhesive warning labels made of PVC (polyvinyl chloride) in card format in accordance with ISO 7010	150



THERMOMARK CARD 2.0



THERMOMARK CARD 2.0 thermal transfer printer







Type	Item no.	THERMOMARK CARD 2.0	1085267
Description	Thermal transfer printer for card materials, incl. Euro/US power cable and USB cable. User manual printed in German and English. Magazine for UCT-TM... sheets and magazines for US-... cards. One packing unit each UCT-TM 6, US-EMLP (85,6x54), ink ribbon = 50 m		
Interfaces	10/100 Mbps Ethernet, USB 2.0		
Ambient temperature	5°C ... 35°C		
Print resolution	300 dpi		
Weight	6 kg		

Accessories for the THERMOMARK CARD 2.0

Accessories: Transportation		
	Type	TL CASE
	Item no.	0800613
Transport case for THERMOMARK printers, rounded profile case with aluminum frame, including the TL CASE TROLLEY		
	Type	TL CASE TROLLEY
	Item no.	0803337
Trolley for the transport cases for THERMOMARK LINE and THERMOMARK ROLL X1		
	Type	TC/TR-PACKAGE WITH FOAM
	Item no.	0801804
Original packaging for transportation		

Accessories: Magazines		
	Type	TMP-UCT-MAG1
	Item no.	0803342
Magazine, for THERMOMARK PRIME and THERMOMARK CARD, for holding UCT-TM..., UCT1(U)-TM..., UCT5-TM..., UCT-EM (5x10), UCT-EM (6x10), length: 0.166 m, width: 114 mm, height: 11.5 mm		
	Type	TMP-US-MAG1
	Item no.	0803341
Magazine, for THERMOMARK CARD and THERMOMARK PRIME, for holding US cards, length: 0.166 m, width: 114 mm, height: 10 mm		
	Type	TMP-UM-MAG1
	Item no.	0831200
Magazine for THERMOMARK CARD and THERMOMARK PRIME, for holding UM material (UM1-TM and UM5-TM)		

Accessories: Ink ribbons		
	Type	THERMOMARK-RIBBON 110-TC
	Item no.	0801371
Ink ribbon, for THERMOMARK CARD for printing product groups UCT..., US..., and UM..., roll length: 300 m, width: 110 mm, color: black		
	Type	TM-RIBBON 110 WH 100
	Item no.	0804661
Ink ribbon, for THERMOMARK roll printers and THERMOMARK CARD for printing material-off-the-roll product groups: EML ..., EMLP ..., EMLF ..., PML-M ..., WMTB HF-HP..., WMS-2 HF ... RD and US material product groups: US-EML(S)P ..., US-EMLP-HA ..., US-EM(S)P ..., US-WMT ..., US-WMTB ..., US-PML-M ..., US-EMLF ..., roll length: 60 m, width: 110 mm, color: white		
	Type	THERMOMARK-RIBBON 110/50-TC
	Item no.	0801384
Ink ribbon, for THERMOMARK CARD for printing product groups UCT..., US..., and UM..., roll length: 50 m, width: 110 mm, color: black		

Accessories: Cleaning		
	Type	CLEANING STICK
	Item no.	5146697
Cleaning stick for fast and efficient printhead cleaning of all Phoenix Contact thermal transfer printers.		
	Type	THERMOMARK-CP
	Item no.	5145371
Cleaning pen, for thermal transfer printers		

For more magazines and ink ribbons, visit our online shop

THERMOMARK ROLL 2.0

Thermal transfer printer for roll format

The THERMOMARK ROLL 2.0 prints labels and insert labels as well as shrink sleeves and marking sleeves in roll format. You can control the THERMOMARK ROLL 2.0 directly via the marking software.

The proven thermal transfer printing technology offers a high level of efficiency and low-maintenance operation.



With the THERMOMARK ROLL 2.0, you can mark preassembled or continuous adhesive labels, insert labels, and shrink sleeves and marking sleeves quickly, easily, and cost-effectively.

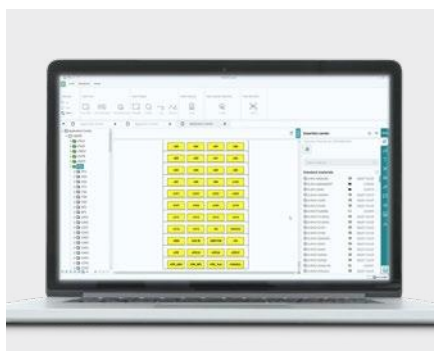

The marking software enables you to implement your custom-designed marking solutions easily and conveniently. Control and manage your THERMOMARK ROLL 2.0 with the Marking system software.

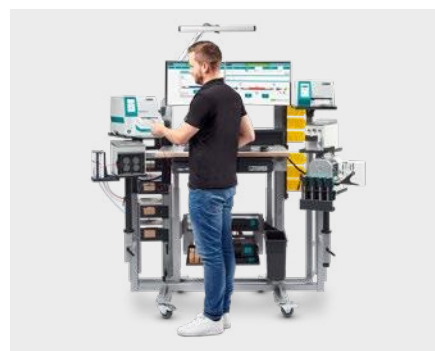

The clipx WIRE assist worker assistance system enables efficient wire processing. Combine the software-supported system with printing systems for easy and ergonomic wire preparation.

Information about the THERMOMARK ROLL 2.0

Thermal transfer roll printer

The THERMOMARK ROLL 2.0 prints markers in roll and continuous format for applications in terminal, wire and cable, equipment, and plant marking. You can create high-quality printed labels, insert labels, shrink sleeves, and marking sleeves easily and reliably. In combination with the THERMOMARK ROLL-CUTTER(/P) cutting units, you can cut or perforate continuous media in next to no time. The marking systems in the THERMOMARK series are characterized by the proven, low-maintenance thermal transfer printing method as well as their compact design, which enables space-saving stationary operation. The touch display enables intuitive printer operation.



Flexible thermal transfer printing

During the thermal transfer printing process, the desired print image is generated through a spot heat generation of the ink ribbon without greater mechanical influence of the marking material (Greek thermós = warm). As the ink ribbon is fed along the printhead in synchronization with the marking material, the heating elements of the printhead are heated according to the desired print image. The heat and contact pressure initiate precise ink transfer to the marking material.

The three components comprising the printer, marking material, and thermal transfer ink ribbon determine the print quality. If their interaction is optimally coordinated, this ensures high-quality and durable printing results.

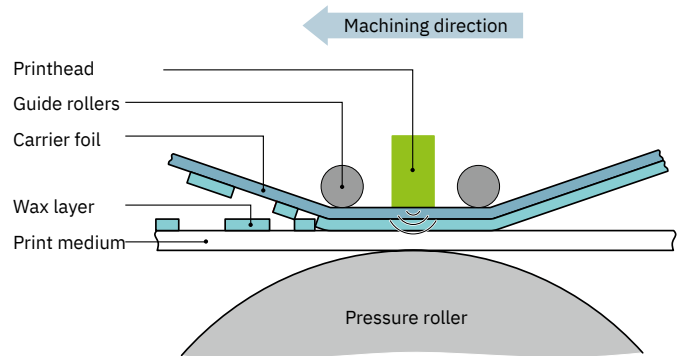

Your advantages

- ✔ High-quality, durable, and fast printing of labels and insert labels as well as shrink sleeves and marking sleeves, preassembled or in continuous format
- ✔ Cutting or perforating of continuous media with high positioning accuracy
- ✔ Intuitive operation via color touch display
- ✔ Easy to control with the marking software
- ✔ USB and Ethernet ports as well as optional control via Marking system app and separate Bluetooth adapter

Possible applications of the thermal transfer printer

Possible applications			
Product group	Feature image	Description	Page
Terminal identification			
TMT...		Perforated terminal markers made of polyester in roll format for latching into a flat marking groove	97
Wire and cable identification			
WML		Durable, self-adhesive wrap-around labels made of PVC (polyvinyl chloride) with a transparent protective foil in roll format for marking wires and cables in indoor and outdoor installations	115
WML HF		Halogen-free, durable, and self-adhesive wrap-around labels made of PE (polyethylene) with a transparent protective foil in roll format for marking wires and cables	115
WML-FLAG		Self-adhesive labels suitable for double-sided printing made of polyolefin with cable marking flags in roll format for marking wires and cables	115
WMS		Halogen-free WMS marking sleeve made of polyolefin in ladder and continuous format for sliding onto wires and cables in accordance with UL 224 and CSA 22.2 with a shrink ratio of 3:1	116
WMS-2 HF		Halogen-free WMS-2 HF marking sleeve made of polyolefin in ladder and continuous format for sliding onto wires and cables in accordance with EN 45545-2 for the railway industry with a shrink ratio of 2:1	116
WMTB HF		Halogen-free WMTB HF cable markers made of PUR (polyurethane) in roll format for marking and bundling wires and cables by means of assembly with cable ties	113
WMTB HF-HP		Halogen-free WMTB HF-HP cable markers made of polyolefin in roll format for marking and bundling wires and cables by means of assembly with cable ties in accordance with EN 45545-2 for the railway industry	113
WMT...		Prepunched cable markers made of PVC (polyvinyl chloride) in roll format for threading onto wires and cables	110
WMTS		Prepunched cable markers made of PET (polyethylene terephthalate) in roll format for insertion into marking tags from the PATG/ PATO... system, easy mounting with threading and insertion aid	111
EMT		Prepunched insert labels made of polyester in roll format for KMK... marker carriers	111

THERMOMARK ROLL 2.0

Possible applications			
Product group	Feature image	Description	Page
Equipment identification			
EML		Self-adhesive, prepunched labels made of polyester in roll format for equipment marking	130
EML-HA		Self-adhesive, prepunched labels made of polyester in roll format for equipment marking of components with rough, textured, and low-energy surfaces	137
EML-LPR		Self-adhesive labels made of polyester with transparent protective laminate in roll format for equipment marking of components with rough, textured, and low-energy surfaces	137
EML-LPR-D		Detectable, self-adhesive labels made of polyester with transparent protective laminate in roll format for equipment marking of components with rough, textured, and low-energy surfaces	136
EML-D		Detectable, self-adhesive, and prepunched labels made of polyester with high adhesive strength in roll format for equipment marking	136
EML-LT		Self-adhesive, prepunched labels made of polyester in roll format for equipment marking of components in refrigerated and frozen environments	137
EMLP		Self-adhesive, prepunched labels made of polyester in roll format for the identification of electrical components, equipment, and buttons	130
EMLS		Self-adhesive safety labels made of polyester with special adhesive in roll format for equipment marking, can be used as a rating plate or seal label	137
EMT		Sustainable identification for loading bins in logistics	134
Plant identification			
PML-W		Self-adhesive warning labels made of PVC (polyvinyl chloride) in roll format in accordance with ISO 7010	150
PML-M		Self-adhesive mandatory signs made of PVC (polyvinyl chloride) in roll format in accordance with ISO 7010	149
PML-P		Self-adhesive prohibition signs made of PVC (polyvinyl chloride) in roll format in accordance with ISO 7010	149

THERMOMARK ROLL 2.0 and printer accessories

THERMOMARK ROLL 2.0 thermal transfer printer



Type	Item no.	THERMOMARK ROLL 2.0	1085260
Description	Thermal transfer printer for material off the roll, incl. Euro/ US power cable and USB cable. Operating instructions printed in German and English. 1 roll of labels EML (20x8)R white = 1,000 labels, ink ribbon = 50 m		
Interfaces	10/100 Mbps Ethernet, USB 2.0, RS-232		
Ambient temperature	10°C ... 35°C		
Print resolution	300 dpi		
Weight	3.8 kg		

Accessories: Transportation

	Type	TL CASE
	Item no.	0800613
Transport case for THERMOMARK printers, rounded profile case with aluminum frame, including the TL CASE TROLLY		
	Type	TL CASE TROLLY
	Item no.	0803337
Trolley for the transport cases for THERMOMARK LINE and THERMOMARK ROLL X1		
	Type	TC/TR-PACKAGE WITH FOAM
	Item no.	0801804
Original packaging for transportation		

Accessories: Cutting unit and tear-off plate



	Type	THERMOMARK ROLL-CUTTER
	Item no.	5146422
Cutter, for THERMOMARK ROLL and THERMOMARK ROLL 2.0, cutter width: 110 mm, suitable for: TML-, SK-, EML-RM-, PMM-, WMS-, WMS-2 HF-, WMS-OT HF-, TMT continuous media, and EMT (EX15)R		
	Type	THERMOMARK ROLL-CUTTER/P
	Item no.	5146435
Perforation cutter, for THERMOMARK ROLL and THERMOMARK ROLL 2.0, cutter width: 45 mm, suitable for: WMS continuous media up to 25.4 mm, WMS-2 continuous media up to 25.4 mm, WMS-OT HF continuous media, TMT continuous media, and EMT (EX15)R		
	Type	TR-TEAR OFF PLATE
	Item no.	0801803
Tear-off plate		

Accessories for the THERMOMARK ROLL 2.0

Accessories: Ink ribbons		
	Type	THERMOMARK-RIBBON 110
	Item no.	5145384
	Ink ribbon, for roll printers for printing product groups TML..., WML..., WML HF..., WML-FLAG..., EML..., EML-ESD..., EML-RM..., EML-HA..., EMLS..., EMLC..., EMLP..., and PMM..., roll length: 300 m, width: 110 mm, color: black	
	Type	TM-RIBBON 110 WH 100
	Item no.	0804661
	Ink ribbon, for THERMOMARK roll printers and THERMOMARK CARD for printing material-off-the-roll product groups: EML ..., EMLP ..., EMLF ..., PML-M ..., WMTB HF-HP..., WMS-2 HF ... RD and US material product groups: US-EML(S)P ..., US-EMLP-HA ..., US-EM(S)P ..., US-WMT ..., US-WMTB ..., US-PML-M ..., US-EMLF ..., roll length: 60 m, width: 110 mm, color: white	
	Type	THERMOMARK-RIBBON 110-WMTB HF
	Item no.	5148007
	Ink ribbon, for roll printers for printing product groups WMTB HF..., WMS-2 HF..., TMT..., EMT..., EMLF..., PML-..., roll length: 300 m, width: 110 mm, color: black	
	Type	THERMOMARK-RIBBON 110-WMSU
	Item no.	0801358
	Ink ribbon, for roll printers for printing product groups WMS..., WMS-2 HF..., and WMTB HF-HP, roll length: 300 m, width: 110 mm, color: black	
	Type	THERMOMARK-RIBBON 64-WMSU WH
	Item no.	0801361
	Ink ribbon, for roll printers for printing product group WMS... (black), roll length: 300 m, width: 64 mm, color: white	
	Type	TM-RIBBON 25 BK 102
	Item no.	1053499
	Ink ribbon, for printing WMS-OT/WMS-2 HF... materials, roll length: 300 m, width: 25 mm, color: black	

For more ink ribbons, visit our online shop

Accessories: Pressure rollers		
	Type	TR-PRESSURE ROLLER DR4-50
	Item no.	0801800
	Pressure roller for continuous shrink sleeve	
	Type	TR-PRESSURE ROLLER STANDARD
	Item no.	0801802
	Standard pressure roller	

Accessories: External media hubs		
	Type	THERMOMARK ROLL-ERH
	Item no.	5146448
	External media hub, for THERMOMARK ROLL, for outside roll diameter of 150 to 400 mm	
	Type	THERMOMARK-ERH 500
	Item no.	5146309
	External media hub, for THERMOMARK ROLL, for outside roll diameter of up to 500 mm	

Accessories: Cleaning		
	Type	THERMOMARK-CP
	Item no.	5145371
	Cleaning pen, for thermal transfer printers	

THERMOMARK E.300 (D) / E.600 (D)

Thermal transfer printer for roll format

The THERMOMARK E.300 (D) / E.600 (D) processes all materials off the roll with a print resolution of 300 or 600 dpi. The marking system is suitable for long-term industrial use as well as for large print volumes, as large rolls can

also be processed. In addition, the THERMOMARK E.300 (D) / E.600 (D) is the basic printer of the THERMOMARK E SERIES.



The THERMOMARK E.300 (D) / E.600 (D) marks preassembled or continuous adhesive labels, insert labels, and shrink sleeves and marking sleeves quickly and easily.



The printer can process larger material rolls than the THERMOMARK ROLL 2.0. It is suitable for the production of large print volumes and for long-term industrial use.



The clipx WIRE assist worker assistance system enables efficient wire processing by combining the software-supported system with various printing systems.

Information about the THERMOMARK E.300 (D) / E.600 (D)

Thermal transfer printer for large print volumes

Benefit from the flexibility of the THERMOMARK E.300 (D) / E.600 (D) and use the printer to print all materials off the roll in the Marking system portfolio for professional and durable wire and cable identification, equipment and plant identification, and terminal identification. In addition to prepunched label formats, the printer also processes shrink sleeves and marking sleeves as well as label material in continuous format. To do this, simply combine the printer with the THERMOMARK E.CUTTER or E.CUTTER/P for the convenient cutting or perforation of materials in continuous format.



Efficient printing and application system

For maximum efficiency of the identification processes, combine the standard thermal transfer printer with a THERMOMARK E SERIES applicator. This will transform your printer into an efficient printing and application system, enabling you to achieve an average time saving of 60% as the markers are printed and applied in just a single automated process step. With the THERMOMARK E.300 D, the THERMOMARK E.WRAP, E.WIRE, and E.SLEEVE applicators can be used for efficient wire and cable identification and the THERMOMARK E.VARIO can be used for efficient terminal identification.

➤ More information starting on page 76



Your advantages

- ✔ Modular identification system that can be used as a standard printer for equipment identification as well as for automated identification
- ✔ Print resolution of 300 or 600 dpi for precise printing of small barcodes, symbols, and Asian characters
- ✔ Suitable for large print volumes and long-term use in production, as large rolls can also be processed
- ✔ OPC UA supports the real-time bidirectional transfer of all status and error messages to the marking software

Possible applications of the thermal transfer printer





Possible applications			
Product group	Feature image	Description	Page
Terminal identification			
TMT...		Perforated terminal markers made of polyester in roll format for latching into a flat marking groove	97
Wire and cable identification			
WML		Durable, self-adhesive wrap-around labels made of PVC (polyvinyl chloride) with a transparent protective foil in roll format for marking wires and cables in indoor and outdoor installations	115
WML HF		Halogen-free, durable, and self-adhesive wrap-around labels made of PE (polyethylene) with a transparent protective foil in roll format for marking wires and cables	115
WML-FLAG		Self-adhesive labels suitable for double-sided printing made of polyolefin with cable marking flags in roll format for marking wires and cables	115
WMS		Halogen-free WMS marking sleeve made of polyolefin in ladder and continuous format for sliding onto wires and cables in accordance with UL 224 and CSA 22.2 with a shrink ratio of 3:1	116
WMS-2 HF		Halogen-free WMS-2 HF marking sleeve made of polyolefin in ladder and continuous format for sliding onto wires and cables in accordance with EN 45545-2 for the railway industry with a shrink ratio of 2:1	116
WMTB HF		Halogen-free WMTB HF cable markers made of PUR (polyurethane) in roll format for marking and bundling wires and cables by means of assembly with cable ties	113
WMTB HF-HP		Halogen-free WMTB HF-HP cable markers made of polyolefin in roll format for marking and bundling wires and cables by means of assembly with cable ties in accordance with EN 45545-2 for the railway industry	113
WMT...		Prepunched cable markers made of PVC (polyvinyl chloride) in roll format for threading onto wires and cables	110
WMTS		Prepunched cable markers made of PET (polyethylene terephthalate) in roll format for insertion into marking tags from the PATG/ PATO... system, easy mounting with threading and insertion aid	111
EMT		Prepunched insert labels made of polyester in roll format for KMK... marker carriers	111

THERMOMARK E.300 (D) / E.600 (D)





Possible applications			
Product group	Feature image	Description	Page
Equipment identification			
EML		Self-adhesive, prepunched labels made of polyester in roll format for equipment marking	130
EML-HA		Self-adhesive, prepunched labels made of polyester in roll format for equipment marking of components with rough, textured, and low-energy surfaces	137
EML-LPR		Self-adhesive labels made of polyester with transparent protective laminate in roll format for equipment marking of components with rough, textured, and low-energy surfaces	137
EML-LPR-D		Detectable, self-adhesive labels made of polyester with transparent protective laminate in roll format for equipment marking of components with rough, textured, and low-energy surfaces	136
EML-D		Detectable, self-adhesive, and prepunched labels made of polyester with high adhesive strength in roll format for equipment marking	136
EML-LT		Self-adhesive, prepunched labels made of polyester in roll format for equipment marking of components in refrigerated and frozen environments	137
EMLP		Self-adhesive, prepunched labels made of polyester in roll format for the identification of electrical components, equipment, and buttons	130
EMLS		Self-adhesive safety labels made of polyester with special adhesive in roll format for equipment marking, can be used as a rating plate or seal label	137
EMT		Sustainable identification for loading bins in logistics	134
Plant identification			
PML-W		Self-adhesive warning labels made of PVC (polyvinyl chloride) in roll format in accordance with ISO 7010	150
PML-M		Self-adhesive mandatory signs made of PVC (polyvinyl chloride) in roll format in accordance with ISO 7010	149
PML-P		Self-adhesive prohibition signs made of PVC (polyvinyl chloride) in roll format in accordance with ISO 7010	149

THERMOMARK E.300 (D) / E.600 (D)

THERMOMARK E.300 (D) / E.600 (D) thermal transfer printers

					
Type	Item no.	THERMOMARK E.300 1285306	THERMOMARK E.600 1285310	THERMOMARK E.300 D 1004303	THERMOMARK E.600 D 1004304
Description		Thermal transfer printer for printing all materials in roll format with a print resolution of 300 dpi. Suitable for long-term use in production and for large print volumes, as large rolls can also be processed.	Thermal transfer printer for printing all materials in roll format with a print resolution of 600 dpi. Suitable for long-term use in production and for large print volumes, as large rolls can also be processed.	Thermal transfer printer with internal rewriter for printing all materials in roll format with a print resolution of 300 dpi. Suitable for long-term use in production and for large print volumes, as large rolls can also be processed.	Thermal transfer printer with internal rewriter for printing all materials in roll format with a print resolution of 600 dpi. Suitable for long-term use in production and for large print volumes, as large rolls can also be processed.
Interfaces		10/100 Mbps Ethernet, USB 2.0, RS-232	10/100 Mbps Ethernet, USB 2.0, RS-232	10/100 Mbps Ethernet, USB 2.0, RS-232	10/100 Mbps Ethernet, USB 2.0, RS-232
Ambient temperature		5°C ... 40°C	5°C ... 40°C	5°C ... 40°C	5°C ... 40°C
Print resolution		300 dpi	600 dpi	300 dpi	600 dpi
Weight		10 kg	10 kg	10 kg	10 kg

Country-specific versions

US version		AR version		CN version		KIT version	
							
Type	Item no.	Type	Item no.	Type	Item no.	Type	Item no.
THERMOMARK E.300 US	1287021	THERMOMARK E.300 AR	1287022	THERMOMARK E.300 CN	1287020	THERMOMARK E.300 KIT	1287026
THERMOMARK E.600 US	1287029	THERMOMARK E.600 AR	1287030	THERMOMARK E.600 CN	1287028	THERMOMARK E.600 KIT	1287031
THERMOMARK E.300 D US	1287033	THERMOMARK E.300 D AR	1287034	THERMOMARK E.300 D CN	1287032	THERMOMARK E.300 D KIT	1287038
THERMOMARK E.600 D US	1287040	THERMOMARK E.600 D AR	1287041	THERMOMARK E.600 D CN	1287039	THERMOMARK E.600 D KIT	1287042

The devices with the abbreviations US, AR, and CN have country-specific power supply units:

Standard plug type F: Germany

US – plug type B: USA and Canada

CN – plug type I: China

AR – plug type I*: Argentina



KIT – no power cable included in the scope of supply

Accessories for THERMOMARK E.300 (D) / E.600 (D) printers

Accessories: Ink ribbons



	Type	THERMOMARK-RIBBON 110
	Item no.	5145384
Ink ribbon, for roll printers for printing product groups TML..., WML..., WML HF..., WML-FLAG..., EML..., EML-ESD..., EML-RM..., EML-HA..., EMLS..., EMLC..., EMLP..., and PMM..., roll length: 300 m, width: 110 mm, color: black		
	Type	TM-RIBBON 110 WH 100
	Item no.	0804661
Ink ribbon, for THERMOMARK roll printers and THERMOMARK CARD for printing material-off-the-roll product groups: EML ..., EMLP ..., EMLF ..., PML-M ..., WMTB HF-HP..., WMS-2 HF ... RD and US material product groups: US-EML(S)P ..., US-EMLP-HA ..., US-EM(S)P ..., US-WMT ..., US-WMTB ..., US-PML-M ..., US-EMLF ..., roll length: 60 m, width: 110 mm, color: white		
	Type	THERMOMARK-RIBBON 110-WMTB HF
	Item no.	5148007
Ink ribbon, for roll printers for printing product groups WMTB HF..., WMS-2 HF..., TMT..., EMT..., EMLF..., PML-..., roll length: 300 m, width: 110 mm, color: black		
	Type	THERMOMARK-RIBBON 110-WMSU
	Item no.	0801358
Ink ribbon, for roll printers for printing product groups WMS..., WMS-2 HF..., and WMTB HF-HP, roll length: 300 m, width: 110 mm, color: black		
	Type	THERMOMARK-RIBBON 64-WMSU WH
	Item no.	0801361
Ink ribbon, for roll printers for printing product group WMS... (black), roll length: 300 m, width: 64 mm, color: white		
	Type	TM-RIBBON 25 BK 102
	Item no.	1053499
Ink ribbon, for printing WMS-OT/WMS-2 HF... materials, roll length: 300 m, width: 25 mm, color: black		

Accessories: Pressure rollers



	Type	TRM-PRESSURE ROLLER STANDARD
	Item no.	0804655
Standard pressure roller		
	Type	TRM-PRESSURE ROLLER 4-50
	Item no.	0804656
Pressure roller for continuous shrink sleeve		

For more ink ribbons, visit our online shop

Accessories: Cutting unit

	Type	THERMOMARK E.CUTTER
	Item no.	1234241
Cutter for marking materials in continuous format for cutting custom lengths		
	Type	THERMOMARK E.CUTTER/P
	Item no.	1201336
Perforation cutter for all shrink sleeve and marking sleeve versions in continuous format for cutting custom lengths		



Accessories: Standard printer

	Type	TM E.300/E.600-TEAR OFF PLATE
	Item no.	1263118
Tear-off plate for all roll printers in the THERMOMARK E SERIES		
	Type	TM E.300/E.600-FRONT COVER
	Item no.	1285305
Front panel for all roll printers in the THERMOMARK E SERIES		

Accessories: Transportation

	Type	THERMOMARK ROLLMASTER-CASE
	Item no.	0804643
Transport case for THERMOMARK ROLLMASTER and THERMOMARK E SERIES printers		

Accessories: External media hubs

	Type	THERMOMARK ROLL-ERH
	Item no.	5146448
External media hub, for THERMOMARK ROLL, for outside roll diameter of 150 to 400 mm		
	Type	THERMOMARK-ERH 500
	Item no.	5146309
External media hub, for THERMOMARK ROLL, for outside roll diameter of up to 500 mm		

THERMOMARK E.300 DOUBLE

Thermal transfer printer for roll format

The THERMOMARK E.300 DOUBLE has been specifically developed for single-sided and double-sided marking of shrink sleeves and marking sleeves as well as for single-sided marking of prepunched

labels or continuous media. The marking system prints all materials off the roll with a print resolution of 300 dpi. The device is suitable for long-term industrial use as well as for the production of high

print volumes, as large rolls can also be processed.



Prepunched labels and materials in continuous format can be marked on one side. When used in combination with the THERMOMARK E.CUTTER cutting unit, continuous media can be cut to individual size.



Shrink sleeves and marking sleeves can be marked on both sides. When used in combination with the THERMOMARK E.CUTTER/P perforation cutter, shrink sleeves and marking sleeves in continuous format can be perforated.



Compatibility with the THERMOMARK E.SLEEVE means that shrink sleeves and marking sleeves can be marked on both sides and automatically applied to wires and cables in a single step.

Information about the THERMOMARK E.300 DOUBLE

Versatile thermal transfer roll printer

Benefit from the versatility of the THERMOMARK E.300 DOUBLE and optimize your industrial identification. Use the printer for single-sided or double-sided printing of Phoenix Contact materials off the roll for professional and durable wire and cable identification, equipment and plant identification, and terminal identification. In addition to prepunched label formats, the printer also processes shrink sleeves and marking sleeves as well as label material in continuous format. To do this, simply combine the printer with the THERMOMARK E.CUTTER or E.CUTTER/P for the convenient cutting or perforation of materials in continuous format.



Efficient single-sided and double-sided marking



The THERMOMARK E.300 DOUBLE offers the unique option of automated single-sided and double-sided marking of shrink sleeves and marking sleeves. Combine the standard printer with the THERMOMARK E.SLEEVE applicator for efficient printing and applying in just a single step. The printer display guides you intuitively through the identification process using project-supporting information. The efficient marking system enables time savings of up to 75% compared to manual marking and application processes with shrink sleeves and marking sleeves.



Your advantages

- ✔ Printing on both sides guarantees optimum legibility of the shrink sleeves and marking sleeves
- ✔ Compatible with the THERMOMARK E.SLEEVE: easily transform the standard printer into an efficient printing and application system
- ✔ Easy processing of all materials in continuous format by using THERMOMARK E.CUTTER and THERMOMARK E.CUTTER/P
- ✔ OPC UA supports the real-time bidirectional transfer of status messages to the marking software

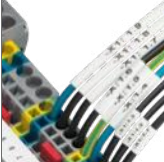
Possible applications of the thermal transfer printer

Possible applications			
Product group	Feature image	Description	Page
Terminal identification			
TMT...		Perforated terminal markers made of polyester in roll format for latching into a flat marking groove	97
Wire and cable identification			
WML		Durable, self-adhesive wrap-around labels made of PVC (polyvinyl chloride) with a transparent protective foil in roll format for marking wires and cables in indoor and outdoor installations	115
WML HF		Halogen-free, durable, and self-adhesive wrap-around labels made of PE (polyethylene) with a transparent protective foil in roll format for marking wires and cables	115
WML-FLAG		Self-adhesive labels suitable for double-sided printing made of polyolefin with cable marking flags in roll format for marking wires and cables	115
WMS		Halogen-free WMS marking sleeve made of polyolefin in ladder and continuous format for sliding onto wires and cables in accordance with UL 224 and CSA 22.2 with a shrink ratio of 3:1	116
WMS-2 HF		Halogen-free WMS-2 HF marking sleeve made of polyolefin in ladder and continuous format for sliding onto wires and cables in accordance with EN 45545-2 for the railway industry with a shrink ratio of 2:1	116
WMTB HF		Halogen-free WMTB HF cable markers made of PUR (polyurethane) in roll format for marking and bundling wires and cables by means of assembly with cable ties	113
WMTB HF-HP		Halogen-free WMTB HF-HP cable markers made of polyolefin in roll format for marking and bundling wires and cables by means of assembly with cable ties in accordance with EN 45545-2 for the railway industry	113
WMTS		Prepunched cable markers made of PET (polyethylene terephthalate) in roll format for insertion into marking tags from the PATG/PATO... system, easy mounting with threading and insertion aid	111
EMT		Prepunched insert labels made of polyester in roll format for KMK... marker carriers	111

THERMOMARK E.300 DOUBLE

Possible applications			
Product group	Feature image	Description	Page
Equipment identification			
EML		Self-adhesive, prepunched labels made of polyester in roll format for equipment marking	130
EML-HA		Self-adhesive, prepunched labels made of polyester in roll format for equipment marking of components with rough, textured, and low-energy surfaces	137
EML-LPR		Self-adhesive labels made of polyester with transparent protective laminate in roll format for equipment marking of components with rough, textured, and low-energy surfaces	137
EML-LPR-D		Detectable, self-adhesive labels made of polyester with transparent protective laminate in roll format for equipment marking of components with rough, textured, and low-energy surfaces	136
EML-D		Detectable, self-adhesive, and prepunched labels made of polyester with high adhesive strength in roll format for equipment marking	136
EML-LT		Self-adhesive, prepunched labels made of polyester in roll format for equipment marking of components in refrigerated and frozen environments	137
EMLS		Self-adhesive safety labels made of polyester with special adhesive in roll format for equipment marking, can be used as a rating plate or seal label	137
EMT		Sustainable identification for loading bins in logistics	134
Plant identification			
PML-W		Self-adhesive warning labels made of PVC (polyvinyl chloride) in roll format in accordance with ISO 7010	150
PML-M		Self-adhesive mandatory signs made of PVC (polyvinyl chloride) in roll format in accordance with ISO 7010	149
PML-P		Self-adhesive prohibition signs made of PVC (polyvinyl chloride) in roll format in accordance with ISO 7010	149



THERMOMARK E.300 DOUBLE

THERMOMARK E.300 DOUBLE thermal transfer printer



Type	Item no.	THERMOMARK E.300 DOUBLE	1472379
Description	Thermal transfer printer for single-sided and double-sided printing of materials in roll format with a print resolution of 300 dpi. Suitable for long-term use in production and for large print volumes, as large rolls can also be processed.		
Interfaces	10/100 Mbps Ethernet, USB 2.0, RS-232		
Ambient temperature	5°C ... 40°C		
Print resolution	300 dpi		
Weight	21 kg		



Accessories for the THERMOMARK E.300 DOUBLE printer

Accessories: Applicator and cutting unit		
	Type	THERMOMARK E.SLEEVE
	Item no.	1192932
Applicator for the efficient printing and applying of E-WMS... shrink sleeves and marking sleeves on wires and cables in just a single automated process step		
	Type	THERMOMARK E.CUTTER
	Item no.	1234241
Cutter for marking materials in continuous format for cutting custom lengths		
	Type	THERMOMARK E.CUTTER/P
	Item no.	1201336
Perforation cutter for all shrink sleeve and marking sleeve versions in continuous format for cutting custom lengths		

Accessories: Pressure rollers		
	Type	TM E.300 DOUBLE-PR
	Item no.	1660594
Pressure roller for the pressure system of the THERMOMARK E.300 DOUBLE		
	Type	TRM-PRESSURE ROLLER STANDARD
	Item no.	0804655
Standard pressure roller		
	Type	TRM-PRESSURE ROLLER 4-50
	Item no.	0804656
Pressure roller for continuous shrink sleeve		

Accessories: Ink ribbons		
	Type	THERMOMARK-RIBBON 110
	Item no.	5145384
Ink ribbon, for roll printers for printing product groups TML..., WML..., WML HF..., WML-FLAG..., EML..., EML-ESD..., EML-RM..., EML-HA..., EMLS..., EMLC..., EMLP..., and PMM..., roll length: 300 m, width: 110 mm, color: black		
	Type	THERMOMARK-RIBBON 110/50
	Item no.	0800687
Ink ribbon, for roll printers for printing product groups TML..., WML..., WML HF..., WML-FLAG..., EML..., EML-ESD..., EML-RM..., EML-HA..., EMLS..., EMLC..., EMLP..., and PMM..., roll length: 50 m, width: 110 mm, color: black		
	Type	THERMOMARK-RIBBON 110-WMS
	Item no.	5145397
Ink ribbon, length: 300 m, width: 110 mm, ink color: black (specifically for shrink sleeves)		
	Type	THERMOMARK-RIBBON 110-WMSU
	Item no.	0801358
Ink ribbon, for roll printers for printing product groups WMS..., WMS-2 HF..., and WMTB HF-HP, roll length: 300 m, width: 110 mm, color: black		
	Type	TM-RIBBON 40 BK 105
	Item no.	1259008
Ink ribbon, for the E-WMS... product group in combination with the THERMOMARK E.SLEEVE applicator and the WMS... and WMS-2 HF... product groups in combination with conventional roll printers, roll length: 300 m, width: 40 mm, color: black		

Accessories: Transportation		
	Type	TME.D-CARDBOARD BOX
	Item no.	1644890
Original packaging including inlay for safe transportation of the THERMOMARK E.300 DOUBLE printer		

Accessories: External media hubs		
	Type	THERMOMARK ROLL-ERH
	Item no.	5146448
External media hub, for THERMOMARK ROLL, for outside roll diameter of 150 to 400 mm		
	Type	THERMOMARK-ERH 500
	Item no.	5146309
External media hub, for THERMOMARK ROLL, for outside roll diameter of up to 500 mm		

Mobile printers

In addition to marking systems for stationary identification, Marking system also offers thermal transfer printers for mobile use directly on site in the application environment. With the integrated marking software and a high-performance battery, the THERMOMARK PRIME 2.0 is suitable for stand-alone use. The THERMOMARK GO SERIES mobile printers are flexible, compact companions for maintenance and repair work.



THERMOMARK PRIME 2.0

The THERMOMARK PRIME 2.0 mobile printer is not only suitable for desk-based use, it can also be used to mark materials in card and sheet format directly in the application environment.

➤ More information starting on page 50



THERMOMARK GO

With the THERMOMARK GO mobile label printer and Marking system app, you can create markings directly on site. The device processes continuous media as well as prepunched marking materials in convenient cartridge format.

➤ More information starting on page 56



THERMOMARK GO.K

The practical handheld thermal transfer printer is ideal for fast identification on site. Use the integrated keypad to mark shrink sleeves and marking sleeves, labels, and non-adhesive materials in convenient cartridge format.

➤ More information starting on page 62



THERMOMARK PRIME 2.0

Mobile thermal transfer printer

The THERMOMARK PRIME 2.0 offers an unrivaled combination of proven thermal transfer printing technology, integrated marking software, and an independent power supply.

The mobile printer marks all UCT, US, and UM card materials with a print resolution of 300 dpi. With automated ink ribbon, magazine, and material detection, identification is easy and error-free. The

thermal transfer printer can be used wherever you need it – whether as a fixed desktop device or out and about in the field.



With the THERMOMARK PRIME 2.0, you can mark UniCard materials (UCT) made of sturdy polycarbonate as well as UniSheet materials (US) made of various plastics quickly and easily.



The THERMOMARK PRIME 2.0 mobile thermal transfer printer allows you to create markings right where they will be used. It therefore saves you a great deal of time.



In stationary use, the printer can be easily controlled via the Marking system software. It features the integrated Marking system app for identification on site.

Information about the THERMOMARK PRIME 2.0

Flexible thermal transfer printer

The locations of use and requirements for industrial identification are as numerous as they are varied: from centrally organized industrial assembly to technical supply units. The THERMOMARK PRIME 2.0 mobile thermal transfer printer covers this variety with its wide range of marking materials in both card and sheet format. With integrated software and a high-performance battery, it is also suitable for stand-alone use directly on site, in addition to desktop operation.



Printing directly in the application environment

The THERMOMARK PRIME 2.0 allows you to create markings for terminal, wire and cable, equipment, and plant identification right where they will be used. With the integrated marking software and 7" color touch display with stand, operation is super easy. In addition to the intuitive user interface, the printer features replaceable, rechargeable high-performance batteries, making it ideal for mobile use.













Your advantages

- ✔ Versatile stand-alone printing system: fully independent thanks to replaceable and rechargeable battery
- ✔ Easy design of marking solutions with the Marking system app integrated marking software
- ✔ Material and ink ribbon can be changed easily in less than 10 s
- ✔ Automatic ink ribbon, magazine, and material detection prevents printing errors
- ✔ Fast and high-quality printing of all card materials in under 8 s

Possible applications of the thermal transfer printer

Possible applications			
Product group	Feature image	Description	Page
Terminal identification			
UCT-TM		Markers made of PC (polycarbonate) in sheet format for latching into terminal blocks with tall marking groove, can be marked with thermal transfer, UV inkjet, and laser technology	97
UCT-TMF		Markers made of PC (polycarbonate) in sheet format for latching into terminal blocks with flat marking groove, can be marked with thermal transfer, UV inkjet, and laser technology	96
UM...-TM...		Markers made of PC (polycarbonate) in strip format for latching into terminal blocks from other manufacturers with tall marking groove	Online shop
UM...-TMF...		Markers made of PC (polycarbonate) in strip format for latching into terminal blocks from other manufacturers with flat marking groove	
US-TML		Self-adhesive marking strips made of polyester in card format for marking terminal blocks without marking groove	98
Wire and cable identification			
UCT-WMTBA		Angled cable markers made of PC (polycarbonate) in sheet format for marking and bundling wires and cables by means of assembly with cable ties	112
UCT-WMCO		Wire markers made of PC (polycarbonate) in sheet format for subsequent marking by simply clipping onto wires and cables	118
UCT-WMT		Cable markers made of PC (polycarbonate) in sheet format for insertion into marking tags from the PATG (HF) / PATO... system	110
UCT-WMS		Wire markers made of PC (polycarbonate) in sheet format for sliding onto wires and cables	119
US-WML		Durable, self-adhesive wrap-around labels made of PVC (polyvinyl chloride) with a transparent protective foil in card format for marking wires and cables in indoor and outdoor installations	115
US-WMTB		Cable markers made of PVC (polyvinyl chloride) in card format for marking and bundling wires and cables by means of assembly with cable ties	113
US-WMT		Prepunched cable markers made of PVC (polyvinyl chloride) in card format for insertion on wires and cables with marking tags from the PATG / PATO... system	113

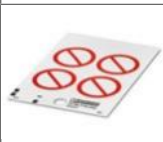
THERMOMARK PRIME 2.0

Possible applications			
Product group	Feature image	Description	Page
Equipment identification			
UCT-EM		Snap-in markers made of PC (polycarbonate) in sheet format for latching into a marking groove	134
US-EML		Self-adhesive, prepunched labels made of polyester in card format for the identification of components and equipment	130
US-EMLF		Self-adhesive, prepunched, and highly flexible labels made of PVC (polyvinyl chloride) in card format for equipment marking in indoor and outdoor installations	131
US-EMT		Prepunched snap-in markers made of polyester in card format for the identification of Siemens S7-300 controllers	134
US-EMLP		Self-adhesive device markers made of PVC (polyvinyl chloride) in card format for the identification of components and equipment	130
US-EMLP-HA		Self-adhesive labels made of PVC (polyvinyl chloride) with high adhesive strength in card format for equipment marking of components with rough, textured, and low-energy surfaces	138
US-EMP		Snap-in markers made of PVC (polyvinyl chloride) in card format for latching into existing CARRIER-EMP... marker carriers	134
US-EMSP		Individual markers in card format made of PVC (polyvinyl chloride) for screwing or riveting for equipment marking	132
Plant identification			
US-PML-ESS		Self-adhesive labels made of PVC (polyvinyl chloride) in card format for the identification of emergency stop buttons	153
US-PML-P		Self-adhesive prohibition signs made of PVC (polyvinyl chloride) in card format in accordance with ISO 7010	149
US-PML-W		Self-adhesive warning labels made of PVC (polyvinyl chloride) in card format in accordance with ISO 7010	150

THERMOMARK PRIME 2.0

THERMOMARK PRIME 2.0 thermal transfer printer



Type	Item no.	THERMOMARK PRIME 2.0	1472405
Description	Thermal transfer printer for printing card materials with a print resolution of 300 dpi. Suitable for stationary as well as mobile use thanks to a 7" color touch display with integrated "Marking system app" and a replaceable battery pack.		
Interfaces	10/100 Mbps Ethernet, USB 2.0		
Ambient temperature	5°C ... 40°C		
Print resolution	300 dpi		
Weight	6 kg		

Country-specific versions

US version		AR version		CN version		KIT version	
Type	Item no.	Type	Item no.	Type	Item no.	Type	Item no.
THERMOMARK PRIME 2.0 US	1472410	THERMOMARK PRIME 2.0 AR	1472408	THERMOMARK PRIME 2.0 CN	1472406	THERMOMARK PRIME 2.0 KIT	1472413

The devices with the abbreviations US, AR, and CN have country-specific power supply units:

Standard plug type F: Germany

US – plug type B: USA and Canada

CN – plug type I: China

AR – plug type I*: Argentina

KIT – no power cable included in the scope of supply



Accessories for the THERMOMARK PRIME 2.0



Accessories: Magazines		
	Type	TMP-UCT-MAG1
	Item no.	0803342
	Magazine, for THERMOMARK PRIME and THERMOMARK CARD, for holding UCT-TM..., UCT1(U)-TM..., UCT5-TM..., UCT-EM (5x10), UCT-EM (6x10), length: 0.166 m, width: 114 mm, height: 11.5 mm	
	Type	TMP-US-MAG1
	Item no.	0803341
	Magazine, for THERMOMARK CARD and THERMOMARK PRIME, for holding US cards, length: 0.166 m, width: 114 mm, height: 10 mm	
	Type	TMP-UM-MAG1
	Item no.	0831200
	Magazine for THERMOMARK CARD and THERMOMARK PRIME, for holding UM material (UM1-TM and UM5-TM)	

Accessories: Ink ribbons		
	Type	TMP-RIBBON 110 WH 100
	Item no.	0803376
	Ink ribbon cartridge, for THERMOMARK PRIME for printing product groups US(2)-TM(F)..., US-TM(F)L..., US-WMT(B)..., US-EML(F)..., US-EML(S)P..., US-EMLP-HA..., US-EM(S)P..., US-EML-RS..., US-PML..., roll length: 60 m, width: 110 mm, color: white	
	Type	TMP-RIBBON 110 BK 100
	Item no.	0803374
	Ink ribbon cartridge, for THERMOMARK PRIME for printing product groups UCT..., US..., and UM..., roll length: 70 m, width: 110 mm, color: black	
	Type	TMP-RIBBON 110 BK 101
	Item no.	0803714
	Ink ribbon cartridge, for THERMOMARK PRIME for printing product groups US(2)-TM(F)..., US-TM(F)L..., US-WMTB..., US-EML..., US-EML(S)P..., US-EMLP-HA..., US-EM(S)P..., US-EML-RS..., roll length: 60 m, width: 110 mm, color: black	

Accessories: Cleaning		
	Type	CLEANING STICK
	Item no.	5146697
	Cleaning stick for fast and efficient printhead cleaning of all Phoenix Contact thermal transfer printers.	

For more magazines and ink ribbons, visit our online shop

Accessories: Battery / charger		
	Type	TMP/EXT.POWER-SUPPLY 100-240V
	Item no.	0803672
	Replacement power supply unit for THERMOMARK PRIME, input voltage from 100 V AC ... 240 V AC/1.5 A/50 Hz ... 60 Hz, output voltage: 24 V DC/4.16 A	
	Type	TMP/ACCU
	Item no.	0803668
	Replacement battery for THERMOMARK PRIME, NiMH 18 V DC, 2.1 Ah	
	Type	TMP/ACCU COVER
	Item no.	0803669
	The battery compartment cover provides protection against dust and dirt deposits when starting up the THERMOMARK PRIME without the battery using the mains connection	

Accessories: Transportation		
	Type	TMP CASE
	Item no.	0803675
	Transport case for THERMOMARK PRIME including accessories, marking materials, and consumables. Rounded profile case with aluminum frame, unequipped	
	Type	MOBILE BACKPACK
	Item no.	0803717
	Transport backpack for THERMOMARK PRIME including accessories, marking materials, and consumables, unequipped	
	Type	TMP BAG
	Item no.	0803674
	Transport bag for THERMOMARK PRIME including accessories, marking materials, and consumables, unequipped	

THERMOMARK GO

THERMOMARK GO mobile printer

Create your labels easily and wherever you need them: Control the THERMOMARK GO mobile label printer from your smart device via the Marking system app. Create

markings for numerous applications with flexibility directly in the industrial environment.



The material in practical cartridge format combines an ink ribbon and material for fast changeovers and flexible use on site.



The Marking system app features a mobile interface for the smart selection and creation of marking files. It has functions that are specifically optimized for mobile use.



Everything with you on the go and always to hand: transport the printer and accessories safely and conveniently in the practical shoulder bag or in the proven L-BOXX system.

Information about the THERMOMARK GO

Mobile thermal transfer printer

With modern interfaces, a host of applications, and automatic material detection, the THERMOMARK GO creates high-quality marking solutions. In addition to continuous media, it also processes practical prepunched marking materials for terminal, wire and cable, equipment, and plant identification. Along with the Marking system app, the printer can also be controlled via the marking software. With its compact dimensions and robust design, the THERMOMARK GO is ideally suited for mobile use in industrial environments.



Professional marking on site

Use the Marking system app to control the THERMOMARK GO easily from your iOS or Android device. Connect your smart device to the label printer via Bluetooth or alternatively use the NFC interface to directly and conveniently start the app. The Marking system app guides you through the entire printing process. It helps you create and print the perfect marking solution right where the marking is needed.







Your advantages

- ✔ Identification on site: the printer can be controlled entirely from a smartphone or tablet
- ✔ Modern interfaces: connect to your smart device wirelessly via Bluetooth and simply start the Marking system app via NFC
- ✔ User-friendly operation with context-based menu navigation of the Marking system app and Application Wizards for easily creating application-specific marking solutions
- ✔ Alternative control via the Marking system desktop software

Possible applications of the thermal transfer printer

Possible applications			
Product group	Feature image	Description	Page
Terminal identification			
MM-TML		Self-adhesive marking strips made of polyester in cartridge format for marking terminal blocks without marking groove	99
MM-TMT		Labels in cartridge format made of polyester for latching into terminal blocks with tall and flat marking groove / universal marker groove	99
Wire and cable identification			
MM-WML		Durable, self-adhesive wrap-around label made of vinyl polymer with a transparent protective foil in cartridge format for marking wires and cables	117
MM-WML-FLAG		Self-adhesive label suitable for double-sided printing with cable marking flags made of polyolefin in cartridge format for marking wires and cables	117
MM-WMS		Halogen-free marking sleeve made of polyolefin in cartridge format for sliding onto wires and cables in accordance with UL 224 and CSA 22.2 with a shrink ratio of 3:1	117
MM-WMS-2		Halogen-free marking sleeve made of polyolefin in cartridge format for sliding onto wires and cables in accordance with UL 224, CSA 22.2, and EN 45545-2 with a shrink ratio of 2:1	117
MM-WMTB HF		Halogen-free cable marker made of PUR (polyurethane) in cartridge format for marking and bundling wires and cables by means of assembly with cable ties	117
MM-WMTB		Cable marker made of polyester in cartridge format for marking and bundling wires and cables by means of assembly with cable ties	118
MM-WMT		Prepunched cable marker made of polyester in cartridge format for threading onto wires and cables	118
MM-EMT		Prepunched insert label made of polyester in cartridge format for KMK... marker carriers	142

THERMOMARK GO

Possible applications			
Product group	Feature image	Description	Page
Equipment identification			
MM-EML		Self-adhesive labels made of polyester in cartridge format for equipment marking (prepunched labels and labels in continuous format)	142
MM-EMLF		Self-adhesive, highly flexible labels made of vinyl polymer in cartridge format for equipment marking	142
MM-EMLC		Self-adhesive, highly flexible labels made of fabric film (polyamide) in cartridge format for equipment marking	142
Plant identification			
MM-EML		Self-adhesive labels made of polyester in cartridge format for creating inspection labels using templates in the Marking system app	156



THERMOMARK GO



THERMOMARK GO thermal transfer printer



Type	Item no.	THERMOMARK GO 1090747	THERMOMARK GO SET 1221548
Description	Mobile thermal transfer printer for marking materials in cartridge format incl. accessories. The printer can print prepunched labels as well as materials in continuous format up to a material width of 24 mm.		Mobile thermal transfer printer for marking materials in cartridge format incl. accessories in a practical case from the proven L-BOXX system. The printer can print prepunched labels as well as materials in continuous format up to a material width of 24 mm.
Interfaces	USB, Bluetooth		USB, Bluetooth
Ambient temperature	5°C ... 40°C		5°C ... 40°C
Print resolution	203 dpi		203 dpi
Weight	743 g		3411 g

Accessories for the THERMOMARK GO

Accessories: Transportation		
	Type	THERMOMARK GO CASE
	Item no.	1229456
<p>Practical and robust case for storing the THERMOMARK GO and THERMOMARK GO.K mobile printers as well as accessories. The case offers space for 9 material cartridges and maximum flexibility for all transport situations with the proven L-BOXX system.</p>		
	Type	THERMOMARK GO BAG
	Item no.	1229457
<p>Flexible shoulder bag and belt pouch for the THERMOMARK GO mobile printer. Additional pockets provide space for a smartphone and materials.</p>		

Accessories: Battery / charger		
	Type	THERMOMARK GO ACCU
	Item no.	0805009
<p>Battery for mobile operation of the THERMOMARK GO and THERMOMARK GO.K / THERMOFOX printers.</p>		
	Type	THERMOMARK GO CHARGER
	Item no.	0805012
<p>Charging dock for charging the THERMOMARK GO ACCU battery (0805009), which is required for mobile operation of the THERMOMARK GO and THERMOMARK GO.K / THERMOFOX printers.</p>		
	Type	THERMOMARK GO ADAPTER
	Item no.	0805010
<p>Power supply unit incl. 4 adapters for operating the THERMOMARK GO and THERMOMARK GO.K / THERMOFOX printers.</p>		

THERMOMARK GO.K

THERMOMARK GO.K handheld printer

The THERMOMARK GO.K handheld printer is ideal for fast identification on site. It is robust, easy to use, and offers versatile functions. The thermal transfer printer processes continuous media for terminal,

wire and cable, equipment, and plant marking.

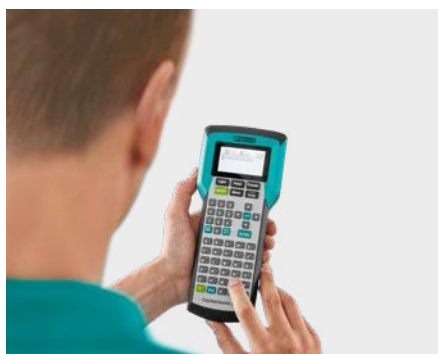

Easy operation via the practical keypad: the printer input field prioritizes frequently used characters and offers a large selection of special characters as well as barcode types.



The material in practical cartridge format combines an ink ribbon and material for fast changeovers and flexible use on site in your application.



Everything with you on the go and always to hand: transport the printer and accessories safely and conveniently in the shoulder bag, on the practical belt clip, or in the proven L-BOXX system.

Information about the THERMOMARK GO.K

Handheld thermal transfer printer

The identification of equipment and systems frequently has to be done spontaneously without prior planning during service and maintenance. An especially flexible and mobile solution for creating markings is required during maintenance repair overhauls (MRO). This is where the THERMOMARK GO.K comes in. The practical handheld thermal transfer printer with integrated keypad processes shrink sleeves, labels, and non-adhesive materials in continuous format.



Easy handling, full flexibility







Always there when you need it. The THERMOMARK GO.K handheld printer is ideal for fast identification on site. It is characterized by its easy handling and robust design. You can enter the print data intuitively via the keypad, and there is also a wide range of special characters, symbols, and barcode types available. Automatic material detection helps ensure that markers are formatted to fit and can be cut to a custom size using the cutter. You can also save up to 20 marking projects on the device.



Your advantages

- ✔ Processing of shrink sleeves, labels, and non-adhesive materials
- ✔ Intelligent keypad allows special characters, symbols, barcodes, and serial numbers to be integrated
- ✔ Optimum print settings with automatic material detection
- ✔ Easy exchange of marking data via connection to the marking software
- ✔ Quick and easy material changeover with the combined material and ink ribbon cartridge

Possible applications of the thermal transfer printer

Possible applications			
Product group	Feature image	Description	Page
Terminal identification			
MM-TML		Self-adhesive marking strips made of polyester in cartridge format for marking terminal blocks without marking groove	99
MM-TMT		Labels in cartridge format made of polyester for latching into terminal blocks with tall and flat marking groove / universal marker groove	99
Wire and cable identification			
MM-WML		Durable, self-adhesive wrap-around label made of vinyl polymer with a transparent protective foil in cartridge format for marking wires and cables	117
MM-WMS		Halogen-free marking sleeve made of polyolefin in cartridge format for sliding onto wires and cables in accordance with UL 224 and CSA 22.2 with a shrink ratio of 3:1	117
MM-WMS-2		Halogen-free marking sleeve made of polyolefin in cartridge format for sliding onto wires and cables in accordance with UL 224, CSA 22.2, and EN 45545-2 with a shrink ratio of 2:1	117
MM-EMT		Prepunched insert label made of polyester in cartridge format for KMK... marker carriers	142

THERMOMARK GO.K



1

2

3

4

Marking systems

Possible applications			
Product group	Feature image	Description	Page
Equipment identification			
MM-EML		Self-adhesive labels made of polyester in cartridge format for equipment marking (prepunched labels and labels in continuous format)	142
MM-EMLF		Self-adhesive, highly flexible labels made of vinyl polymer in cartridge format for equipment marking	142
MM-EMLC		Self-adhesive, highly flexible labels made of fabric film (polyamide) in cartridge format for equipment marking	142

THERMOMARK GO.K



THERMOMARK GO.K thermal transfer printer



Type	Item no.	THERMOMARK GO.K	1184146	THERMOMARK GO.K SET	1184148
Description		Mobile thermal transfer printer for marking materials in cartridge format. The printer can print materials in continuous format up to a material width of 24 mm.		Mobile thermal transfer printer for marking materials in cartridge format incl. accessories in a practical case from the proven L-BOXX system. The printer can print materials in continuous format up to a material width of 24 mm.	
Interfaces		USB		USB	
Ambient temperature		5°C ... 40°C		5°C ... 40°C	
Print resolution		203 dpi		203 dpi	
Weight		667 g		3390 g	

Accessories for the THERMOMARK GO.K

Accessories: Transportation		
	Type	THERMOMARK GO.K BAG
	Item no.	0805003
	Shoulder bag for storing the THERMOMARK GO.K / THERMOFOX mobile printer as well as necessary accessories	
	Type	THERMOMARK GO CASE
	Item no.	1229456
	Practical and robust case for storing the THERMOMARK GO and THERMOMARK GO.K mobile printers as well as accessories. The case offers space for 9 material cartridges and maximum flexibility for all transport situations with the proven L-BOXX system.	
	Type	THERMOMARK GO.K MAGNET HOLDER
	Item no.	0805008
	Magnetic holder for mounting the THERMOMARK GO.K / THERMOFOX mobile printer on metal surfaces, such as a control cabinet.	
	Type	THERMOMARK GO.K BELT CLIP
	Item no.	0805004
	Clip for fastening the THERMOMARK GO.K / THERMOFOX mobile printer to a belt.	

Accessories: Battery / charger		
	Type	THERMOMARK GO ACCU
	Item no.	0805009
	Battery for mobile operation of the THERMOMARK GO and THERMOMARK GO.K / THERMOFOX printers.	
	Type	THERMOMARK GO CHARGER
	Item no.	0805012
	Charging dock for charging the THERMOMARK GO ACCU battery (0805009), which is required for mobile operation of the THERMOMARK GO and THERMOMARK GO.K / THERMOFOX printers.	
	Type	THERMOMARK GO ADAPTER
	Item no.	0805010
	Power supply unit incl. 4 adapters for operating the THERMOMARK GO and THERMOMARK GO.K / THERMOFOX printers.	

Marking plotter and engraving unit

Use the plotter to mark a variety of plastic materials for professional identification. By simply swapping the standard plotter head with the engraving unit, you can convert the plotter into an engraving system. Markings created with this system are very durable even under extreme conditions.

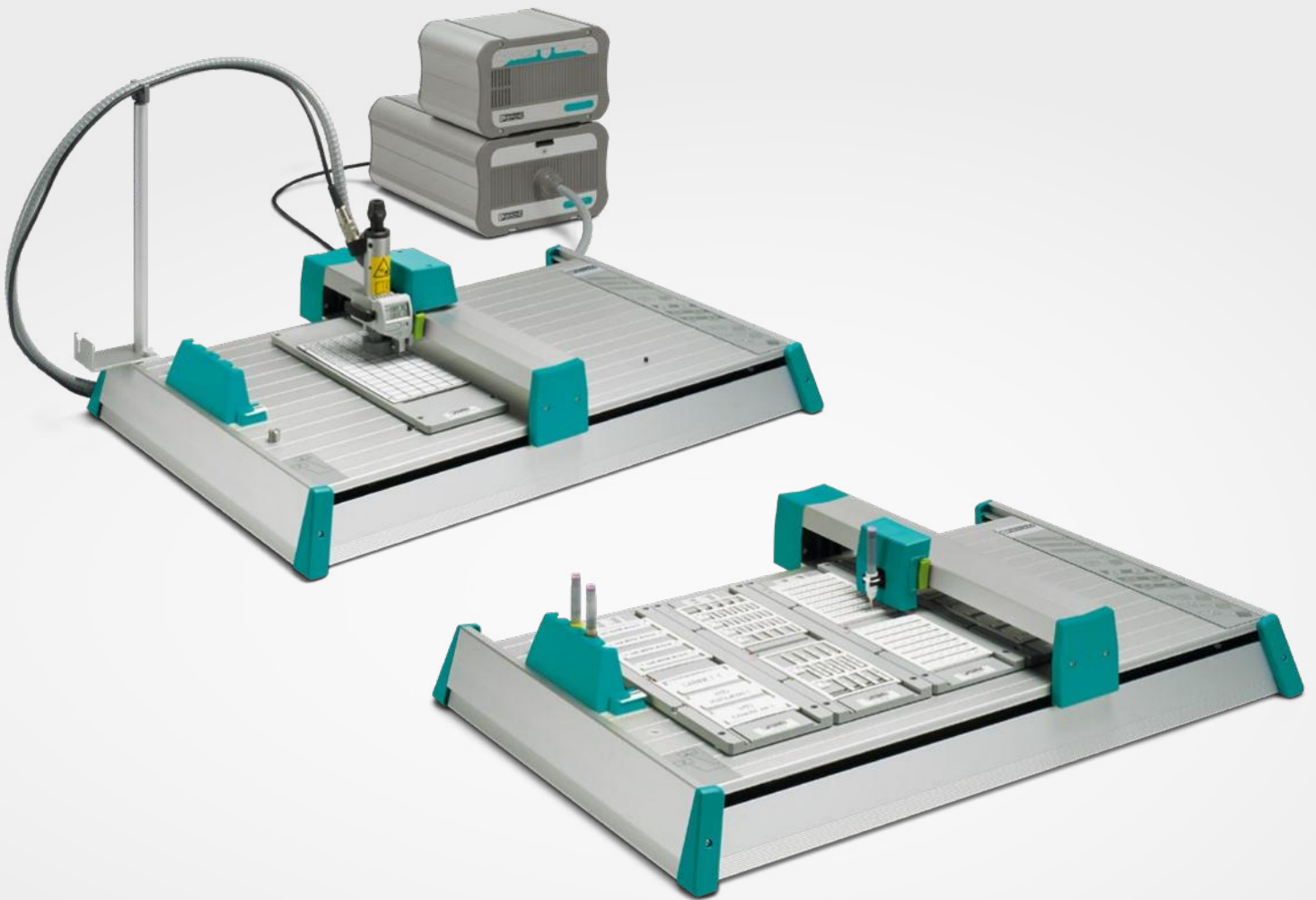

Information about the PLOTMARK and the ENGRAVING UNIT

PLOTMARK marking plotter

The PLOTMARK enables you to produce durable markings. To do this, materials are placed in robust plastic magazines and optimally marked with the aid of an automatic marking preparation function. The plotter pens produce smudge-proof and high-quality marking results.

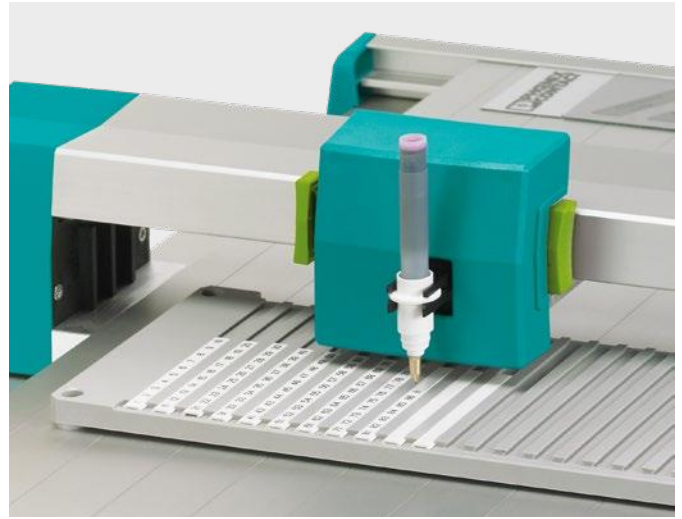

ENGRAVING UNIT

The PLOTMARK can be converted into an engraving unit quickly and easily by swapping the plotter head for the engraving device. Engraving chisels are available with diameters ranging from 0.2 to 1.0 mm for creating different line thicknesses. You can thus create durable plastic labels for equipment and plant identification.











Your advantages

- ✓ The automatic marking preparation function ensures optimum marking results even after downtime
- ✓ Comprehensive product portfolio for terminal, wire and cable, equipment, and plant identification
- ✓ Quick and easy connection to PC via USB interface
- ✓ The device is controlled via the Marking system software

Possible applications for the PLOTMARK and the ENGRAVING UNIT

Possible applications				
Product group	Feature image	Can be marked using	Description	Page
Terminal identification				
UC-TM		PLOTMARK	Markers made of PA (polyamide) in sheet format for latching into terminal blocks with tall marking groove	97
UC-TMF		PLOTMARK	Markers made of PA (polyamide) in sheet format for latching into terminal blocks with flat marking groove	96
UC-TMN		PLOTMARK	Markers made of PA (polyamide) in sheet format for insertion into terminal blocks with marking stud holder and tall marker grooves	98
ZB		PLOTMARK	Zack marker strips made of PA (polyamide) for latching into terminal blocks with tall marking grooves	100
ZBF		PLOTMARK	Zack marker strips made of PA (polyamide) for latching into terminal blocks with flat marking grooves	100
SK		PLOTMARK	Self-adhesive marking strips made of polyester in card format for terminal blocks without marker groove	Online shop
Wire and cable identification				
UC-WMT		PLOTMARK	Cable markers made of PA (polyamide) in sheet format for insertion on wires and cables with marking tags from the PATG (HF)/PATO... system	110
UC-WMC		PLOTMARK	Markers made of PA (polyamide) in sheet format for clipping onto wires and cables, even after wiring has already been completed	118
PABA		PLOTMARK	Cable markers in strip format for insertion on wires and cables with marking tags from the PATG (HF)/PATO... system	Online shop
PABL		PLOTMARK	Prepunched insert strips in DIN A4 sheet format for insertion into marking tags from the PATG (HF)/PATO... system	119



Possible applications				
Product group	Feature image	Can be marked using	Description	Page
		Plotter		
Wire and cable identification				
UC-WMTBA		PLOTMARK	Angled cable marker made of PA (polyamide) in sheet format for marking and bundling wires and cables by means of assembly with cable ties	112
UC-WMTB		PLOTMARK	Cable marker made of PA (polyamide) in sheet format for marking cables by means of assembly with cable ties	112
WML...A4		PLOTMARK	Durable, self-adhesive wrap-around label with a transparent protective foil in DIN A4 sheet format for marking wires and cables in indoor and outdoor installations	119
Equipment identification				
ESL		PLOTMARK	Plastic labels in DIN A4 sheet format for equipment and cable marking using marker carriers	119
GPE		PLOTMARK ENGRAVING UNIT	Self-adhesive plastic labels in sheet format for equipment marking	143
GPA/SK + GPK/SK		ENGRAVING UNIT	Self-adhesive engraving material made of plastic, which can be ordered in various color combinations	143
GPA/GPK		ENGRAVING UNIT	Engraving material made of plastic, which can be ordered in various color combinations	143
UC-EM		PLOTMARK	Snap-in markers made of PA (polyamide) in sheet format for latching into marker carriers for equipment marking	134
UC-EMP		PLOTMARK	Snap-in markers made of PA (polyamide) in sheet format for latching into existing CARRIER-EMP... label frames	134
UC-EMLP		PLOTMARK	Self-adhesive device markers made of PA (polyamide) in sheet format with high adhesive strength	131
BMKL		PLOTMARK	Self-adhesive labels in DIN A4 sheet format for equipment marking	Online shop

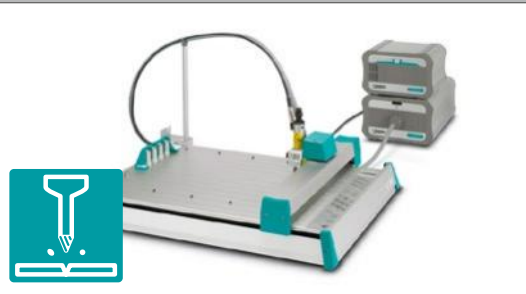

PLOTMARK and ENGRAVING UNIT



Plotter and engraving systems

		
Type	Item no. PLOTMARK 0804499	ENGRAVING UNIT 0804500
Description	Marking plotter for the entire portfolio of UC marking materials and materials in sheet and strip format.	Engraving unit in combination with PLOTMARK marking plotter for the entire portfolio of GPE, GPA, and GPK plastic materials.
Interfaces	USB 2.0	USB 2.0
Ambient temperature	10°C ... 35°C	10°C ... 35°C
Print resolution	0.01 mm	0.01 mm
Weight	8 kg	7.6 kg

Accessories for the PLOTMARK and the ENGRAVING UNIT



Accessories: PLOTMARK		
	Type	CMS-P1-PREPLATES
	Item no.	5145135
50 marking preparation plates for the pen station of the plotter systems		
	Type	CMS-P1-PENDEPOT
	Item no.	5144835
4 replacement seals for the pen station of the plotter systems and 10 marking preparation plates		



Accessories: Cleaning		
	Type	CMS-R-SET-TR
	Item no.	5146751
Cleaning set, consisting of: 1x cleaning cup, 2x cleaning cartridges with 10 ml cleaning fluid each, and 2x replacement sealing caps for the CMS-PEN ... and CMS-DISPOSABLE-PEN ...		
	Type	CMS-R-FLUID-TR-C2
	Item no.	5146752
Cleaning cartridges with replacement sealing caps, 2 cartridges with 10 ml cleaning fluid each and 2 caps for the CMS-PEN ... and CMS-DISPOSABLE-PEN ...		
	Type	CMS-R-FLUID-TR
	Item no.	5146750
Cleaning fluid, 30 ml, for the CMS-PEN ... and CMS-DISPOSABLE-PEN ...		

Accessories: Magazines		
	Type	P1 UC-MAG 1
	Item no.	5146079
Magazine, for CMS-P1-PLOTTER and PLOTMARK, for holding UC-TM..., UC-TMN..., UC-WMC 3,1..., UC-WMTBA...		
	Type	CMS-P1-M/ZB
	Item no.	5144699
Plastic magazines for CMS-P1-PLOTTER and PLOTMARK. For holding 22 zack marker strips.		
	Type	CMS-P1-PAD
	Item no.	5144819
Plastic magazine for CMS-P1-PLOTTER and PLOTMARK, for holding sheet material, self-adhesive mat for fixing labels, films, and paper, sheet size max. DIN A4.		

Accessories for the PLOTMARK and the ENGRAVING UNIT

Accessories: Marker pens		
	Type	CMS-INK-TR-C5
	Item no.	5146684
	Ink cartridge, special black ink, 5 cartridges of 1 ml each, for high demands	
	Type	CMS-PEN 0,25
	Item no.	5067815
	Pen, incl. adapter, ink reservoir, and pen station, line thickness: 0.25 mm	
	Type	CMS-PEN 0,35
	Item no.	5067828
	Pen, incl. adapter, ink reservoir, and pen station, line thickness: 0.35 mm	
	Type	P-PEN
	Item no.	0815211
	Disposable pen, non-refillable, for manual marking, can also be used for plotter marking in combination with the P-PEN ADAPTER, line thickness: 0.1 mm	
	Type	CMS-DISPOSABLE-PEN 0,25 TR
	Item no.	5146685
	Disposable pen, incl. adapter, integrated ink cartridge, and pen station, line thickness: 0.25 mm	
	Type	CMS-DISPOSABLE-PEN 0,35 TR
	Item no.	5146686
	Disposable pen, incl. adapter, integrated ink cartridge, and pen station, line thickness: 0.35 mm	

Accessories: ENGRAVING UNIT		
	Type	P1 ENGRAVING CONTROLLER
	Item no.	5145698
	Control unit for the ENGRAVING UNIT and P1 ENGRAVING UNIT engraving systems	
	Type	P1 ENGRAVING VC
	Item no.	5145708
	Suction unit for the ENGRAVING UNIT and P1 ENGRAVING UNIT engraving systems	

Accessories: Engraving chisel		
	Type	P1 GRAVER 0.5
	Item no.	5145504
	Engraving chisel with a point angle of 15°, point diameter: 0.5 mm	
	Type	P1 GRAVER 1.0
	Item no.	5145520
	Engraving chisel with a point angle of 15°, point diameter: 1.0 mm	

Accessories for the PLOTMARK and the ENGRAVING UNIT

Accessories: PLOTMARK with ENGRAVING UNIT		
	Type	P1 ENGRAVING CC1
	Item no.	5145591
	Replacement connecting cable between suction unit and control unit	
	Type	P1 ENGRAVING CC2
	Item no.	5145614
	Replacement connecting cable between control unit and marking plotter	
	Type	P1 ENGRAVING CC3
	Item no.	5145672
	Replacement connecting cable set, consisting of: 1x connecting cable between suction unit and control unit, 1x connecting cable between control unit and engraving spindle	
	Type	P1 ENGRAVING CORD
	Item no.	5145627
	Replacement power cable for the control unit	
	Type	P1 ENGRAVING TUBE
	Item no.	5145601
	Replacement suction tube and clamping piece for the suction unit	
	Type	P1 ENGRAVING VC PLUG
	Item no.	5145630
	Replacement adapter as connection between suction tube and engraving spindle	
	Type	P1 ENGRAVING CB
	Item no.	5145588
	Replacement counter bearing for horizontal alignment of the engraving head for the ENGRAVING UNIT	
	Type	P1 ENGRAVING CH
	Item no.	5145643
	Replacement set, consisting of: 1x stand tube, 1x clamping piece, 1x mounting bracket for fixing the suction tube and the connecting cable	

Automated industrial identification

All work processes throughout the product lifecycle of a control cabinet can be performed more efficiently if all the components are uniformly and clearly marked. Up to 30% of the total production time of a control cabinet is spent just printing, separating, and mounting marking material. The THERMOMARK E SERIES combines these work steps into a single automated process step, thus providing time savings of up to 60%.

THERMOMARK E.300 (D) / E.600 (D)



THERMOMARK E.SLEEVE



THERMOMARK E.WRAP

THERMOMARK E.VARIO



THERMOMARK E.WIRE

The modular system for maximum efficiency



THERMOMARK E.300 (D) / E.600 (D)

Combine one of the thermal transfer roll printers with one of the applicators. In just a few steps, the system is ready for the desired identification task. You can choose between a print resolution of 300 or 600 dpi. The D version of the printers has an integrated take-up hub and is compatible with all four applicators.



THERMOMARK E.WIRE

The THERMOMARK E.WIRE marks wires and cables with a radially and axially movable marking that can be marked on three sides. The heat-sealed joint ensures that the marker remains captive. Thanks to the continuous format, all diameters between 1.8 and 5.6 mm are marked with just one material. The cable diameter is measured automatically. Based on this measurement, the software helps determine the optimum size of the marker.



THERMOMARK E.SLEEVE

The THERMOMARK E.SLEEVE processes shrink sleeves in continuous format and cuts them individually to the desired length. In addition, the applicator opens the shrink sleeve so that it can be easily slid onto wires and cables ranging from 0.8 to 8.5 mm in diameter. Thanks to automatic object detection by means of photoelectric barriers, you can remove ready marked cables very effectively.



THERMOMARK E.WRAP

The THERMOMARK E.WRAP automatically applies wire-wrap labels to cylindrical objects that are between 2 and 16 mm in diameter. A transparent laminate covers the printed area and protects it completely from external influences. To make handling as easy as possible, the device features an adjustable scale. This ensures that the marking is always attached at the desired distance from the cable end.







THERMOMARK E.VARIO





The THERMOMARK E.VARIO marks entire terminal strips with just two materials in continuous format, regardless of the number of different pitches. This means that any pitch between 3.5 and 1,000 mm can be implemented. Thanks to the innovative geometry of the marking material, you benefit from the material fitting perfectly in the marking groove.

Automated industrial identification – THERMOMARK E SERIES

THERMOMARK E SERIES thermal transfer printers

					
Type	Item no.	THERMOMARK E.300 1285306	THERMOMARK E.600 1285310	THERMOMARK E.300 D 1004303	THERMOMARK E.600 D 1004304
Description		Thermal transfer printer for printing all materials in roll format with a print resolution of 300 dpi. Suitable for long-term use in production and for large print volumes, as large rolls can also be processed.	Thermal transfer printer for printing all materials in roll format with a print resolution of 600 dpi. Suitable for long-term use in production and for large print volumes, as large rolls can also be processed.	Thermal transfer printer with internal rewinder for printing all materials in roll format with a print resolution of 300 dpi. Suitable for long-term use in production and for large print volumes, as large rolls can also be processed.	Thermal transfer printer with internal rewinder for printing all materials in roll format with a print resolution of 600 dpi. Suitable for long-term use in production and for large print volumes, as large rolls can also be processed.
Interfaces		10/100 Mbps Ethernet, USB 2.0, RS-232	10/100 Mbps Ethernet, USB 2.0, RS-232	10/100 Mbps Ethernet, USB 2.0, RS-232	10/100 Mbps Ethernet, USB 2.0, RS-232
Ambient temperature		5°C ... 40°C	5°C ... 40°C	5°C ... 40°C	5°C ... 40°C
Print resolution		300 dpi	600 dpi	300 dpi	600 dpi
Weight		10 kg	10 kg	10 kg	10 kg

Country-specific versions

US version		AR version		CN version		KIT version	
							
Type	Item no.	Type	Item no.	Type	Item no.	Type	Item no.
THERMOMARK E.300 US	1287021	THERMOMARK E.300 AR	1287022	THERMOMARK E.300 CN	1287020	THERMOMARK E.300 KIT	1287026
THERMOMARK E.600 US	1287029	THERMOMARK E.600 AR	1287030	THERMOMARK E.600 CN	1287028	THERMOMARK E.600 KIT	1287031
THERMOMARK E.300 D US	1287033	THERMOMARK E.300 D AR	1287034	THERMOMARK E.300 D CN	1287032	THERMOMARK E.300 D KIT	1287038
THERMOMARK E.600 D US	1287040	THERMOMARK E.600 D AR	1287041	THERMOMARK E.600 D CN	1287039	THERMOMARK E.600 D KIT	1287042

The devices with the abbreviations US, AR, and CN have country-specific power supply units:

Standard plug type F: Germany





US – plug type B: USA and Canada





CN – plug type I: China

AR – plug type I*: Argentina

KIT – no power cable included in the scope of supply

Automated industrial identification – THERMOMARK E SERIES

Applicators					
					
Type	Item no.	THERMOMARK E.WIRE 1203216	THERMOMARK E.SLEEVE 1192932	THERMOMARK E.WRAP 1192931	THERMOMARK E.VARIO 1195972
Description		Applicator for the efficient printing and applying of movable E-WM... markers on wires and cables in just a single automated process step	Applicator for the efficient printing and applying of E-WMS... shrink sleeves and marking sleeves on wires and cables in just a single automated process step	Applicator for the efficient printing and applying of E-WML... wire-wrap labels on wires and cables in just a single automated process step	Applicator for the efficient perforation and cutting of a flexible continuous profile of type E-TM... and E-TMF... in a variable pitch ranging from 3.4 mm ... 1000 mm for terminal marking in just a single automated process step

Sets					
					
Type	Item no.	THERMOMARK E.WIRE SET 1287043	THERMOMARK E.SLEEVE SET 1287049	THERMOMARK E.WRAP SET 1287054	THERMOMARK E.VARIO SET 1287059
Description		Equipment set consisting of the E.WIRE applicator and the compatible THERMOMARK E.300 BASIC printing system for printing and applying movable E-WM... markers on wires and cables.	Equipment set consisting of the E.SLEEVE applicator and the compatible THERMOMARK E.300 BASIC printing system for printing and applying E-WMS... shrink sleeves on wires and cables.	Equipment set consisting of the E.WRAP applicator and the compatible THERMOMARK E.300 D BASIC printing system for printing and applying E-WML... wire-wrap labels on wires and cables.	Equipment set consisting of the E.VARIO applicator and the compatible THERMOMARK E.300 BASIC printing system for the efficient perforation and cutting of a flexible continuous profile of type E-TM... and E-TMF... in a variable pitch for terminal marking.

Country-specific versions (pin connector patterns)								
	Type	Item no.	Type	Item no.	Type	Item no.	Type	Item no.
US version	THERMOMARK E.WIRE SET US	1287046	THERMOMARK E.SLEEVE SET US	1287051	THERMOMARK E.WRAP SET US	1287056	THERMOMARK E.VARIO SET US	1287074
AR version	THERMOMARK E.WIRE SET AR	1287047	THERMOMARK E.SLEEVE SET AR	1287052	THERMOMARK E.WRAP SET AR	1287057	THERMOMARK E.VARIO SET AR	1287075
CN version	THERMOMARK E.WIRE SET CN	1287044	THERMOMARK E.SLEEVE SET CN	1287050	THERMOMARK E.WRAP SET CN	1287055	THERMOMARK E.VARIO SET CN	1287060
KIT version	THERMOMARK E.WIRE SET KIT	1287048	THERMOMARK E.SLEEVE SET KIT	1287053	THERMOMARK E.WRAP SET KIT	1287058	THERMOMARK E.VARIO SET KIT	1287077



Accessories for automated industrial identification

Accessories: E.WIRE		
	Type	TM E.WIRE/E.SLEEVE-PR
	Item no.	1259203
Pressure roller for all E-WM... and E-WMS... materials (for material width of up to 30 mm/1.18")		
	Type	TM-RIBBON 30 BK 103
	Item no.	1309076
Ink ribbon, for the E-WM... product group in combination with the THERMOMARK E.WIRE applicator, roll length: 300 m, width: 30 mm, color: black		
	Type	TM E.WIRE-CARDBOARD BOX
	Item no.	1371339
Original packaging incl. inlay for safe transportation of the THERMOMARK E.WIRE		



Accessories: E.SLEEVE		
	Type	TM E.WIRE/E.SLEEVE-PR
	Item no.	1259203
Pressure roller for all E-WM... and E-WMS... materials (for material width of up to 30 mm/1.18")		
	Type	TM-RIBBON 40 BK 105
	Item no.	1259008
Ink ribbon, for the E-WMS... product group in combination with the THERMOMARK E.SLEEVE applicator and the WMS... and WMS-2 HF... product groups in combination with conventional roll printers, roll length: 300 m, width: 40 mm, color: black		
	Type	TM E.SLEEVE-CARDBOARD BOX
	Item no.	1371341
Original packaging incl. inlay for safe transportation of the THERMOMARK E.SLEEVE		



Accessories: Transportation		
	Type	THERMOMARK E SERIES CASE
	Item no.	1450747
Transport case for the E.SLEEVE, E.VARIO, E.WIRE, and E.WRAP applicators of the THERMOMARK E SERIES and their accessories.		



Accessories: E.WRAP		
	Type	TM E.WRAP-PR
	Item no.	1259200
Pressure roller for all E-WML... materials (material width of up to 60 mm/2.36")		
	Type	TM-RIBBON 64 BK 103
	Item no.	1255598
Ink ribbon, for the E-WML... product group in combination with the THERMOMARK E.WRAP applicator, roll length: 300 m, width: 64 mm, color: black		
	Type	TM E.300/E.600-DISPENSING EDGE/L
	Item no.	1263116
Dispensing edge for processing all E-WML... materials when using the THERMOMARK E.WRAP		
	Type	TM E.WRAP-CARDBOARD BOX
	Item no.	1371340
Original packaging incl. inlay for safe transportation of the THERMOMARK E.WRAP		

Accessories: E.VARIO		
	Type	TM E.VARIO-PR-TM
	Item no.	1259201
Pressure roller for E-TM... materials (material width of up to 10 mm/0.39")		
	Type	TM E.VARIO-PR-TMF
	Item no.	1259202
Pressure roller for E-TMF... materials (material width of up to 5 mm/0.20")		
	Type	TM-RIBBON 30 BK 100
	Item no.	1259009
Ink ribbon, for the E-TM(F)... product group in combination with the THERMOMARK E.VARIO applicator, roll length: 300 m, width: 34 mm, color: black		
	Type	TM E.VARIO-CARDBOARD BOX
	Item no.	1371342
Original packaging incl. inlay for safe transportation of the THERMOMARK E.VARIO		





Marking materials for automated industrial identification

THERMOMARK E.WIRE: Movable cable markers in continuous format				Additional versions
	Type	Item no.	E-WM (EX15)R	1233940
	Technology			
	Cable diameter		1.8 mm ... 5.6 mm	
	Text field width		15.00 mm	
	Mounting type		Welding	
	Material		PET + thermoplastic hot-melt adhesive	
	Ambient temperature		-40°C ... 80°C	
			E-WM (EX15)R YE	1233941
			E-WM (EX18)R	1234227
			E-WM (EX18)R YE	1234228
			E-WM (EX23)R	1234231
			E-WM (EX23)R YE	1234233

THERMOMARK E.SLEEVE: Shrink sleeve in continuous format				Additional versions
	Type	Item no.	E-WMS 2,4 (EX4)R	1221568
	Technology			
	Cable diameter		0.8 mm ... 2.4 mm	
	Text field height		4.00 mm	
	Shrink rate		3:1	
	Shrink temperature		>85°C	
	Mounting type		Slide on	
	Material		Polyolefin	
	Ambient temperature		-55°C ... 125°C	
				E-WMS 2,4 (EX4)R YE
			E-WMS 3,2 (EX5)R	1221582
			E-WMS 3,2 (EX5)R YE	1221584
			E-WMS 4,8 (EX9)R	1221574
			E-WMS 4,8 (EX9)R YE	1221586
			E-WMS 6,4 (EX10)R	1221580
			E-WMS 6,4 (EX10)R YE	1221588
			E-WMS 9,5 (EX16)R	1221590
			E-WMS 9,5 (EX16)R YE	1221593

THERMOMARK E.WRAP: Wrap-around label with protective laminate				Additional versions	
	Type	Item no.	E-WML 4 (13X6)R	1199658	
	Technology				
	Cable diameter		2 mm ... 4 mm		
	Text field height		6.00 mm		
	Text field width		13.00 mm		
	Mounting type		Adhesive		
	Material		PVC		
	Ambient temperature		-40°C ... 80°C		
				E-WML 4 (25X6)R	1343120
				E-WML 5 (25X10)R	1199660
			E-WML 5 (25X10)R YE	1199661	
			E-WML 6 (25X13)R	1343122	
			E-WML 6 (13X13)R YE	1199665	
			E-WML 8 (25X13)R	1199675	
			E-WML 12 (25X19)R	1199677	
			E-WML 14 (25X19)R	1199679	
			E-WML 14 (25X19)R YE	1199681	
			E-WML 16 (25X19)R	1199686	
			E-WML 16 (51X19)R	1199685	

Marking materials for automated industrial identification

THERMOMARK E.VARIO: Zack marker strips in continuous format				Additional versions		
	Type	Item no.	E-TMF (EX5)R	1196220	E-TMF (EX5)RL	1196221
	Technology					
	Text field height		5.00 mm			
	Text field width		7800.00 mm			
	Mounting type		Latching			
	Material		TPU			
	Ambient temperature		-30°C ... 80°C			
	Type	Item no.	E-TM (EX10)R	1196222	E-TM (EX10)RL	1196223
	Technology					
	Text field height		10.00 mm			
	Text field width		3100.00 mm			
	Mounting type		Latching			
	Material		TPU			
	Ambient temperature		-30°C ... 80°C			

Marking material

2

Marking system includes a wide range of marking materials that are suitable for a variety of applications in the industrial environment – from control cabinet marking to outdoor installations. Numerous versions are available for terminal, wire and cable, equipment, and plant identification. Durability is particularly important for professional and long-lasting identification, which is why all marking materials are extensively tested.

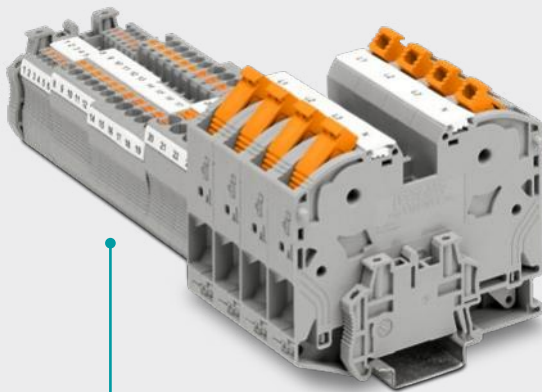

Terminal identification

Large-surface and clear marking is essential for the quick and error-free wiring of terminal strips. In particular, this simplifies the commissioning and maintenance of control cabinets and systems.

➤ More information starting on page 90



Equipment identification

Equipment markings are used in the control cabinet, in production plants, in the field, or in outdoor installations. This multitude of applications presents numerous demands, which can only be met with special materials and adhesives.

➤ More information starting on page 124



Wire and cable identification

Standard-compliant and durable wire and cable identification ensures safety and simplifies maintenance work during servicing. Depending on the application and wiring process, the appropriate choice of material and the mounting type are crucial.

➤ More information starting on page 104

Plant identification

The comprehensive and clear identification of plants not only ensures safety, but is also a legal requirement. Along with warning information, prohibition signs, and mandatory signs, markings identify emergency stop buttons and fire alarm systems, for example.

➤ More information starting on page 146

Overview of marking material

The right marking solution for every situation

When it comes to industrial identification, there are numerous and different requirements. This not only applies to the requirements regarding the area of application, mounting type, or durability

of an individual marker, but also the entire production or procurement process for marking materials. With our comprehensive material portfolio, we provide the right marking solution

for every situation. In order to increase the flexibility and efficiency of your identification processes, we offer individual solutions in addition to our standard solutions.

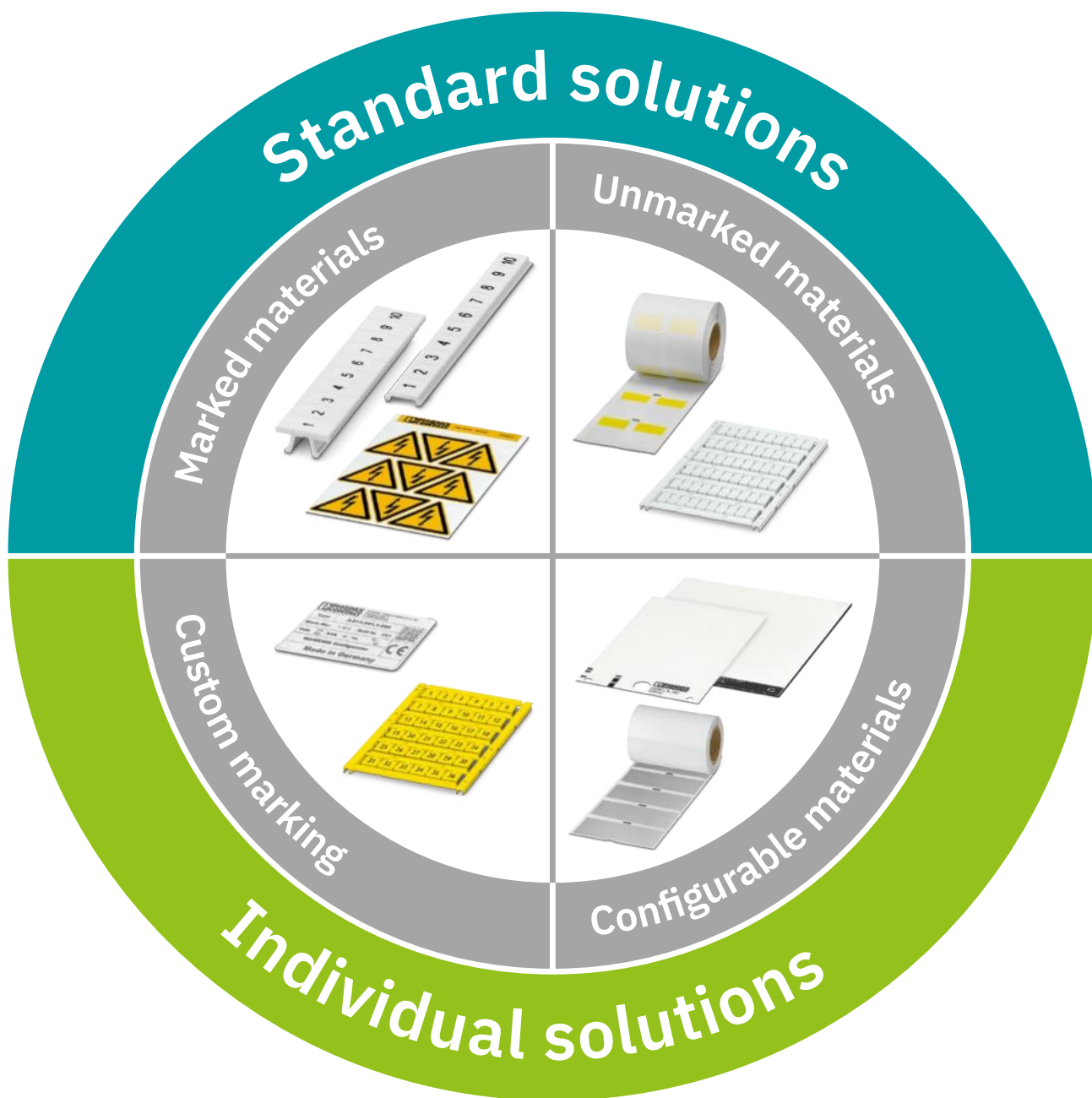

Marked marking materials

Do you need marking materials that you can mount directly in your application without any marking work? Then simply order our marked and ready-to-use materials. These include, for example, labels for plant identification, markers and zack marker strips for terminal identification, and marking tags for wire and cable identification.



Unmarked marking materials

Do you prefer a high degree of flexibility and want to mark your marking materials with your own identification systems? Our portfolio includes numerous unmarked materials for terminal, wire and cable, equipment, and plant identification. We provide identification solutions featuring flexible thermal transfer printing, versatile UV inkjet printing, and resilient direct laser marking.



Custom-marked marking materials

What if you don't have your own marking systems or the right device for your requirements, and you need to cope with order peaks and cover maintenance work? – No problem. With our web-based Marking Configurator, you can order over 2,000 marking materials that are custom-marked in accordance with your requirements and ready to use.



Configurable marking materials

What if you need a label in a specific size or geometry and can't find what you need in our standard portfolio? – Then simply configure your material according to your individual requirements. To do this, select a material and specify the quantity of markers, their dimensions, the shape, and the mounting type. The material will then be tailor-made for you. You can then apply the marking to the markers using your own marking systems.

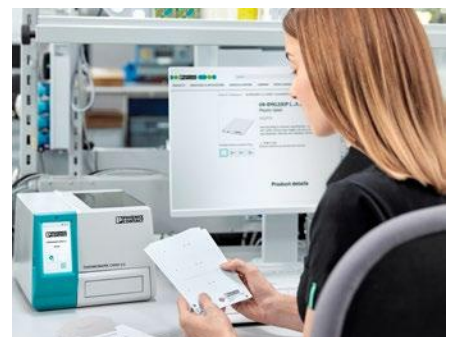

Identification solutions

Ink ribbons for thermal transfer printers		
Designation	Item No.	Print media
THERMOMARK-RIBBON 110	5145384	EML, EML-ESD, EML-LT, EML-RM, EML-HA, EML-LPR, EML-LPR-D, EMLS, EMLC, EMLP, EMLF, WML, WML HF, WML-FLAG, WMT, WMTB, WMTS, PML, PMM, SK, TML, TMT
THERMOMARK-RIBBON 110/50	0800687	EML, EML-ESD, EML-RM, EML-HA, EMLS, EMLC, EMLP, EMLF, WML, WML HF, WML-FLAG, WMT, WMTB, PML, PMM, SK, TML, TMT
THERMOMARK-RIBBON 110-EX	0803211	EML-EX, EML-D
THERMOMARK-RIBBON 110-EML-HT	0800342	EML-HT
THERMOMARK-RIBBON 110-WMTB HF	5148007	WMTB HF, WMS-2 HF, TMT, EMT, WMT
THERMOMARK-RIBBON 110 BU	0829544	EML
THERMOMARK-RIBBON 110 GN	0829542	EML
THERMOMARK-RIBBON 110 RD	0829543	EML
THERMOMARK-RIBBON 110-WMSU	0801358	WMS, WMTB HF-HP
THERMOMARK-RIBBON 25-WMSU	0803390	WMS, WMS-2 HF
THERMOMARK-RIBBON 64-WMSU	0801360	WMS
THERMOMARK-RIBBON 110-WMS	5145397	WMS
THERMOMARK-RIBBON 64-WMSE	5145724	WMS
THERMOMARK-RIBBON 110-WMSU WH	0801359	WMS
THERMOMARK-RIBBON 64-WMSU WH	0801361	WMS
THERMOMARK-RIBBON 64-WMSE RD	5145740	WMS
TM-RIBBON 105 BK 106	1255597	WMTB HF-D
TM-RIBBON 25 BK 102	1053499	WMS-OT HF, TML (white), TMT, EMT (continuous)
TM-RIBBON 30 BK 100	1259009	E-TM, E-TMF
TM-RIBBON 30 BK 103	1309076	E-WM
TM-RIBBON 40 BK 105	1259008	E-WMS
TM-RIBBON 64 BK 103	1255598	E-WML
THERMOMARK-RIBBON 110-WMTB HF WH	0802990	WMTB HF, WMS-2 HF, EMT
TM-RIBBON 110 WH 100	0804661	EMLP BU, EMLP RD US-EML, US-EMLP, US-EMLP-HA, US-EML-RS, US-EMLSP, US-TM, US2-TM, US-TMF, US-TMFL, US-TML, US-WMT, US-WMTB, WMTB HF-HP
TM-RIBBON 110 WH 101	1099966	PML-T
THERMOMARK-RIBBON 110-TC	0801371	UCT, US, UM
THERMOMARK-RIBBON 110/50-TC	0801384	UCT, US, UM
TMP-RIBBON 110 BK 100	0803374	UCT, UM, US-EML, US-EMLF, US-EMLP, US-EMLP-HA, US-EML-RS, US-EMLSP, US-EMT, US-PML, US-TM, US2-TM, US-TMF, US-TMFL, US-TML, US-WML, US-WMT, US-WMTB
TMP-RIBBON 110 BK 101	0803714	US-EML, US-EMLP, US-EMLP-HA, US-EML-RS, US-EMLSP, US-TM, US2-TM, US-TMF, US-TMFL, US-TML, US-WMT, US-WMTB
TMP-RIBBON 110 BU 100	0803378	US-EML, US-EMLP, US-EMLP-HA, US-EML-RS, US-EMLSP, US-TM, US2-TM, US-TMF, US-TMFL, US-TML, US-WMT, US-WMTB
TMP-RIBBON 110 GN 100	0803380	US-EML, US-EMLP, US-EMLP-HA, US-EML-RS, US-EMLSP, US-TM, US2-TM, US-TMF, US-TMFL, US-TML, US-WMT, US-WMTB
TMP-RIBBON 110 RD 100	0803377	US-EML, US-EMLP, US-EMLP-HA, US-EML-RS, US-EMLSP, US-TM, US2-TM, US-TMF, US-TMFL, US-TML, US-WMT, US-WMTB
TMP-RIBBON 110 WH 100	0803376	US-EML, US-EMLP, US-EMLP-HA, US-EML-RS, US-EMLSP, US-TM, US2-TM, US-TMF, US-TMFL, US-TML, US-WMT, US-WMTB
TMP-RIBBON 110 YE 100	0803379	US-EML, US-EMLP, US-EMLP-HA, US-EML-RS, US-EMLSP, US-TM, US2-TM, US-TMF, US-TMFL, US-TML, US-WMT, US-WMTB

	THERMOMARK PRIME 2.0	THERMOMARK CARD 2.0	THERMOMARK E.300 (D) / 600 (D)	THERMOMARK E.300 DOUBLE	THERMOMARK ROLL 2.0
			●	●	●
			●	●	●
			●	●	●
			●	●	●
			●	●	●
			●	●	●
			●	●	●
			●	●	●
			●	●	●
			●	●	●
			●	●	●
			●	●	●
			●	●	●
			●	●	●
			●	●	●
			●	●	●
			●	●	●
			●	●	●
			●	●	●
			●	●	●
			●	●	●
			●	●	●
			●	●	●
			●	●	●
			●	●	●
			●	●	●
		●	●	●	●
			●	●	●
		●			
		●			
●					
●					
●					
●					
●					
●					
●					
●					





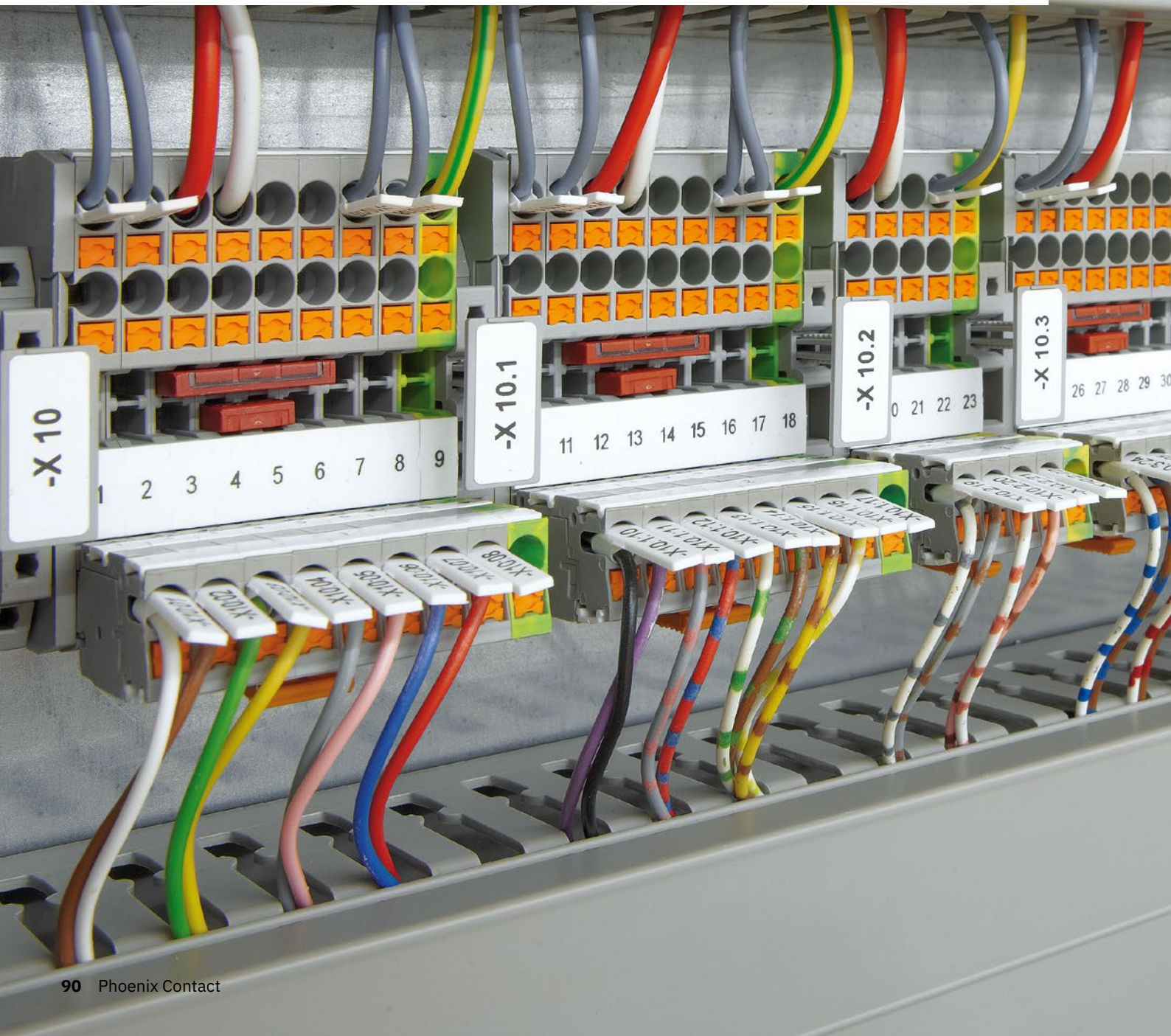

Terminal identification

Large-surface and clear marking of terminal points is essential for the quick and error-free wiring of terminal strips. In particular, this simplifies the commissioning and maintenance of control cabinets and systems. Terminal strips are assembled flexibly with different terminal blocks whose geometries can differ from each other. The decisive variables for the terminal markings are the pitch and the marker groove. Phoenix Contact offers a wide range of versions here.

















Designation key: Terminal identification

1
2
3
4
Marking material



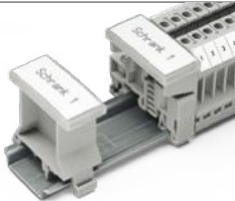

						Technology
Terminal identification: Marking solution in roll format						
TML		Terminal Marking	Label		Self-adhesive marking strips for zack marker strips or terminal blocks without marking groove	 Thermal transfer printing
TMT (EX...)			Tag	Continuous media	Markers for latching into flat marking groove	
TMT					Markers for latching into flat marking groove	
SK		Self-adhesive strips			Self-adhesive marking strips for components without marking groove	
EMT		Equipment Marking	Tag		Plastic label for insertion into KLM... and UBE... group marker carriers for terminal identification or for insertion into PATG or PATO marking tags and KMK... marker carriers for wire and cable identification	
Terminal identification: Marking solution in sheet format						
UC-TM	Universal Card	Terminal Marking			Markers for latching into terminal blocks with tall marking groove	 UV inkjet printing Plotter
UC-TMF			Flat		Markers for latching into terminal blocks with flat marking groove	
UC-TMN			Nail		Plug-in markers for G5 / ... device terminal blocks and VDFK... panel feed-through terminal blocks	
UCT-TM	Universal Card thermal transfer	Terminal Marking			Markers for latching into terminal blocks with tall marking groove	 Direct laser marking UV inkjet printing Thermal transfer printing
UCT-TMF			Flat		Markers for latching into terminal blocks with flat marking groove	
UCT-TMC					Markers for the identification of the E/NS 35 N end bracket	
UCTU-TM					Markers for the PTIO 1,5/S... terminal block series	
Terminal identification: Marking solution in card format						
US-TML	Universal Sheet	Terminal Marking	Label		Self-adhesive marking strips for zack marker strips or terminal blocks without marking groove	 UV inkjet printing Thermal transfer printing
US-TMF			Flat		Marking strips for latching into flat marking groove	
US-TMFL			Flat Label		Self-adhesive marking strips for flat marking groove	
US-TM 100			100 mm		Marking strips for latching into marking groove	
Terminal identification: Marking solution in zack marker strip format						
ZB		Zack marker strip			Markers in strip format for latching into tall marking groove	 Plotter
ZBF			Flat		Markers in strip format for latching into flat marking groove	
Terminal identification: Marking solution in cartridge format						
MM-TML	Mobile Marking	Terminal Marking	Label		Self-adhesive marking strips for marking terminal blocks without marking groove	 Thermal transfer printing
MM-TMT			Tag		Labels for latching into flat and tall marking groove	

Terminal identification

Marker carriers for terminal identification								
								
Product group	STP...		STP-ZB...		CARRIER-TM...			
Product type	Marker carrier		Marker carrier		Marker carrier			
Mounting type	Plug in		Plug in		Snap in			
Mounting type of the marking material	Snap in		Snap in		Snap in			
Area of application (examples)	Multi-level terminal blocks, double-level or three-level spring-cage terminal blocks (e.g., STTB..., PTTB..., ST...)		ST 1,5... or ST 2,5 spring-cage terminal blocks		All terminal blocks from the CLIPLINE complete system with flat, lateral marker groove			
Marking material product group	Compatible printing technology							
								
UCT-TM...		•	•	•		•	•	•
UCT-TMF...		•	•	•		•	•	
UC-TM...			•		•	•	•	•
UC-TMF...			•		•	•	•	
US-EMP...		•	•					
US-EML...		•	•					
US-EMLP...		•	•					
EMT...	•	•						
EML...	•	•						
EMLP...	•	•						
EMLC...	•	•						
ESL					•			
ZB					•	•	•	•
ZBF					•	•	•	
B-STIFT					•			

					
CARRIER-TMH...	CARRIER-TMD...	KLM...	GBS...	AK...	UBE(/D)...
Marker adapter	Double marker adapter	Marker carrier	Group marking label	Group marking label	Marker carrier
Snap in	Snap in	Plug in	Snap in	Snap in	Snap in
Snap in	Snap in	Snap in	Snap in	Snap in	Snap in
All terminal blocks from the CLIPLINE complete system with flat, lateral marker groove	Double-row, snap-in marker adapter, for holding two ZB... or UC-TM... and UCT-TM...	E/UK end bracket, CLIPFIX 15, CLIPFIX 35, and CLIPFIX 35-5 end brackets	Can be snapped into terminal center for screw, spring-cage, and fast-connection terminal blocks, Push-in terminal blocks of type ...1,5/S	Terminal blocks whose uppermost marker groove is angled 45°/60°, e.g., DIK terminal blocks, can be snapped into marker groove, the marker holder can be swiveled 120°	For the identification of terminal block groups, for E/UK end bracket or E/U end bracket
					
•	•		•	•	
			•		
•	•				
		•			•
		•			
		•			
		•			
		•			
		•			
		•	•		
		•			
		•		•	•
•	•		•		
			•		
			•		

Marking materials for terminal identification

Marking material for terminal blocks from other manufacturers				
Product group	Compatible marking system			
				
	THERMOMARK PRIME 2.0	THERMOMARK CARD 2.0	BLUEMARK ID (COLOR)	TOPMARK NEO
UC1-TM			•	
UC1-TMF			•	
UCT1-TM	•	•	•	•
UCT1-TMF	•	•	•	•
UM1-TM	•	•	•	•
UM1-TMF	•	•	•	•
UC2-TM			•	
UC2F-TM			•	
UCT2-TM	•	•	•	•
UM2-TM	•	•	•	•
UC3-TM			•	
UCT3-TM	•	•	•	•
UM3-TM	•	•	•	•
UC4-TM			•	
UCT5-TM	•	•	•	•
UM5-TM	•	•	•	•
UCT6M-TM	•	•	•	•
UCT6R-TM	•	•	•	•
UM6M-TM	•	•	•	•
UM6R-TM	•	•	•	•
UM7-TM	•	•	•	•
UM8-TM	•	•	•	•



Manufacturers







	Weidmüller CONTA-CLIP Klemsan	Wago	Wieland	Siemens (8WA series)	Cabur	ABB (SNK series)	Entelec	Legrand	Woertz
	•								
	•								
	•								
	•								
	•								
	•								
		•							
		•							
		•							
		•							
			•						
			•						
			•						
				•					
					•				
					•				
						•			
							•		
						•			
							•		
								•	
									•

Marking materials for terminal identification









Markers for the flat marking groove				Additional versions
	Type	Item no.	UCT-TMF 5	0828744
	Technology			
	Pitch	5.2 mm		
	Marking groove	Flat		
	Text field height	4.70 mm		
	Text field width	4.40 mm		
	Mounting type	Latching		
	Material	PC		
	Ambient temperature	-40°C ... 100°C		
				UCT-TMF 3,5 0829486 UCT-TMF 4 0828742 UCT-TMF 6 0828746 UCT-TMF 8 0828748
	Type	Item no.	UC-TMF 5	0818153
	Technology			
	Pitch	5.2 mm		
	Marking groove	Flat		
	Text field height	5.10 mm		
	Text field width	4.60 mm		
	Mounting type	Latching		
	Material	PA		
	Ambient temperature	-40°C ... 120°C		
				UC-TMF 4 0818166 UC-TMF 6 0818140 UC-TMF 8 0818137 UC-TMF 16 0819262
	Type	Item no.	US-TMF 100	0829260
	Technology			
	Pitch	Variable		
	Marking groove	Flat		
	Text field height	6.60 mm		
	Text field width	104.00 mm		
	Mounting type	Latching		
	Material	PVC		
	Ambient temperature	-30°C ... 80°C		
	Type	Item no.	US-TMFL 100	0830339
	Technology			
	Pitch	Variable		
	Marking groove	Flat		
	Text field height	6.60 mm		
	Text field width	104.00 mm		
	Mounting type	Adhesive		
	Material	PVC		
	Ambient temperature	-30°C ... 80°C		
	Type	Item no.	TML (EX3,8)R	0801837
	Technology			
	Pitch	Variable		
	Marking groove	Flat		
	Text field height	3.80 mm		
	Text field width	30000.00 mm		
	Mounting type	Adhesive		
	Material	Polyester		
	Ambient temperature	-40°C ... 150°C		
				TML (101X9,5)R TR 0816647 TML (104X2,8)R 0801832 TML (104X3,8)R 0801833 TML (EX2,8)R 0801836 TML (EX5)R 0801838 TML (EX7)R 0830837 TML (EX10)R 0801839

Marking materials for terminal identification

Markers for the flat marking groove				Additional versions
	Type	Item no.	TMT 5 R	0816430
	Technology			
	Pitch	5.2 mm		
	Marking groove	Flat		
	Text field height	6.35 mm		
	Text field width	5.15 mm		
	Mounting type	Latching		
	Material	Polyester		
	Ambient temperature	-40°C ... 120°C		
				TMT 4 R 0816375 TMT 6 R 0816498 TMT 8 R 0816553 TMT 10 R 0816210 TMT 100 R 0816605



Markers for the tall marking groove				Additional versions
	Type	Item no.	UCT-TM 5	0828734
	Technology			
	Pitch	5.2 mm		
	Marking groove	Tall		
	Text field height	10.50 mm		
	Text field width	4.60 mm		
	Mounting type	Latching		
	Material	PC		
	Ambient temperature	-40°C ... 100°C		
				UCT-TM 3,5 0829484 UCT-TM 6 0828736 UCT-TM 8 0828740 UCT-TM 10 0829142
	Type	Item no.	UC-TM 5	0818108
	Technology			
	Pitch	5.2 mm		
	Marking groove	Tall		
	Text field height	10.50 mm		
	Text field width	4.60 mm		
	Mounting type	Latching		
	Material	PA		
	Ambient temperature	-40°C ... 120°C		
				UC-TM 6 0818085 UC-TM 8 0818072 UC-TM 10 0818069 UC-TM 12 0819194
	Type	Item no.	US-TM 100	0829255
	Technology			
	Pitch	Variable		
	Marking groove	Universal		
	Text field height	9.80 mm		
	Text field width	104.00 mm		
	Mounting type	Latching		
	Material	PVC		
	Ambient temperature	-30°C ... 80°C		





Marking materials for terminal identification

Marking strips for components without/with universal marking groove				Additional versions
	Type	Item no.	SK 2,8 WH:REEL	0805205
	Technology			
	Pitch	Variable		
	Marking groove	Flat		
	Text field height	2.80 mm		
	Text field width	90000.00 mm		
	Mounting type	Adhesive		
	Material	Polyester		
	Ambient temperature	-40°C ... 150°C		
				SK 3,8 WH:REEL 0805218 SK 5,0 WH:REEL 0805221 SK 10,0 WH:REEL 0812188
	Type	Item no.	US-TML (104X3,8)	0830768
	Technology			
	Pitch	Variable		
	Marking groove	Flat		
	Text field height	3.80 mm		
	Text field width	104.00 mm		
	Mounting type	Adhesive		
	Material	Polyester		
	Ambient temperature	-40°C ... 150°C		
				US-TML (104X2,8) 0830767 US-TML (104X5) 0830769 US-TML (104X10) 0830770
	Type	Item no.	TMT (EX9,5)R	0828295
	Technology			
	Pitch	Variable		
	Marking groove			
	Text field height	9.50 mm		
	Text field width	50000.00 mm		
	Mounting type	Latching		
	Material	PVC		
	Ambient temperature	-30°C ... 80°C		
				TMT (EX5,5)R 0803062 TMT (EX6,2)R 0803063 TMT (EX6,5)R 0803064 TMT (EX7,5)R 0803065 TMT (EX8)R 0803066 TMT (EX8,5)R 0803067 TMT (EX10)R 0803068 TMT (EX10,5)R 0803070 TMT2 (EX11)R 0802683 TMT (EX12)R 0803071
Plug-in markers for G5 / VDFK				Additional versions
	Type	Item no.	UC-TMN 7,5	0821823
	Technology			
	Pitch	7.5 mm		
	Marking groove	Tall		
	Text field height	3.97 mm		
	Text field width	6.90 mm		
	Mounting type	Latching		
	Material	PA		
	Ambient temperature	-40°C ... 120°C		
				UC-TMN 5,2 0822945 UC-TMN 10 0828554

Marking materials for terminal identification



1
2
3
4
Marking material

Markers for the PTIO 1,5/S... terminal block series				Additional versions
	Type	Item no.	UCTU-TM (3,5X7)	0803666
	Technology			
	Area of application	PTIO 1,5/S... terminal block series		
	Pitch	3.5 mm		
	Marking groove	Tall		
	Text field height	7.00 mm		
	Text field width	3.50 mm		
	Mounting type	Latching		
	Material	PC		
	Ambient temperature	-40°C ... 120°C		

Terminal markers in cartridge format / for the GO SERIES				Additional versions
	Type	Item no.	MM-TML (EX3,8)R C1 WH/BK	1092026
	Technology			
	Pitch	Variable		
	Marking groove	Flat		
	Text field height	3.80 mm		
	Text field width	8000.00 mm		
	Mounting type	Adhesive		
	Material	Polyester		
	Ambient temperature	-40°C ... 150°C		
	Type	Item no.	MM-TMT (EX6,35)R C1 WH/BK	0803982
	Technology			
	Pitch	Variable		
	Marking groove	Flat		
	Text field height	5500.00 mm		
	Text field width	6.35 mm		
	Mounting type	Latching		
	Material	Polyester		
	Ambient temperature	-40°C ... 120°C		





MM-TML (EX4,2)R C1 TR/BK 0803979
MM-TML (EX9,5)R C1 TR/BK 0803981



MM-TMT (EX9,5)R C1 WH/BK 0803983

Markers for E/NS 35 N end bracket				Additional versions
	Type	Item no.	UCT-TMC (30X8)	1278515
	Technology			
	Area of application	E/NS 35 N end bracket		
	Text field height	8.00 mm		
	Text field width	30.00 mm		
	Mounting type	Latching		
	Material	PC		
	Ambient temperature	-40°C ... 120°C		

UCT-EM (30X5) YE 0830340

Marking materials for terminal identification





Terminal markers in zack marker strip format				Additional versions
	Type	Item no.	ZB 6:UNBEDRUCKT	1051003
	Technology			
	Pitch		6.2 mm	
	Marking groove		Tall	ZB 5:UNBEDRUCKT 1050004
	Text field height		10.50 mm	ZB 8:UNBEDRUCKT 1052002
	Text field width		6.15 mm	ZB 10:UNBEDRUCKT 1053001
	Mounting type		Latching	ZB 12:UNPRINTED 0812120
	Material		PA	
	Ambient temperature		-40°C ... 100°C	
	Type	Item no.	ZBF 5:UNBEDRUCKT	0808642
	Technology			
	Pitch		5 mm	
	Marking groove		Flat	ZBF 3,5:UNBEDRUCKT 0829392
	Text field height		5.15 mm	ZBF 4:UNBEDRUCKT 0808587
	Text field width		5.15 mm	ZBF 6:UNBEDRUCKT 0808710
	Mounting type		Latching	ZBF 15:UNBEDRUCKT 0811202
	Material		PA	
	Ambient temperature		-40°C ... 100°C	

Marked terminal markers in zack marker strip format				Additional versions
	Type	Item no.	ZB 5,LGS:FORTL.ZAHLEN	1050017
	Pitch		5.2 mm	
	Marking groove		Tall	
	Text field height		10.50 mm	ZB 5,QR:FORTL.ZAHLEN 1050020
	Text field width		5.15 mm	ZB 6,QR:FORTL.ZAHLEN 1051029
	Mounting type		Latching	ZB 6,LGS:FORTL.ZAHLEN 1051016
	Material		PA	ZB 8,LGS:FORTL.ZAHLEN 1052015
	Ambient temperature		-40°C ... 100°C	
	Type	Item no.	ZBF 5,LGS:FORTL.ZAHLEN	0808671
	Pitch		5 mm	
	Marking groove		Flat	ZBF 3,5,LGS:FORTL.ZAHLEN 0801406
	Text field height		5.15 mm	ZBF 6,LGS:FORTL.ZAHLEN 0808749
	Text field width		5.15 mm	ZBF 5,LGS:GERADE ZAHLEN 0810821
	Mounting type		Latching	ZBF 5,LGS:UNGERADE ZAHLEN 0810863
	Material		PA	ZBF 5,LGS:FO.ZA. 1-10 VPE 500 1684696
	Ambient temperature		-40°C ... 100°C	ZBF 5,LGS:FO.ZA. 11-20 VPE 500 1684697 ZBF 5,LGS:FO.ZA. 21-30 VPE 500 1684698

Marking materials for terminal identification

1
2
3
4



Marking material

Insert labels for group marker carriers				Additional versions	
	Type	Item no.	ESL 44X7	0808244	ESL 40X17 ESL 60X10 0808095 0804287
	Technology				
	Text field height		7.00 mm		
	Text field width		44.00 mm		
	Mounting type		Insert		
	Material		Polyester foil		
	Ambient temperature		-40°C ... 100°C		
	Type	Item no.	EMT (44X7)R	0819275	EMT (40X17)R EMT (60X10)R 0817293 0804288
	Technology				
	Text field height		7.00 mm		
	Text field width		44.00 mm		
	Mounting type		Insert		
	Material		Polyester		
	Ambient temperature		-40°C ... 120°C		

Marking materials for terminal identification

Marker carriers for marking terminal block groups				Additional versions
	Type	Item no.	STP 5-2	0800967
	Text field height		10.50 mm	
	Text field width		5.00 mm	
	Mounting type		Plug in	
	Material		PA	
	Ambient temperature		-40°C ... 100°C	
	Type	Item no.	STP 5-2-ZB	3037643
	Text field height		10.50 mm	
	Text field width		5.00 mm	
	Mounting type		Latching	
	Material		PA	
	Ambient temperature		-40°C ... 100°C	
	Type	Item no.	CARRIER-TM 300	0828282
	Text field height		10.50 mm	
	Text field width		300.00 mm	
	Mounting type		Latching	
	Material		PA	
	Ambient temperature		-40°C ... 80°C	
	Type	Item no.	CARRIER-TMH 300	0830670
	Text field height		10.50 mm	
	Text field width		300.00 mm	
	Mounting type		Latching	
	Material		PA	
	Ambient temperature		-40°C ... 80°C	
	Type	Item no.	CARRIER-TMD 300	0828693
	Text field height		10.50 mm	
	Text field width		300.00 mm	
	Mounting type		Latching	
	Material		PA	
	Ambient temperature		-40°C ... 80°C	
	Type	Item no.	KLM	1004306
	Text field height		6.00 mm	
	Text field width		25.00 mm	
	Mounting type		Plug in	
	Material		ABS	
	Ambient temperature		-40°C ... 80°C	
				STP 5-3 STP 3,5-2 STP 3,5-3 STP 4-2 STP 5-2/S 0810562 0830131 0830132 0810575 0800970
				STP 4-2-ZB 3038613
				KLM 1 KLM 2 KLM 3 KLM 3-L KLM 4 1004319 0807575 0811969 0814788 0811970

Marking materials for terminal identification

Marker carriers for marking terminal block groups				Additional versions	
	Type	Item no.	GBS 5-25X12	0810588	GBS 5-25X5 GBS 3,5-25X3,5 GBS 3,5-25X12
	Pitch		5.2 mm		
	Text field height		12.00 mm		
	Text field width		25.00 mm		
	Mounting type		Latching		
	Material		PA		
	Ambient temperature		-40°C ... 120°C		
	Type	Item no.	AK-DST/UK	1000708	AK-DST/DIK 1000779
	Text field height		4.00 mm		
	Text field width		24.00 mm		
	Mounting type		Latching		
	Material		PA/PC		
	Ambient temperature		-40°C ... 100°C		
	Type	Item no.	UBE	0800310	UBE/D UBE/D N+C 0800307 0803122
	Text field height		20.00 mm		
	Text field width		41.40 mm		
	Mounting type		Latching		
	Material		PA		
	Ambient temperature		-40°C ... 100°C		





Wire and cable identification

Standard-compliant and durable wire and cable marking ensures safety and simplifies maintenance work during servicing. Depending on the application and wiring process, the choice of material and the mounting type are crucial. Assembly with cable ties is not dependent on the wire or cable diameter, and can also be performed after wiring in the same way that markers are clipped on or adhered. Identification with thread-on markers, however, must be performed prior to wiring.







Designation key: Wire and cable identification

1
2
3
4
Marking material

Wire and cable identification: Marking solutions in roll format					Technology
WML	Wire Marking	Label		Wrap-around labels with protective laminate for extra high durability	 Thermal transfer printing
WML HF			Halogen-free	Halogen-free wrap-around labels with protective laminate for extra high durability	
WML-FLAG			Flag	Self-adhesive labels with horizontal cable marking flags	
WML-FLAGV			Flag Vertical	Self-adhesive labels with vertical cable marking flags	
WMT ...		Tag		Markers for sliding directly onto wires and cables or inserting into PATG/PATO marking tags	
WMTS		Tag Slide		Markers for easy identification of PATG/PATO marking tags by means of a perforated pull-through tab	
WMS		Slide		Halogen-free marking sleeve in accordance with UL 224 and CSA 22.2 with a shrink ratio of 3:1	
WMS-2 HF			Halogen-free	Halogen-free marking sleeve in accordance with EN 45545-2 with a shrink ratio of 2:1	
WMS-OT HF			Oval tube Halogen-free	Halogen-free marking sleeve in oval design, non-shrinkable	
WMTB		Tag Binder		Markers for marking and bundling with cable ties	
WMTB HF			Halogen-free	Halogen-free markers for marking and bundling by means of assembly with cable ties	
WMTB HF-HP			Halogen-free High performance	Halogen-free markers for marking and bundling by means of assembly with cable ties in accordance with EN 45545-2 for the railway industry	
WMTB HF-D			Halogen-free Detectable	Halogen-free, detectable markers for marking and bundling by means of assembly with cable ties for the food industry	
Wire and cable identification: Marking solutions in sheet format					
UC-WMTB	Universal Card	Wire Marking	Tag Binder	Markers for marking and bundling by means of assembly with cable ties	 UV inkjet printing Plotter
UC-WMTBA			Tag Binder Angled	Angled markers for marking and bundling by means of assembly with cable ties	
UC-WMT			Tag	Markers for insertion into marking tags from the PATG (HF)/PATO... system	
UC-WMCO			Clip Open	Markers that are slid on using the UC-WMCO ... TOOL	
UC-WMC			Clip	Markers for subsequent marking that are simply clipped on	
UC-WMTBA/PP			Tag Binder Angled Polypropylene	Angled markers made of highly durable polypropylene for assembly with cable ties in the food industry	
UC-WMTBA-D/PP	Tag Binder Angled Detectable Polypropylene	Angled, detectable markers made of highly durable polypropylene for assembly with cable ties in the food industry			
UCT-WMTBA	Universal Card thermal transfer	Wire Marking	Tag Binder Angled	Angled markers for marking and bundling by means of assembly with cable ties	   Direct laser marking UV inkjet printing Thermal transfer printing
UCT-WMCO			Clip Open	Markers for subsequent marking that are simply clipped on	
UCT-WMS			Slide	Slide-on markers	
UCT-WMT			Tag	Markers for insertion into marking tags from the PATG (HF)/PATO... system	

Designation key: Wire and cable identification











Marking material

Designation key						Technology	
Wire and cable identification: Marking solutions in card format							
US-WML	Universal Sheet	Wire Marking	Label		Wrap-around labels with protective laminate for extra high durability	 UV inkjet printing Thermal transfer printing	
US-WMTB			Tag Binder		Markers for marking and bundling by means of assembly with cable ties		
US-WMT			Tag		Markers for insertion into PATG/ PATO marking tags		
Wire and cable identification: Marking solutions in sheet format							
LS-WMTB-AL	Laser Sheet	Wire Marking	Tag Binder	Aluminum	Aluminum markers attached by means of assembly with cable ties	 Direct laser marking	
LS-WMTB-V4A			Tag Binder	V4A	Stainless steel markers attached by means of assembly with cable ties		
WMTB-AL	WML...A4		Tag Binder	Aluminum	Aluminum markers attached by means of assembly with cable ties	 UV inkjet printing	
ESL			Laser insert strip		Plastic labels in DIN A4 sheet format for the identification of KMK... marker carriers	 Office laser printing Plotter	
PABL					Markers for insertion into PATG/ PATO marking tags		
Wire and cable identification: Marking solutions in cartridge format							
MM-WML	Mobile Marking		Wire Marking	Label		Wrap-around labels with protective laminate for extra high durability	 Thermal transfer printing
MM-WML-FLAG				Label	Flag	Self-adhesive labels suitable for double-sided printing with cable marking flags	
MM-WMTB		Tag Binder		Markers for marking and bundling by means of assembly with cable ties			
MM-WMTB HF		Tag Binder		Halogen-free	Halogen-free markers for marking and bundling by means of assembly with cable ties		
MM-WMT		Tag		Prepunched markers for threading on			
MM-WMS		Slide		Halogen-free marking sleeve in accordance with UL 224 and CSA 22.2 with a shrink ratio of 3:1			
MM-WMS-2		Slide		Halogen-free marking sleeve in accordance with EN 45545-2 with a shrink ratio of 2:1			
Wire and cable identification: Individual markers							
SD-WMTBS VA	Single Digit	Wire Marking	Tag Binder	VA	Individual, embossed stainless steel marking tags for SD-WMTB (...X10) VA carriers for assembly with cable ties		
SD-WMTBS			Slide		Individual, printed plastic marking tags for SD-WMTB (70X10) or (100X10) carriers for assembly with cable ties		

Wire and cable identification

1
2
3
4

Marking material



Marker carriers for wire and cable identification										
										
Product group					PATG...	PATG HF...	PATO...			
Product type					Marking tag	Marking tag	Marking tag			
Mounting type					Slide on	Slide on	Clip on			
Mounting type of the marking material					Insertion	Insertion	Insertion			
Area of application					For sliding onto wires and cables that have not yet been wired	For sliding onto wires and cables that have not yet been wired	For subsequent marking of systems that have already been wired			
Marking material product group		Compatible printing technology								
										
UCT-WMT			•	•	•	•	•	•		
UC-WMT				•	•	•	•	•		
US-WMT			•	•		•		•		
US-EMP...			•	•						
US-EML...			•	•						
US-EMLF			•	•						
UCT-EMP...			•	•	•					
UC-EMLP...			•	•		•		•		
WMTS...		•								
EMT...		•				•		•		
EML...		•								
EMLP...		•								
LS-EMLP					•					
EMLC...		•								
ESL										

WM-CARRIER/B...	KMK...	KMK UV...	LM...	KME...	PAB-KTL...	KMK HP...
Marker carrier	Marker carrier	Marker carrier	Marker carrier	Marker carrier	Marker carrier	Marker carrier
Assembly with cable ties	Assembly with cable ties	Assembly with cable ties	Assembly with cable ties	Assembly with cable ties	Assembly with cable ties	Assembly with cable ties
Adhesive	Insertion	Insertion	Insertion	Insertion	Insertion	Insertion
For the identification and bundling of wires and cables	For the identification and bundling of wires and cables in indoor installations	For the durable identification of cables in outdoor installations due to extremely high UV and weather resistance	For the identification and bundling of wires and cables in indoor installations	For the identification and bundling of wires and cables in indoor installations	For the identification and bundling of wires and cables	For the identification and bundling of wires and cables in accordance with EN 45545-2 for the railway industry
					•	
					•	
					•	
	•	•		•		•
				•		
	•	•		•		
•			•		•	
				•		
				•		
				•		
	•	•	•			•

Marking materials for wire and cable identification

Cable markers for marking tags				Additional versions
	Type	Item no.	UCT-WMT (15X4)	0801446
	Technology			
	Cable diameter	0.6 mm ... 50 mm		
	Text field height	4.00 mm		
	Text field width	15.00 mm		
	Mounting type	Insert		
	Material	PC		
	Ambient temperature	-40°C ... 120°C		
				UCT-WMT (10X4) 0801430 UCT-WMT (12X4) 0801438 UCT-WMT (18X4) 0801462 UCT-WMT (23X4) 0801453
	Type	Item no.	UC-WMT (15X4)	0819398
	Technology			
	Cable diameter	0.6 mm ... 46 mm		
	Text field height	4.00 mm		
	Text field width	15.00 mm		
	Mounting type	Insert		
	Material	PA		
	Ambient temperature	-40°C ... 120°C		
				UC-WMT (12X4) 0823517 UC-WMT (18X4) 0820293 UC-WMT (23X4) 0819411 UC-WMT (30X4) 0819437
	Type	Item no.	US-WMT (15X4)	0828767
	Technology			
	Cable diameter	0.6 mm ... 50 mm		
	Text field height	4.00 mm		
	Text field width	15.00 mm		
	Mounting type	Slide on		
	Material	PVC		
	Ambient temperature	-30°C ... 80°C		
				US-WMT (10X4) 0828765 US-WMT (12X4) 0828766 US-WMT (18X4) 0828768 US-WMT (23X4) 0828769
	Type	Item no.	WMT 2,4 (15X4)R	0816281
	Technology			
	Cable diameter	1 mm ... 2.4 mm		
	Text field height	4.20 mm		
	Text field width	15.00 mm		
	Mounting type	Slide on		
	Material	Polyester		
	Ambient temperature	-40°C ... 120°C		
				WMT 3,5 (15X5)R 0817222 WMT 4,2 (15X6)R 0817235 WMT 5,5 (15X8)R 0817248 WMT 8,4 (17X10)R 0817251
	Type	Item no.	WMT (15X4)RL	1080099
	Technology			
	Cable diameter	0.6 mm ... 45 mm		
	Text field height	4.00 mm		
	Text field width	15.00 mm		
	Mounting type	Insert		
	Material	PVC		
	Ambient temperature	-30°C ... 80°C		
				WMT (18X4)RL 1099186 WMT (23X4)RL 1099187

Marking materials for wire and cable identification

Cable markers for marking tags				Additional versions
	Type	Item no.	WMTS (15X4)R	1352325
	Technology			
	Cable diameter		0.6 mm ... 45 mm	
	Text field height		4.00 mm	
	Text field width		15.00 mm	
	Mounting type		Insert	
	Material		PET	
	Ambient temperature		-25°C ... 80°C	
			WMTS (15X4)R YE 1352329 WMTS (18X4)R 1352326 WMTS (18X4)R YE 1352330 WMTS (23X4)R 1352327 WMTS (23X4)R YE 1352331	
	Type	Item no.	EMT (15X4)R	0817329
	Technology			
	Cable diameter		0.6 mm ... 50 mm	
	Text field height		4.00 mm	
	Text field width		15.00 mm	
	Mounting type		Insert	
	Material		Polyester	
	Ambient temperature		-40°C ... 120°C	
			EMT (10X4)R 0816235 EMT (15X4)R YE 0817358 EMT (23X4)R 0817361 EMT (23X4)R YE 0817374	
	Type	Item no.	EMT (25X6)R	0817264
	Technology			
	Cable diameter		10 mm ... 25 mm	
	Text field height		6.00 mm	
	Text field width		25.00 mm	
	Mounting type		Insert	
	Material		Polyester	
	Ambient temperature		-40°C ... 120°C	
			EMT (29X8)R 0817277 EMT (40X17)R 0817293 EMT (60X15)R 0801846	











Marking materials for wire and cable identification

1
2
3
4
Marking material







Cable markers for fastening with cable ties				Additional versions	
	Type	Item no.	UC-WMTB (44X15)	0828376	
	Technology				
	Cable diameter		>7 mm		UC-WMTB (52X30) 5775288
	Text field height		15.00 mm		UC-WMTB (52X50) 5775289
	Text field width		44.00 mm		
	Mounting type		Assembly with cable ties		
	Material		PA		
	Ambient temperature		-40°C ... 120°C		
	Type	Item no.	UC-WMTBA (29X8)	0820183	
	Technology				
	Cable diameter		>6 mm		UC-WMTBA (24X5) 0820426
	Text field height		8.00 mm		UC-WMTBA (60X11) 0820468
	Text field width		29.00 mm		
	Mounting type		Assembly with cable ties		
	Material		PA		
	Ambient temperature		-40°C ... 120°C		
	Type	Item no.	UC-WMTBA (24X5)/PP	1199627	
	Technology				
	Product features		High resistance to chemicals		
	Area of application		Food and beverage industry		UC-WMTBA (29X8)/PP 1199634
	Cable diameter		>4 mm		
	Text field height		5.00 mm		
	Text field width		24.00 mm		
	Mounting type		Assembly with cable ties		
	Ambient temperature		-30°C ... 90°C		
	Type	Item no.	UC-WMTBA-D (24X5)/PP	1312764	
	Technology				
	Product features		Detectable		
	Area of application		Food and beverage industry		UC-WMTBA-D (29X8)/PP 1312767
	Cable diameter		>4 mm		UC-WMTBA-D (29X8)/PP LBU 1199650
	Text field height		5.00 mm		
	Text field width		24.00 mm		
	Mounting type		Assembly with cable ties		
	Ambient temperature		-30°C ... 90°C		
	Type	Item no.	UCT-WMTBA (29X6)	1014084	
	Technology				
	Cable diameter		>6 mm		UCT-WMTBA (24X4) 1014082
	Text field height		6.00 mm		UCT-WMTBA (40X17) 1014086
	Text field width		29.00 mm		
	Mounting type		Assembly with cable ties		
	Material		PC		
	Ambient temperature		-40°C ... 120°C		

Marking materials for wire and cable identification







1
2
3
4
Marking material





Cable markers for fastening with cable ties				Additional versions	
	Type	Item no.	US-WMTB (44X15)	0828773	US-WMTB (24X5) 0828771 US-WMTB (29X8) 0828772
	Technology				
	Cable diameter		>13 mm		
	Text field height		15.00 mm		
	Text field width		44.00 mm		
	Mounting type		Assembly with cable ties		
	Material		PVC		
	Ambient temperature		-30°C ... 80°C		
	Type	Item no.	WMTB (24X8)R	0816278	WMTB (35X15)R 0817316
	Technology				
	Cable diameter		≥6 mm		
	Text field height		8.00 mm		
	Text field width		24.00 mm		
	Mounting type		Assembly with cable ties		
	Material		Polyester		
	Ambient temperature		-40°C ... 120°C		
	Type	Item no.	WMTB HF (40X12)R	0830407	WMTB HF (30X10)R 1369826 WMTB HF (40X18)R 1369832 WMTB HF (55X15)R 0830409 WMTB HF (55X25)R 0830411
	Technology				
	Cable diameter		≥6 mm		
	Text field height		12.00 mm		
	Text field width		40.00 mm		
	Mounting type		Assembly with cable ties		
	Material		PUR		
	Ambient temperature		-25°C ... 100°C		
	Type	Item no.	WMTB HF-HP (40X12)R	1523619	WMTB HF-HP (40X12)R BK 1525870 WMTB HF-HP (40X12)R BU 1525866 WMTB HF-HP (40X12)R GN 1525867 WMTB HF-HP (40X12)R OG 1525868 WMTB HF-HP (40X12)R YE 1523621 WMTB HF-HP (40X12)R RD 1525865 WMTB HF-HP (55X15)R 1523622 WMTB HF-HP (55X15)R YE 1523623
	Technology				
	Area of application		Railway industry		
	Cable diameter		≥6 mm		
	Text field height		12.00 mm		
	Text field width		40.00 mm		
	Mounting type		Assembly with cable ties		
	Material		Polyolefin		
	Ambient temperature		-55°C ... 105°C		
	Type	Item no.	WMTB HF-D (30X10)R BU	1255591	WMTB HF-D (40X12)R BU 1255595
	Technology				
	Product features		Detectable		
	Area of application		Food and beverage industry		
	Cable diameter		≥6 mm		
	Text field height		10.00 mm		
	Text field width		30.00 mm		
	Mounting type		Assembly with cable ties		
	Material		TPU		
	Ambient temperature		-25°C ... 105°C		

Marking materials for wire and cable identification







Cable markers for fastening with cable ties				Additional versions
	Type	Item no.	WMTB-AL (40X15)	0830524
	Technology			
	Cable diameter		>4.60 mm	
	Text field height		15.00 mm	
	Text field width		40.00 mm	
	Mounting type		Assembly with cable ties	
	Material		Aluminum	
	Ambient temperature		-25°C ... 120°C	
	Type	Item no.	LS-WMTB-AL (29X8)	0831500
	Technology			
	Cable diameter		>2.90 mm	
	Text field height		8.00 mm	
	Text field width		29.00 mm	
	Mounting type		Assembly with cable ties	
	Material		Aluminum	
	Ambient temperature		-25°C ... 120°C	
	Type	Item no.	LS-WMTB-V4A (60X15)	0831518
	Technology			
	Cable diameter		>4.60 mm	
	Text field height		15.00 mm	
	Text field width		60.00 mm	
	Mounting type		Assembly with cable ties	
	Material		V4A (1.4404; AISI 316L)	
	Ambient temperature		-80°C ... 350°C	
				WMTB-AL (29X8) 0830805 WMTB-AL (60X15) 0830525 WMTB-AL (D30) 0830804 LS-WMTB-AL (40X15) 0831501 LS-WMTB-AL (60X15) 0831502 LS-WMTB-AL (D25) 0831504 LS-WMTB-AL (D30) 0831505 LS-WMTB-V4A (29X8) 0831516 LS-WMTB-V4A (40X15) 0831517 LS-WMTB-V4A (100X15) 0831519 LS-WMTB-V4A (D30) 0831521 LS-WMTB-V4A (48X8) 1450532

Marking materials for wire and cable identification

Wire-wrap labels				Additional versions	
	Type	Item no.	WML 14 (25X19)R	0817536	
	Technology				
	Cable diameter		6.1 mm ... 14.2 mm		
	Text field height		19.10 mm		
	Text field width		25.40 mm		
	Mounting type		Adhesive		
	Material		PVC		
	Ambient temperature		-40°C ... 80°C		
	Type	Item no.	WML HF 7,5(25X13)R	0830816	
	Technology				
	Cable diameter		4 mm ... 7.6 mm		
	Text field height		12.70 mm		
	Text field width		25.40 mm		
	Mounting type		Adhesive		
	Material		Polyethylene		
	Ambient temperature		-40°C ... 100°C		
	Type	Item no.	US-WML 14 (25X19)	0800473	
	Technology		 		
	Cable diameter		6.1 mm ... 14 mm		
	Text field height		19.00 mm		
	Text field width		25.00 mm		
	Mounting type		Adhesive		
	Material		PVC		
	Ambient temperature		-40°C ... 80°C		
					WML 3 (13X10)R 0800073 WML 5 (25X10)R 0817523 WML 6 (13X13)R 0816252 WML 7,5 (25X13)R 0800075 WML 12 (25X19)R 0800076 WML 22 (25X25)R 0800078 WML 36 (25X38)R 0817510 WML 46 (25X38)R 0800067 WML 8 (51X13)R 1488729 WML 8 (51X13)R YE 1488730 WML 14 (25X19)R OG 1539828 WML 36 (25X38)R OG 1539829
					WML HF 3(13X10)R 0830812 WML HF 5(25X10)R 0830814 WML HF 14(25X19)R 0830818 WML HF 22(25X25)R 0830820 WML HF 36(25X38)R 0830822
					US-WML 6 (13X13) 0800472 US-WML 36 (25X25) 0800474

Cable marking flags				Additional versions	
	Type	Item no.	WML-FLAG 6 (30X10)R	0830712	
	Technology				
	Cable diameter		6 mm		
	Text field height		10.00 mm		
	Text field width		30.00 mm		
	Mounting type		Adhesive		
	Ambient temperature		-40°C ... 60°C		
	Type	Item no.	WML-FLAGV 6 (30X10)R	0830714	
	Technology				
	Cable diameter		6 mm		
	Text field height		10.00 mm		
	Text field width		30.00 mm		
	Mounting type		Adhesive		
	Ambient temperature		-40°C ... 60°C		
					WML-FLAG 6 (20X10)R 0830711
					WML-FLAGV 6 (20X10)R 0830713

Marking materials for wire and cable identification

Shrink and marking sleeve				Additional versions
	Type	Item no.	WMS 4,8 (30X9)R	0800375
	Technology			
	Cable diameter		1.6 mm ... 4.8 mm	WMS 3,2 (30X5)RL 0800387
	Text field height		9.00 mm	WMS 3,2 (EX5)R 0800290
	Text field width		30.00 mm	WMS 4,8 (EX9)R 0800291
	Shrink rate		3:1	WMS 6,4 (30X10)R 0800376
	Shrink temperature		>85°C	
	Mounting type		Slide on	
	Material		Polyolefin	
	Ambient temperature		-55°C ... 125°C	
	Type	Item no.	WMS-2 HF 3,2 (30X5)RL	0801011
	Technology			
	Area of application		Railway industry	WMS-2 HF 3,2 (EX5)RL 0803903
	Cable diameter		1.5 mm ... 3.2 mm	WMS-2 HF 4,8 (30X9)RL 0801016
	Text field height		5.00 mm	WMS-2 HF 4,8 (EX9)RL 0803904
	Text field width		30.00 mm	WMS-2 HF 6,4 (30X10)RL 0801022
	Shrink rate		2:1	WMS-2 HF 25,4 (EX40)R YE 1656684
	Shrink temperature		>90°C	
	Mounting type		Slide on	
	Ambient temperature		-30°C ... 105°C	
	Type	Item no.	WMS-OT HF 2,4 (EX4)R	1163127
	Technology			
	Cable diameter		1 mm ... 2.4 mm	WMS-OT HF 3,2 (EX5)R 1044236
	Text field height		4.00 mm	WMS-OT HF 3,2 (EX5)R YE 1044239
	Text field width		30000.00 mm	WMS-OT HF 4,8 (EX9)R 1044243
	Mounting type		Slide on	WMS-OT HF 4,8 (EX9)R YE 1044245
	Material		Polyolefin	
	Ambient temperature		-30°C ... 125°C	



Marking materials for wire and cable identification







Cable markers in cartridge format / GO SERIES				Additional versions	
	Type	Item no.	MM-WML 5 (24X10)R C1 WH/BK	1116196	MM-WML 7,5 (24X13)R C1 WH/BK 1116198 MM-WML 14 (24X19)R C1 WH/BK 1116146 MM-WML 5 (EX10)R C1 WH/BK 0803932 MM-WML 5 (EX10)R C1 YE/BK 1116138
	Technology				
	Cable diameter		2 mm ... 5 mm		
	Text field height		9.50 mm		
	Text field width		22.00 mm		
	Mounting type		Adhesive		
	Material		Vinyl polymer		
	Ambient temperature		-40°C ... 80°C		
	Type	Item no.	MM-WML-FLAG 6 (20X10)R C1 WH/BK	1116143	MM-WML-FLAG 6 (20X10)R C1 WH/BK 1116190
	Technology				
	Cable diameter		1 mm ... 6 mm		
	Text field height		10.00 mm		
	Text field width		20.00 mm		
	Mounting type		Adhesive		
	Material		Polyolefin		
	Ambient temperature		-40°C ... 60°C		
	Type	Item no.	MM-WMS 3,2 (EX5)R C1 WH/BK	0803923	MM-WMS 3,2 (EX5)R C1 YE/BK 1116139 MM-WMS 4,8 (EX9)R C1 WH/BK 0803924 MM-WMS 4,8 (EX9)R C1 YE/BK 1116140 MM-WMS 6,4 (EX10)R C1 WH/BK 0803925
	Technology				
	Area of application		Railway industry		
	Cable diameter		1 mm ... 3.2 mm		
	Text field height		3.10 mm		
	Text field width		1800.00 mm		
	Shrink rate		3:1		
	Mounting type		Slide on		
	Material		Polyolefin		
Ambient temperature		-55°C ... 125°C			
	Type	Item no.	MM-WMS-2 3,2 (EX5)R C1 WH/BK	0803927	MM-WMS-2 3,2 (EX5)R C1 YE/BK 1116176 MM-WMS-2 4,8 (EX9)R C1 WH/BK 0803928 MM-WMS-2 4,8 (EX9)R C1 YE/BK 1116186 MM-WMS-2 6,4 (EX10)R C1 WH/BK 0803929
	Technology				
	Area of application		Railway industry		
	Cable diameter		1.6 mm ... 3.2 mm		
	Text field height		3.70 mm		
	Text field width		1800.00 mm		
	Shrink rate		2:1		
	Mounting type		Slide on		
	Material		Polyolefin		
Ambient temperature		-55°C ... 125°C			
	Type	Item no.	MM-WMTB HF (40X12)R C1 WH/BK	1116166	MM-WMTB HF (40X12)R C1 YE/BK 1116206 MM-WMTB HF (55X15)R C1 WH/BK 1116207 MM-WMTB HF (55X15)R C1 YE/BK 1116208 MM-WMTB HF (55X25)R C1 WH/BK 1116209
	Technology				
	Cable diameter		6 mm ... 115 mm		
	Text field height		8.50 mm		
	Text field width		40.00 mm		
	Mounting type		Assembly with cable ties		
	Material		PUR		
	Ambient temperature		-25°C ... 80°C		

Marking materials for wire and cable identification



1
2
3
4







Marking material

Cable markers in cartridge format / GO SERIES				Additional versions
	Type	Item no.	MM-WMTB (24X8)R C1 WH/BK	1116145
	Technology			
	Cable diameter		6 mm ... 115 mm	
	Text field height		7.00 mm	
	Text field width		20.00 mm	
	Mounting type		Assembly with cable ties	
	Material		Polyester	
	Ambient temperature		-40°C ... 120°C	
	Type	Item no.	MM-WMT 2,4 (15X4)R C1 WH/BK	1116144
	Technology			
	Cable diameter		1 mm ... 2.4 mm	
	Text field height		3.20 mm	
	Text field width		14.10 mm	
	Mounting type		Slide on	
	Material		Polyester	
	Ambient temperature		-40°C ... 120°C	
			MM-WMT 3,5 (15X5)R C1 WH/BK	1116191
			MM-WMT 4,2 (15X6)R C1 WH/BK	1116192
			MM-WMT 5,5 (15X8)R C1 WH/BK	1116193
			MM-WMT 8,4 (17X10)R C1 WH/BK	1116194

Cable markers for subsequent identification				Additional versions
	Type	Item no.	UCT-WMCO 2,9 (12X4)	0830780
	Technology			
	Cable diameter		2 mm ... 2.9 mm	
	Text field height		4.00 mm	
	Text field width		12.00 mm	
	Mounting type		Clip on	
	Material		PC	
	Ambient temperature		-40°C ... 120°C	
	Type	Item no.	UC-WMC 3,1 (15X4)	0818205
	Technology			
	Cable diameter		1.9 mm ... 3.1 mm	
	Text field height		4.00 mm	
	Text field width		15.00 mm	
	Mounting type		Clip on	
	Material		PA	
	Ambient temperature		-40°C ... 120°C	
			UC-WMCO 2,9 (18X4)	0830781
			UC-WMCO 3,5 (12X4)	0830782
			UC-WMCO 3,5 (18X4)	0830783
			UC-WMCO 4,1 (18X4)	0830785
	Type	Item no.	UC-WMCO 2,9 (12X3,5)	0827148
	Technology			
	Cable diameter		2.1 mm ... 2.9 mm	
	Text field height		3.50 mm	
	Text field width		12.00 mm	
	Mounting type		Slide on	
	Material		PA	
	Ambient temperature		-40°C ... 120°C	
			UC-WMC 1,9 (15X4)	0828004
			UC-WMC 3,1 (23X4)	0818218
			UC-WMC 4,4 (15X5,5)	0818182
			UC-WMC 7,5 (23X8)	0818179
			UC-WMCO 2,1 (12X3)	0827120
			UC-WMCO 2,1 (21X3)	0827134
			UC-WMCO 3,6 (12X4,5)	0827176
			UC-WMCO 3,6 (21X4,5)	0827190

Marking materials for wire and cable identification

Slide-on cable markers				Additional versions	
	Type	Item no.	UCT-WMS 3,2 (12X4)	0828570	UCT-WMS 4,7 (12X5,5) 0828571
	Technology				
	Cable diameter	1.5 mm ... 3.2 mm			
	Text field height	4.00 mm			
	Text field width	12.00 mm			
	Mounting type	Slide on			
	Material	PC			
	Ambient temperature	-40°C ... 100°C			

Cable markers for office printing systems				Additional versions	
	Type	Item no.	WML 7,5 (25X13)A4	0830691	WML 3 (13X10)A4 0830687 WML 5 (25X10)A4 0830689 WML 14 (25X19)A4 0830693 WML 22 (35X25)A4 0830695 WML 36 (25X38)A4 0830697
	Technology				
	Cable diameter	4 mm ... 7.6 mm			
	Text field height	12.70 mm			
	Text field width	25.00 mm			
	Mounting type	Adhesive			
	Material	Polyester			
	Ambient temperature	-40°C ... 150°C			
	Type	Item no.	ESL (25X6)	0801849	ESL 24X4 0808231 ESL 29X8 0808257 ESL 40X17 0808095 ESL (60X15) 0801851
	Technology				
	Text field height	6.00 mm			
	Text field width	25.00 mm			
	Mounting type	Insert			
	Material	Polyester foil			
	Ambient temperature	-40°C ... 100°C			
	Type	Item no.	PABL 15X4	0808260	PABL 23X4 0809447
	Technology				
	Cable diameter	0.6 mm ... 50 mm			
	Text field height	4.00 mm			
	Text field width	15.00 mm			
	Mounting type	Insert			
	Ambient temperature	-40°C ... 100°C			

Marking materials for wire and cable identification

Marked cable markers for fastening with cable ties				Additional versions
	Type	Item no.	SD-WMTBS (NEUTRAL) CC	0826637
	Cable diameter		>16 mm	
	Text field height		2.60 mm	
	Text field width		4.30 mm	
	Mounting type		Slide on	
	Material		PVC	
	Ambient temperature		-30°C ... 60°C	
	Type	Item no.	SD-WMTB (70X10)	0826530
	Cable diameter		>16 mm	
	Text field height		10.00 mm	
	Text field width		70.00 mm	
	Mounting type		Assembly with cable ties	
	Material		PVC	
	Ambient temperature		-30°C ... 70°C	
	Type	Item no.	SD-WMTBS (NEUTRAL) VA	0826666
	Cable diameter		1 mm ... 63 mm	
	Text field height		4.00 mm	
	Text field width		5.50 mm	
	Mounting type		Slide on	
	Material		Stainless steel	
	Ambient temperature		-80°C ... 400°C	
	Type	Item no.	SD-WMTB (30X10) VA	0826569
	Cable diameter		>16 mm	
	Text field height		10.00 mm	
	Text field width		30.00 mm	
	Mounting type		Assembly with cable ties	
	Material		Stainless steel	
	Ambient temperature		-80°C ... 400°C	
				SD-WMTBS (CH) YE 0826611 SD-WMTBS (NU) CC 0826527 SD-WMTBS (S) YE 0826514 SD-WMTBS (SY) YE 0826624
				SD-WMTB (100X10) 0826543
				SD-WMTBS (CH) VA 0826640 SD-WMTBS (NU) VA 0826556 SD-WMTBS (SY) VA 0826653
				SD-WMTB (70X10) VA 0826585 SD-WMTB (92X10) VA 0826598

Marking materials for wire and cable identification

Marker carriers and marking sleeves				Additional versions
	Type	Item no.	PATG 1/15	1013025
	Cable diameter		1.5 mm ... 2.5 mm	PATG 2/15 1013038
	Text field height		4.00 mm	PATG 3/15 1013041
	Text field width		15.00 mm	PATG 1/18 0820510
	Mounting type		Slide on	PATG 2/18 0820523
	Material		PVC	PATG 3/18 0820536
	Ambient temperature		-50°C ... 80°C	PATG 1/23 1013847
				PATG 2/23 1013850
			PATG 3/23 1013863	
	Type	Item no.	PATG HF 1/15	1014046
	Area of application		Railway industry	PATG HF 2/15 1014052
	Cable diameter		1.3 mm ... 2.8 mm	PATG HF 3/15 1014058
	Text field height		4.00 mm	PATG HF 4/15 1014064
	Text field width		15.00 mm	PATG HF 1/18 1014047
	Mounting type		Slide on	PATG HF 2/18 1014053
	Material		TPU	PATG HF 3/18 1014059
	Ambient temperature		-40°C ... 85°C	PATG HF 4/23 1014066
	Type	Item no.	PATO 1/15	1013119
	Cable diameter		2 mm ... 3.5 mm	PATO 2/15 1013122
	Text field height		4.00 mm	PATO 3/15 1013135
	Text field width		15.00 mm	PATO 4/15 1013148
	Mounting type		Clip on	PATO 1/18 0823740
	Material		PVC	PATO 2/18 0823753
	Ambient temperature		-50°C ... 80°C	PATO 1/23 1013892
				PATO 2/23 1013902
	Type	Item no.	WM-CARRIER/B (55X15)LPR	0830424
	Cable diameter		≥9 mm	WM-CARRIER/B (48X10)LPR 0830423
	Text field height		15.00 mm	WM-CARRIER/B (85X15)LPR 0830425
	Text field width		55.00 mm	
	Mounting type		Assembly with cable ties	
	Material		Polyester	
	Ambient temperature		-10°C ... 60°C	
	Type	Item no.	KMK	1005208
	Cable diameter		10 mm ... 25 mm	
	Text field height		8.00 mm	
	Text field width		29.00 mm	
	Mounting type		Assembly with cable ties	
	Material		Polyethylene	
	Ambient temperature		-40°C ... 80°C	



Marking materials for wire and cable identification

Marker carriers and marking sleeves				Additional versions	
	Type	Item no.	KMK UV (29X8)	1014107	KMK UV (25X6) 1014106 KMK UV (40X17) 1014109 KMK UV (60X15) 1014108
	Area of application		Outdoors		
	Cable diameter		≥6 mm		
	Text field height		8.00 mm		
	Text field width		29.00 mm		
	Mounting type		Assembly with cable ties		
	Material		PA		
	Ambient temperature		-40°C ... 100°C		
	Type	Item no.	KMK HP (29X8)	0830721	KMK HP (60X15) 0830722 KMK HP (40X17) 0830723 KMK HP (25X6) 0830720
	Area of application		Railway industry		
	Cable diameter		≥6 mm		
	Text field height		8.00 mm		
	Text field width		29.00 mm		
	Mounting type		Assembly with cable ties		
	Material		PC		
	Ambient temperature		-40°C ... 125°C		
	Type	Item no.	KMK 2	1005266	KMK 1 0830745 KMK 3 1005211 KMK 4 1005305 KMK 5 0830746
	Cable diameter		≥6 mm		
	Text field height		8.00 mm		
	Text field width		29.00 mm		
	Mounting type		Assembly with cable ties		
	Material		Polyethylene		
	Ambient temperature		-40°C ... 80°C		
	Type	Item no.	LM	1004377	
	Cable diameter		1 mm ... 12 mm		
	Text field height		4.00 mm		
	Text field width		24.00 mm		
	Mounting type		Assembly with cable ties		
	Material		PA		
	Ambient temperature		-40°C ... 100°C		
	Type	Item no.	KME	0807083	
	Cable diameter		>5 mm		
	Text field height		8.00 mm		
	Text field width		20.00 mm		
	Mounting type		Assembly with cable ties		
	Material		PA		
	Ambient temperature		-40°C ... 100°C		

Marking materials for wire and cable identification

1
2
3
4

Marking material

Marker carriers and marking sleeves				Additional versions	
	Type	Item no.	PAB-KTL 23	1013957	PAB-KTL 1013261
	Cable diameter		>10 mm		
	Text field height		4.00 mm		
	Text field width		23.00 mm		
	Mounting type		Assembly with cable ties		
	Material		PVC		
	Ambient temperature		-50°C ... 80°C		
	Type	Item no.	PKT 9X20	0803977	
	Cable diameter		>10 mm		
	Text field height		9.00 mm		
	Text field width		20.00 mm		
	Mounting type		Assembly with cable ties		
	Material		PVC		
	Ambient temperature		-50°C ... 80°C		



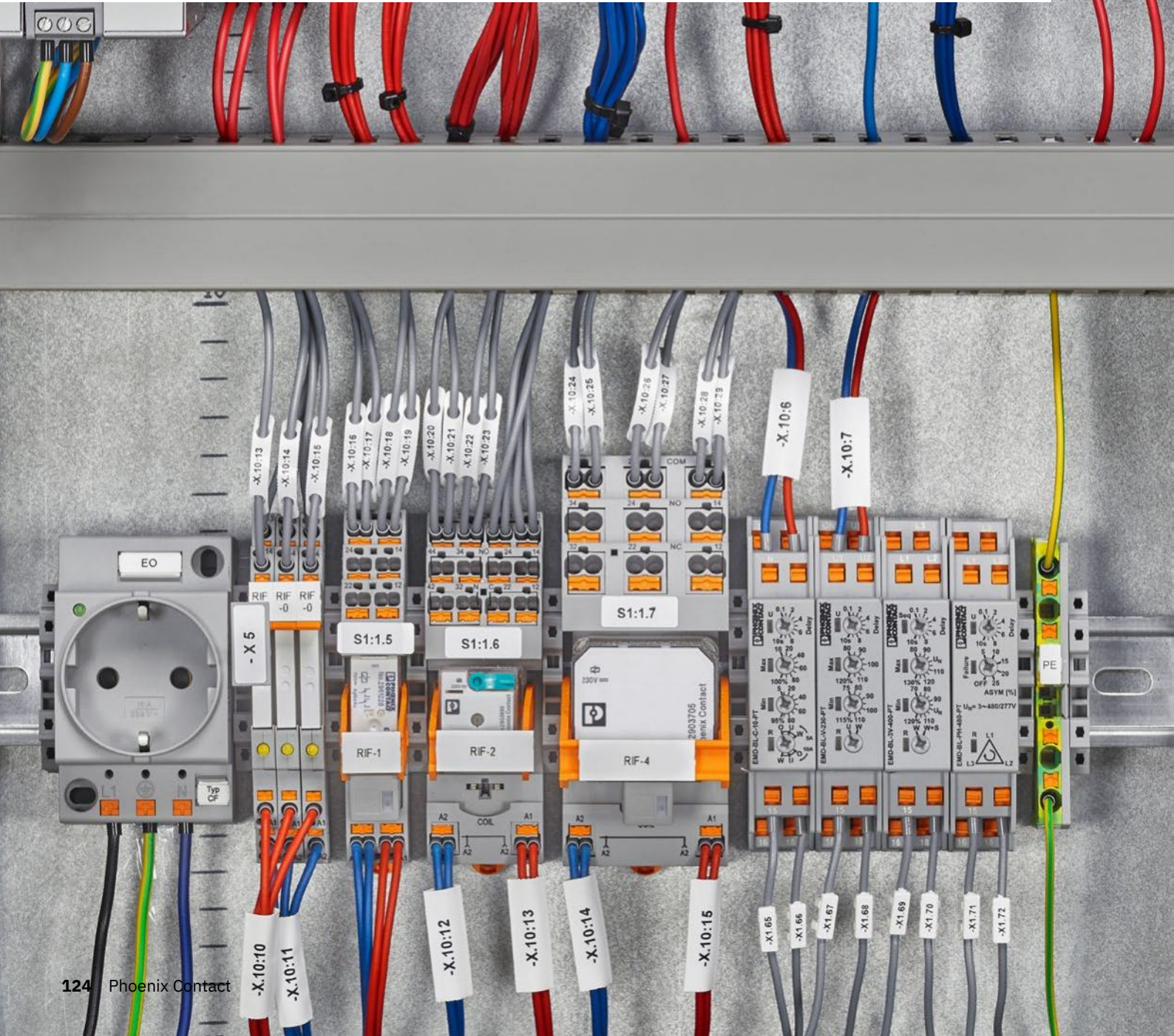

Marking material

Equipment identification





Whether in the control cabinet, in production plants, in the field, or in outdoor installations – equipment markings are used everywhere. This multitude of applications places numerous demands on the markings used, which can only be met with specialized materials and special adhesives. For uneven surfaces, for example, highly flexible PVC labels that mold themselves perfectly to the surface are ideal. On the other hand, only labels with special and particularly strong adhesives will bond to rough and low-energy surfaces.



Designation key: Equipment identification











					Technology
Equipment identification: Marking solutions in roll format					
EML	Equipment Marking	Label		Self-adhesive, flexible labels	 Thermal transfer printing
EMLP			Plate	Self-adhesive labels	
EMLF			Flexible	Highly flexible labels for uneven surfaces	
EMLC			Cloth	Fabric labels with low restoring forces enabling the label to be adhered over edges and curves	
EMLS			Security	Safety labels with special adhesive	
EML-RM			Removable	Removable labels for temporary identification in logistics processes	
EML-HT			High Temperature	Labels with very high temperature resistance for special manufacturing processes	
EML-LT			Low Temperature	Labels for the identification of components in refrigerated and frozen environments	
EML-HA			High adhesive	Labels with high adhesive strength for rough, textured, and low-energy surfaces	
EML-D			Detectable	Detectable labels for the food and beverage industry	
EML-LPR			Label Protection	Labels with transparent protective laminate for maximum resistance against external influences	
EML-LPR-D			Label Protection Detectable	Detectable labels with transparent protective laminate	
EML-RS			Rotary switch	Labels for the identification of rotary switches	
EMT		Tag		Insert labels for the identification of KMK... marker carriers and Siemens controllers	
Equipment identification: Marking solutions in sheet format					
UC-EM	Universal Card	Equipment Marking		Snap-in labels for the identification of components with marking groove	 UV inkjet printing Plotter
UC-EMP			Plate	Snap-in labels for the identification of CARRIER-EMP... marker carriers	
UC-EMSP			Screw Plate	Plastic labels attached with screws or rivets	
UC-EMLP			Label Plate	Self-adhesive plastic labels	
UCT-EM	Universal Card thermal transfer	Equipment Marking		Snap-in labels for the identification of components with marking groove	  Direct laser marking UV inkjet printing Thermal transfer printing
UCT-EMP			Plate	Snap-in labels for the identification of CARRIER-EMP... marker carriers	
UCT-EMNP			Nail Plate	Insert labels for the identification of the Festo CPX-AP-I automation system	











Designation key: Equipment identification

Designation key					Technology		
Equipment identification: Marking solutions in card format							
US-EML	Universal Sheet	Equipment Marking	Label		Self-adhesive, flexible labels	  UV inkjet printing Thermal transfer printing	
US-EMLF			Label Flexible		Highly flexible labels for uneven surfaces		
US-EMLP			Label Plate		Self-adhesive plastic labels		
US-EMLP-HA			Label Plate	High adhesive	Self-adhesive plastic labels with high adhesive strength for rough, textured, and low-energy surfaces		
US-EMLSP			Label Screw Plate		Plastic labels that are stuck on or attached with screws or rivets		
US-EML-RS			Label	Rotary switch	Labels for the identification of rotary switches		
US-EMP			Plate		Snap-in labels for the identification of CARRIER-EMP... marker carriers		
US-EMSP			Screw Plate		Plastic labels attached with screws or rivets		
US-EMT			Tag		Insert labels for the identification of KMK... marker carriers and Siemens controllers		
Equipment identification: Marking solutions in sheet format							
LS-EML	Laser Sheet	Equipment Marking	Label		Self-adhesive, flexible labels	 Direct laser marking	
LS-EMLP-AL			Label Plate	Aluminum	Self-adhesive aluminum labels		
LS-EMLP-V4A				V4A	Self-adhesive stainless steel labels		
LS-EMLP					Self-adhesive plastic labels		
LS-EMP-AL			Plate	Aluminum	Aluminum labels for latching into marker carriers		
LS-EMLSP			Label Screw Plate		Plastic labels that are stuck on or attached with screws or rivets		
LS-EMSP-AL			Screw Plate	Aluminum	Aluminum labels attached with screws or rivets		
LS-EMSP-V4A				V4A	Stainless steel labels attached with screws or rivets		
Equipment identification: Marking solutions in cartridge format							
MM-EML	Mobile Marking	Equipment Marking	Label		Self-adhesive, flexible labels	 Thermal transfer printing	
MM-EMLF			Label Flexible		Highly flexible labels for uneven surfaces		
MM-EMLC			Label Cloth		Fabric labels with low restoring forces enabling the label to be adhered over edges and curves		
MM-EMT			Tag		Insert labels for the identification of KMK... marker carriers and Siemens controllers		
Equipment identification: Individual labels							
EMP-AL	Equipment Marking	Plate	Aluminum	Aluminum labels for snapping into CARRIER-EMP... marker carriers		 UV inkjet printing	
EMSP-AL		Screw Plate		Aluminum labels attached with screws or rivets			
EMLP-AL		Label Plate		Self-adhesive aluminum labels			

Equipment identification











1
2
3
4
Marking material

Marker carriers for equipment identification								
								
Product group		CARRIER-EMP...	CARRIER-EMP 22...	CARRIER-EMLP 22...				
Product type		Marker carrier	Marker carrier	Marker carrier				
Mounting type		Screws, rivets	Screws, rivets	Screws, rivets				
Mounting type of the marking material		Insertion	Insertion	Adhesive				
Area of application		Equipment and control cabinets	Can be used for all buttons and switches, diameter: 22 mm	Can be used for all buttons and switches, diameter: 22 mm				
Marking material product group	Compatible printing technology							
								
UCT-TM...		•	•	•				
UCT-TMF...		•	•	•				
US-TMF...		•	•					
ZB					•			
ZBF...					•			
TMT...	•							
UCT-WMT		•	•	•				
UC-WMT			•	•				
US-WMT		•	•					
US-EMP...		•	•			•	•	
US-EMLP...		•	•				•	
UC-EM...			•	•				
UC-EMP...			•	•		•	•	
UCT-EMP...		•	•	•				
UC-EMLP...			•	•			•	
EMT...	•							
EML...	•						•	
EMP-AL...	•					•	•	
LS-EMP-AL...				•		•	•	
EMLP...	•						•	
EMLP-AL...	•						•	
LS-EMLP				•			•	
SS-ZB					•			









					
PAB-SK...	P-SS-ZB 100	P-ZB METER	CARRIER-EMP...	CARRIER / L-EMP...	CARRIER / L-EMP... COVER
Marker carrier	Zack marker strip carrier	Zack marker strip carrier	Marker carrier	Marker carrier	Cover
Adhesive	Adhesive	Adhesive	Screws, rivets	Adhesive	Latching
Insertion	Insertion	Insertion	Insertion	Insertion	/
Self-adhesive marker carriers for equipment and component identification	Self-adhesive zack marker strip carriers for equipment and component identification, by the meter for cutting to length	Self-adhesive zack marker strip carriers, by the meter for cutting to length	Marker carriers for screwing or riveting for equipment and component identification	Self-adhesive marker carrier for holding UC, US, LS, and EMT material	For CARRIER/EMP... + CARRIER/L-EMP...
					
		•			
		•			
		•			
		•			
		•			
		•			
•					
•					
•					
			•	•	
	•				
	•		•	•	
			•	•	
•			•	•	
			•	•	
	•				

Marking materials for equipment identification







Marking material

Self-adhesive device markers				Additional versions	
	Type	Item no.	EML (20X8)R YE	0816799	
	Technology				EML (16,5X5)R 0816702 EML (25,4X12,7)R 0816825 EML (70X50)R 0817099 EML (100X73)R 0817125 EML (60X210)R YE 1488728 EML (80X200)R YE 1688725
	Text field height		8.00 mm		
	Text field width		20.00 mm		
	Mounting type		Adhesive		
	Material		Polyester		
	Ambient temperature		-40°C ... 100°C		
	Type	Item no.	EMLF (108XE)R YE	0800550	
	Technology				EMLF (108XE)R 0800549 EMLF (108XE)R OG 0804199 EMLF (108XE)R RD 0804198 EMLF (108XE)R SR 0800551
	Product features		Highly flexible		
	Text field height		108.00 mm		
	Text field width		48000.00 mm		
	Mounting type		Adhesive		
	Material		PVC		
	Ambient temperature		-40°C ... 100°C		
	Type	Item no.	EMLC (20X8)R YE	0800235	
	Technology				EMLC (5,5X40)R 0817620 EMLC (15X9)R 0804527 EMLC (17,5X8)R 0804528 EMLC (25,4X12,7)R YE 0800238 EMLC (19X12,7)RL 1645742 EMLC (20X8)RL 1645500 EMLC (36,5X20)RL 1645743
	Product features		Low restoring force		
	Text field height		8.00 mm		
	Text field width		20.00 mm		
	Mounting type		Adhesive		
	Material		PA		
	Ambient temperature		0°C ... 125°C		
	Type	Item no.	EMLP (27X18)R SR	0819534	
	Technology				EMLP (22X12)R 0819495 EMLP (27X12,5)R 0804488 EMLP (27X27)R SR 0827467 EMLP (45X15)R 0801820 EMLP (45X25)R 0802727 EMLP (60X15)R 1466840 EMLP (60X30)R 0819505 EMLP (85,6X54)R 1096325 EMLP (100X30)R 1096330 EMLP (27X12,5)RL 1645504
	Text field height		18.00 mm		
	Text field width		27.00 mm		
	Mounting type		Adhesive		
	Material		Polyester		
	Ambient temperature		-40°C ... 120°C		
	Type	Item no.	US-EML (17,5X8)	0800461	
	Technology		 		US-EML (15X6) 0803816 US-EML (15X9) 0803811 US-EML (20X8) 0800458 US-EML (104X140) 0800465
	Text field height		8.00 mm		
	Text field width		17.50 mm		
	Mounting type		Adhesive		
	Material		Polyester		
	Ambient temperature		-40°C ... 150°C		
	Type	Item no.	US-EMLP (85,6X54)	0828806	
	Technology		 		US-EMLP (17X7) 0828792 US-EMLP (20X9) 0828795 US-EMLP (49X15) 0828803 US-EMLP (60X30) 0828805
	Text field height		54.00 mm		
	Text field width		85.60 mm		
	Mounting type		Adhesive		
	Material		PVC		
	Ambient temperature		-30°C ... 80°C		

Marking materials for equipment identification

Self-adhesive device markers				Additional versions	
	Type	Item no.	US-EMLF (104X70)	1014294	US-EMLF (104X140) US-EMLF (D39)
	Technology				
	Product features		Low restoring force		
	Area of application		Combi labels		
	Text field height		70.00 mm		
	Text field width		104.00 mm		
	Mounting type		Adhesive		
	Material		PVC		
	Ambient temperature		-40°C ... 100°C		
				1014291 0803845	
	Type	Item no.	UC-EMLP (20X8)	0819327	UC-EMLP (17X9)
	Technology				
	Text field height		8.00 mm		
	Text field width		20.00 mm		
	Mounting type		Adhesive		
	Material		PA		
	Ambient temperature		-40°C ... 120°C		
				0819314	
	Type	Item no.	UC-EMLP (60X30)-EX	0803228	UC-EMLP (27X27)-EX UC-EMLP (49X15)-EX
	Technology				
	Product features		Highly resistant to chemicals		
	Text field height		30.00 mm		
	Text field width		60.00 mm		
	Mounting type		Adhesive		
	Ambient temperature		-40°C ... 90°C		
				0803226 0803227	
	Type	Item no.	LS-EML (180X180)/PET BK-WH	1729992	LS-EML (180X180) SR-BK
	Technology				
	Text field height		180.00 mm		
	Text field width		180.00 mm		
	Mounting type		Adhesive		
	Ambient temperature		-40°C ... 130°C		
				0831785	
	Type	Item no.	LS-EMLP (180X180) SR	0804347	LS-EMLP (20X8) WH LS-EMLP (27X18) WH LS-EMLP (60X30) WH LS-EMLP (180X180) WH LS-EMLP (75X35) WH
	Technology				
	Text field height		180.00 mm		
	Text field width		180.00 mm		
	Mounting type		Adhesive		
	Material		ABS		
	Ambient temperature		-20°C ... 60°C		
				0831685 0831691 0831697 0804346 1558015	





Marking materials for equipment identification

Device markers that are stuck on or attached with screws or rivets				Additional versions	
	Type	Item no.	UC-EMSP (50X30)	0828709	UC-EMSP (50X15) 0828706
	Technology		 		
	Text field height		30.00 mm		
	Text field width		50.00 mm		
	Mounting type		Screw, rivet		
	Material		PA		
	Ambient temperature		-40°C ... 120°C		
	Type	Item no.	US-EMSP (75,6X54)	0828787	US-EMSP(46X30) 0804490 US-EMSP (50X30) 0828786 US-EMSP (90X60) 0828788
	Technology		 		
	Text field height		54.00 mm		
	Text field width		75.60 mm		
	Mounting type		Screw, rivet		
	Material		PVC		
	Ambient temperature		-30°C ... 80°C		
	Type	Item no.	US-EMLSP (28X10)	0830343	
	Technology		 		
	Text field height		10.00 mm		
	Text field width		28.00 mm		
	Mounting type		Adhesive, screw, rivet		
	Material		PVC		
	Ambient temperature		-30°C ... 80°C		
	Type	Item no.	LS-EMLSP (21,5X15) WH	1045512	LS-EMLSP (70,8X40) WH 1069847
	Technology				
	Product features		In addition adhesive		
	Text field height		15.00 mm		
	Text field width		21.50 mm		
	Mounting type		Adhesive, screw, rivet		
	Ambient temperature		-20°C ... 60°C		
	Type	Item no.	LS-EMSP-AL (50X15)	0831616	LS-EMSP-AL (40X15) 1,5 0804645 LS-EMSP-AL (75,6X54) BU 0831646 LS-EMSP-AL (110X80) BK 0831631 LS-EMSP-AL (150X120) BK 0831633 LS-EMSP-AL (91X60) R0 1438087
	Technology				
	Text field height		15.00 mm		
	Text field width		50.00 mm		
	Mounting type		Screw, rivet		
	Material		Aluminum		
	Ambient temperature		-25°C ... 120°C		

Marking materials for equipment identification

Device markers that are stuck on or attached with screws or rivets				Additional versions	
	Type	Item no.	LS-EMLP-AL (85,6X54) BK	0831594	
	Technology				LS-EMLP-AL (27X15) BK 0831589 LS-EMLP-AL (60X30) BK 0831593 LS-EMLP-AL (85,6X54) BU 0831607 LS-EMLP-AL (100X60) 0831586 LS-EMLP-AL (100X40) 1689500 LS-EMLP-AL (45X25) 1689499
	Text field height		54.00 mm		
	Text field width		85.60 mm		
	Mounting type		Adhesive		
	Material		Aluminum		
	Ambient temperature		-25°C ... 70°C		
	Type	Item no.	LS-EMSP-V4A (75,6X54)	0831656	
	Technology				LS-EMSP-V4A (50X15) 0831654 LS-EMSP-V4A (50X30) 0831655 LS-EMSP-V4A (50X30) 2H 0803992 LS-EMSP-V4A (90X60) 0831657 LS-EMSP-V4A (140X100) 1 1030550
	Text field height		54.00 mm		
	Text field width		75.60 mm		
	Mounting type		Screw, rivet		
	Material		V4A (1.4404; AISI 316L)		
	Ambient temperature		-80°C ... 350°C		
	Type	Item no.	LS-EMLP-V4A (60X30)	0803991	
	Technology				LS-EMLP-V4A (50X15) 1019818 LS-EMLP-V4A (60X15) 1031604
	Text field height		30.00 mm		
	Text field width		60.00 mm		
	Mounting type		Adhesive		
	Material		V4A (1.4404; AISI 316L)		
	Ambient temperature		-40°C ... 250°C		
	Type	Item no.	LS-EMSP-AL 2L (20X15) 1	1634318	
	Technology				LS-EMSP-AL 2L (40X15) 1 1631672
	Text field height		15.00 mm		
	Text field width		20.00 mm		
	Mounting type		Screw, rivet		
	Material		Aluminum		
Ambient temperature		-20°C ... 150°C			





Marking materials for equipment identification

Device markers for latching				Additional versions
	Type	Item no.	UC-EM (20X9)	0825503
	Technology			
	Text field height	9.00 mm		
	Text field width	20.00 mm		
	Mounting type	Latching		
	Material	PA		
	Ambient temperature	-40°C ... 120°C		
				UC-EM (17,5X8) 0823766 UC-EM (17,5X9) 0827490 UC-EM (19X9) 0827492 UC-EM (20X7) 0825499
	Type	Item no.	UC-EMP (27X18)	0825445
	Technology			
	Text field height	18.00 mm		
	Text field width	27.00 mm		
	Mounting type	Latching		
	Material	PA		
	Ambient temperature	-40°C ... 120°C		
				UC-EMP (17X15) 0825421 UC-EMP (27X8) 0825427 UC-EMP (27X15) 0825439 UC-EMP (49X15) 0825457
	Type	Item no.	UCT-EM (20X9)	0801471
	Technology			
	Text field height	9.00 mm		
	Text field width	20.00 mm		
	Mounting type	Latching		
	Material	PC		
	Ambient temperature	-40°C ... 120°C		
				UCT-EM (12X7) 0801501 UCT-EM (15X10) 0801504 UCT-EM (17X9) 0801475
	Type	Item no.	US-EMT (23X109)	0803858
	Technology			
	Text field height	23.00 mm		
	Text field width	109.00 mm		
	Mounting type	Latching		
	Material	Polyester		
	Ambient temperature	-40°C ... 120°C		
				US-EMT (13X109) 0803862 US-EMT (31X12,5) 0803848 US-EMT (50/28X13) 0803853 US-EMT (103X23) 0803856
	Type	Item no.	US-EMP (27X18)	0828778
	Technology			
	Text field height	18.00 mm		
	Text field width	27.00 mm		
	Mounting type	Latching		
	Material	PVC		
	Ambient temperature	-30°C ... 80°C		
				US-EMP (27X15) 0828777 US-EMP (29X8) 0829436 US-EMP (44X7) 0829438 US-EMP (49X15) 0828780
	Type	Item no.	EMT (EX15)R	0830671
	Technology			
	Text field height	15.00 mm		
	Text field width	50000.00 mm		
	Mounting type	Latching		
	Material	PVC		
	Ambient temperature	-30°C ... 80°C		
				EMT (EX14)R 0803461 EMT (EX17)R 0804546 EMT (EX38)R 0804547 EMT (EX40)R 0804545

Marking materials for equipment identification



1
2
3
4



Marking material



Device markers for latching				Additional versions	
	Type	Item no.	LS-EMP (37X18) WH	1558020	LS-EMP (75X38) WH 1558021 LS-EMP (89X76) WH 1558022
	Technology				
	Text field height		18.00 mm		
	Text field width		37.00 mm		
	Mounting type		Insert		
	Material		ABS		
	Ambient temperature		-20°C ... 60°C		
	Type	Item no.	LS-EMP-AL (27X15)	0831661	LS-EMP-AL (27X18) 0831662 LS-EMP-AL (49X15) 0831663 LS-EMP-AL (100X60) 0831667 LS-EMP-AL 22,5 (30X17) 1350943
	Technology				
	Text field height		15.00 mm		
	Text field width		27.00 mm		
	Mounting type		Latching		
	Material		Aluminum		
	Ambient temperature		-25°C ... 120°C		

Marking materials for equipment identification





1
2
3
4
Marking material

Sustainable identification solution for loading bins in logistics				Additional versions
	Type	Item no.	EMT (95X140)R WH-WH	1463688
	Technology			
	Text field height	140.00 mm		
	Text field width	95.00 mm		
	Mounting type	Assembly with cable ties		
	Material	Synthetic paper		
	Ambient temperature	120°C		

Device markers for insertion				Additional versions
	Type	Item no.	UCT-EMNP (12,5X6)	1025150
	Technology			
	Area of application	Festo: CPX-AP-I automation system		
	Text field height	6.00 mm		
	Text field width	12.50 mm		
	Mounting type	Plug in		
	Ambient temperature	-40°C ... 120°C		

Device markers for insertion in marker carriers				Additional versions
	Type	Item no.	UCT-EMP (29X8)	1014118
	Technology			
	Text field height	8.00 mm		
	Text field width	29.00 mm		
	Mounting type	Insert		
	Material	PC		
	Ambient temperature	-40°C ... 120°C		



[UCT-EMP \(25X6\)](#) [1014117](#)
[UCT-EMP \(35X9\)](#) [1058145](#)
[UCT-EMP \(40X17\)](#) [1014120](#)
[UCT-EMP \(60X15\)](#) [1014119](#)





Detectable device markers				Additional versions
	Type	Item no.	EML-LPR-D (85,6X54)R SR	1255579
	Technology			
	Product features	Detectable, with protective laminate		
	Text field height	54.00 mm		
	Text field width	85.60 mm		
	Mounting type	Adhesive		
	Ambient temperature	-40°C ... 100°C		
	Type	Item no.	EML-D (40X15)R SR	1054877
	Technology			
	Product features	Detectable		
	Text field height	15.00 mm		
	Text field width	40.00 mm		
	Mounting type	Adhesive		
	Ambient temperature	-40°C ... 100°C		

[EML-LPR-D \(85,6X54\)R YE](#) [1255580](#)
[EML-LPR-D \(85,6X54\)R RD](#) [1255581](#)
[EML-LPR-D \(100X73\)R SR](#) [1255582](#)
[EML-LPR-D \(100X73\)R YE](#) [1255583](#)
[EML-LPR-D \(100X73\)R RD](#) [1255584](#)





[EML-D \(40X15\)R](#) [1054876](#)
[EML-D \(60X30\)R SR](#) [1054879](#)
[EML-D \(60X30\)R](#) [1054878](#)
[EML-D \(20X8\)R](#) [1182298](#)

Marking materials for equipment identification











Device markers with protective laminate				Additional versions	
	Type	Item no.	EML-LPR (100X73)R SR	1090082	
	Technology				
	Product features		With protective laminate		EML-LPR (70X32)R SR 1090079
	Text field height		73.00 mm		EML-LPR (70X50)R SR 1090080
	Text field width		100.00 mm		EML-LPR (85,6X54)R SR 1090081
	Mounting type		Adhesive		
	Material		Polyester		
	Ambient temperature		-40°C ... 150°C		

Device markers with special adhesive properties				Additional versions	
	Type	Item no.	EMLS (76X51)R SR	0800350	
	Technology				
	Product features		Tamper-proof		EMLS (15X9)R SR 0800347
	Text field height		51.00 mm		EMLS (26,5X12)R SR 0800353
	Text field width		76.00 mm		EMLS (60X30)R SR 0800355
	Mounting type		Adhesive		EMLS (70X32)R SR 0800346
	Material		Polyester		
	Ambient temperature		-40°C ... 150°C		
	Type	Item no.	EML-HA (40X8)R	0830604	
	Technology				
	Product features		Highly adhesive		EML-HA (19X6)R 0830601
	Text field height		8.00 mm		EML-HA (60X30)R 0830606
	Text field width		40.00 mm		EML-HA (76X51)R 0830609
	Mounting type		Adhesive		EML-HA (100X90)R 0830732
	Material		Polyester		
	Ambient temperature		-40°C ... 150°C		
	Type	Item no.	EML-RM (25X8)R	0830533	
	Technology				
	Product features		Removable		EML-RM (8X8)R 0830528
	Text field height		8.00 mm		EML-RM (15X6)R 0830529
	Text field width		25.00 mm		EML-RM (25XE)RL 0804195
	Mounting type		Adhesive		EML-RM (70X50)R 0803186
	Material		Polyester		
	Ambient temperature		-40°C ... 120°C		
	Type	Item no.	EML-LT (40X150)R	1314240	
	Technology				
	Product features		Resistant to low temperatures		EML-LT (40X150)R YE 1314241
	Text field height		40.00 mm		
	Text field width		150.00 mm		
	Mounting type		Adhesive		
	Material		Polyester		
	Ambient temperature		-40°C ... 120°C		







Marking materials for equipment identification

Device markers with special adhesive properties				Additional versions	
	Type	Item no.	EML-HT (40X15)R	0800339	
	Technology				
	Product features		Resistant to high temperatures		EML-HT (15X6)R 0830644
	Text field height		15.00 mm		EML-HT (20X7)R 0830645
	Text field width		40.00 mm		EML-HT (45X5)R 0800337
	Mounting type		Adhesive		EML-HT (50X10)R 0800338
	Material		Acrylate		
	Short-term temperature		300°C (max. 1 minute)		
	Ambient temperature		-40°C ... 180°C		
	Type	Item no.	US-EMLP-HA (85,6X54)	0830992	
	Technology		 		
	Product features		Highly adhesive		US-EMLP-HA (17X7) 0830988
	Text field height		54.00 mm		US-EMLP-HA (20X9) 0830989
	Text field width		85.60 mm		US-EMLP-HA (60X30) 0830990
	Mounting type		Adhesive		US-EMLP-HA 24 (30X18/8) 0803876
	Material		PVC		US-EMLP-HA (104X135) 1655569
	Ambient temperature		-30°C ... 80°C		







Marking materials for equipment identification





Plastic labels for the identification of safety buttons				Additional versions	
	Type	Item no.	EMLP 24 (30X12)R	0819550	
	Technology				
	Text field height		12.00 mm		
	Text field width		30.00 mm		
	Mounting type		Adhesive		
	Material		Polyester		
	Ambient temperature		-40°C ... 120°C		
	Type	Item no.	EMLP 30 (45X10)R	0801855	
	Technology				
	Text field height		10.00 mm		
	Text field width		45.00 mm		
	Mounting type		Adhesive		
	Material		Polyester		
	Ambient temperature		-40°C ... 120°C		
	Type	Item no.	EML-RS (45,7X45,7)R SR	0803187	
	Technology				
	Area of application		Rotary switch Ø 25 mm	EML-RS (45,7X45,7)R	0803387
	Text field height		45.70 mm		
	Text field width		45.70 mm		
	Mounting type		Adhesive		
	Ambient temperature		-40°C ... 150°C		
	Type	Item no.	US-EML-RS (45,7X45,7) SR	0803826	
	Technology				
	Area of application		Rotary switch Ø 25 mm		
	Text field height		45.70 mm		
	Text field width		45.70 mm		
	Mounting type		Adhesive		
	Ambient temperature		-40°C ... 150°C		
	Type	Item no.	LS-EMP 22 (50X50) WH	1558018	
	Technology				
	Area of application		Command and signaling devices, Ø 22 mm		
	Text field height		50.00 mm		
	Text field width		50.00 mm		
	Mounting type		Insert		
	Ambient temperature		-20°C ... 60°C		

Marking materials for equipment identification

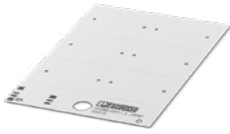

Self-adhesive device markers for command and signaling devices				Additional versions	
	Type	Item no.	LS-EMLP 24 (30X12) SR	0831727	LS-EMLP 24 (30X12) WH 0831700 LS-EMLP 24 (30X12) YE 0831754
	Technology				
	Area of application		Command and signaling devices, Ø 24 mm		
	Text field height		12.00 mm		
	Text field width		30.00 mm		
	Mounting type		Adhesive		
	Material		ABS		
	Ambient temperature		-20°C ... 60°C		
	Type	Item no.	LS-EMLP 30 (45X10) SR	0831728	LS-EMLP 30 (45X10) WH 0831701 LS-EMLP 30 (45X10) YE 0831755
	Technology				
	Area of application		SIEMENS: SIRIUS ACT command and signaling devices, Ø 30 mm		
	Text field height		10.00 mm		
	Text field width		45.00 mm		
	Mounting type		Adhesive		
	Material		ABS		
	Ambient temperature		-20°C ... 60°C		
	Type	Item no.	LS-EMLP 32 (38X14) SR	0831729	LS-EMLP 32 (38X14) WH 0831702 LS-EMLP 32 (38X14) YE 0831756
	Technology				
	Area of application		Command and signaling devices, Ø 32 mm		
	Text field height		14.00 mm		
	Text field width		38.00 mm		
	Mounting type		Adhesive		
	Material		ABS		
	Ambient temperature		-20°C ... 60°C		

Marking materials for equipment identification











Individual labels made of aluminum				Additional versions	
	Type	Item no.	EMP-AL (27X18)	0830777	
	Technology				
	Text field height		18.00 mm		EMP-AL (27X15) 0830776
	Text field width		27.00 mm		EMP-AL (49X15) 0830778
	Mounting type		Latching		EMP-AL (60X30) 0830796
	Material		Aluminum		EMP-AL (85,6X54) 0830797
	Ambient temperature		-25°C ... 120°C		
	Type	Item no.	EMSP-AL (90X60)	0830504	
	Technology				
	Text field height		60.00 mm		EMSP-AL (39X15) 0830510
	Text field width		90.00 mm		EMSP-AL (50X15) 0830773
	Mounting type		Screw, rivet		EMSP-AL (50X30) 0830502
	Material		Aluminum		EMSP-AL (75,6X54) 0830503
	Ambient temperature		-25°C ... 120°C		
	Type	Item no.	EMLP-AL (100X60)	0830515	
	Technology				
	Text field height		60.00 mm		EMLP-AL (27X15) 0830508
	Text field width		100.00 mm		EMLP-AL (27X18) 0830509
	Mounting type		Adhesive		EMLP-AL (60X30) 0830513
	Material		Aluminum		EMLP-AL (85,6X54) 0830514
	Ambient temperature		-25°C ... 120°C		

Individually configurable markers for various geometries and sizes					
	Type	Item no.	US-EM(L)(S)P (...X...)/RPET	1533775	
	Technology		 		
	Text field height		Configurable		
	Text field width		Configurable		
	Mounting type		Configurable		
	Material		Polyethylene terephthalate		
	Ambient temperature		-40°C ... 40°C		
	Type	Item no.	LS-EM(L)(S)P (...X...)/RPET	1533778	
	Technology				
	Text field height		Configurable		
	Text field width		Configurable		
	Mounting type		Configurable		
	Material		Polyethylene terephthalate		
	Ambient temperature		-40°C ... 40°C		

Marking materials for equipment identification

Device markers in cartridge format for the GO SERIES				Additional versions
	Type	Item no.	MM-EML (20X8)R C1 YE/BK	1116205
	Technology			
	Text field height		8.00 mm	
	Text field width		20.00 mm	
	Mounting type		Adhesive	
	Material		Polyester	
	Ambient temperature		-40°C ... 150°C	
				MM-EML (16,5X5)R C1 WH/BK 1116200 MM-EML (EX10)R C1 WH/BK 0803970 MM-EML (EX12)R C1 SR/BK 0803975 MM-EML (EX24)R C1 TR/BK 1116133 MM-EML (EX6)R C1 WH/BK 1666419 MM-EML (EX8)R C1 WH/BK 1582241
	Type	Item no.	MM-EMLF (EX10)R C1 YE/BK	0803941
	Technology			
	Product features		Highly flexible	
	Text field height		8.00 mm	
	Text field width		8000.00 mm	
	Mounting type		Adhesive	
	Material		Vinyl polymer	
	Ambient temperature		-20°C ... 75°C	
			MM-EMLF (EX12)R C1 WH/BK 0803938 MM-EMLF (EX14)R C1 YE/BK 1116136 MM-EMLF (EX18)R C1 OG/BK 0803957 MM-EMLF (EX24)R C1 BU/WH 0803949	
	Type	Item no.	MM-EMLC (EX10)R C1 WH/BK	0803933
	Technology			
	Text field height		8.00 mm	
	Text field width		6000.00 mm	
	Mounting type		Adhesive	
	Material		PA	
	Ambient temperature		0°C ... 80°C	
				MM-EMLC (EX12)R C1 WH/BK 0803934 MM-EMLC (EX14)R C1 WH/BK 1116134 MM-EMLC (EX18)R C1 WH/BK 0803936
	Type	Item no.	MM-EMT (EX4)R C1 WH/BK	1169312
	Technology			
	Text field height		3.00 mm	
	Text field width		8000.00 mm	
	Mounting type		Latching	
	Material		Polyester	
	Ambient temperature		-40°C ... 120°C	
				MM-EMT (EX6)R C1 WH/BK 0803963 MM-EMT (EX8)R C1 WH/BK 0803965 MM-EMT (EX15)R C1 WH/BK 0803966 MM-EMT (EX23)R C1 WH/BK 0803969
Markers for end brackets				Additional versions
	Type	Item no.	UCT-EM (30X5)	0801505
	Technology			
	Area of application		CLIPFIX 35-5... end bracket	
	Text field height		5.00 mm	
	Text field width		30.00 mm	
	Mounting type		Latching	
	Material		PC	
	Ambient temperature		-40°C ... 120°C	
			UCT-EM (30X5) YE 0830340	

Marking materials for equipment identification

Device markers for the PLOTMARK and the ENGRAVING UNIT				Additional versions	
	Type	Item no.	GPE 27X18 SR/R	0806893	
	Technology				
	Text field height		18.00 mm		GPE 20X 8 WH 0806945
	Text field width		27.00 mm		GPE 60X30 WH 0806961
	Mounting type		Adhesive		GPE 27X18 WH/R 0815208
	Material		TRANSPLY-ABS		GPE 45X14 SR/R 0807009
	Ambient temperature		-20°C ... 85°C		
	Type	Item no.	GPA 610X610X0,8...	0811406	
	Technology				
	Text field height		610.00 mm		GPA 300X280X0,8 ... 0811370
	Text field width		610.00 mm		GPA 610X610X1,5... 0811435
	Mounting type		Screw, rivet		
	Material		ABS		
	Ambient temperature		-20°C ... 85°C		
	Type	Item no.	GPA/SK 300X280X1,5...	0814005	
	Technology				
	Text field height		280.00 mm		GPA/SK 300X280X0,8 ... 0811383
	Text field width		300.00 mm		
	Mounting type		Adhesive		
	Material		ABS		
	Ambient temperature		-20°C ... 85°C		
	Type	Item no.	GPK 300X280X0,8 ...	0806068	
	Technology				
	Text field height		280.00 mm		GPK 300X280X1,5 ... 0806123
	Text field width		300.00 mm		GPK 300X280X1,5 WH/BK 5031919
	Mounting type		Screw, rivet		GPK 610X610X1,5 ... 0806424
	Material		TRANSPLY-ABS		
	Ambient temperature		-20°C ... 85°C		
	Type	Item no.	GPK/SK 610X610X1,5 WH/BK	0806518	
	Technology				
	Text field height		610.00 mm		GPK/SK 610X610X0,8 WH/BK 0806437
	Text field width		610.00 mm		GPK/SK 300X280X0,8 WH/BK 0803854
	Mounting type		Adhesive		GPK/SK 300X280X0,8 SR/BK 0803841
	Material		TRANSPLY-ABS		GPK/SK 300X280X0,8 YE/BK 0806178
	Ambient temperature		-20°C ... 85°C		

Marking materials for equipment identification

Marker carriers for equipment identification				Additional versions
	Type	Item no.	CARRIER-EMP (60X30)	0827454
	Text field height		30.00 mm	
	Text field width		60.00 mm	
	Mounting type		Screw, rivet	
	Material		PA	
	Ambient temperature		-40°C ... 105°C	
	Type	Item no.	CARRIER-EMP 22 (27X18)	0827448
	Text field height		18.00 mm	
	Text field width		27.00 mm	
	Mounting type		Screw, rivet	
	Material		PA	
	Ambient temperature		-40°C ... 105°C	
	Type	Item no.	CARRIER-EMLP 22 (27X18)	0828987
	Text field height		18.00 mm	
	Text field width		27.00 mm	
	Mounting type		Screw, rivet	
	Material		PA	
	Ambient temperature		-40°C ... 105°C	
	Type	Item no.	PAB-SK 15	1013287
	Text field height		4.00 mm	
	Text field width		15.00 mm	
	Mounting type		Adhesive	
	Material		PVC	
	Ambient temperature		-40°C ... 80°C	
	Type	Item no.	PAB-SK 30	1013290
	Text field height		4.00 mm	
	Text field width		15.00 mm	
	Mounting type		Adhesive	
	Material		PVC	
	Ambient temperature		-40°C ... 80°C	
	Type	Item no.	P-SS-ZB 100	1013737
	Text field height		10.50 mm	
	Text field width		1000.00 mm	
	Mounting type		Adhesive	
	Material		PVC	
	Ambient temperature		-15°C ... 80°C	
	Type	Item no.	P-ZB METER	1051854
	Text field height		10.50 mm	
	Text field width		1000.00 mm	
	Mounting type		Latching	
	Material		PA	
	Ambient temperature		-40°C ... 100°C	

Marking materials for equipment identification



1

2

3

4

Marking material

Marker carriers for equipment identification				Additional versions
	Type	Item no.	CARRIER-EMP (1000X15) GY	0829366
	Text field height		15.00 mm	
	Text field width		1000.00 mm	
	Mounting type		Screw, rivet	
	Material		PVC	
	Ambient temperature		-40°C ... 60°C	
CARRIER-EMP (1000X15) TR 0829530				
	Type	Item no.	CARRIER/L-EMP (1000X15) GY	0829559
	Text field height		15.00 mm	
	Text field width		1000.00 mm	
	Mounting type		Adhesive	
	Material		PVC	
	Ambient temperature		-40°C ... 60°C	
CARRIER/L-EMP (1000X15) TR 0829560				
CARRIER/L-EMP (1000X15) WH 1285733				
	Type	Item no.	CARRIER-EMP (1000X15) COVER	0829520
	Text field height		15.00 mm	
	Text field width		1000.00 mm	
	Mounting type		Latching	
	Material		PVC	
	Ambient temperature		-40°C ... 60°C	







Marking material

Plant identification









The comprehensive and clear identification of plants not only ensures safety, but is also a legal requirement. Along with warning information, prohibition signs, and mandatory signs, markings identify emergency stop buttons and fire alarm systems, for example. Identification with hazardous substance labels ensures the necessary protection when handling hazardous substances, in accordance with the international standard. Furthermore, pipeline markers are used to indicate which fluids or gases are flowing in the pipes, as well as the direction of flow.









Designation key: Plant identification





Designation key						Technology
Plant identification: Marking solutions in roll format						
PML-M	Plant Marking	Label	Mandatory	Labels for mandatory identification in accordance with ISO 7010	 Thermal transfer printing	
PML-P			Prohibition	Labels for prohibition identification in accordance with ISO 7010		
PML-W			Warning	Labels for warning identification in accordance with ISO 7010		
PML-C			Circuit	Circuit identification on emergency lighting systems in acc. with DIN EN 50172, VDE 0108-100 and fire alarm identification in acc. with DIN 14675		
PML-T			Tubing	Arrow labels for pipeline identification in accordance with DIN 2403 in different colors according to the flow substance		
PML-GHS			Globally Harmonized System	Labels for hazardous substance identification in accordance with CLP/GHS regulation		
PMM		Magnet		Magnetic labels in cont. format for the temp. identification of storage locations in logistics		
EMLF			Flexible	Self-adhesive, highly flexible labels for instruction identification in accordance with ISO 3864 and ANSI Z535 for the individual design of hazard notices		
Plant identification: Marking solutions in sheet format						
UC-PMP	Universal Card	Plant Marking	Plate	Insert labels for CARRIER(/L)-PMP... marker carriers	 UV inkjet printing	
UC-PMLP			Label Plate	Self-adhesive plastic labels		
UCT-PMP	Universal Card thermal transfer		Plate	Insert labels for CARRIER(/L)-PMP... marker carriers	 Laser and UV inkjet printing	
UCT-PMLP			Label Plate	Self-adhesive plastic labels		
US-EMLF			Label Flexible	Self-adhesive, highly flexible labels for instruction identification in accordance with ISO 3864 and ANSI Z535 for the individual design of hazard notices	 UV inkjet and thermal transfer printing	
Plant identification: Marking solutions in card format						
US-PML-M	Universal Sheet	Plant Marking	Label	Mandatory	Labels for mandatory identification in accordance with ISO 7010	 UV inkjet printing Thermal transfer printing
US-PML-P...				Prohibition	Labels for prohibition identification in accordance with ISO 7010	
US-PML-W...				Warning	Labels for warning identification in accordance with ISO 7010	
US-PML-F				Fire protection	Labels for the identification of smoke alarms for fire alarm systems in accordance with DIN 4066	
US-PML-ESS				Emergency stop sign	Labels for the identification of emergency stop buttons in accordance with ISO 13850	
US-PML-GHS				Globally Harmonized System	Labels for hazardous substance identification in accordance with CLP/GHS regulation	
US-EML (D39)		Equipment Marking	Label	Labels for creating inspection labels in accordance with BGV A8 using templates in the Marking system software	 UV inkjet printing	
Plant identification: Marking solutions in cartridge format						
MM-EML 24	Mobile Marking	Equipment Marking	Label	Self-adhesive, flexible labels for creating inspection labels using templates in the Marking system app	 Thermal transfer printing	

Marking materials for plant identification

Marker carriers for plant identification								
								
Product group		CARRIER-PMP	CARRIER-PMP-ENCLOSED	CARRIER/L-PMP-ENCLOSED				
Product type		Marker carrier	Marker carrier	Marker carrier				
Mounting type		Screws, rivets, assembly with cable ties	Screws, rivets	Adhesive				
Mounting type of the marking material		Insert	Insert	Insert				
Area of application		Equipment and control cabinets	Equipment and control cabinets	Equipment and control cabinets				
Marking material product group	Compatible printing technology							
	    							
PMT...						•	•	•
PMST...						•	•	•
UC-PMP...			•	•		•		•
UCT-PMP		•	•	•			•	

Marking materials for plant identification





Labels for mandatory identification				Additional versions	
	Type	Item no.	US-PML-M100 (D50)	1014176	
	Technology				
	Area of application		Mandatory identification in accordance with ISO 7010		
	Text field height		50.00 mm		
	Text field width		50.00 mm		
	Mounting type		Adhesive		
	Material		PVC		
	Ambient temperature		-40°C ... 90°C		
	Type	Item no.	US-PML-M100 (D100)	1014177	US-PML-M100 (D50) 1014176
	Technology				
	Area of application		Mandatory identification in accordance with ISO 7010		
	Text field height		100.00 mm		
	Text field width		100.00 mm		
	Mounting type		Adhesive		
	Material		PVC		
	Ambient temperature		-40°C ... 90°C		
	Type	Item no.	PML-M100 (D50)R	1014180	PML-M100 (D100)R 1014181
	Technology				
	Area of application		Mandatory identification in accordance with ISO 7010		
	Text field height		50.00 mm		
	Text field width		50.00 mm		
	Mounting type		Adhesive		
	Material		PVC		
	Ambient temperature		-40°C ... 90°C		







Labels for prohibition identification				Additional versions	
	Type	Item no.	US-PML-P100 (D50)	1014217	US-PML-P100 (D100) 1014218 US-PML-P200 (D50) 1014221 US-PML-P200 (D100) 1014222
	Technology				
	Area of application		Prohibition identification in accordance with ISO 7010		
	Text field height		50.00 mm		
	Text field width		50.00 mm		
	Mounting type		Adhesive		
	Material		PVC		
	Ambient temperature		-40°C ... 90°C		
	Type	Item no.	PML-P100 (D50)R	1014225	PML-P100 (D100)R 1014226
	Technology				
	Area of application		Prohibition identification in accordance with ISO 7010		
	Text field height		50.00 mm		
	Text field width		50.00 mm		
	Mounting type		Adhesive		
	Material		PVC		
	Ambient temperature		-40°C ... 90°C		

Marking materials for plant identification



Labels for warning identification				Additional versions
	Type	Item no.	US-PML-W100 (25X25)	1014125
	Technology			
	Area of application	Warning identification in accordance with ISO 7010		
	Text field height	25.00 mm		
	Text field width	25.00 mm		
	Mounting type	Adhesive		
	Material	PVC		
	Ambient temperature	-40°C ... 90°C		
				US-PML-W100 (50X50) 1014126 US-PML-W100 (100X100) 1014127
	Type	Item no.	US-PML-W200 (100X100)	1014133
	Technology			
	Area of application	Warning identification in accordance with ISO 7010		
	Text field height	100.00 mm		
	Text field width	100.00 mm		
	Mounting type	Adhesive		
	Material	PVC		
	Ambient temperature	-40°C ... 90°C		
				US-PML-W200 (50X50) 1014132
	Type	Item no.	PML-W100 (50X50)R	0830430
	Technology			
	Area of application	Warning identification in accordance with ISO 7010		
	Text field height	50.00 mm		
	Text field width	50.00 mm		
	Mounting type	Adhesive		
	Material	PVC		
	Ambient temperature	-40°C ... 100°C		
				PML-W100 (25X25)R 0830429 PML-W100 (100X100)R 0830431
	Type	Item no.	PML-W200 (50X50)R	0830452
	Technology			
	Area of application	Warning identification in accordance with ISO 7010		
	Text field height	50.00 mm		
	Text field width	50.00 mm		
	Mounting type	Adhesive		
	Material	PVC		
	Ambient temperature	-40°C ... 100°C		
				PML-W200 (100X100)R 0830453
	Type	Item no.	PML-W300 (105X52)R	0830460
	Technology			
	Area of application	Warning identification in accordance with ISO 7010		
	Text field height	52.00 mm		
	Text field width	105.00 mm		
	Mounting type	Adhesive		
	Material	PVC		
	Ambient temperature	-40°C ... 100°C		



Marking materials for plant identification





Labels for warning identification				Additional versions
	Type	Item no.	PML-W400 (58/19XE)R WH-OG 1016499	
	Technology			
	Area of application		Instruction identification in accordance with ISO 3864 and ANSI Z535	
	Text field height		77.00 mm	
	Text field width		48000.00 mm	
	Mounting type		Adhesive	
	Material		PVC	
	Ambient temperature		-40°C ... 90°C	
	Type	Item no.	PML-W501 (100X48)R WH-RD 1016507	
	Technology			
	Area of application		Instruction identification in accordance with ISO 3864 and ANSI Z535	
	Text field height		48.00 mm	
	Text field width		100.00 mm	
	Mounting type		Adhesive	
	Material		PVC	
	Ambient temperature		-40°C ... 90°C	

Labels for the identification of smoke alarms for fire alarm systems				Additional versions
	Type	Item no.	US-PML-F100 (50X25) 0803866	US-PML-F100 (D50) 0803869 US-PML-F200 (50X25) 0803868 US-PML-F200 (D50) 0803871
	Technology		 	
	Area of application		Identification of smoke alarms in accordance with DIN 4066	
	Text field height		15.00 mm	
	Text field width		40.00 mm	
	Mounting type		Adhesive	
	Material		PVC	
	Ambient temperature		-40°C ... 100°C	
	Type	Item no.	US-PML-F100 (D50) 0803869	
	Technology		 	
	Area of application		Identification of smoke alarms in accordance with DIN 4066	
	Text field height		50.00 mm	
	Text field width		50.00 mm	
	Mounting type		Adhesive	
	Material		PVC	
	Ambient temperature		-40°C ... 100°C	

Marking materials for plant identification



Arrow labels for pipeline identification				Additional versions
	Type	Item no.	PML-T101 (26X280)R	1014229
	Technology			
	Area of application		Pipeline identification in accordance with DIN 2403	
	Text field height		26.00 mm	
	Text field width		280.00 mm	
	Mounting type		Adhesive	
	Material		Polyester	
	Ambient temperature		-40°C ... 150°C	
			PML-T102 (26X280)R 1014231 PML-T103 (26X280)R 1014233 PML-T104 (26X280)R 1014235 PML-T105 (26X280)R 1014237 PML-T106 (26X280)R 1014239 PML-T107 (26X280)R 1014241 PML-T108 (26X280)R 1014243 PML-T109 (26X280)R 1014245 PML-T110 (26X280)R 1014247	



Circuit identification on emergency lighting systems and fire alarm identification				Additional versions
	Type	Item no.	PML-C101 (D39)R	1032780
	Technology			
	Area of application		Circuit identification on emergency lighting systems in accordance with DIN VDE 0108-100	
	Text field height		39.00 mm	
	Text field width		39.00 mm	
	Mounting type		Adhesive	
	Material		PVC	
	Ambient temperature		-40°C ... 90°C	



Labels for hazardous substance identification				Additional versions
	Type	Item no.	US-PML-GHS100 (25X25)	1014288
	Technology		 	
	Area of application		Hazardous substance identification in accordance with CLP/GHS regulation	
	Text field height		25.00 mm	
	Text field width		25.00 mm	
	Mounting type		Adhesive	
	Material		Polyester	
	Ambient temperature		-40°C ... 150°C	
			US-PML-GHS100 (13X13) 1014287	
	Type	Item no.	PML-GHS100 (13X13)R	1014289
	Technology			
	Area of application		Hazardous substance identification in accordance with CLP/GHS regulation	
	Text field height		13.00 mm	
	Text field width		13.00 mm	
	Mounting type		Adhesive	
	Material		Polyester	
	Ambient temperature		-40°C ... 150°C	
			PML-GHS100 (25X25)R 1014290	

Marking materials for plant identification

1
2
3
4



Labels for the identification of emergency stop buttons				Additional versions	
	Type	Item no.	US-PML-ESS100 (D60) YE	0803873	US-PML-ESS100 (D90) YE 0803872
	Technology		 		
	Area of application		Identification of emergency stop buttons in accordance with ISO 13850		
	Text field height		60.00 mm		
	Text field width		60.00 mm		
	Mounting type		Adhesive		
	Material		PVC		
	Ambient temperature		-40°C ... 60°C		





Labels for creating inspection labels				Additional versions	
	Type	Item no.	US-EML (D39)	0803822	
	Technology		 		
	Area of application		Inspection labels in accordance with BGV A8		
	Text field height		39.00 mm		
	Text field width		39.00 mm		
	Mounting type		Adhesive		
	Material		Polyester		
	Ambient temperature		-40°C ... 150°C		

Magnetic labels for temporary identification in logistics				Additional versions	
	Type	Item no.	PMM (EX20)R	1014303	PMM (EX25)R 1014306 PMM (EX30)R 1014309 PMM (EX40)R 1014312 PMM (EX50)R 1014315
	Technology				
	Product features		Magnetic		
	Area of application		Warehousing/ logistics		
	Text field height		20.00 mm		
	Text field width		15000.00 mm		
	Mounting type		Magnetic adhesion		
	Material		Magnetic tape		
	Ambient temperature		-30°C ... 55°C		





Marking material

Marking materials for plant identification





Marking labels for flow substances in marker carriers				Additional versions	
	Type	Item no.	PMST (10X38) GN	0831081	PMST (10X38) 0831076
	Area of application	Identification of flow substances in accordance with DIN 2403			PMST (10X38) BK 0831085
	Mounting type	Latching			PMST (10X38) BN 0831083
	Material	PVC			PMST (10X38) BU 0831084
	Ambient temperature	-30°C ... 80°C			PMST (10X38) GY 0831082
	Type	Item no.	PMT (10X38) GN	0831091	PMT (10X38) 0831086
	Area of application	Identification of flow substances in accordance with DIN 2403			PMT (10X38) BK 0831095
	Mounting type	Latching			PMT (10X38) BN 0831093
	Material	PVC			PMT (10X38) BU 0831094
	Ambient temperature	-30°C ... 80°C			PMT (10X38) GY 0831092
					PMT (10X38) OG 0831088
					PMT (10X38) RD 0831089
					PMT (10X38) VT 0831090
					PMT (10X38) YE 0831087

Self-adhesive plastic labels				Additional versions			
	Type	Item no.	UCT-PMLP (90X38)	0803041			
	Technology						
	Text field height	38.00 mm					
	Text field width	90.00 mm					
	Mounting type	Adhesive					
	Material	PC					
					Ambient temperature	-40°C ... 120°C	
	Type	Item no.	UC-PMLP (110X38)	0831020			
	Technology						
	Text field height	38.00 mm			UC-PMLP (90X38) 0831017		
	Text field width	110.00 mm					
	Mounting type	Adhesive					
	Material	PA					
						Ambient temperature	-40°C ... 120°C



Marking materials for plant identification



Insert labels for CARRIER(/L)-PMP... marker carriers				Additional versions	
	Type	Item no.	UCT-PMP (90X38)	0803039	
	Technology				
	Text field height		38.00 mm		
	Text field width		90.00 mm		
	Mounting type		Latching into marker carrier		
	Material		PC		
	Ambient temperature		-40°C ... 100°C		
	Type	Item no.	UC-PMP (110X38)	0831019	
	Technology				
	Text field height		38.00 mm		UC-PMP (90X38) 0831016
	Text field width		110.00 mm		
	Mounting type		Latching into marker carrier		
	Material		PA		
	Ambient temperature		-40°C ... 120°C		

Marked plant markers (in sheet format)				Additional versions	
	Type	Item no.	PML-W101 (50X50)	0830434	
	Area of application		Warning identification in accordance with ISO 7010		
	Text field height		50.00 mm		PML-W301 (52X26) 0830461
	Text field width		50.00 mm		PML-W301 (74X37) 0830462
	Mounting type		Adhesive		PML-W301 (105X52) 0830463
	Material		PVC		
	Ambient temperature		-40°C ... 60°C		

Self-adhesive, highly flexible labels for instruction identification				Additional versions	
	Type	Item no.	EMLF (50XE)R YE	0804678	
	Technology				
	Product features		Highly flexible		EMLF (108XE)R 0800549
	Area of application		Instruction identification in accordance with ISO 3864 and ANSI Z35		EMLF (108XE)R YE 0800550
	Text field height		50.00 mm		EMLF (108XE)R BU 0804197
	Text field width		48000.00 mm		EMLF (108XE)R OG 0804199
	Mounting type		Adhesive		EMLF (108XE)R RD 0804198
	Material		PVC		
	Ambient temperature		-40°C ... 100°C		
	Type	Item no.	US-EMLF (104X140)	1014291	
	Technology				
	Area of application		Combi labels		US-EMLF (104X140) YE 1014292
	Text field height		140.00 mm		US-EMLF (104X140) BU 1014293
	Text field width		104.00 mm		
	Mounting type		Adhesive		
	Material		PVC		
	Ambient temperature		-40°C ... 100°C		

Marking materials for plant identification

Self-adhesive, flexible labels for creating inspection labels				Additional versions
	Type	Item no.	MM-EML (EX24)R C1 YE/BK	1116131
	Technology			
	Text field height		22.00 mm	
	Text field width		8000.00 mm	
	Mounting type		Adhesive	
	Material		Polyester	
	Ambient temperature		-40°C ... 150°C	
			MM-EML (EX24)R C1 WH/BK	0803973
			MM-EML (EX24)R C1 SR/BK	0803978

Marker carriers				Additional versions
	Type	Item no.	CARRIER-PMP (110X38)	0831056
	Text field height		38.00 mm	
	Text field width		110.00 mm	
	Mounting type		Screw, rivet	
	Material		PA	
	Ambient temperature		-40°C ... 105°C	
	Type	Item no.	CARRIER/L-PMP-ENCLOSED (110X38)	0831062
	Text field height		38.00 mm	
	Text field width		110.00 mm	
	Mounting type		Adhesive	
	Material		PA	
	Ambient temperature		-40°C ... 105°C	
	Type	Item no.	CARRIER-PMP-ENCLOSED (110X38)	0831068
	Text field height		38.00 mm	
	Text field width		110.00 mm	
	Mounting type		Screw, rivet	
	Material		PA	
	Ambient temperature		-40°C ... 105°C	
			CARRIER-PMP (108X38)	0830958

1 Identification solutions

2 Building infrastructure

3
4
Marking material

In modern building installation, a clear overview in the control cabinet is a key factor for efficient and error-free operation and maintenance. Using appropriate markings means that all components can be clearly identified. Along with a clear overview, safety and fire protection also play an essential role – especially in

public buildings. To ensure that fire alarm systems are marked in accordance with DIN 14675 and that sources of danger are clearly indicated in accordance with ISO 7010, ISO 3864, and ANSI Z535, professional and durable identification is required. To make installation work as simple and efficient as possible, mobile

printing systems are an ideal solution with their compact dimensions, integrated power supply, and intuitive operation.



To hand and safely stowed away: benefit from the proven L-BOXX system and our practical shoulder bag/belt pouch. They allow the printer and accessories to be transported safely and conveniently.



The Application Wizards in the Marking system app make marking even easier. For example, you can benefit from the “Textfield Matrix Wizard” when it comes to component identification in service panels.



The THERMOMARK PRIME 2.0 mobile thermal transfer card printer allows you to create markings right where they will be used. It therefore saves you a great deal of time and provides greater flexibility.

Marking materials for building infrastructure

1

2

3

4

Marking material

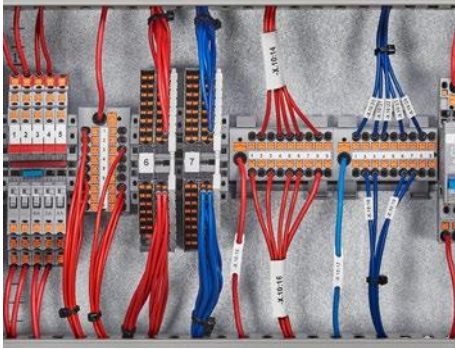

MM-TMT... and MM-TML...

All terminal blocks with tall and flat marking grooves can be marked with the MM-TMT... label. The MM-TML... self-adhesive marking strips mark terminal blocks and DIN rail-mounted devices without a marking groove. The continuous format provides the flexibility to cut the material to size.

➤ More information starting on page 99



MM-EML...

The MM-EML... self-adhesive labels are suitable for the identification of components in the control cabinet, such as miniature circuit breakers. With the cartridge system, which includes the material and ink ribbon, the identification process is very efficient. There are prepunched labels and versions in continuous format for various areas of application.

➤ More information starting on page 142



MM-WML...

The MM-WML... self-adhesive wrap-around labels enable durable wire and cable marking. The transparent area of the label serves as a protective foil and is wound over the marking, thus permanently protecting it against dirt and abrasion. The wrap-around labels fit snugly, allowing cables to be drawn through cable ducts, for example, without any problems.

➤ More information starting on page 117



PML-C101...

The PML-C101... labels with two marking fields are used for professional circuit identification on rescue and emergency lighting systems for fire alarm identification in accordance with DIN 14675. The highly flexible PVC label also molds itself well to uneven surfaces.

➤ More information starting on page 152



US-PML-F...

Comprehensive fire alarm identification also includes the proper identification of smoke alarms in accordance with DIN 4066. The US-PML-F... labels are available in a round and square version for this purpose.

➤ More information starting on page 151



US-EM(L)(S)P (...X...)/RPET

The configurable US-EM(L)(S)P (...X...)/RPET plastic labels are ideal for use in building infrastructure due to their fire and smoke behavior. We produce the markers according to your requirements with regard to the dimensions, shape, and mounting type. You can then mark them using your own marking systems.

➤ More information starting on page 141

1 Identification solutions

2 Food and beverage industry

A high level of hygiene and safety is required in the food and beverage industry. Therefore, all components and materials used in the production process are subject to special requirements – this also includes identification. High chemical resistance, good visual recognition as well

as detectability and optimum adhesion ensure high-quality, long-lasting, and safe marking in this environment.



Cleaning agents can corrode markers and cause the marking to fade or become illegible, or result in brittle fractures. Marking materials must therefore have a high resistance to chemicals.



Blue markings are used in the food industry so that they can be quickly spotted. In addition, the use of detectable markers is recommended so that even small fragments can be detected during final inspection.



Due to constant cleaning, marking materials are exposed to strong mechanical influences. Therefore, an adhesive is required that is optimally distributed over the surface texture and thus provides optimum adhesive strength.

Marking materials for the food and beverage industry



UC-WMTBA-D.../PP...

Due to the detectability of the UC-WMTBA-D.../PP... material, even small fragments of the marking can be detected during final inspection. Made of polypropylene, the material is resistant to moisture, chemicals, and tearing and is highly durable due to marking with the TOPMARK NEO.

➤ More information starting on page 112

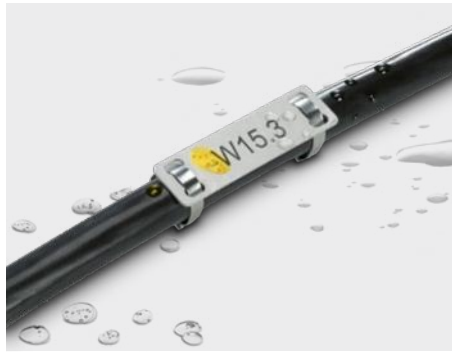

LS-WMTB-V4A...

The LS-WMTB-V4A... stainless steel markers are characterized by their high resistance to saltwater, chloride, and solvents. The markers are therefore suitable for particularly demanding industrial requirements. The markers can be marked by means of engraving or annealing marking depending on the application and requirements.

➤ More information starting on page 114



WMTB HF-D...

The WMTB HF-D... detectable wire and cable markers are used in combination with the WT-ID HF... detectable cable ties for the identification and bundling of wires and cables. They are made of high-quality thermoplastic polyether urethane. The material is highly flexible and features a very good tear strength.

➤ More information starting on page 113



EML-D...

EML-D... labels are suitable for equipment identification. A continuous aluminum foil strip makes the label detectable. The high adhesive strength allows the labels to be applied to rough, textured, and low-energy surfaces. The material used is approved by ISEGA for use in the food industry.

➤ More information starting on page 136



EML-LPR-D...

Textured surfaces often make optimum label adhesion more difficult. If the labels will also be exposed to mechanical stresses caused by cleaning processes, an extra protective laminate is required in addition to the appropriate adhesive system. The EML-LPR-D... detectable labels provide these features.

➤ More information starting on page 136



LS-EMSP-V4A...

The LS-EMSP-V4A... stainless steel device markers are suitable for easy-care and durable identification that also meets high hygiene requirements. The markings also feature high resistance to corrosion, acids, and temperatures.

➤ More information starting on page 133

Identification solutions

Railway infrastructure

There is almost no other industry that places such high demands on parts and components such as marking materials. Passenger safety during passenger transport is a very high priority, which is why even the smallest components must

comply with fire protection requirements. Due to the long product lifecycle of a train series and the legally required maintenance work, high demands are placed on the durability of the marking materials. For maintenance work to run

smoothly, the marking must still be clear after many years of use. Marking system provides halogen-free identification solutions optimized for fire protection for all applications in the railway industry.



Marking system offers solutions for numerous areas of application and requirements – from cable identification in passenger areas to outdoor infrastructure marking.



Fire protection is an important factor for safe and smooth railway operation. We offer halogen-free marking materials that meet the high requirements of DIN EN 45545-2.



When performing maintenance on trains, it may be necessary to replace or add markers. The professional, mobile printing systems of the THERMOMARK GO SERIES can be used to perform these tasks.

Marking materials for railway infrastructure

1

2

3

4

Marking material

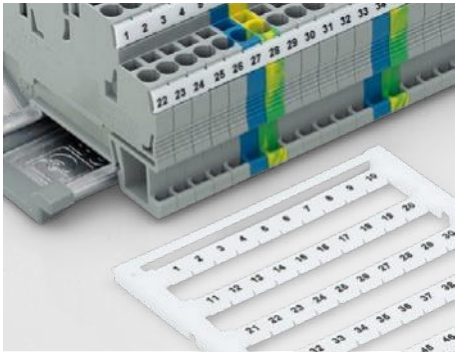

UC-TM(F)...

The UC-TM(F)... markers made of polyamide, which are marked using UV inkjet printing technology, are used for terminal identification. The markers are available for both tall and flat marking grooves and conform to hazard levels H1 to H2 and satisfy requirements R22 to R24 of DIN EN 45545-2.

➤ More information starting on page 96/97

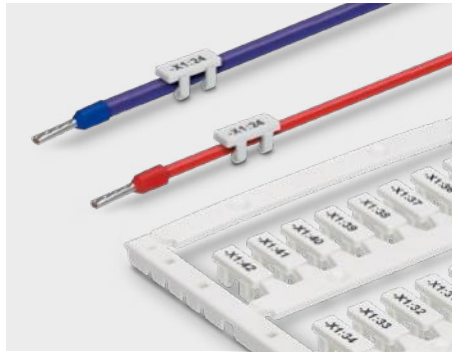

UCT-WMCO...

The UCT-WMCO... markers made of polycarbonate are used for the subsequent identification of wires, as they are simply clipped on. Their special design ensures a secure tight fit in the event of vibrations. In addition, these markers are extremely space-saving and satisfy the requirements of DIN EN 45545-2.

➤ More information starting on page 118



WMS-2 HF...

The WMS-2 HF marking sleeves are ideal for railway applications. They are halogen-free, conform to hazard levels HL1 to HL3, and satisfy requirements R22 to R24 of DIN EN 45545-2. They can also be shrunk onto wires and cables as an option.

➤ More information starting on page 116

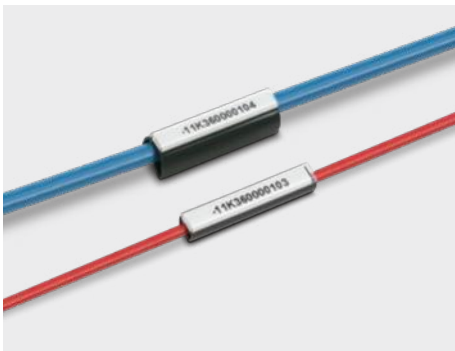

PATG HF...

The PATG HF... marking tags can be used to mark wires and cables and are simply slid on. Together with the corresponding UCT-WMT... and UC-WMT... insert labels, a system solution is created that meets high fire protection requirements, as all components conform to DIN EN 45545-2.

➤ More information starting on page 121



WMTB HF-HP...

The WMTB HF-HP... wire and cable marking is used for the identification and bundling of wires and cables in indoor and outdoor installations. The halogen-free material conforms to hazard levels HL1 to HL3 and satisfies requirements R22 to R24 of DIN EN 45545-2.

➤ More information starting on page 113



LS-EMSP-AL...

The LS-EMSP-AL... equipment marking is made of aluminum and has mounting holes for screws or rivets. The label is engraved with the TOPMARK NEO, thus creating an extremely durable marking. This type of equipment marking is also available as a stainless steel label and as a self-adhesive label.

➤ More information starting on page 132

1 Identification solutions

2 Outdoor installations

Outdoor installations are sometimes subject to adverse ambient conditions: Heat, cold, moisture, and sunlight are all influences that marking materials must withstand in order to meet the requirements for clear and long-lasting identification. Marking system provides

a wide range of marking solutions for wire and cable, equipment, and plant identification, suitable for permanent outdoor exposure.



To simulate several years of use outdoors, in our laboratory the marking materials are exposed to cyclical stresses through UV radiation and humidity, and are thus tested in accordance with DIN EN ISO 4892-2.



The IP degree of protection of markings is determined with the help of a water jet test and indicates the material's scope of protection against the ingress of foreign bodies as well as the tightness of seal against moisture.



In some areas of application, the markings must withstand a saline atmosphere. To ensure this can be achieved, the resistance of the materials is tested through salt spray in a corrosive atmosphere.

Marking materials for outdoor installations



(US-)WML...

The (US-)WML... self-adhesive wrap-around labels ensure high-quality and weather-resistant wire and cable marking. The transparent area of the label serves as a protective foil and is stuck over the marking, thus permanently protecting it against dirt, weathering, and mechanical abrasion.

➤ More information starting on page 115



KMK UV...

The KMK UV... marker carriers, in combination with the WT-UV HF... cable ties, are used for the identification and bundling of wires and cables in outdoor installations. The transparent marker carrier has a high impact strength and is resistant to UV, chemicals, and weathering. The sealing cap protects the marked insert label against external influences and dirt.

➤ More information starting on page 122



WMTB HF...

The WMTB HF... cable markers can be used for the identification and bundling of wires and cables in outdoor installations. Assembly with cable ties makes it easy to attach the marker retrospectively. The high-quality thermoplastic polyether urethane that is used is highly flexible and adapts to the bending of the components.

➤ More information starting on page 113



(US-)EMLF...

The (US-)EMLF... labels are made of soft, highly flexible PVC film that molds itself perfectly to uneven surfaces. In combination with the corresponding ink ribbon, the labels are UV-resistant and have a wide temperature range, making them suitable for all climates and areas of application.

➤ More information starting on page 130/131



LS-WMTB-V4A...

The LS-WMTB-V4A... stainless steel cable markers are engraved using the TOPMARK NEO and feature high resistance to corrosion, acids, and temperatures. For this reason, they are very resistant to weathering and suitable for permanent identification.

➤ More information starting on page 114



(US-)PML...

Sources of danger must also be marked outdoors in accordance with ISO 7010. The (US-)PML... safety labels are made of highly flexible PVC film. They are UV-resistant and suitable for all climates and areas of application due to their wide temperature range.

➤ More information starting on page 150

Certified quality for your applications

Environmental tests

Marking materials and their markings must be particularly resilient depending on their area of application. To ensure clear and durable identification, the properties of the base material must not be able to change too drastically. The quality of the printing must remain constant. Phoenix Contact strictly uses tested materials that fulfill the requirements set by various standards in every respect.

Weathering and radiation: DIN EN ISO 4892-2

To simulate several years of use outdoors, the marking materials are exposed to cyclical stresses through UV radiation and humidity. In this way, artificial weathering can be created, which provides an insight into the mechanical properties and the appearance of a material.



Chemical resistance: DIN EN ISO 175

Liquid oils and chemicals can trigger physical or chemical reactions that have a negative impact on the base material. Both the mechanical properties of a plastic and the durability of the marking can be affected. Tested materials withstand these influences.



Wipe resistance: DIN EN ISO 61010-1 and DIN EN 62208

To ensure the wipe resistance of markings in an industrial environment, the markings undergo a test with isopropanol, n-hexane, and petroleum ether. A cloth is soaked in the respective chemical and wiped over the marking material with a defined force for 30 s. After the test, the marking must still be clearly legible.



Condensation changing climate: DIN 50018

To test the resistance of the materials to corrosion damage, they are exposed to a condensation changing climate with a sulfur dioxide atmosphere at +40°C. An acidic atmosphere forms during the test. Finally, a microscopic visual inspection of the materials is performed.



Salt spray: IEC 60068-2-11/-52

Particularly in shipbuilding and in offshore applications, the markings must withstand corrosive atmospheres containing salt. To ensure this can be achieved, the resistance of the materials is tested through salt spray in a corrosive atmosphere. A visual inspection is performed after the test.

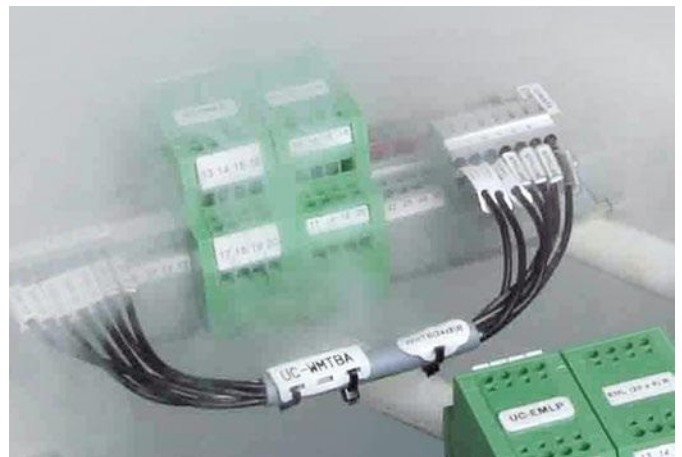

Certified quality for your applications

Testing of mechanical influences

In addition to environmental influences, marking materials and their markings are often subjected to mechanical influences. It must not be possible to scratch the marking off and abrasive industrial cleaning agents must not render the marking illegible. Furthermore, the marking materials must also remain securely fixed in place even when subjected to vibration. The materials used by Phoenix Contact also satisfy all standards and requirements in this area.

Scratch resistance: DIN EN ISO 1518

Using an Erichsen hardness test pencil, the scratch resistance of markings is tested by exposing them to intermittent or linear stress. A defined force is applied to an engraving needle via spring tension. The spring tension under which the Erichsen hardness test pencil leaves a barely visible trace is the deciding factor.

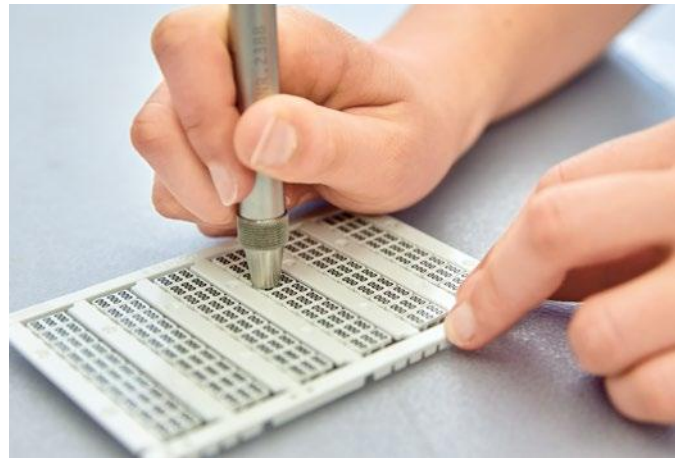

Grid test: DIN EN ISO 2409

The Tesa test is used to test the adhesion of printing. A transparent self-adhesive tape with an adhesive strength of 10 ± 1 N is applied to the printing to be tested and is then removed from the surface at an angle of 60° to the pull-off direction. There should be no marks from the printing on the adhesive tape after the test.



Adhesion: FINAT 1, 2, and 9

To determine the adhesive strength of a label on a base material, a strip of labels (25 mm x 175 mm) is applied with a specified force. The test sample is then removed after a defined wait time, at a predefined angle, at 300 mm/min. The adhesive strength is specified in N/25 mm.



Degrees of protection: DIN EN 60529 / ISO 20653

Differing ambient conditions and requirements necessitate a clear classification of markings in IP degrees of protection. These are indicated by a code consisting of two numbers following the IP abbreviation. The first number describes the scope of protection against the ingress of foreign bodies, and the second the tightness of seal against moisture.

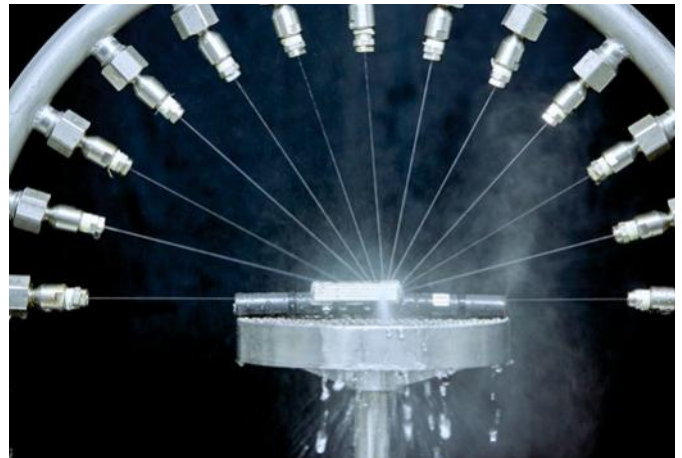

Vibrations: DIN EN 50155

To simulate vibration stress that occurs in practice (e.g., in the railway industry), the marking materials are exposed to increasing and decreasing frequencies and amplitudes. They are tested in the three axes (x, y, z) for five hours each, and must not be damaged and their secure positioning must not have been impacted.



Marking software

3

Comprehensive data for the creation of all marking files is the basis for an efficient and straightforward identification process. Marking system provides digital solutions for every application. Design your markings on a desktop computer with the Marking system software. Use the Marking system app for mobile use in the application environment.

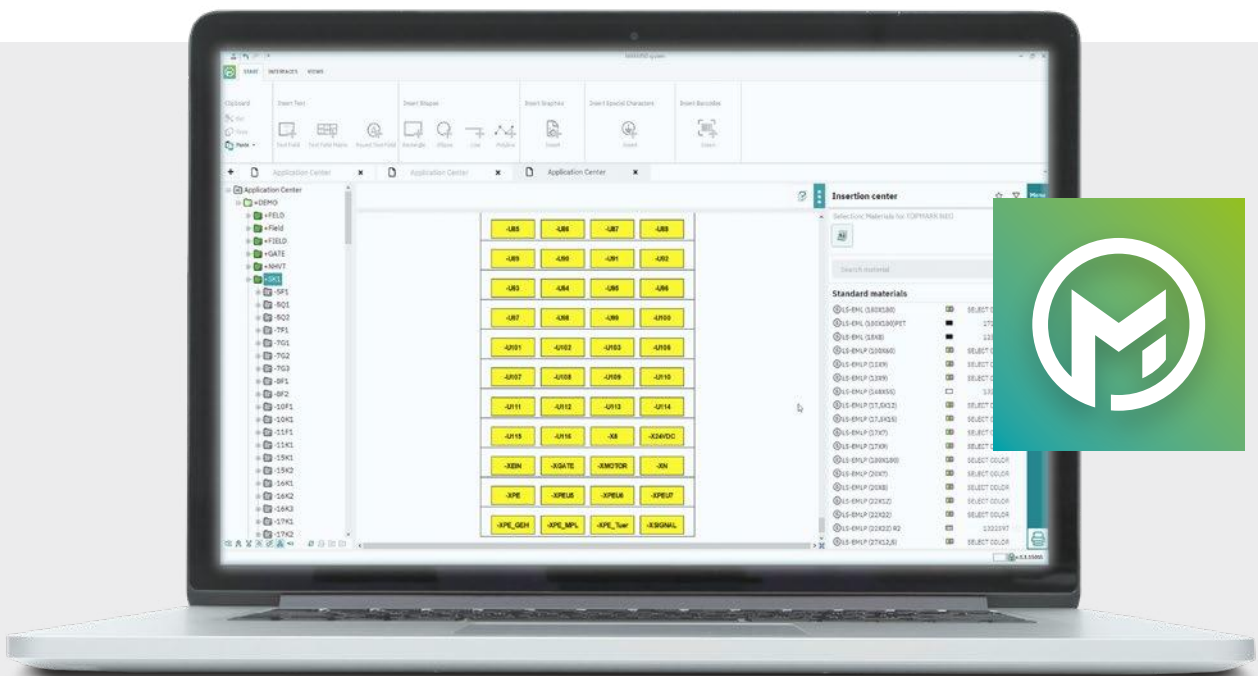

Marking system software

With the Marking system software, you can create marking files easily and conveniently on your laptop or desktop PC. The software imports marking data from ECAD systems, spreadsheet programs, and word processing programs, reducing the amount of work required. All Phoenix Contact marking systems as well as standard office printers can be controlled via the software.

➤ More information starting on page 172

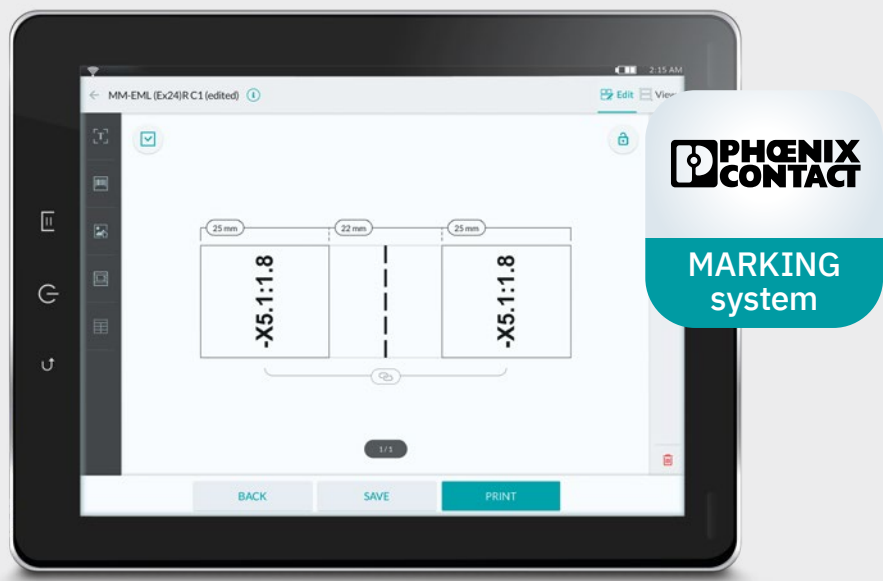

Marking system app

The Marking system app features a unique, mobile interface for the smart selection and creation of marking files. The app can also be used offline on mobile end devices and is available for iOS and Android operating systems.

➤ More information starting on page 176

Marking software

Marking system software

In addition to marking systems and materials, Marking system provides user-friendly marking software with application-specific functions. The Marking system software supports you in all phases of the identification process at your stationary PC workstation. Comprehensive functions and design options enable you to create customized marking solutions for terminal blocks, wires and cables, equipment, and plants.

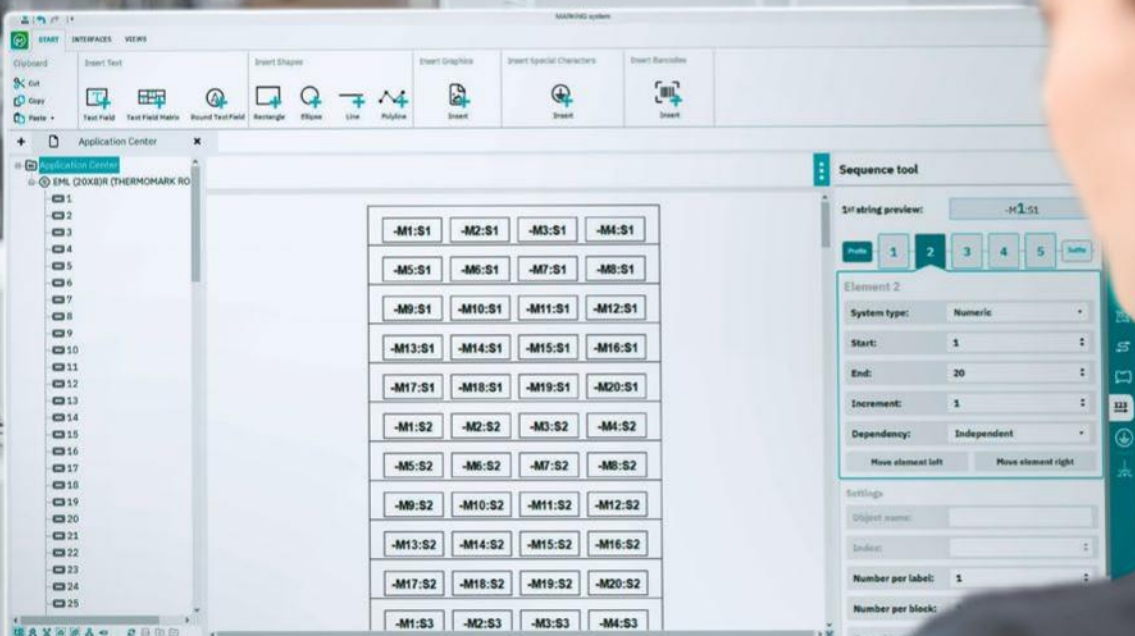

Software for stationary use

Create marking data easily

The Marking system software enables you to implement your custom-designed marking solutions easily and conveniently. All Phoenix Contact marking systems can be controlled and managed centrally from this software. In addition to many functions for the visual design of the marking materials, the software ensures efficient marking processes with its powerful data import functions and interfaces to common ECAD programs and spreadsheet formats. The interface to clipx ENGINEER ensures seamless processes from planning through to production. The Wire Marking Application Center even guides you through the entire printing and applying process all the way to the finished marked wire or cable.



Easy creation of marking files with the Marking system software

Your advantages

- ✓ Everything from a single source: The Marking system software supports all marking systems and marking materials from Phoenix Contact
- ✓ End-to-end process support from the product search, through creation, right through to ready-to-mount marking material
- ✓ High-performance interfaces for the efficient import of data from ECAD systems and common data exchange formats
- ✓ Efficient creation of structured marking projects in accordance with IEC 81346 with a clear project tree, intuitive user interface, and extensive design options

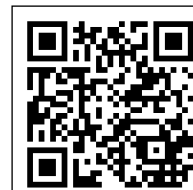

Go here to get the Marking system software

Marking system software

Decentralized marking processes on site

For efficient identification directly at the control cabinet, you can quickly and easily transfer marking projects to the printing and marking systems. Thanks to the Marking system software, all information is thus shown on the device display. The THERMOMARK E SERIES printers even visualize on the display a digital image of the components to be physically produced, including the marking. In this way, you are guided step by step through the entire identification process. Sources of error are reduced and efficient workflows are made possible even for unskilled workers.



Centralized marking processes

If all identification processes are carried out centrally in a marking cell, it is essential that all marking systems are controlled and managed from one marking software tool. With the help of the Marking system software, you assign your projects to the printing and marking systems and start the printing processes with just a click. In addition to the common control method via Ethernet, the THERMOMARK E SERIES also offers another advantage. By using the OPC UA bidirectional communication interface, you are informed in real time about the project and operating status of the individual devices. In the event of malfunctions, you can respond quickly and thus minimize downtimes.

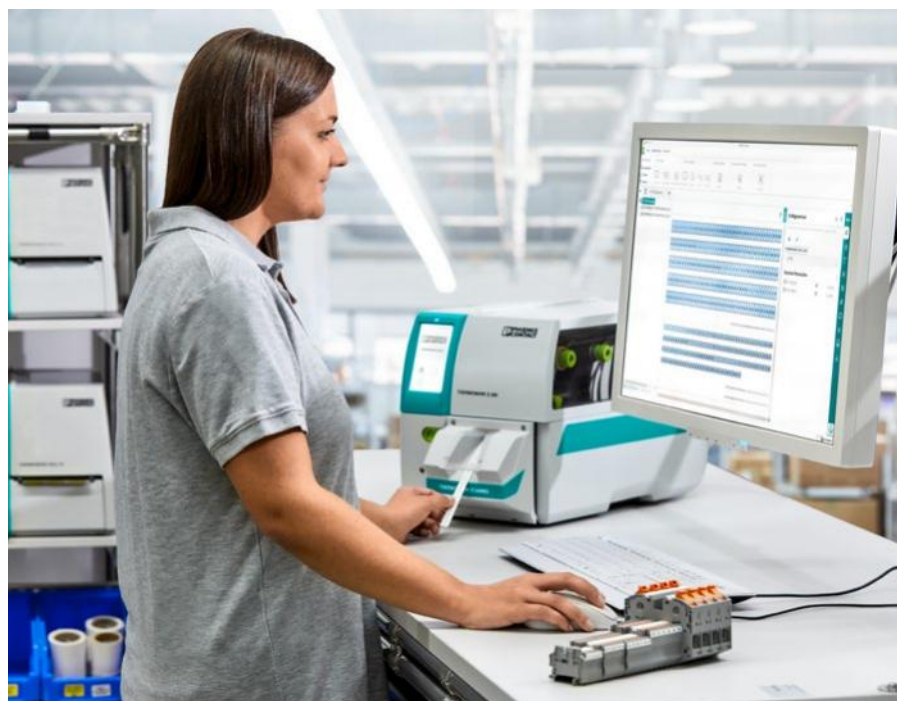



Perfect ECAD integration

The Marking system software features powerful interfaces to common ECAD programs for the efficient creation of marking solutions. This means that application-specific data from digital circuit diagrams can be imported instantly and processed automatically, thus saving time.



Comprehensive data import manager

Interfaces to various spreadsheet and word processing programs are provided for the open exchange of data. This enables comprehensive design options for creating custom markings for terminal blocks, cables and wires, equipment, and plants.

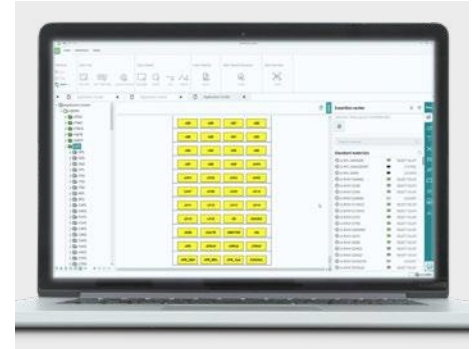

Structuring with the help of the project tree

You can easily structure your project in accordance with IEC 81346 using the project tree. Creating, sorting, and reprinting your marking materials for specific areas of your application could not be easier. Filtering by printed and unprinted materials efficiently supports you in your work.

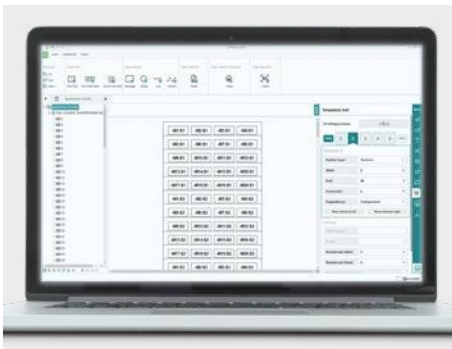

Intuitive operation via context-sensitive menu

The context-sensitive menu automatically suggests design options tailored to the respective step. The sequencing function supports you in the efficient and error-free creation of consecutive labels, for example. You can flexibly adapt the sequences to your requirements.



Easy and efficient wire identification

The Wire Marking Application Center provides a representation of the digital twin of your wire and cable markings. Comprehensive sorting and filtering functions provide you with ideal support for wire marking within your wire preparation process.



Template designer

Design custom labels and adapt existing material descriptions with the powerful Template Designer. Graphics, barcode types, special characters, safety symbols, and geometric shapes are available for your design.

Marking software

Marking system app

In addition to stationary identification using the Marking system software at a central PC workstation, we also offer mobile solutions for identification directly in the application environment using the Marking system app. The Marking system app features a unique, mobile interface for the smart selection and creation of marking files right where they are needed.

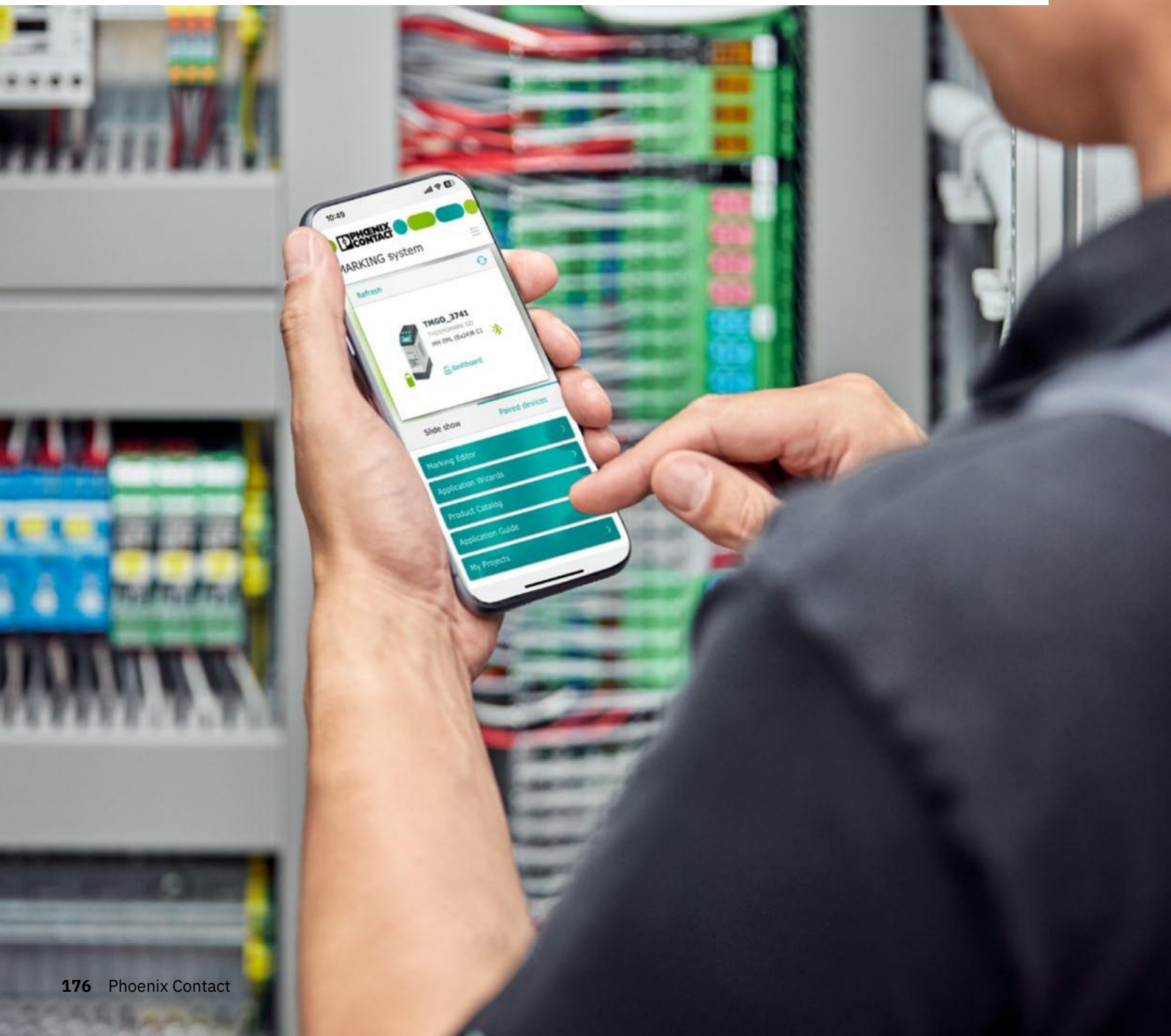

Software for mobile use

Mobile marking wherever you want

Which marking best suits your requirements? With the help of the Marking system app, users can quickly and easily find appropriate marking solutions for any requirement. The labels can then be marked on a compatible Phoenix Contact marking system, such as the THERMOMARK GO SERIES devices.

Featuring particularly user-friendly and context-sensitive menu navigation, the free app enables an efficient marking process. You can quickly and easily select your material using the integrated wizards. The material portfolio includes over 3,000 solutions for terminal, wire and cable, equipment, and plant identification. Once the appropriate material has been found, the individual, application-specific identification solution can be designed – without requiring any specialist knowledge. The label templates that are created can be stored for future applications. The ability to create the marking directly on site is a particular

advantage when carrying out service call-outs where components need to be marked retrospectively.

The app is available for iOS and Android operating systems. Automatic updates ensure that the app is available both online and offline at all times. The app features state-of-the-art connectivity and intuitive operation and is available in 19 languages.



Create marking data on the go with the Marking system app

Your advantages

- ✔ Unique, mobile interface for the smart selection and creation of marking files directly in the application environment
- ✔ Wireless control of the printer via Bluetooth and app start via NFC by simply placing the smart device on the printer
- ✔ Simplified creation process for application-specific identification solutions with various Application Wizards
- ✔ Saving completed marking projects enables quick and convenient reprinting and project sharing



Marking system app

The dream team for mobile use: THERMOMARK GO and Marking system app

The Marking system app guides you through the entire printing process. It helps you create an optimal marking solution. By systematically requesting application parameters, the software identifies the ideal solution for individual identification needs. All technical data for the selected marking material can be viewed at a glance. In addition to information about material properties and accessories, users also find out which marking system can be used to implement the requirements. Design a durable marking easily on your smart device and control the printer via Bluetooth. High flexibility directly in the application environment enables an efficient identification process. Various Application Wizards support the implementation of application-specific markers – without requiring any specialist knowledge.

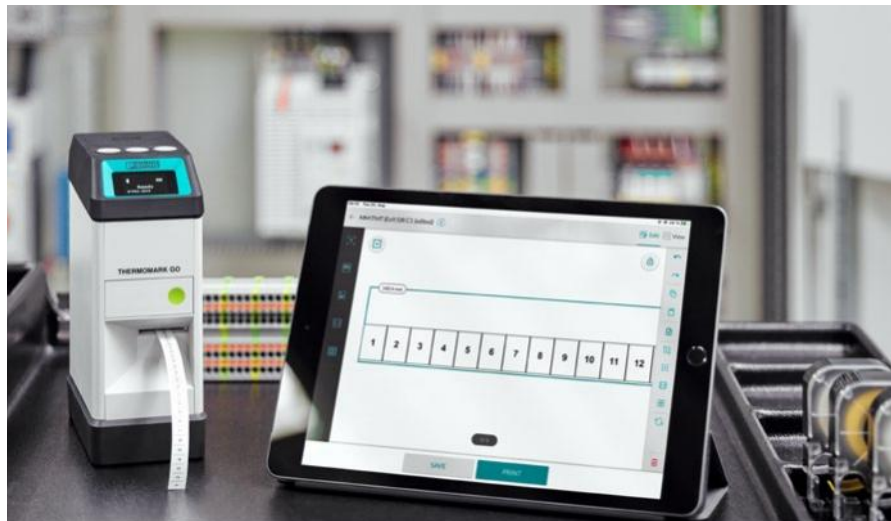

Application Wizards



Patch Panel Wizard

Intuitive and cost-effective creation of labels for the identification of patch panel modules.



Cable Flag Wizard

Flexible creation of cable marking flags from standard materials in continuous format.



Textfield Matrix Wizard

Quick and easy creation of labels for components such as DIN rail-mounted devices or entire terminal strips.



Go here to get to the Marking system app

Functions of the Marking system app



Marking Editor

The Marking Editor allows you to create the required markings directly in the application environment via a tablet or smartphone. Numerous editing functions, such as text formatting, images, logos, and symbols, are available.



Application Wizards

The Application Wizards simplify the creation process for application-specific identification solutions for all use groups. These include the Patch Panel Wizard, the Cable Flag Wizard, and the Textfield Matrix Wizard. This means that special application-specific marking solutions can be designed easily and efficiently – without requiring any previous knowledge.



My Projects

Manage your created projects in a structured and clear way under “My Projects”. This enables you to print your marking quickly and conveniently at a later time. If required, share your projects with other end devices, e.g. via Bluetooth, email, etc.

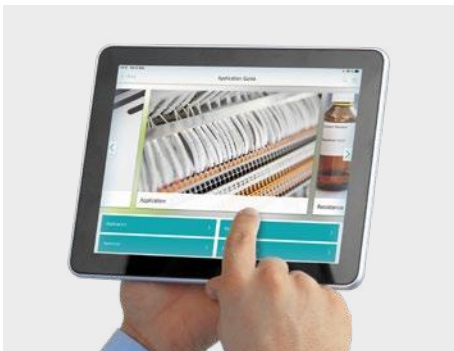

Application Guide

The four overriding filter criteria – application, resistance, approvals, and material properties – enable you to find application-specific marking materials in a structured and simple way, without requiring any specific knowledge in this field.



Product catalog

The digital product catalog containing over 3,000 marking materials enables you to quickly find the right material with the aid of helpful filter functions (e.g., printing system, application, color, etc.).



Product detail view

The product display shows all relevant technical information and types of resistance – including a list of the appropriate marking systems plus fluids and ink ribbons.

Services

4

Marking system offers high-quality, versatile products for designing your individual identification solution – comprehensively, intuitively, and precisely tailored to your needs. Along with software and hardware for creating your markings, this also includes comprehensive services. We offer customized service concepts tailored to your requirements and processes. This is how we support you in the smooth implementation of your processes, simplifying your day-to-day work.





Marking system services

With our services, we provide expert support for any pre-sales, sales, or after-sales issues. Whether by email, phone, or directly on site – we are here to assist you at any time with our individual services.

Installation and setup

We set up your marking system, including the preinstalled software and necessary drivers, directly on site. We then provide you with intensive training on how to use the device and software. We process a series of print jobs with you and provide you with the knowledge you need to safely operate the marking system.



Maintenance and repair

Our service personnel will repair and maintain your marking system quickly and precisely. Service for your printer includes testing the firmware, drivers, and marking software, operation in connection with the material being used, a visual inspection, and operational test. Depending on the type of printer, repairs are carried out on site or at one of our worldwide service centers. You will then receive a detailed report listing all of the steps performed and the parts that have been replaced.



Leased devices

Do you need additional marking capacity on a temporary basis, want to meet project-specific marking requirements, or is your marking system being repaired? Our leased devices are available to you for precisely these reasons. After coordinating with you, we send you the device or install it with you on request and train you how to use it safely.



Service packages

With our service packages, we make sure your marking systems are operating perfectly at all times. Benefit from professional support during device installation, regular maintenance, and free repairs. Choose from various packages and select the combination of services that best suits your needs.



Customer-specific marking

What if you don't have your own marking systems or the right device for your requirements, and you need to cope with order peaks and cover maintenance work and repairs? The web-based Marking Configurator is the solution for all of these challenges. Order standardized and application-specific marking solutions that are custom-marked in accordance with your wishes. Choose a marking solution that suits your requirements from over 2,000 materials.

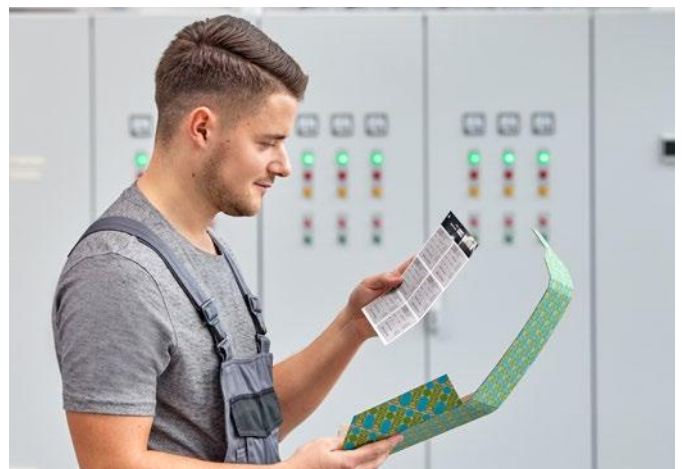

Open communication with customers and partners worldwide

Phoenix Contact is a global market leader based in Germany. We are known for producing forward-thinking products and solutions for the comprehensive electrification, networking, and automation of all sectors of the economy and infrastructure. With a global network, we maintain close relationships with our customers, something we believe is essential for our common success.

You can find your local partner at
phoenixcontact.com

