



**IDEM SAFETY**  
Making Industry Safer



THE QUEEN'S AWARDS  
FOR ENTERPRISE:  
INTERNATIONAL TRADE  
2022



NEW PRODUCTS  
PAGES 4-7



Setting the standard in  
machine safety products

Product Overview Brochure



## What We Do

IDEM designs and manufactures machine safety products, that make industry safer.



## Proud Winners of

The Queen's Award for Enterprise: International Trade 2022

## Our History

### 1985

The founder of IDEM, Medi Mohtasham begins his employment at EJA Engineering where he designed Trojan, Atlas, Rotacam and LRS1 under the Guardmaster brand. Rockwell Automation acquires EJA in 1996.

### 2003

Medi leaves his position as Technical Director of Rockwell to create IDEM Safety Switches, with the vision to develop the 'Next Generation' of Safety Switches, designed and manufactured in the UK.

### 2005

IDEM manufactures the GuardianLine range of safety rope switches, specialising in products for the Food Industry, Explosion Proof applications and Factory Automation.

### Present

Today IDEM operates globally, providing reliable, cost-effective safety interlock solutions that save lives. IDEM continues to invest in new ways to protect your personnel and improve your productivity.

## Why Choose IDEM?



Global leadership in the design and manufacture of machine safety products since 1985.



IDEM's global headquarters is based in the UK with offices in the USA and Europe.



Privately owned business with in house sales, R&D and technical support teams.



Renowned for world-class product quality and reliability on a global scale.



State-of-the-art manufacturing and test facilities. This includes Ingress Protection (IP) and Shock testing.



Exceptional delivery time for both small and large orders. We put the customers' needs first.

# TABLE OF CONTENTS

---

<b>UGB-NET GATE ACCESS WITH INDUSTRIAL ETHERNET</b>	<b>2-3</b>
<b>NETBOX DISTRIBUTED I/O WITH INDUSTRIAL ETHERNET</b>	<b>4-5</b>
<b>MLZ HYGIENIC RFID SOLENOID INTERLOCK</b>	<b>6</b>
<b>MPZ / MMZ COMPACT RFID SAFETY SWITCHES</b>	<b>7</b>
<b>NON-CONTACT STAINLESS STEEL SWITCHES</b>	<b>8-9</b>
<b>NON-CONTACT PLASTIC SWITCHES</b>	<b>10</b>
<b>NON-CONTACT RFID CODED SWITCHES</b>	<b>11</b>
<b>SOLENOID CONTROLLED INTERLOCKS</b>	<b>12-13</b>
<b>MGL-SERIES ELECTROMAGNETIC RFID LOCKING</b>	<b>14</b>
<b>EMERGENCY STOP SWITCHES</b>	<b>15</b>
<b>GUARDIAN LINE SAFETY ROPE PULL SWITCHES</b>	<b>16-17</b>
<b>CONVEYOR BELT ALIGNMENT SWITCHES</b>	<b>18</b>
<b>TWO-HAND CONTROL STATION RUN BARS</b>	<b>19</b>
<b>SAFETY LIMIT SWITCHES</b>	<b>20</b>
<b>SAFETY HINGE SWITCHES</b>	<b>21</b>
<b>Z-RANGE OSSD SAFETY SWITCHES</b>	<b>22-23</b>
<b>SAFETY TONGUE INTERLOCKS (NON-LOCKING)</b>	<b>24</b>
<b>VIPER SAFETY RELAYS</b>	<b>25</b>
<b>TRAPPED KEY INTERLOCKS</b>	<b>26-31</b>
<b>SAFETY PRODUCTS FOR HAZARDOUS AREAS</b>	<b>32-33</b>

# UGB-NET GATE INTERLOCK WITH INDUSTRIAL ETHERNET

The UGB-NET is an industry leading gate access interlock which combines RFID guard interlocking, solenoid lock monitoring, integrated machine control functions and integrated industrial ethernet in one robust housing.



EtherNet/IP<sup>®</sup>



## AVAILABLE IN TWO MATERIAL TYPES



### PAINTED DIE-CAST METAL

- Robust material
- IP65 protection
- Painted red for easy visibility



### 316 STAINLESS STEEL

- Mirror polished finish
- IP69K protection
- Suitable for washdown

## SLIDING AND HINGED DOORS



### SLIDING HANDLE

- Die-Cast Metal and Stainless Steel construction
- Robust shock-bolt for guiding the door closed



### ROTARY HANDLE

- Mirror polished finish
- IP69K protection
- Suitable for washdown

## INTEGRATED CODED RELEASE KEY

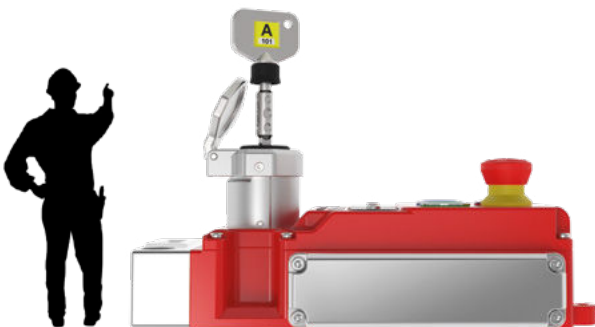

- Operate safely inside hazardous areas with a personnel key
- Custom label coding available (see page 31)
- Can be used inside the hazardous area to operate machinery / robots in teach mode.

## ADDITIONAL I/O

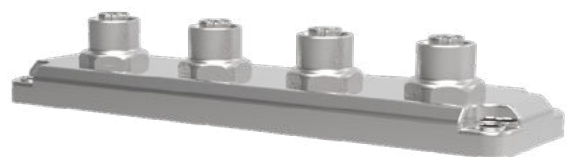

- Up to 4 additional connectors can be added to the UGB-NET
- 3 dual channel safety inputs, 1 dual channel safety output
- 8 standard inputs, 8 standard outputs
- 5-PIN or 8-PIN M12 connectors

# UGB-NET GATE INTERLOCK WITH INDUSTRIAL ETHERNET

## Fully customisable to meet your most demanding requirements.

### EASY TO MOUNT

Custom mounting plates and brackets provide compatibility with both fixed and modular guarding.

Before ordering, discuss with our technical team which guarding you plan to use.

### ROBUST OPERATION

The handle mechanism is manufactured from stainless steel and provides a reliable operation.

The shock-bolt reduces pressure on the switch tongue on heavy doors.

### 4 OR 6 BUTTON VERSIONS

The lid is available with 4 or 6 control devices depending on the model. They are fully configurable for complex requirements.

### ADDITIONAL CONNECTIVITY

Up to 4 additional connectors can be added to the UGB-NET. These can be used to connect field devices directly to your network.

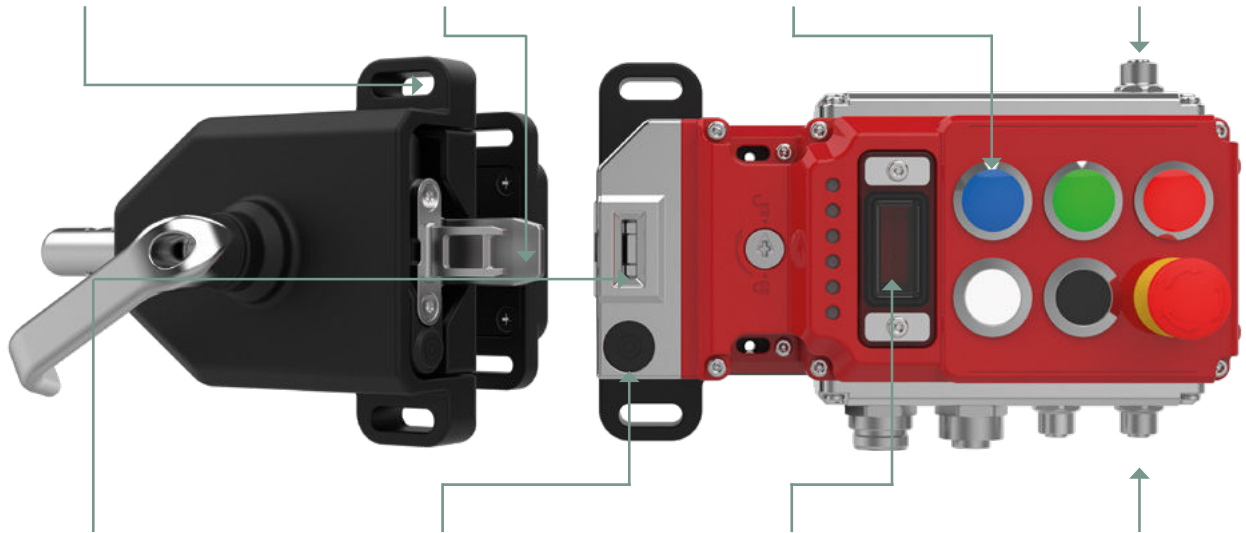

### ANTI-TAMPER CAM SYSTEM

The UGB-NET uses a robust, anti-tamper cam system for reliable mechanical interlocking.

IDEM's patented cam system has been designed to prevent external tampering.

### RFID CODING

Dual RFID antenna's on side and front of the UGB-NET provide high level coding in accordance with EN14119.

The UGB-NET features a re-teach facility should the actuator be lost or damaged

### EASY ACCESS DIP SWITCHES

The DIP switches are easy to access via a removeable polycarbonate cover and does not require the switch lid to be removed.

### CONNECTIVITY

PROFIsafe: Data 2 x M12 D Code 4-Pin / Power 2 x 7/8" 5-Pin

CIP Safety: Data 2 x M12 D Code 4-Pin / Power 2 x M12 A Code 5-Pin

**Other connectors are available on request.**

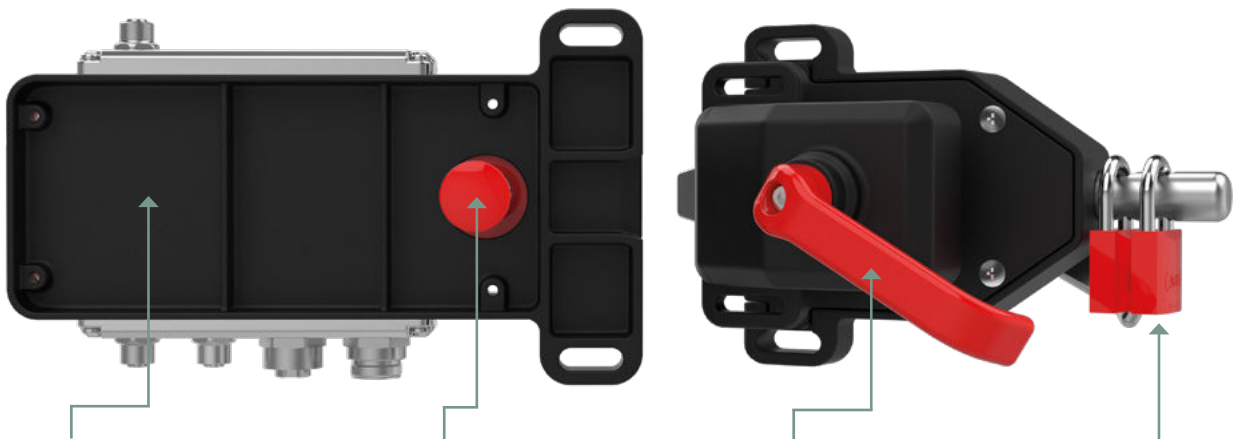

### ROBUST MOUNTING

Robust mounting plate with adjustable mounting holes provide greater flexibility when installing on different sized guards.

### ESCAPE RELEASE BUTTON

Emergency escape button is manufactured from solid stainless steel.

Pressing and holding the button overrides to locking mechanism allowing the handle to be released.

### REAR ESCAPE HANDLE

The rear escape handle is designed to withstand high force in the event of an emergency. It is painted red for ease of visibility from a distance.

### LOCKOUT TAGOUT SUPPORT

Opening the handle releases a bolt which can be used for lockout tagout. This adds additional protection against an inadvertent start-up occurring.

# NETBOX DISTRIBUTED I/O WITH INDUSTRIAL ETHERNET

## Distributed I/O via PROFINET PROFI-safe or EtherNet/IP CIP Safety.

The NETBOX has been designed with fully configurable I/O which can be programmed as 3 dual channel safety inputs or non-safe inputs. The pushbuttons are modular and can be configured over CIP Safety or PROFI-safe.

This industry leading solution provides a convenient way of integrating direct communication to PLC control, benefiting from reduced wiring, quicker installation, reduced maintenance and maximum production up-time.



LIGHT CURTAINS / SCANNERS

STACK LIGHTS

ENABLING PENDANTS

LOCKING SWITCHES

NON-CONTACT SWITCHES

TRAPPED KEY

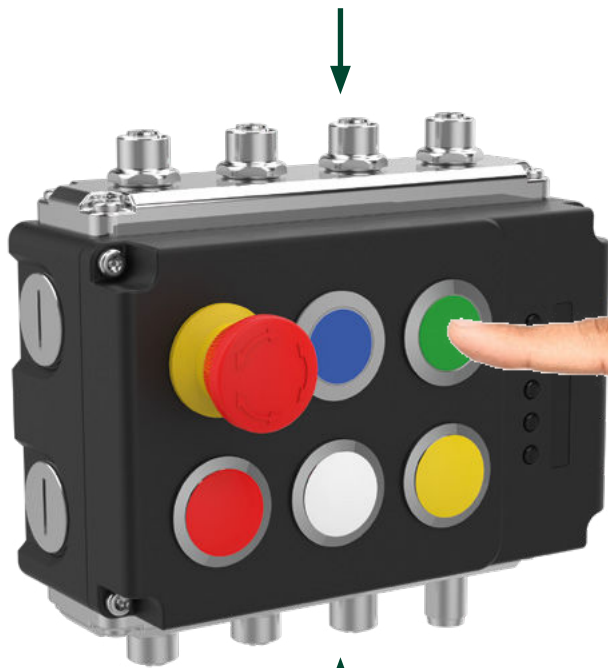

### AVAILABLE IN 316 STAINLESS STEEL

- Mirror polished
- Tested to IP67 and IP69K
- Suitable for strict washdown

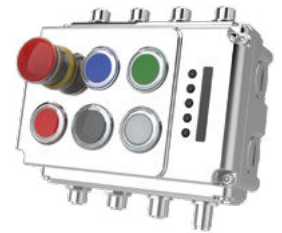

## Configure your control

A choice of illuminated push buttons, lamps, emergency stops and selector switches can be configured for operator and maintenance control. Legacy labels or text / images can be added to the buttons for easy identification of functionality.

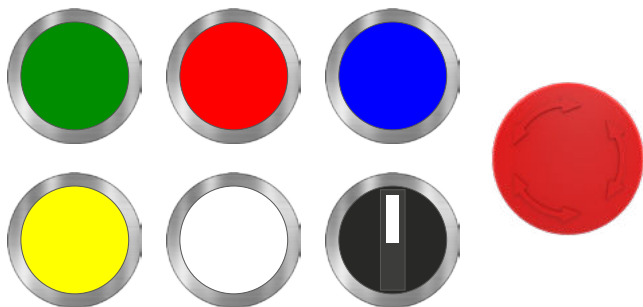

# NETBOX DISTRIBUTED I/O WITH INDUSTRIAL ETHERNET

More companies are starting to seek the benefits of Smart manufacturing in their factories, connecting their automation and control systems to their IT infrastructure via the use of Industrial Ethernet.

Now, factories want to incorporate their safety in the same way.

Making machinery safe often requires a multitude of devices to achieve the correct safety standard, the NETBOX provides the ability to mix safety and non-safety devices on the same network.

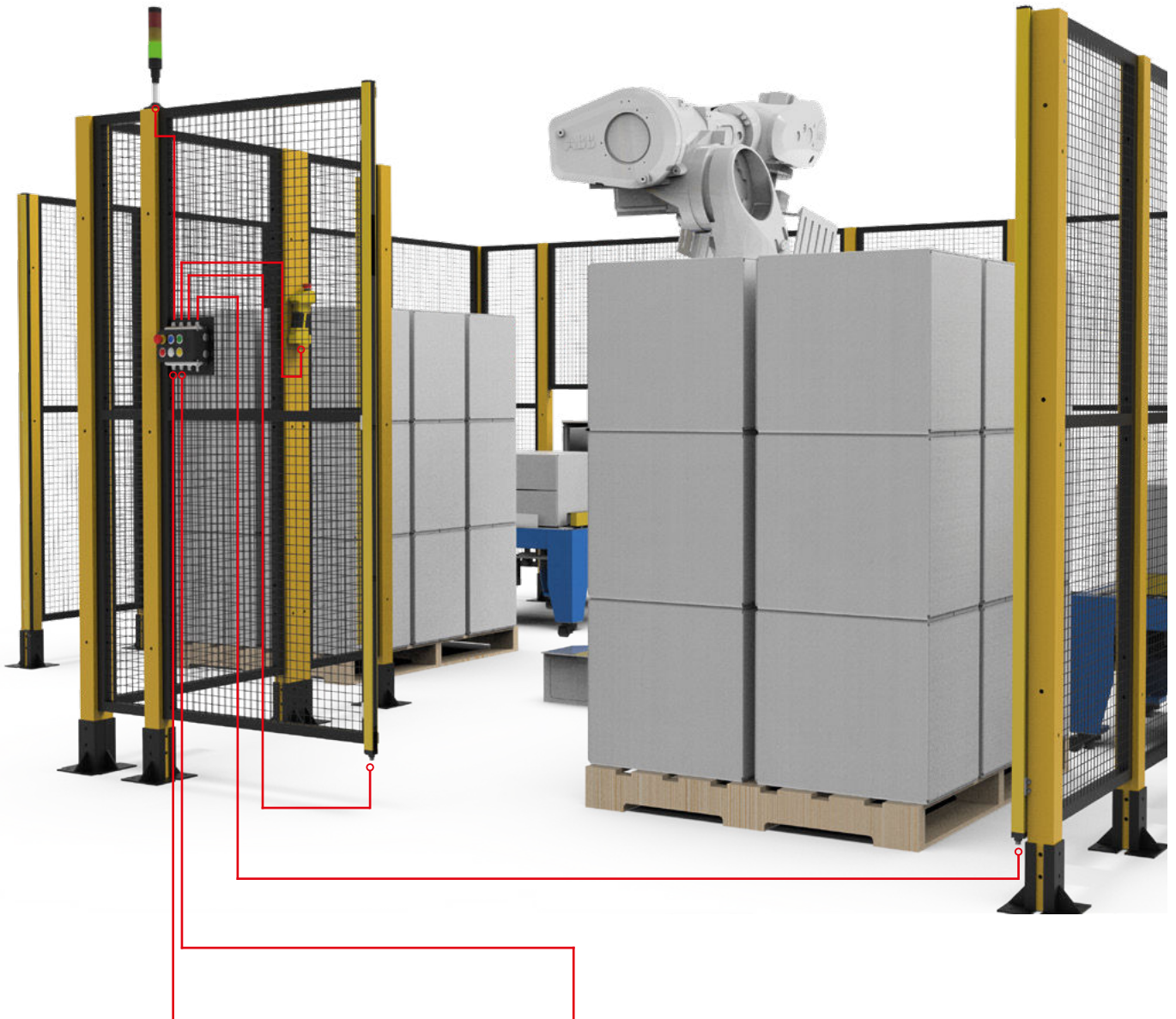

## DATA

The NETBOX features simple to use connectivity for data communication.

- Two Female D-Code M12 Ports.

Special connectors can be used on request. Talk to our technical team for more information.

## POWER

The POWER is supplied via two industry standard connectors.

- PROFISAFE: x1 Female x1 Male 7/8" Connectors
- CIP SAFETY: x1 Female x1 Male M12 Connectors

Special connectors can be used on request. Talk to our technical team for more information.

# MLZ HYGIENIC INTERLOCK WITH RFID



## Small but mighty.

The MLZ is a compact 30mm-wide hygienic safety locking switch housed in mirror polished 316 stainless steel. It features versatile mounting with 3 RFID coded entry points and **OSSD outputs** for series connection. The device's super-compact design means it is compatible with the narrowest of machine guard rails and requires no mounting plate, making it simple to install and maintain.

The MLZ's diminutive size belies its strength and durability, with an impressive **4000N holding force** when locked.

Tested to **IP67 and IP69K** and suitable for SIP and CIP cleaning, this robust interlock is ideal for outdoor use as well as for strict washdown environments, particularly food contact, beverage, and pharmaceutical manufacturing.



### RFID CODED TONGUE

- RFID technology meets the requirements of Type 4 high level coding

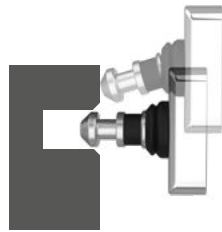

### FLEXIBLE TONGUE

- 316 stainless-steel construction
- Flexible tongue for misaligned guards



### ADJUSTABLE LATCH

- Adjustable latch mechanism for smooth unlocking of all door types.

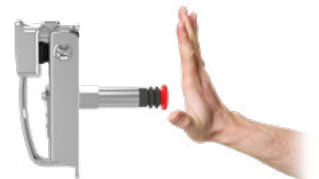

### ESCAPE RELEASE

- Optional escape release
- Can be fitted easily by the end user

## Seamless Integration.

The MLZ's compact design and 3-way head actuation means it can be integrated onto any machine guard door. The flexible actuator and adjustable latch mechanism supports misaligned guards.





# MPZ / MMZ RFID NON-CONTACT SAFETY SWITCH

The MPZ and MMZ are compact and versatile **RFID** safety switches suitable for monitoring doors, gates and other moveable safeguards which demand a high degree of manipulation protection.

The integrated **OSSD outputs** are suitable for series connection up to 30 sensors, maintaining up to **CAT4, SIL3, PLe** in accordance with the latest international safety standards.

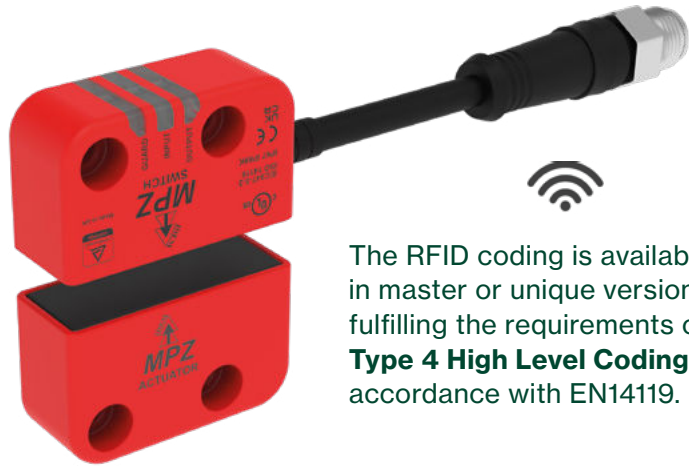

The RFID coding is available in master or unique versions, fulfilling the requirements of **Type 4 High Level Coding** in accordance with EN14119.

Any Coding	Unique Coding
Any actuator will work at any time.	Factory paired, reattach procedure available up to 7 times.



### FLEXIBLE ACTUATION

- The RFID signal is projected on three sides.
- Provides safe operation on five angles, ideal for most guard doors



### VISIBLE INDICATION

- Wraparound LED design
- Shows all switch states clearly
- Easily fault find with input / output display



### SCREW CAP COVERS

- Included with every MPZ purchase
- Provides an extra level of protection against tampering and contaminates



### MMZ HYGIENIC OPTION

- Mirror polished 316 stainless steel
- Tested to IP69K
- The world's smallest RFID safety switch in stainless steel

ON: 12mm OFF: 18mm



The MMZ ensures reliable switching with no interference from the stainless-steel enclosure.



We understand the rigorous cleaning processes involved in high hygiene environments. With that in mind, we have molded the LED lens directly into the casting, meaning no water ingress can occur. The smooth surface reduces the likelihood of food traps.



Other than the switching characteristics, the MMZ shares all the same benefits as the MPZ.

- RFID Coded Actuator
- Mounting on both sides
- Highly visible LED
- OSSD Outputs

# HYGIEMAG AND HYGIECODE NON-CONTACT

- Hygiecode survives shock and vibration
- Operates in temperatures up to 105°C
- Suitable for CIP/SIP high-pressure cleaning
- Stainless Steel 316 IP69K and IP67
- Compatible with most common safety relays to achieve up to Cat. 4/ PLe and SIL 3 to ISO 13849-1 and IEC 62061
- Dual channel 2NC outputs with optional 1NO auxiliary

Specific switches in the HygieMag and HygieCode ranges boast additional hygienic factors. These include mirror polished housings and mounting points from underneath the switch, eliminating food trap areas. These versions are suitable for both splash and direct contact zone applications.

## HYGIEMAG

- High power magnetic sensing.
- Up to 2A ac/dc current switching.
- Sensing up to 12mm.

## HYGIECODE

- Coded actuation.
- Solid state construction.
- Tolerant to shock and vibration.
- LED Guard Status Indication.
- Sensing up to 14mm.

### MMR-H MAGNETIC SWITCH

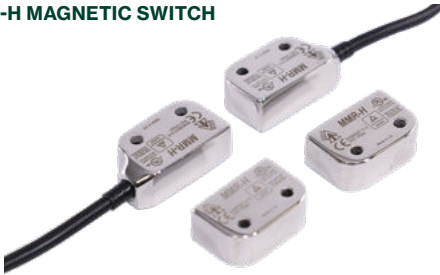

### MMC-H CODED SWITCH Status LED Indicators



- Compact fitting with 22mm fixing
- M4 clearance holes.
- Suitable for mouting with hexagonal head bolts.
- Suitable for splash contact zones.



### SMR MAGNETIC SWITCH



### SMC CODED SWITCH Status LED Indicator



- Compact 50mm long with 22mm fixing hole centres.



### SMR-H MAGNETIC SWITCH



### SMC-H CODED SWITCH Status LED Indicator



- Mounted with hexagonal head bolts to prevent food traps.
- Universal 22mm fixing.
- Suitable for splash contact zones.



### SMR-F MAGNETIC SWITCH



### SMC-F CODED SWITCH Status LED Indicators



- Coded switch sensing 14mm.
- Compact 50mm long with 22mm fixing hole centres.
- Suitable for splash contact zones.



# HYGIEMAG

# HYGIECODE

**LMR MAGNETIC SWITCH**  
Status LED Indicator available



**LMC CODED SWITCH**  
Status LED Indicators



- Can be mounted unobtrusively.
- Suitable for splash contact zones.

**CMR MAGNETIC SWITCH**



**CMC CODED SWITCH**  
Status LED Indicator



- Slim fitting 20mm wide.
- Suitable for splash contact zones.



**CMR-F MAGNETIC SWITCH**



**CMC-F CODED SWITCH**  
Status LED Indicators



- Slim fitting 20mm wide.
- Suitable for splash contact zones.



**WMR MAGNETIC SWITCH**



**WMC CODED SWITCH**  
Status LED Indicators



- Suitable for splash zones in accordance with EHEDG guidelines
- Industry standard wide body



**RMR MAGNETIC SWITCH**



**RMC CODED SWITCH**  
Status LED Indicators



- Barrel type cylindrical fitting with M30 thread.
- 45mm adjustment length.
- Suitable for splash contact zones.



**BMR MAGNETIC SWITCH**



- M18 threaded cylindrical fitting.
- Suitable for all industry applications.
- Easy to install and set.
- 50mm adjustment length.



# IDEMAG

# IDECODE

**MPR MAGNETIC SWITCH**



**MPC CODED SWITCH**



- Compact housing with 22mm fixing.
- Cable exit left or right options available.
- Supplied with hygienic screw cap covers.

**SPR MAGNETIC SWITCH**



**SPC CODED SWITCH**



- Industry standard 22mm fixing.
- Withstands environments of high humidity and wash down conditions.

**LPR MAGNETIC SWITCH**  
Available with LED if required.



**LPC CODED SWITCH**



- Industry standard European housing.
- Narrow fitting for flush mounting.

**CPR MAGNETIC SWITCH**



**CPC CODED SWITCH**



- Industry standard slimline housing.
- Easy to install within narrow frame.
- Heavy duty switching available.

**WPR MAGNETIC SWITCH**



**WPC CODED SWITCH**



- Industry standard fitting.
- Suitable for all industry applications.
- Wide body – tolerant to guard misalignment.

**RPR MAGNETIC SWITCH**



**RPC CODED SWITCH**



- M30 cylindrical fitting.
- Suitable for all industry applications.
- Easy to install and set.
- 45mm adjustment length.

**BPR MAGNETIC SWITCH**



**KPC CODED SWITCH**



- M18 threaded cylindrical fitting (BPR).
- Suitable for all industry applications.
- Easy to install and set.
- 50mm adjustment length (BPR).

# RFID TECHNOLOGY

## NON-CONTACT WITH UNIQUE OR MASTER SERIES CODING

- Guard Status LED - indicates safety circuits closed.
- Compatible with most common safety relays to achieve up to Cat.4 / PL e and SIL3 to ISO 13849-1 and IEC 62061.
- Dual channel 2NC safety outputs - 1NO auxiliary.
- Master or unique RFID coding up to type 4 (high coded).
- Plastic or Stainless Steel 316 housings.



LMF



KPF



SPF



LPF



WPF



BPF



BMF

Gate bolt accessories to be used with LPF, LMF and SPF (including Z-Range equivalents)



GBN-1



GBN-3

## STANDALONE NON-CONTACT WITH CODED MAGNETIC ACTUATOR

- Standalone switches for direct machine control.
- Guard Status LEDs – indicates safety circuits closed.
- Compact housing – fits on 40mm frame sections.
- Compatible with most common safety relays to achieve up to Cat.4 / PL e and SIL3 to ISO 13849-1 and IEC 62061.
- 2NC Relay safety outputs – high current switching 3A.
- Contact feedback circuit (manual or auto).
- Maintain a high level of functional safety without the need to connect to a safety monitoring device such as a safety relay or PLC.



PSA



MSA

## STANDALONE NON-CONTACT DOUBLE DOOR



PSA-D



MSA-D

- Standalone switches for direct machine control.
- Guard Status LEDs – indicates safety circuits closed.
- Compact housing – fits on 40mm frame sections.
- Dual door activation - both actuators have to be present to activate safety outputs.
- Half the wiring + connections.

## GUARD LOCKING INTERLOCKS SOLENOID CONTROLLED



**KL1P  
1400N**

- Plastic body universal 40mm mounting.
- 4 Actuator entry positions – rotatable head.
- Guard locking for small to medium doors.



**KLP  
2000N**

- Medium to heavy duty guards.
- Provides 2NC safety contacts and 2NO aux. contacts or LED indication diagnostics.
- 8 Actuator entry positions – rotatable head.



**KLM  
3000N**

- Die cast metal switch suitable for heavy duty guard locking.
- Provides 4NC safety contacts and 2NO auxiliary contacts or LED indication diagnostics.
- 3 conduit entry points and 30mm fixing.



**KLTM  
3000N**

- Suitable for heavy duty guard locking with solenoid locking.
- Provides 4NC safety contacts and 2NO aux. contacts or LED indication diagnostics.
- 3 conduit entry points. 73mm fixing centres.



**KL1-SS  
2000N**



- Provides 4 actuator entry points.
- Rotatable head.
- 2 lock monitoring safety contacts.
- 2 LEDs for solenoid and lock status.



**KL3-SS  
3000N**



- Choice of 24V 110V or 230V operation.
- 2 LEDs for solenoid and lock status.
- Standard or flexible actuator options available.



**KL4-SS  
3000N**



- Optional request button.
- Choice of 24V 110V or 230V operation.
- 2 LEDs for solenoid and lock status.
- Standard or flexible actuator options available.



**KLT-SS  
3000N**



- Suitable for heavy duty guard locking with solenoid locking.
- Provides 4NC safety contacts and 2NO aux. contacts or LED indication diagnostics.
- 3 conduit entry points.
- 73mm fixing centres.

## SOLENOID CONTROLLED INTERLOCK RFID CODED

The KLT-RFID and KLT-SS-RFID Guard Locking Switches incorporate IDEM's patented anti-tamper CAM system, with the improved security of an RFID coded sensor. The combination ensures maximum security and reliability, even in the most challenging environments.



**KLTM-RFID  
3000N**



**KLT-SS-RFID  
3000N**



## POWER-TO-LOCK MECHANICAL INTERLOCK



**KLP-P2L  
2000N**



**KLTM-P2L  
3000N**



**KLM-P2L  
2000N**



**KL3-SS-P2L  
3000N**



## SOLENOID CONTROLLED INTERLOCK REAR RELEASE

- Rear Release handle for solenoid locking tongue switches with optional extra rear handle.
- Suitable for: KLP, KLM, KLM-RR and KL4-SS.
- Available in Stainless Steel, Plastic and Die Cast
- A manual escape release is used to enable a quick release of the switch lock in case of emergency.



**KLM-RR 3000N**



**GBL-1**



**KL3-SS-RR 3000N**



**GBL-1-SS**

## UNIVERSAL GATE BOX WITH BUILT IN CONTROL FUNCTIONALITY

- High level RFID coded interlocking and machine control.
- Functions in one heavy duty housing.
- They are easily fitted to access doors to provide guard locking, rear escape options and sliding or rotary handles.
- Holds guards closed up to 3000N and can be padlocked off for safe working in maintenance situations.
- Die Cast Metal, painted red, or Stainless Steel 316.
- 4 Station model or 2 Station model.
- Completely flexible – end user can select buttons, lamps, and switches for each station from a wide range of options.



**UGB-KLTM RFID**



**UGB-KLT-SS RFID**

- Choice of rotary or sliding handle accessories with mounting plates.
- Manufactured from die-cast metal and stainless steel.
- Compatible with rear release functionality.
- 2-Station and 4-Station versions



**UGB-SFH-SS / UGB-SFH-M**



**UGB-RFH-SS / UGB-RFH-M**

## KLM-Z-4ST GATE ACCESS WITH BUILT IN CONTROL FUNCTIONALITY



Choice of up to 4 22mm pilot devices

- Solenoid Locking Switch featuring RFID interlocking and incorporating machine control functions.
- The KLM-Z-4ST incorporates all the switch features of the KLM-Z but offers extra machine control functions all in one housing incorporating standard 22mm push buttons, lamps or switches for machine request or control function.
- The KLM-Z-4ST has a slim profile and has been designed specifically to fit on 50mm (2in.) frame sections.
- Robust Stainless Steel 316 head and Die-Cast metal body.
- Choice of standard or flexible actuators.



**GBZ-4ST ROTARY**



**GBZ-4ST SLIDING**

- Choice of rotary or sliding handle accessories with mounting plates.
- Manufactured from die-cast metal and stainless steel.
- Compatible with rear release functionality.

# MGL ELECTROMAGNETIC RFID LOCKING SWITCHES

- The MGL range of switches has been developed in order to provide and maintain a high level of functional safety whilst providing a reliable magnetic door interlock.
- Flexibility for holding force is provided by the provision of 2 different switches sizes; MGL-1 and MGL-2.
- Compatible with most common safety relays to achieve up to Cat.4 / PL e and SIL3 to ISO 13849-1 and IEC 62061.
- Holding forces up to 1500N.
- Stainless Steel 316, Robust Plastic or Die-Cast metal.
- RFID Master or Unique Coding, up to Type4.

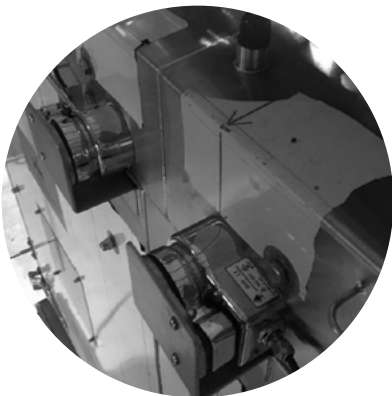
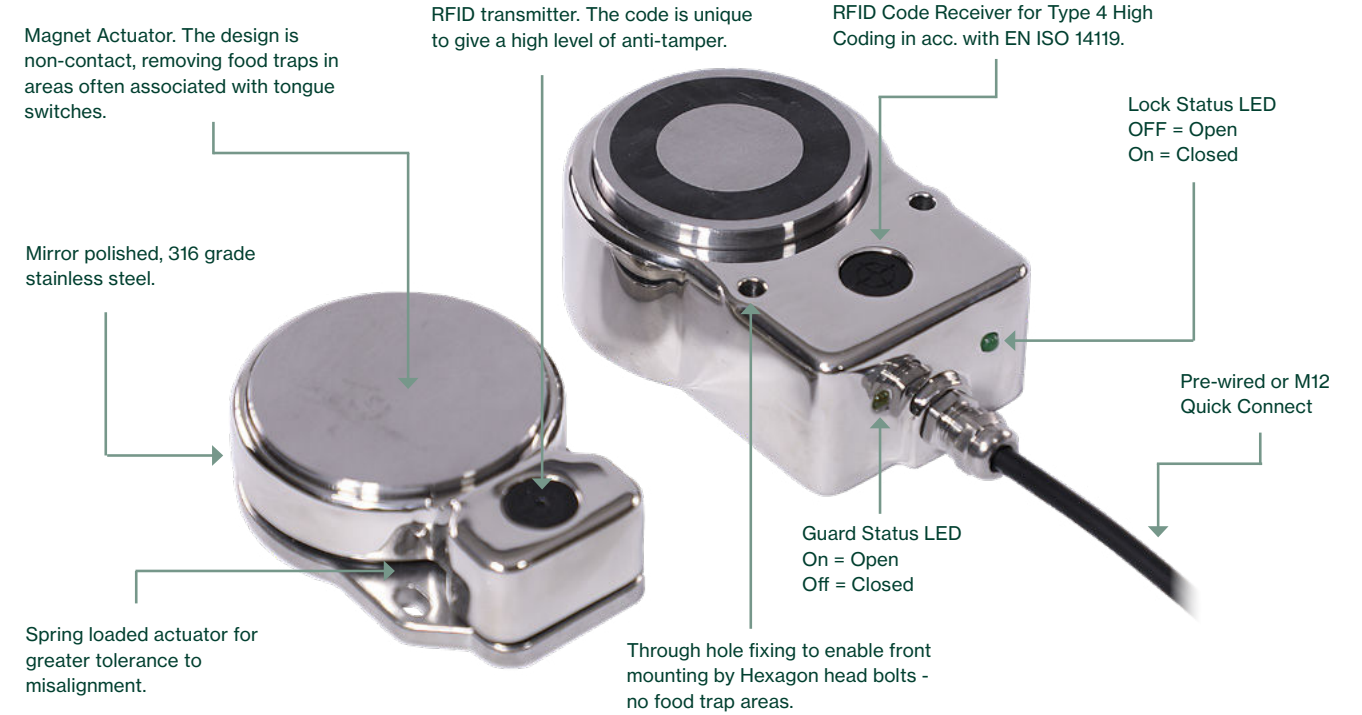

MGL-1SS x 2 are used to hold two doors closed during the wash cycle. The doors are large and prone to heavy use and misalignment.





# EMERGENCY STOP SWITCHES

All IDEM's Emergency Stop Switches conform to European Standard EN ISO 13850 and IEC 60947-5-5. They have a positive mechanical linkage between the switch contacts and the E Stop Button. The switches are mechanically latched and can then only be returned to the operational condition by operating the reset button as required by EN ISO 13850.

- Designed with a special lid safety trip mechanism means that the safety contacts will open if the lid is removed from the Emergency Stop Switch adding an extra level of protection.
- Protection and padlock shroud versions available.
- Two colour LED versions available.



**3 POLE  
ES-P(P)**



**3 POLE  
ES-SS**



**4 POLE  
ESL-SS**



**4 POLE  
ESL-SS(P)**



**3 POLE  
ES-P(P)**



**3 POLE  
ES-SS (P)**



**4 POLE  
ESL-SS(L)**



**4 POLE  
ESL-SS(LP)**



## ESL-SS-WR CONTACT ZONE SUITABLE EMERGENCY STOP



Unique to IDEM, the ESL-SS-WR is the only emergency stop on the market suitable for direct contact zone applications.

Sloped sides to reduce liquid build-up on the surface

X-Ray and Metal Detectable Button

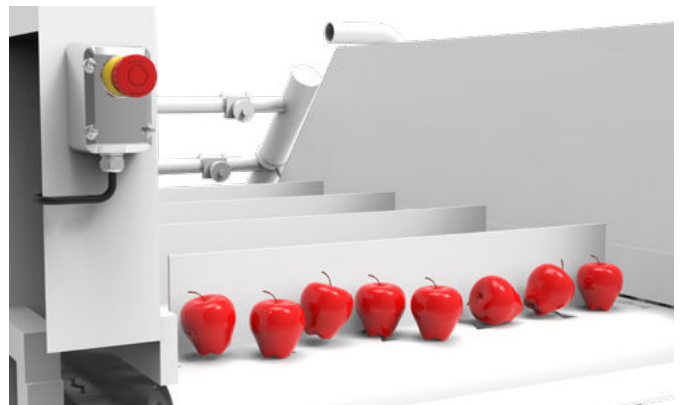
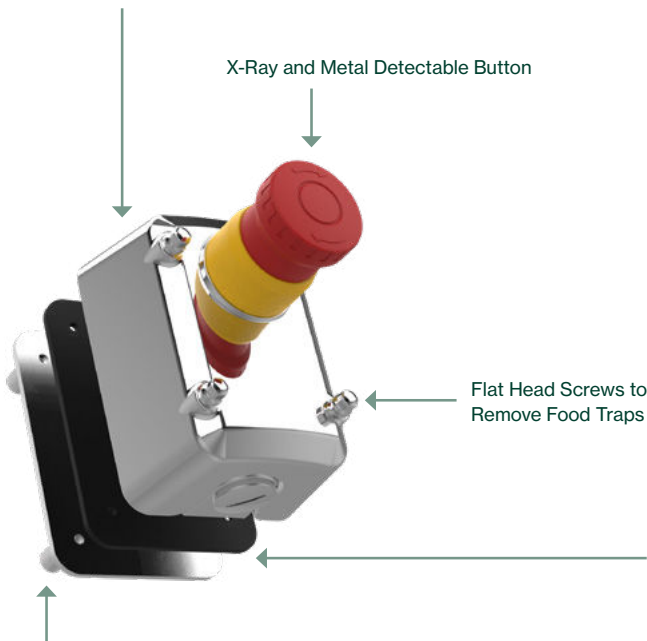

**RUBBER SEAL (239300)**



**SPACER KIT (239301)**

# SAFETY ROPE SWITCHES

The Guardian line safety rope pull switches and grab wire pull cords are designed to be mounted on machines and sections of conveyors which cannot be protected by guards.

All IDEM safety rope pull switches conform to ISO 13850 and IEC 60947-5-5 and have a positive mechanical linkage between the switch contacts and the wire rope. The rope pull switches have wire breakage monitoring.

On pulling the rope, the safety contacts are positively opened and the auxiliary contacts are closed. The safety rope switches are mechanically latched and can then only be returned to the operational condition by pressing the blue reset button as required by ISO 13850.



**GLM**

- Light Duty Safety Rope Pull.
- Protects short conveyer lengths in most industrial applications.
- Up to 50m protection using two switches.
- Up to 30m protection using one switch.



**GLM-SS**

- Stainless steel 316.
- Medium Duty Safety Rope Pull.
- Up to 30m protection using one switch.



**GLS**

- Standard Duty Safety Rope Pull.
- Up to 80m protection using two switches.
- Up to 60m protection using one switch.



**GLS-SS**

- Stainless steel 316.
- Standard Duty Safety Rope Pull.
- Protects conveyer lengths up to 80m using one switch.



## ROPE SWITCHES FOR LONGER PROTECTION LENGTHS

GLH Range of Heavy Duty Safety Rope Pull Switches have been designed to protect long conveyer lengths. A single GLHD can protect up to 100m on each side or combine with GLHR and GLHL for up to 125m (250m total). See diagram below.



**GLHL**



**GLHD**



**GLHR**

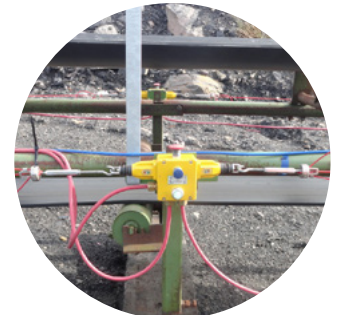

**GLHL-SS**



**GLHD-SS**



**GLHR-SS**

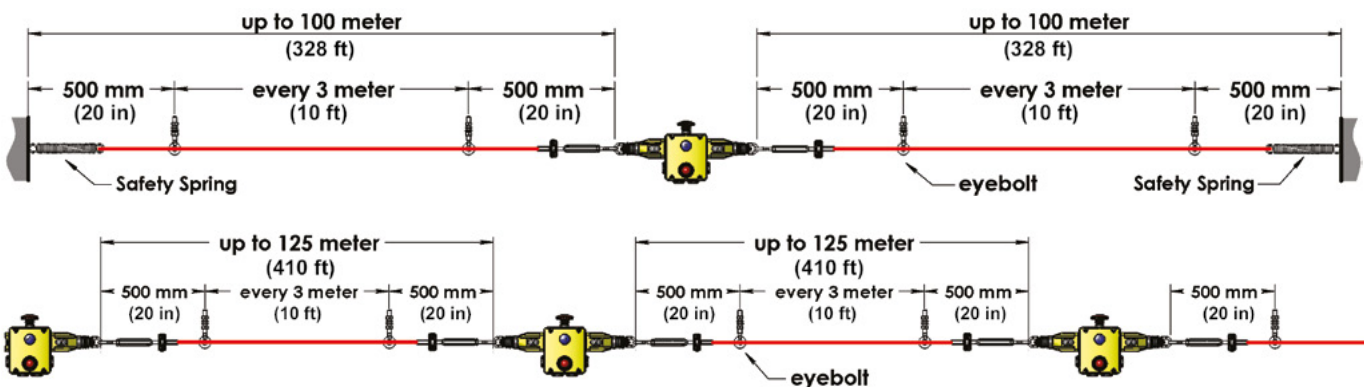

## ROPE SWITCH ACCESSORIES

### ROPE KITS



IDEM's patented Tensioner Gripper system allows for quick and reliable initial setup of the rope, as well as simple maintenance where re-tensioning of the rope is required.

**Rope Kits up to 125m contains:**  
Tensioner Gripper, Rope, Eyebolts and Allen Key.

IDEM Rope Kits come with the correct number of accessories needed to correctly install an GuardianLine Rope Switch.

Galvanised	Stainless Steel	Description	Rope	Standard 84mm	Tensioner	Allen Key
140010	140001	5M Rope Kit	5M QL	3	1	1
140011	140002	10M Rope Kit	10M QL	5	1	1
140012	140003	15M Rope Kit	15M QL	7	1	1
140013	140004	20M Rope Kit	20M QL	9	1	1
140014	140005	30M Rope Kit	30M QL	12	1	1
140015	140006	50M Rope Kit	50M QL	20	1	1
140016	140007	80M Rope Kit	80M	30	2	1
140017	140008	100M Rope Kit	100M	37	2	1
140018	140009	126M Rope Kit	126M	45	2	1

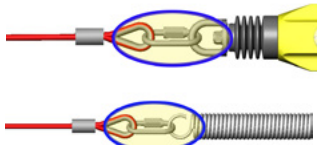

For systems up to 50m a Quick Link termination is provided for easy connection to either a Safety Spring or Switch eyebolt.

### OPTIONAL ACCESSORIES



**UNIVERSAL PULLEY**



**SAFETY SPRING**  
Stainless Steel 220mm Length.



**TENSIONER / GRIPPER**



**QUICK LINK**



**FLEXIBLE ROLLER**



**FLEXIBLE ROLLER EYEBOLT WITH NUTS**



**PIGTAIL EYEBOLT**



**STANDARD EYEBOLT**

### FLEXIBLE EYE BOLT ROLLERS

When using rope pull switch systems on conveyors, the rope is supported along the conveyor length by equally spaced eyebolts.

Traditional eyebolts are made from solid metal and offer an eyelet to support the rope and provide a catenary between eyebolts which deflects the rope during pulling.

On long conveyors, eyebolt mounting positions can vary along the length of the conveyor and therefore mis-alignment can cause friction, making the system difficult to operate. After operation the rope system, the rope may not be able to move (due to the friction) and allow the switch mechanism to be reset.

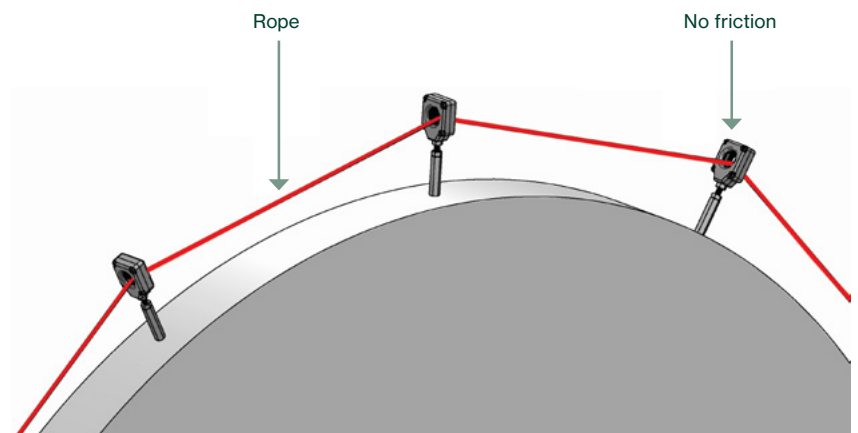

# CONVEYOR BELT ALIGNMENT SWITCHES

- Contacts: 2NC 2NO
- Supply: 24V or 110V or 230V
- Indication: With or without LED
- Conduit Entry: M20 or 1/2"NPT fitting

- Operating Torque: 3.0 – 5.0Nm
- Warning Signal: 10 – 18 degrees
- Stop Initiated: 15-35 degrees
- Ingress Protection



## DIE CAST

## STAINLESS STEEL



**BELT SWITCH 35MM DIAM.**  
Short Roller

**BELT SWITCH 50MM DIAM.**  
Medium Roller

**BELT SWITCH 35MM DIAM.**  
Long Roller



**BELT SWITCH 35MM DIAM.**  
Short Roller

**BELT SWITCH 50MM DIAM.**  
Medium Roller

**BELT SWITCH 35MM DIAM.**  
Long Roller

## WARNING SIGNAL AND STOP SIGNAL

### WARNING SIGNAL

- Contact block 1
- Adjustment cam.
- Allen screw (2.5mm)
- Tightening Torque 2Nm
- Factory setting 14 degrees
- (Adjustable 10 to 18 degrees)

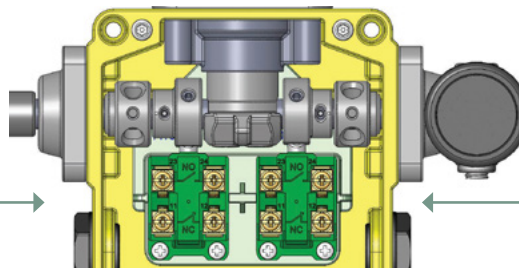

### STOP SIGNAL

- Contact block 2
- Adjustment cam.
- Allen screw (2.5mm)
- Tightening Torque 2Nm
- Factory setting 25 degrees.
- (Adjustable 15 to 35 degrees)

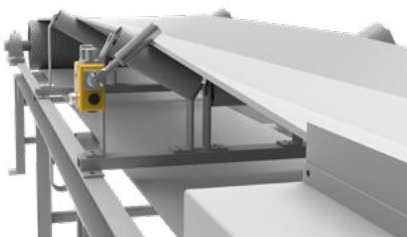

Set in the safe position. The belt is currently aligned and working as intended.

The operational torque can be adjusted to cope with belt sensitivity or mounting angle.

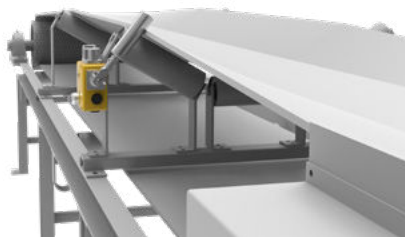

Belt begins to drift triggering the warning signal. This can be displayed on the LED or through the N/O auxiliary contact to the PLC / HMI. Conveyor still operational at this point.

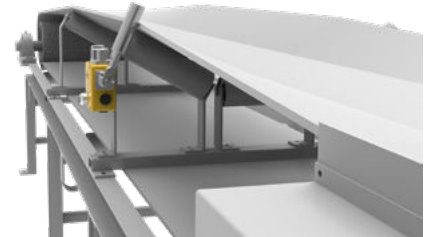

Belt has now moved to the edge of the roller triggering the stop signal. The conveyor is now off. This can be displayed on the LED or through the N/O auxiliary contact to the PLC / HMI.

## PYTHON CONVEYOR MINI BELT ALIGNMENT

- Miniature Belt Alignment switches are mounted on sections of narrow conveyors to protect against belt drift due to an unintentional movement.
- Miniature Belt Alignment Switch has the option of stainless steel or plastic roller and is housed in a rugged die cast aluminium or stainless steel body, which are mounted on sections of narrow conveyors to protect against belt drift due to an unintentional movement.
- Positive opening NC safety contact to EN60947-5-1
- Slow break or snap action contacts
- High mechanical life over 500,000 cycles
- Industry standard mounting to EN5004



# TWO-HAND CONTROL STATIONS

IDEM's TouchSafe Two-Hand Control Stations are designed to provide reliable protection by ensuring the machine operators hands are located on the control station when the signal for machine operation is issued.

TouchSafe Two-hand Control run bars are generally used for setting-up work, such as press applications. Other uses include single-stroke operations for feed and removal processes.



**MF BUTTON (MECHANICAL)**

- Mechanical operation - suitable for long term use.
- 100% replaceable with M12 pig tail connect for quick installation.



**ZF BUTTON (ZERO FORCE)**

- Dual colour LED (red - waiting (green - activated).
- Requires minimal contact to operate (reduces strain on your hands and arms).
- 100% replaceable with M12 pig tail connect for quick installation.

## TWO-HAND CONTROL STATION

- Solid die-cast body painted yellow and black
- Includes 5 22mm pilot device ports (unused ports sealed with blanks)
- Hand protection shrouds

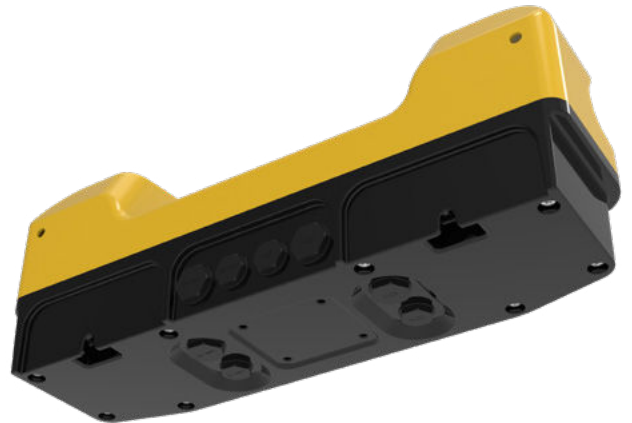

## CONNECTIVITY AND INSTALLATION

- External mounting points for easy installation
- Two 3/4" NPT conduit entries
- Two 1/2" NPT conduit entries
- Two M20 conduit entries
- Two M25 NPT conduit entries

The SCR-2H can be installed externally or, internally as part of your Touch-Safe system.



## ADJUSTABLE FLOOR MOUNT

- Constructed from stainless steel
- Adjustable height 830mm to 1150mm

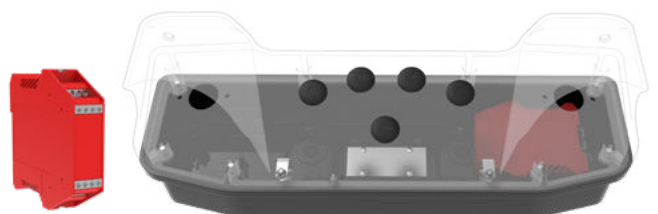

## SAFETY LIMIT SWITCHES

- Positive opening contacts to IEC60947-5-1.
- Industry standard mounting to EN50041.
- Rotary or Linear Actions.
- M20 or 1/2" NPT conduit entry.
- High mechanical life expectancy – 2,500,000 cycles.
- 2NC 1NO - 3NC - 2NC 2NO - 3NC 1NO - 4NC



HLM Die Cast Metal – EN50041 IP67

HLM-SS Stainless Steel EN50041

## SAFETY LIMIT SWITCHES

- Positive opening safety contacts to IEC 60947-5-1
- Choice of 11 actuator heads: Linear, Rotary and Flexible actions
- High mechanical life expectancy - 2,500,000 cycles.
- Head position adjustment any of 4 positions
- Enclosure protection to IP67 making them suitable for washdown
- Conduit entries: M20 1/2" NPT or Quick Connect



LSPS Plastic - EN 50047

## MINIATURE SAFETY LIMIT SWITCHES

- Standard duty plastic body or robust, die cast body
- Positive opening NC safety contacts to IEC60947-5-1
- Unique 3 pole positively operated contacts.
- Choice of 7 actuator heads Linear and Rotary
- High mechanical life expectancy - 2,500,000 cycles.
- Side or end cable exit
- Enclosure protected to IP67
- Operating temperature -25C to 80C



## MICRO SWITCHES

To complement our range we now stock a wide range of the most popular micro switches including Pin Plunger, Roller Lever Panel Mount types, Short and Long Hinge Lever, etc.



## HINGE INTERLOCK SAFETY SWITCHES



**HC-1**

- Polyester body and Stainless Steel head.
- 2 N/C or 1 N/C + 1 N/O.
- Hollow shafts available.
- Solid shafts are available as: 10mm dia. and 50 or 80mm long or as 8mm dia. and 60mm long.



**HC-3**

- Polyester body and Stainless Steel head.
- 2 N/C + 1 N/O.
- Hollow shafts available.
- Solid shafts are available as: 10mm dia. and 50 or 80mm long or as 8mm dia. and 60mm long.



**HC-SS**

- Mirror Polished 316 Stainless Steel (IP69K)
- 2 N/C + 1 N/O.
- Hollow shafts available.
- Solid shafts are available as: 10mm dia. and 50 or 80mm long or as 8mm dia. and 60mm long.



**IDIS-2**

- Compact fitting.
- 18mm fixing profile.
- The head can be rotated through 90 degree increments to provide ease of mounting in 4 positions.
- Suitable for food splash/contact zones.



## HINGE INTERLOCK SAFETY SWITCHES

- Available in either die cast or stainless steel housing.
- Designed to be mounted for interlock position sensing of hinged moving guards.
- They feature positive opening contacts in accordance with IEC 60947-5-1 and after fitting the switch offers a very high degree of anti-tamper.

- Positive actuation of the contacts is achieved at only 6 degrees of opening of the guard and can be adjusted up to 12 degrees if required upon installation.
- 800N Axial Holding Force
- Blank hinges available for use on large doors.



**HSM**



**HS-SS**



**BLANK STAINLESS STEEL**



**BLANK DIE CAST**

# Z-RANGE – OSSD OUTPUTS

- The Z-Range of safety devices feature self monitoring and OSSD outputs to achieve CAT4 PLe (ISO 13849-1) and SIL3 (IEC 62061) even when connected in a series.
- Up to 30 Z-Range devices can be connected to one safety relay.
- The high precision stainless steel castings combined with a double seal ensures a IP69K protection level or yellow painted die-cast.
- IDEM's RFID Technology is available with high and low coding acc. ISO 14119. Switch and actuator are supplied pre-taught from the factory for the customers convenience.
- The uniquely coded versions have up to 32 million code variations, reducing the likelihood of manipulation or defeat.
- The Z-Range features extended diagnostics presented by the device LEDs and auxillary output signals that can help reduce downtime by allowing quick identification of individual device stats.

## SAFETY ROPE SWITCHES

### STAINLESS STEEL



GLM-SS-Z



GLS-SS-Z

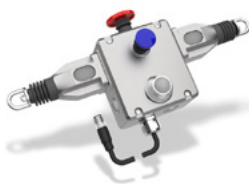

GLHD-SS-Z



GLHL-SS-Z



GLHR-SS-Z

### DIE CAST



GLM-Z



GLS-Z



GLHD-Z



GLHL-Z



GLHR-Z

## EMERGENCY STOP SWITCHES



ES-P-Z



ESL-SS-Z(L)



ESL-SS-Z(LP)



## SAFETY TONGUE INTERLOCKS



KM-Z



KM-SS-Z



## HINGE INTERLOCK SAFETY SWITCH

- Stainless Steel 316 or Die Cast
- Left and Right Hinges
- Blank hinges used on applications where two hinges are needed.



HS-SS-Z



HSM-Z



## NON-CONTACT RFID SWITCHES

- RFID with Unique or Master Series Coding.
- Tamper resistant operation.
- Safety outputs short-circuit protected.
- Wide sensing range.
- Tolerant to guard misalignment.
- Cable or quick connect options.



LPZ



LMZ



BPZ



BMZ



## SOLENOID LOCKING RFID SWITCHES

IDEM's Z-range solenoid-controlled guard switches feature RFID coding and provide a robust and secure lock mechanism that keeps the guard closed until the hazard has been removed. The head features two RFID entry points (top and front) and can be rotated 360 degrees to provide up to 8 different entry positions.

Available in plastic, red painted Die Cast or 316 Stainless Steel.



KLP-Z 2000N



KLM-Z 3000N



KL3-SS-Z 3000N



## NEW SOLENOID LOCKING SWITCH WITH CODED RELEASE KEY

KLM-Z-SKR is a solenoid controlled, RFID coded tongue interlock with OSSD outputs. The mechanical coded key is trapped until the solenoid is energised; turning the key and removing it permits access to the hazardous area.

The interlock cannot be restarted until the key has been returned.

Solenoid Controlled Release Key (Reduces the likelihood of inadvertent start-ups)

OSSD Outputs and internal self monitoring suitable for **CAT4, SIL3, PLe** in accordance with EN ISO 13849-1 and EN62061.

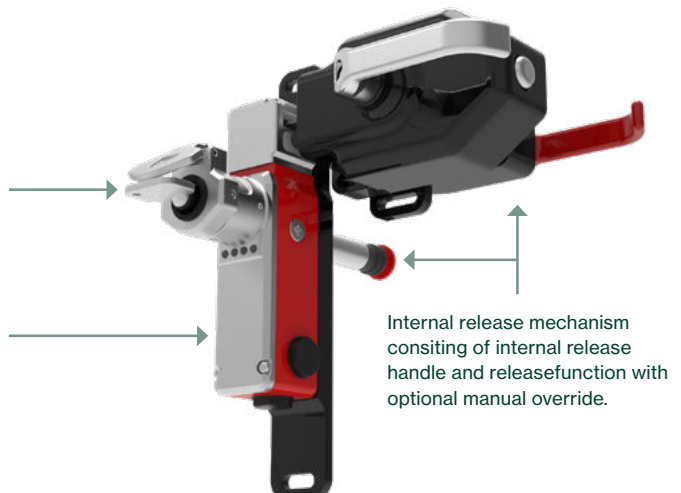

Internal release mechanism consisting of internal release handle and release function with optional manual override.

# TONGUE OPERATED SAFETY INTERLOCKS

- IDEM Tongue Operated Safety Interlock Switches are designed to fit to the leading edge of sliding, hinged or lift off machine guards to provide position interlock detection for moving guards.
- For harsh environments like food processing, pharmaceutical and petro-chemical industries, the Stainless Steel 316 range offers protection up to IP69K for use in high pressure chemical cleaning or CIP/SIP applications.

- They can be used independently to provide positively operated contacts to EN60947-5-1.
- They can be used in combination with any dual channel safety monitoring relays to provide up to Category 4 PLe and SIL 3 to ISO 13849-1 and EN 60261.



**KM**

- 8 Actuator entry positions.
- 3 pole or 4 pole contact blocks.
- 30mm fixing.
- IP67 ingress protection.



**KM-SS**



**KM-SS**

- Mirror polished surface finish (Ra4).
- Head rotates to protect head assembly and prevent tampering with switch.
- Provides 8 actuator entry positions.



**K-15**

- 4 Actuator entry positions - designed with a rotatable head.
- Compact body with 3 conduit entries – 40mm fixing.
- 3 pole contact blocks.
- IP67 ingress protection rating.



**K-15-SS**



**KP**

- 4 Actuator entry positions – designed with a rotatable head.
- 3 pole or 4 pole contact blocks.
- 3 conduit entries.



**KP-SS**



**K-SS**

- Universal fitting.
- Suitable for most general applications.
- Replaceable contact blocks.
- Head rotates to give 4 actuator entry points

## MINIATURE TONGUE INTERLOCK



**INCH-1**

- 17mm fixing centres.
- 8 Actuator entry positions – designed for robustness with a rotatable Stainless Steel 316 head.
- 2 pole contact blocks.
- IP67 or IP69K ingress protection.



**IDIS-1**

- Suitable for food processing and petro-chemical industries.
- 8 Actuator entry positions – rotatable head.
- 3 pole contact blocks or 2 pole snap action.
- 17mm fixing.



**INCH-3**

- 8 Actuator entry positions – designed with a rotatable Stainless Steel 316 head.
- 3 pole contact blocks.
- Choice of 3 conduit entries.
- Plastic housing with IP67 ingress protection
- 22mm fixing.



**MK1-SS**

- Compact with 22mm fixing centres.
- Mirror polished finish.
- Suitable for most applications.
- Replaceable contact blocks.
- Provides 8 actuator entry points.
- Standard or flexible actuator.

## SAFETY RELAYS

All relays include a combination of the below diagnostics.

<b>Power</b>	Power applied to device
<b>Reset</b>	Reset Circuit is closed
<b>CH1</b>	External switch input 1 closed
<b>CH2</b>	External switch input 2 closed
<b>K1</b>	Internal relay safety output contacts closed
<b>K2</b>	Internal relay safety output contacts closed
<b>K3</b>	Internal relay safety output contacts closed
<b>K4</b>	Internal relay safety output contacts closed

- Dual force guided relay output contacts with high current up to 6A each.
- Up to Cat. 4PLe and SIL 3 acc. to ISO13849-1, IEC 62061 and IEC 61508.
- Single or dual channel input.
- Feedback loop for monitoring contactors.
- Short circuit and earth fault monitoring.
- Automatic or monitored manual start.
- Instant or delayed contacts
- Pluggable terminals available



SCR-21-i



SCR-31-i



SCR-31P-i



SCR-73-i



SCR-31-42TD-i



SEU-31-i



SEU-31TD-i

# SKORPION TRAPPED KEY INTERLOCKS

IDEM's Trapped-key interlocks utilise locks and coded keys for sequential control of equipment and machinery to ensure safe operation. Trapped-key interlocks are widely used to ensure safe access to potentially live or dangerous plant or equipment in an industrial setting.

- Mirror Polished Die-Cast Metal
- 316 Stainless Steel (IP69K)
- Designed and Manufactured in the UK
- Comprehensive Range
- Robust with high Mechanical Integrity
- Thousands of Codes Available

## CONTROL / ISOLATION

The first stage of any trapped key system is to isolate the power or control circuit. This should STOP any hazardous processes.

## KEY EXCHANGE

The second stage is exchange. The isolator key can be used to open 1 access lock at a time or, if there are multiple access locks, a key exchange

## ACCESS CONTROL

Access locks prevent entry to the hazardous areas. Only when the correct coded key is presented, will entry be permitted.

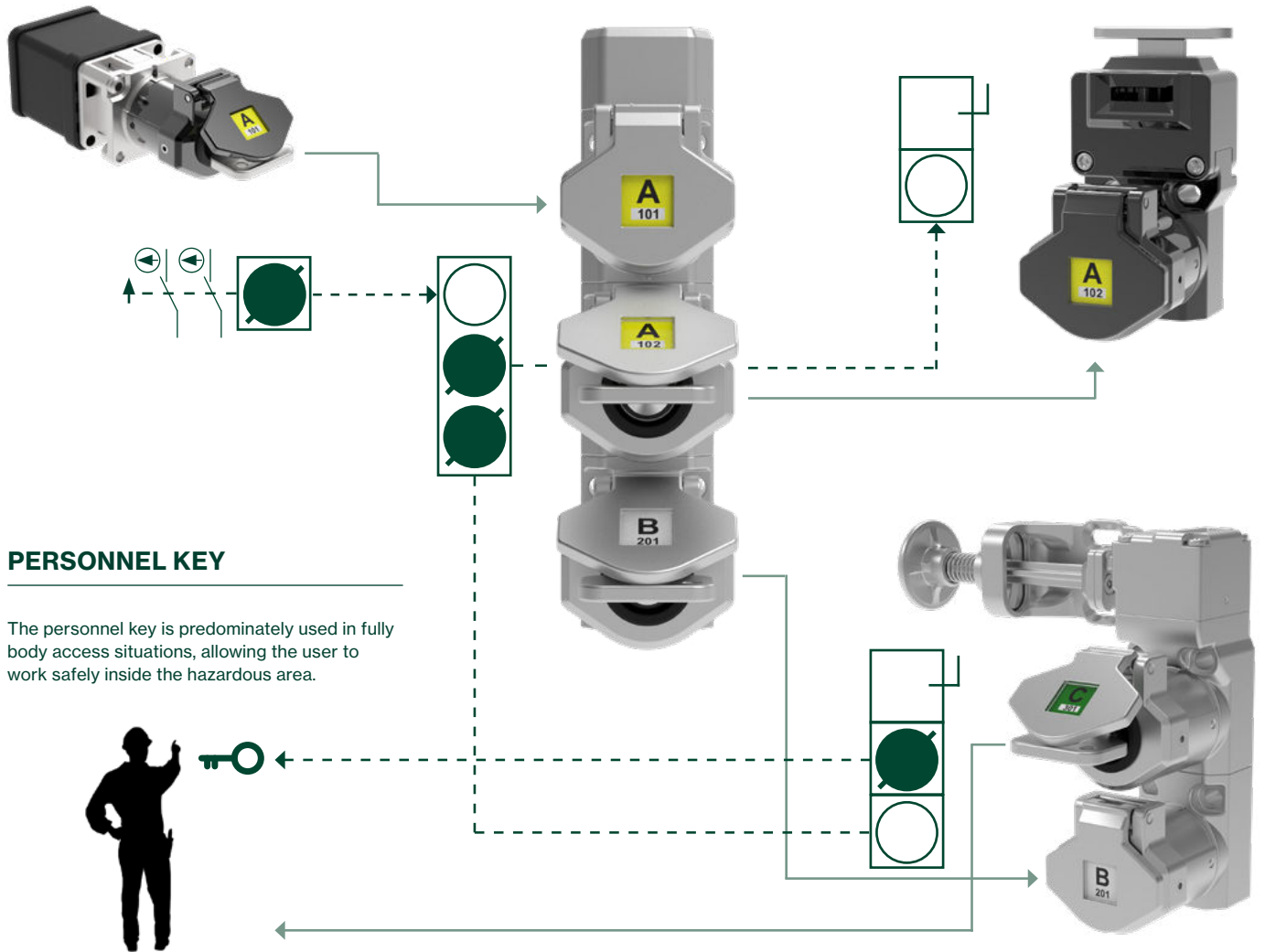

## PERSONNEL KEY

The personnel key is predominately used in fully body access situations, allowing the user to work safely inside the hazardous area.



## POWER ISOLATION



- ISB1**
- Die-Cast or 316 Stainless Steel 316
  - 25A or 40A



- ISB2**
- Die-Cast or 316 Stainless Steel 316
  - 60A



- ISP**
- Die-Cast or 316 Stainless Steel 316
  - 25A or 40A

# SKORPION TRAPPED KEY INTERLOCKS

## CONTROL SWITCH



**ISB-CB**

- Die-Cast or 316 Stainless Steel 316



**TS-CB**

- Die-Cast or 316 Stainless Steel 316



**CS**

- Die-Cast or 316 Stainless Steel 316

## POWER ISOLATION WITH SOLENOID CONTROLLED KEY RELEASE



**ISP-SKR-WR**

- Die-Cast or 316 Stainless Steel 316
- 25A or 40A
- 24Vdc Solenoid



**ISP-SKR**

- Die-Cast or 316 Stainless Steel 316
- 25A or 40A
- 24Vdc Solenoid



**ISP-SKR**

- Die-Cast or 316 Stainless Steel 316
- 25A or 40A
- 24Vdc Solenoid

## CONTROL SWITCH WITH SOLENOID CONTROLLED KEY RELEASE

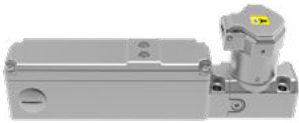

**ISB4-SR**

- Die-Cast or 316 Stainless Steel 316
- 24Vdc Solenoid

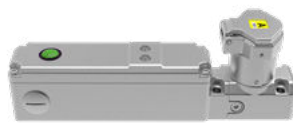

**ISB4-SR – with Request Button**

- Die-Cast or 316 Stainless Steel 316
- 24Vdc Solenoid



**CS-SKR**

- Die-Cast or 316 Stainless Steel 316
- 24Vdc Solenoid



# KEY EXCHANGE

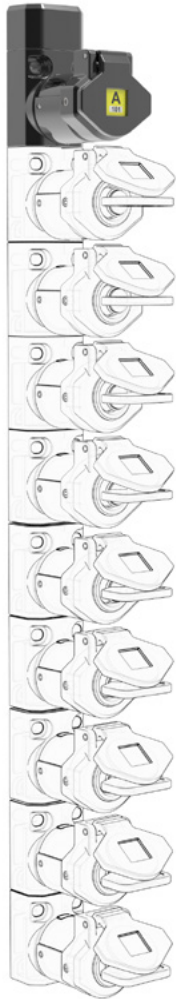

Part Number	Key Exchange - 316 Stainless Steel	
SS-KE-NS2	2 Keys	First Key Trapped All remaining keys can be released non-sequentially
SS-KE-NS3	3 Keys	
SS-KE-NS4	4 Keys	
SS-KE-NS5	5 Keys	
SS-KE-NS6	6 Keys	

Part Number	Key Exchange - Mirror Polished Die-Cast	
M-KE-NS2	2 Keys	First Key Trapped All remaining keys can be released non-sequentially
M-KE-NS3	3 Keys	
M-KE-NS4	4 Keys	
M-KE-NS5	5 Keys	
M-KE-S6	6 Key	First Key Trapped All remaining keys can be released sequentially
M-KE-S7	7 Key	
M-KE-S8	8 Key	
M-KE-S9	9 Key	
M-KE-S10	10 Key	

## LARGER SYSTEMS



**MX-P-8-2X6 PANEL MOUNTED**  
**MX-B-8-2X6 BOX MOUNTED**

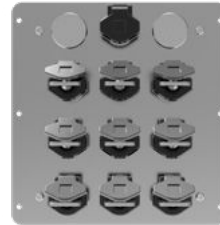

**MX-P-12-3X9 PANEL MOUNTED**  
**MX-B-12-3X9 BOX MOUNTED**

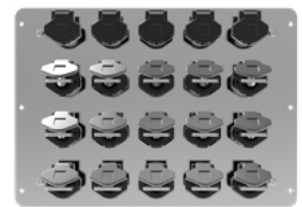

**MX-P-20-5X15 PANEL MOUNTED**  
**MX-B-20-5X15 BOX MOUNTED**

## NEW PANEL MOUNT CONTROL SWITCH AND KEY EXCHANGE COMBINATION

The new CS control isolation switch is available in 4 versions; monitored, monitored with solenoid controlled key, monitored with solenoid controlled key reversed and mechanical release only. All 4 variations can be used in conjunction with each other, combining control isolation and key exchange.



**M-CS / SS-CS**

- Stainless Steel Control Switch
- Available in stainless steel (ss) (pictured) or die-cast metal (m)
- 4NC 2NO Contacts
- 240V 3A Max



**M-CS-SKR / SS-CS-SKR**

- Control Switch with Solenoid Key Release
- Available in stainless steel (ss) (pictured) or die-cast metal (m)
- 4NC 2NO Contacts
- 240V 3A Max - 24VDC Solenoid



**M-KR / SS-KR**

- Stainless Steel Mechanical Key Release
- Available in stainless steel (ss) (pictured) or die-cast metal (m)



# TRAPPED KEY INTERLOCKS - ACCESS CONTROL

## SINGLE KEY WITH ACTUATOR



**TS**  
· Die-Cast or 316 Stainless Steel 316

## DUAL KEY WITH ACTUATOR



**TD-11**  
· Die-Cast or 316 Stainless Steel 316

## BOLT INTERLOCK

### SINGLE KEY



**BS**  
· Die-Cast or 316 Stainless Steel 316

### DUAL KEY



**BD-11**  
· Die-Cast or 316 Stainless Steel 316

### IMPORTANT

When the key is inserted and the bolt retracted, you must block the bolt so that it cannot extend until the door is in the closed position.

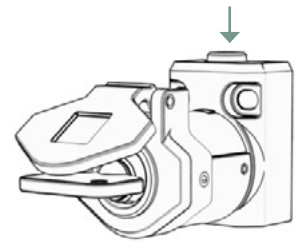

## HANDLE INTERLOCK

### SINGLE KEY WITH ACTUATOR



**HS**  
· Die-Cast or 316 Stainless Steel 316



**HS-C – with chain**  
· Die-Cast or 316 Stainless Steel 316

### DUAL KEY WITH ACTUATOR



**HD-11**  
· Die-Cast or 316 Stainless Steel 316



**HD-11-C – with chain**  
· Die-Cast or 316 Stainless Steel 316

### SINGLE KEY WITH ACTUATOR



**HT-S-11**  
· Die-Cast or 316 Stainless Steel 316

### DUAL KEY WITH ACTUATOR

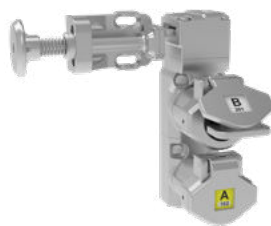

**HT-D-11**  
· Die-Cast or 316 Stainless Steel 316

360 degrees rotating dual entry head with Anti-Tamper cam system.

Flexible actuator for misaligned guards.

Spring loaded handle.



# VALVE INTERLOCKS

IDEM's mini valve locks can be used standalone or easily integrated as part of a SKORPION Trapped Key solution. The key can then be removed and can be moved to safe storage (to avoid tampering) or can be integrated with trapped key guard interlocks to protect operators from machine, gas or air hazards that may be present.

Available as (FOP) Key Free Valve Open, Passing state or as (FCL) Key Free, Valve Closed, Non Passing state.

## Features and Benefits.

**Compact designs** allows for ease of installation and eliminates the need for electrical wiring. Skorpion Valve Interlocks are virtually maintenance free, apart from scheduled inspection checks.

**Robust build quality:** Available in Stainless Steel 316 or Die Cast metal housing. Operates within temperatures between -40C to +170C at 40Bar (600PSI)

**Ease of clean:** Suitable for CIP and SIP cleaning processes and can be high pressure hosed with detergents at high temperatures.

**Freezing the fluid in the installation may severley damage the valve.**

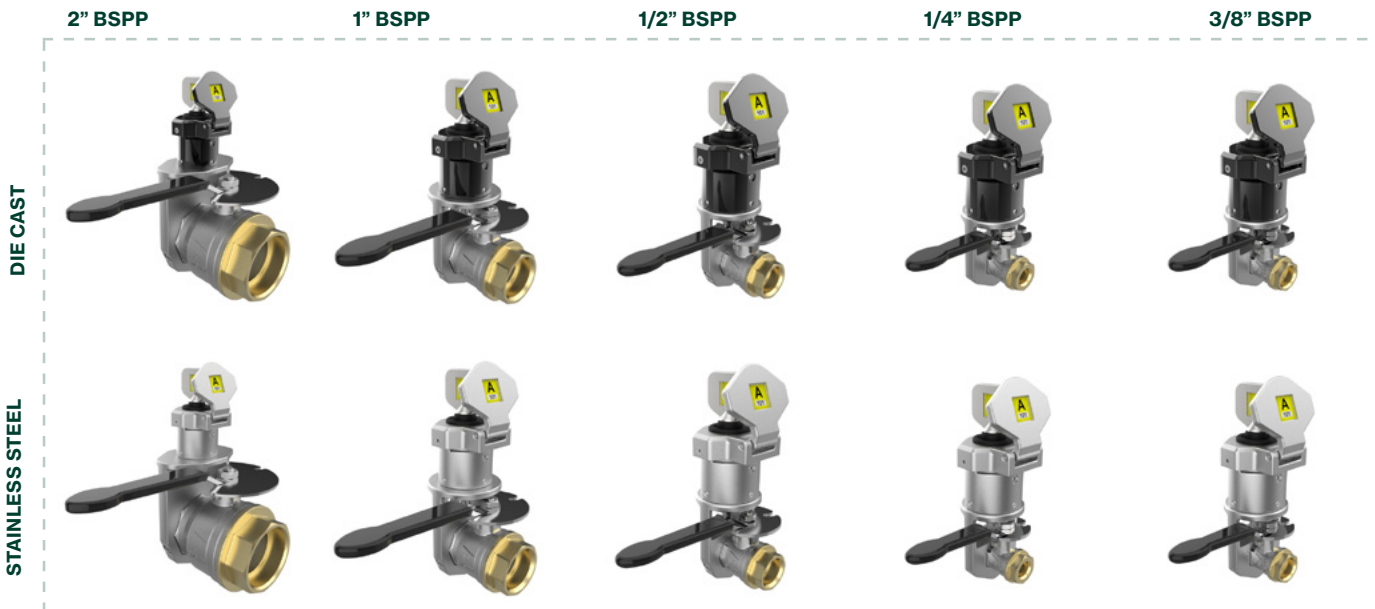

Part Number	A (mm)	B (mm)	C (mm)	Valve Size BSP
MV-FCL 1/4	96	125	39	0.25 Inch
MV-FOP 1/4	96	125	39	0.25 Inch
MV-FCL 3/8	96	125	39	0.375 Inch
MV-FOP 3/8	96	125	39	0.375 Inch
MV-FCL 1/2	118	129	50	0.5 Inch
MV-FOP 1/2	118	129	50	0.5 Inch
MV-FCL 1	146	137	67	1 Inch
MV-FOP 1	146	137	67	1 Inch
MV-FCL 2	202	161	106	2 Inch
MV-FOP 2	202	161	106	2 Inch



# CODED KEYS

## STANDARD KEY (SK)



SK keys can be used throughout the system and all Sales Numbers start with SK- followed by a letter and then three digits e.g. SK-C306

## EJECTOR KEY (EK)

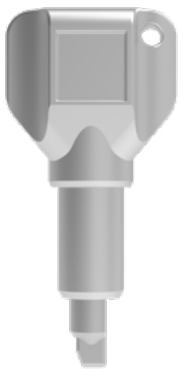

EK ejector keys can be used where a secondary function requires an operator to enter and carry the key into a hazardous area.

Different key fob colours are available dependent upon the code chosen. This is a customer option to provide the end-user with an easily seen visual aid e.g. The First Key (Primary Key) could be chosen in a different colour to the colour chosen for the Released Keys - therefore easily distinguishing the Primary Key from the other keys in the system.

- Thousands of key codes available
- Custom key labels available on request

Yellow		White		Green		Blue	
A101	A111	B201	B211	C301	C311	D401	D411
A102	A112	B202	B212	C302	C312	D402	D412
A103	A113	B203	B213	C303	C313	D403	D413
A104	A114	B204	B214	C304	C314	D404	D414
A105	A115	B205	B215	C305	C315	D405	D415
A106	A116	B206	B216	C306	C316	D406	D416
A107	A117	B207	B217	C307	C317	D407	D417
A108	A118	B208	B218	C308	C318	D408	D418
A109	A119	B209	B219	C309	C319	D409	D419
A110		B210		C310		D410	

If you require more key codes than shown above, increase the number by 1 (example: A119 > A120 > A121 and so on)

# CUSTOM KEY (CK)

## CHOOSE YOUR COLOUR

5 colours are available to choose from.



**LABEL**  
Fully customisable label. Any character configuration can be used as long as it fits within 33x12mm.

## HOW TO ORDER

Using the key codes above, add CK to the front of the description. For example: CK-A101 will have a yellow label and A101 coding.

The customised description needs to be added to the order against each key.

# SAFETY FOR HAZARDOUS AREAS









IDEM's product portfolio includes safety switches that are safe to use in potentially explosive atmospheres. A mixture of air gases, vapours, mists or dusts can combine in a way that can ignite under certain operating conditions.

ATEX products sold with 3m pre-wired cable, longer cable lengths are available upon request. Please note, this cannot be changed after the product has been manufactured.

A place in which an explosive atmosphere is...	Gases	Dusts
Continually Present	0	20
Likely to occur in normal operation occasionally	1	21
Not likely to occur in normal operation and only for very short durations	2	22

## NON CONTACT MAGNETIC SAFETY SWITCHES

**II 2G Ex mb IIC T6 Gb**      **II 2D Ex mb IIIC T80 Db IP67**      **ZONES 1 / 2 / 21 / 22**

 <b>CM1-Ex</b>	 <b>CM2-Ex</b>	 <b>CM3-Ex</b>	 <b>RM-Ex</b>
 <b>LM-Ex</b>	 <b>WM2-Ex</b>	<div style="border: 1px solid black; padding: 5px;"> <p><b>II 1G Ex ma IIC T6 Ga</b></p> <p><b>II ID Ex ma IIIC T80 Da IP67</b></p> <p><b>ZONES 0 / 1 / 2 / 20 / 21 / 22</b></p> </div>	 <b>WM1-Ex</b>

## EMERGENCY STOP STATIONS

**Exd IIC T6 (-20 ≤ Ta ≤ +60C) Gb**      **Ex tb IIIC T85C (-20 ≤ Ta ≤ +60C) Db**      **ZONES 1 / 2 / 21 / 22**

 <b>ESL-SS(P)-Ex</b>	 <b>ESL-SS-Ex</b>
--	---

## CONTROL SWITCH ISOLATION

**Exd IIC T6 (-20 ≤ Ta ≤ +60C) Gb**      **Ex tb IIIC T85C (-20 ≤ Ta ≤ +60C) Db**      **ZONES 1 / 2 / 21 / 22**

 <b>ISB-CB-Ex</b> · Die-Cast or 316 Stainless Steel 316	 <b>TS-CB-Ex</b> · Die-Cast or 316 Stainless Steel 316
--	---

IDEM's product portfolio includes safety switches that are safe to use in potentially explosive atmospheres. A mixture of air gases, vapours, mists or dusts can combine in a way that can ignite under certain operating conditions.

ATEX products sold with 3m pre-wired cable, longer cable lengths are available upon request. Please note, this cannot be changed after the product has been manufactured.

## TONGUE INTERLOCK SWITCHES (NON-LOCKING)



Exd IIC T6 (-20 ≤ Ta ≤ +60C) Gb



Ex tb IIIC T85C (-20 ≤ Ta ≤ +60C) Db

ZONES 1 / 2 / 21 / 22



K-SS-Ex



KP-Ex



KM-Ex



KM-SS-Ex

## SAFETY ROPE PULL SWITCHES



Exd IIC T6 (-20 ≤ Ta ≤ +60C) Gb



Ex tb IIIC T85C (-20 ≤ Ta ≤ +60C) Db

ZONES 1 / 2 / 21 / 22



GLHR-Ex



GLHD-Ex



GLHL-EX



GLS-EX



GLHR-SS -Ex



GLHD-SS -Ex



GLHL-SS -Ex



GLS-SS-Ex

## CONVEYOR AND BELT ALIGNMENT



Exd IIC T6 (-20 ≤ Ta ≤ +60C) Gb



Ex tb IIIC T85C (-20 ≤ Ta ≤ +60C) Db

ZONES 1 / 2 / 21 / 22



50MM dia. 120MM Length



35MM dia. 170MM Length

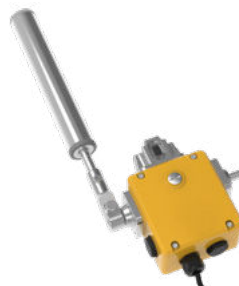

35MM dia. 230MM Length



MINI BELT ALIGNMENT Ex

· Die-Cast or 316 Stainless Steel 316

· Die-Cast or 316 Stainless Steel 316

· Die-Cast or 316 Stainless Steel 316

· Die-Cast or 316 Stainless Steel 316

## SAFETY LIMIT SWITCHES



Exd IIC T6 (-20 ≤ Ta ≤ +60C) Gb



Ex tb IIIC T85C (-20 ≤ Ta ≤ +60C) Db

ZONES 1 / 2 / 21 / 22



HLM-SRL-Ex



HLM-ARL-Ex



HLM-PP-Ex



HLM-RP-Ex



THE QUEEN'S AWARDS  
FOR ENTERPRISE:  
INTERNATIONAL TRADE  
2022



---

### **IDEM SAFETY SWITCHES LTD**

2 Ormside Close, Hindley Green  
Wigan, United Kingdom  
WN2 4HR

+44 (0) 1942 257070  
sales@idemsafety.com

---

**[WWW.IDEMSAFETY.COM](http://WWW.IDEMSAFETY.COM)**



---

### **IDEM SAFETY SWITCHES USA**

2574 South Beverly Street  
Boise, Suite 100  
ID 83709

+1 (510) 445 0751  
salesusa@idemsafety.com

---

**[WWW.IDEMSAFETYUSA.COM](http://WWW.IDEMSAFETYUSA.COM)**



**IDEM SAFETY**  
Making Industry Safer

