

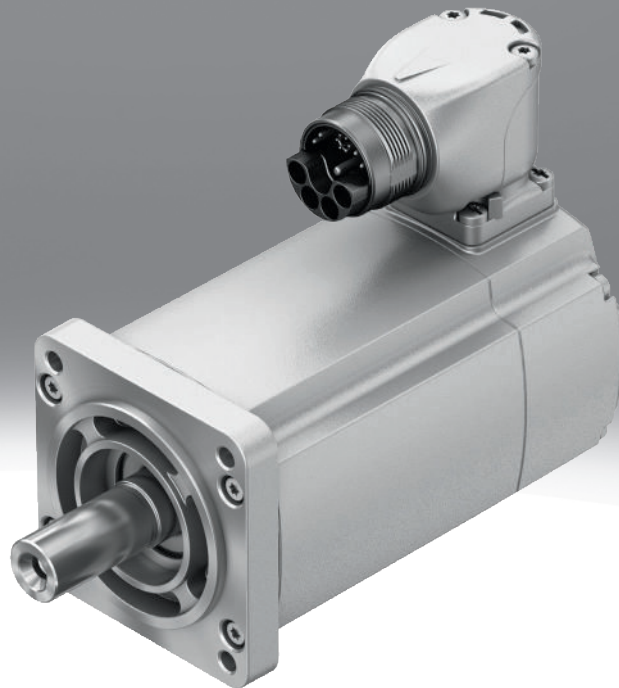

Servo motor EMMT-AS, EMMT-EC

FESTO



Characteristics

At a glance

[Link](#)  [emmt-as](#)

EMMT-AS-40 ... 190:

- Dynamic, brushless, permanent magnet synchronous servo motors

EMMT-EC-40:

- Dynamic, brushless, permanent magnet synchronous servo motors for operation at low voltage

- Extremely low cogging torque – supports high synchronisation even at low rotational speeds
- Digital motor temperature transmission via EnDat 2.2; motor protection via CMMT-AS

Digital absolute encoder system:

- Single turn
- Multi-turn, without battery
- Multi-turn, without battery, with SIL3 for flange sizes 60/80/100 (optional)
- Multi-turn, without battery, with SIL2 for flange sizes 150/190 (optional)

Winding variants:

- Torque optimised
- Rotational speed optimised

Degree of protection:

- IP21 (motor shaft) for flange sizes 150/190
- IP40 (motor shaft without radial shaft seal) for flange sizes 40/60/80/100
- IP67 (motor housing with connection technology)
- IP65 (motor shaft with rotary shaft seal made of PTFE)

Optional:

- Holding brake
- Shaft with feather key
- Motor shaft with rotary shaft seal

Ordering data - modular system

[Link](#)  [emmt-as](#)

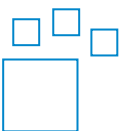

Configurable product

This product and all its product options can be ordered online via the configurator.

Characteristics

Engineering tools

Link [electric motion sizing](#)



Save time with engineering tools: Smart engineering for the optimal solution. Our goal is to increase your productivity. Our engineering tools play an integral part in achieving this goal. They help you size your system correctly, tap into unimagined productivity reserves and generate additional productivity along the entire value chain. In every phase of your project, from the initial contact to the modernisation of your machine, you will come across a number of different tools that will be of use to you.

Electric Motion Sizing

- Create the optimum drive package quickly and reliably. Electric Motion Sizing calculates suitable combinations of electric axis, electric motor and servo drive using just a few application details. It provides all the relevant data including the bill of materials and documentation for your selected combination. This avoids design errors and results in significantly improved energy efficiency for the system. A smooth connection to the Festo Automation Suite also makes commissioning easier for you.

Festo Automation Suite

- Parameterisation, programming and commissioning in a clear and user-friendly interface
- Optimal support for complex processes thanks to guided wizards (e.g. for initial commissioning, drive configuration, etc.)
- Quick access to the required documents and further information
- Easy integration of electric drives in the controller programming

Diagrams

Link [emmt-as](#)



The diagrams shown in this document are also available online. These can be used to display precise values.

Radial shaft seal

[R] With standard shaft sealing ring

- Achieves degree of protection IP67 together with the sealing ring
- The sealing ring must be replaced after a maximum of 5000 operating hours, subject to the operating conditions.
- Information on installation/replacement: www.festo.com/sp

Electrical connection

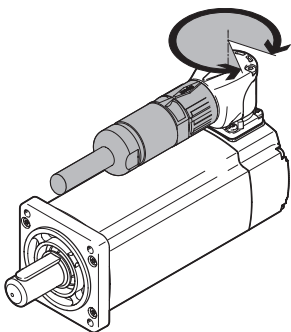

Simple connection technology (OCP: one cable plug) – hybrid cable: motor cable and connecting cable for supply and encoder in one

For motor cable NEBM-LX/M17:

- The connection can be freely selected in the range from 0 to 290°.

For NEBM-M23 and NEBM-M40 motor cable:

- The connection can be freely selected in the range from 0 to 310°.

Characteristics

Measuring unit

[S] Absolute encoder, single turn

- The angular position is assigned to a unique value in coded form.
- The position is only detected within one turn. All subsequent turns need to be counted by the higher-level device.
- When switched off, the position is only sensed within one turn.
- Following switch-on, a homing run is required.

[MY] Absolute multi-turn safety encoder, EnDat®

- Properties such as absolute multi-turn encoder
- Also available with 'functional safety' SIL 2 or SIL 3 (depending on the flange size)
- Securely mounted encoder

[M] Absolute encoder, multi-turn

- A unique value in coded form is assigned to the angular position and each full turn.
- This type counts the full turns until the specified maximum is reached (including when switched off).
- Homing is only required once it has been installed in the application.

Brake

[B] With brake

The holding brake should not be used as a safety brake.

Type code

001	Series	
EMMT	Motor	

002	Motor type	
AS	AC synchronous	
EC	EC motor	

003	Flange size, motors [mm]	
40	40	
60	60	
80	80	
100	100	
150	150	
190	190	

004	Length	
S	Short	
M	Medium	
L	Long	
H	Very long	

005	Output shaft	
	Smooth shaft	
K	Shaft with featherkey according to DIN 6885	

006	Radial shaft seal	
	None	
R	With standard shaft sealing ring	

007	Winding	
ES	Safety extra-low voltage, standard	
HS	High voltage, standard	
HT	High voltage, torque optimised	
HV	High voltage, speed optimised	
LS	Low voltage, standard	

008	Electrical connection	
R	Angled plug, rotatable	
R1	Angled plug M17, rotatable	
R2	Angled plug M23, rotatable	
R3	Angled plug M40, rotatable	

009	Measuring unit	
M	Absolute encoder, multi-turn	
MC	Absolute encoder, multi-turn, BISS-C	
MY	Absolute multi-turn safety encoder, EnDat®	
S	Absolute encoder, single turn	
SC	Absolute encoder, single-turn, BISS-C	

010	Brake	
	None	
B	With brake	

Datasheet

General

Motors and motor controllers from Festo have been specially designed to be used together. Trouble-free operation cannot be guaranteed in combination with third-party controllers.

General technical data - EMMT-EC-40, EMMT-AS-40

Flange size, motors [mm]	40							
Length	Short [S]				Medium [M]			
Winding	Safety extra-low voltage, standard [ES]		Low voltage, standard [LS]		Safety extra-low voltage, standard [ES]		Low voltage, standard [LS]	
Brake	None [L]	With brake [B]	None [L]	With brake [B]	None [L]	With brake [B]	None [L]	With brake [B]
Nominal operating voltage DC ¹⁾	48 V		325 V		48 V		325 V	
Nominal motor current	4.2 A		1.2 A		5.2 A		1.2 A	
Continuous stall current	4.4 A		1.3 A		5.2 A		1.6 A	
Nominal power rating of motor	96 W		154 W		138 W		234 W	
Nominal torque ²⁾	0.23 Nm		0.21 Nm		0.44 Nm		0.32 Nm	
Peak current	20 A		5.4 A		20 A		6 A	
Peak torque	0.85 Nm		0.83 Nm		1.32 Nm		1.41 Nm	
Standstill torque	0.24 Nm				0.45 Nm			
Standstill torque constant ³⁾	0.06 Nm/A		0.24 Nm/A		0.1 Nm/A		0.32 Nm/A	
Nominal rotary speed	4,000 rpm		7,000 rpm		3,000 rpm		7,000 rpm	
Max. rotational speed	9,100 rpm		15,600 rpm		5,770 rpm		11,800 rpm	
Max. mechanical speed	15,000 rpm							
Max. brake no-load speed	–	12,000 rpm	–	12,000 rpm	–	12,000 rpm	–	12,000 rpm
Angular acceleration	100,000 rad/s ²							
Motor constant	0.055 Nm/A		0.175 Nm/A		0.085 Nm/A		0.267 Nm/A	
Voltage constant, phase-to-phase	3.6 mV/min		14.6 mV/min		5.8 mV/min		19.3 mV/min	
Electric time constant	0.82 ms		1.06 ms		1.02 ms		1.24 ms	
Thermal time constant	4.6 min				21.4 min			
Thermal resistance	1.58 K/W				1.35 K/W			
Number of pole pairs	5							
Phase-phase winding resistance	1.1 Ohm		13.1 Ohm		0.87 Ohm		7.96 Ohm	
Phase-phase winding inductance	0.9 mH		13.9 mH		0.89 mH		9.8 mH	
Winding longitudinal inductivity L _d (phase)	0.35 mH		5.3 mH		0.34 mH		3.8 mH	
Winding cross inductivity L _q (phase)	0.45 mH		6.9 mH		0.45 mH		4.9 mH	
Total mass moment of inertia of output	0.039 kgcm ²	0.045 kgcm ²	0.039 kgcm ²	0.045 kgcm ²	0.07 kgcm ²	0.076 kgcm ²	0.07 kgcm ²	0.076 kgcm ²
Permissible axial shaft load	30 N							
Permissible radial shaft load	150 N							

1) With 3-phase mains supply to the servo drive, a voltage of up to 3x 400 VAC +10% is permitted.

2) When using the radial shaft seal, a reduction (derating) of the nominal torque of 10% must be observed.

For motors with safety encoders, a derating must be taken into account in line with the specification in the datasheet when using the radial shaft seal.

3) Internal stall torque constant

Datasheet

Technical data brake - EMMT-EC-40, EMMT-AS-40				
Flange size, motors [mm]	40			
Length	Short [S]		Medium [M]	
Winding	Safety extra-low voltage, standard [ES]	Low voltage, standard [LS]	Safety extra-low voltage, standard [ES]	Low voltage, standard [LS]
Operating voltage DC for brake	24 V			
Brake current consumption	0.34 A			
Power consumption, brake	8.2 W			
Brake holding torque	0.45 Nm			
Brake separation time	≤28 ms			
Brake closing time	41 ms			
DC brake response delay	≤8 ms			
Brake coil resistance	70.9 Ohm			
Brake coil inductivity	146 mH			
Mass moment of inertia of brake	0.0058 kgcm ²			
Max. friction per braking process	1,500 J			
Number of emergency stops per hour	1			
Total brake friction	1.5 kJ			

Datasheet

General technical data – EMMT-AS-60

Flange size, motors [mm]	60											
Length	Short [S]				Medium [M]				Long [L]			
Winding	High voltage, standard [HS]		Low voltage, standard [LS]		High voltage, standard [HS]		Low voltage, standard [LS]		High voltage, standard [HS]		Low voltage, standard [LS]	
Brake	None [L]	With brake [B]	None [L]	With brake [B]	None [L]	With brake [B]	None [L]	With brake [B]	None [L]	With brake [B]	None [L]	With brake [B]
Nominal operating voltage DC ¹⁾	680 V		325 V		680 V		325 V		680 V		325 V	
Nominal motor current	1.6 A	1.4 A	1.6 A	1.4 A	2.4 A	2.2 A	2.4 A	2.2 A	3.2 A	3 A	3.2 A	3 A
Continuous stall current	1.7 A	1.6 A	1.7 A	1.6 A	2.7 A	2.5 A	2.7 A	2.5 A	3.8 A	3.5 A	3.8 A	3.5 A
Nominal power rating of motor	200 W	190 W	200 W	190 W	350 W	310 W	350 W	310 W	440 W	410 W	440 W	410 W
Nominal torque ²⁾	0.64 Nm	0.6 Nm	0.64 Nm	0.6 Nm	1.1 Nm	1 Nm	1.1 Nm	1 Nm	1.4 Nm	1.3 Nm	1.4 Nm	1.3 Nm
Peak current	5.4 A				11 A				18.3 A			
Peak torque	1.6 Nm				3.4 Nm				5.6 Nm			
Standstill torque	0.7 Nm	0.66 Nm	0.7 Nm	0.66 Nm	1.24 Nm	1.15 Nm	1.24 Nm	1.15 Nm	1.66 Nm	1.56 Nm	1.66 Nm	1.56 Nm
Standstill torque constant ³⁾	0.49 Nm/A				0.53 Nm/A				0.52 Nm/A			
Nominal rotary speed	3,000 rpm											
Max. rotational speed	15,000 rpm		7,100 rpm		14,200 rpm		6,800 rpm		14,300 rpm		6,800 rpm	
Max. mechanical speed	16,000 rpm											
Max. brake no-load speed	–	10,000 rpm	–	10,000 rpm	–	10,000 rpm	–	10,000 rpm	–	10,000 rpm	–	10,000 rpm
Angular acceleration	100,000 rad/s ²											
Motor constant	0.41 Nm/A				0.45 Nm/A				0.44 Nm/A			
Voltage constant, phase-to-phase	29.9 mVmin				32 mVmin				31.2 mVmin			
Electric time constant	2.1 ms				2.7 ms				3 ms			
Thermal time constant	40 min	41 min	40 min	41 min	42 min	41 min	42 min	41 min	43 min	44 min	43 min	44 min
Thermal resistance	1.3 K/W	1.5 K/W	1.3 K/W	1.5 K/W	1.1 K/W	1.3 K/W	1.1 K/W	1.3 K/W	1 K/W	1.2 K/W	1 K/W	1.2 K/W
Number of pole pairs	5											
Phase-phase winding resistance	11.7 Ohm				4.85 Ohm				2.68 Ohm			
Phase-phase winding inductance	38 mH				20 mH				12 mH			
Winding longitudinal inductivity Ld (phase)	15.5 mH				8 mH				5 mH			
Winding cross inductivity Lq (phase)	19 mH				10 mH				6 mH			
Total mass moment of inertia of output	0.169 kg-cm ²	0.257 kg-cm ²	0.169 kg-cm ²	0.257 kg-cm ²	0.286 kg-cm ²	0.373 kg-cm ²	0.286 kg-cm ²	0.373 kg-cm ²	0.403 kg-cm ²	0.49 kg-cm ²	0.403 kg-cm ²	0.49 kg-cm ²
Permissible axial shaft load	70 N											
Permissible radial shaft load	350 N											

1) With 3-phase mains supply to the servo drive, a voltage of up to 3x 400 VAC +10% is permitted.

2) When using the radial shaft seal, a reduction (derating) of the nominal torque of 10% must be observed.

For motors with safety encoders, a derating must be taken into account in line with the specification in the datasheet when using the radial shaft seal.

3) Internal stall torque constant

Datasheet

Technical data brake - EMMT-AS-60						
Flange size, motors [mm]	60					
Length	Short [S]		Medium [M]		Long [L]	
Winding	High voltage, standard [HS]	Low voltage, standard [LS]	High voltage, standard [HS]	Low voltage, standard [LS]	High voltage, standard [HS]	Low voltage, standard [LS]
Operating voltage DC for brake	24 V					
Brake current consumption	0.46 A					
Power consumption, brake	11 W					
Brake holding torque	2.5 Nm					
Brake separation time	≤35 ms					
Brake closing time	10 ms					
DC brake response delay	≤2 ms					
Brake coil resistance	52.4 Ohm					
Brake coil inductivity	700 mH					
Mass moment of inertia of brake	0.074 kgcm ²					
Max. friction per braking process	5,600 J					
Number of emergency stops per hour	1					
Total brake friction	615 kJ					

Datasheet

General technical data – EMMT-AS-80

Flange size, motors [mm]	80													
Length	Short [S]				Medium [M]				Long [L]				Very long [H]	
Winding	High voltage, standard [HS]		Low voltage, standard [LS]		High voltage, standard [HS]		Low voltage, standard [LS]		High voltage, standard [HS]		Low voltage, standard [LS]		High voltage, standard [HS]	
Brake	None []	With brake [B]	None []	With brake [B]	None []	With brake [B]	None []	With brake [B]	None []	With brake [B]	None []	With brake [B]	None []	With brake [B]
Nominal operating voltage DC ¹⁾	680 V		325 V		680 V		325 V		680 V		325 V		565 V	
Nominal motor current	1.76 A		2.7 A		2.2 A		4.1 A		3.5 A		5.5 A		3.8 A	
Continuous stall current	2 A		3.1 A		2.6 A		4.9 A		4.3 A		6.7 A		4.8 A	
Nominal power rating of motor	408 W				690 W				910 W				1,070 W	
Nominal torque ²⁾	1.3 Nm		2.2 Nm		2.2 Nm		2.9 Nm		2.9 Nm		3.4 Nm		3.4 Nm	
Peak current	5.4 A		8.4 A		9 A		17.1 A		17.5 A		27.3 A		21.7 A	
Peak torque	2.8 Nm				6.4 Nm				9.9 Nm				13.5 Nm	
Standstill torque	1.46 Nm				2.6 Nm				3.5 Nm				4.3 Nm	
Standstill torque constant ³⁾	0.89 Nm/A		0.57 Nm/A		1.17 Nm/A		0.62 Nm/A		0.93 Nm/A		0.6 Nm/A		1 Nm/A	
Nominal rotary speed	3,000 rpm													
Max. rotational speed	8,950 rpm		6,700 rpm		6,800 rpm		6,150 rpm		8,540 rpm		6,400 rpm		6,500 rpm	
Max. mechanical speed	14,000 rpm													
Max. brake no-load speed	–	10,000 rpm	–	10,000 rpm	–	10,000 rpm	–	10,000 rpm	–	10,000 rpm	–	10,000 rpm	–	10,000 rpm
Angular acceleration	100,000 rad/s ²													
Motor constant	0.74 Nm/A		0.48 Nm/A		1 Nm/A		0.54 Nm/A		0.82 Nm/A		0.53 Nm/A		0.9 Nm/A	
Voltage constant, phase-to-phase	53.6 mV/min		34.3 mV/min		70.7 mV/min		37.3 mV/min		56 mV/min		36 mV/min		61.4 mV/min	
Electric time constant	4.8 ms		4.9 ms		6.4 ms		6.5 ms		7 ms		6.9 ms		7.2 ms	
Thermal time constant	42 min				45 min				48 min				51 min	
Thermal resistance	0.95 K/W				0.78 K/W				0.68 K/W				0.65 K/W	
Number of pole pairs	5													
Phase-phase winding resistance	12.4 Ohm		4.93 Ohm		7.43 Ohm		2.04 Ohm		2.69 Ohm		1.13 Ohm		2.21 Ohm	
Phase-phase winding inductance	39.8 mH		16.3 mH		31.8 mH		8.9 mH		12.6 mH		5.2 mH		10.7 mH	
Winding longitudinal inductivity L _d (phase)	25 mH		10.2 mH		19.4 mH		5.4 mH		7.5 mH		3.1 mH		6.6 mH	
Winding cross inductivity L _q (phase)	29.8 mH		12.2 mH		23.8 mH		6.6 mH		9.45 mH		3.9 mH		8 mH	
Total mass moment of inertia of output	0.597 kgcm ²	0.897 kgcm ²	0.597 kgcm ²	0.897 kgcm ²	1.035 kgcm ²	1.285 kgcm ²	1.035 kgcm ²	1.285 kgcm ²	1.473 kgcm ²	1.993 kgcm ²	1.473 kgcm ²	1.993 kgcm ²	1.91 kgcm ²	2.43 kgcm ²
Permissible axial shaft load	120 N													
Permissible radial shaft load	620 N													

1) With 3-phase mains supply to the servo drive, a voltage of up to 3x 400 VAC +10% is permitted.

2) When using the radial shaft seal, a reduction (derating) of the nominal torque of 10% must be observed.

For motors with safety encoders, a derating must be taken into account in line with the specification in the datasheet when using the radial shaft seal.

3) Internal stall torque constant

Datasheet

Technical data brake - EMMT-AS-80							
Flange size, motors [mm]	80						
Length	Short [S]		Medium [M]		Long [L]		Very long [H]
Winding	High voltage, standard [HS]	Low voltage, standard [LS]	High voltage, standard [HS]	Low voltage, standard [LS]	High voltage, standard [HS]	Low voltage, standard [LS]	High voltage, standard [HS]
Operating voltage DC for brake	24 V						
Brake current consumption	0.5 A				0.63 A		
Power consumption, brake	12 W				15 W		
Brake holding torque	4.5 Nm				7 Nm		
Brake separation time	≤55 ms				≤45 ms		
Brake closing time	≤15 ms				≤30 ms		
DC brake response delay	≤3 ms				≤4 ms		
Brake coil resistance	48 Ohm				38.4 Ohm		
Brake coil inductivity	1,000 mH				900 mH		
Mass moment of inertia of brake	0.249 kgcm ²				0.459 kgcm ²		
Max. friction per braking process	8,200 J				12,000 J		
Number of emergency stops per hour	1						
Total brake friction	580 kJ				2,400 kJ		

Datasheet

General technical data – EMMT-AS-100

Flange size, motors [mm]	100							
Length	Short [S]		Medium [M]		Long [L]		Very long [H]	
Winding	High voltage, standard [HS]							
Brake	None []	With brake [B]	None []	With brake [B]	None []	With brake [B]	None []	With brake [B]
Nominal operating voltage DC ¹⁾	680 V							
Nominal motor current	3.5 A		4.3 A		4.7 A		5.5 A	
Continuous stall current	4.4 A		5.9 A		7 A		9.5 A	
Nominal power rating of motor	1,450 W		1,770 W		2,030 W		2,060 W	
Nominal torque ²⁾	5.1 Nm		6.3 Nm		7.2 Nm		7.3 Nm	
Peak current	13.7 A		22.1 A		28.6 A		36 A	
Peak torque	13.7 Nm		22.4 Nm		30.5 Nm		38.7 Nm	
Standstill torque	6.3 Nm		8.6 Nm		10.8 Nm		12.4 Nm	
Standstill torque constant ³⁾	1.67 Nm/A		1.66 Nm/A		1.75 Nm/A		1.54 Nm/A	
Nominal rotary speed	2,700 rpm							
Max. rotational speed	4,770 rpm		4,790 rpm		4,530 rpm		5,150 rpm	
Max. mechanical speed	13,000 rpm							
Max. brake no-load speed	–	10,000 rpm	–	10,000 rpm	–	10,000 rpm	–	10,000 rpm
Angular acceleration	100,000 rad/s ²							
Motor constant	1.45 Nm/A		1.46 Nm/A		1.54 Nm/A		1.32 Nm/A	
Voltage constant, phase-to-phase	101 mV/min		100 mV/min		106 mV/min		93.2 mV/min	
Electric time constant	14.5 ms		16.6 ms		15.8 ms		16.7 ms	
Thermal time constant	74 min		73 min		71 min		68 min	
Thermal resistance	0.6 K/W		0.5 K/W		0.46 K/W		0.39 K/W	
Number of pole pairs	5							
Phase-phase winding resistance	3.35 Ohm		1.84 Ohm		1.49 Ohm		0.81 Ohm	
Phase-phase winding inductance	32.4 mH		20.4 mH		15.7 mH		9 mH	
Winding longitudinal inductivity Ld (phase)	17.8 mH		10.2 mH		8.7 mH		5.7 mH	
Winding cross inductivity Lq (phase)	24.3 mH		15.3 mH		11.8 mH		6.8 mH	
Total mass moment of inertia of output	3.15 kgcm ²	4.04 kgcm ²	4.46 kgcm ²	5.34 kgcm ²	5.77 kgcm ²	8.06 kgcm ²	8.8 kgcm ²	11.09 kgcm ²
Permissible axial shaft load	200 N							
Permissible radial shaft load	1,110 N						815 N	915 N

1) With 3-phase mains supply to the servo drive, a voltage of up to 3x 400 VAC +10% is permitted.

2) When using the radial shaft seal, a reduction (derating) of the nominal torque of 10% must be observed.

For motors with safety encoders, a derating must be taken into account in line with the specification in the datasheet when using the radial shaft seal.

3) Internal stall torque constant

Datasheet

Technical data brake – EMMT-AS-100				
Flange size, motors [mm]	100			
Length	Short [S]	Medium [M]	Long [L]	Very long [H]
Winding	High voltage, standard [HS]			
Operating voltage DC for brake	24 V			
Brake current consumption	0.75 A		1 A	
Power consumption, brake	18 W		24 W	
Brake holding torque	11 Nm		18 Nm	
Brake separation time	≤80 ms			
Brake closing time	≤20 ms		≤40 ms	
DC brake response delay	≤4 ms		≤5 ms	
Brake coil resistance	32 Ohm		24 Ohm	
Brake coil inductivity	900 mH			
Mass moment of inertia of brake	0.74 kgcm ²		2.15 kgcm ²	
Max. friction per braking process	12,000 J		15,000 J	
Number of emergency stops per hour	1			
Total brake friction	1,335 kJ		3,600 kJ	

General technical data – EMMT-AS-150								
Flange size, motors [mm]	150							
Length	Medium [M]				Long [L]			
Winding	High voltage, standard [HS]		High voltage, speed optimised [HV]		High voltage, standard [HS]		High voltage, torque optimised [HT]	
Brake	None [L]	With brake [B]	None [L]	With brake [B]	None [L]	With brake [B]	None [L]	With brake [B]
Nominal operating voltage DC ¹⁾	680 V							
Nominal motor current	9.5 A		10.2 A		15.4 A		10.3 A	
Continuous stall current	11.4 A		24 A		23.6 A		11.4 A	
Nominal power rating of motor	4,257 W		4,948 W		6,377 W		4,157 W	
Nominal torque ²⁾	27.1 Nm		13.5 Nm		29 Nm		39.7 Nm	
Peak current	24 A		50 A		49.5 A		24 A	
Peak torque	64 Nm		60 Nm		87 Nm		86 Nm	
Standstill torque	33 Nm				45.5 Nm		44 Nm	
Standstill torque constant ³⁾	3.3 Nm/A		1.54 Nm/A		2.23 Nm/A		4.38 Nm/A	
Nominal rotary speed	1,500 rpm		3,500 rpm		2,100 rpm		1,000 rpm	
Max. rotational speed	2,368 rpm		5,051 rpm		3,495 rpm		1,812 rpm	
Max. mechanical speed	10,000 rpm				8,000 rpm			
Max. brake no-load speed	–	10,000 rpm	–	10,000 rpm	–	8,000 rpm	–	8,000 rpm
Angular acceleration	100,000 rad/s ²							
Motor constant	2.85 Nm/A		1.32 Nm/A		1.88 Nm/A		3.85 Nm/A	
Voltage constant, phase-to-phase	199.4 mV/min		92.9 mV/min		135.1 mV/min		264.9 mV/min	
Electric time constant	15.4 ms		15.6 ms		17.1 ms		15.6 ms	
Thermal time constant	45 min				55 min			
Thermal resistance	0.45 K/W		0.46 K/W		0.39 K/W		0.42 K/W	
Number of pole pairs	5							
Phase-phase winding resistance	0.935 Ohm		0.211 Ohm		0.25 Ohm		1.016 Ohm	
Phase-phase winding inductance	14.6 mH		3.3 mH		4.4 mH		15.7 mH	
Winding longitudinal inductivity L _d (phase)	7.2 mH		1.65 mH		2.15 mH		7.95 mH	
Winding cross inductivity L _q (phase)	7.3 mH		1.65 mH		2.2 mH		7.85 mH	
Total mass moment of inertia of output	38.7 kgcm ²	46.9 kgcm ²	38.7 kgcm ²	46.9 kgcm ²	57.6 kgcm ²	70.1 kgcm ²	57.6 kgcm ²	70.1 kgcm ²
Permissible axial shaft load	294 N		217 N		274 N		346 N	
Permissible radial shaft load	1,470 N		1,085 N		1,370 N		1,730 N	

1) With 3-phase mains supply to the servo drive, a voltage of up to 3x 480 VAC +10% is permitted.

2) When using the radial shaft seal, a reduction (derating) of the nominal torque of 10% must be observed.

3) Internal stall torque constant

Datasheet

Technical data brake - EMMT-AS-150

Flange size, motors [mm]	150			
Length	Medium [M]		Long [L]	
Winding	High voltage, standard [HS]	High voltage, speed optimised [HV]	High voltage, standard [HS]	High voltage, torque optimised [HT]
Operating voltage DC for brake	24 V			
Brake current consumption	1.08 A			
Power consumption, brake	26 W			
Brake holding torque	45 Nm		65 Nm	
Brake separation time	230 ms		200 ms	
Brake closing time	45 ms		40 ms	
DC brake response delay	6 ms		10 ms	
Mass moment of inertia of brake	8.2 kgcm ²		12.5 kgcm ²	
Max. friction per braking process	28,000 J		40,000 J	
Number of emergency stops per hour	1			
Total brake friction	2,600 kJ		4,500 kJ	

General technical data – EMMT-AS-190

Flange size, motors [mm]	190			
Length	Medium [M]		Long [L]	
Winding	High voltage, standard [HS]		High voltage, torque optimised [HT]	
Brake	None []	With brake [B]	None []	With brake [B]
Nominal operating voltage DC ¹⁾	680 V			
Nominal motor current	19.2 A		20 A	
Continuous stall current	25 A		22.8 A	
Nominal power rating of motor	7,427 W		8,629 W	
Nominal torque ²⁾	59.1 Nm		82.4 Nm	
Peak current	41.5 A		49.7 A	
Peak torque	118.3 Nm		183.3 Nm	
Standstill torque	76.7 Nm		93.7 Nm	
Standstill torque constant ³⁾	3.56 Nm/A		4.79 Nm/A	
Nominal rotary speed	1,200 rpm		1,000 rpm	
Max. rotational speed	2,163 rpm		1,654 rpm	
Max. mechanical speed	8,000 rpm			
Max. brake no-load speed	–	8,000 rpm	–	8,000 rpm
Angular acceleration	100,000 rad/s ²			
Motor constant	3.08 Nm/A		4.12 Nm/A	
Voltage constant, phase-to-phase	215.2 mVmin		289.7 mVmin	
Electric time constant	39.6 ms		38.8 ms	
Thermal time constant	70 min		80 min	
Thermal resistance	0.31 K/W		0.3 K/W	
Number of pole pairs	5			
Phase-phase winding resistance	0.285 Ohm		0.358 Ohm	
Phase-phase winding inductance	12.3 mH		13.8 mH	
Winding longitudinal inductivity Ld (phase)	5.65 mH		6.95 mH	
Winding cross inductivity Lq (phase)	6.15 mH		6.9 mH	
Total mass moment of inertia of output	110 kgcm ²	160 kgcm ²	145 kgcm ²	195 kgcm ²
Permissible axial shaft load	500 N		520 N	
Permissible radial shaft load	2,530 N		2,620 N	

1) With 3-phase mains supply to the servo drive, a voltage of up to 3x 480 VAC +10% is permitted.

2) When using the radial shaft seal, a reduction (derating) of the nominal torque of 10% must be taken into account.

3) Internal stall torque constant

Datasheet

Technical data brake - EMMT-AS-190		
Flange size, motors [mm]	190	
Length	Medium [M]	Long [L]
Winding	High voltage, standard [HS]	High voltage, torque optimised [HT]
Operating voltage DC for brake	24 V	
Brake current consumption	2.08 A	
Power consumption, brake	50 W	
Brake holding torque	115 Nm	
Brake separation time	190 ms	
Brake closing time	65 ms	
DC brake response delay	12 ms	
Mass moment of inertia of brake	50 kgcm ²	
Max. friction per braking process	62,000 J	
Number of emergency stops per hour	1	
Total brake friction	13,000 kJ	

Datasheet

Operating and environmental conditions – EMMT-EC-40/EMMT-AS-40

Flange size, motors [mm]	40		
Motor type	AC synchronous [AS]	EC motor [EC]	
Length	Short [S]	Medium [M]	Short [S] Medium [M]
Conforms to standard	IEC 60034		
Motor type to EN 60034-7	IM B5, IM V1, IM V3		
Degree of protection	IP40		
Note on degree of protection	IP40 for motor shaft without rotary shaft seal IP65 for motor shaft with rotary shaft seal IP67 for motor housing including connection components		IP40 for motor shaft without rotary shaft seal IP65 for motor housing, incl. connection technology IP65 for motor shaft with rotary shaft seal
Ambient temperature	-40 ... 40°C		
Note on ambient temperature ¹⁾	Up to 80°C with derating -2%/°C	Up to 80°C with derating of -2.25% per degree Celsius	Up to 80°C with derating of -1.5% per degree Celsius
Storage temperature	-40 ... 70°C		
Max. winding temperature	155°C		
Temperature monitoring	Digital motor temperature transmission via EnDat [®] 2.2		Dig. motor temp. via BiSS-C
Rating class as per EN 60034-1	S1		
Temperature class as per EN 60034-1	F		
Relative air humidity	0 - 90%		
Concentricity, coaxiality, axial runout to DIN SPEC 42955	N		
Balance quality	G 2.5		
Pollution degree	2		
Max. installation height	4,000 m		
Note on max. installation height	As of 1,000 m: only with derating of -1.0% per 100 m		
Bearing lifetime under nominal conditions	20,000 h		
Switching cycles holding brake	10 million idle actuations (without friction work!)		
CE mark (see declaration of conformity) ²⁾	To EU EMC Directive To EU Low Voltage Directive In accordance with EU RoHS Directive		To EU EMC Directive In accordance with EU RoHS Directive
UKCA marking (see declaration of conformity) ³⁾	To UK instructions for EMC To UK RoHS instructions To UK regulations for electrical equipment		
Approval	RCM trademark c UL us - Recognized (OL)		
Certificate issuing authority	UL E342973		
Vibration resistance	Transport application test with severity level 2 to FN 942017-4 and EN 60068-2-6		
Shock resistance	Shock test with severity level 2 to FN 942017-5 and EN 60068-2-27		
LABS (PWIS) conformity	VDMA24364 zone III		
Note on materials	RoHS-compliant		

1) Without friction work

2) More information www.festo.com/catalogue/emmt → Downloads.

3) More information www.festo.com/catalogue/emmt → Downloads.

Datasheet

Operating and environmental conditions – EMMT-AS-60, 80							
Flange size, motors [mm]	60			80			
Length	Short [S]	Medium [M]	Long [L]	Short [S]	Medium [M]	Long [L]	Very long [H]
Conforms to standard	IEC 60034						
Motor type to EN 60034-7	IM B5, IM V1, IM V3						
Degree of protection	IP40						
Note on degree of protection	IP40 for motor shaft without rotary shaft seal IP65 for motor shaft with rotary shaft seal IP67 for motor housing including connection components						
Ambient temperature	-40 ... 40°C						
Note on ambient temperature ¹⁾	Up to 80°C with derating of -1.5% per degree Celsius						
Storage temperature	-40 ... 70°C						
Max. winding temperature	155°C						
Temperature monitoring	Digital motor temperature transmission via EnDat [®] 2.2						
Rating class as per EN 60034-1	S1						
Temperature class as per EN 60034-1	F						
Relative air humidity	0 - 90%						
Concentricity, coaxiality, axial runout to DIN SPEC 42955	N						
Balance quality	G 2.5						
Pollution degree	2						
Max. installation height	4,000 m						
Note on max. installation height	As of 1,000 m: only with derating of -1.0% per 100 m						
Bearing lifetime under nominal conditions	20,000 h						
Switching cycles holding brake	10 million idle actuations (without friction work!)						
CE mark (see declaration of conformity) ²⁾	To EU EMC Directive To EU Low Voltage Directive In accordance with EU RoHS Directive						
UKCA marking (see declaration of conformity) ³⁾	To UK instructions for EMC To UK RoHS instructions To UK regulations for electrical equipment						
Approval	RCM trademark c UL us - Recognized (OL)						
Certificate issuing authority	UL E342973						
Energy efficiency	-				ENEFF (CN) / Class 2		
Vibration resistance	Transport application test with severity level 2 to FN 942017-4 and EN 60068-2-6						
Shock resistance	Shock test with severity level 2 to FN 942017-5 and EN 60068-2-27						
LABS (PWIS) conformity	VDMA24364 zone III						
Note on materials	RoHS-compliant						

1) Without friction work

2) More information www.festo.com/catalogue/emmt → Downloads.3) More information www.festo.com/catalogue/emmt → Downloads.

Datasheet

Operating and environmental conditions – EMMT-AS-100								
Flange size, motors [mm]	100							
Length	Short [S]		Medium [M]		Long [L]		Very long [H]	
Brake	None []	With brake [B]	None []	With brake [B]	None []	With brake [B]	None []	With brake [B]
Conforms to standard	IEC 60034							
Motor type to EN 60034-7	IM B5, IM V1, IM V3							
Degree of protection	IP40							
Note on degree of protection	IP40 for motor shaft without rotary shaft seal IP65 for motor shaft with rotary shaft seal IP67 for motor housing including connection components							
Ambient temperature	-40 ... 40°C							
Note on ambient temperature ¹⁾	Up to 80°C with derating of -1.5% per degree Celsius				Up to 80°C with derating of -1.75% per degree Celsius	Up to 80°C with derating of -2.25% per degree Celsius	Up to 80°C with derating of -1.75% per degree Celsius	Up to 80°C with derating of -2.25% per degree Celsius
Storage temperature	-40 ... 70°C							
Max. winding temperature	155°C							
Temperature monitoring	Digital motor temperature transmission via EnDat [®] 2.2							
Rating class as per EN 60034-1	S1							
Temperature class as per EN 60034-1	F							
Relative air humidity	0 - 90%							
Concentricity, coaxiality, axial runout to DIN SPEC 42955	N							
Balance quality	G 2.5							
Pollution degree	2							
Max. installation height	4,000 m							
Note on max. installation height	As of 1,000 m: only with derating of -1.0% per 100 m							
Bearing lifetime under nominal conditions	20,000 h							
Switching cycles holding brake	–	10 million idle actuations (without friction work!)	–	10 million idle actuations (without friction work!)	–	10 million idle actuations (without friction work!)	–	10 million idle actuations (without friction work!)
CE mark (see declaration of conformity) ²⁾	To EU EMC Directive To EU Low Voltage Directive In accordance with EU RoHS Directive							
UKCA marking (see declaration of conformity) ³⁾	To UK instructions for EMC To UK RoHS instructions To UK regulations for electrical equipment							
Approval	RCM trademark c UL us - Recognized (OL)							
Certificate issuing authority ⁴⁾	UL E342973							
Energy efficiency	ENEFF (CN) / Class 2							
Vibration resistance	Transport application test with severity level 2 to FN 942017-4 and EN 60068-2-6							
Shock resistance	Shock test with severity level 2 to FN 942017-5 and EN 60068-2-27							
LABS (PWIS) conformity	VDMA24364 zone III							
Note on materials	RoHS-compliant							

1) Without friction work

2) More information www.festo.com/catalogue/emmt → Downloads.

3) More information www.festo.com/catalogue/emmt → Downloads.

4) German Technical Control Board (TÜV) 968/FSP 2317.00/21: only applies to variants with multi-turn absolute safety encoder.

Datasheet

Operating and environmental conditions – EMMT-AS-150, 190										
Flange size, motors [mm]	150				190					
Length	Medium [M]			Long [L]		Medium [M]			Long [L]	
Brake	None []	With brake [B]	None []	With brake [B]	None []	With brake [B]	None []	With brake [B]	None []	With brake [B]
Conforms to standard	IEC 60034									
Motor type to EN 60034-7	IM B5, IM V1, IM V3									
Degree of protection	IP21									
Note on degree of protection	IP21 for motor shaft without rotary shaft seal IP65 for motor shaft with rotary shaft seal IP67 for motor housing including connection components									
Ambient temperature	-15 ... 40°C									
Note on ambient temperature ¹⁾	Up to 80°C with derating of -1.5% per degree Celsius									
Storage temperature	-20 ... 70°C									
Max. winding temperature	155°C									
Temperature monitoring	Digital motor temperature transmission via EnDat [®] 2.2									
Rating class as per EN 60034-1	S1									
Temperature class as per EN 60034-1	F									
Relative air humidity	0 - 90%									
Concentricity, coaxiality, axial runout to DIN SPEC 42955	N									
Balance quality	G 2.5									
Pollution degree	2									
Max. installation height	4,000 m									
Note on max. installation height	As of 1,000 m: only with derating of -1.0% per 100 m									
Bearing lifetime under nominal conditions	20,000 h									
Switching cycles holding brake	–	5 million idle actuations (without friction work!)	–	5 million idle actuations (without friction work!)	–	5 million idle actuations (without friction work!)	–	5 million idle actuations (without friction work!)	–	5 million idle actuations (without friction work!)
CE mark (see declaration of conformity) ²⁾	To EU EMC Directive To EU Low Voltage Directive In accordance with EU RoHS Directive									
UKCA marking (see declaration of conformity) ³⁾	To UK instructions for EMC To UK RoHS instructions To UK regulations for electrical equipment									
Approval	RCM trademark c UL us - Recognized (OL)									
Certificate issuing authority ⁴⁾	TÜV 968/FSP 2317.01/25, UL E342973									
Energy efficiency	ENEFF (CN) / Class 1									
Vibration resistance	As per EN 60068-2-6									
Shock resistance	As per EN 60068-2-29, 15 g/11 ms to EN 60068-2-27									
LABS (PWIS) conformity	VDMA24364 zone III									
Note on materials	RoHS-compliant									

1) Without friction work

2) More information www.festo.com/catalogue/emmt → Downloads.

3) More information www.festo.com/catalogue/emmt → Downloads.

4) German Technical Control Board (TÜV) 968/FSP 2317.00/21: only applies to variants with multi-turn absolute safety encoder.

Weight - EMMT-EC-40, EMMT-AS-40, EMMT-AS-60										
Flange size, motors [mm]	40				60					
Length	Short [S]		Medium [M]		Short [S]		Medium [M]		Long [L]	
Brake	None []	With brake [B]	None []	With brake [B]	None []	With brake [B]	None []	With brake [B]	None []	With brake [B]
Product weight	500 g	600 g	700 g	800 g	1,180 g	1,500 g	1,530 g	1,850 g	1,910 g	2,230 g

Datasheet

Weight - EMMT-AS-80

Flange size, motors [mm]	80							
Length	Short [S]		Medium [M]		Long [L]		Very long [H]	
Brake	None []	With brake [B]	None []	With brake [B]	None []	With brake [B]	None []	With brake [B]
Product weight	2,020 g	2,720 g	2,640 g	3,360 g	3,290 g	4,120 g	3,910 g	4,750 g

Weight - EMMT-AS-100

Flange size, motors [mm]	100							
Length	Short [S]		Medium [M]		Long [L]		Very long [H]	
Brake	None []	With brake [B]	None []	With brake [B]	None []	With brake [B]	None []	With brake [B]
Product weight	5,500 g	6,700 g	7,100 g	8,200 g	8,700 g	10,100 g	11,900 g	13,300 g

Weight - EMMT-AS-150, 190

Flange size, motors [mm]	150				190			
Length	Medium [M]		Long [L]		Medium [M]		Long [L]	
Brake	None []	With brake [B]	None []	With brake [B]	None []	With brake [B]	None []	With brake [B]
Product weight	18,700 g	22,200 g	25,400 g	29,700 g	42,200 g	50,600 g	53,000 g	61,500 g

Technical data – Encoder single turn

Flange size, motors [mm]	40		60	80	100	150	190
Winding	Safety extra-low voltage, standard [ES]	Low voltage, standard [LS]			High voltage, standard [HS]	High voltage, speed optimised [HV]	High voltage, torque optimised [HT]
Rotor position sensor	Absolute single-turn encoder						
rotor position sensor, DC operating voltage	5 V						
rotor position sensor, DC operating voltage range	4.5 ... 5.5 V	3.6 ... 14 V					
Rotor position encoder interface	BiSS-C	EnDat® 22					
rotor position sensor, position values per revolution	65,536	524,288	262,144		524,288		
Rotor position sensor, encoder measuring principle	Magnetic	Inductive					
Rotor position transducer resolution	16 bit	19 bit	18 bit		19 bit		
rotor position sensor, absolute detectable revolutions	1						
rotor position sensor, system accuracy of angle measurement	-1,800 ... 1,800 arcsec	-120 ... 120 arcsec			-65 ... 65 arcsec		

Datasheet

Technical data – Encoder, multi-turn							
Flange size, motors [mm]	40		60	80	100	150	190
Winding	Safety extra-low voltage, standard [ES]	Low voltage, standard [LS]	High voltage, standard [HS]	Low voltage, standard [LS]	High voltage, standard [HS]	High voltage, speed optimised [HV]	High voltage, torque optimised [HT]
Rotor position sensor	Absolute multi-turn encoder						
rotor position sensor, DC operating voltage	5 V						
rotor position sensor, DC operating voltage range	4.5 ... 5.5 V	3.6 ... 14 V					
Rotor position encoder interface	BiSS-C	EnDat® 22					
rotor position sensor, position values per revolution	131,072	524,288					
Rotor position sensor, encoder measuring principle	Magnetic	Inductive					
Rotor position transducer resolution	17 bit	19 bit					
rotor position sensor, absolute detectable revolutions	4,096						
rotor position sensor, system accuracy of angle measurement	-320 ... 320 arcsec	-120 ... 120 arcsec			-65 ... 65 arcsec		

Technical data – Encoder, safety, multi-turn							
Flange size, motors [mm]	60		80	100	150	190	
Winding	High voltage, standard [HS]	Low voltage, standard [LS]	High voltage, standard [HS]	Low voltage, standard [LS]	High voltage, standard [HS]		High voltage, torque optimised [HT]
Rotor position sensor	Absolute multi-turn safety encoder						
rotor position sensor, DC operating voltage	5 V						
rotor position sensor, DC operating voltage range	3.6 ... 14 V						
Rotor position encoder interface	EnDat® 22						
rotor position sensor, position values per revolution	524,288						
Rotor position sensor, encoder measuring principle	Inductive						
Rotor position transducer resolution	19 bit						
rotor position sensor, absolute detectable revolutions	4,096						
rotor position sensor, system accuracy of angle measurement	-120 ... 120 arcsec				-65 ... 65 arcsec		

Safety-related characteristic values – Safety encoder					
Flange size, motors [mm]	60	80	100	150	190
Maximum SIL	Safety integrity level 3, See user documentation				
Maximum PL and category	Performance Level e, category 3, See user documentation				
Safety sub-functions up to SIL2	Reliable recording and transmission of single-turn position data				
Safety sub-functions up to SIL3	Reliable recording and transmission of single-turn position data, only with additional software function in the servo drive				
Safety sub-function up to PL d, Cat. 3	Reliable recording and transmission of single-turn position data				
Safety sub-function up to PL e, Cat. 3	Reliable recording and transmission of single-turn position data, only with additional software function in the servo drive				
PFFd, subcomponent	15 x 10E-9, encoder				
Duration of use Tm, subcomponent	20 years, rotor position sensor				

Datasheet

Torque M as a function of rotational speed n for EMMT-EC-40, short, safety extra-low voltage, with/without brake

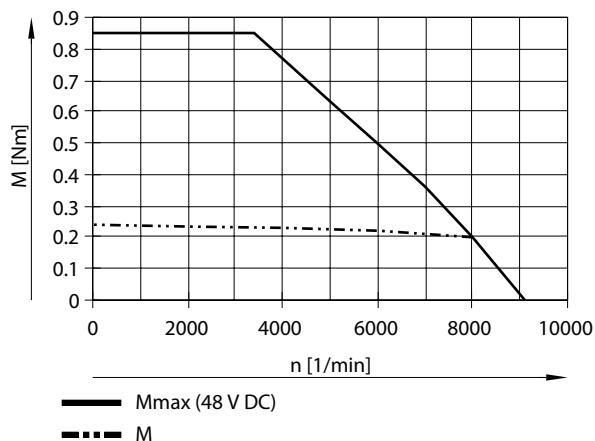

Typical motor characteristic curve with nominal voltage and optimal motor controller.
 Observe the maximum permissible rotational speeds of add-ons and installation components (such as brake, encoder, etc.).
 Mmax = peak torque
 M = nominal torque

Torque M as a function of rotational speed n for EMMT-EC-40, medium, safety extra-low voltage, with/without brake

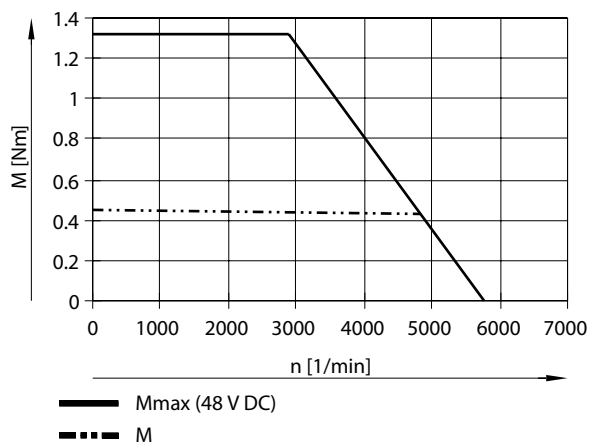

Typical motor characteristic curve with nominal voltage and optimal motor controller.
 Observe the maximum permissible rotational speeds of add-on and installation components (such as brake, encoder, etc.).
 Mmax = peak torque
 M = nominal torque

Torque M as a function of rotational speed n for EMMT-AS-40, short, low voltage, with/without brake

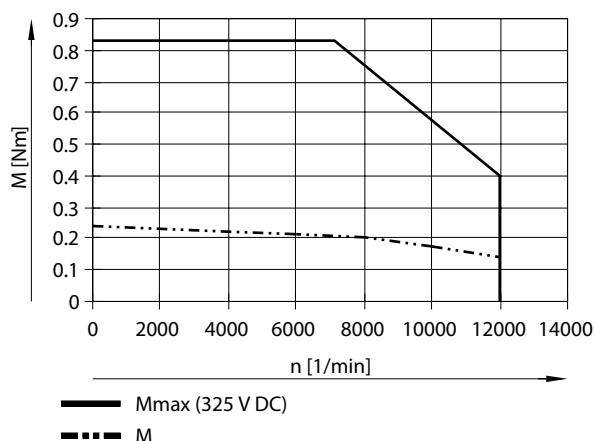

Typical motor characteristic curve with nominal voltage and optimal motor controller.
 Observe the maximum permissible rotational speeds of add-on and installation components (such as brake, encoder, etc.).
 Mmax = peak torque
 M = nominal torque

Datasheet

Torque M as a function of rotational speed n for EMMT-AS-40, medium, low voltage, with/without brake

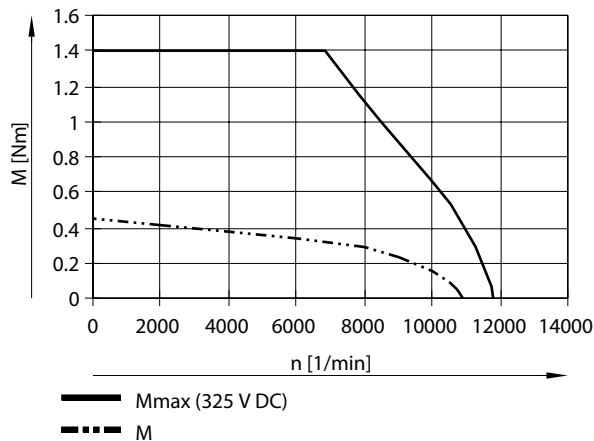

Typical motor characteristic curve with nominal voltage and optimal motor controller.

Observe the maximum permissible rotational speeds of add-ons and installation components (such as brake, encoder, etc.).

Mmax = peak torque

M = nominal torque

Torque M as a function of rotational speed n for EMMT-AS-60, short, low voltage, without brake

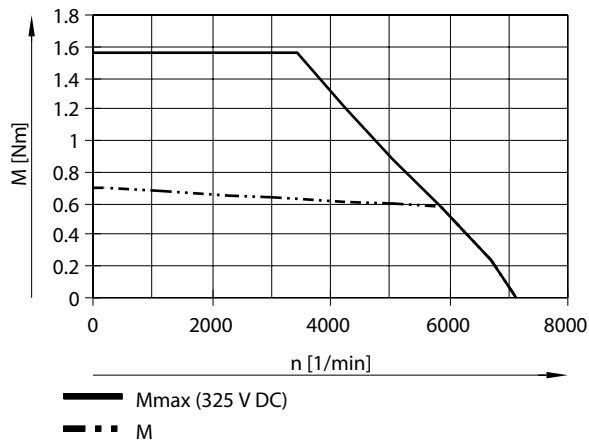

Typical motor characteristic curve at nominal voltage and optimal motor controller. Note the max. permissible rotational speeds of mounting and installation components (such as brake, encoder, etc.).

Mmax = peak torque

M = nominal torque

Torque M as a function of rotational speed n for EMMT-AS-60, short, low voltage, with brake

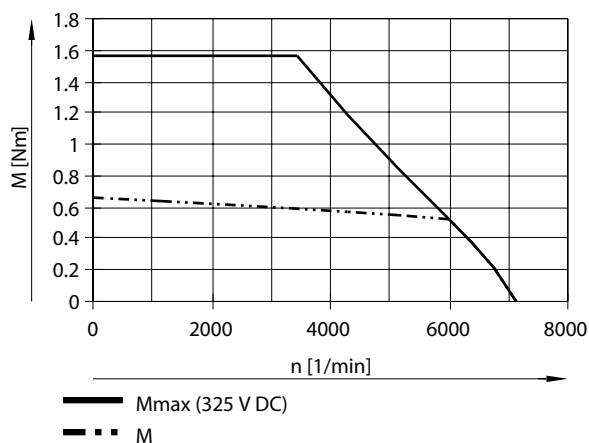

Typical motor characteristic curve at nominal voltage and optimal motor controller. Note the max. permissible rotational speeds of mounting and installation components (such as brake, encoder, etc.).

Mmax = peak torque

M = nominal torque

Datasheet

Torque M as a function of rotational speed n for EMMT-AS-60, short, high voltage, without brake

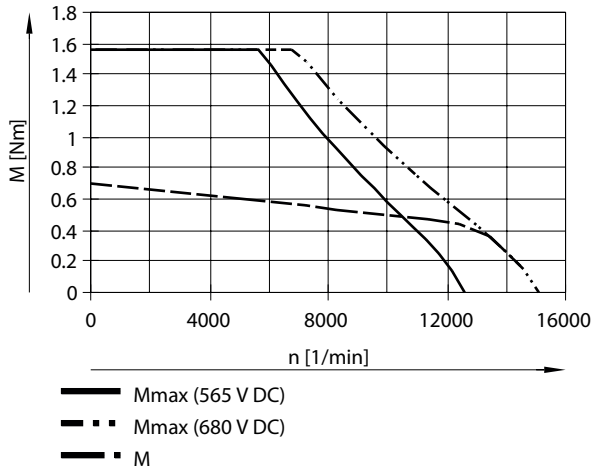

Typical motor characteristic curve at nominal voltage and optimal motor controller. Note the max. permissible rotational speeds of mounting and installation components (such as brake, encoder, etc.).

Mmax = peak torque

M = nominal torque

Torque M as a function of rotational speed n for EMMT-AS-60, short, high voltage, with brake

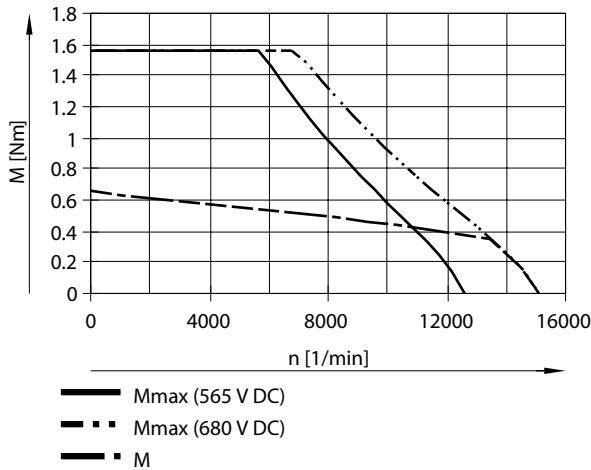

Typical motor characteristic curve at nominal voltage and optimal motor controller. Note the max. permissible rotational speeds of mounting and installation components (such as brake, encoder, etc.).

Mmax = peak torque

M = nominal torque

Torque M as a function of rotational speed n for EMMT-AS-60, medium, low voltage, without brake

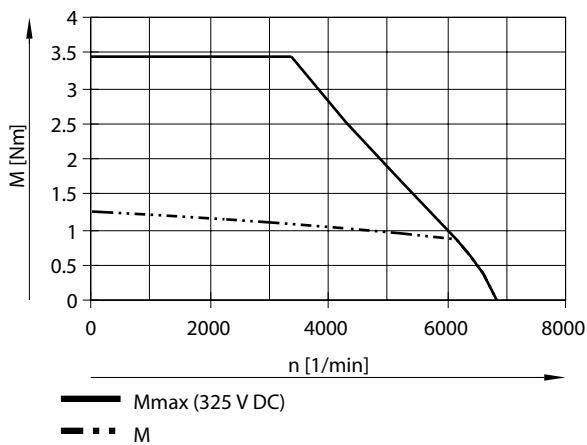

Typical motor characteristic curve at nominal voltage and optimal motor controller. Note the max. permissible rotational speeds of mounting and installation components (such as brake, encoder, etc.).

Mmax = peak torque

M = nominal torque

Datasheet

Torque M as a function of rotational speed n for EMMT-AS-60, medium, low voltage, with brake

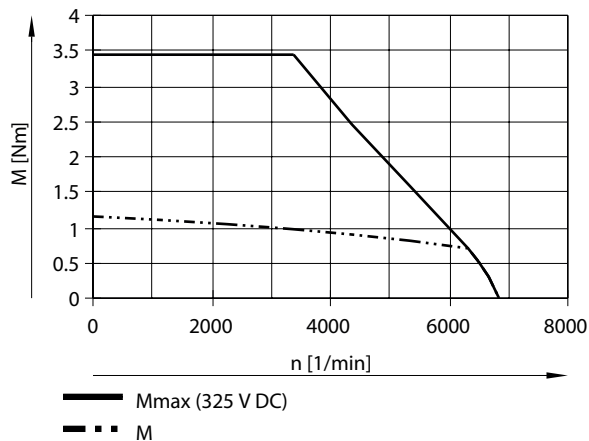

Typical motor characteristic curve at nominal voltage and optimal motor controller. Note the max. permissible rotational speeds of mounting and installation components (such as brake, encoder, etc.).

Mmax = peak torque

M = nominal torque

Torque M as a function of rotational speed n for EMMT-AS-60, medium, high voltage, without brake

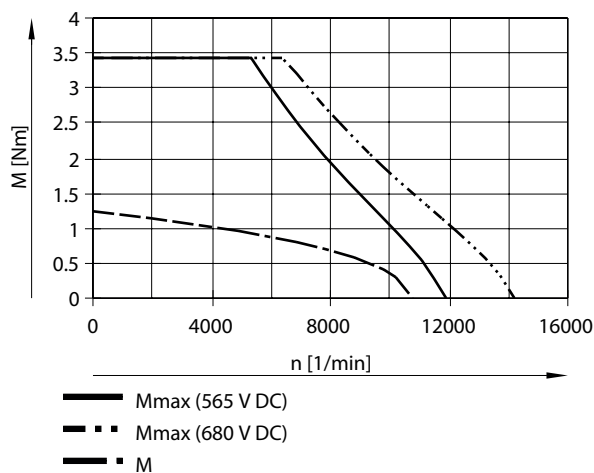

Typical motor characteristic curve at nominal voltage and optimal motor controller. Note the max. permissible rotational speeds of mounting and installation components (such as brake, encoder, etc.).

Mmax = peak torque

M = nominal torque

Torque M as a function of rotational speed n for EMMT-AS-60, medium, high voltage, with brake

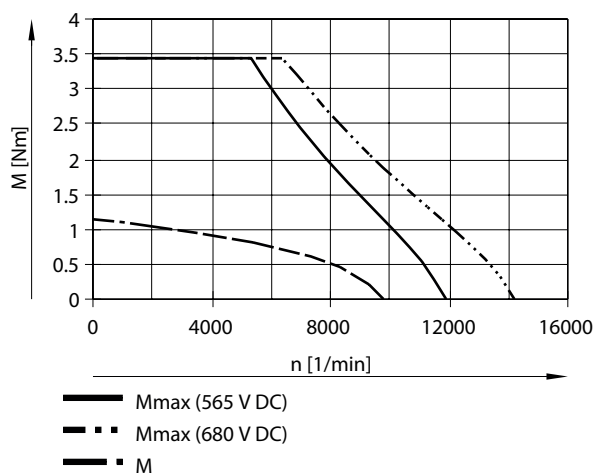

Typical motor characteristic curve at nominal voltage and optimal motor controller. Note the max. permissible rotational speeds of mounting and installation components (such as brake, encoder, etc.).

Mmax = peak torque

M = nominal torque

Datasheet

Torque M as a function of rotational speed n for EMMT-AS-60, long, low voltage, without brake

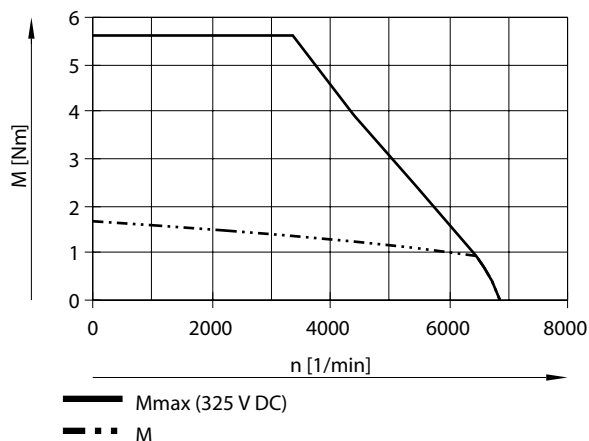

Typical motor characteristic curve at nominal voltage and optimal motor controller. Note the max. permissible rotational speeds of mounting and installation components (such as brake, encoder, etc.).

Mmax = peak torque

M = nominal torque

Torque M as a function of rotational speed n for EMMT-AS-60, long, low voltage, with brake

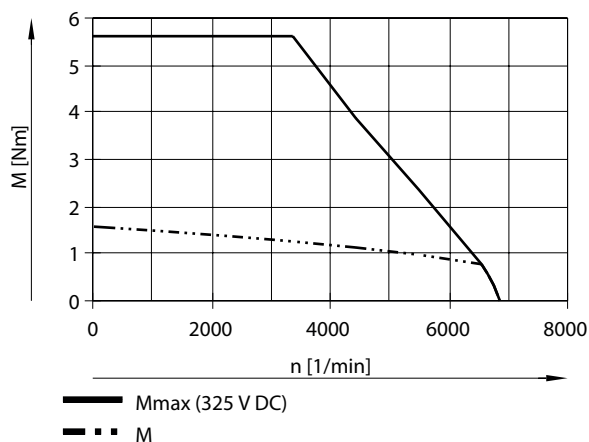

Typical motor characteristic curve at nominal voltage and optimal motor controller. Note the max. permissible rotational speeds of mounting and installation components (such as brake, encoder, etc.).

Mmax = peak torque

M = nominal torque

Torque M as a function of rotational speed n for EMMT-AS-60, long, high voltage, without brake

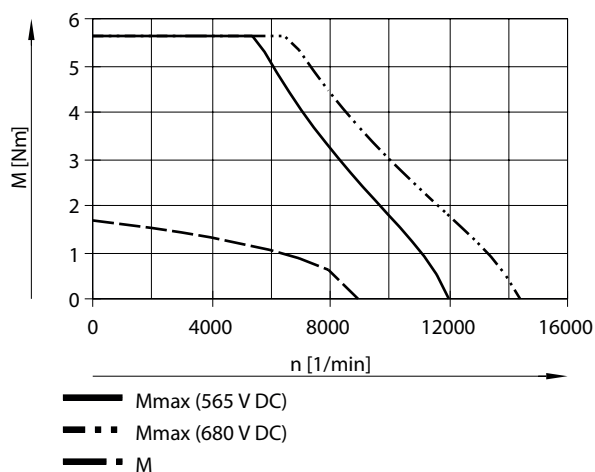

Typical motor characteristic curve at nominal voltage and optimal motor controller. Note the max. permissible rotational speeds of mounting and installation components (such as brake, encoder, etc.).

Mmax = peak torque

M = nominal torque

Datasheet

Torque M as a function of rotational speed n for EMMT-AS-60, long, high voltage, with brake

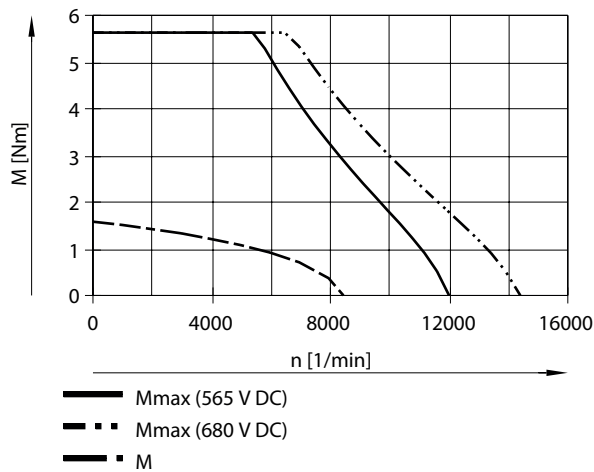

Typical motor characteristic curve at nominal voltage and optimal motor controller. Note the max. permissible rotational speeds of mounting and installation components (such as brake, encoder, etc.).

Mmax = peak torque

M = nominal torque

Torque M as a function of rotational speed n for EMMT-AS-80, short, low voltage, without/with brake

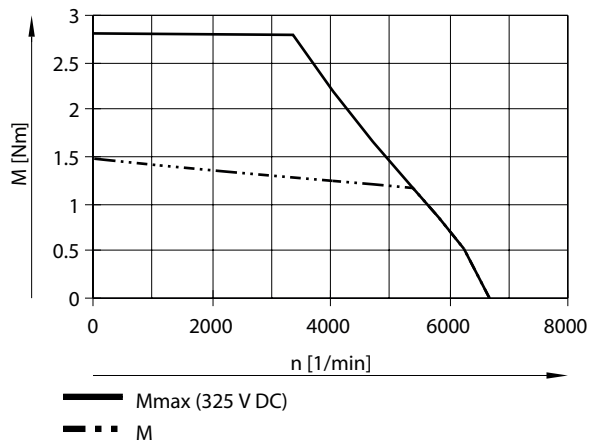

Typical motor characteristic curve at nominal voltage and optimal motor controller. Note the max. permissible rotational speeds of mounting and installation components (such as brake, encoder, etc.).

Mmax = peak torque

M = nominal torque

Torque M as a function of rotational speed n for EMMT-AS-80-S-HS, short, high voltage, without/with brake

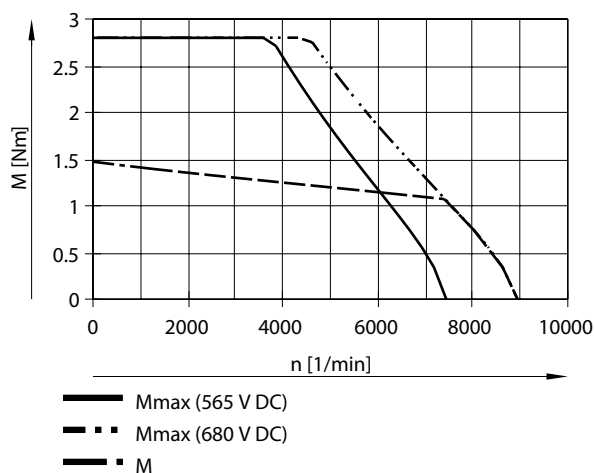

Typical motor characteristic curve at nominal voltage and optimal motor controller. Note the max. permissible rotational speeds of mounting and installation components (such as brake, encoder, etc.).

Mmax = peak torque

M = nominal torque

Datasheet

Torque M as a function of rotational speed n for EMMT-AS-80, medium, low voltage, without/with brake

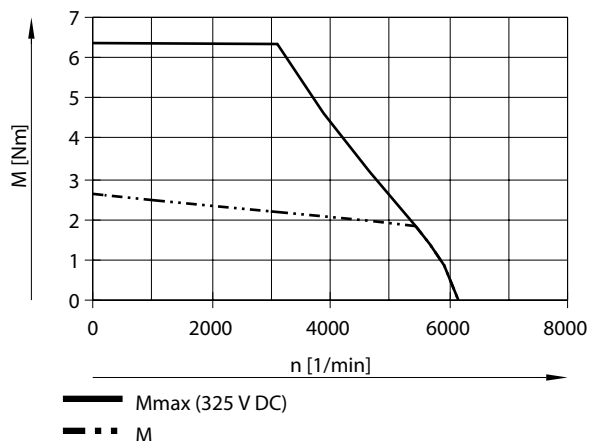

Typical motor characteristic curve at nominal voltage and optimal motor controller. Note the max. permissible rotational speeds of mounting and installation components (such as brake, encoder, etc.).

Mmax = peak torque

M = nominal torque

Torque M as a function of rotational speed n for EMMT-AS-80, medium, high voltage, without/with brake

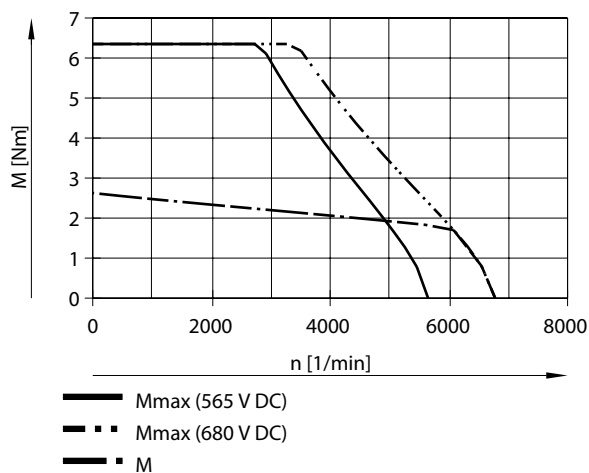

Typical motor characteristic curve at nominal voltage and optimal motor controller. Note the max. permissible rotational speeds of mounting and installation components (such as brake, encoder, etc.).

Mmax = peak torque

M = nominal torque

Torque M as a function of rotational speed n for EMMT-AS-80, long, low voltage, without/with brake

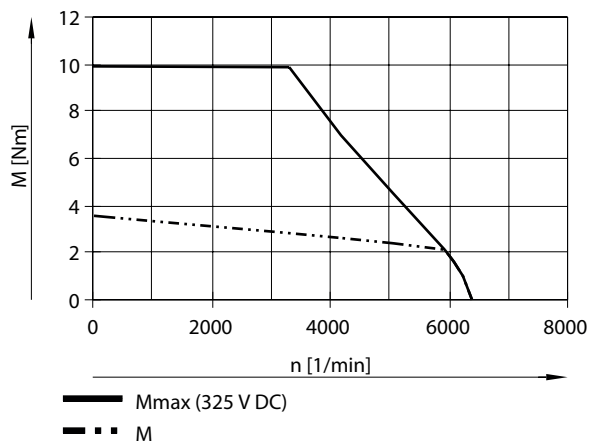

Typical motor characteristic curve at nominal voltage and optimal motor controller. Note the max. permissible rotational speeds of mounting and installation components (such as brake, encoder, etc.).

Mmax = peak torque

M = nominal torque

Datasheet

Torque M as a function of rotational speed n for EMMT-AS-80, long, high voltage, without/with brake

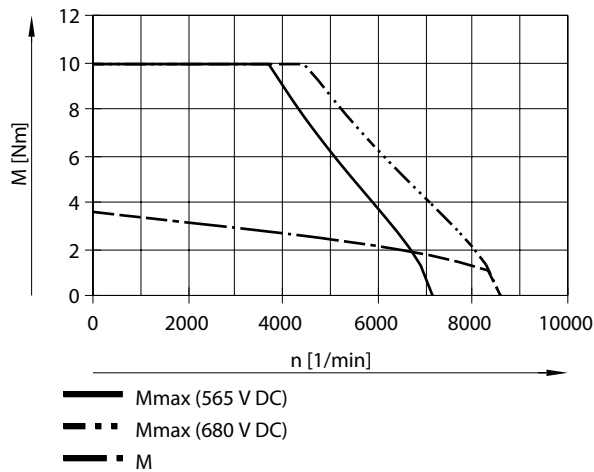

Typical motor characteristic curve at nominal voltage and optimal motor controller. Note the max. permissible rotational speeds of mounting and installation components (such as brake, encoder, etc.).

Mmax = peak torque

M = nominal torque

Torque M as a function of rotational speed n for EMMT-AS-80, very long, high voltage, without/with brake

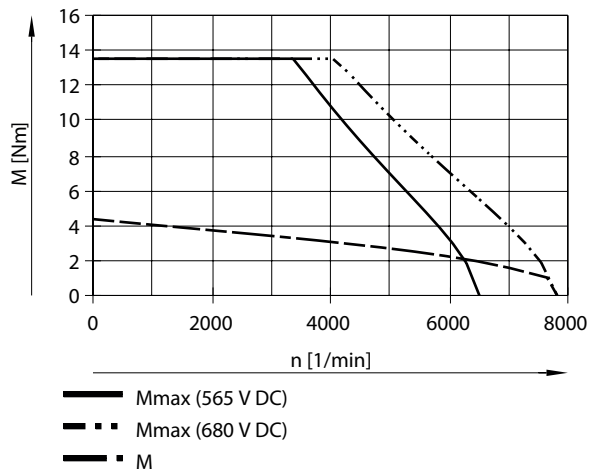

Typical motor characteristic curve at nominal voltage and optimal motor controller. Note the max. permissible rotational speeds of mounting and installation components (such as brake, encoder, etc.).

Mmax = peak torque

M = nominal torque

Torque M as a function of rotational speed n for EMMT-AS-100-S-HS, short, high voltage, without/with brake

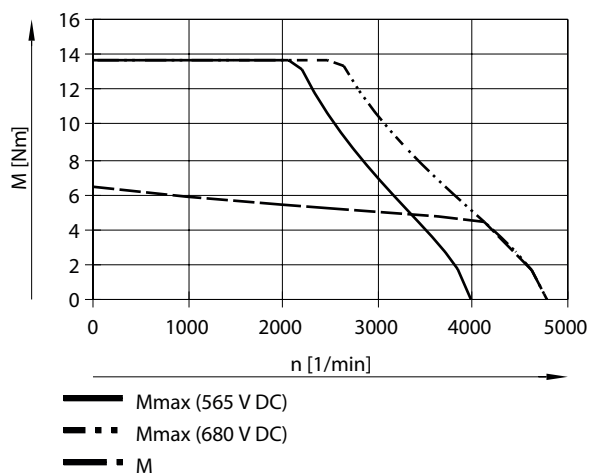

Typical motor characteristic curve at nominal voltage and optimal motor controller. Note the max. permissible rotational speeds of mounting and installation components (such as brake, encoder, etc.).

Mmax = peak torque

M = nominal torque

Datasheet

Torque M as a function of rotational speed n for EMMT-AS-100, medium, high voltage, without/with brake

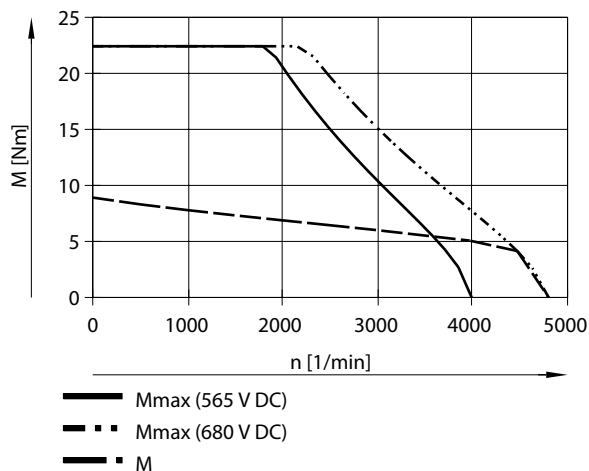

Typical motor characteristic curve at nominal voltage and optimal motor controller. Note the max. permissible rotational speeds of mounting and installation components (such as brake, encoder, etc.).

Mmax = peak torque

M = nominal torque

Torque M as a function of rotational speed n for EMMT-AS-100, long, high voltage, without brake

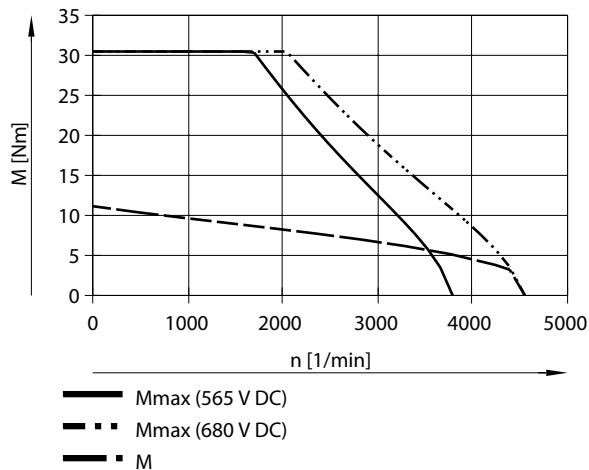

Typical motor characteristic curve at nominal voltage and optimal motor controller. Note the max. permissible rotational speeds of mounting and installation components (such as brake, encoder, etc.).

Mmax = peak torque

M = nominal torque

Torque M as a function of rotational speed n for EMMT-AS-100, long, high voltage, with brake

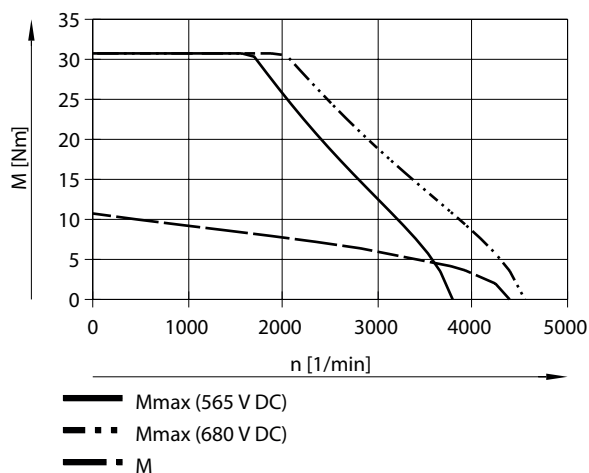

Typical motor characteristic curve at nominal voltage and optimal motor controller. Note the max. permissible rotational speeds of mounting and installation components (such as brake, encoder, etc.).

Mmax = peak torque

M = nominal torque

Datasheet

Torque M as a function of rotational speed n for EMMT-AS-100, very long, high voltage, without brake

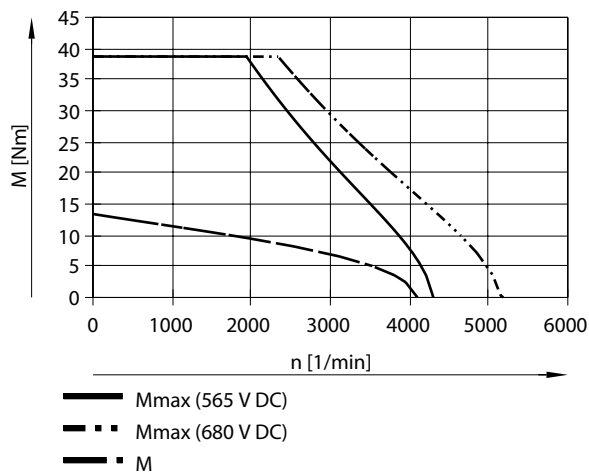

Typical motor characteristic curve at nominal voltage and optimal motor controller. Note the max. permissible rotational speeds of add-on and installation components (such as brake, encoder, etc.).

Mmax = peak torque

M = nominal torque

Torque M as a function of rotational speed n for EMMT-AS-100, very long, high voltage, with brake

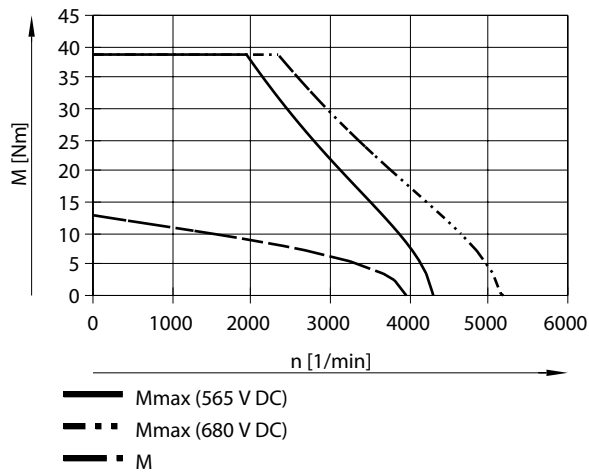

Typical motor characteristic curve at nominal voltage and optimal motor controller. Note the max. permissible rotational speeds of add-on and installation components (such as brake, encoder, etc.).

Mmax = peak torque

M = nominal torque

Torque M as a function of rotational speed n for EMMT-AS-150, medium, high voltage, without/with brake

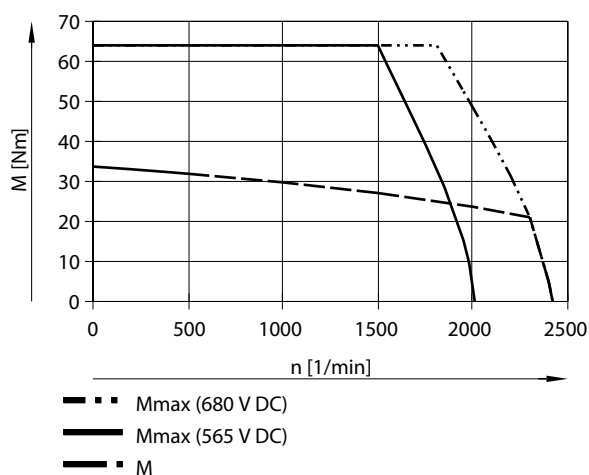

Typical motor characteristic curve at nominal voltage and optimal motor controller. Note the max. permissible rotational speeds of mounting and installation components (such as brake, encoder, etc.).

Mmax = peak torque

M = nominal torque

Datasheet

Torque M as a function of speed n for EMMT-AS-150, medium, high-voltage speed-optimised, without/with brake

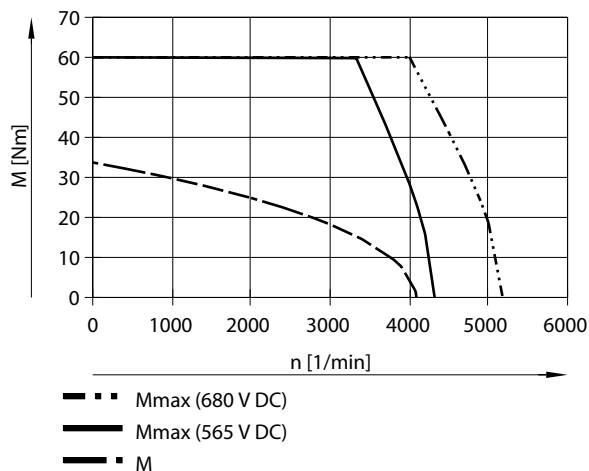

Typical motor characteristic curve at nominal voltage and optimal motor controller. Note the max. permissible rotational speeds of mounting and installation components (such as brake, encoder, etc.).

Mmax = peak torque

M = nominal torque

Torque M as a function of rotational speed n for EMMT-AS-150, long, high voltage, without/with brake

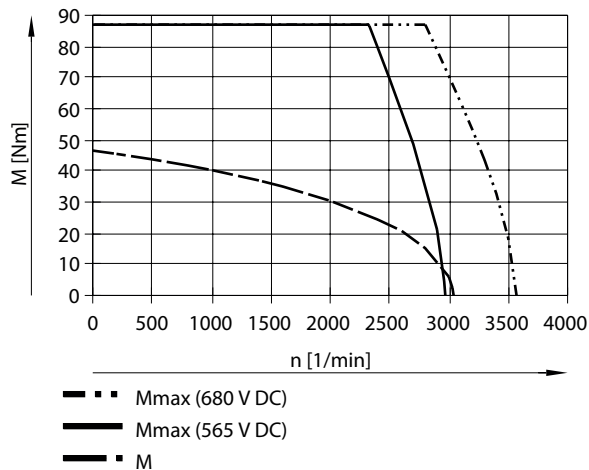

Typical motor characteristic curve at nominal voltage and optimal motor controller. Note the max. permissible rotational speeds of mounting and installation components (such as brake, encoder, etc.).

Mmax = peak torque

M = nominal torque

Torque M as a function of speed n for EMMT-AS-150, long, high-voltage torque-optimised, without/with brake

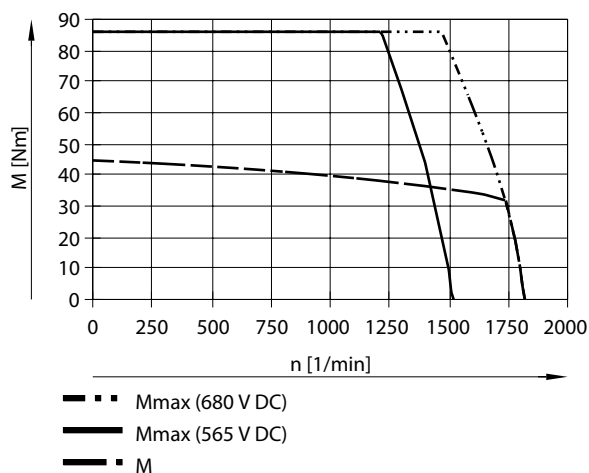

Typical motor characteristic curve at nominal voltage and optimal motor controller. Note the max. permissible rotational speeds of mounting and installation components (such as brake, encoder, etc.).

Mmax = peak torque

M = nominal torque

Datasheet

Torque M as a function of rotational speed n for EMMT-AS-190, medium, high voltage, without/with brake

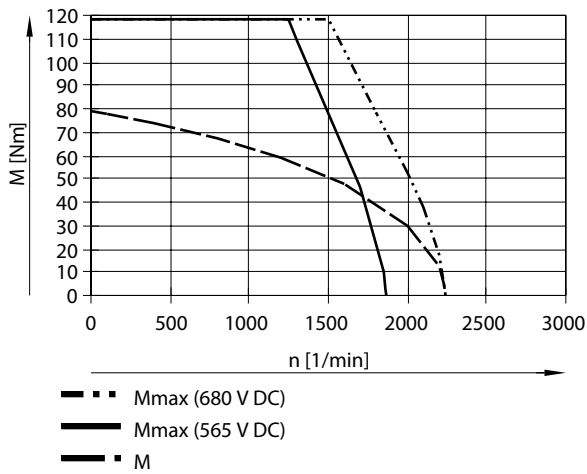

Typical motor characteristic curve at nominal voltage and optimal motor controller. Note the max. permissible rotational speeds of mounting and installation components (such as brake, encoder, etc.).

Mmax = peak torque

M = nominal torque

Torque M as a function of speed n for EMMT-AS-190, long, high-voltage torque-optimised, without/with brake

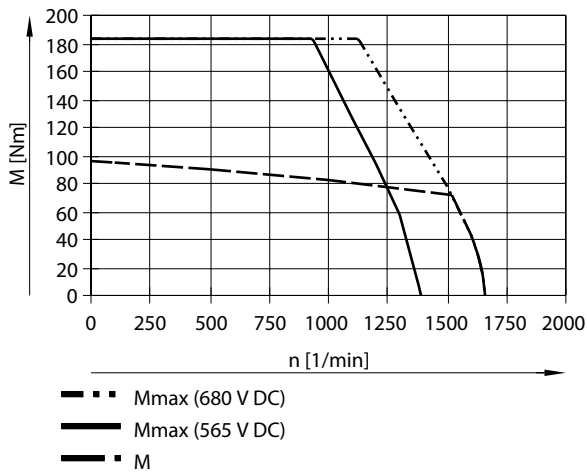

Typical motor characteristic curve at nominal voltage and optimal motor controller. Note the max. permissible rotational speeds of mounting and installation components (such as brake, encoder, etc.).

Mmax = peak torque

M = nominal torque

Dimensions

Dimensions – EMMT-EC-40

Download CAD data www.festo.com

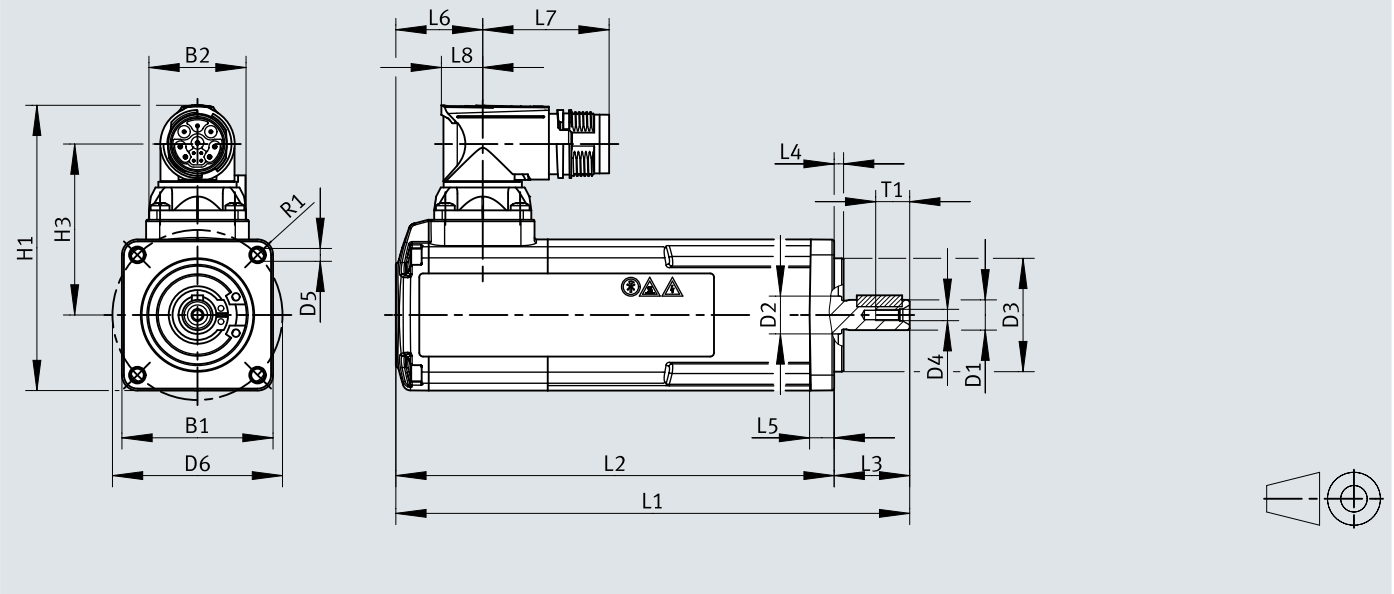

		B1	B2	D1 ø h6	D2 ø	D3 ø h7	D4	D5 ø
EMMT-EC-40	S	40	26	8	10	30	M3	3,4
	M							

		D6 ø ±0,3	H1	H3	L1		L2		L3
					B ¹⁾	±2	B ¹⁾	±2	
EMMT-EC-40	S	45	75,4	45,1	116	96	119,1	116	20 ^{+0,5/-0,7}
	M				136	116	139,1		

		L4	L5	L6		L7	L8	R1	T1
		±0,2	±0,3	B ¹⁾					
EMMT-EC-40	S	2,5	6,5	22,3	46,1	33,5	13	4	9
	M								

1) With brake

Dimensions

Dimensions – Featherkey for EMMT-EC-40

Download CAD data www.festo.com

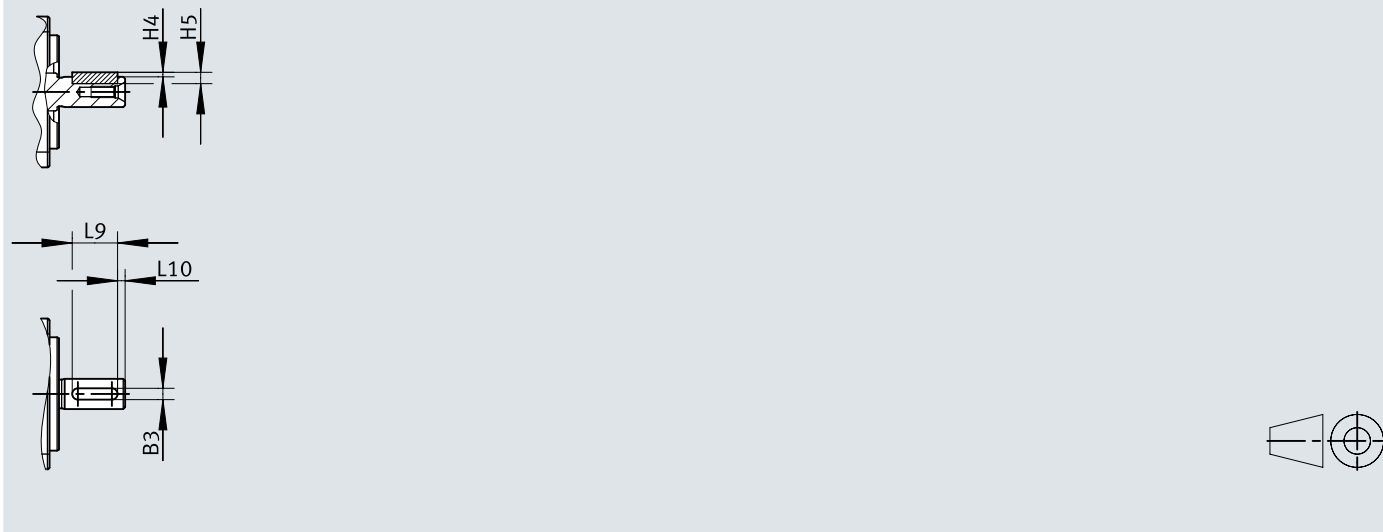

	B3	H4	H5	L9 -0,2	L10	1)
EMMT-EC-40-...-K	3	1,2	3	12	2	DIN 6885 A 3x3x12

1) Feather key

Dimensions

Dimensions – Connection for EMMT-EC-40

Download CAD data www.festo.com

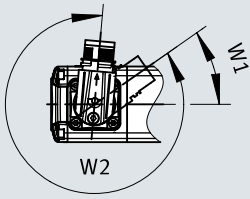

	W1	W2
EMMT-EC-...	-35°	310°

Dimensions

Dimensions – EMMT-AS-40, 60, 80, 100

Download CAD data www.festo.com

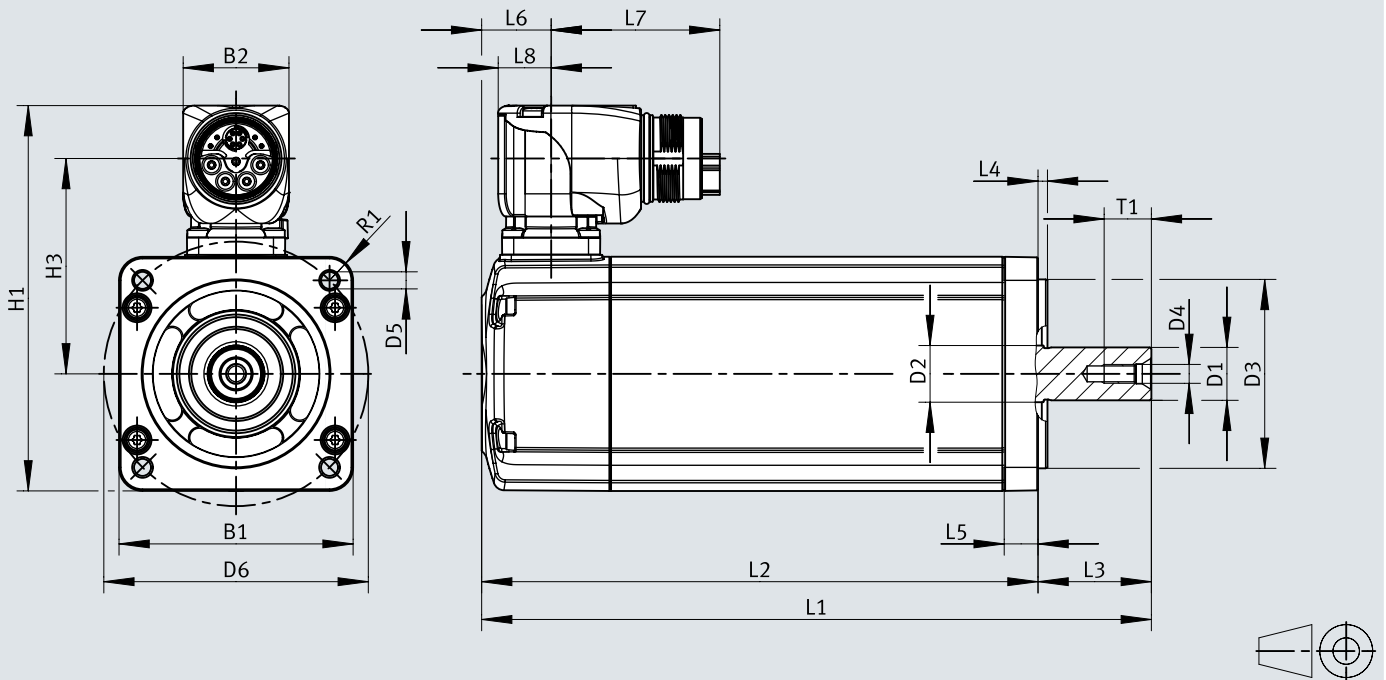

[1] Only motors without feather key may be used in combination with parallel and axial kits (EAMM-U/EAMM-A).

Dimensions

		B1	B2	D1 ∅ h6	D2 ∅	D3 ∅ h7	D4	D5 ∅
EMMT-AS-40	S	40	28	8	10	30	M3	3,4
	M							
EMMT-AS-60	S	62	28	14	15	50	M5	4,3
	M							
	L							
EMMT-AS-80	S	82	28	19	20	70	M6	5,3
	M							
	L							
	H							
EMMT-AS-100	S	104	28	19	20	95	M6	9
	M							
	L							
	H							

		D6 ∅ ±0,3	H1	H3	L1		L2		L3
						B ¹⁾	±2	B ¹⁾ ±2	
EMMT-AS-40	S	45	84,7	50,7	116	139,1	96	119,1	20 _{+0,5/-0,7}
	M				136	159,1	116	139,1	
EMMT-AS-60	S	70	102	57	144,5	177,3	114,5	147,3	30 _{+0,5/-0,2}
	M				164,5	197,3	134,5	167,3	
	L				184,5	217,3	154,5	187,3	
EMMT-AS-80	S	90	122	67	165,2	209,4	130,2	174,4	35 _{+0,4/-0,2}
	M				185,2	229,4	150,2	194,4	
	L				205,2	249,4	170,2	214,4	
	H				225,2	269,4	190,2	234,4	
EMMT-AS-100	S	115	144	78	227,5	271,7	187,5	231,7	40 _{+0,4/-0,2}
	M				257,5	301,7	217,5	261,7	
	L				287,5	330,7	247,5	290,7	
	H				344,5	388,7	304,5	348,7	

		L4 ±0,2	L5 ±0,3	L6		L7	L8	R1	T1
					B ¹⁾				
EMMT-AS-40	S	2,5	6,5	22,3	46,1	44,7	14	4	9
	M								
EMMT-AS-60	S	2,5	9	18,4		44,7	14	6	12,5
	M								
	L								
EMMT-AS-80	S	3	10	20,1		44,7	14	8	16
	M								
	L								
	H								
EMMT-AS-100	S	3	12	22,7		44,7	14	11	16
	M								
	L								
	H								

1) With brake

Dimensions

Dimensions – Featherkey for EMMT-AS-40, 60, 80, 100

Download CAD data www.festo.com

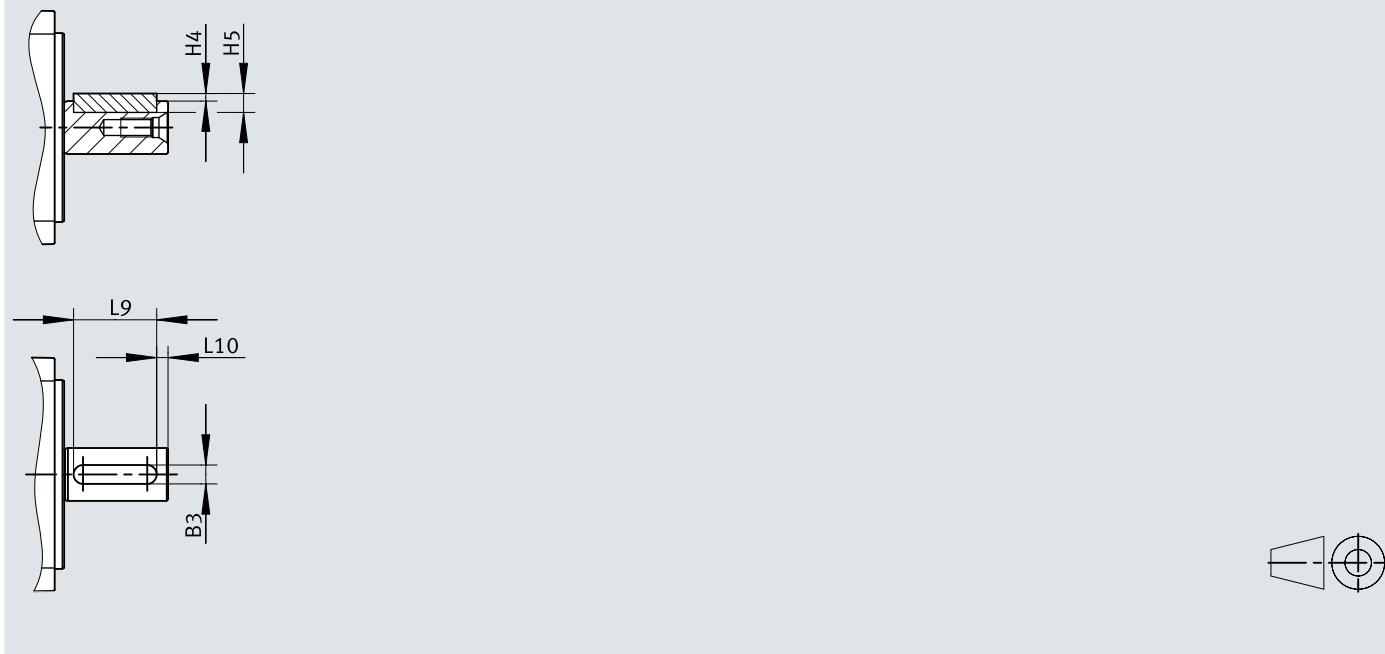

	B3	H4	H5	L9	L10	1)
EMMT-AS-40-...-K	3	1,2	3	12	2	DIN 6885 A 3x3x12
EMMT-AS-60-...-K	5	2	5	22	3	DIN 6885 A 5x5x22
EMMT-AS-80-...-K	6	2,5	6	22	3	DIN 6885 A 6x6x22
EMMT-AS-100-...-K	6	2,5	6	32	3	DIN 6885 A 6x6x32

1) Feather key

Dimensions

Dimensions – Connection for EMMT-AS-60, 80, 100

Download CAD data www.festo.com

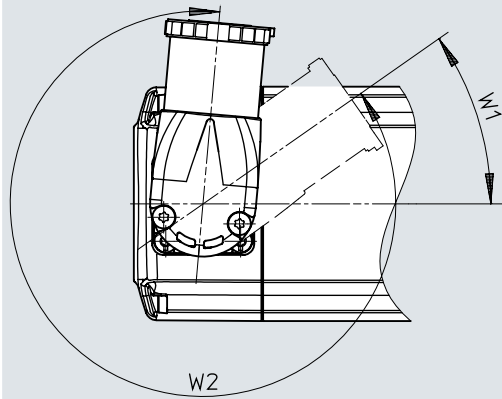

	W1	W2
EMMT-AS...	-35°	310°

Dimensions

Dimensions – EMMT-AS-150, 190

Download CAD data www.festo.com

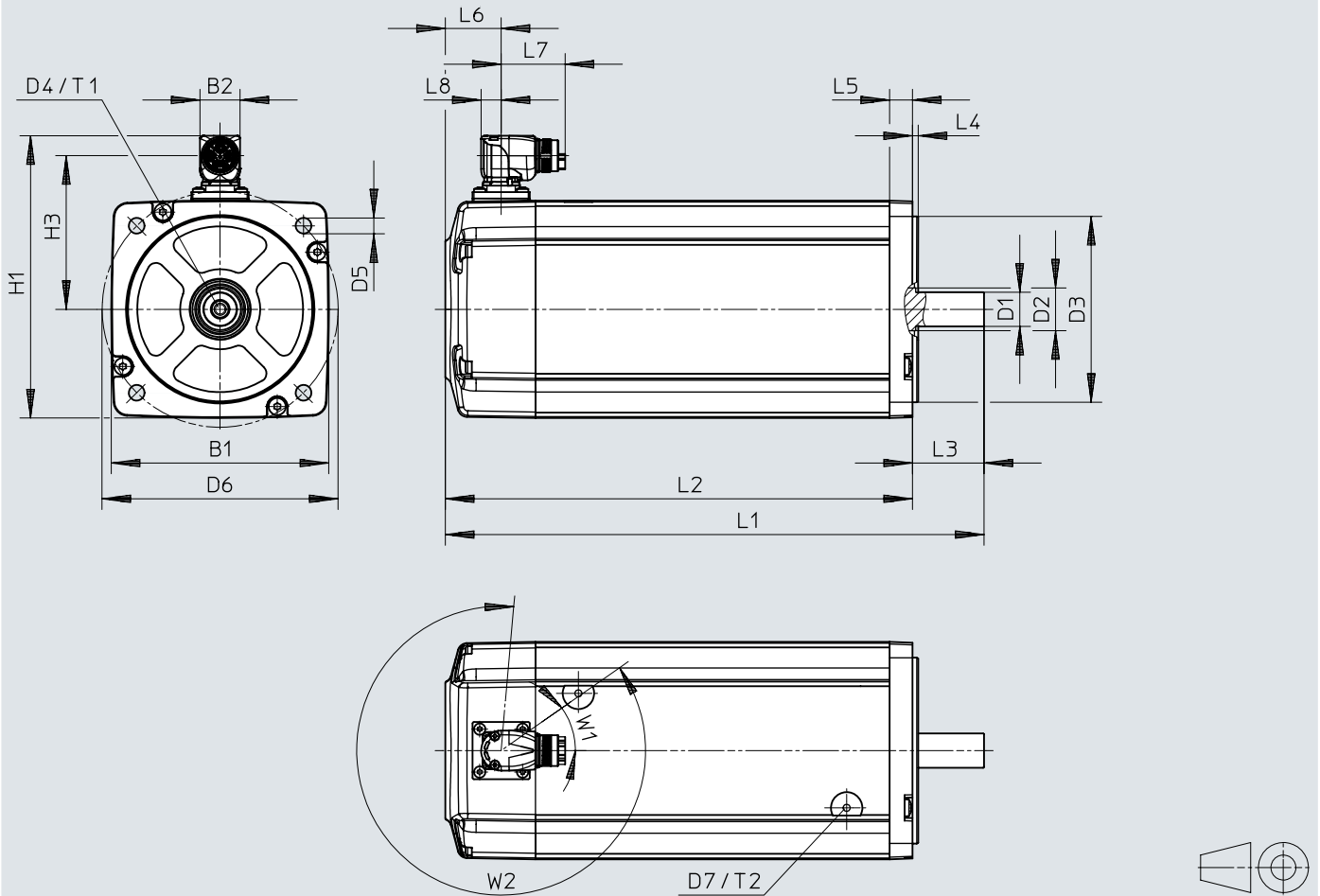

[1] Only motors without feather key may be used in combination with parallel and axial kits (EAMM-U/EAMM-A).

Dimensions

			B1	B2	D1 ∅ h6	D2 ∅	D3 ∅ h7	D4	D5 ∅	D6 ∅ ±0,3
EMMT-AS-150	M	HS	152	28	24	30	130	M8	11	165
	L	HT		42,8						
	M	HV								
	L	HS								
EMMT-AS-190	M	HS	190	42,8	32	40	180	M8	13,5	215
	L	HT								

			D7	H1	H3	L1		L2		L3	L4 ±0,2
							B ¹⁾	±2	B ¹⁾ ±2		
EMMT-AS-150	M	HS	M6	197,4	107,4	316,5	367,5	266,5	317,5	50	4
	L	HT				376,5	440,5	326,5	390,5		
	M	HV		219,8	117,8	316,5	367,5	266,5	317,5		
	L	HS				376,5	440,5	326,5	390,5		
EMMT-AS-190	M	HS	M8	258,3	137,3	414,5	477	356,5	419	58	5
	L	HT				474,5	537	416,5	479		

			L5 ±0,3	L6	L7	L8	T1	T2	W1	W2
EMMT-AS-150	M	HS	16	39	44,7	14	19	13	-35	310
	L	HT								
	M	HV			80,9	19,9				
	L	HS								
EMMT-AS-190	M	HS	18	46	80,9	19,9	28	13	-35	310
	L	HT								

1) With brake

Dimensions

Dimensions – Featherkey for EMMT-AS-150, 190

Download CAD data www.festo.com

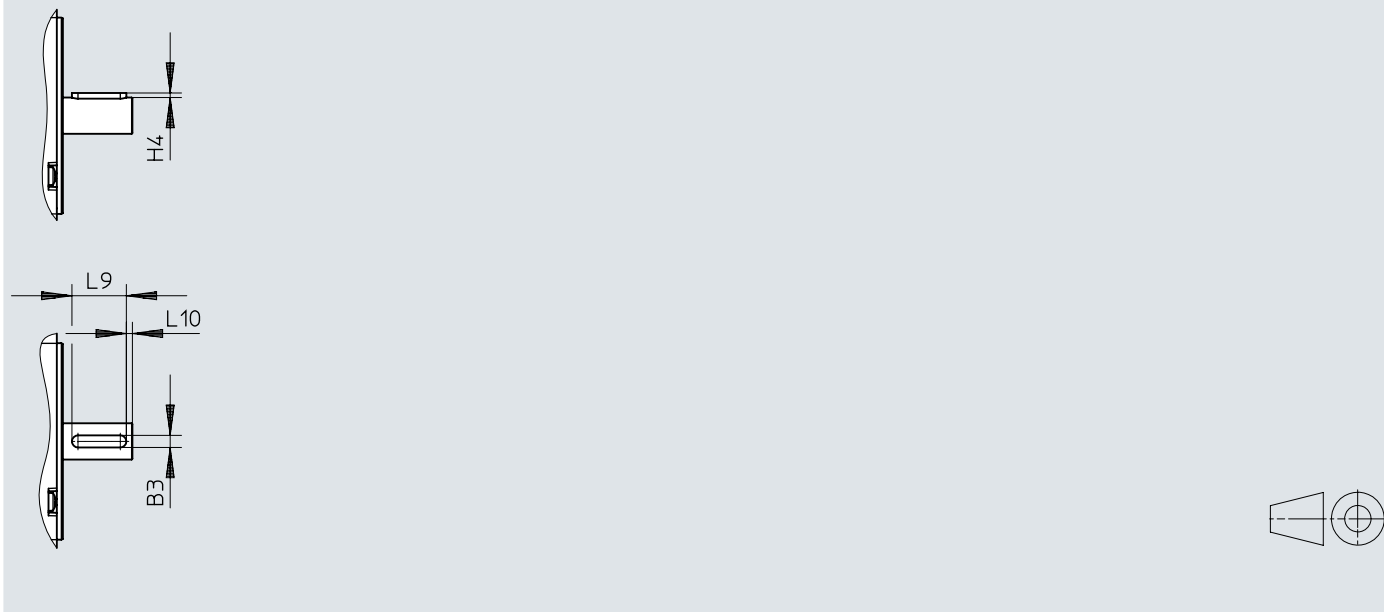

	B3	H4	L9	L10	1)
	h9		-0,2		
EMMT-AS-150-...-K	8	3	36	4	DIN 6885 A 8x7x36
EMMT-AS-190-...-K	10	3	45	4	DIN 6885 A 10x8x45

1) Feather key

Dimensions

Dimensions – Connection for EMMT-AS-150, 190

Download CAD data www.festo.com

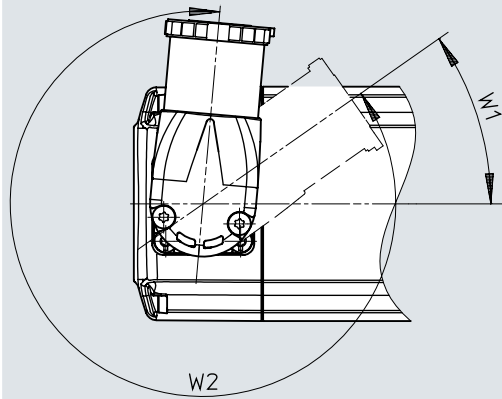

	W1	W2
EMMT-AS...	-35°	310°

Ordering data

EMMT-EC-40, EMMT-AS-40					
Length	Winding	Measuring unit	Brake	Part no.	Type
Short	Safety extra-low voltage, standard	Absolute encoder, multi-turn, BISS-C	None	8171401	EMMT-EC-40-S-ES-R1MC
			With brake	8171403	EMMT-EC-40-S-ES-R1MCB
		Absolute encoder, single-turn, BISS-C	None	8171400	EMMT-EC-40-S-ES-R1SC
			With brake	8171402	EMMT-EC-40-S-ES-R1SCB
	Low voltage, standard	Absolute encoder, multi-turn	None	8171413	EMMT-AS-40-S-LS-R2M
			With brake	8171415	EMMT-AS-40-S-LS-R2MB
		Absolute encoder, single turn	None	8171412	EMMT-AS-40-S-LS-R2S
			With brake	8171414	EMMT-AS-40-S-LS-R2SB
Medium	Safety extra-low voltage, standard	Absolute encoder, multi-turn, BISS-C	None	8171405	EMMT-EC-40-M-ES-R1MC
			With brake	8171407	EMMT-EC-40-M-ES-R1MCB
		Absolute encoder, single-turn, BISS-C	None	8171404	EMMT-EC-40-M-ES-R1SC
			With brake	8171406	EMMT-EC-40-M-ES-R1SCB
	Low voltage, standard	Absolute encoder, multi-turn	None	8171417	EMMT-AS-40-M-LS-R2M
			With brake	8171419	EMMT-AS-40-M-LS-R2MB
		Absolute encoder, single turn	None	8171416	EMMT-AS-40-M-LS-R2S
			With brake	8171418	EMMT-AS-40-M-LS-R2SB

EMMT-AS-60					
Length	Winding	Measuring unit	Brake	Part no.	Type
Short	High voltage, standard	Absolute encoder, multi-turn	None	5242201	EMMT-AS-60-S-HS-RM
			With brake	5242203	EMMT-AS-60-S-HS-RMB
		Absolute multi-turn safety encoder, EnDat®	None	8160632	EMMT-AS-60-S-HS-RMY
			With brake	8160633	EMMT-AS-60-S-HS-RMYB
		Absolute encoder, single turn	None	5242200	EMMT-AS-60-S-HS-RS
			With brake	5242202	EMMT-AS-60-S-HS-RSB
	Low voltage, standard	Absolute encoder, multi-turn	None	5242197	EMMT-AS-60-S-LS-RM
			With brake	5242199	EMMT-AS-60-S-LS-RMB
		Absolute multi-turn safety encoder, EnDat®	None	8160630	EMMT-AS-60-S-LS-RMY
			With brake	8160631	EMMT-AS-60-S-LS-RMYB
		Absolute encoder, single turn	None	5242196	EMMT-AS-60-S-LS-RS
			With brake	5242198	EMMT-AS-60-S-LS-RSB
Medium	High voltage, standard	Absolute encoder, multi-turn	None	5242209	EMMT-AS-60-M-HS-RM
			With brake	5242211	EMMT-AS-60-M-HS-RMB
		Absolute multi-turn safety encoder, EnDat®	None	8160636	EMMT-AS-60-M-HS-RMY
			With brake	8160637	EMMT-AS-60-M-HS-RMYB
		Absolute encoder, single turn	None	5242208	EMMT-AS-60-M-HS-RS
			With brake	5242210	EMMT-AS-60-M-HS-RSB
	Low voltage, standard	Absolute encoder, multi-turn	None	5242205	EMMT-AS-60-M-LS-RM
			With brake	5242207	EMMT-AS-60-M-LS-RMB
		Absolute multi-turn safety encoder, EnDat®	None	8160634	EMMT-AS-60-M-LS-RMY
			With brake	8160635	EMMT-AS-60-M-LS-RMYB
		Absolute encoder, single turn	None	5242204	EMMT-AS-60-M-LS-RS
			With brake	5242206	EMMT-AS-60-M-LS-RSB
Long	High voltage, standard	Absolute encoder, multi-turn	None	5242217	EMMT-AS-60-L-HS-RM
			With brake	5242219	EMMT-AS-60-L-HS-RMB
		Absolute multi-turn safety encoder, EnDat®	None	8160640	EMMT-AS-60-L-HS-RMY
			With brake	8160641	EMMT-AS-60-L-HS-RMYB
		Absolute encoder, single turn	None	5242216	EMMT-AS-60-L-HS-RS
			With brake	5242218	EMMT-AS-60-L-HS-RSB
	Low voltage, standard	Absolute encoder, multi-turn	None	5242213	EMMT-AS-60-L-LS-RM
			With brake	5242215	EMMT-AS-60-L-LS-RMB
		Absolute multi-turn safety encoder, EnDat®	None	8160638	EMMT-AS-60-L-LS-RMY
			With brake	8160639	EMMT-AS-60-L-LS-RMYB
		Absolute encoder, single turn	None	5242212	EMMT-AS-60-L-LS-RS
			With brake	5242214	EMMT-AS-60-L-LS-RSB

Ordering data

EMMT-AS-80					
Length	Winding	Measuring unit	Brake	Part no.	Type
Short	High voltage, standard	Absolute encoder, multi-turn	None	5255430	EMMT-AS-80-S-HS-RM
			With brake	5255432	EMMT-AS-80-S-HS-RMB
		Absolute multi-turn safety encoder, EnDat®	None	8160644	EMMT-AS-80-S-HS-RMY
			With brake	8160645	EMMT-AS-80-S-HS-RMYB
		Absolute encoder, single turn	None	5255429	EMMT-AS-80-S-HS-RS
			With brake	5255431	EMMT-AS-80-S-HS-RSB
	Low voltage, standard	Absolute encoder, multi-turn	None	5255426	EMMT-AS-80-S-LS-RM
			With brake	5255428	EMMT-AS-80-S-LS-RMB
		Absolute multi-turn safety encoder, EnDat®	None	8160642	EMMT-AS-80-S-LS-RMY
			With brake	8160643	EMMT-AS-80-S-LS-RMYB
		Absolute encoder, single turn	None	5255425	EMMT-AS-80-S-LS-RS
			With brake	5255427	EMMT-AS-80-S-LS-RSB
Medium	High voltage, standard	Absolute encoder, multi-turn	None	5255438	EMMT-AS-80-M-HS-RM
			With brake	5255440	EMMT-AS-80-M-HS-RMB
		Absolute multi-turn safety encoder, EnDat®	None	8160648	EMMT-AS-80-M-HS-RMY
			With brake	8160649	EMMT-AS-80-M-HS-RMYB
		Absolute encoder, single turn	None	5255437	EMMT-AS-80-M-HS-RS
			With brake	5255439	EMMT-AS-80-M-HS-RSB
	Low voltage, standard	Absolute encoder, multi-turn	None	5255434	EMMT-AS-80-M-LS-RM
			With brake	5255436	EMMT-AS-80-M-LS-RMB
		Absolute multi-turn safety encoder, EnDat®	None	8160646	EMMT-AS-80-M-LS-RMY
			With brake	8160647	EMMT-AS-80-M-LS-RMYB
		Absolute encoder, single turn	None	5255433	EMMT-AS-80-M-LS-RS
			With brake	5255435	EMMT-AS-80-M-LS-RSB
Long	High voltage, standard	Absolute encoder, multi-turn	None	5255446	EMMT-AS-80-L-HS-RM
			With brake	5255448	EMMT-AS-80-L-HS-RMB
		Absolute multi-turn safety encoder, EnDat®	None	8160652	EMMT-AS-80-L-HS-RMY
			With brake	8160653	EMMT-AS-80-L-HS-RMYB
		Absolute encoder, single turn	None	5255445	EMMT-AS-80-L-HS-RS
			With brake	5255447	EMMT-AS-80-L-HS-RSB
	Low voltage, standard	Absolute encoder, multi-turn	None	5255442	EMMT-AS-80-L-LS-RM
			With brake	5255444	EMMT-AS-80-L-LS-RMB
		Absolute multi-turn safety encoder, EnDat®	None	8160650	EMMT-AS-80-L-LS-RMY
			With brake	8160651	EMMT-AS-80-L-LS-RMYB
		Absolute encoder, single turn	None	5255441	EMMT-AS-80-L-LS-RS
			With brake	5255443	EMMT-AS-80-L-LS-RSB
Very long	High voltage, standard	Absolute encoder, multi-turn	None	8172104	EMMT-AS-80-H-HS-RM
			With brake	8172026	EMMT-AS-80-H-HS-RMB
		Absolute multi-turn safety encoder, EnDat®	None	8185112	EMMT-AS-80-H-HS-RMY
			With brake	8185114	EMMT-AS-80-H-HS-RMYB
		Absolute encoder, single turn	None	610909	EMMT-AS-80-H-HS-RS
			With brake	610908	EMMT-AS-80-H-HS-RSB

EMMT-AS-100					
Length	Winding	Measuring unit	Brake	Part no.	Type
Short	High voltage, standard	Absolute encoder, multi-turn	None	5255521	EMMT-AS-100-S-HS-RM
			With brake	5255529	EMMT-AS-100-S-HS-RMB
		Absolute multi-turn safety encoder, EnDat®	None	8160654	EMMT-AS-100-S-HS-RMY
			With brake	8160655	EMMT-AS-100-S-HS-RMYB
		Absolute encoder, single turn	None	5255519	EMMT-AS-100-S-HS-RS
			With brake	5255528	EMMT-AS-100-S-HS-RSB
Medium	High voltage, standard	Absolute encoder, multi-turn	None	5255531	EMMT-AS-100-M-HS-RM
			With brake	5255533	EMMT-AS-100-M-HS-RMB
		Absolute multi-turn safety encoder, EnDat®	None	8160656	EMMT-AS-100-M-HS-RMY
			With brake	8160657	EMMT-AS-100-M-HS-RMYB
		Absolute encoder, single turn	None	5255530	EMMT-AS-100-M-HS-RS
			With brake	5255532	EMMT-AS-100-M-HS-RSB
Long	High voltage, standard	Absolute encoder, multi-turn	None	5255535	EMMT-AS-100-L-HS-RM

Ordering data

EMMT-AS-100					
Length	Winding	Measuring unit	Brake	Part no.	Type
Long	High voltage, standard	Absolute encoder, multi-turn	With brake	5255537	EMMT-AS-100-L-HS-RMB
			None	8160658	EMMT-AS-100-L-HS-RMY
		Absolute multi-turn safety encoder, EnDat®	With brake	8160659	EMMT-AS-100-L-HS-RMYB
			None	5255534	EMMT-AS-100-L-HS-RS
		Absolute encoder, single turn	With brake	5255536	EMMT-AS-100-L-HS-RSB
			None	8182016	EMMT-AS-100-H-HS-RM
Very long	High voltage, standard	Absolute encoder, multi-turn	With brake	8182014	EMMT-AS-100-H-HS-RMB
			None	8160660	EMMT-AS-100-H-HS-RMY
		Absolute multi-turn safety encoder, EnDat®	With brake	8160661	EMMT-AS-100-H-HS-RMYB
			None	8182017	EMMT-AS-100-H-HS-RS
		Absolute encoder, single turn	With brake	8182015	EMMT-AS-100-H-HS-RSB
			None		

EMMT-AS-150					
Length	Winding	Measuring unit	Brake	Part no.	Type
Medium	High voltage, standard	Absolute encoder, multi-turn	None	8148271	EMMT-AS-150-M-HS-R2M
			With brake	8148274	EMMT-AS-150-M-HS-R2MB
		Absolute multi-turn safety encoder, EnDat®	None	8148272	EMMT-AS-150-M-HS-R2MY
			With brake	8148275	EMMT-AS-150-M-HS-R2MYB
		Absolute encoder, single turn	None	8148270	EMMT-AS-150-M-HS-R2S
			With brake	8148273	EMMT-AS-150-M-HS-R2SB
	High voltage, speed optimised	Absolute encoder, multi-turn	None	8148277	EMMT-AS-150-M-HV-R3M
			With brake	8148280	EMMT-AS-150-M-HV-R3MB
		Absolute multi-turn safety encoder, EnDat®	None	8148278	EMMT-AS-150-M-HV-R3MY
			With brake	8148281	EMMT-AS-150-M-HV-R3MYB
		Absolute encoder, single turn	None	8148276	EMMT-AS-150-M-HV-R3S
			With brake	8148279	EMMT-AS-150-M-HV-R3SB
Long	High voltage, standard	Absolute encoder, multi-turn	None	8148325	EMMT-AS-150-L-HS-R3M
			With brake	8148328	EMMT-AS-150-L-HS-R3MB
		Absolute multi-turn safety encoder, EnDat®	None	8148326	EMMT-AS-150-L-HS-R3MY
			With brake	8148329	EMMT-AS-150-L-HS-R3MYB
		Absolute encoder, single turn	None	8148324	EMMT-AS-150-L-HS-R3S
			With brake	8148327	EMMT-AS-150-L-HS-R3SB
	High voltage, torque optimised	Absolute encoder, multi-turn	None	8148319	EMMT-AS-150-L-HT-R2M
			With brake	8148322	EMMT-AS-150-L-HT-R2MB
		Absolute multi-turn safety encoder, EnDat®	None	8148320	EMMT-AS-150-L-HT-R2MY
			With brake	8148323	EMMT-AS-150-L-HT-R2MYB
		Absolute encoder, single turn	None	8148318	EMMT-AS-150-L-HT-R2S
			With brake	8148321	EMMT-AS-150-L-HT-R2SB

EMMT-AS-150 with featherkey					
Length	Winding	Measuring unit	Brake	Part no.	Type
Medium	High voltage, standard	Absolute encoder, multi-turn	None	8148283	EMMT-AS-150-MK-HS-R2M
			With brake	8148286	EMMT-AS-150-MK-HS-R2MB
		Absolute multi-turn safety encoder, EnDat®	None	8148284	EMMT-AS-150-MK-HS-R2MY
			With brake	8148287	EMMT-AS-150-MK-HS-R2MYB
		Absolute encoder, single turn	None	8148282	EMMT-AS-150-MK-HS-R2S
			With brake	8148285	EMMT-AS-150-MK-HS-R2SB
	High voltage, speed optimised	Absolute encoder, multi-turn	None	8148289	EMMT-AS-150-MK-HV-R3M
			With brake	8148292	EMMT-AS-150-MK-HV-R3MB
		Absolute multi-turn safety encoder, EnDat®	None	8148290	EMMT-AS-150-MK-HV-R3MY
			With brake	8148293	EMMT-AS-150-MK-HV-R3MYB
		Absolute encoder, single turn	None	8148288	EMMT-AS-150-MK-HV-R3S
			With brake	8148291	EMMT-AS-150-MK-HV-R3SB
Long	High voltage, standard	Absolute encoder, multi-turn	None	8148337	EMMT-AS-150-LK-HS-R3M
			With brake	8148340	EMMT-AS-150-LK-HS-R3MB
		Absolute multi-turn safety encoder, EnDat®	None	8148338	EMMT-AS-150-LK-HS-R3MY

Ordering data

EMMT-AS-150 with featherkey					
Length	Winding	Measuring unit	Brake	Part no.	Type
Long	High voltage, standard	Absolute multi-turn safety encoder, EnDat®	With brake	8148341	EMMT-AS-150-LK-HS-R3MYB
			None	8148336	EMMT-AS-150-LK-HS-R3S
		Absolute encoder, single turn	With brake	8148339	EMMT-AS-150-LK-HS-R3SB
			None	8148331	EMMT-AS-150-LK-HT-R2M
	High voltage, torque optimised	Absolute encoder, multi-turn	With brake	8148334	EMMT-AS-150-LK-HT-R2MB
			None	8148332	EMMT-AS-150-LK-HT-R2MY
		Absolute multi-turn safety encoder, EnDat®	With brake	8148335	EMMT-AS-150-LK-HT-R2MYB
			None	8148330	EMMT-AS-150-LK-HT-R2S
Absolute encoder, single turn	With brake	8148333	EMMT-AS-150-LK-HT-R2SB		
	None				

EMMT-AS-150 with radial shaft seal					
Length	Winding	Measuring unit	Brake	Part no.	Type
Medium	High voltage, standard	Absolute encoder, multi-turn	None	8148295	EMMT-AS-150-MR-HS-R2M
			With brake	8148298	EMMT-AS-150-MR-HS-R2MB
		Absolute multi-turn safety encoder, EnDat®	None	8148296	EMMT-AS-150-MR-HS-R2MY
			With brake	8148299	EMMT-AS-150-MR-HS-R2MYB
		Absolute encoder, single turn	None	8148294	EMMT-AS-150-MR-HS-R2S
			With brake	8148297	EMMT-AS-150-MR-HS-R2SB
	High voltage, speed optimised	Absolute encoder, multi-turn	None	8148301	EMMT-AS-150-MR-HV-R3M
			With brake	8148304	EMMT-AS-150-MR-HV-R3MB
		Absolute multi-turn safety encoder, EnDat®	None	8148302	EMMT-AS-150-MR-HV-R3MY
			With brake	8148305	EMMT-AS-150-MR-HV-R3MYB
		Absolute encoder, single turn	None	8148300	EMMT-AS-150-MR-HV-R3S
			With brake	8148303	EMMT-AS-150-MR-HV-R3SB
Long	High voltage, standard	Absolute encoder, multi-turn	None	8148349	EMMT-AS-150-LR-HS-R3M
			With brake	8148352	EMMT-AS-150-LR-HS-R3MB
		Absolute multi-turn safety encoder, EnDat®	None	8148350	EMMT-AS-150-LR-HS-R3MY
			With brake	8148353	EMMT-AS-150-LR-HS-R3MYB
		Absolute encoder, single turn	None	8148348	EMMT-AS-150-LR-HS-R3S
			With brake	8148351	EMMT-AS-150-LR-HS-R3SB
	High voltage, torque optimised	Absolute encoder, multi-turn	None	8148343	EMMT-AS-150-LR-HT-R2M
			With brake	8148346	EMMT-AS-150-LR-HT-R2MB
		Absolute multi-turn safety encoder, EnDat®	None	8148344	EMMT-AS-150-LR-HT-R2MY
			With brake	8148347	EMMT-AS-150-LR-HT-R2MYB
		Absolute encoder, single turn	None	8148342	EMMT-AS-150-LR-HT-R2S
			With brake	8148345	EMMT-AS-150-LR-HT-R2SB

EMMT-AS-150 with featherkey and radial shaft seal					
Length	Winding	Measuring unit	Brake	Part no.	Type
Medium	High voltage, standard	Absolute encoder, multi-turn	None	8148307	EMMT-AS-150-MKR-HS-R2M
			With brake	8148310	EMMT-AS-150-MKR-HS-R2MB
		Absolute multi-turn safety encoder, EnDat®	None	8148308	EMMT-AS-150-MKR-HS-R2MY
			With brake	8148311	EMMT-AS-150-MKR-HS-R2MYB
		Absolute encoder, single turn	None	8148306	EMMT-AS-150-MKR-HS-R2S
			With brake	8148309	EMMT-AS-150-MKR-HS-R2SB
	High voltage, speed optimised	Absolute encoder, multi-turn	None	8148313	EMMT-AS-150-MKR-HV-R3M
			With brake	8148316	EMMT-AS-150-MKR-HV-R3MB
		Absolute multi-turn safety encoder, EnDat®	None	8148314	EMMT-AS-150-MKR-HV-R3MY
			With brake	8148317	EMMT-AS-150-MKR-HV-R3MYB
		Absolute encoder, single turn	None	8148312	EMMT-AS-150-MKR-HV-R3S
			With brake	8148315	EMMT-AS-150-MKR-HV-R3SB
Long	High voltage, standard	Absolute encoder, multi-turn	None	8148361	EMMT-AS-150-LKR-HS-R3M
			With brake	8148364	EMMT-AS-150-LKR-HS-R3MB
		Absolute multi-turn safety encoder, EnDat®	None	8148362	EMMT-AS-150-LKR-HS-R3MY
			With brake	8148365	EMMT-AS-150-LKR-HS-R3MYB
Absolute encoder, single turn	None	8148360	EMMT-AS-150-LKR-HS-R3S		
	With brake				

Ordering data

EMMT-AS-150 with featherkey and radial shaft seal					
Length	Winding	Measuring unit	Brake	Part no.	Type
Long	High voltage, standard	Absolute encoder, single turn	With brake	8148363	EMMT-AS-150-LKR-HS-R3SB
			None	8148355	EMMT-AS-150-LKR-HT-R2M
	High voltage, torque optimised	Absolute encoder, multi-turn	With brake	8148358	EMMT-AS-150-LKR-HT-R2MB
			None	8148356	EMMT-AS-150-LKR-HT-R2MY
			With brake	8148359	EMMT-AS-150-LKR-HT-R2MYB
			None	8148354	EMMT-AS-150-LKR-HT-R2S
High voltage, torque optimised	Absolute multi-turn safety encoder, EnDat®	With brake	8148357	EMMT-AS-150-LKR-HT-R2SB	
		None	8148357	EMMT-AS-150-LKR-HT-R2SB	

EMMT-AS-190					
Length	Winding	Measuring unit	Brake	Part no.	Type
Medium	High voltage, standard	Absolute encoder, multi-turn	None	8148367	EMMT-AS-190-M-HS-R3M
			With brake	8148370	EMMT-AS-190-M-HS-R3MB
		Absolute multi-turn safety encoder, EnDat®	None	8148368	EMMT-AS-190-M-HS-R3MY
			With brake	8148371	EMMT-AS-190-M-HS-R3MYB
		Absolute encoder, single turn	None	8148366	EMMT-AS-190-M-HS-R3S
			With brake	8148369	EMMT-AS-190-M-HS-R3SB
Long	High voltage, torque optimised	Absolute encoder, multi-turn	None	8148391	EMMT-AS-190-L-HT-R3M
			With brake	8148394	EMMT-AS-190-L-HT-R3MB
		Absolute multi-turn safety encoder, EnDat®	None	8148392	EMMT-AS-190-L-HT-R3MY
			With brake	8148395	EMMT-AS-190-L-HT-R3MYB
		Absolute encoder, single turn	None	8148390	EMMT-AS-190-L-HT-R3S
			With brake	8148393	EMMT-AS-190-L-HT-R3SB

EMMT-AS-190 with featherkey					
Length	Winding	Measuring unit	Brake	Part no.	Type
Medium	High voltage, standard	Absolute encoder, multi-turn	None	8148373	EMMT-AS-190-MK-HS-R3M
			With brake	8148376	EMMT-AS-190-MK-HS-R3MB
		Absolute multi-turn safety encoder, EnDat®	None	8148374	EMMT-AS-190-MK-HS-R3MY
			With brake	8148377	EMMT-AS-190-MK-HS-R3MYB
		Absolute encoder, single turn	None	8148372	EMMT-AS-190-MK-HS-R3S
			With brake	8148375	EMMT-AS-190-MK-HS-R3SB
Long	High voltage, torque optimised	Absolute encoder, multi-turn	None	8148397	EMMT-AS-190-LK-HT-R3M
			With brake	8148400	EMMT-AS-190-LK-HT-R3MB
		Absolute multi-turn safety encoder, EnDat®	None	8148398	EMMT-AS-190-LK-HT-R3MY
			With brake	8148401	EMMT-AS-190-LK-HT-R3MYB
		Absolute encoder, single turn	None	8148396	EMMT-AS-190-LK-HT-R3S
			With brake	8148399	EMMT-AS-190-LK-HT-R3SB

EMMT-AS-190 with radial shaft seal					
Length	Winding	Measuring unit	Brake	Part no.	Type
Medium	High voltage, standard	Absolute encoder, multi-turn	None	8148379	EMMT-AS-190-MR-HS-R3M
			With brake	8148382	EMMT-AS-190-MR-HS-R3MB
		Absolute multi-turn safety encoder, EnDat®	None	8148380	EMMT-AS-190-MR-HS-R3MY
			With brake	8148383	EMMT-AS-190-MR-HS-R3MYB
		Absolute encoder, single turn	None	8148378	EMMT-AS-190-MR-HS-R3S
			With brake	8148381	EMMT-AS-190-MR-HS-R3SB
Long	High voltage, torque optimised	Absolute encoder, multi-turn	None	8148403	EMMT-AS-190-LR-HT-R3M
			With brake	8148406	EMMT-AS-190-LR-HT-R3MB
		Absolute multi-turn safety encoder, EnDat®	None	8148404	EMMT-AS-190-LR-HT-R3MY
			With brake	8148407	EMMT-AS-190-LR-HT-R3MYB
		Absolute encoder, single turn	None	8148402	EMMT-AS-190-LR-HT-R3S
			With brake	8148405	EMMT-AS-190-LR-HT-R3SB

Ordering data

EMMT-AS-190 with featherkey and radial shaft seal					
Length	Winding	Measuring unit	Brake	Part no.	Type
Medium	High voltage, standard	Absolute encoder, multi-turn	None	8148385	EMMT-AS-190-MKR-HS-R3M
			With brake	8148388	EMMT-AS-190-MKR-HS-R3MB
		Absolute multi-turn safety encoder, EnDat®	None	8148386	EMMT-AS-190-MKR-HS-R3MY
			With brake	8148389	EMMT-AS-190-MKR-HS-R3MYB
		Absolute encoder, single turn	None	8148384	EMMT-AS-190-MKR-HS-R3S
			With brake	8148387	EMMT-AS-190-MKR-HS-R3SB
Long	High voltage, torque optimised	Absolute encoder, multi-turn	None	8148409	EMMT-AS-190-LKR-HT-R3M
			With brake	8148412	EMMT-AS-190-LKR-HT-R3MB
		Absolute multi-turn safety encoder, EnDat®	None	8148410	EMMT-AS-190-LKR-HT-R3MY
			With brake	8148413	EMMT-AS-190-LKR-HT-R3MYB
		Absolute encoder, single turn	None	8148408	EMMT-AS-190-LKR-HT-R3S
			With brake	8148411	EMMT-AS-190-LKR-HT-R3SB

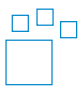
Ordering data – Modular product system					Link 
	Flange size, motors [mm]	Nominal torque	Part no.	Type	
	40 mm	0.21 ... 0.69 Nm	8171399	EMMT-...-40-	
	60 mm	0.56 ... 1.4 Nm	4808568	EMMT-AS-60-	
	80 mm	1.24 ... 3.4 Nm	4595815	EMMT-AS-80-	
	100 mm	4.8 ... 7.8 Nm	5185818	EMMT-AS-100-	

Accessories

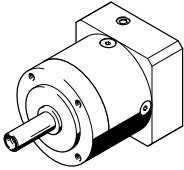
Planetary gearbox for EMMT-AS-40, EMMT-EC-40 Link emga					
	Gear unit ratio	Note on materials	Product weight	Part no.	Type
	3:1	RoHS-compliant	350 g	2297684	EMGA-40-P-G3-EAS-40
	5:1			2297685	EMGA-40-P-G5-EAS-40
	8:1			8141729	EMGA-40-P-G8-EAS-40
	12:1		450 g	8141730	EMGA-40-P-G12-EAS-40
	20:1			8141731	EMGA-40-P-G20-EAS-40

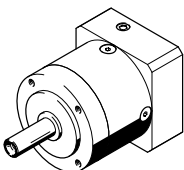
Planetary gear for EMMT-AS-60 Link emga					
	Gear unit ratio	Note on materials	Product weight	Part no.	Type
	3:1	RoHS-compliant	900 g	2297686	EMGA-60-P-G3-EAS-60
	5:1			2297687	EMGA-60-P-G5-EAS-60
	8:1			8141735	EMGA-60-P-G8-EAS-60
	12:1		1,100 g	8141736	EMGA-60-P-G12-EAS-60
	20:1			8141737	EMGA-60-P-G20-EAS-60

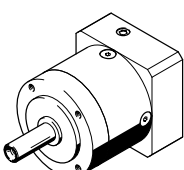
Planetary gear for EMMT-AS-80 Link emga					
	Gear unit ratio	Note on materials	Product weight	Part no.	Type
	3:1	RoHS-compliant	2,000 g	2297690	EMGA-80-P-G3-EAS-80
	5:1			2297691	EMGA-80-P-G5-EAS-80
	8:1			8141741	EMGA-80-P-G8-EAS-80
	12:1		2,500 g	8141742	EMGA-80-P-G12-EAS-80
	20:1			8141743	EMGA-80-P-G20-EAS-80

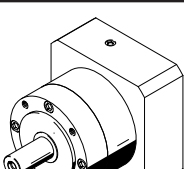
Planetary gear for EMMT-AS-100 Link emga					
	Gear unit ratio	Note on materials	Product weight	Part no.	Type
	3:1	RoHS-compliant	2,100 g	552194	EMGA-80-P-G3-SAS-100
			6,000 g	552196	EMGA-120-P-G3-SAS-100
	5:1		2,100 g	552195	EMGA-80-P-G5-SAS-100
			6,000 g	552197	EMGA-120-P-G5-SAS-100
	8:1		2,300 g	8141750	EMGA-80-P-G8-SAS-100
			6,000 g	8141753	EMGA-120-P-G8-SAS-100
	12:1		2,800 g	8141751	EMGA-80-P-G12-SAS-100
			8,000 g	8141754	EMGA-120-P-G12-SAS-100
	20:1		2,800 g	8141752	EMGA-80-P-G20-SAS-100
			8,000 g	8141755	EMGA-120-P-G20-SAS-100

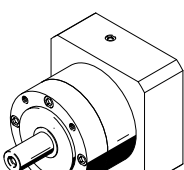
Planetary gear for EMMT-AS-150 Link emga					
	Gear unit ratio	Note on materials	Product weight	Part no.	Type
	3:1	RoHS-compliant	6,000 g	552196	EMGA-120-P-G3-SAS-100
				552198	EMGA-120-P-G3-SAS-140
	5:1		18,000 g	552200	EMGA-160-P-G3-SAS-140
			6,000 g	552199	EMGA-120-P-G5-SAS-140
			18,000 g	552201	EMGA-160-P-G5-SAS-140
			7,000 g	8141759	EMGA-120-P-G8-SAS-140
	12:1		9,000 g	8141760	EMGA-120-P-G12-SAS-140
	20:1			8141761	EMGA-120-P-G20-SAS-140

Accessories

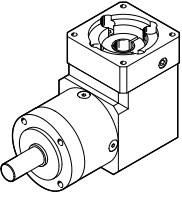
Angular gearbox for EMMT-AS-40, EMMT-EC-40 Link emga					
	Gear unit ratio	Note on materials	Product weight	Part no.	Type
	3:1	RoHS-compliant	500 g	8085342	EMGA-40-A-G3-40P
	5:1			8085343	EMGA-40-A-G5-40P
	8:1			8141732	EMGA-40-A-G8-40P
	12:1		8141733	EMGA-40-A-G12-40P	
	20:1		8141734	EMGA-40-A-G20-40P	

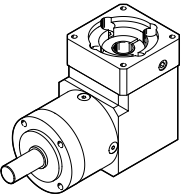
Angular gear for EMMT-AS-60 Link emga					
	Gear unit ratio	Note on materials	Product weight	Part no.	Type
	3:1	RoHS-compliant	1,700 g	8085344	EMGA-60-A-G3-60P
	5:1			8085345	EMGA-60-A-G5-60P
	8:1			8141738	EMGA-60-A-G8-60P
	12:1		8141739	EMGA-60-A-G12-60P	
	20:1		8141740	EMGA-60-A-G20-60P	

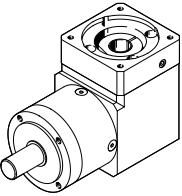
Angular gear for EMMT-AS-80 Link emga					
	Gear unit ratio	Note on materials	Product weight	Part no.	Type
	3:1	RoHS-compliant	4,300 g	8085346	EMGA-80-A-G3-80P
	5:1			8085347	EMGA-80-A-G5-80P
	8:1		4,400 g	8141744	EMGA-80-A-G8-80P
	12:1		5,000 g	8141745	EMGA-80-A-G12-80P
	20:1			8141746	EMGA-80-A-G20-80P

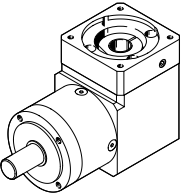
Angular gear for EMMT-AS-100 Link emga					
	Gear unit ratio	Note on materials	Product weight	Part no.	Type
	3:1	RoHS-compliant	4,500 g	8085348	EMGA-80-A-G3-100A
	5:1			8085349	EMGA-80-A-G5-100A
	8:1			8141747	EMGA-80-A-G8-100A
	12:1		5,100 g	8141748	EMGA-80-A-G12-100A
	20:1			8141749	EMGA-80-A-G20-100A

Radial shaft seal					
	Description ¹⁾	Note on materials	Part no.	Type	
	For flange size 40	RoHS-compliant		8193011	EASS-RS-T-A-4P-10-26-B7
	For flange size 60			8079786	EASS-RS-T-A-4P-15-30-B7
	For flange size 80, 100			8079785	EASS-RS-T-A-4P-20-40-B7
	For flange size 150			8154298	EASS-RS-T-A-4P-30-42-B7
	For flange size 190			8154299	EASS-RS-T-A-4P-40-55-B7

1) -Degree of protection to IP65 is achieved in combination with the sealing ring

-When using the radial shaft seal, a reduction (derating) of the nominal torque of 10% must be taken into account.

-The sealing ring must be replaced after a maximum of 5000 operating hours, subject to the operating conditions.

Accessories

Recommended cable cross-section as a function of cable length and servo drive CMMT-ST



- When using other servo drives, the max. cable lengths may be shorter or the cable cross-sections may be different
- For cable lengths over 10 m, prior technical clarification is recommended
- Motors with a holding brake require a logic power supply UB greater than 24 V DC. In this case, the recommended motor cables from Festo with the appropriate cross-sections should also be used
- This recommendation is made on the basis that the servo drive is connected to the supply network via a short connecting cable and network-side voltage drops can therefore be neglected

Motor cable with cable cross-section 1.5 mm² for servo drive CMMT-ST

[Link](#)

	Bending radius, moving cable	Cable characteristic	Ambient temperature	Cable length ¹⁾	Part no.	Type
	78.75 ... 81 mm	Suitable for energy chains	-40 ... 90 °C	0.5 ... 20 m	8181663	NEBM-LX/M17-
	81 mm			2.5 m	8234028	NEBM-M17G12-EH-2.5-Q9N-LE12
				5 m	8234029	NEBM-M17G12-EH-5-Q9N-LE12
				7.5 m	8234030	NEBM-M17G12-EH-7.5-Q9N-LE12
				10 m	8234031	NEBM-M17G12-EH-10-Q9N-LE12

1) For NEBM-LX/M17-...: selectable cable length: 0.5 ... 20 m, in detent 0.5 m.

Recommended cable cross-section as a function of cable length and servo drive CMMT-AS

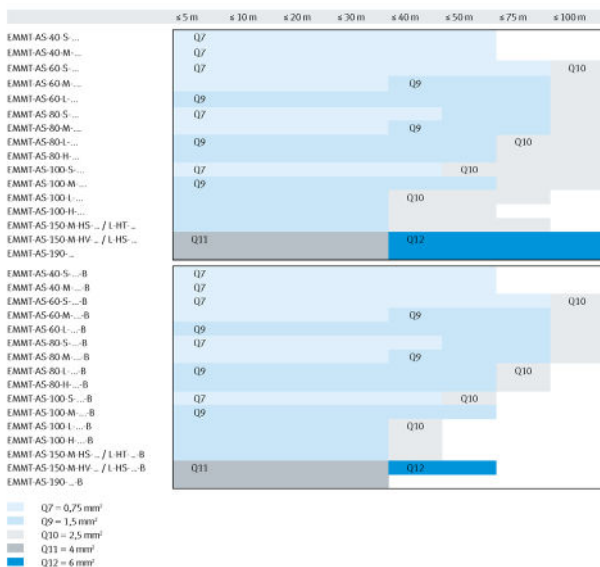

- When using other servo drives, the max. cable lengths may be shorter or the cable cross-sections may be different
- For cable lengths over 25 m, prior technical clarification is recommended
- Motors with a holding brake require a logic power supply UB greater than 24 V DC. In this case, the recommended motor cables from Festo with the appropriate cross-sections should also be used
- This recommendation is made on the basis that the servo drive is connected to the supply network via a short connecting cable and network-side voltage drops can therefore be ignored

Motor cable with cable cross-section 0.75 mm² for servo drive CMMT-AS

[Link](#)

	Bending radius, moving cable	Cable characteristic	Ambient temperature	Cable length ¹⁾	Part no.	Type
	90 mm	Suitable for energy chains	-40 ... 90 °C	0.5 ... 100 m	5251373	NEBM-M23G15-EH- -Q7N-R3LEG14
				2.5 m	5251374	NEBM-M23G15-EH-2.5-Q7N-R3LEG14
				5 m	5251375	NEBM-M23G15-EH-5-Q7N-R3LEG14
				7.5 m	5251376	NEBM-M23G15-EH-7.5-Q7N-R3LEG14
				10 m	5251377	NEBM-M23G15-EH-10-Q7N-R3LEG14
				15 m	5251378	NEBM-M23G15-EH-15-Q7N-R3LEG14

Accessories

Motor cable with cable cross-section 0.75 mm² for servo drive CMMT-AS

[Link !\[\]\(a3859c22c378670cd6224333e3c53990_img.jpg\)](#)

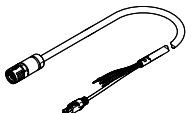
	Bending radius, moving cable	Cable characteristic	Ambient temperature	Cable length ¹⁾	Part no.	Type
	90 mm	Suitable for energy chains	-40 ... 90 °C	20 m	5251379	NEBM-M23G15-EH-20-Q7N-R3LEG14

1) Choice of cable lengths: 0.5 ... 99.9 m, in increments of 0.1 m.

Motor cable with cable cross-section 1.5 mm² for servo drive CMMT-AS

[Link !\[\]\(0d02338139225ba9482f9993590abfbe_img.jpg\)](#)

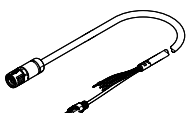
	Bending radius, moving cable	Cable characteristic	Ambient temperature	Cable length ¹⁾	Part no.	Type
	96 mm	Suitable for energy chains	-40 ... 90 °C	0.5 ... 100 m	5251380	NEBM-M23G15-EH- -Q9N-R3LEG14
				2.5 m	5251381	NEBM-M23G15-EH-2.5-Q9N-R3LEG14
				5 m	5251382	NEBM-M23G15-EH-5-Q9N-R3LEG14
				7.5 m	5251383	NEBM-M23G15-EH-7.5-Q9N-R3LEG14
				10 m	5251384	NEBM-M23G15-EH-10-Q9N-R3LEG14
				15 m	5251385	NEBM-M23G15-EH-15-Q9N-R3LEG14
				20 m	5251386	NEBM-M23G15-EH-20-Q9N-R3LEG14

1) Choice of cable lengths: 0.5 ... 99.9 m, in increments of 0.1 m.

Motor cable with cable cross-section 2.5 mm² for servo drive CMMT-AS

[Link !\[\]\(2ef0ac1b4a0cefb388277fc009172759_img.jpg\)](#)

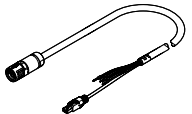
	Bending radius, moving cable	Cable characteristic	Ambient temperature	Cable length ¹⁾	Part no.	Type
	97.3 mm	Suitable for energy chains	-40 ... 90 °C	0.5 ... 100 m	5251387	NEBM-M23G15-EH- -Q10N-R3LEG14
				2.5 m	5251388	NEBM-M23G15-EH-2.5-Q10N-R3LEG14
				5 m	5251389	NEBM-M23G15-EH-5-Q10N-R3LEG14
				7.5 m	5251390	NEBM-M23G15-EH-7.5-Q10N-R3LEG14
				10 m	5251391	NEBM-M23G15-EH-10-Q10N-R3LEG14
				15 m	5251392	NEBM-M23G15-EH-15-Q10N-R3LEG14
				20 m	5251393	NEBM-M23G15-EH-20-Q10N-R3LEG14

1) Choice of cable lengths: 0.5 ... 99.9 m, in increments of 0.1 m.

Motor cable with cable cross-section 4 mm² for servo drive CMMT-AS

[Link !\[\]\(01d7fb8d27f9f3e64569f92a7dd4ffc2_img.jpg\)](#)

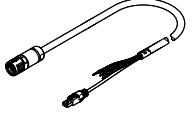
	Bending radius, moving cable	Cable characteristic	Ambient temperature	Cable length ¹⁾	Part no.	Type
	123 mm	Suitable for energy chains	-40 ... 90 °C	0.5 ... 100 m	5251394	NEBM-M40G15-EH- -Q11N-R3LEG14
				2.5 m	5251395	NEBM-M40G15-EH-2.5-Q11N-R3LEG14
				5 m	5251396	NEBM-M40G15-EH-5-Q11N-R3LEG14
				7.5 m	5251397	NEBM-M40G15-EH-7.5-Q11N-R3LEG14
				10 m	5251398	NEBM-M40G15-EH-10-Q11N-R3LEG14
				15 m	5251399	NEBM-M40G15-EH-15-Q11N-R3LEG14
				20 m	5251400	NEBM-M40G15-EH-20-Q11N-R3LEG14

1) Choice of cable lengths: 0.5 ... 99.9 m, in increments of 0.1 m.

Motor cable with cable cross-section 6 mm² for servo drive CMMT-AS

[Link !\[\]\(56e9d40ab6ed15d72d78c2990391f793_img.jpg\)](#)

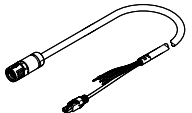
	Bending radius, moving cable	Cable characteristic	Ambient temperature	Cable length ¹⁾	Part no.	Type
	140.25 mm	Suitable for energy chains	-40 ... 90 °C	0.5 ... 100 m	5251401	NEBM-M40G15-EH- -Q12N-R3LEG14

1) Choice of cable lengths: 0.5 ... 99.9 m, in increments of 0.1 m.

Accessories

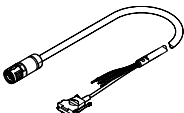
Motor cable with cable cross-section 0.75 mm ² for CMMP-AS servo drive Link nebm						
	Bending radius, moving cable	Cable characteristic	Ambient temperature	Cable length ¹⁾	Part no.	Type
	90 mm	Suitable for energy chains	-40 ... 90 °C	5 m	8190885	NEBM-M23G15-EH-5-Q7N-S1LEG21
				7.5 m	8190886	NEBM-M23G15-EH-7.5-Q7N-S1LEG21
				10 m	8190887	NEBM-M23G15-EH-10-Q7N-S1LEG21
	0.5 ... 99.9 m			8190874	NEBM-M23/40	
	90 ... 140.25 mm					

1) Choice of cable lengths: 0.5 ... 99.9 m, in increments of 0.1 m.

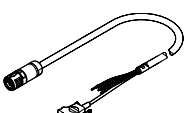
Motor cable with cable cross-section 1.5 mm ² for servo drive CMMP-AS Link nebm						
	Bending radius, moving cable	Cable characteristic	Ambient temperature	Cable length ¹⁾	Part no.	Type
	90 ... 140.25 mm	Suitable for energy chains	-40 ... 90 °C	0.5 ... 99.9 m	8190874	NEBM-M23/40
				5 m	8190888	NEBM-M23G15-EH-5-Q9N-S1LEG21
				7.5 m	8190889	NEBM-M23G15-EH-7.5-Q9N-S1LEG21
	10 m			8190890	NEBM-M23G15-EH-10-Q9N-S1LEG21	
	96 mm					

1) Choice of cable lengths: 0.5 ... 99.9 m, in increments of 0.1 m.

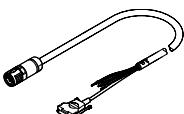
Motor cable with cable cross-section 4 mm ² for CMMP-AS Link nebm						
	Bending radius, moving cable	Cable characteristic	Ambient temperature	Cable length ¹⁾	Part no.	Type
	90 ... 140.25 mm	Suitable for energy chains	-40 ... 90 °C	0.5 ... 99.9 m	8190874	NEBM-M23/40

1) Choice of cable lengths: 0.5 ... 99.9 m, in increments of 0.1 m.

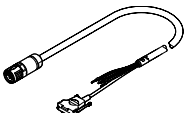
Motor cable with cable cross-section 6 mm ² for CMMP-AS Link nebm						
	Bending radius, moving cable	Cable characteristic	Ambient temperature	Cable length ¹⁾	Part no.	Type
	90 ... 140.25 mm	Suitable for energy chains	-40 ... 90 °C	0.5 ... 99.9 m	8190874	NEBM-M23/40

1) Choice of cable lengths: 0.5 ... 99.9 m, in increments of 0.1 m.

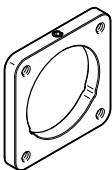
Mounting flange for fitting the motor cable plug (e.g. on the control cabinet) Link nebm			
	Note on materials ¹⁾	Part no.	Type
	RoHS-compliant	8201098	NEAM-MF-M23
		8201099	NEAM-MF-M40

1) This flange does not define an IP degree of protection for a control cabinet.