

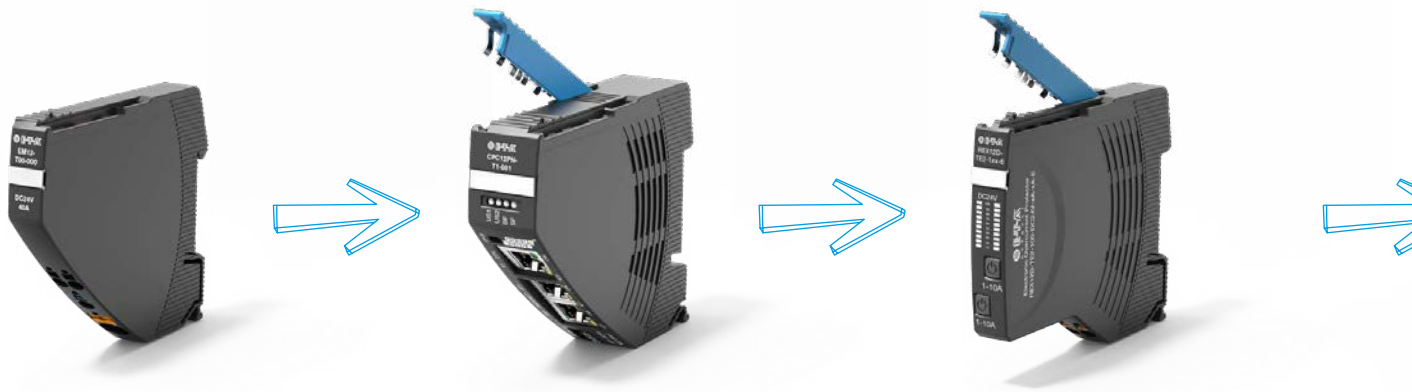

# THE REX SYSTEM

Your »All-in-one« solution



## SUPPLY

Supply in DC 24 V applications has never been so easy. Plus or minus supply, BASE or COM system - the EM12 modules are a vital part of the REX all-in-one solution. They are tailor-made to the requirements of the machine building industry and no further accessories, e.g. bridges or busbars, are required for the electrical or mechanical connection of the individual modules. This helps save components, time and money!

## BUS CONTROLLER

The CPC12 and EM12D **ControlPlex**® controllers connect the COM REX system with the superordinate communication interface. In addition to IO link and Modbus RTU, the interfaces for Ethernet based fieldbus connections via PROFINET, EtherCAT, Ethernet/IP and Modbus TCP are also possible. The bus controllers record all status information and measuring values of the circuit protectors and enable their control and parametrisation. With the CPC12 **ControlPlex**® controllers it is also possible to visualise data via the web server and use it as maintenance interface. A high transparency, clear troubleshooting and remote access increase machine uptime significantly.

## OVERCURRENT PROTECTION

Overcurrent protection with globally unique features, this is how the REX12 (time-current characteristic) and REX22D (situational active-linear current limitation) present themselves. Available with one or two channels, with fixed or adjustable current ratings, the devices are perfectly adaptable to the requirements of the respective application and can be easily connected electrically without further accessories, thanks to the integral blue connector arm. Whether BASE or COM system - with the REXx2D you can choose both options, as the circuit protectors automatically recognise the currently connected supply or bus controller.





## POWER DISTRIBUTION

The PM12-T potential distribution modules of the REX system can be divided into two main groups. In the same system, not only the +DC 24 V distribution, but also the minus distribution 0 V (GND) can be realised. The slim modules save space and enable direct assignment of the power distribution in a system. The direct assignment can be displayed effortlessly and functionally in the respective ePlan and supports wiring and troubleshooting.

## REX SYSTEM

E-T-A's compact and flexible REX system presents the comprehensive DC 24 V protection and power distribution solution for mechanical engineering under the headline »all in one«. It is a perfectly matched system, completely obtained from one source. Due to optimised functionalities, the product group requires amazingly few modules while offering considerable time and cost savings.

The REX system provides highest transparency and remote diagnostics with regard to the mechanical design and additionally through direct access to available detailed data of the DC 24 V power distribution. **This significantly increases machine availability.**

## YOUR BENEFITS

- **Increases machine uptime** – through clear troubleshooting, high transparency and remote diagnosis
- **Flexibility is ensured** – through easy assembly or disassembly, modular design and convenient adjustment
- **Saves min. 50 % time** – through innovative and flexible connection technology
- **Saves costs** - as no further accessories e.g. current bridges or busbars are required
- **Saves up to 65 % space** – with modules that are only 12.5 mm wide



# THE REX SYSTEM

## The supply modules

### The supply

The EM12 supply modules for the power input of the REX system are available in different versions, providing genuine flexibility with regard to costs and functionalities. Besides the conventional EM12-T01-... BASE supply modules with integral group fault signalling by means of a relay contact, there are also the EM12D-TIO-... for IO link and the EM12D-TMB-... for

Modbus RTU **ControlPlex**® COM supply modules. They provide a great amount of diagnostic information via the superordinate IO link or Modbus RTU master as a basis for targeted remote maintenance.

In addition, there are supply modules for further potential supplies. In this process the EM12-T00-100-... supply module connects all +DC 24 V points

of supply. The EM12-T00-200-... supply module serves as +DC 24 V disconnect terminal for the supply of e.g. DC 24 V voltages buffered by the DC intermediate circuit or as group supply point for safety related trips by means of an upstream safety switch-gear. The EM12-T supply modules for GND take up the 0 V potential and complete the supply.

COM **ControlPlex**®  BASE 



### YOUR BENEFITS

- EM12 supply modules ensure flexibility during the planning process.
- All BASE and COM supply modules are designed for a permanent total current of 40 A.
- The **COM ControlPlex**® supply modules increase transparency in the DC 24 V range significantly and form the basis for an additional increase of machine uptime.

## COM



**ControlPlex®**  
**EM12D-TIO-000-DC24V-40A**  
Supply module, IO link



**ControlPlex®**  
**EM12D-TMB-000-DC24V-40A**  
Supply module, Modbus RTU

## BASE / COM



**EM12-T00-000-DC24V-40A**  
Supply module, standard,  
without auxiliary contacts



**EM12-T00-200-LINE-40A**  
Supply module, centre,  
LINE separated



**EM12-T01-001-DC24V-40A**  
Supply module, standard,  
auxiliary contact N/O



**EM12-T00-000-GND-40 A**  
Supply module, standard,  
GND - 0 V



**EM12-T00-100-LINE-40A**  
Supply module, mid/right,  
LINE connected



**EM12-T00-300-GND-40 A**  
Supply module, mid/right,  
GND - 0 V



# THE REX-SYSTEM

## The bus-Controller



Web Server

Field bus connection

The **CPC12** bus controllers are connected with the EM12-T supply module. This enables an independent supply of the circuit protectors and also of the **ControlPlex**® controllers. The bus controllers record all status information and measuring values of the **REX12D** and **REX22D** BASE +COM circuit protectors and enable their control and parametrisation. With the **CPC12 ControlPlex**® controllers it is also possible to visualise data via the web server and use it as maintenance interface. A high transparency, clear troubleshooting and remote access increase machine uptime significantly.

The **CPC12 bus controller** offers a wealth of features: From the integral web server to the separate voltage supply.



COM ControlPlex®



**YOUR BENEFITS**

- Unrivalled machine uptime
- High transparency, clear troubleshooting and remote access via CPC12 increase machine uptime significantly
- The integral web server simplifies diagnosis during start-up and maintenance

# THE REX SYSTEM

## The overcurrent protection

### THE OVERCURRENT PROTECTION

The REX12 and REX22 electronic circuit protectors combine flexibility and compactness - whether single or double channel, fixed or adjustable current ratings, in BASE or COM system with IO link, Modbus RTU, PROFINET, EtherCAT, EtherNet/IP or Modbus TCP. REX, this means a space-saving and reliable protection, tailor-made for primary pulsed DC 24 V switch mode power supplies. The modules ensure a stable operation of switch mode power supplies, easy troubleshooting and a high

machine uptime. At the same time, no additional accessories are needed to connect the individual components electrically or mechanically.

The REX modules exactly meet the technical and economic requirements of the machine building industry. The UL-compliant circuit protectors are available in all standard fixed and adjustable current ratings from 1 A to 20 A. Up to 4 A current rating, the modules also meet the UL1310 requirement (NEC Class2 - Class 2 Power Unit).

The devices with fixed current ratings allow standard-compliant cable protection to EN60204-1 - even with small cable cross sections. The cable cross section is always adapted to the integral fail-safe element. The adjustable variants help to reduce the stock significantly and, in the case of variable load conditions, support flexible adjustment of the protection in a targeted manner, even without changing modules.



## REX12 BASE / COM ControlPlex®



**REX12D-TA1-10x-DC24V-xA**  
1-channelled,  
fixed current ratings 1 A to 10 A



**REX12D-TA2-10x-DC24V-xA/xA**  
2-channelled,  
fixed current ratings 1 A to 6 A



**REX12D-TB1-10x-DC24V-xA**  
1-channelled,  
fixed current ratings 1 A to 10 A,  
two load output terminals



**REX12D-TE2-10x-DC24V-xA-xA**  
2-channelled, manually adjustable or  
via communication, variable current  
ratings 1 A - 4 A (CL2), 1 A - 10 A

## REX12 BASE



**REX12-TA1-107-DC24V-xA**  
1-channelled,  
fixed current ratings 1 A to 10 A



**REX12-TA2-107-DC24V-xA/xA**  
2-channelled,  
fixed current ratings 1 A to 6 A



**REX12-TB1-107-DC24V-xA**  
1-channelled,  
fixed current ratings 1 A to 10 A,  
two load output terminals



## REX22 BASE / COM ControlPlex®



**REX22D-TA1-10x-DC24V-xA**  
1-channelled, fixed current rating  
12 A to 20 A situational active  
linear current limitation



**REX22D-TE2-10x-DC24V-xA-xA**  
2-channelled, manually adjustable  
or via communication, variable  
current ratings 1 A - 3.6 A (CL2),  
1 A - 10 A, situational active linear  
current limitation



**REX22D-TD1-10x-DC24V-xA/xA/xA**  
1-channelled, adjustable 3 posi-  
tion slide switch, variable current  
ratings 10 A to 20 A, situational  
active linear current limitation



**REX22D-TD2-10x-DC24V-xA-xA**  
2-channelled, adjustable 3 posi-  
tion slide switch, variable current  
ratings 1 A to 10 A, situational  
active linear current limitation



### YOUR BENEFITS

**Save costs, time and space.**

- The REX circuit protectors ensure a space-saving and reliable protection of primary pulsed DC 24 V switch mode power supplies
- The REX12D and REX22D modules support both the BASE as well as the COM mode and recognise the mode automatically
- The circuit protectors are available in fixed or adjustable current ratings



## THE REX-SYSTEM

### Difference between REX12 and REX22D

**The REX circuit protectors meet all technical and economic requirements of mechanical engineering.**

The REX12 modules are available in all standard fixed and adjustable current ratings from 1 A to 10 A. The REX22D circuit protectors can be selected with fixed current ratings of 12 A, 16 A and 20 A or with adjustable current ratings from 1 A to 20 A.

The time-current characteristic of the REX12 is characterised by its unbeatable cost efficiency and also provides effective selective overcurrent protection for many DC 24 V applications.

The REX12 thus achieves switch-on capacities of 20,000  $\mu\text{F}$ .

With the REX22D, the output current is actively limited when switching on current-intensive loads or in the event of a short circuit. In the event of a short-circuit, the limitation causes the max. current (I) to adjust to a defined value of the current rating for a time (t). Since the current flows quadratically into the calculation for the transition energy, one also speaks of

so-called “ $I^2t$  limiters”. This limitation makes effective protection possible even for switching power supplies with lower current reserves as well as long cable lengths with small cross-sections. In order to be able to switch on powerful loads effortlessly, the limited current can be made available situationally for a longer period of time. Switch-on capacities of  $\geq 40,000\mu\text{F}$  are thus no problem.

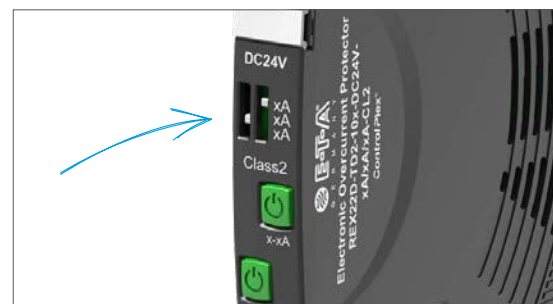
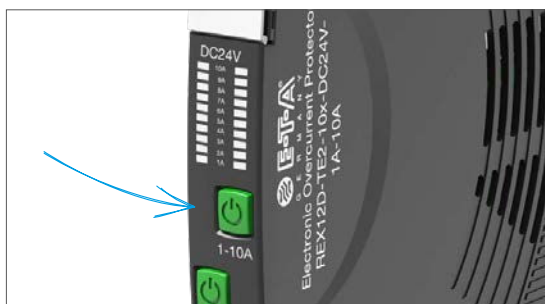
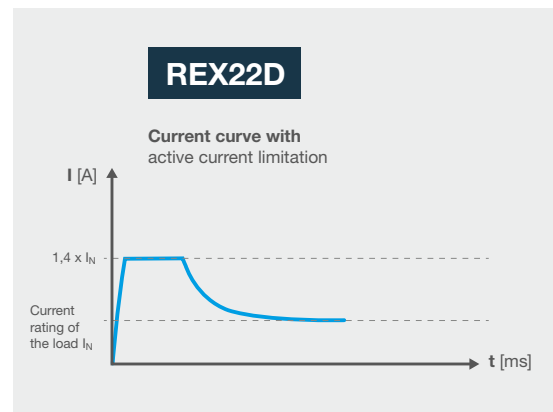
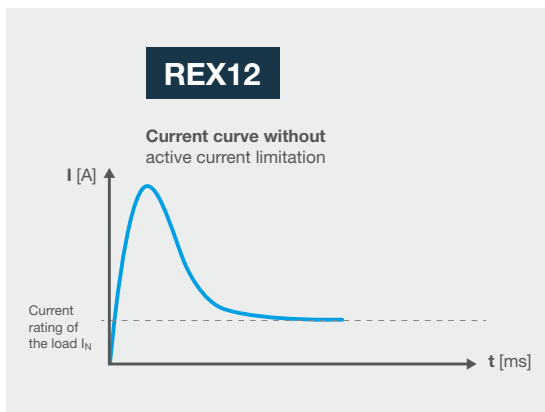

The current rating of the REX12D-TE2 / REX22D-TE2 circuit protectors can be parametrised and read directly on the device in BASE mode by pressing a button. The setting can also be done in COM mode via the control unit.

The current rating of the REX22D-TD can be adjusted and read directly on the device even in dead-voltage condition by means of a slide switch.

#### REX12 – AT A GLANCE

- Reduces downtimes through clear troubleshooting, high transparency and remote diagnosis
- Offers flexibility through adjustable and fixed current ratings
- Saves costs because no further accessories such as current bridges or busbars are required
- Saves space with modules that are only 12.5 mm wide and thus omission of additional minimum distances
- Offers flexibility through automatic recognition of the BASE or COM operating mode

#### REX22D – AT A GLANCE

- Offers all advantages of the REX12
- Increases transparency and flexibility through adjustable current ratings via slide
- Reduces the probability of failure due to the calculable limited max. current during current limitation
- Can be used for a wide range of applications - due to current ratings in the range of 1 A – 20 A



# THE REX SYSTEM

## Difference between REX12 and REX22D

| Type  | REX12  | REX22D  |
|---|--|---|
|   |                             |                                 |
| <b>Channels</b>                                       | 1 & 2  | 1 & 2   |
| <b>Current ratings</b>                                | 1 A - 10 A   | 1 A - 20 A  |
| <b>Trip curve</b>                                     | Time-current characteristics   | Situational active linear current limitation »I <sup>2</sup> t Limiter«   |
| <b>Comparable characteristic behaviour to the MCB</b> | B-C characteristic curve   | C-D characteristic curve  |
| <b>Current rating adjustment</b>                      | <ul style="list-style-type: none"> <li>• Fixed</li> <li>• Momentary switch</li> </ul>                        | <ul style="list-style-type: none"> <li>• Fixed</li> <li>• 3 position slide</li> <li>• Momentary switch</li> </ul> |
| <b>Capacitive load</b>                                | 20,000µF   | ≥40,000µF   |
| <b>Communication</b>                                  | <ul style="list-style-type: none"> <li>• Yes - ELBus® - COM - REX12D</li> <li>• No - BASE - REX12</li> </ul> | <ul style="list-style-type: none"> <li>• Yes - ELBus® - COM - REX22D</li> </ul>                                   |
| <b>Fail-safe element (Fuse)/Current rating</b>        | Yes, the fail safe element corresponds to the current rating   | Yes, the fail safe element is adjusted to the current rating  |
| <b>Ambient temperature</b>                            | -25 °C ... +60 °C  | -30 °C ... +60 °C   |
| <b>Typical 24 V DC loads</b>                          | Control technology, displays, magnetic valves, sensors, actuators  | In addition to REX12, modular drive controllers, FI control technology, multiphase motors, relay contacts         |

The REX12 and REX22D circuit protectors meet numerous approvals and are thus globally deployable!

Cable protection to  
EN60204-1



NEC Class2



## THE REX-SYSTEM

The power distribution

The power distribution module of the REX system can be divided into two main groups. In the same system, in addition to the +DC 24 V distribution, the minus distribution 0 V (GND) can also be realised. The new PM12-T modules for the + DC 24 V can be mounted side by side with the REX12 and REX22D electronic circuit protectors to be electrically connected to them. This increases the number of terminals, saves space and conventional distribution terminals are no longer required.

The EM12-T supply module for GND takes the 0 V potential, is connected to and multiplies it with the help of the attachable PM12-T for DC 0 V (GND). These components can also conveniently be connected and wired up. The distribution solution for DC 0 V is suitable for 40 A rated load. Rating of components is made easy for the design engineers. Complex design solutions to reduce cable cross sections from 10 mm<sup>2</sup> to 2.5 mm<sup>2</sup> belong to the past.



PM12-T01-00-LOAD potential module



PM12-T03-00-GND potential module



#### DC 24 V



**PM12-T01-00-LOAD-20 A**  
Potential module,  
10 terminals 2.5 mm<sup>2</sup>  
1 x line entry, 9 x LOAD+



**PM12-T02-00-LOAD-20 A**  
Potential module,  
10 terminals 2.5 mm<sup>2</sup>  
2 x supply separately,  
4 x LOAD+ each



#### 0 V (GND)



**PM12-T03-00-GND-20 A**  
Potential module,  
10 terminals 2.5 mm<sup>2</sup>



#### AT A GLANCE

- +DC 24 V distribution and minus distribution 0 V (GND) can be realised in the same system.
- The PM12-T distribution modules multiply the number of terminals while significantly cutting space requirements.

# THE REX-SYSTEM

Protection while keeping the standard firmly in view



The internal fail-safe element in the shape of a blade fuse is adapted directly to the current rating of the corresponding circuit protector, thus ensuring easy adjustment to the cable cross section.

Thus, the REX12... with 4 A contains a 4 A fuse to IEC 60127-4/2, UL248-14 and CSA248-14. Besides the UL508 and NEC Class2 approvals, the REX12 exclusively meets the requirements of cable protection to EN60204-1.

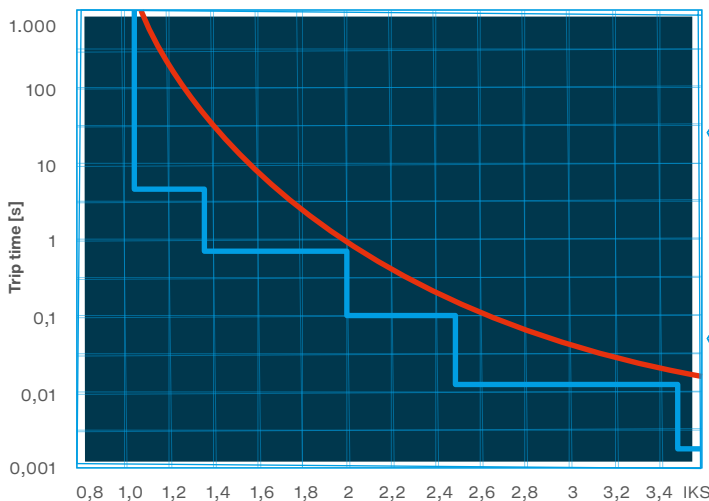

... times current rating/rated current // REX12 characteristic curve

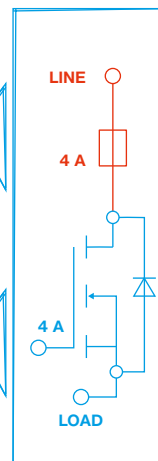

— Blade fuse  
— Semiconductor

Schematic diagram REX12 with fixed current ratings



Watch the REX12 video Adjustability

... or flexible adjustment via PROFINET, EtherCAT, EtherNet/IP, Modbus TCP, IO link, Modbus RTU or directly on the device

In COM mode, the adjustable solution can be realised quite simple using the existing **ControlPlex®** controllers and supply modules. In BASE mode, the current ratings are adjusted manually by touch contact. The REX22 modules offer the option to

make the adjustment via slide switch. This means, the user can very easily adjust the electronic circuit protectors to the corresponding load conditions of the application. This also helps reduce stock keeping costs significantly.



Adjustment of: Current ratings 1 A up to 10 A, 1 A to 4 A (Class2) and warning threshold 50 % to 100 %

# THE REX SYSTEM

## The application



To view product animation please scan the QR code!

Not only is the REX system easy to mount side by side, it also stands out for its flexibility when it comes to subsequent adjustments.

Individual protectors can effortlessly be replaced. Just open the left and

right connector arm of the circuit protector and remove the module in question. Put in a new module, close the connector arm, done! The REX system allows the customer to build up a very economic DC 24 V supply with a modular and cost-effective

protection and distribution solution. Without any connection accessories and with virtually no wiring effort.

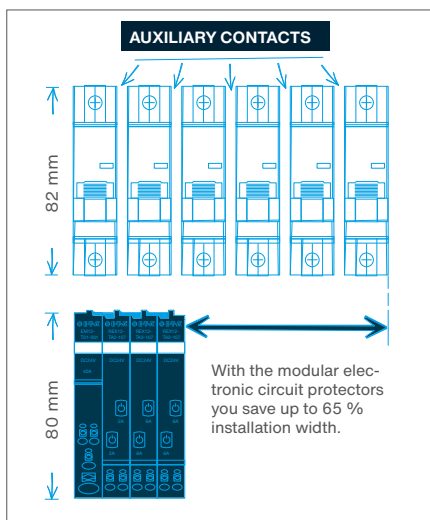

Corresponds to the wishes of many end customers: E-T-A electronic circuit protectors save space in the control cabinet.

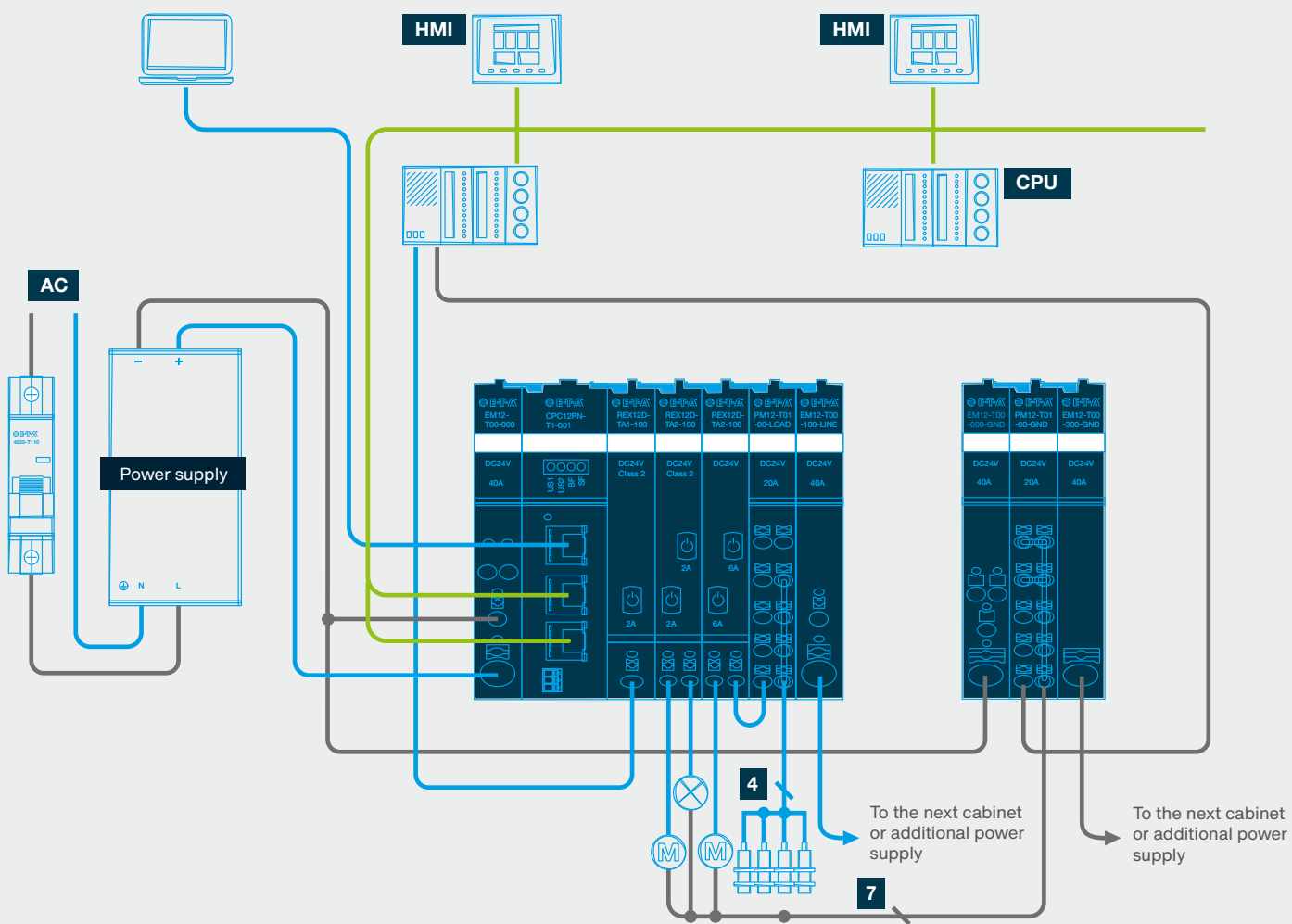









Also with  IO-Link and Modbus RTU connection



# PRODUCT RANGE

## REX system

| Type  |  | EM12-T  | EM12-T (GND)   | EM12D-T   |  |
|---|--|---|--|---|--|
|   |  |  |  |  |  |
| System Mode   | BASE   | ●   | ●  |   |  |
|   | COM  | ●   | ●  | ●   |  |
| Operating voltage range $U_B$   | DC 24 V (18 ... 30 V)  | ●   |  | ●   |  |
|   | DC 0 V (0 ... 30 V)  |   | ●  |   |  |
| Trip curve  | Time-current   |   |  |   |  |
|   | Current limitation   |   |  |   |  |
| Current rating $I_N$  | Fixed:   |   |  |   |  |
|   | Adjustable (Button+ COM)   |   |  |   |  |
|   | Adjustable (Slide switch)  |   |  |   |  |
| Fail-safe element (Blade fuse)  | Corresponds to $I_N$ (4 A electronics = 4 A fuse)                                |   |  |   |  |
|   | Adapted to $I_N$   |   |  |   |  |
| Warning:  | 90 % of $I_N$  |   |  |   |  |
|   | 50 % ...100 % of $I_N$ Adjustable  |   |  |   |  |
| Capacitive load   | $\geq 40,000 \mu\text{F}$  |   |  |   |  |
|   | $20,000 \mu\text{F}$   |   |  |   |  |
| Total current   | 40 A   | ●   | ●  | ●   |  |
|   | 20 A   |   |  |   |  |
| Signalling  | Multicoloured LED indication   |   |  | ●   |  |
|   | Potential-free auxiliary contact   | ●   |  |   |  |
| Communication   | IO link, Modbus-RTU  |   |  | ●   |  |
|   | PROFINET, EtherCAT, EtherNet/IP, Modbus TCP, web server, JSON                    |   |  |   |  |
| Temperature range   | -30 °C ... +60°C   | ●   | ●  |   |  |
|   | -25 °C ... +60°C   |   |  | ●   |  |
| Approvals   | UL2367   | ●   | ●  | ●   |  |
|   | UL508 listed   | ●   | ●  | ●   |  |
|   | UL1310, NEC Class2   |   |  |   |  |
|   | UL1059   |   |  |   |  |
|   | IEC/EN IEC 60079-0, IEC/EN IEC 60079-7, IEC/EN IEC 60079-15, IEC/EN IEC 60079-31 | ●   | ●  | ●   |  |
| Marking  | II 3G Ex ec IIC GC<br>II 3D Ex tc IIIB DC  | ●   | ●  | ●   |  |
| Max. system expansion   |  | 40 modules  | 40 modules   | 40 modules, 16 REX modules 16 or 32 REX channels (Observe IODD)                     |  |
| Combinable devices  | BASE   | ●   | ●  |   |  |
|   | COM - EM12D-T  | ●   | ●  | ●   |  |
|   | COM-CPC12  | ●   | ●  |   |  |

|  | CPC12   | REX12-T   | REX12D-T  | REX22D-T   | PM12-T  |
|--|---|---|---|--|---|
|  |  |  |  |  |  |
|  |   | ●   | ●   | ●  | ●   |
|  | ●   |   | ●   | ●  | ●   |
|  | ●   | ●   | ●   | ●  | ●   |
|  |   | ●   | ●   |  | ●   |
|  |   | ●   |   | ●  |   |
|  |   | ●   | ●   | ●  |   |
|  |   |   | ●   | ●  |   |
|  |   | ● I <sub>N</sub> fixed  | ● I <sub>N</sub> fixed  |  |   |
|  |   |   | ● I <sub>N</sub> adjustable   | ●  |   |
|  |   | ●   | ● BASE mode   |  |   |
|  |   |   | ● COM mode  | ● COM mode   |   |
|  |   | ●   |   | ●  |   |
|  |   | ●   | ●   |  | ●   |
|  | ●   | ●   | ●   | ●  |   |
|  | ●   |   |   | ●  |   |
|  | ●   | ●   | ●   | ●  |   |
|  | ●   | ●   | ●   | ●  |   |
|  |   | ● up to 4 A   | ● up to 4 A   | ● up to 3.6 A  |   |
|  | ●   |   |   | ●  | ●   |
|  | ●   |   |   | ●  | ●   |
|  | 40 modules,<br>16 REX modules<br>32 REX channels                                  |   |   |  |   |
|  |   | ●   | ●   | ●  | ●   |
|  |   |   | ●   | ●  | ●   |
|  | ●   |   | ●   | ●  | ●   |

# INDUSTRY 4.0 WITH THE REX SYSTEM

## Condition monitoring – Predictive maintenance

### E-T-A'S INTELLIGENT REX SYSTEM OFFERS

- Overcurrent protection
- Power distribution of load circuits
- Monitoring
- Parametrisation

The CPC12 **ControlPlex**® controllers and EM12D supply modules transmit various diagnostic information to the superordinate control unit. Including input voltage, load voltage, load current, limit values and various setting options for the circuit protector, such as current rating or limit value.



STATUS INDICATION



Status indication

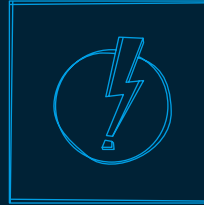

Short circuit

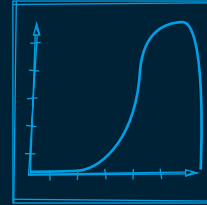

Overcurrent

DATA LOGGING

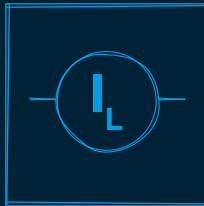

Load current

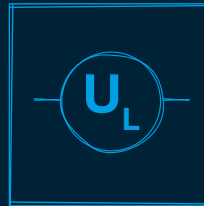

Load voltage

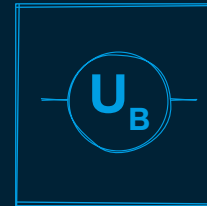

Input voltage

DATA ANALYSIS

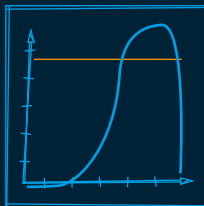

Limit value

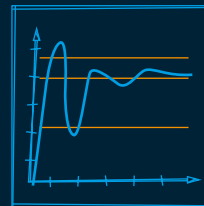

Current curve

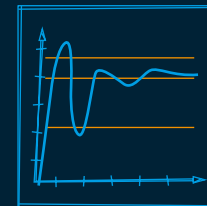

Voltage curve

CONTROL UNIT

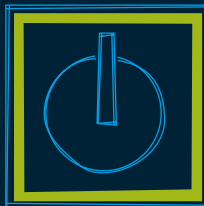

Control ON

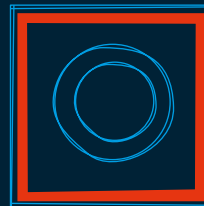

Control OFF

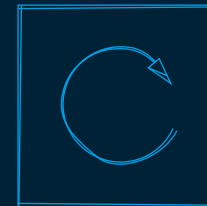

Control RESET

PARAMETRISATION

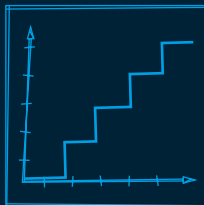

Current rating adjustment

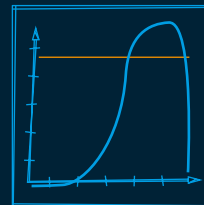

Limit value

**E-T-A ELEKTROTECHNISCHE APPARATE GMBH**

Industriestraße 2 – 8

90518 Altdorf

Tel. 09187 10-0

Fax 09187 10-397

Email: [info@e-t-a.de](mailto:info@e-t-a.de)

[global.e-t-a.com](http://global.e-t-a.com)