























TIRAS LED - NEÓN

TIRAS LED			
TIRAS LED AC 220V	6	12W RGB	46
TIRAS LED COB	7	PERFILES	47
COB-8W-IP20-24V MONOCOLOR	8	SENSORES	52
COB-15W-IP20-24V MONOCOLOR	9	NEÓN	
COB-CDC-16W-IP20-24V	10	NEÓN 1/2/3/4 - 24V	53
COB-RGB+CDC-16W-IP20-24V	11	TIRAS LED APTAS PARA NEONES 1-2-3 Y 4	58
COB-RGB-15W-IP20-24V	12	NEÓN 360°	60
COB-DIG-14W-IP20-24V PÍXEL	13	NEÓN EMPOTRAR	62
TIRAS LED SMD	15	FUENTES Y ACCESORIOS TIRAS LED	
4.8W-IP20-24V	16	CONECTORES 2 CONDUCTORES	63
PERIMETRAL-4,8W-IP20-24V	17	CONECTORES 3 Y 4 CONDUCTORES	64
Ultrafina-10W-IP20-24V	18	CONECTORES RÁPIDOS	65
CRI 95	20	JACK ALIMENTACIÓN	65
20W-IP20-24V	21	CONECTORES DE 2 Y 3 POLOS	66
26W-IP20-24V	22	CONECTORES DERIVACIÓN	66
26WDOBLE-IP20-24V	23	CABLES	67
CDC-12W-IP20-24V	24	FUENTES DE ALIMENTACIÓN PARA TIRAS DE LED	68
RGB+CDC-25.5W-IP20-24V	25	ACCESORIOS TIRAS DE LED	69
RGB-12W-IP20-24V	26	CONTROLADORES Y MANDOS R.F.	70
RGB+C /F-19.2W-IP20-24V	27	CONTROLADORES RGB Y TRIAC-AC	71
LED-PÍXEL-14,4W-IP20-24V	28	CONTROLADORES MONOCOLOR Y TRIAC-AC	72
HORTICULTURA	30	DIMMER MONOCOLOR	73
TIRAS LED IP	33	CONTROLADORES RGB Y TRIAC-AC	74
4,8W-IP65-24V	34	CONTROLADORES MONOCOLOR Y TRIAC-AC	75
12W-IP65-24V	35	CONTROLADORES DMX-DALI-KNX	76
12W-IP68-24V	36	CONTROLADORES DMX-0/1-10V	77
26W-IP65-24V	37	MANDO A DISTANCIA PASTILLA 0/1-10V	77
26WDOBLE-IP66-24V	38	CONTROLADORES DMX-DALI-KNX	78
RGB-12W-IP65-24V	39	CONTROLADORES 0/1-10V	80
RGB+C-19.2W-IP65-24V	40	CONTROLADORES DMX-DALI-KNX	81
RGB+F-19.2W-IP65-24V	40	CONTROLADORES PÍXEL-CV-PIR	82
LED-PÍXEL-14,4W-IP65-24V	41	AMPLIFICADOR SPI (TIRA LED DIGITAL)	83
TIRAS LED SMD 12V	43	AMPLIFICADORES, DECODIFICADOR Y MANDO	84
4,8W MONOCOLOR	44	CONTROLADORES ETHERNET	85
12W MONOCOLOR	45	PROGRAMADOR EDITOR-REPRODUCTOR	86
		CONTROLADOR PARA CHIPS	86

SIMBOLOGÍA

	IP20: protección contra cuerpos extraños de diámetro >12 mm. No protegido contra el agua.
	IP40: protección contra cuerpos extraños de diámetro >1 mm. No protegido contra el agua.
	IP44: protección contra cuerpos extraños diámetro >1 mm. Protegido contra agua desde cualquier dirección.
	IP54: protección completa contra contacto, protección contra sedimentaciones de polvo en el interior. Protegido contra agua proyectada desde cualquier dirección.
	IP65: protección completa contra contacto y contra penetración de polvo. Protegido contra chorros de agua desde cualquier dirección.
	IP66: protección completa contra contacto y contra penetración de polvo. Protegido contra fuertes chorros de agua desde cualquier dirección.
	IP67: protección completa contra contacto y contra penetración de polvo. Protegido contra los efectos por inmersión temporal en agua.
	IP68: Protección total contra el polvo y permite la inmersión prolongada en agua a una profundidad específica
	CRI>80: mínimo exigido por las normativas europeas para vender un producto de uso interior.
	CRI95: reproducción cromática muy alta, que permiten reproducir los colores de forma muy realista.
	CE: simboliza que el producto está Certificado y cumple las normativas exigidas por la Comunidad Europea.
	ROHS: Normativa de Restricción de ciertas Sustancias Peligrosas en aparatos eléctricos y electrónicos, tales como Plomo y otros materiales nocivos para el medioambiente y el hombre.

	MacAdam 3-STEP: uniformidad en la luz de los diferentes leds que conforman la tira
	UL: cumple los requisitos de seguridad de UL y que el fabricante asegura que el producto siga cumpliendo con esos requisitos.
	Símbolo apertura 120º o 180º. Nos indica el grado de apertura de cada tira de led.
	Nos indica la unidad mínima de corte en esa tira.
	Nos indica la cantidad de leds que contiene un metro de tira de led.
	Productos de bajo consumo y alta eficiencia
	WIFI: posibilidad de controlar este producto mediante WIFI (móvil-tablet-ordenador)
	Clase II: aparato con doble aislamiento eléctrico, que ha sido diseñado de tal forma que no requiere una toma a tierra de seguridad. El requisito básico es que un fallo simple no puede dar lugar a tensiones peligrosas que podrían causar una descarga eléctrica y que esto se logre sin depender de una caja metálica conectada a tierra. Se consigue normalmente con dos capas de material aislante que rodean las partes con tensiones peligrosas o utilizando un aislamiento reforzado.
	F.P (Factor Corrector de Potencia): es la relación entre la Potencia Activa y la Potencia Aparente, por este motivo cuanto mejor es el PFC menor es su consumo interno. Cuanto más cercano a 1 sea este valor, significa que la fuente para generar su potencia total necesita menos consumo interno y el consumo final del conjunto es menor. Si una fuente no tiene un buen PFC, por lo normal, tampoco tendrá un buen comportamiento en Armónicos.

IMPORTANTE:
Ninguna tira /perfil de corte admite devolución.

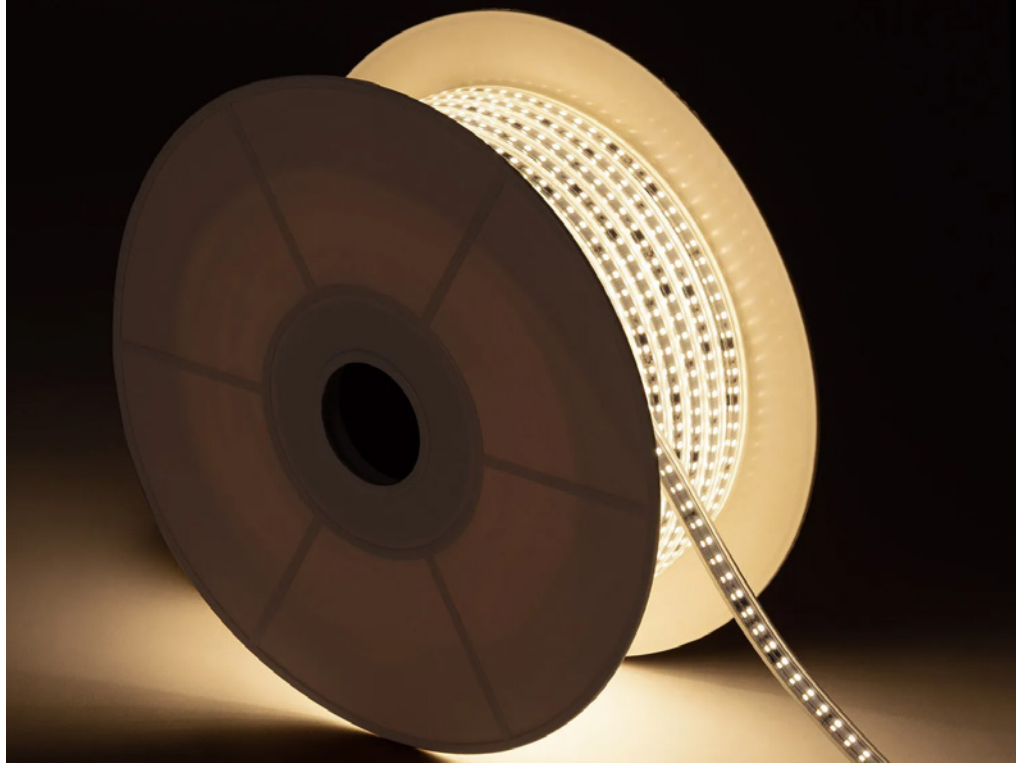



- 2700K
- Cálido
- Neutro
- Frío

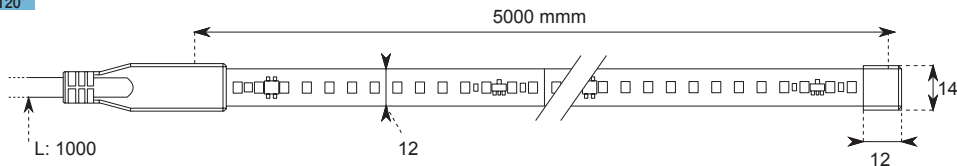

140 LEDs/metro	Acabado	lm/m	P.V. ● 50 m	P.V. ✂ 1m
AC220V-18W-IP65-2700K	● Cálido	1940 lm/m	850,00 €	18,40 €
AC220V-18W-IP65-3K	● Cálido	2070 lm/m	850,00 €	18,40 €
AC220V-18W-IP65-4K	● Neutro	2156 lm/m	850,00 €	18,40 €
AC220V-18W-IP65-6K	● Frío	2113 lm/m	850,00 €	18,40 €

	P.V.
AC220V-MPC Manipulación y corte tira LED 220V: Soldadura + 1 metro de cable	11,00 €



Kit cable alimentación (1 metro con fusible y tapa)

Ref.	P.V.
AC220V-ALI	9,60 €



Tapa de silicona

Ref.	P.V.
AC220V-TAPA	0,60 €



Kit grapas y tornillos

Ref.	P.V.
AC220V-GRF	1,90 €



Funda de silicona

Ref.	P.V.
AC220V-FUNDA	0,90 €



PCB protección cortocircuito y sobretensiones

Ref.	P.V.
AC220V-FUSIBLE	4,60 €

Pegamento de silicona



Ref.	P.V.
AC220V-SILICONA	4,70 €

Para mejorar la disipación debe utilizarse perfil o pletina de aluminio

TIRAS LED COB

- Mayor densidad LED/m, hasta 840 leds/m
- Mayor luminosidad / W
- Iluminación continua "sin puntitos"

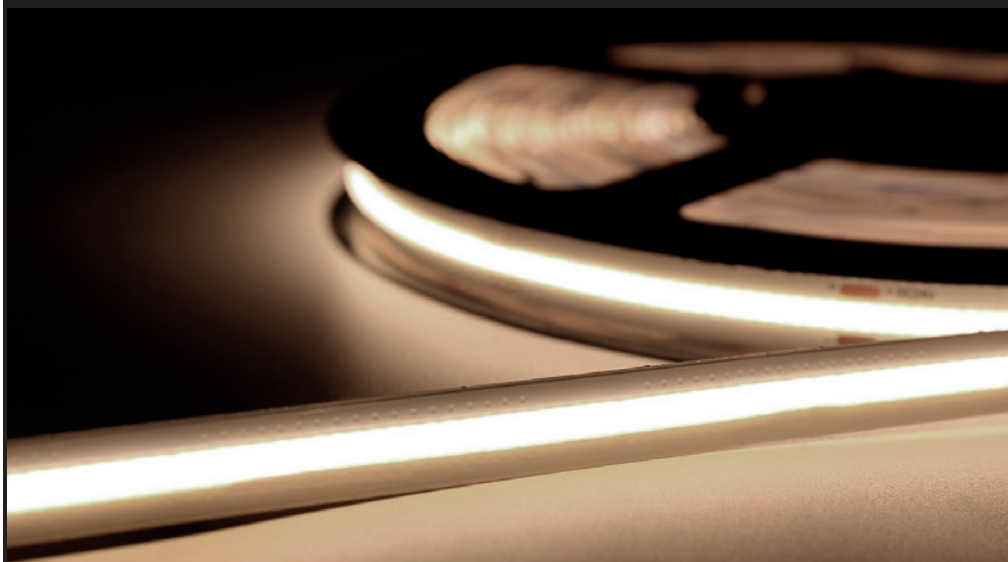



● Cálido

● Neutro

● Frío

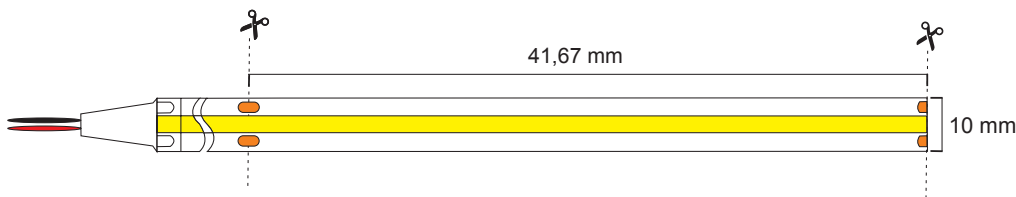

504 LEDs/metro	Acabado	lm/m	P.V. ● 20 m	P.V. ✂ 1m
COB-8W-IP20-24V-3K	● Cálido	900 lm/m	77,80 €	6,30 €
COB-8W-IP20-24V-4K	● Neutro	923 lm/m	77,80 €	6,30 €
COB-8W-IP20-24V-6K	● Frío	950 lm/m	77,80 €	6,30 €

Manipulación: Soldadura + 1 metro de cable	P.V.
	3,50 €

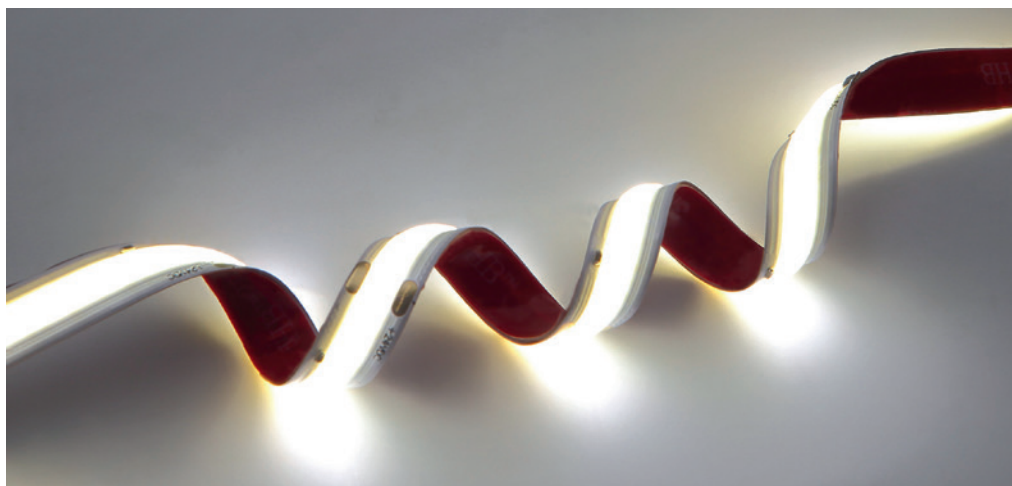

Para mejorar la disipación debe utilizarse perfil o pletina de aluminio



- Cálido
- Neutro
- Frío

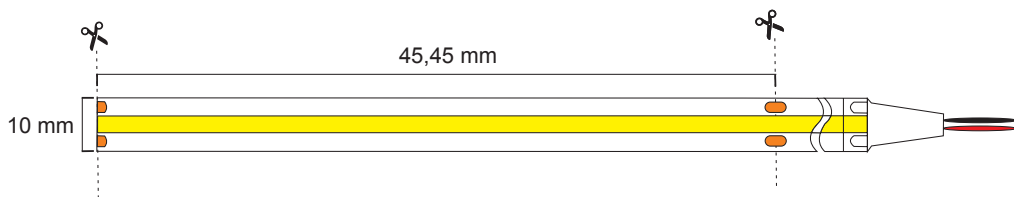

528 LEDs/metro	Acabado	lm/m	P.V. ● 10 m	P.V. ✂ 1m
COB-15W-IP20-24V-3K	● Cálido	1500 lm/m	98,80 €	11,80 €
COB -15W-IP20-24V-4K	● Neutro	1575 lm/m	98,80 €	11,80 €
COB -15W-IP20-24V-6K	● Frío	1650 lm/m	98,80 €	11,80 €

	P.V.
Manipulación: Soldadura + 1 metro de cable	3,50 €

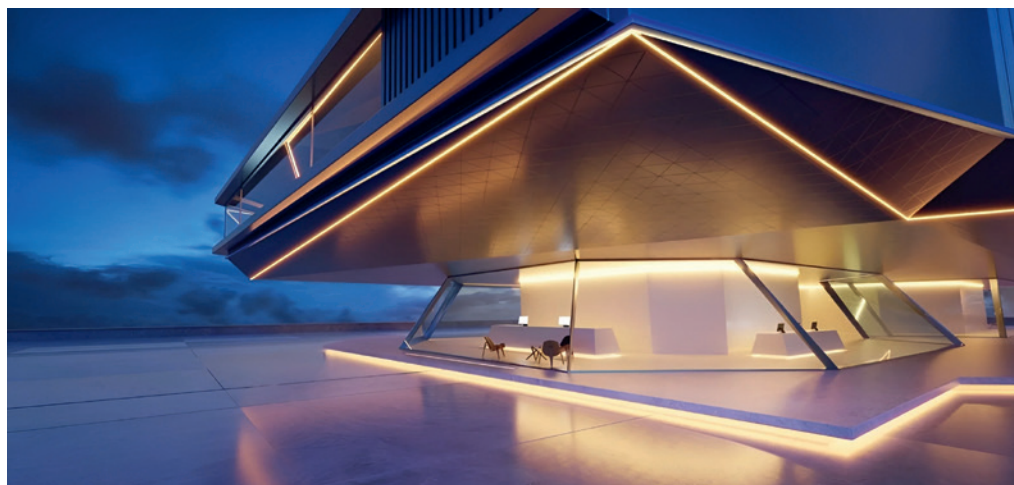

Para mejorar la disipación debe utilizarse perfil o pletina de aluminio



- Cálido
- Neutro
- Frío

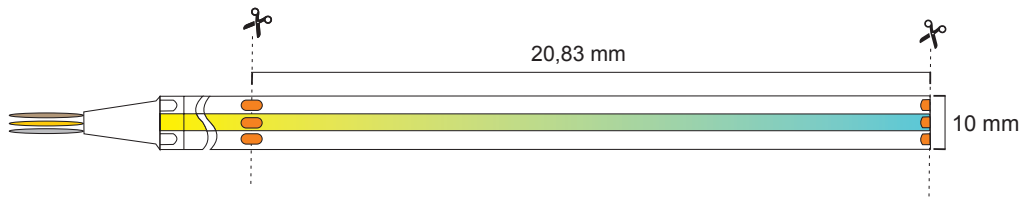

640 LEDs/metro	Acabado	lm/m	P.V. ● 10 m	P.V. ✂ 1m
COB-CDC-16W-IP20-24V	● ● ●	1760 lm/m	160,80 €	19,80 €

Manipulación: Soldadura + 1 metro de cable	P.V.
	5,50 €



Para mejorar la disipación debe utilizarse perfil o pletina de aluminio

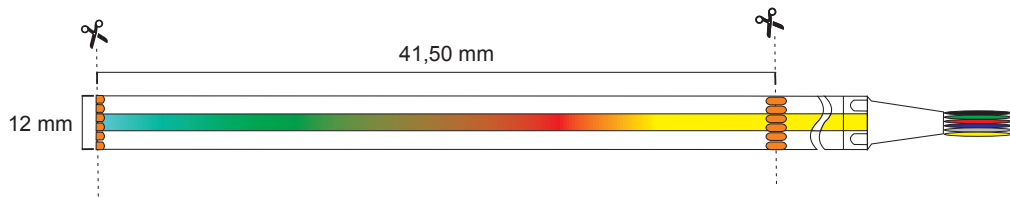

840 LEDs/metro	Acabado	lm/m	P.V. ● 10 m	P.V. ✂ 1m
COB-RGB+CDC-16W-IP20-24V		1700 lm/m	174,40 €	21,00 €

	P.V.
Manipulación: Soldadura + 1 metro de cable	5,50 €



Para mejorar la disipación debe utilizarse perfil o pletina de aluminio

COB RGB

IP 20 **W 15** **640 led/m** **CRI >80** **50 mm** **24V** **110 lm/W** **3 AÑOS DE GARANTÍA** **CE** **RoHS** **MacAdam 3-STEP**

RGB

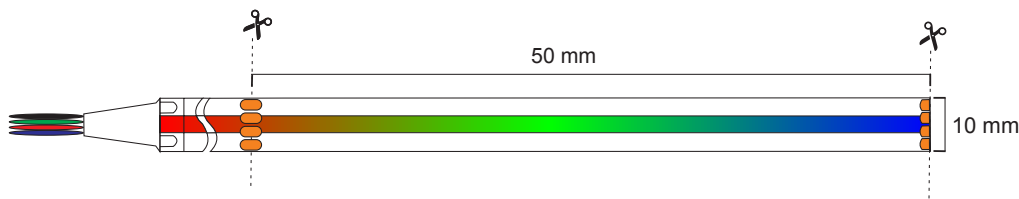

640 LEDs/metro	Acabado	lm/m	P.V. 10 m	P.V. 1m
COB-RGB-15W-IP20-24V	RGB	1500 lm/m	143,60 €	18,00 €

Manipulación: Soldadura + 1 metro de cable	P.V.
	5,50 €



Para mejorar la disipación debe utilizarse perfil o pletina de aluminio

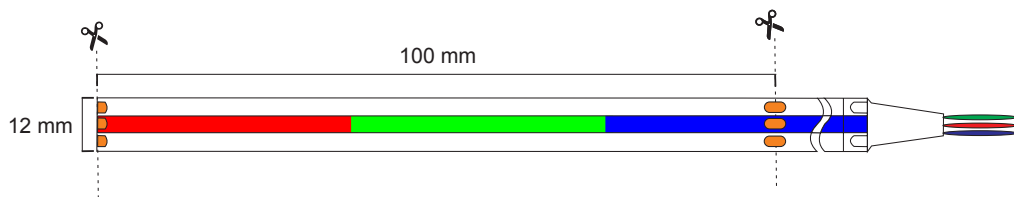

670 LEDs/metro	Acabado	lm/m	P.V. ● 10 m	P.V. ✂ 1m
COB-DIG-14W-IP20-24V	PÍXEL	1500 lm/m	143,60 €	19,00 €

Manipulación: Soldadura + 1 metro de cable	P.V.
	5,50 €



Para mejorar la disipación debe utilizarse perfil o pletina de aluminio



TIRAS LED SMD



● Cálido

● Neutro

● Frío

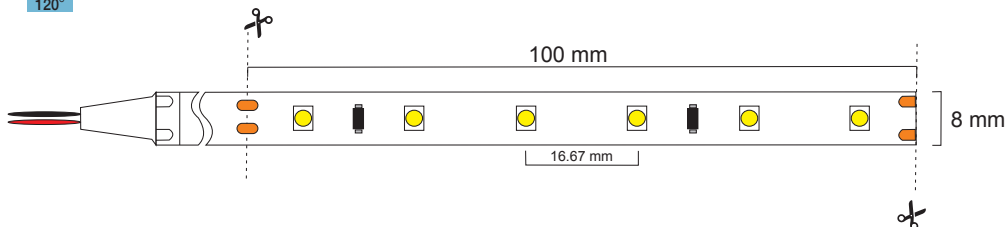

60 LEDs/metro	Acabado	lm/m	P.V. ● 50 m	P.V. ● 5 m	P.V. ✂ 1m
4.8W-IP20-24V-3K	● Cálido	395 lm/m	192,00 €	21,95 €	5,90 €
4.8W-IP20-24V-4K	● Neutro	417 lm/m	192,00 €	21,95 €	5,90 €
4.8W-IP20-24V-6K	● Frío	454 lm/m	192,00 €	21,95 €	5,90 €

P.V.

Manipulación: Soldadura + 1 metro de cable

3,50 €



Para mejorar la disipación debe utilizarse perfil o pletina de aluminio

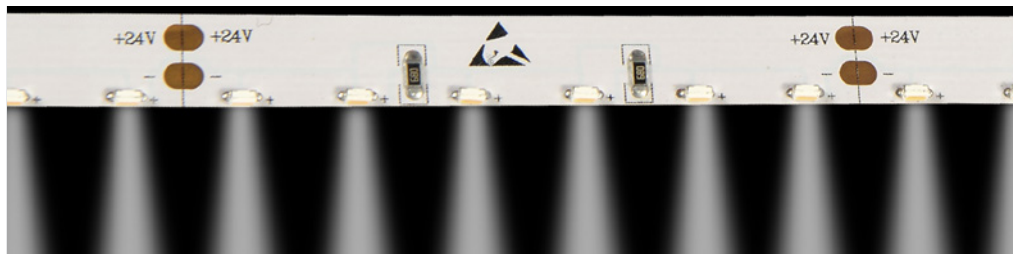

● Neutro



60 LEDs/metro

PERIMETRAL-4.8W-IP20-24V-4K

LED SMD 335

Acabado

● Neutro

P.V. ● 5 m

43,20 €

P.V. ✂ 1m

11,20 €

P.V.

Manipulación: Soldadura + 1 metro de cable

3,50 €



Para mejorar la disipación debe utilizarse perfil o pletina de aluminio

ULTRAFINA MONOCOLOR



● Cálido

● Neutro

● Frío

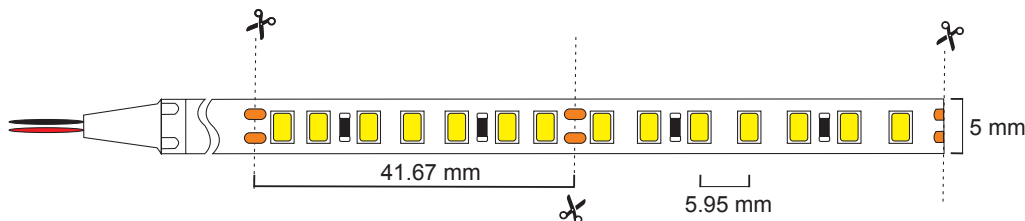

168 LEDs/metro	Acabado	lm/m	P.V. ● 20 m	P.V. ✂ 1m
ULTRAFINA-10W-IP20-24V-3K	● Cálido	1000 lm/m	138,40 €	10,34 €
ULTRAFINA-10W-IP20-24V-4K	● Neutro	1050 lm/m	138,40 €	10,34 €
ULTRAFINA-10W-IP20-24V-6K	● Frío	1050 lm/m	138,40 €	10,34 €

	P.V.
Manipulación: Soldadura + 1 metro de cable	3,50 €



Para mejorar la disipación debe utilizarse perfil o pletina de aluminio



- 1700K
- 2700K
- Cálido
- Neutro
- Frio

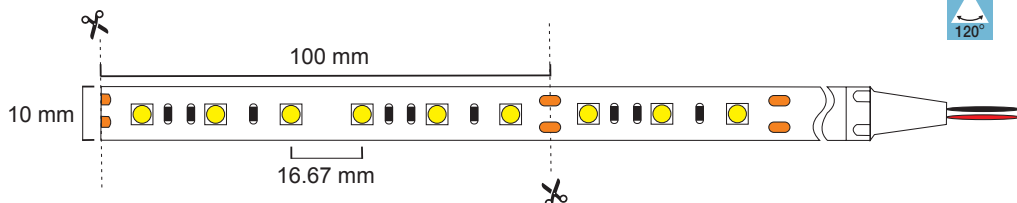

70 LEDs/metro	Acabado	lm/m	P.V. ● 50 m	P.V. ● 5 m	P.V. ✂ 1m
12W-IP20-24V-1700K	● 1700K	1080 lm/m	284,00 €	29,90 €	9,50 €
12W-IP20-24V-2700K	● 2700K	1195 lm/m	226,00 €	25,00 €	8,50 €
12W-IP20-24V-3K	● Cálido	1195 lm/m	226,00 €	25,00 €	8,50 €
12W-IP20-24V-4K	● Neutro	1224 lm/m	226,00 €	25,00 €	8,50 €
12W-IP20-24V-6K	● Frio	1224 lm/m	226,00 €	25,00 €	8,50 €

P.V.
Manipulación: Soldadura + 1 metro de cable 3,50 €



Para mejorar la disipación debe utilizarse perfil o pletina de aluminio



- Cálido
- Neutro
- Frío

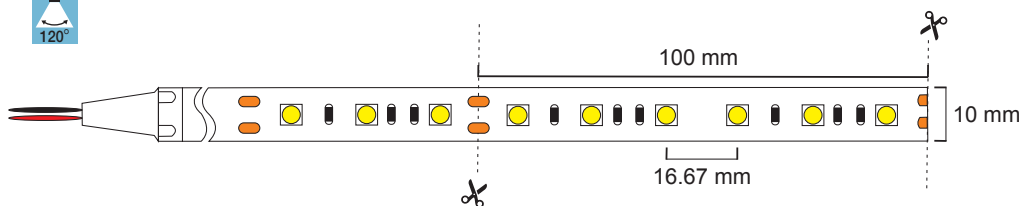

60 LEDs/metro	Acabado	lm/m	P.V. ● 50 m	P.V. ● 10 m	P.V. ✂ 1m
CRI95-7.6W-IP20-24V-3K	● Cálido	764 lm/m	389,00 €	76,80 €	11,22 €
CRI95-7.6W-IP20-24V-4K	● Neutro	778 lm/m	389,00 €	76,80 €	11,22 €
CRI95-7.6W-IP20-24V-6K	● Frío	792 lm/m	389,00 €	76,80 €	11,22 €

60 LEDs/metro	Acabado	lm/m	P.V. ● 50 m	P.V. ✂ 1m
CRI95-12W-IP20-24V-3K	● Cálido	1064 lm/m	389,00 €	11,22 €
CRI95-12W-IP20-24V-4K	● Neutro	1078 lm/m	389,00 €	11,22 €
CRI95-12W-IP20-24V-6K	● Frío	1092 lm/m	389,00 €	11,22 €

P.V.

Manipulación: Soldadura + 1 metro de cable

3,50 €

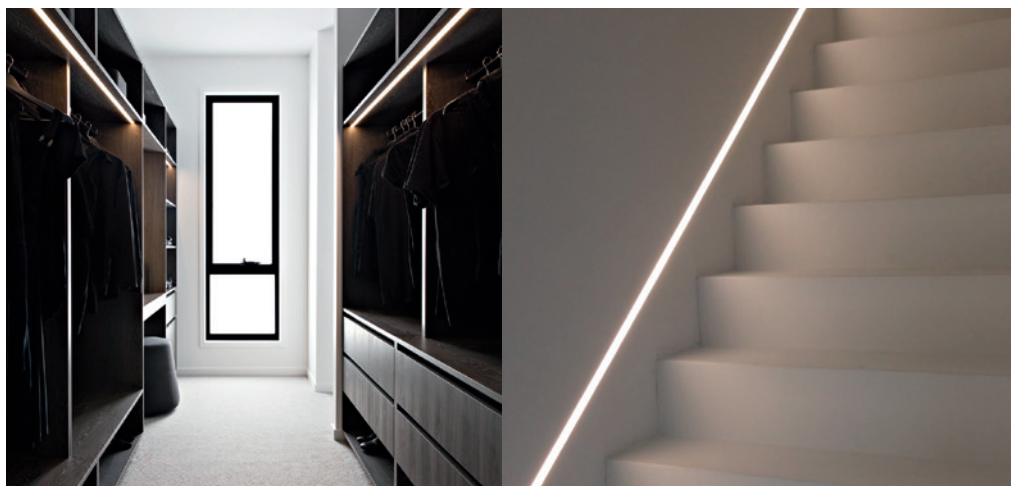

Para mejorar la disipación debe utilizarse perfil o pletina de aluminio



- Cálido
- Neutro
- Frío

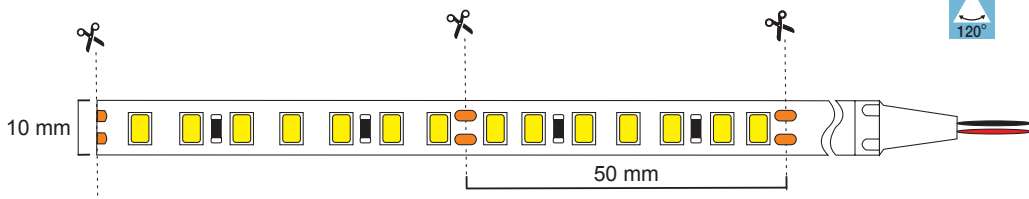

140 LEDs/metro	Acabado	lm/m	P.V. ● 50 m	P.V. ✂ 1m
20W-IP20-24V-3K	● Cálido	2200 lm/m	346,00 €	10,60 €
20W-IP20-24V-4K	● Neutro	2250 lm/m	346,00 €	10,60 €
20W-IP20-24V-5K	● Frío	2300 lm/m	346,00 €	10,60 €

Manipulación: Soldadura + 1 metro de cable	P.V. 3,50 €
--	----------------



Para mejorar la disipación debe utilizarse perfil o pletina de aluminio



- Cálido
- Neutro
- Frío

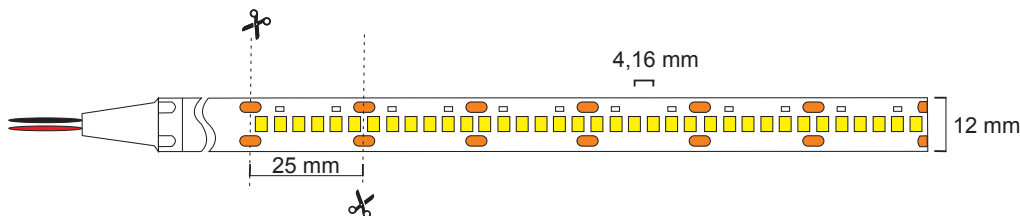

240 LEDs/metro	Acabado	lm/m	P.V. ● 50 m	P.V. ● 5 m	P.V. ✂ 1m
26W-IP20-24V-3K	● Cálido	2340 lm/m	650,00 €	68,90 €	17,74 €
26W-IP20-24V-4K	● Neutro	2418 lm/m	650,00 €	68,90 €	17,74 €
26W-IP20-24V-6K	● Frío	2418 lm/m	650,00 €	68,90 €	17,74 €

P.V.

Manipulación: Soldadura + 1 metro de cable 3,50 €



Para mejorar la disipación debe utilizarse perfil o pletina de aluminio



- Cálido
- Neutro
- Frío

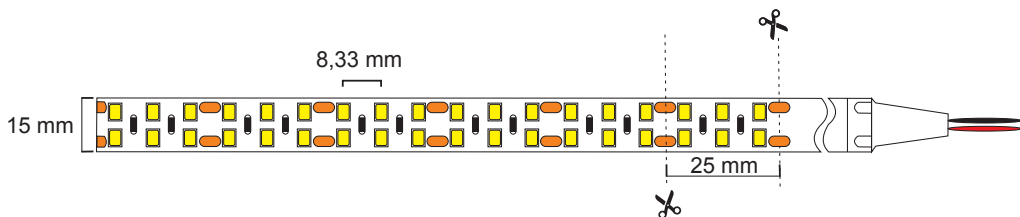

240 LEDs/metro	Acabado	lm/m	P.V. ● 5 m	P.V. ✂ 1m
26WDOBLE-IP20-24V-3K	● Cálido	2880 lm/m	75,08 €	17,74 €
26WDOBLE-IP20-24V-4K	● Neutro	2976 lm/m	75,08 €	17,74 €
26WDOBLE-IP20-24V-6K	● Frío	2976 lm/m	75,08 €	17,74 €

Manipulación: Soldadura + 1 metro de cable	P.V. 3,50 €
--	----------------



Para mejorar la disipación debe utilizarse perfil o pletina de aluminio

TIRAS CDC

IP 20	W 12	120 led/m	CRI >80	10 cm	24V	80 lm/W	3 AÑOS DE GARANTÍA	CE	RoHS	MacAdam 3-STEP
-----------------	----------------	---------------------	-------------------	-----------------	------------	-------------------	---------------------------	-----------	-------------	-----------------------

● Cálido	2700K	6W	468lm
● Neutro	Mixta 4000K	Máx. 12W	968lm
● Frío	6500K	6W	468lm

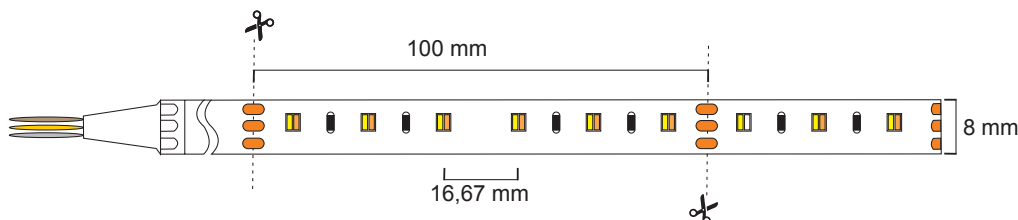

120 LEDs/metro	Acabado	P.V. ● 5 m	P.V. ✂ 1m
CDC-12W-IP20-24V	● ● ●	73,20 €	21,20 €
Manipulación: Soldadura + 1 metro de cable			P.V. 3,50 €



Para mejorar la disipación debe utilizarse perfil o pletina de aluminio



Rojo	4,1W	109,3lm
Verde	4,9W	323,5lm
Azul	4,7W	57,9lm
Blanco cálido	6,1W	635,5lm
Blanco frío	6,2W	703,8lm
Mixto	25,5W	1742,4lm

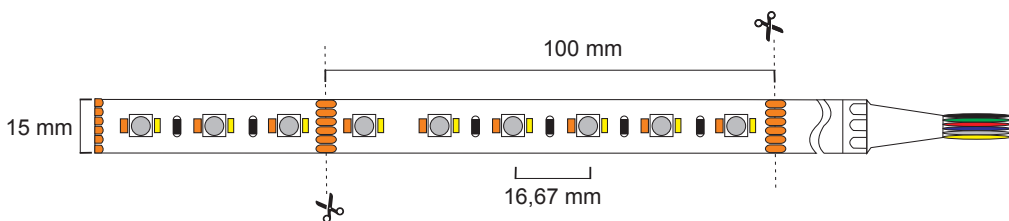

180 LEDs/metro

RGB+CDC-25,5W-IP20-24V



W/m

25,5 W/m

P.V. 5 m

76,20 €

P.V. 1m

23,20 €

Manipulación: Soldadura + 1 metro de cable

P.V.

3,50 €



Para mejorar la disipación debe utilizarse perfil o pletina de aluminio



RGB	Rojo	4,2W	97lm
	Verde	4,2W	246lm
	Azul	4,2W	42lm
	Mixto	12W	432lm

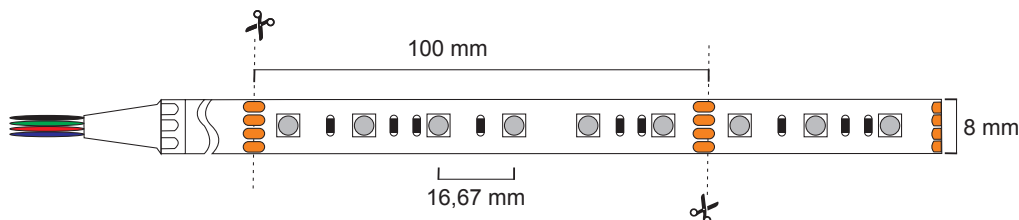

60 LEDs/metro	Acabado	P.V. ● 50 m	P.V. ● 5 m	P.V. ✂ 1m
RGB-12W-IP20-24V	RGB	380,00 €	36,20 €	8,55 €

Manipulación: Soldadura + 1 metro de cable	P.V.
	5,5 €



Para mejorar la disipación debe utilizarse perfil o pletina de aluminio



Rojo	4,8W	53lm
Verde	4,8W	149lm
Azul	4,8W	26lm
Blanco	4,8W	612lm
Mixto	19,2W	763lm

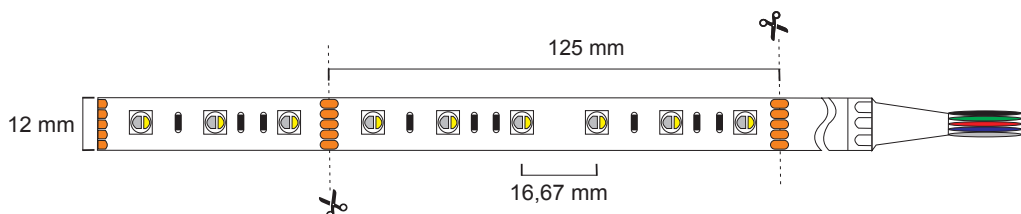
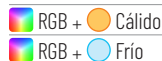

60 LEDs/metro	Acabado	P.V. ● 50 m	P.V. ● 5 m	P.V. ✂ 1m
RGB+C-19.2W-IP20-24V	RGB + Cálido	624,00 €	62,40 €	19,00 €
RGB+F-19.2W-IP20-24V	RGB + Frío	624,00 €	62,40 €	19,00 €

Manipulación: Soldadura + 1 metro de cable	P.V.
	5,5 €



Para mejorar la disipación debe utilizarse perfil o pletina de aluminio

PÍXEL



PÍXEL

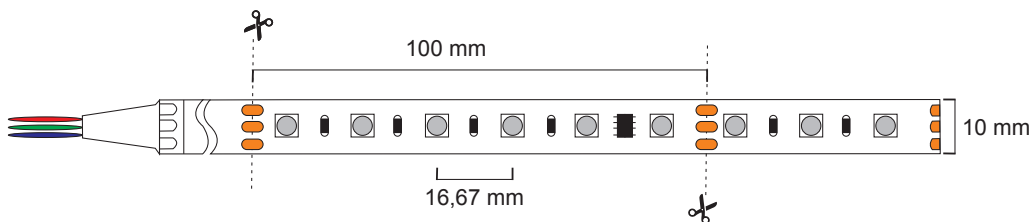

60 LEDs/metro	Acabado	W/m	P.V. ● 5 m	P.V. ✂ 1m
LED-PÍXEL-14,4W-IP20-24V	PÍXEL	14,4 W/m	60,80 €	20,00 €
Manipulación: Soldadura + 1 metro de cable				P.V. 3,50 €



Para mejorar la disipación debe utilizarse perfil o pletina de aluminio



- Rojo
- Verde
- Azul
- Rosa

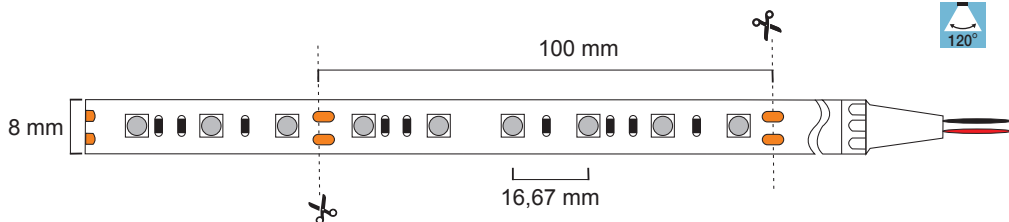

60 LEDs/metro	Acabado	lm/m	P.V. ● 50 m	P.V. ✂ 1m
12W-IP20-24V-ROJO	● Rojo	1080 lm/m	420,00 €	12,81 €
12W-IP20-24V-VERDE	● Verde	1080 lm/m	420,00 €	12,81 €
12W-IP20-24V-AZUL	● Azul	1080 lm/m	420,00 €	12,81 €
12W-IP20-24V-ROSA	● Rosa	1080 lm/m	420,00 €	12,81 €

	P.V.
Manipulación: Soldadura + 1 metro de cable	3,50 €



Para mejorar la disipación debe utilizarse perfil o pletina de aluminio



IP 20 **W 20** **120 led/m** **CRI >80** **10 cm** **24V** **3 AÑOS DE GARANTÍA** **CE** **RoHS**

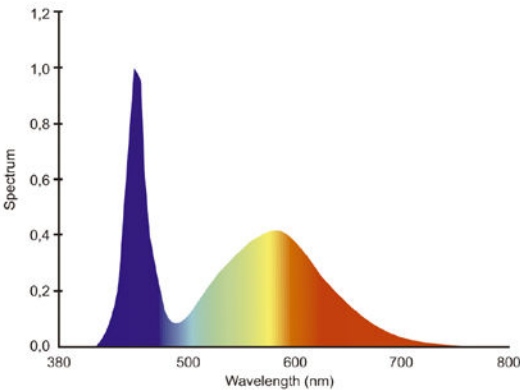
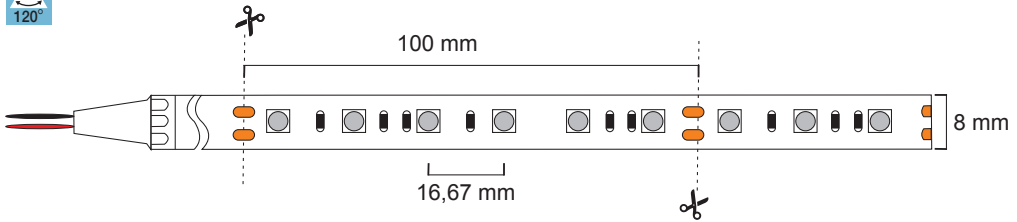

CRECIMIENTO

- Tira LED 20W, para fomentar el crecimiento de plantas
- Espectro luminoso amplio, con predominancia de azules
- 120 LEDs/m 24 VDC
- Sistemas de control y regulación disponibles

120 LEDs/metro	Medidas	W/m	P.V. ● 5 m
H.CRECIMIENTO	5000 x 0,22 mm	20 W/m	77,00 €

Para mejorar la disipación debe utilizarse perfil o pletina de aluminio

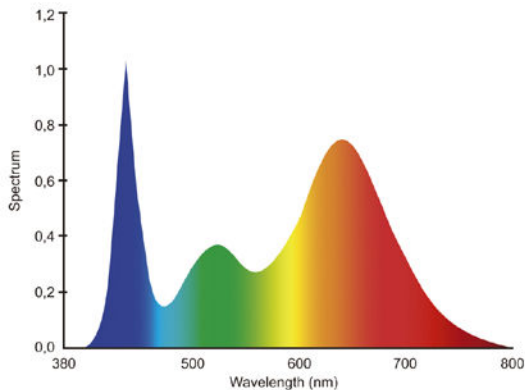

FLORACIÓN 1

- Tira LED 20W, para floración de plantas
- Recomendada para plantas con pocas hojas
- Predominación de rojos
- 120 LEDs/m 24 VDC
- Sistemas de control y regulación disponibles

120 LEDs/metro	Medidas	W/m	P.V. ● 5 m
H.FLORACION1	5000 x 0,22 mm	20 W/m	80,85 €

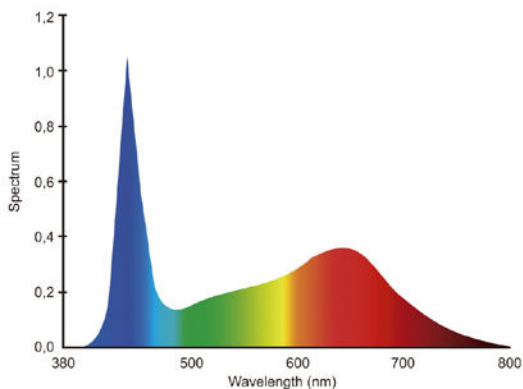

FLORACIÓN 2

- Tira LED 20W, para floración de plantas
- Recomendada para plantas con muchas hojas
- Predominación de rojos
- 120 LEDs/m 24 VDC
- Sistemas de control y regulación disponibles

120 LEDs/metro	Medidas	W/m	P.V. ● 5 m
H.FLORACION2	5000 x 0,22 mm	20 W/m	80,85 €

Para mejorar la disipación debe utilizarse perfil o pletina de aluminio

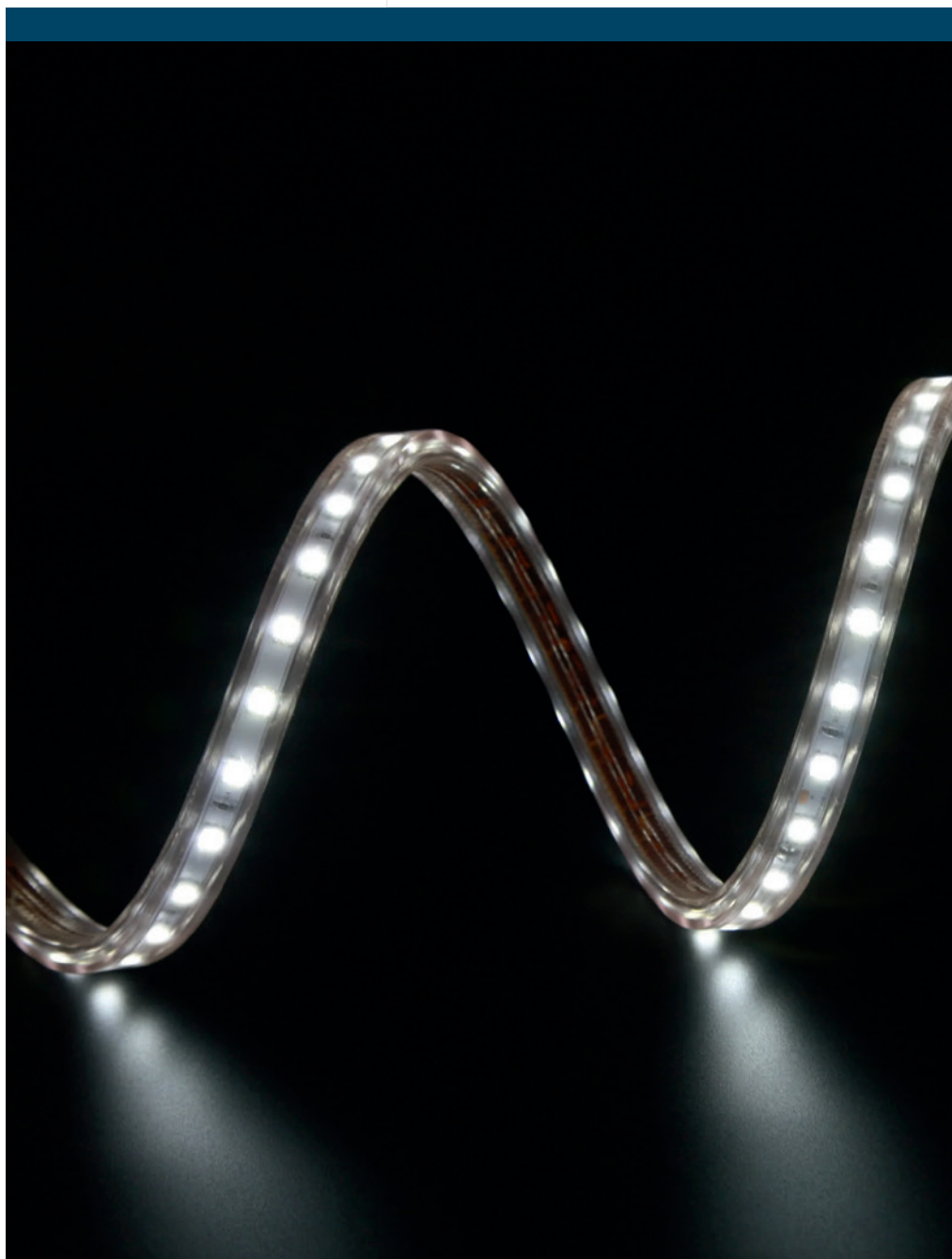

TIRAS LED IP

4,8W IP65



● Cálido

● Neutro

● Frío

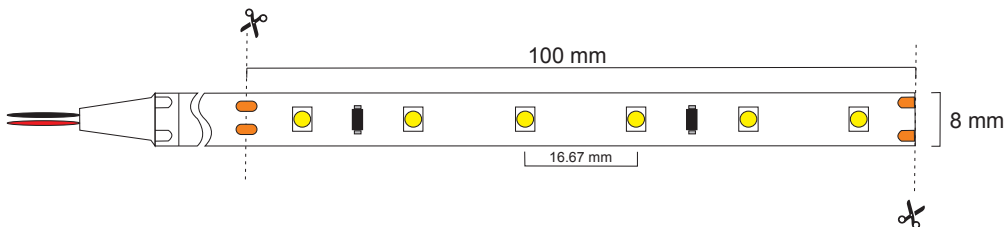

60 LEDs/metro	Acabado	lm/m	P.V. ● 10 m	P.V. ✂ 1m
4,8W-IP65-24V-3K	● Cálido	395 lm/m	58,40 €	6,50 €
4,8W-IP65-24V-4K	● Neutro	417 lm/m	58,40 €	6,50 €
4,8W-IP65-24V-6K	● Frío	454 lm/m	58,40 €	6,50 €

				P.V.
Manipulación: Soldadura + 1 metro de cable				7,50 €

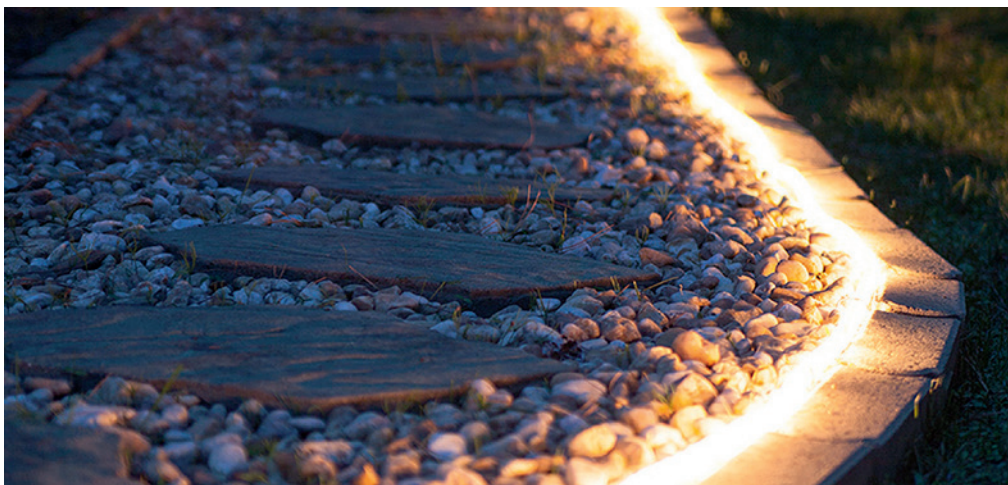

Para mejorar la disipación debe utilizarse perfil o pletina de aluminio



- Cálido
- Neutro
- Frío

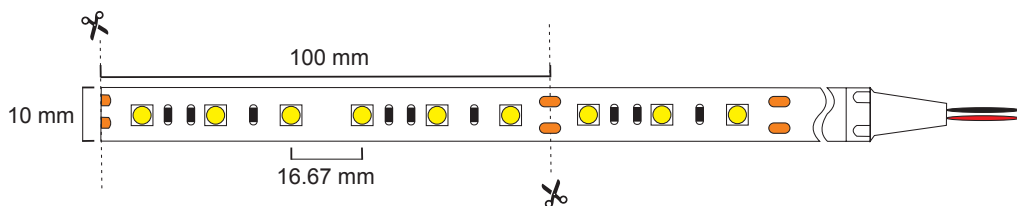

60 LEDs/metro	Acabado	lm/m	P.V. ● 10 m	P.V. ● 5 m	P.V. ✂ 1m
12W-IP65-24V-3K	● Cálido	1195 lm/m	79,00 €	41,00 €	13,00 €
12W-IP65-24V-4K	● Neutro	1224 lm/m	79,00 €	41,00 €	13,00 €
12W-IP65-24V-6K	● Frío	1224 lm/m	79,00 €	41,00 €	13,00 €

	P.V.
Manipulación: Soldadura + 1 metro de cable	7,50 €



Para mejorar la disipación debe utilizarse perfil o pletina de aluminio



● Cálido

● Neutro

● Frío

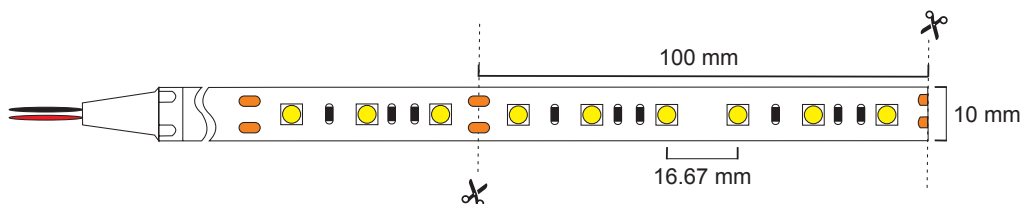

60 LEDs/metro	Acabado	lm/m	P.V. ● 10 m
12W-IP68-24V-3K	● Cálido	1195 lm/m	104,00 €
12W-IP68-24V-4K	● Neutro	1224 lm/m	104,00 €
12W-IP68-24V-6K	● Frío	1224 lm/m	104,00 €

*NO instalar en aguas tratadas con productos químicos. Pueden dañar el recubrimiento.



Para mejorar la disipación debe utilizarse perfil o pletina de aluminio



- Cálido
- Neutro
- Frío

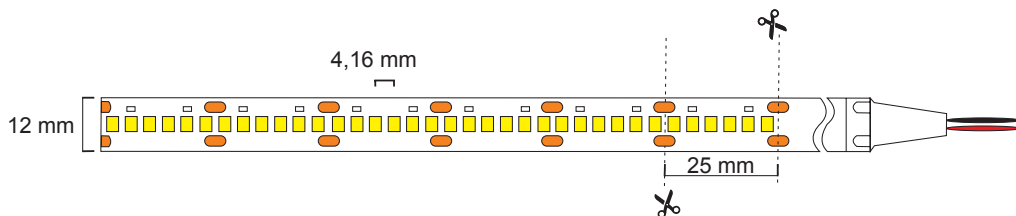

240 LEDs/metro	Acabado	lm/m	P.V. ● 10 m	P.V. ✂ 1m
26W-IP65-24V-3K	● Cálido	2340 lm/m	183,54 €	24,50 €
26W-IP65-24V-4K	● Neutro	2418 lm/m	183,54 €	24,50 €
26W-IP65-24V-6K	● Frío	2418 lm/m	183,54 €	24,50 €

Manipulación: Soldadura + 1 metro de cable	P.V. 7,50 €
--	----------------



Para mejorar la disipación debe utilizarse perfil o pletina de aluminio



● Cálido

● Neutro

● Frío

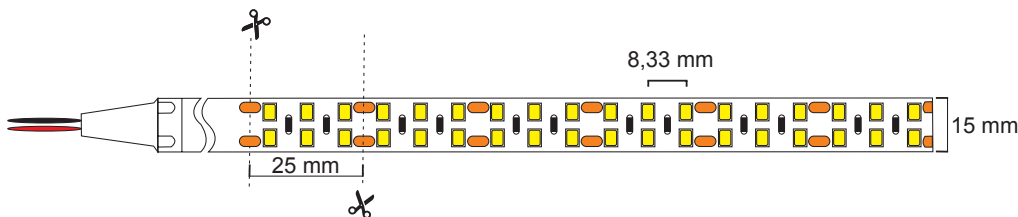

240 LEDs/metro	Acabado	lm/m	P.V. ● 10 m	P.V. ✂ 1m
26WDOBLE-IP66-24V-3K	● Cálido	2880 lm/m	160,00 €	24,50 €
26WDOBLE-IP66-24V-4K	● Neutro	2976 lm/m	160,00 €	24,50 €
26WDOBLE-IP66-24V-6K	● Frío	2976 lm/m	160,00 €	24,50 €

P.V.

Manipulación: Soldadura + 1 metro de cable

7,50 €



Para mejorar la disipación debe utilizarse perfil o pletina de aluminio



Rojo	4,2W	97lm	RGB
Verde	4,2W	246lm	
Azul	4,2W	42lm	
Mixto	12W	432lm	

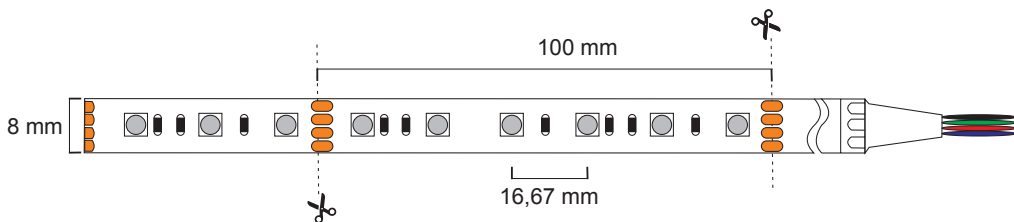

60 LEDs/metro	Acabado	P.V. ● 20 m	P.V. ✂ 1m
RGB-12W-IP65-24V	RGB	188,80 €	15,20 €

	P.V.
Manipulación: Soldadura + 1 metro de cable	7,50 €

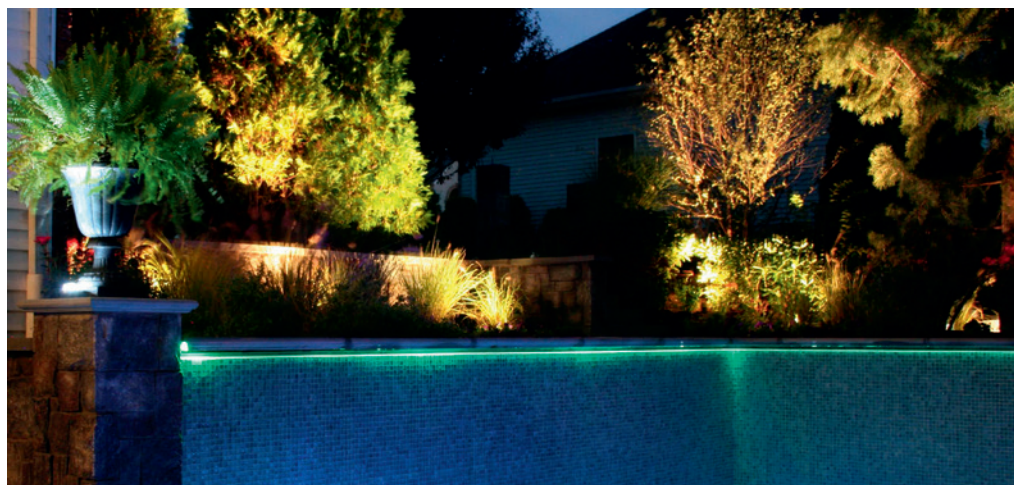

Para mejorar la disipación debe utilizarse perfil estanco

RGBW (RGB + Cálido o Frío) IP65

IP 65 **W 19,2** **60 led/m** **CRI >80** **12,5 crh** **24V** **3 AÑOS DE GARANTÍA** **CE** **RoHS** **MacAdam 3-STEP**

- RGB + Cálido
- RGB + Frío

Rojo	4,8W	53lm
Verde	4,8W	149lm
Azul	4,8W	26lm
Blanco	4,8W	612lm
Mixto	19,2W	763lm

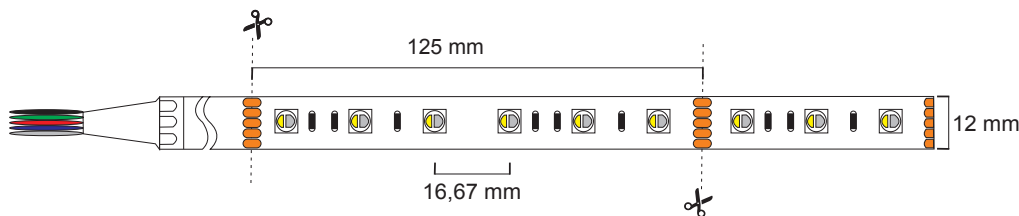

60 LEDs/metro	Acabado	lm/m	P.V. ● 10 m	P.V. ● 5 m	P.V. ✂ 1m
RGB+C-19,2W-IP65-24V	RGB + Cálido	960 lm/m	128,00 €	64,00 €	18,00 €
RGB+F-19,2W-IP65-24V	RGB + Frío	1080 lm/m	128,00 €	64,00 €	18,00 €

Manipulación: Soldadura + 1 metro de cable P.V. 7,50 €



Para mejorar la disipación debe utilizarse perfil o pletina de aluminio

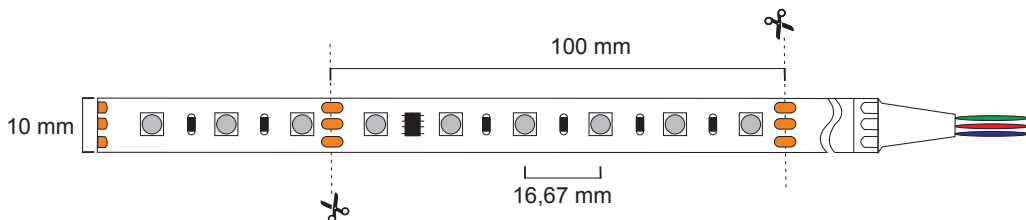

60 LEDs/metro

Acabado

W/m

P.V. ● 5 m

P.V. ✂ 1m

LED-PIXEL-14,4W-IP65- 24V

PIXEL

14,4W/m

73,40 €

23,00 €

P.V.

Manipulación: Soldadura + 1 metro de cable

7,50 €



Para mejorar la disipación debe utilizarse perfil o pletina de aluminio



TIRAS LED SMD 12V



- Cálido
- Neutro
- Frío

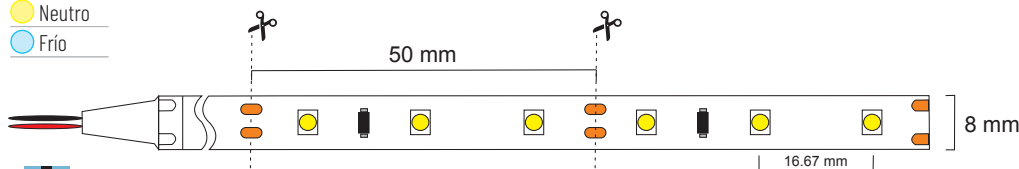

IP20 60 LEDs/metro	Acabado	lm/m	P.V. ● 5 m
4,8W-IP20-12V-3K	● Cálido	395 lm/m	21,90 €
4,8W-IP20-12V-4K	● Neutro	417 lm/m	21,90 €
4,8W-IP20-12V-6K	● Frío	454 lm/m	21,90 €

IP65 60 LEDs/metro	Acabado	lm/m	P.V. ● 5 m
4,8W-IP65-12V-3K	● Cálido	395 lm/m	29,20 €
4,8W-IP65-12V-4K	● Neutro	417 lm/m	29,20 €
4,8W-IP65-12V-6K	● Frío	454 lm/m	29,20 €

IP66 60 LEDs/metro	Acabado	lm/m	P.V. ● 5 m
4,8W-IP66-12V-3K	● Cálido	395 lm/m	29,20 €
4,8W-IP66-12V-6K	● Frío	454 lm/m	29,20 €



Para mejorar la disipación debe utilizarse perfil o pletina de aluminio

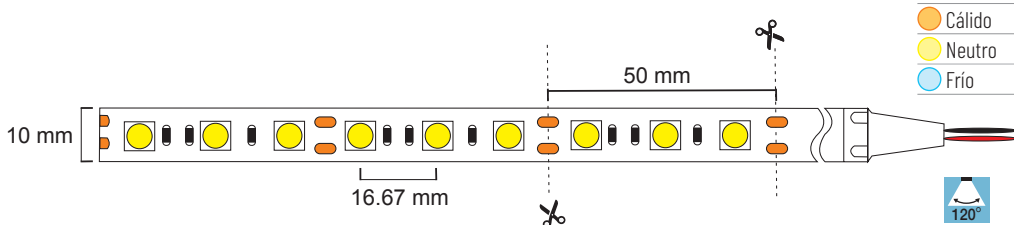

IP20 60 LEDs/metro	Acabado	lm/m	P.V. ● 5 m
12W-IP20-12V-3K	● Cálido	1195 lm/m	37,17 €
12W-IP20-12V-4K	● Neutro	1224 lm/m	37,17 €
12W-IP20-12V-6K	● Frío	1224 lm/m	37,17 €

IP65 60 LEDs/metro	Acabado	lm/m	P.V. ● 5 m
12W-IP65-12V-3K	● Cálido	1195 lm/m	39,00 €

IP66 60 LEDs/metro	Acabado	lm/m	P.V. ● 5 m
12W-IP66-12V-3K	● Cálido	1195 lm/m	39,00 €
12W-IP66-12V-6K	● Frío	1224 lm/m	39,00 €



Para mejorar la disipación debe utilizarse perfil o pletina de aluminio



	RGB			
	Rojo	4,2W	97lm	
	Verde	4,2W	246lm	
	Azul	4,2W	42lm	
	Mixto	12W	432lm	

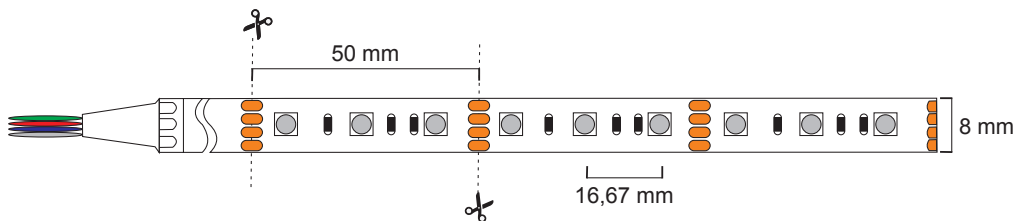

IP20 60 LEDs/metro	Acabado	P.V. ● 5 m
RGB-12W-IP20-12V	 RGB	36,20 €

IP65 60 LEDs/metro	Acabado	P.V. ● 5 m
RGB-12W-IP65-12V	 RGB	47,20 €



Para mejorar la disipación debe utilizarse perfil o pletina de aluminio



PERFILES

PERFILES

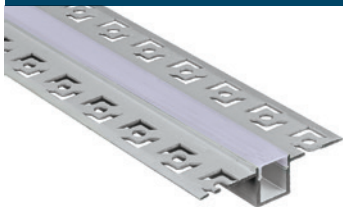

PERFIL LÍNEAS 1

- PERFIL de extrusión de aluminio PARA EMPOTRAR y hacer líneas rectas
- Perfil para empotrar en escayola para tira LED de hasta 12mm

Código	Descripción	P.V.
LINEAS1-2M	Perfil Aluminio	17,74 €

Anchura de tira máxima recomendada 12 mm

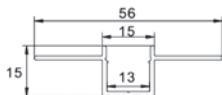

PERFIL LÍNEAS 2

- Perfil de extrusión de aluminio para empotrar en esquinas interiores
- Perfil para empotrar en escayola para tira LED de hasta 8mm

Código	Descripción	P.V.
LINEAS2-2M	Perfil Aluminio	17,74 €

Anchura de tira máxima recomendada 8 mm

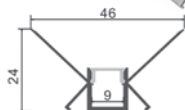

PERFIL LÍNEAS 3

- Perfil de extrusión de aluminio PARA EMPOTRAR en esquinas exteriores
- Perfil para empotrar en escayola para tira LED de hasta 8mm

Código	Descripción	P.V.
LINEAS3-2M	Perfil Aluminio	18,80 €

Anchura de tira máxima recomendada 8 mm

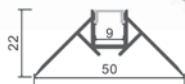

PERFIL U16

- Barra de 2m de perfil de aluminio para superficie
- Válido para montajes de Tiras LED, IP20, IP65 e IP66

Código	Descripción	Acabado	P.V.
U16-2M-01	Perfil Aluminio	<input type="checkbox"/> Blanco	10,40 €
U16-2M-19	Perfil Aluminio	<input checked="" type="checkbox"/> Negro	10,40 €

Anchura de tira máxima recomendada 16 mm

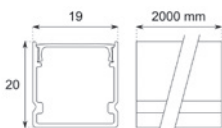

Coste corte de perfil: 5,00 € Coste instalación tira en perfil: 7,00 €

PERFIL U7E

- Perfil empotrable bañador de aluminio para iluminación indirecta
- Para señalización o iluminación de escaleras, pasillos y decoración
- Barra de 2m unidad mínima

Código	Descripción	Acabado	P.V.
U7E-2M-01	Perfil de aluminio	Blanco	7,40 €
U7E-2M-19	Perfil de aluminio	Negro	7,40 €
U7E-2M	Perfil de aluminio	Plata	7,40 €

Anchura de tira máxima recomendada 12 mm

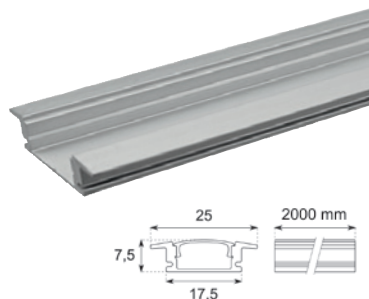

PERFIL V

- Perfil de extrusión de aluminio en forma de V
- Ángulo 90°
- Difusor ovalado

Código	Descripción	Acabado	P.V.
PERFILV-2M	Perfil Aluminio	Anodizado	4,72 €

Anchura de tira máxima recomendada 10 mm



PLETINA ALUMINIO

- Se puede utilizar en foseados y lugares donde no se requiera un perfil tapado
- Barra de 2 metros (unidad mínima)

Código	Descripción	Acabado	P.V.
6063-2M	Pletina Aluminio Lisa	Pulido	4,72 €

Anchura de tira máxima recomendada 14 mm

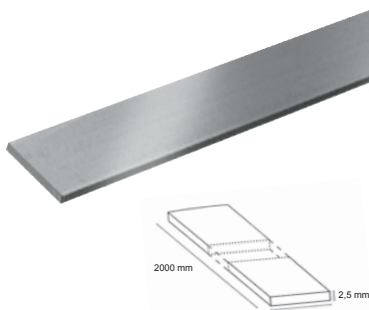

PERFIL H10

- Perfil de extrusión de aluminio para Tiras de LED de 10mm de ancho y máx.14.4W/m. Disponible difusor Transparente u Opalizado
- Disponibles grapas de fijación
- Barra de 2 metros (unidad mínima)
- Disponible EN ALUMINIO Y BLANCO

Código	Descripción	Acabado	P.V.
H10-2m	Perfil Aluminio Pulido	Aluminio	10,40 €
H10-2m-01	Perfil Aluminio Blanco	Blanco	12,60 €

Anchura de tira máxima recomendada 12 mm



Coste corte de perfil: 5,00 € Coste instalación tira en perfil: 7,00 €

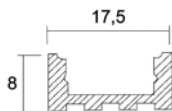

PERFIL U9

- Barra de 2m de perfil de aluminio para superficie
- Aletas cortas
- Válido para montajes de Tiras LED IP20 e IP65

Código	Descripción	P.V.
U9-2m	Perfil Aluminio Pulido	10,20 €

Anchura de tira máxima recomendada 12 mm

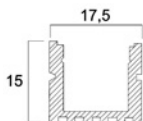
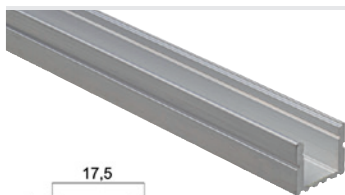

PERFIL U15

- Barra de 2m de perfil de aluminio para superficie
- Aletas altas
- Válido para montajes de Tiras LED, IP20, IP65 e IP66

Código	Descripción	P.V.
U15-2m	Perfil Aluminio Pulido	16,25 €

Anchura de tira máxima recomendada 12 mm

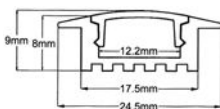
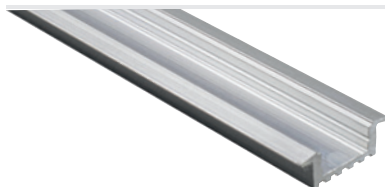

PERFIL U8E

- Perfil de extrusión de aluminio, acabado pulido
- Para Tiras de LED de 10mm de ancho y máx. 14,4W/m
- Disponible difusor Transparente u Opalizado
- Disponibles tapas laterales
- Barra de 2 metros (unidad mínima)

Código	Descripción	P.V.
U8E-2m	Perfil Aluminio Pulido	10,90 €

Anchura de tira máxima recomendada 12 mm

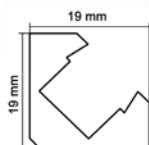
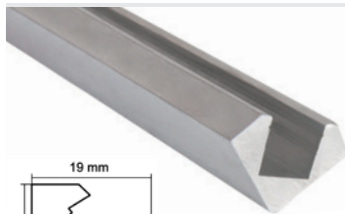

PERFIL A19

- Perfil superficie para ángulo 90°/esquinero
- Perfil de extrusión de aluminio para Tiras de LED de alta luminosidad (SMD 5630 máx. 28W/m)
- Difusor Transparente u Opalizado, opcional

Código	Descripción	P.V.
A19-2m	Perfil Aluminio Anodizado	24,60 €

Anchura de tira máxima recomendada 12 mm

Coste corte de perfil: 5,00 € Coste instalación tira en perfil: 7,00 €

PERFIL U78E

- Perfil empotrable bañador de aluminio para iluminación indirecta
- Para señalización o iluminación de escaleras, pasillos y decoración
- Barra de 2m unidad

Código	Descripción	P.V.
U78E-2m	Perfil Aluminio Pulido	56,60 €

Anchura de tira máxima recomendada 12 mm

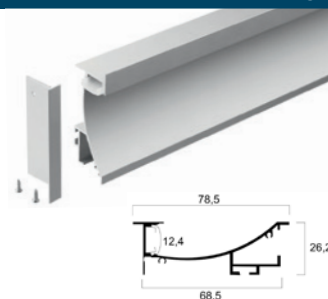

PERFIL PERCHERO

- Barra de extrusión de aluminio, con cavidad para incrustar tira de LED
- Válida para cualquier tipo de tira LED

Código	Descripción	P.V.
PERFIL PERCHERO-2M	Perfil Aluminio	29,40 €

Anchura de tira máxima recomendada 10 mm

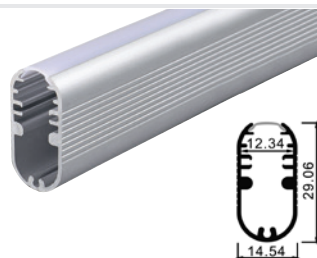

PERFIL AÉREO

Perfil aéreo de aluminio, perfecto para situaciones donde no tenemos un lugar físico para colocar la iluminación. Crea diferentes ambientes luminicos sin necesidad de hacer obra. Consta de dos tensores (para colocar en paredes/techos), y 10 metros de perfil de aluminio con los que crearemos nuestro ambiente, más accesorios para su instalación.

Código	Descripción	P.V.
PERFIL AEREO	Perfil Aluminio Negro	124,20 €

Anchura de tira máxima recomendada 12 mm

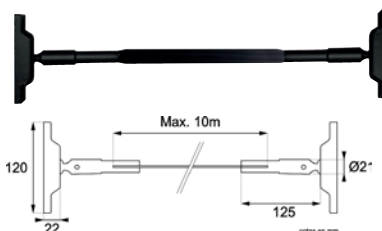

Perfil Líneas 1

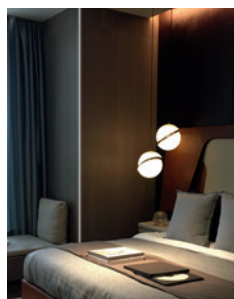

Perfil Líneas 3



Perfil Perchero



Perfil aéreo

Coste corte de perfil: 5,00 € Coste instalación tira en perfil: 7,00 €

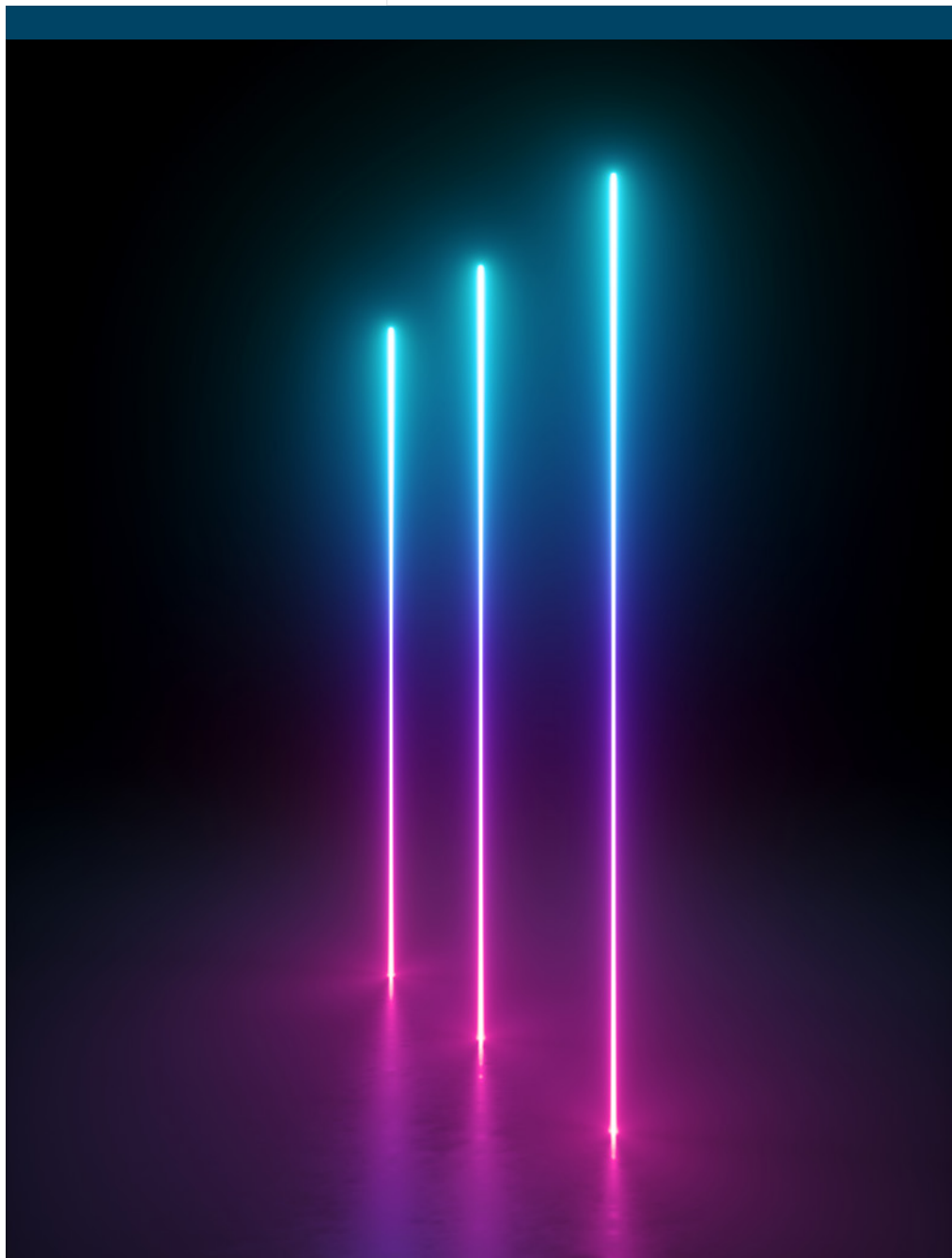

NEÓN

NEÓN 1 - 24V

IP 67 **CRI >80** **24V** **3 AÑOS DE GARANTÍA** **CE** **RoHS** **MacAdam 3-STEP**

- 1700K
 - 2700K
 - Cálido
 - Neutro
 - Frío
 - Rojo
 - Verde
 - Azul
 - Rosa
- RGB
 - RGB + Frío
 - RGB + Cálido
 - PÍXEL
 - COB RGB
 - COB + CDC
 - COB RGB+
 - COB PÍXEL



- Perfil flexible silicona IP67
- Iluminación frontal

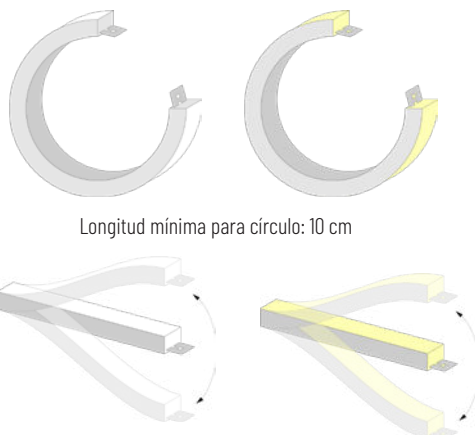
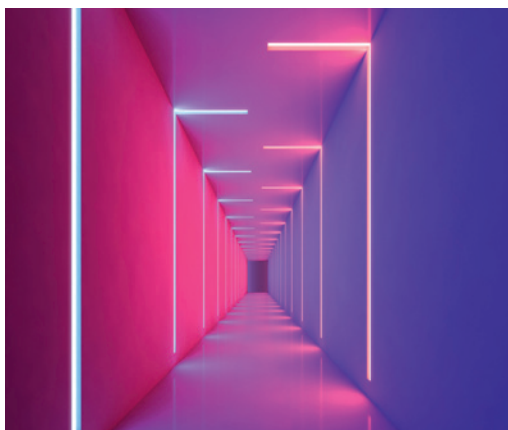
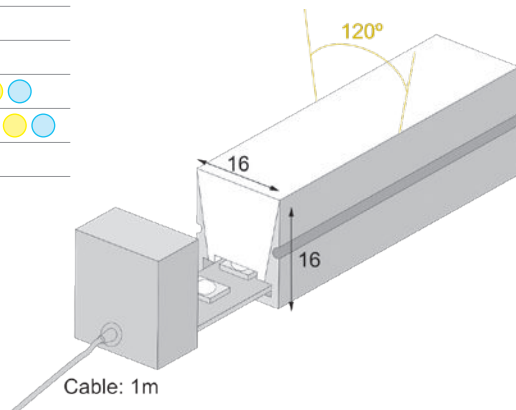

Ref. GRAPAS NEON1 **P.V.** 0,64 €

Ref. PERFIL FLEX.NEON1 **P.V. 1m** 8,94 €

- Perfil flexible silicona IP67
- Iluminación frontal

MacAdam 3-STEP | RoHS | CE | 3 AÑOS DE GARANTÍA | 24V | CRI >80 | IP 67

1700K	RGB
2700K	RGB + Frío
Cálido	RGB + Cálido
Neutro	PÍXEL
Frío	COB RGB
Rojo	COB + CDC
Verde	COB RGB+
Azul	COB PÍXEL
Rosa	

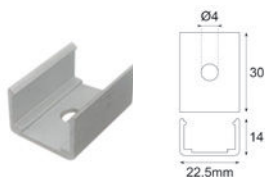
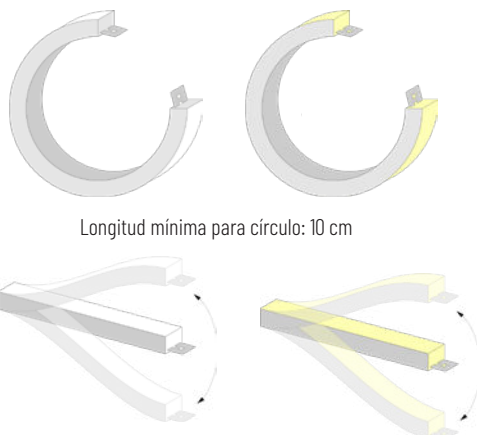
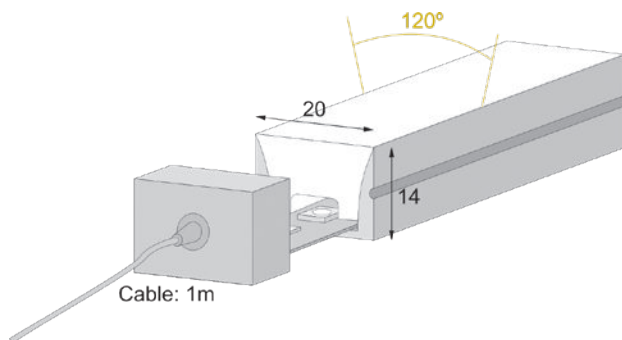

Ref. GRAPAS NEON2 P.V. 0,64 €



Ref. PERFIL FLEX.NEON2 P.V. 1m 8,94 €

NEÓN 3 - 24V

IP 67 **CRI >80** **24V** **3 AÑOS DE GARANTÍA** **CE** **RoHS** **MacAdam 3-STEP**

● 1700K	● RGB
● 2700K	● RGB + ● Frío
● Cálido	● RGB + ● Cálido
● Neutro	● PÍXEL
● Frío	● COB RGB
● Rojo	● COB + CDC ● ● ●
● Verde	● COB RGB+ ● ● ●
● Azul	● COB PÍXEL
● Rosa	

- Perfil flexible silicona IP67
- Iluminación lateral

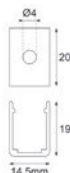
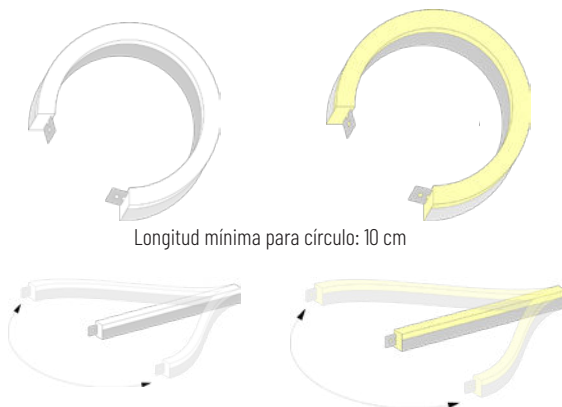
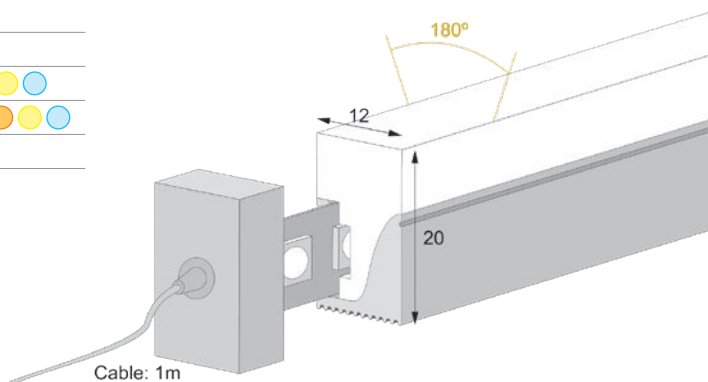

Ref. GRAPAS NEON3 P.V. 0,64 €



Ref. PERFIL FLEX.NEON3 P.V. 1m 8,94 €

- Perfil flexible silicona IP67
- Iluminación lateral



● 1700K	● RGB
● 2700K	● RGB + ● Frío
● Cálido	● RGB + ● Cálido
● Neutro	● PÍXEL
● Frío	● COB RGB
● Rojo	● COB + CDC ● ● ●
● Verde	● COB RGB+ ● ● ●
● Azul	● COB PÍXEL
● Rosa	

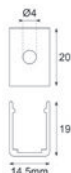
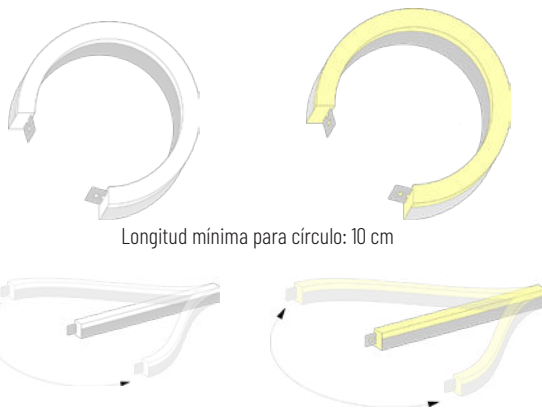
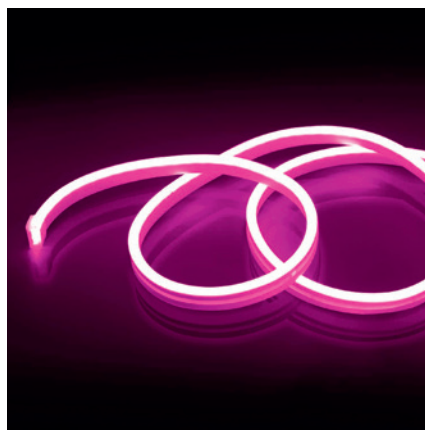
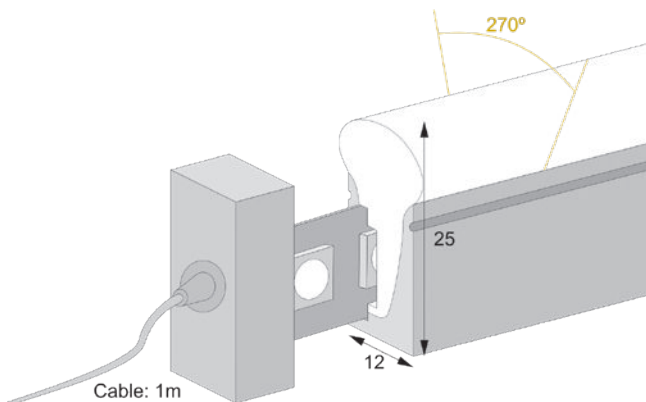









Ref. GRAPAS NEON4 P.V. 0,64 €





Ref. PERFIL FLEX.NEON4 P.V. 1m 8,94 €

TIRAS LED APTAS PARA NEONES 1-2-3-4



- Los precios indicados corresponden a un metro lineal de tira led
- Se pueden hacer cortes de hasta un máximo de 10 m (consultar según modelo)

12W 60 LEDs/metro	Acabado	lm/m	NEÓN 1	NEÓN 2	NEÓN 3	NEÓN 4
12W-IP67-24V-1700K	 1700K	810 lm/m	28,40 €	28,00 €	28,00 €	28,00 €
12W-IP67-24V-2700K	 2700K	896 lm/m	22,16 €	24,26 €	24,26 €	24,26 €
12W-IP67-24V-3K	 Cálido	896 lm/m	22,16 €	24,26 €	24,26 €	24,26 €
12W-IP67-24V-4K	 Neutro	918 lm/m	22,16 €	24,26 €	24,26 €	24,26 €
12W-IP67-24V-6K	 Frío	918 lm/m	22,16 €	24,26 €	24,26 €	24,26 €
12W-IP67-24V-Rojo	 Rojo	810 lm/m	29,20 €	31,30 €	31,30 €	31,30 €
12W-IP67-24V-Verde	 Verde	810 lm/m	29,20 €	31,30 €	31,30 €	31,30 €
12W-IP67-24V-Azul	 Azul	810 lm/m	29,20 €	31,30 €	31,30 €	31,30 €
12W-IP67-24V-Rosa	 Rosa	810 lm/m	29,20 €	31,30 €	31,30 €	31,30 €

15W **528** LEDs/metro

COB-15W-IP67-24V-3K	 Cálido	1125 lm/m	28,20 €	30,30 €	30,30 €	30,30 €
COB-15W-IP67-24V-4K	 Neutro	1181 lm/m	28,20 €	30,30 €	30,30 €	30,30 €
COB-15W-IP67-24V-6K	 Frío	1237 lm/m	28,20 €	30,30 €	30,30 €	30,30 €

26W **240** LEDs/metro



26W-IP67-24V-3K	 Cálido	1755 lm/m	34,14 €	36,24 €	36,24 €	36,24 €
26W-IP67-24V-4K	 Neutro	1813 lm/m	34,14 €	36,24 €	36,24 €	36,24 €
26W-IP67-24V-6K	 Frío	1813 lm/m	34,14 €	36,24 €	36,24 €	36,24 €

P.V.

Manipulación: Soldadura + 1 metro de cable

9,40 €

60 LEDs/metro	Acabado	NEÓN 1	NEÓN 2	NEÓN 3	NEÓN 4
12W-IP67-24V-RGB	 RGB	24,50 €	26,70 €	26,70 €	26,70 €
19,2W-IP67-24V-RGB+F	 RGB +  Frío	31,36 €	33,46 €	33,46 €	33,46 €
19,2W-IP67-24V-RGB+C	 RGB +  Cálido	31,36 €	33,46 €	33,46 €	33,46 €

COB 640 a 840 LEDs/m	Acabado	lm/m	NEÓN 1	NEÓN 2	NEÓN 3	NEÓN 4
COB-CDC-16W-IP20-24V	COB + CDC   	1500 lm/m	36,20 €	38,30 €	38,30 €	38,30 €
COB-RGB+CDC-16W-IP20-24V	 COB RGB+   	1700 lm/m	37,40 €	39,50 €	39,50 €	39,50 €
COB-RGB-15W-IP20-24V	 COB RGB	1500 lm/m	34,40 €	36,50 €	36,50 €	36,50 €
COB-DIG-14W-IP20-24V	 COB PÍXEL	1500 lm/m	35,40 €	37,50 €	37,50 €	37,50 €

PÍXEL **60** LEDs/metro

14,4W-IP67-24V-PÍXEL (Digital)	 PÍXEL	28,56 €	30,66 €	30,66 €	30,66 €
--------------------------------	---	---------	---------	---------	---------

P.V.

Manipulación: Soldadura + 1 metro de cable

13,40 €

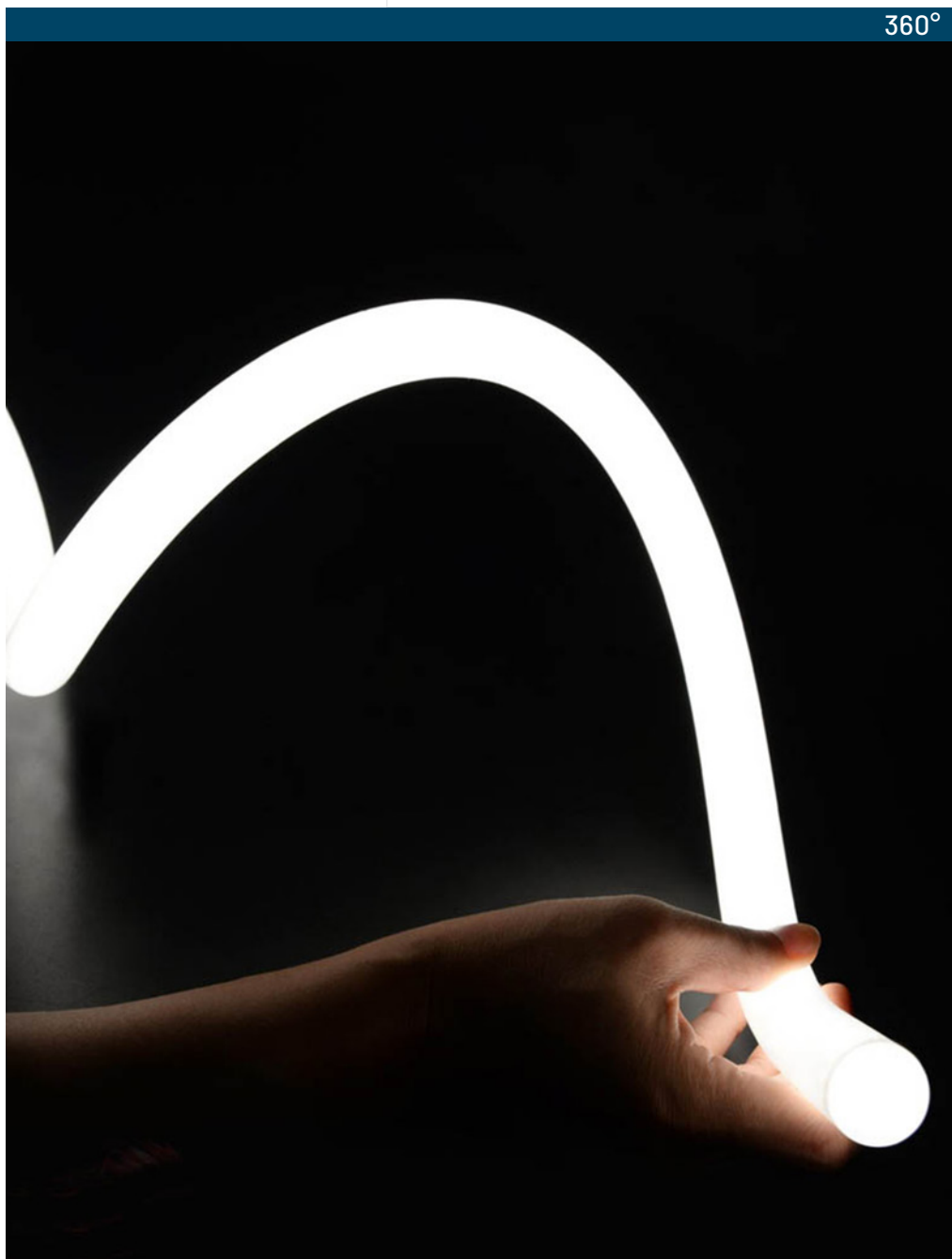

NEÓN 360°

NEÓN FLEXIBLE REDONDO



- Neón flexible redondo 360°
- Disponible en acabado blanco mate
- Tapa final metálica blanca
- Diámetro 22 mm
- 20 cm de cable
- Funciona a 24V

● Cálido

● Neutro

● Frío

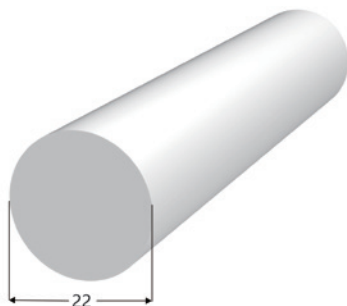

240 LEDs/metro	Tº de Color	lm/m	w	P.V.
360-1M-24V	3K, 4K o 5K	1500 lm/m	19,2 W	27,60 €
360-2M-24V	3K, 4K o 5K	1500 lm/m	38,4 W	55,20 €
360-3M-24V	3K, 4K o 5K	1500 lm/m	57,6 W	82,80 €
360-5M-24V	3K, 4K o 5K	1500 lm/m	96 W	138,00 €



ACCESORIOS	Descripción	P.V.
360-AC	Accesorio colgante metálico para Neón 360°	13,40 €
360-AS	Accesorio superficie metálico para Neón 360°	8,60 €
360-GRAPA	Clip-grapa PVC transparente para Neón 360°	0,50 €
360-ASH	Accesorio superficie horizontal para Neón 360°	13,90 €

NEONES COLGANTES HORIZONTALES Y VERTICALES

- Neón colgante horizontal o vertical
- Disponible en acabado blanco mate
- Recubierto de PVC en forma de tubo
- Tapa final metálica cromo
- Diámetros 22 mm y 44 mm



- Cálido
- Neutro

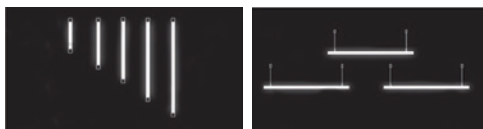
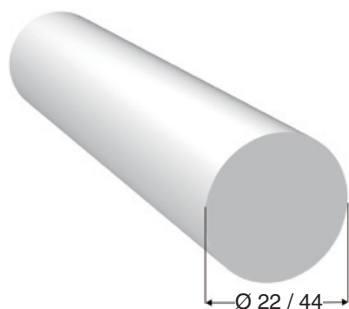

240 LEDs/metro	Ø	Tª de Color	lm/m	w	P.V.
360-H-1M	22 mm	3K o 4K	1500 lm/m	19,2 W	52,00 €
360-V-1M	22 mm	3K o 4K	1500 lm/m	19,2 W	52,00 €
360-XH-1M	44 mm	3K o 4K	1500 lm/m	19,2 W	69,00 €
360-XV-1M	44 mm	3K o 4K	1500 lm/m	19,2 W	69,00 €

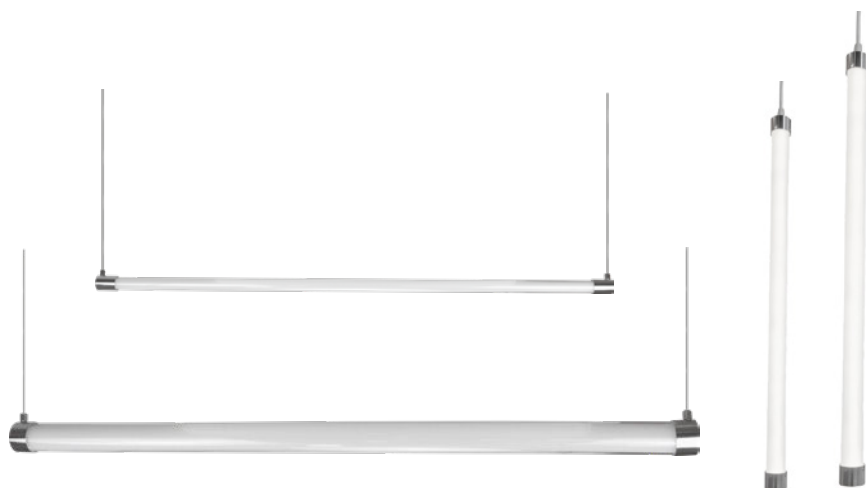



01: Blanco

19: Negro

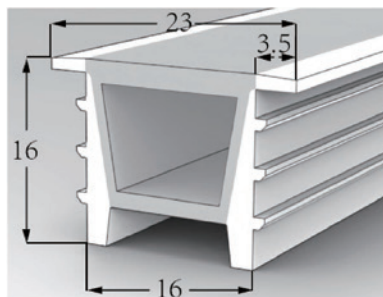

- Neón para empotrar en perfiles de 16 mm o regatas de 16 mm
- Acabados blanco y negro

Ref.	Acabado	P.V. ● 100 m	P.V. ✂ 1m
NEÓN S - 01	Blanco	580,00 €	7,10 €
NEÓN S - 19	Negro	580,00 €	7,10 €

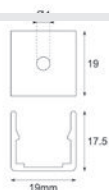
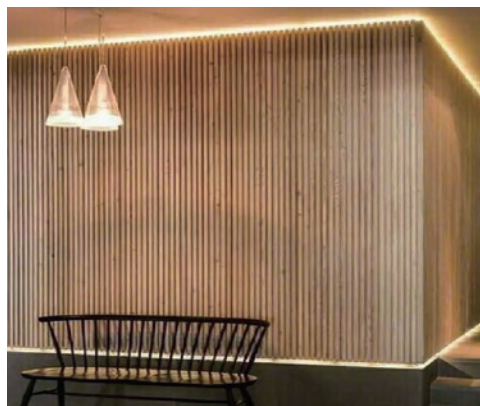

Ref.	P.V.
Grapa neón 1	0,64 €



Ref.	P.V. 1m
Perfil flexible neón 1	8,94 €

CU2P4-8W

- Conector para unión de Tiras LED 4,8W-8mm
2 conductores
- Se puede instalar una vez unido dentro de perfiles de
10mm >mm

Ref.	P.V.
CU2P4-8W	1,98 €



CA2P4-8W

- Conector para alimentación de Tiras LED 4,8W-8mm
2 conductores
- Se puede instalar una vez unido dentro de perfiles de
10mm >mm

Ref.	P.V.
CA2P4-8W	1,98 €



CU2P12W

- Conector para unión de Tiras LED 12W-10mm
2 conductores
- Se puede instalar una vez unido dentro de perfiles de
12mm >mm

Ref.	P.V.
CU2P14-4W	1,98 €



CA2P12W

- Conector para alimentación de Tiras LED 12W-10mm 2
conductores
- Se puede instalar una vez unido dentro de perfiles de
12mm >mm

Ref.	P.V.
CA2P14-4W	1,98 €





CU3P12W

- Conector para unión de Tiras LED 3 conductores
- Tiras de 10mm
- Se puede instalar una vez unido dentro de perfiles de 12mm o >mm, CDC, PÍXEL, DC-3-24V 6A MÁX

Ref.	P.V.
CU3P12W	1,54 €



CA3P12W

- Conector para alimentación de Tiras LED 3 conductores
- Tiras de 10mm
- Se puede instalar una vez unido dentro de perfiles de 12mm o >mm, CDC, PÍXEL, DC-3-24V 6A MÁX

Ref.	P.V.
CA3P12W	1,54 €



CU4PRGB

- Conector para unión de Tiras LED 4 conductores
- Tiras de 10mm
- Se puede instalar una vez unido dentro de perfiles de 12mm o >mm. Válido para tiras RGB o 4 conductores DC-3-24V 6A máx.

Ref.	P.V.
CU4PRGB	1,54 €



CA4PRGB

- Conector para alimentación de Tiras LED 4 conductores
- Tiras de 10mm
- Se puede instalar una vez unido dentro de perfiles de 12mm o >mm. Válido para tiras RGB o 4 conductores DC-3-24V 6A máx.

Ref.	P.V.
CA4PRGB	1,54 €

CONECTOR RÁPIDO ALIMENTACIÓN 1 POLO

Ref.	P.V.
C-1POLO	1,54 €



CONECTOR RÁPIDO DERIVACIÓN ALIMENTACIÓN 1 POLO

Ref.	P.V.
C-T-1POLO	2,31 €



CONECTOR RÁPIDO ALIMENTACIÓN 2 POLOS

Ref.	P.V.
C-2POLO	1,76 €



CONECTOR RÁPIDO DERIVACIÓN ALIMENTACIÓN 2 POLOS

Ref.	P.V.
C-T-2POLO	2,42 €



CONECTOR RÁPIDO TIRA MONOCOLOR 8MM

Ref.	P.V.
C-M-T-4.8W	1,98 €



CONECTOR RÁPIDO TIRA MONOCOLOR 10MM

Ref.	P.V.
C-M-T-12W	2,09 €



CONECTOR RÁPIDO TIRA CDC

Ref.	P.V.
C-CDC-12W	2,31 €



CONECTOR RÁPIDO TIRA RGB

Ref.	P.V.
C-RGB	2,42 €



CONECTOR RÁPIDO TIRA RGBW

Ref.	P.V.
C-RGBW	2,42 €



JACK ALIMENTADOR

- Jack alimentación
- Macho y hembra 2,5mm

Ref.	P.V.
JACK-ALI-M	2,75 €
JACK-ALI-H	2,75 €



CONECTORES



CONECTOR 2 POLOS 10 A 220V (IP20)

Ref.	P.V.
CN-2P-10A-220V.	0,56 €



CONECTOR 3 POLOS 10 A 220V (IP20)

Ref.	P.V.
CN-3P-10A-220V.	0,84 €



**CONECTOR DERIVACIÓN
1 ENTRADA 3 SALIDAS 10 A 220V**

Ref.	P.V.
CN-D-1/3-10 A-220V	0,78 €



**CONECTOR DERIVACIÓN
2 ENTRADAS 4 SALIDAS 8 A**

Ref.	P.V.
CD-2/4-8 A	1,48 €



**CONECTOR DERIVACIÓN
2 ENTRADAS 6 SALIDAS 8 A**

Ref.	P.V.
CD-2/6 8 A	2,38 €

CABLE PARALELO ALIMENTACIÓN TIRA LED

Ref.	P.V.
CAL-M 1M	2,42 €



CABLE ALIMENTACIÓN TIRA CDC

Ref.	P.V.
CAL-CDC 1M	2,75 €



CABLE ALIMENTACIÓN TIRA RGB

Ref.	P.V.
CAL-RGB 1M	3,63 €



CABLE MANGUERA TIRA LED

Ref.	P.V.
CAL-M-2x0.5mm 1M	3,08 €



CABLE 5 POLOS TIRA LED RGB + BLANCO

Ref.	P.V.
CAL-RGBW 1M	3,85 €
CAL-RGB 1M + CDC	4,50 €



FUENTES DE ALIMENTACIÓN PARA TIRAS DE LED

IP
67 **MW**
MEAN WELL



SERIE LPV / HLG

- Opción salida tensión 12V o 24V
- Fuente estanca de tensión constante
- En 20W, 35W, 60W, 100W, 150W, 185W y 240W
- Clase II • 2 años de garantía

P.V.	LPV20W	LPV35W	LPV60W	LPV100W	LPV150W	HLG185W	HLG240W
12V				Consulte precio			
24V				Consulte precio			

IP
67 **FP**
>0.95 **DALI2/PUSH**



FUENTE IP67 24VDC CONTROL DALI2/PUSH

- Fuente de tensión constante para tiras LED 24VDC, con regulación y control por DALI2 o PUSH

Ref.	P.V.
CN-SV100-24V-DALI2	99,80 €
CN-SV160-24V-DALI2	105,00 €
CN-SV240-24V-DALI2	126,00 €
CN-SV400-24V-DALI2	184,00 €

IP
20 **MW**
MEAN WELL



SERIE LRS (MEANWELL)

- Opción salida tensión 12V o 24V
- Fuente MW formato metálico reducido tipo jaula IP20
- Fuente con salida de tensión constante sin PFC.
- Rango de alimentación de entrada universal 85-264VAC 47-63Hz
- Indicador Led de estado
- Potencias 35W, 75W, 100W, 150W • 3 Años de garantía

P.V.	LRS-35W	LRS-75W	LRS-100W	LRS-150W
12V			Consulte precio	
24V			Consulte precio	

IP
20 **MW**
MEAN WELL **FP**
>0.9



RSP

SERIE RSP / UHP

- Opción salida tensión 12V o 24V
- Fuente metálica tensión constante PFC activo
- En 200W, 320W, 350W y 500W
- 3 años de garantía

P.V.	RSP-200	RSP-320	sin ventilador UHP350W	sin ventilador UHP500W
12V			Consulte precio	
24V			Consulte precio	

MANDO Y CONTROLADOR RGB/RGBW

- Mando y Controlador para tira de LED RGB/RGBW
- 4 Canales 2,5 A/Canal
- Máximo 10 A
- Válido para 5m tira 12Vdc o 10m tira 24Vdc

Ref.	P.V.
CTL-RGBW	30,24 €



MANDO Y CONTROLADOR CDC

- Mando y Controlador para tira CDC (Frío/Cálido)
- 2 Canales 6 A/Canal
- Máximo 10 A
- Válido para 5m tira 12Vdc o 10m tira 24Vdc

Ref.	P.V.
CTL-CDC	31,40 €



MANDO Y CONTROLADOR DIM-MONOCOLOR

- Mando y Controlador para tira Monocolor
- 2 Canales 6 A/Canal
- Máximo 10 A
- Válido para 5m tira 12Vdc o 10m tira 24Vdc

Ref.	P.V.
CTL-MONOCOLOR	31,40 €



MANDO Y CONTROLADOR PÍXEL-COM (LED DIGITAL)

- Controlador con más de 100 efectos para tira digital
- 2 Salidas válidas para 1024 píxeles por salida
- Alimentación máxima 12-24V según tira

Ref.	P.V.
CTL-PÍXEL-M	62,69 €



ALIMENTADOR TIRA LED

Ref. 12V	P.V.
DRIVER36WTL	16,28 €
DRIVER72WTL	25,30 €

Ref. 24V	P.V.
DRIVER36W-24V	16,28 €
DRIVER72W-24V	25,30 €
DRIVER96W-24V	31,68 €





CONTROLADOR MONOCOLOR / CDC (3K-6K) /RGB/RGB+BLANCO

- 5 Canales multizona
- Máximo 15 A
- Válido para 10m tira 12Vdc 20m tira 24Vdc

Ref.	P.V.
RF5C15A	37,70 €



MANDO MONOCOLOR / CDC (3K-6K) / RGB /RGB+BLANCO

- Mando de mano RF. 4 Zonas para controlador RF5C15A

Ref.	P.V.
MRF5C15A	39,90 €



CONSOLA PARED

- Consola pared de RF 8 Zonas para controlar RF5C15A

Ref.	P.V.
CRF5C15A	75,60 €



AMPLIFICADOR

- Amplificador 4 canales 3.5 A/Canal
- Máximo 15 A
- Válido para 5m tira 12Vdc 10m tira 24Vdc

Ref.	P.V.
AMP4C3.5A	23,10 €



CONTROLADOR WIFI

- Pasarela Wifi RF para receptor RF5C15A

Ref.	P.V.
WIFIRFC515A	50,40 €

DIMRFTRIAC-AC

- Controlador Dimmer Radio Frecuencia
- Válido para cualquier aplicación TRIAC-AC-220V
- 2 Canales 2x260W

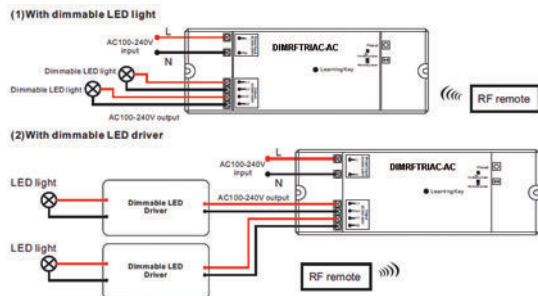

Ref.	P.V.
DIMRFTRIAC-AC	85,47 €

P-AC-150W

- Pastilla regulación TRIAC AC
- TRIAC-AC con regulación mínima de carga máx. 150W
- Opción de sincronizar un máximo de 30 pastillas con el mismo pulsador
- Esquemas y configuraciones de montaje en apartado de esquemas de montaje



Ref.	P.V.
P-AC-150W	41,90 €

DIM-300TRIAC

- Dimmer 300W para tira LED monocolor
- Entrada regulación TRIAC-AC



Ref.	P.V.
DIM-300TRIAC-AC	386,40 €



DIMMER DE POTENCIA

**MANDORF5Z**

- Mando Radio Frecuencia 5 Zonas
- Para controlador DIMRF4C5A

Ref.	P.V.
MANDORF5Z	35,18 €

**DIMRF4C5A DIMMER TIRA MONOCOLOR**

- Controlador Dimmer Radiofrecuencia Monocolor
- 4 Canales 5A Tira LED Monocolor

Ref.	P.V.
DIMRF4C5A	82,85 €

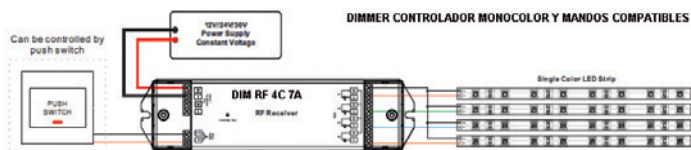
**SMRF1Z**

- Mando Radio Frecuencia de sobremesa
- 1 Zona para controladores DIMRF4C5A
- Uso exclusivo con DIMRF4C5A

Ref.	P.V.
SMRF1Z	64,26 €

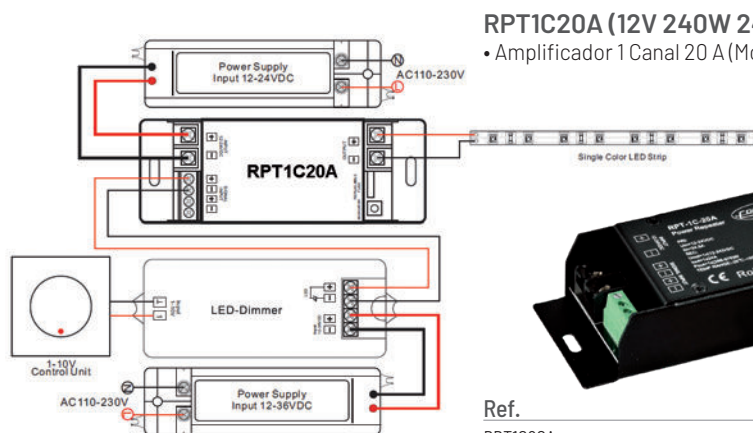

Ref.	P.V.
RPT1C20A	66,99 €

Consultar otras opciones de regulación y control RGB / DMX / Dali / 1-10V

DIM-UNIV-12/24-20A (12V 240W 24V 480W)

- Dimmer universal con entradas de Pulsador, Dali, 0-10V y TRIAC-AC
- Permite regular un máximo de 20A de carga en 12/24 VCD
- Trabaja con TRIAC-AC tanto en principio como en final de fase
- Selector para ajustes de funciones de entrada de control
- Válido para tiras de LED monocolor 12 o 24 VCD
- Conexión mediante bornes sin tornillo



Ref.	P.V.
DIM-UNIV-12/24-20A	84,00 €

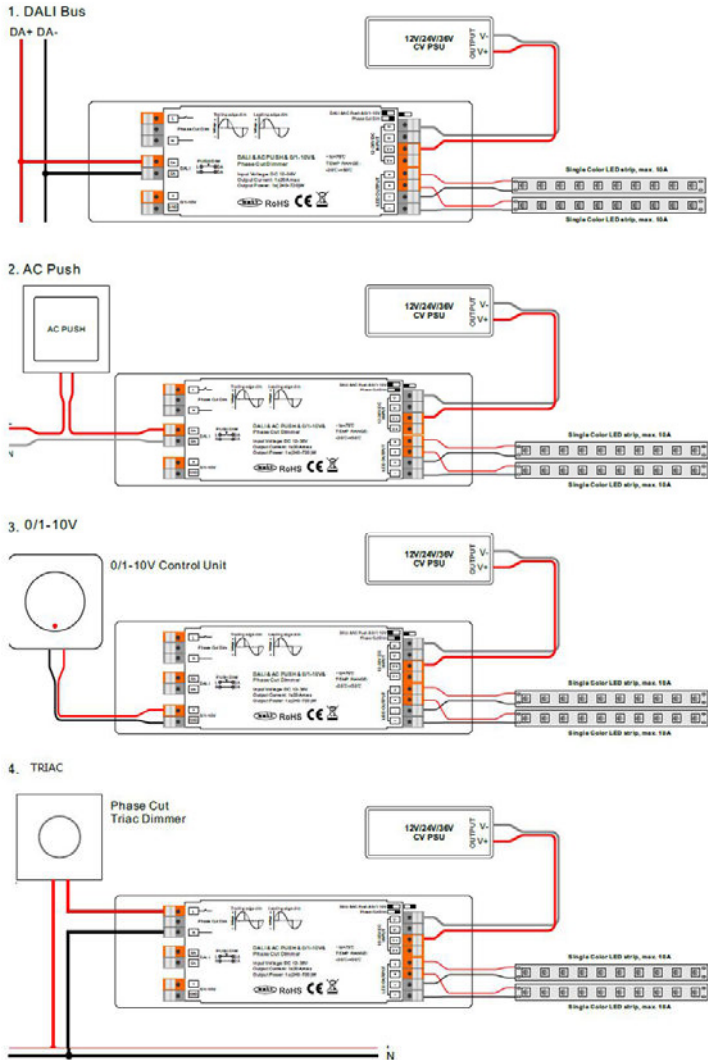

Consultar otras opciones de regulación y control RGB / DMX / Dali / 1-10V

* I.V.A. no incluido en el precio

**WFRFDMX512**

- Pasarela WIFI/RF/DMX para controladores familia DIM-RF
- Convertidor WIFI a RF para poder controlar los dispositivos con el móvil

Ref.	P.V.
WFRFDMX512	145,53 €

**DIMRFIP674C5A 12V 240W 24V 480W**

- Controlador Dimmer Radio Frecuencia RGB+Blanco/ CDC (3K-6K) / Monocolor
- 4 Canales, 5A por canal • IP67

Ref.	P.V.
DIMRFIP674C5A	139,44 €

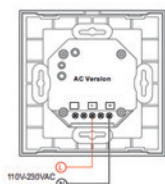
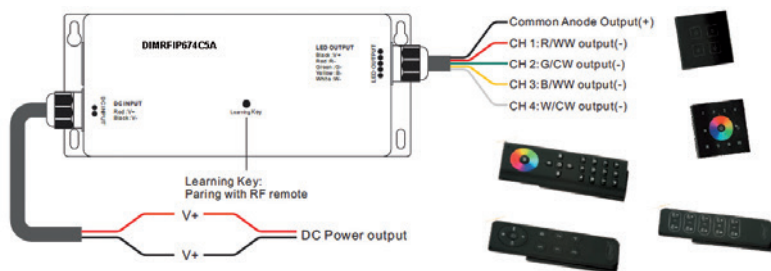
**MP4Z1COLOR**

- Panel Pared Radio Frecuencia 4 Zonas
- Válido para controladores DIM-RF
- Versión monocolor

Ref.	P.V.
MP4Z1COLOR	94,29 €

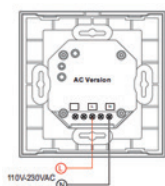
**MPRGBW4Z**

- Panel Pared Radio Frecuencia 4 Zonas
- Válido para controladores DIM-RF-IP67
- Versión RGB+RGB+Blanco

Ref.	P.V.
MPRGBW4Z	118,13 €

Consultar otras opciones de regulación y control RGB / DMX / Dali / 1-10V

MRF5Z1COLOR

- Mando Radio Frecuencia 5 zonas
- Válido para controladores DIM-RF
- Versión monocolor

Ref.	P.V.
MRF5Z1COLOR	33,39 €



MRFCDCCDIMIP67

- Mando Radio Frecuencia Control 4 zonas
- Válido para controladores DIM-RF-IP67
- Versión CDC (3K-6K)

Ref.	P.V.
MRFCDCCDIMIP67	30,87 €



MRFRGBWDIMRFIP67

- Mando Radio Frecuencia 6 Zonas
- Versión RGB+Blanco para controladores DIM-RF-IP67 (RGBW)

Ref.	P.V.
MRFRGBWDIMRFIP67	128,94 €



Consultar otras opciones de regulación y control RGB / DMX / Dali / 1-10V

DMX512



DRIVERDMXCC50W DMX512

- Driver DMX válido para aplicaciones LED hasta 50W
- Corriente constante ajustable 200-1500 mA
- Tensión alimentación: 200-240 VA

Ref.	P.V.
DRIVERDMXCC50W	116,76 €

DMX512



DIMDMXRGBW45A DMX512

- Dimmer DMX para tira de LED RGB, RGB+Blanco
- 4 Canales 5A por canal 12/24VDC

Ref.	P.V.
DIMDMXRGBW45A	104,90 €

DMX512



DIMDMXTRIAC-AC DMX512

- Dimmer DMX TRIAC-AC 220V
- 2 Canales de 220VAC 1.2A 2x264W/Canal
- Válido para aplicaciones de regulación TRIAC AC

Ref.	P.V.
DIMDMXTRIAC-AC	104,90 €

DMX512

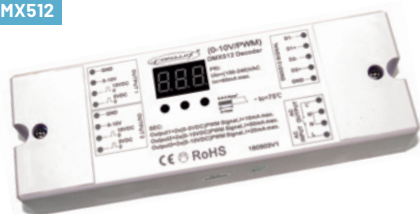

DIM-DMX-2-010V/PWM (Pasarela DMX-0/10V) DMX512

- Dimmer DMX 512 con dos salidas 0-10V/PWM
- Carga máxima soportada por las salidas 2x20mA 0-10V
- Incorpora Relé de corte de Fase máx. 2A

Ref.	P.V.
DIM-DMX-2-010V/PWM	188,90 €

Consultar otras opciones de regulación y control RGB / DMX / Dali / 1-10V

DALI - DT6

**DIMDALI-TRIAC-AC-2C (Pasarela DALI-TRIAC AC)**

- Dimmer con entrada Dali para regulación de cargas TRIAC-AC, 2 salidas 250W máximo potencia salida
- Permite trabajar los canales de salida simultáneos 1 dirección Dali o independientes 2 direcciones Dali
- Programación de las direcciones Dali mediante pulsadores frontales
- Regula cargas en final de fase

Ref.	P.V.
DIMDALI-TRIAC-AC-2	76,97 €

DALI - DT6

**P-RELE-0/1-10-DALI**

- Pastilla convertora de Dali-0-10V, con corte de alimentación por Relé

Ref.	P.V.
P-RELE-0/1-10-DALI	81,90 €

DALI - 2

**P-DALI-2-4P**

- Convertidor Dali-2, 4 entradas de pulsador
- Permite conectar 4 pulsadores estándar del mercado a un sistema Dali 2, y poder manejar la iluminación en 4 grupos, escenas o temporizaciones

Ref.	P.V.
P-DALI-2-4P	101,65 €

DALI

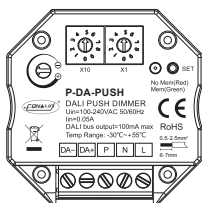
**PASTILLA CONVERSIÓN DALI A PUSH**

Pastilla para poder regular y controlar productos DALI con un pulsador estándar. Permite configurar dirección fija, grupo o broadcast. Genera bus corriente DALI 100ma, memoria configurable y ajuste de mínimo brillo.

Ref.	P.V.
P-DA-PUSH	47,40 €

Consultar otras opciones de regulación y control RGB / DMX / Dali / 1-10V

**CONTROLADOR DALI PARA CARRIL DIM 4 SALIDAS
250W x 4 TRIAC AC**

DALI - DT6

- Ajuste de dirección Dali manual por pulsadores o automático
- Permite controlar las 4 salidas independientes o agrupadas
- Si se ajusta en modo 4 salidas, cada salida ocupa una dirección Dali
- Si se ajusta en 2 salidas L1 y L3 son una dirección, mientras L2 y L4 serían la siguiente dirección
- En modo 3 salidas L1 y L4 son la primera dirección, L2 la segunda y L3 la tercer dirección
- Modo funcionamiento Regulación Final de Fase AC (Trailing Edge)



Ref.	P.V.
DIM-DALI-4CH-800-1600W	173,25 €

Wiring Diagram

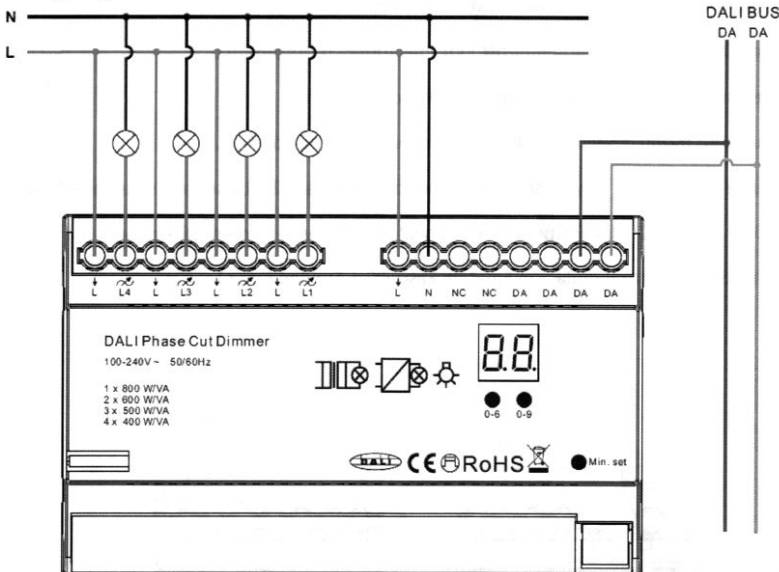

Consultar otras opciones de regulación y control RGB / DMX / Dali / 1-10V

RF 0/1-10V

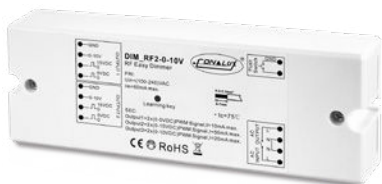
**DIMRF20-10V (Pasarela RF 0/10V)**

- Receptor RF con salidas 0-10V/PWM
- Función PUSH integrada para regulación manual
- 2 Salidas paralelas 0-10V/PWM máx. 20mA
- Relé de corte de Fase
- Compatible con mando MRF5ZICOLOR (Ver pág. 419)

Ref.	P.V.
DIMRF20-10V	191,30 €

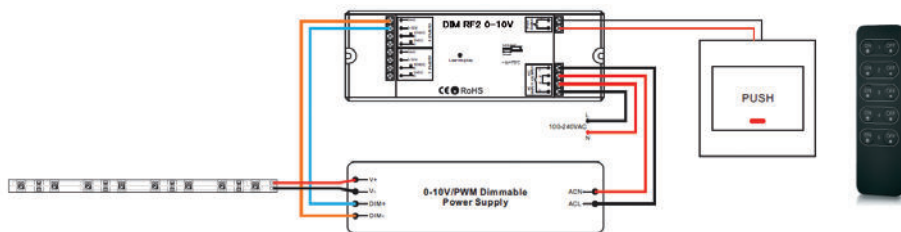

RF 0/1-10V

**P-0-10V-RF-PUSH**

- Pastilla salida 0/1-10V con función de regulación Push (pulsador)
- Opción de mando a distancia RF (30m)
- Alimentación 220 Vac y corte de fase por relé
- Máxima carga 300W

Ref.	P.V.
P-0-10V-RF-PUSH	37,70 €

IP 20 W 300

DIMMER DE
POTENCIA**DIM-300- 0-10V**

- Dimmer 300W para tira LED monocolor
- Entrada regulación 0-10V

Ref.	P.V.
DIM-300-0/10-12	386,40 €

**DIMPARED 0-10V**

- Regulador 0/1-10V para montaje en caja universal
- Función de ON/OFF pulsando en la rueda
- Alimentación 220V-AC
- Válido para Fuentes Regulables 0/10V

Ref.	P.V.
DIMPARE00-10V	60,17 €

DIMKNXRGBW4X5A

- Dimmer para control KNX, válido para tiras LED RGBW
- 4 Canales 5A simultáneo 12/24VDC
- Alimentación desde bus KNX para control
- Necesita de fuente externa 12 o 24 VDC para alimentación de tiras LED

KNX

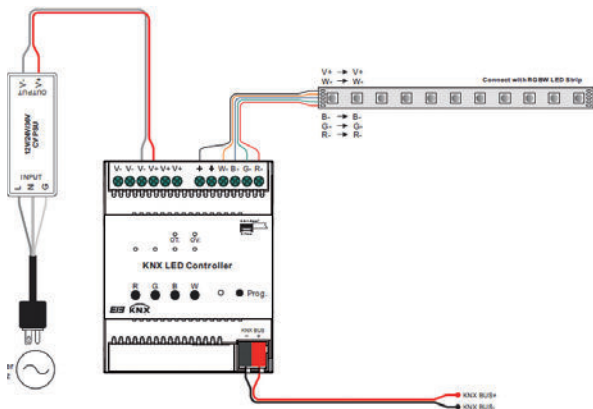

Ref.	P.V.
DIMKNXRGBW4X5A	519,44 €

DIMDALI1D4X5A

- Dimmer para control DALI, válido para tiras LED monocolor
- 4 Canales 5A simultáneo 12/24VDC
- Sólo necesita 1 dirección DALI

DALI - DT6

Ref.	P.V.
DIMDALI1D4X5A	96,08 €

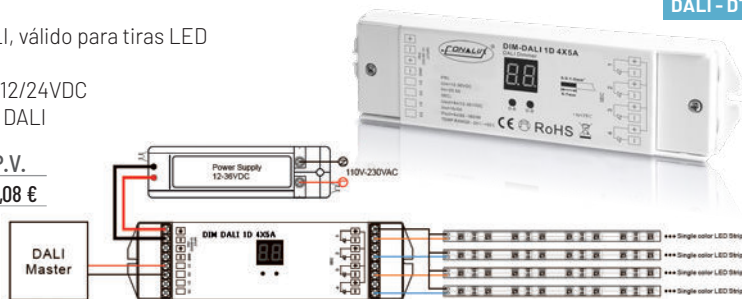

DIMDALIRGBW4X5A

- Dimmer para control DALI, válido para tiras LED RGB, RGB+ Blanco o CDC (3K-6K)
- 4 Canales 5A independientes 12/24VDC
- Necesita 4 direcciones DALI

DALI - DT6

Ref.	P.V.
DIMDALIRGBW4X5A	117,60 €

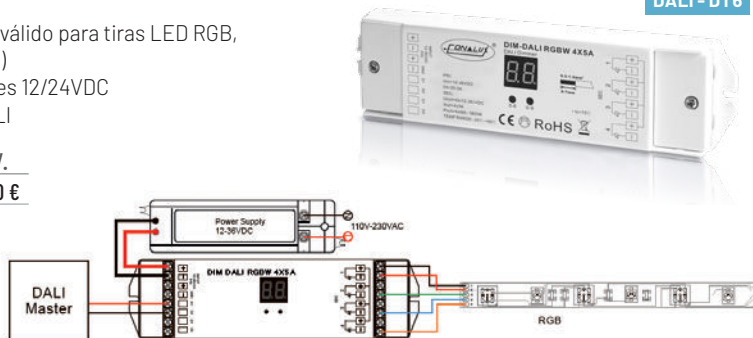

CONTROLADOR 32 SALIDAS 12/24-1A +PIXEL+PIR

- Permite seleccionar el número de salidas que queremos activar
- Se puede utilizar tanto el modo Tensión 12/24 como la tira pixel simultáneas
- Ajustes desde pantalla central OLED
- Salida de sincronización para poder ampliar el sistema con varios equipos
- Entrada Push para modo manual
- Entrada sensor luminico

Ref.	P.V.
CONT-32-S-1 A+PIXEL	190,31 €

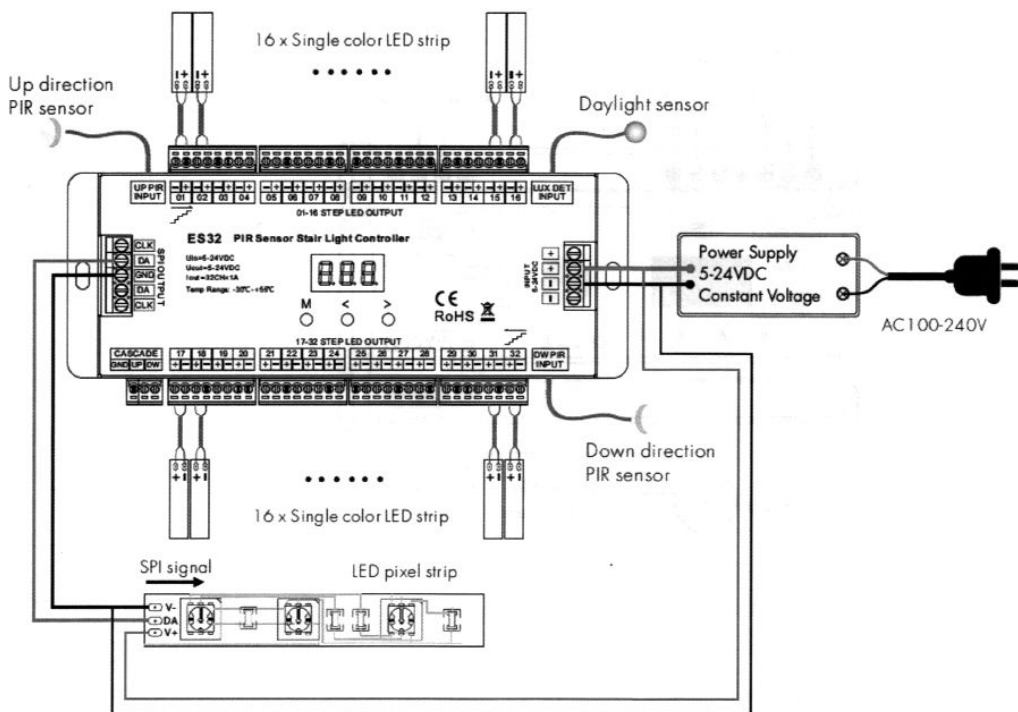

AMP-SPI-2S

- Amplificador SPI (Tira LED Digital) 1 entrada 2 salidas
- Alimentación 5-24V
- Consumo 0.5 A máximo
- Permite amplificar señales SPI (PÍXEL LED) y repetir la misma señal para 2 salidas independientes

Ref.	P.V.
AMP-SPI-2S	79,70 €

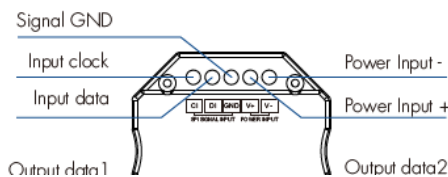
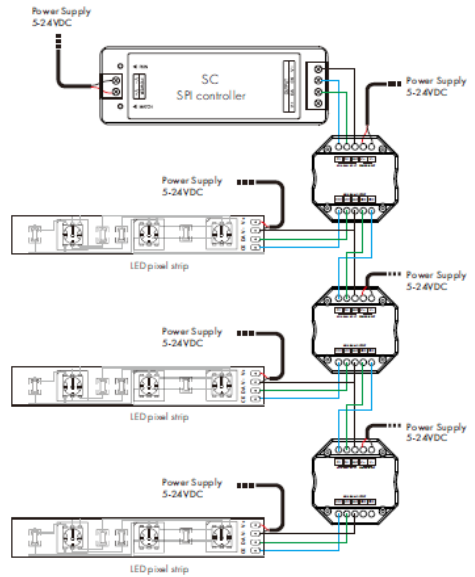
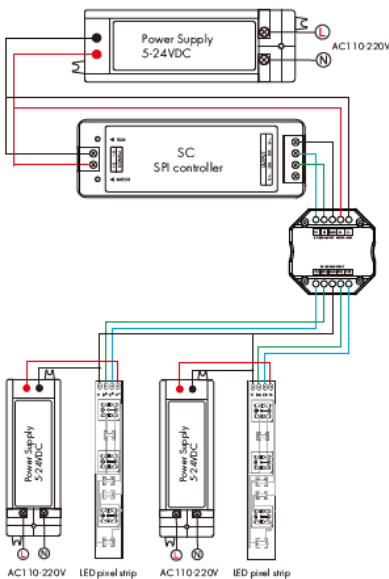

* I.V.A. no incluido en el precio

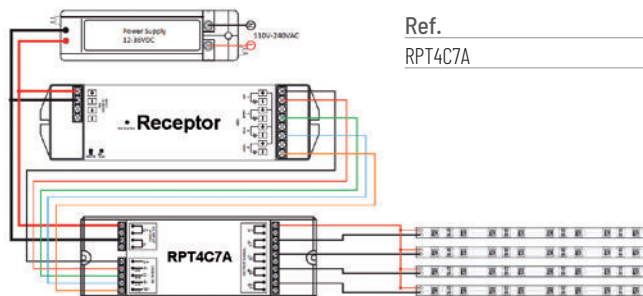
**RPT4C7A**

- Amplificador 4 Canales
- 7A por Canal 12/24V
- 12V máx. 84W por canal, 24V máx. 168W por canal
- Válido monocolor, RGB+W

Ref.	P.V.
RPT4C7A	75,60 €

**AMPLIFICADOR 5 CANALES 5 AMPERIOS CANAL**

- AMPLIFICADOR RGB+CDC 5A CANAL 12/24VDC. CE.EMC-LVD

Ref.	P.V.
RPT5C5A	64,50 €

**DMX-SPI-DEC**

- Decodificador DMX512 a SPI (LED Digital Pixel-Com)
- Incorpora pantalla led para fácil programación
- Compatible con múltiples IC
- Diferentes modos de funcionamiento, DMX, Autónomo
- 32 Programas en modo Autónomo.

Ref.	P.V.
DMX-SPI-DEC	101,33 €

**MANDO MRF-DMX-SPI**

- Mando RF para controlar sistema Pixel de receptor DMX-SPI-DEC
- Válido solo para referencia DMX-SPI-DEC

Ref.	P.V.
MANDO MRF-DMX-SPI	35,18 €

IP-SPI-4 SALIDAS (LED DIGITAL PÍXEL-COM)

- Controlador Ethernet SPI 4 Salidas SPI 7A
- Servidor Web integrado para Programación y Configuración
- Protocolos ArNet y sACN E.1.3.1
- Compatible con múltiples IC
2811,2801,6803,3001,8806,9813
- RGB: 680 PÍXELX 4 CANALES
- RGBW:512 PÍXEL 4 CANALES
- 11 Modos de prueba integrados
- Alimentación 5-24VDC



Ref.	P.V.
IP-SPI-4 SALIDAS	623,70 €

IP-SPI-16 SALIDAS (LED DIGITAL PÍXEL-COM)

- Controlador Ethernet SPI 16 Salidas SPI 3A
- Servidor Web integrado para Programación y Configuración
- Protocolos ArNet y sACN E.1.3.1
- Compatible con múltiples IC
2811,2801,6803,3001,8806,9813
- RGB: 340 PÍXELX 16 CANALES
- RGBW:256 PÍXEL 16 CANALES
- 11 Modos de prueba integrados
- Alimentación 5-24VDC



Ref.	P.V.
IP-SPI-16 SALIDAS	987,00 €



XB-C100 PROGRAMADOR EDITOR-REPRODUCTOR DMX-UCS-512

- Soporta programación de múltiples Chips DMX, Modo Programador y Reproductor desde tarjeta SD
- Batería interna para un uso de unas 10h
- Carga por Conector USB 5V (No Incluido)
- Permite grabar programaciones en SD con software LEEDIT y configuración controlador K1000C
- Soporte máximo de 512 Pixels RGB
- Soporta salida TTL y 485 3-4 hilos
- Cuenta con 22 modos de efectos Demo
- Pantalla táctil para manejo y configuración

Ref.	P.V.
XB-C100 DMX-UCS-512	899,00€



T-1000S CONTROLADOR PARA CHIPS DMX USC512 Y WS2811 CON SD

- Soporta múltiples Chips DMX 512 y WS2811, 2801, 2803...
- Soporte para 512 Pixel en modo DMX y 2048 en WS
- Función autónoma con tarjeta SD, almacena máximo 16 Programas diferentes
- Software libre de creación de programas y efectos LedEdit 2014 V2.44
- Conexión para 3 TTL o 485-DMX

Ref.	P.V.
T-1000S DMX USC512 y WS2811	899,00€

ILUMINACIÓN NACO, S.L.

CENTRAL

Ronda Norte, s/n. Pol. Ind. Virgen de la Salud
46950 · Xirivella (Valencia)
Tel. 96 313 72 90 · Fax 96 399 02 10
administracion@iluminaco.com
www.conalux.com

DELEGACIÓN MADRID

C/ Vedra, 2
(posterior Avda. de Entrevías, 98-100)
28053 · Madrid
Tel. 91 785 07 88 · 91 018 26 55
Fax 91 785 45 65
conaluxmadrid@iluminaco.com

DELEGACIÓN ALICANTE

C/ de la Libra, parc. R-22. Nave 4
Pol. Ind. Las Atalayas
03114 · Alicante
Tel. 96 528 24 19 · Fax: 96 528 66 09
conaluxalicante@iluminaco.com

DELEGACIÓN CATALUÑA

Tel. 672 07 86 79