

UA12/UA18/UA30 Ultrasonic IO-Link sensors

Sensors

UA12/18/30

Ultrasonic IO-Link sensors

This ultrasonic IO-Link sensor series of UA12, UA18 and UA30 provides superior sensing solutions with a good price-performance-ratio for a variety of industry applications. The ultrasonic sensors are excellent at contactless position and distance measurement and they are able to detect any target regardless of its colour, transparency or surface.

Because of their resistance to high and low temperatures and immunity against dust, steam and fumes, these Ultrasonic sensors are especially well suited to harsh environments.

The UA12, UA18 and UA30 come in a purely digital version and a combined version with one digital and one analog output.

Sensing distances go from 20 to 6000 mm and only plug versions are available. Due to improved technology, an extended sensing distance and a reduced housing length, these sensors make for a state of the art sensor family with high accuracy, versatility and resilience!



Advantages of the Ultrasonic IO-Link sensors

Increased machine runtime

Scheduled maintenance is vastly preferable to unexpected machine break downs. The sensors' built-in diagnostic features like temperatures, operating hours and error count give the option of scheduled maintenance, preventing costly downtime. Should a sensor malfunction, sensor replacement is simplified by using the automated parameter reassignment and it also prevents incorrect settings.

Simplified sensor/machine set-up

IO-Link features offer a wide range of customizable options that are easy to set up. When in an IO-link environment the digital channel is available for output instead of being reserved for manual teach, making the analogue sensor version a 2-in-1 option.

An IO-link system requires just standard, unshielded 3-wire cables, that are widely available at relatively low cost. In addition, the standardized interface for sensors and actuators drastically reduces the complexity of the installation process.

Reduced stock

The Ultrasonic sensor is an all-in-one sensor thanks to its IO-Link features. It is highly customizable via an IO-Link master or the SCTL55, allowing for the same sensor being used in multiple applications, ultimately reducing the stock costs.

The IO-Link-enabled sensor acts as a standard sensor when installed in a non-IO-Link system, so the same sensor can be stocked for both standard I/O (SIO) applications and IO-Link applications.



Applications

Blow moulding machine

A blow moulding machine uses air to blow liquid plastic to a certain size or shape. Ultrasonic sensors on all sides of the shape ensure the correct dimensions are reached. The UA-series features synchronized sensing to avoid crosstalk when sensors are mounted facing each other across the blown shape.



Parts counting & presence detection

Because of their superior ability to detect transparent objects and to measure distance, the UA12, UA18 and UA30 sensors are a perfect choice for a wide range of applications. Parts are precisely detected and positioned and objects or persons are counted by the UA18 and UA30 sensors in areas dealing with people, robots, glass, fluids, food & beverage, solid objects, car wash and materials handling.



Detection of trees in mobile spraying systems

Thanks to its 6 m sensing distance, our ultrasonic sensor UA30ASD60 is ideal for tree detection in agricultural spraying equipment used in for instance fruit orchards. A sensor is mounted in front of each sprayer, and its information is used to ensure that only trees are sprayed. As a result, the quantities of pesticides used are reduced for the benefit of costs as well as the environment.



Distance measurement in street sweepers

Because it is highly resistant to salt water and mechanical stress, our ultrasonic sensor with a stainless steel housing is an excellent choice for distance measurement in street sweepers. This sensor detects the distance to the pavement while ignoring its colour or shape. By knowing the exact distance, the performance of the brushes is optimized.



UA12/18/30

Ultrasonic IO-Link sensors

Applications

Level detection in large storage silos

In the animal feed industry, feed manufacturers and animal producers share a common interest in solutions that optimize handling of animal feed at the lowest possible cost. Our ultrasonic sensor UA30ASD60 with a 6 m sensing distance is superb at measuring levels in large feed silos. Knowing the feed level in the silo and the required output of animal feed for a certain period is a powerful instrument. Thus, the feed supplier will know the exact quantity necessary for each refill, overstocking is avoided, and each feed portion will be fresher.

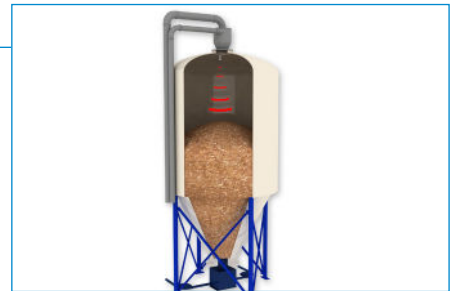

Height and size measurement

The UA12, UA18 and UA30 sensors are successfully used in applications which measure the height or size of objects moving past the sensor or for stacking operations in industries such as the automotive industry, printing machines, metal working, package & distribution, food & beverage, bottle sorting, agriculture, robots, the electronics industry, glass and materials handling.

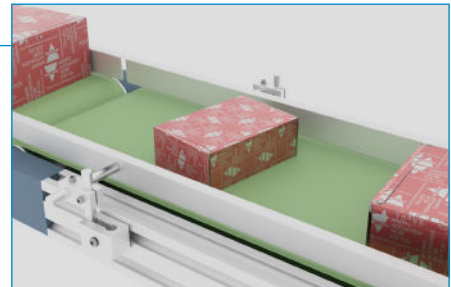

Tension control

Monitoring and control of speed, position and tension of materials being processed are efficiently and accurately performed by the UA12, UA18 and UA30 sensors. The sensors monitor the slope of loops and synchronise the speed between machines, securing a stable working flow. These features are useful in metal working, paper, aluminium, textile and plastics manufacturing as well as packaging and chemical industries.



Diameter measurement

The UA12, UA18 and UA30 sensors are ideal for accurate measurement of changing diameters, such as reels and drums in paper, aluminium and other metal manufacturing, textile, plastics and packaging industries. The sensors provide a precise output of the diameter in rolls or drums as it changes when materials wind or unwind.

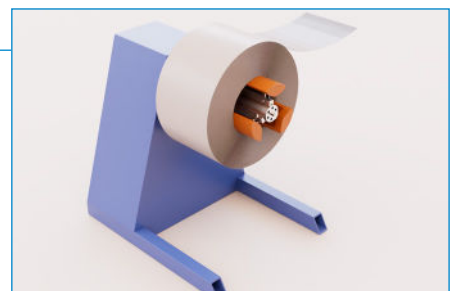

Applications

Detecting people in front of ATMs

Our short-body UA18CSD/ESD sensors can detect up to 800 mm, and they are not affected by the colour of for instance clothes or vehicles. Therefore, these sensors are highly appropriate for detection of customers in front of an ATM (automatic teller machine) or a drive-through ATM. Moreover, the sensors are very resistant to adverse conditions, and they offer a reliable detection that facilitates communication between customer and machine.



Ink level measurement in offset printing

In modern offset printers the ink level is automatically monitored and adjusted for the specific print job. The ink fountain controls the amount of ink that enters the inking system. Our short-body UA18CSD/ESD sensors can detect from 40 to 300 mm, and they offer a precise detection of the ink level in the ink fountain. The ink distribution rollers will receive only the requisite quantity of ink, and unnecessary waste is thereby avoided.



Universal, smart and easy



Data availability down to a detailed level

Using IO-Link, the sensors can deliver their data directly into the control system very efficiently.

Device identification

Each IO-Link sensor has an IODD (IO Device Description), which describes the sensor, its capabilities and parameters, process data, diagnosis data and user interface configuration. Furthermore, each sensor is equipped with an internal ID.

Automatic parameter settings

Initial setup of a new sensor is smooth and easy using previously stored parameters. Once a sensor has been replaced, the IO-Link master simply transmits parameters stored from the old sensor.

Centralized configuration and data management

IO-Link enables fast configuration and dynamic change of the sensor parameters on the fly, which considerably reduces downtime in case of product changeover and increases flexibility and diversity of the installation.

UA12/18/30

Ultrasonic IO-Link sensors

Materials to be detected

Hard foam



Wood



Glass



Liquid / water

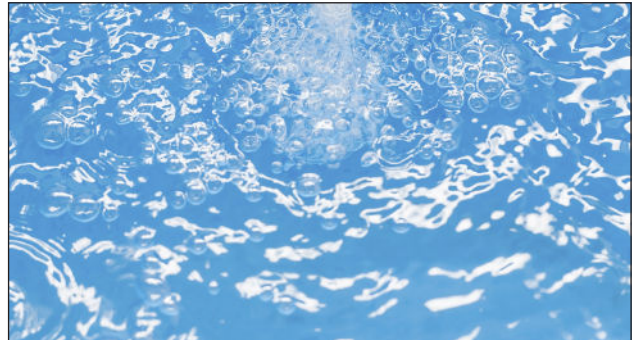

Metal



Plastic



Paint / lacquer



Bulk material / rock



UA12/18/30

Ultrasonic IO-Link sensors



IO-Link functions

Highly flexible sensors

IO-Link provides the first globally standardized interface for sensor communication. Once you have connected the sensor to the IO-Link port, you can access a multitude of configuration parameters and advanced functionalities. This way, the sensor can be tailored to meet your individual needs and requirements at a given time. The settings can also be stored in a master and can always be changed if the need occurs, or they can be smoothly transferred to a new sensor in case of sensor replacement.

Analog sensor version

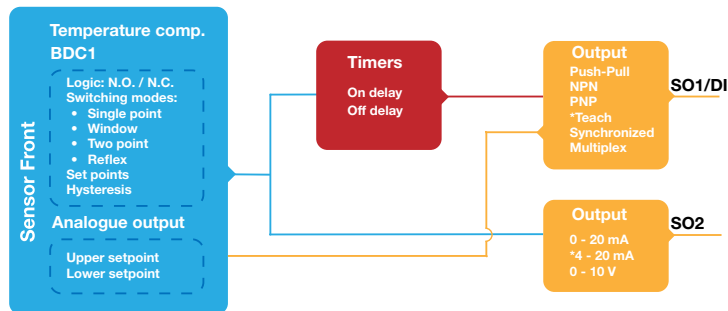

Digital sensor version

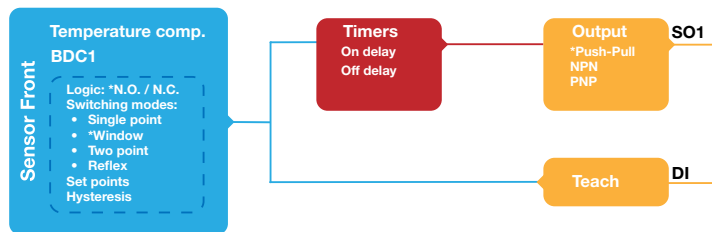

Sensor front

BDC1 (Binary data channel) Detection modes

Each channel can be set to operate in 1 of 4 detection modes. The switch point mode setting is used to create more advanced output behavior. The following switch point modes can be selected for the switching behavior of BDC1: Single-point mode, *Window mode, Two-point mode or Reflex mode.

Hysteresis Settings

The hysteresis can be changed via IO-Link.

Timers

Via IO-Link it is possible to activate different timer functions: ON delay, OFF delay or disabled. These delays may be adjusted in ms.

* Default settings

Output

The sensor outputs (SO) can be configured as:

Analog sensor version

SO1/DI: NPN, PNP, push-pull, Teach, Synchronized or Multiplex.

SO2: 0-20 mA, 4-20 mA or 0-10 V.

Digital sensor version

SO1: NPN, PNP, push-pull.

DI: Teach.

Predictive maintenance

IO-Link connection offers information on operating hours, number of power ONs, temperature alarm, error count and device status, which can be used to schedule maintenance of the installation.

UA12/18/30

Ultrasonic IO-Link sensors

Digital output

Single point mode

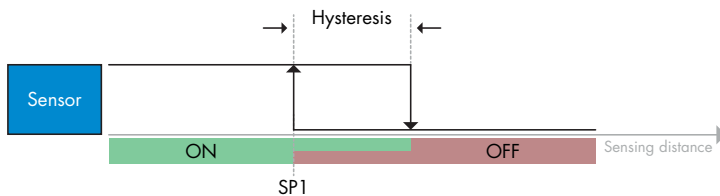

Two point mode

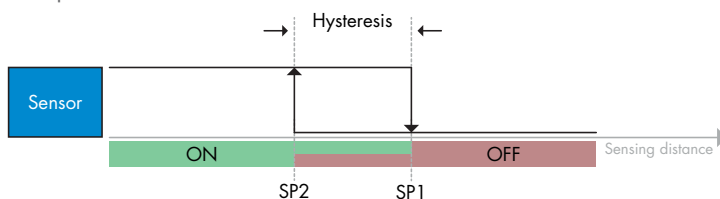

Window mode

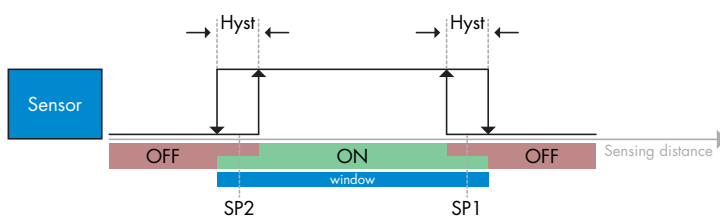

Reflex mode

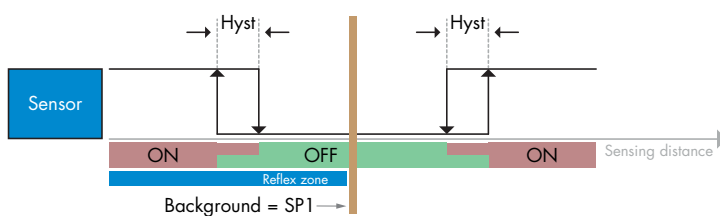

The digital output of the sensor offers 4 different switching modes. These switching modes make the sensor very flexible in its setup, helping it fit most needs in distance, level or diameter measurement, as well as loop control.

If an object needs to be detected at a certain point, the single point mode or two point mode are eminently useful as the sensor switches between ON and OFF at a certain distance. Two Point mode is more flexible.

If the object must be detected within a specific distance range, the window mode lets you define an interval within which the sensor is ON. Outside this range, it switches OFF. Among others, this mode is used in tension control.

In reflex mode, the sensor detects anything between itself and a reference background, which makes it useful for presence and absence detection of any objects, that would absorb or redirect the sound.

These modes all require setup via IO-link.

Analogue output

Negative slope

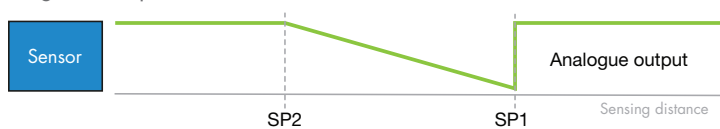

Positive slope

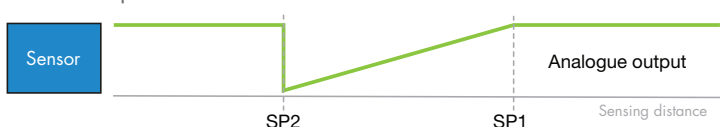

The analogue ultrasonic sensors offer an analogue output channel in addition to the digital one. This analogue output can be configured with either "positive slope" or "negative slope" depending on your application needs. The slope is defined by two teachable set points.

This means that between the two setpoints, the distance from sensor to object is translated into a current or voltage output, where any change in distance results in a corresponding change in the analog output.

0-10V and 4-20mA do not require an IO-link connection, whereas 0-20mA does require IO-link.

Structure

UA12....

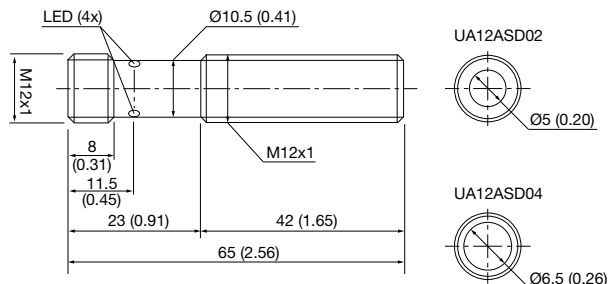

Sensing window, $\text{Ø}5.5$ mm (02), $\text{Ø}6.5$ mm (04)

UA18....

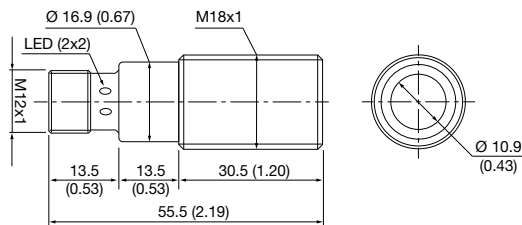

UA 30ASD30..

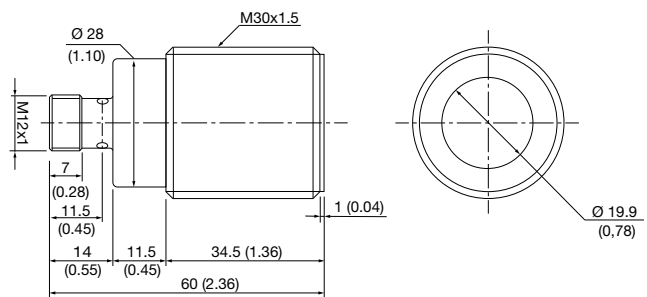

UA 30ASD60..

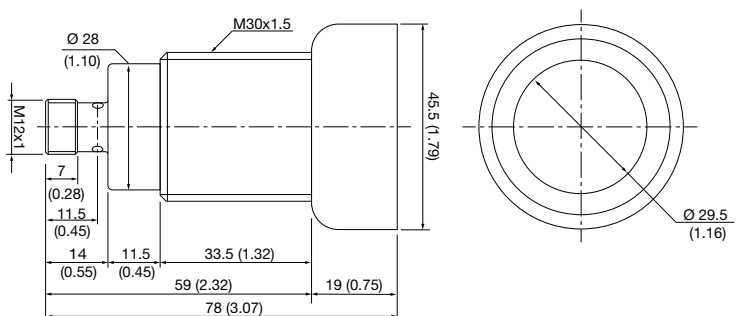

UA12/18/30

Ultrasonic IO-Link sensors

UA12, UA18 and UA30 Analog output

	UA12	UA18	UA30	
				
Sensing range 20...200 mm	UA12ASD02APM1IO			
Sensing range 40...400 mm	UA12ASD04APM1IO			
Sensing range 80...800 mm		UA18ASD08APM1IO		
Sensing range 150...1500 mm		UA18ASD15APM1IO		
Sensing range 300...3000 mm			UA30ASD30APM1IO	
Sensing range 600...6000 mm				UA30ASD60APM1IO
Rated operating distance (S _r)	UA12ASD02: 200 mm, UA12ASD04: 400 mm	UA18ASD08: 800 mm, UA18ASD15: 1500 mm	UA30ASD30: 3000 mm	UA30ASD60: 6000 mm
IO-Link	Transmission type: COM2 (38.4 k Baud), Revision: 1.1, SDCI standard: IEC 61131-9, Profiles: Smart sensor (Process Data Variable; Device Identification), SIO mode: Yes, Required master port type: A, Min. process cycle time [ms]: 5			
Selectable function output 1	Push-Pull, NPN, PNP, Teach, Synchronized, Multiplex			
Selectable function output 2	0-20 mA, 4-20 mA, 0-10 V			
Diagnostic	Sensor, Temperature, Operation hours, Power cycles, Error count, Device status			
Timer functions	ON delay, OFF delay			
Sensitivity adjustment	Teach by wire			
Rated operational voltage (U _b)	18-30 VDC			
No load supply current (I _s)	≤ 40 mA (24 VDC)			
Voltage drop, digital (U _d)	≤ 2 VDC			
Frequency of operating cycles (f)	UA12ASD02: 20 Hz UA12ASD04: 10 Hz	<5 Hz	3 Hz	2 Hz
Response time	≤ 300 ms			
Power on delay (t _i)	≤ 300 ms			
Hysteresis (H) (adjustable by IO-Link)	2...20 mm	6...20 mm	5...50 mm	5...50 mm
Led indications	Green LED: Status Yellow LED: Switching output			
Protections	Short circuits and reverse polarity (except for the analog output PIN2)			
Electrostatic discharge	± 8 kV @ air discharge or ± 4 kV @ contact discharge (IEC 61000-4-2, EN60947-1)			
Fast transient	± 2 kV / 5 kHz (IEC 61000-4-4)			
Wire-conducted immunity	10 Vrms (IEC 61000-4-6, EN60947-1)			
Power - frequency magnetic fields	Continuous: > 30 A/m, 28 μ tesla, Short-time: > 300 A/m, 280 μ tesla (IEC61000-4-8, EN60947-1)			
Electromagnetic field immunity	10V/m (IEC 61000-4-3, EN60947-1)			
Vibration	10 - 55 Hz, 1.0 mm/15 g (EN IEC 60068-2-6)			
Shock	30 gn / 11 ms, 3 pos, 3 neg per axis (EN IEC 60068-2-27)			
Degree of protection	IP67 (EN IEC 60539; EN IEC 60947-1)			
Ambient temperature	Operating: -25° - +70°C (-13° - +158°F), Storage: -25° - +70°C (-13° - +158°F)			
CE marking	According to EN60947-5-2			
Approvals	cULus listed (IND. CONT. EQ. 29W7), UKCA			
Overvoltage category	III (EN IEC 60664; EN IEC 60947-1)			
MTTF _d	110.1 years (EN ISO 13849-1, SN 29500)	128.7 years (EN ISO 13849-1, SN 29500)	116 years (EN ISO 13849-1, SN 29500)	114.8 years (EN ISO 13849-1, SN 29500)
Material	Body: Nickel plated brass, Front: PBT and Filling epoxy resin, Sealing front: PUR			
Connector	M12, 4-pin male			
Dimensions	M12 x 65 mm	M18 x 55 mm	M30 x 60 mm	M30 (49,5) x 78 mm
Weight incl. packaging	18 g	30 g	70 g	140 g
Accessories, additional	Connector type: CO..14NF.. series to be purchased separately			
Further informaion	www.gavazziautomation.com			



UA12, UA18 and UA30 Digital output

	UA12	UA18	UA30	
				
Sensing range 20...200 mm	UA12ASD02BPM1IO			
Sensing range 40...400 mm	UA12ASD04BPM1IO			
Sensing range 80...800 mm		UA18ASD08BPM1IO		
Sensing range 150...1500 mm		UA18ASD15BPM1IO		
Sensing range 300...3000 mm			UA30ASD30BPM1IO	
Sensing range 600...6000 mm				UA30ASD60BPM1IO
Rated operating distance (S _r)	UA12ASD02: 200 mm, UA12ASD04: 400 mm	UA18ASD08: 800 mm, UA18ASD15: 1500 mm	UA30ASD30: 3000 mm	UA30ASD60: 6000 mm
IO-Link	Transmission type: COM2 (38.4 k Baud), Revision: 1.1, SDCI standard: IEC 61131-9, Profiles: Smart sensor (Process Data Variable; Device Identification), SiO mode: Yes, Required master port type: A, Min. process cycle time [ms]: 5			
Selectable function output 1	Push-Pull, NPN, PNP			
Selectable function output 2	Teach			
Diagnostic	Sensor, Temperature, Operation hours, Power cycles, Error count, Device status			
Timer functions	ON delay, OFF delay			
Sensitivity adjustment	Teach by wire			
Rated operational voltage (U _B)	18-30 VDC			
No load supply current (I ₀)	≤ 40 mA (24 VDC)			
Voltage drop (U _d)	≤ 2 VDC			
Frequency of operating cycles (f)	UA12ASD02: 20 Hz UA12ASD04: 10 Hz	<5 Hz	3 Hz	2 Hz
Response time	≤ 300 ms			
Power on delay (t _i)	≤ 300 ms			
Hysteresis (H) (adjustable by IO-Link)	2...20 mm	6...20 mm	5...50 mm	5...50 mm
Led indications	Green LED: Status Yellow LED: Switching output			
Protections	Short circuits and reverse polarity (except for the analog output PIN2)			
Electrostatic discharge	± 8 kV @ air discharge or ± 4 kV @ contact discharge (IEC 61000-4-2, EN60947-1)			
Fast transient	± 2 kV / 5 kHz (IEC 61000-4-4)			
Wire-conducted immunity	10 Vrms (IEC 61000-4-6, EN60947-1)			
Power - frequency magnetic fields	Continuous: > 30 A/m, 28 μ tesla, Short-time: > 300 A/m, 280 μ tesla (IEC61000-4-8, EN60947-1)			
Electromagnetic field immunity	10V/m (IEC 61000-4-3, EN60947-1)			
Vibration	10 - 55 Hz, 1.0 mm/15 g (EN IEC 60068-2-6)			
Shock	30 gn / 11 ms, 3 pos, 3 neg per axis (EN IEC 60068-2-27)			
Degree of protection	IP67 (EN IEC 60539; EN IEC 60947-1)			
Ambient temperature	Operating: -25° - +70°C (-13° - +158°F), Storage: -25° - +70°C (-13° - +158°F)			
CE marking	According to EN60947-5-2			
Approvals	cULus listed (IND. CONT. EQ. 29W7), UKCA			
Overvoltage category	III (EN IEC 60664; EN IEC 60947-1)			
MTTF _d	115.1 years (EN ISO 13849-1, SN 29500)	135.6 years (EN ISO 13849-1, SN 29500)	128.2 years (EN ISO 13849-1, SN 29500)	126.8 years (EN ISO 13849-1, SN 29500)
Material	Body: Nickel plated brass, Front: PBT and Filling epoxy resin, Sealing front: PUR			
Connector	M12, 4-pin male			
Dimensions	M12 x 65 mm	M18 x 55 mm	M30 x 60 mm	M30 (49,5) x 78 mm
Weight incl. packaging	18 g	30 g	70 g	140 g
Accessories, additional	Connector type: CO..14NF.. series to be purchased separately			
Further informaion	www.gavazziautomation.com			



OUR SALES NETWORK IN EUROPE

AUSTRIA

Carlo Gavazzi GmbH
Ketzergasse 374,
A-1230 Wien
Tel: +43 1 888 4112
Fax: +43 1 889 1053
office@carlogavazzi.at

BELGIUM

Carlo Gavazzi NV/SA
Mechelsesteenweg 311,
B-1800 Vilvoorde
Tel: +32 2 257 41 20
sales@carlogavazzi.be

DENMARK

Carlo Gavazzi Handel A/S
Over Hadstensevej 40,
DK-8370 Hadsten
Tel: +45 89 60 61 00
Fax: +45 86 98 15 30
handel@gavazzi.dk

FINLAND

Carlo Gavazzi OY AB
Sinimäentie 8B
FI-02630 Espoo
Tel: +358 9 756 2000
myynti@gavazzi.fi

FRANCE

Carlo Gavazzi Sarl
Zac de Paris Nord II, 69, rue de la Belle Etoile,
F-95956 Roissy CDG Cedex
Tel: +33 1 49 38 98 60
Fax: +33 1 48 63 27 43
french.team@carlogavazzi.fr

GERMANY

Carlo Gavazzi GmbH
Pfnorstr. 10-14
D-64293 Darmstadt
Tel: +49 6151 81 00 0
Fax: +49 6151 81 00 40
info@gavazzi.de

GREAT BRITAIN

Carlo Gavazzi UK Ltd
4.4 Frimley Business Park,
Frimley, Camberley, Surrey GU16 7SG
Tel: +44 1 276 854110
Fax: +44 1 276 682140
sales@carlogavazzi.co.uk

ITALY

Carlo Gavazzi SpA
Via Milano, 13,
I-20045 Lainate
Tel: +39 02 931 76 1
Fax: +39 02 931 76 301
info@gavazziacbu.it

NETHERLANDS

Carlo Gavazzi BV
Wijkemeerweg 23,
NL-1948 NT Beverwijk
Tel: +31 251 22 93 45
info@carlogavazzi.nl

NORWAY

Carlo Gavazzi AS
Melkeveien 13,
N-3919 Porsgrunn
Tel: +47 35 93 08 00
Fax: +47 35 93 08 01
post@gavazzi.no

PORTUGAL

Carlo Gavazzi Lda
Rua dos Jerónimos 38-B,
P-1400-212 Lisboa
Tel: +351 21 361 70 60
Fax: +351 21 362 13 73
carlogavazzi@carlogavazzi.pt

SPAIN

Carlo Gavazzi SA
Avda. Iparraguirre, 80-82,
E-48940 Leioa (Bizkaia)
Tel: +34 94 480 40 37
Fax: +34 94 431 60 81
gavazzi@gavazzi.es

SWEDEN

Carlo Gavazzi AB
V:a Kyrkogatan 1,
S-652 24 Karlstad
Tel: +46 54 85 11 25
Fax: +46 54 85 11 77
info@carlogavazzi.se

SWITZERLAND

Carlo Gavazzi AG
Verkauf Schweiz/Vente Suisse
Sumpfstrasse 3,
CH-6312 Steinhausen
Tel: +41 41 747 45 35
Fax: +41 41 740 45 40
info@carlogavazzi.ch

OUR SALES NETWORK IN THE AMERICAS

USA

Carlo Gavazzi Inc.
750 Hastings Lane,
Buffalo Grove, IL 60089-6904, USA
Tel: +1 847 465 61 00
sales@carlogavazzi.com

CANADA

Carlo Gavazzi Inc.
2430 Meadowpine Blvd Unit 104,
Mississauga, ON L5N 6S2, Canada
Tel: +1 905 542 0979
gavazzi@carlogavazzi.com

MEXICO

Carlo Gavazzi Mexico S.A. de C.V.
Circuito Puericultores 22, Ciudad Satelite
Naucalpan de Juárez, Edo Mex. CP 53100
Mexico
T +52 55 5373 7042
F +52 55 5373 7042
mexicosales@carlogavazzi.com

BRAZIL

Carlo Gavazzi Automação Ltda.
Av. Francisco Matarazzo, 1752
Conj 2108 - CEP 05001-200 -
São Paulo - SP - Brazil
Tel: +55 11 3052 0832
Fax: +55 11 3057 1753
info@carlogavazzi.com.br

OUR SALES NETWORK IN ASIA AND PACIFIC

SINGAPORE

Carlo Gavazzi Automation Singapore Pte. Ltd.
61 Tai Seng Avenue #05-06
Print Media Hub @ Paya Lebar iPark
Singapore 534167
Tel: +65 67 466 990
Fax: +65 67 461 980
info@carlogavazzi.com.sg

MALAYSIA

Carlo Gavazzi Automation (M) SDN. BHD.
D12-06-G, Block D12,
Pusat Perdagangan Dana 1,
Jalan PJU 1A/46, 47301 - Petaling Jaya,
Selangor, Malaysia
Tel: +60 3 7842 7299
Fax: +60 3 7842 7399
info@gavazzi-asia.com

CHINA

Carlo Gavazzi Automation
(China) Co. Ltd.
Unit 2308, 23/F.,
News Building, Block 1, 1002
Middle Shennan Zhong Road, Futian District,
Shenzhen, China
Tel: +86 755 8369 9500
Fax: +86 755 8369 9300
sales@carlogavazzi.cn

HONG KONG

Carlo Gavazzi Automation
Hong Kong Ltd.
Unit No. 16 on 25th Floor, One Midtown,
No. 11 Hoi Shing Road, Tsuen Wan,
New Territories, Hong Kong
Tel: +852 26261332
Fax: +852 26261316

TAIWAN

Branch of Carlo Gavazzi Automation
Singapore Pte. Ltd.
12F-3, No. 530, Yingcai Rd.,
West Dist., Taichung City 403518,
Taiwan, China
Tel: +886 4 2258 4001
Fax: +886 4 2258 4002

OUR COMPETENCE CENTRES AND PRODUCTION SITES

DENMARK

Carlo Gavazzi Industri A/S
Hadsten

MALTA

Carlo Gavazzi Ltd
Zejtun

ITALY

Carlo Gavazzi Controls SpA
Belluno

LITHUANIA

Uab Carlo Gavazzi Industri Kaunas
Kaunas

CHINA

Carlo Gavazzi Automation (Kunshan) Co., Ltd.
Kunshan

HEADQUARTERS

Carlo Gavazzi Automation SpA
Via Milano, 13
I-20045 - Lainate (MI) - ITALY
Tel: +39 02 931 76 1
info@gavazziautomation.com

Energy to Components!

www.gavazziautomation.com