

CABLE CHAINS CABLE CHAINS CABLE CHAINS CABLE CHAINS

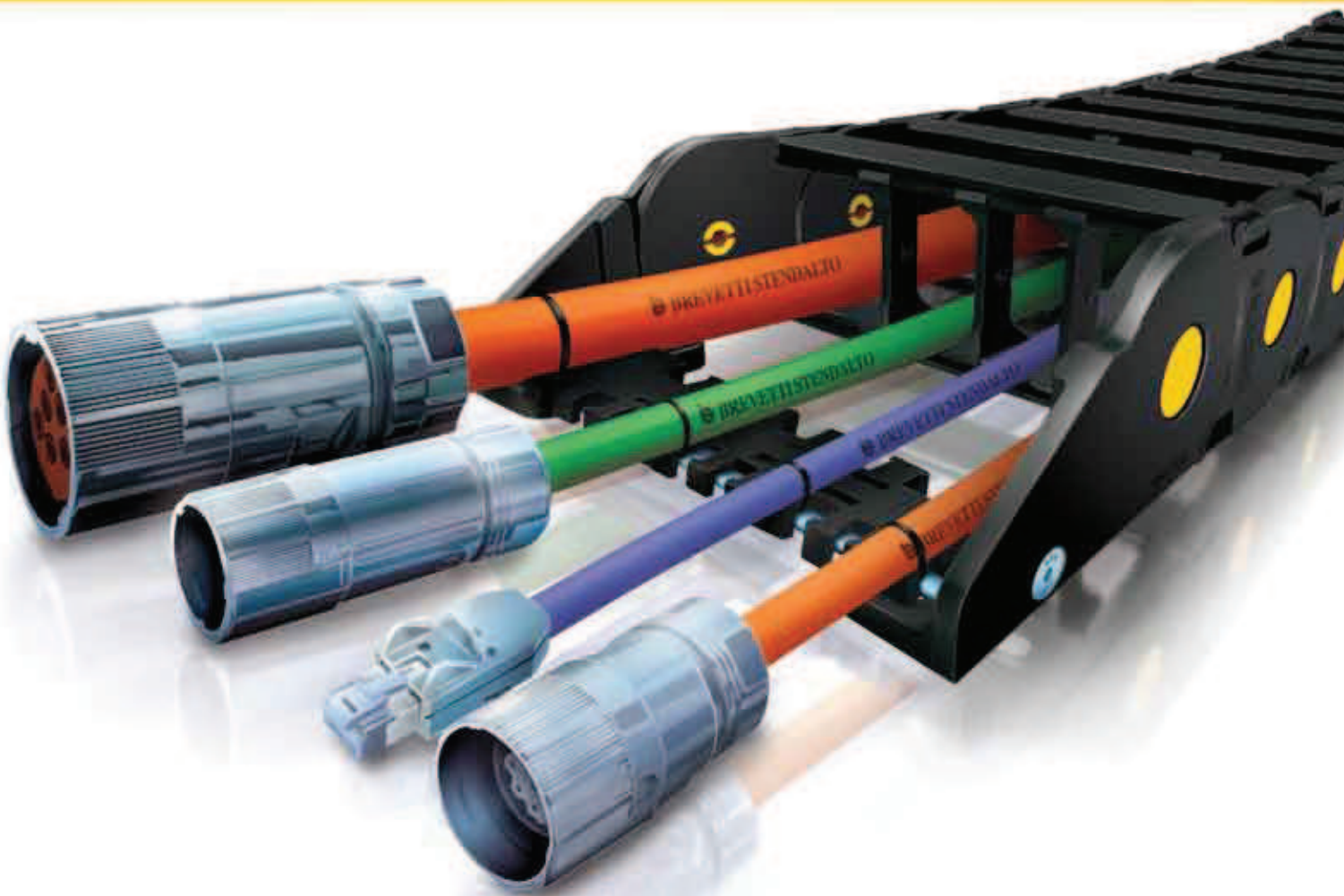

# Summary

---

**Company Profile**

**1**

**Technical Information**

**2**

**Nylon Cable Chains**

**3**

**Steel Cable Chains**

**4**

**Steel Cable Conduit**

**5**

**Cable Chain Cables**

**6**

**Enquiry and Order Form**

**7**

**Overview of Products Range**

**8**

---



# Brevetti Stendalto

1



Brevetti Stendalto is the name of the Company founded almost 40 years ago when a highly dynamic new demand, emerging from the boost of automation concepts, was spreading over the most developed industrialized countries.

At that time, Mr. Giovanni Mauri (President and founder of Brevetti Stendalto) designed and started proposing nylon cable chains to be applied where steel cable chains were too heavy and expensive to fulfil customers' needs.

Looking beyond, he got off more than a new line of products, he gave the original profile to the Company: a successful collection of innovation, technical support, pragmatic solutions and products with the best cost & benefit ratio, able to give customers a real added value to the long-term partnership with Brevetti.

The constant evolution of the Company is presently borne through a wide range of plastic, steel and stainless steel chains for all kinds of applications, new modern premises in Monza and Mesero, branches in France and Germany and a consolidated worldwide sales network.



1989  
Patent for the circular nylon cable chain.

Glancing at short-term future, Brevetti is working on three main directions: development of customized chains for special projects, support to buyers and designers to make their choices more efficient through a real problem-solving approach, and extension of our range of standard products,

The latter, in particular, is necessary to meet the newest market requirements for higher performances with acceptable costs. Brevetti's greater and greater experience in all industrial sectors makes it easier.

We in Brevetti believe that some special applications, such as offshore platforms and harbour cranes, must be faced with non-ordinary means. That is why we decided to give our customers the support of a "Special Projects Division" available to study customized solutions all over the world.

We always keep in mind that our customers have to be "free to project". This is Brevetti Stendalto's philosophy, and to empower it, we can offer our "Total Chain System", a new concept of cable chains completely finished with extra flexible cables and connectors. From the customer's point of view, it means saving costs due to wiring, assembling and installation time, reducing possible problems, and being certain to choose components of the highest reliability available on the market.

So, let's keep on growing together, still going ahead.



Chain testing rig for long travel: Tests at 8 m/s for 130 m travels.

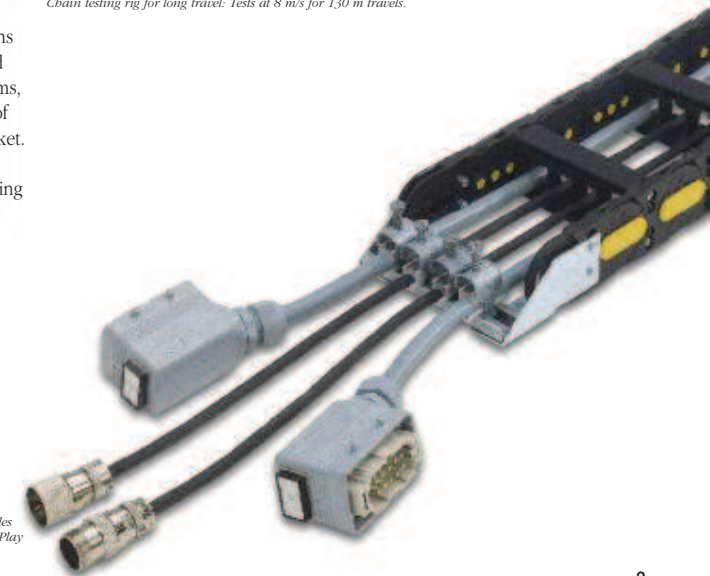

Chain complete with cables and connectors: Plug & Play solution.

# Versatile Automation

1



Production moulds are manufactured using modern CNC machine-tools.



Each aspect of production, whether it be the preparation of moulds and their subsequent shaping or component manufacture and assembly, is monitored closely.

The Company endeavours to adopt the most up-to-date technology available. Considerable resources are invested into this, ensuring the highest standard of products on the market. Production moulds are manufactured using modern CNC machine-tools.

Mould of Light series cable chain.  
Brevetti Stendalto manufacturing process (internal moulding department and complete automated assembly lines) ensures quality and short delivery times.  
Complete automated assembly lines ensure a high standard of quality chains.

**Products**

- Nylon cable chains
- Steel cable chains
- Cable chain cables

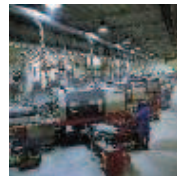

Completely automated assembly lines ensure a high standard of quality chains.



Production moulds are manufactured using modern CNC machine-tools.

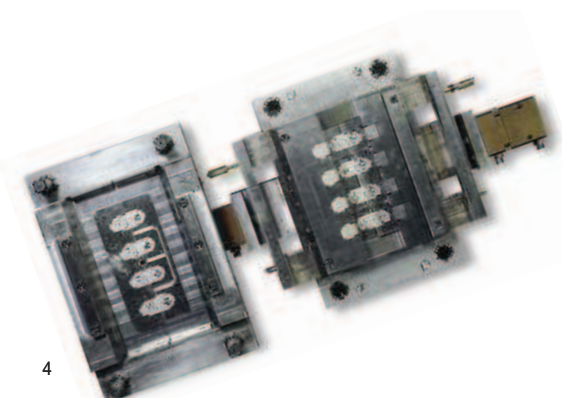

# UNI EN ISO 9001:2008

1

In Brevetti Stendalto the quality is a result of our activities. To be a success and reference company Brevetti Stendalto strives for:

- full satisfaction of our customers ever increasing requests.
- continuing improvement of our company capacities.
- valorization and improvement of our human resources.
- involvement of all our staff in striving for quality assurance.
- careful selection of suppliers and involvement of these in our quality process.
- standardization of production, to assure competitive products.
- innovative products to meet the markets ever increasing requests.
- fast assistance to guarantee the customers reduced breakdown time.



Certificate UNI EN ISO 9001:2008

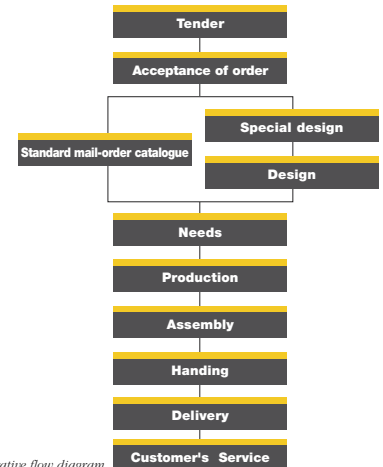

Operative flow diagram



# The Way to Automation

Past experience acquired in the marketing of machine tools has prompted Brevetti Stendalto to diversify its proposals. Today, thanks to products from Brevetti Stendalto, present day problems in cable and tubing protection are solved in the best possible way.

Our products can be found in many applications, especially in the field of automated production, for example in industrial robots and machinery for crafting metal, wood and stone.

Brevetti Stendalto products are used in many, very different, fields of application. We have experience ranging from packaging & automated handling, storage and transportation to providing solutions used in all fields of engineering like mining, offshore drilling, building, in steel works, ports and terminals.

We are always close to our Clients. Our distribution network, consisting of manufacturing plants, sales companies and warehouses, is spread across the entire world.



Welding robot equipped with nylon chains.



Steel chain 30.



318 for long travel distance on a crane application.



Machine tools equipped with Heavy series cable chains.



Circular nylon chains on welding robots.

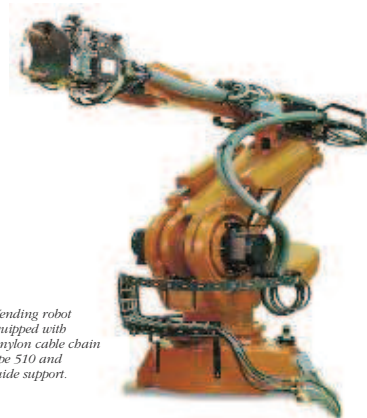

Wending robot equipped with a nylon cable chain type 510 and guide support.

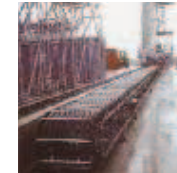

35 steel chains with supporting frame applied to De Icing's equipment at München airport (Germany).



310 plastic chains and 45 stainless steel chains applied to "Oresund Bridge" between Sweden and Denmark.

# Always Available

1



All cable chains are studied with the support of CAD-CAM systems.

Each Client is important to Brevetti Stendalto regardless of the needs and the size of his request. Brevetti Stendalto offers professional support for assessing the Client's needs, consultation inherent to the choice of products, design of new products, design of a new product and visiting *client* installations.

## Technical Office

Competence and availability are the key words in technical assistance. All technical needs and installation characteristic requests are carefully evaluated and verified with the support of informatics and CAD-3D projection that will solve the problems as they arrive.

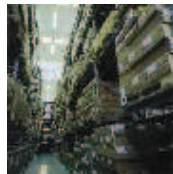

Computerised stock management and control system ensures short delivery times.



Brevetti Stendalto's technical office is the reference-point for information.



To offer a rapid and always updated commercial and technical information, Brevetti Stendalto has introduced a new web-site **www.brevettistendalto.it** in which all necessary info is available for fast chain selection and easy downloads of chain characteristics. For direct technical support, please contact our Technical Dept. at **tekn@brevettistendalto.it** which will assist you with specific technical questions, customized chain solution, CAD drawings, etc.

1

Brevetti Stendalto is always close to customers, ensuring assistance from project analysis up to final installation and after sales support.







## Technical Information

Necessary data to determine the type of cable chain	page 12
Placement of cables/hoses in the cable chain	page 13

### Mounting Variations

Chains placed horizontally	page 14
Chains placed vertically	page 16
Chains with circular motion	page 17

### Going Further

Self-supporting capacity	page 18
Determining the length of the chain	page 19
Vertical applications	page 20
Horizontal applications (side-mounted)	page 21
Long horizontal travel distances	page 22
Guide channels for sliding chains	page 24
How to install the cable chains in the guide channel	page 25
Rotating horizontally	page 26
Rotation with Robot type chains	page 28
Support roller units	page 30
Way of mounting end brackets	page 31
Guide channel	page 32
Split cross pieces from the Heavy/Sliding series	page 33
Materials used	page 34

## Necessary Data to Determine the Type of Cable Chain

The choice of cable chain should not only be based on a mathematical calculation of certain factors but should consider and analyse carefully all the available data. The following information will provide a basic help in making the right decision.

Thanks to thirty years of experience in this sector we have a highly competent technical staff which is at your disposal to help solve any problem relating to the use of cables in any kind of application.

To request a personalised project please fill out the form found on page 249. It will be a pleasure for us to find an immediate solution to your problem.

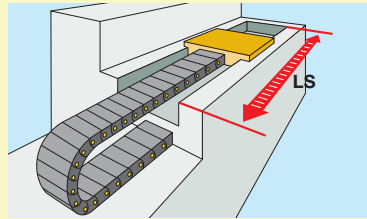

Determining the length of the travelling distance LS.

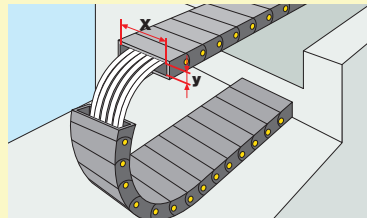

The dimensions of the cable chain in relationship to the dimensions of cables/hoses.

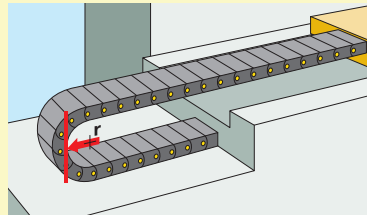

Determining the radius of curvature of the cable chain in relationship to the flexibility characteristics of cables/hoses.

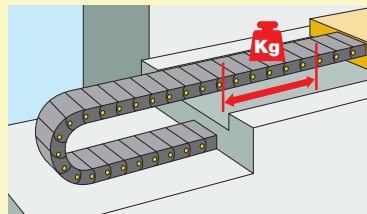

Verifying the self-supporting capacity of the cable chain in relationship to the weight per metre of cables/hoses.

## Placement of Cables/Hoses in the Cable Chains

To guarantee that cable chain functions properly and to avoid any damage to the cables/hoses within, certain criteria concerning the placement must be followed:

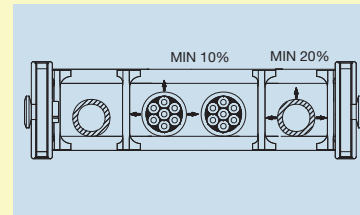

For electric cables a clearance of at least 10% between the placement of the cable and its diameter has to be guaranteed; for hydraulic hoses the clearance should be at least 20%.

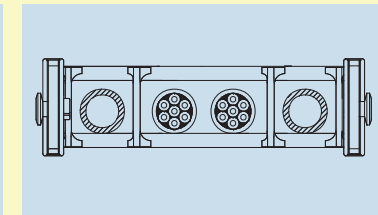

Avoid placing cables/hoses that have different sheath finishes so that friction can be eliminated. (e.g. hydraulic cables and hoses).

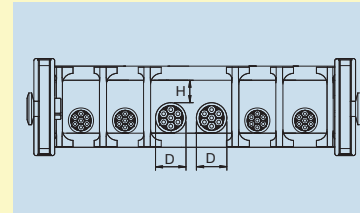

In the application of several cables/hoses it is preferable to avoid them rubbing each other by placing them singularly in the appropriate space and separating them from each other by the separators. If this is not possible, verify that the internal space does not allow the rubbing of the cables/hoses. ( $H < D$ ).

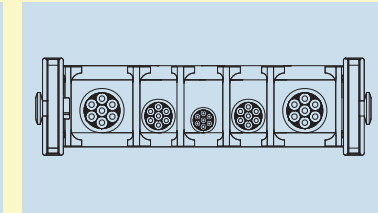

Place cables/hoses in a symmetrical way according to their dimensions and weight placing the largest and heaviest externally and the smaller and lighter internally.

For further information on how to install cables/hoses see page 246.

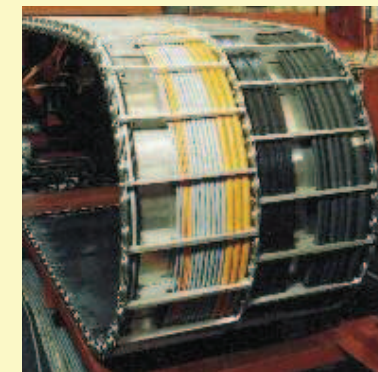

A 30 chain in steel with three bands and separators between electric cables and hydraulic hoses..



# Mounting Variations

## Chains Placed Horizontally

Brevetti Stendalto chains, thanks to a large range of models and versions, satisfy many requirements in variety and combination of motions. On this page the various combinations of mounting are listed.

For further information about realising a personalised project please contact our technical department. They are at your disposal to resolve any specific problems you may have and can design according to your particular request.

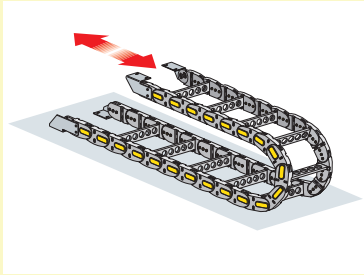

Horizontal with mobile point above.

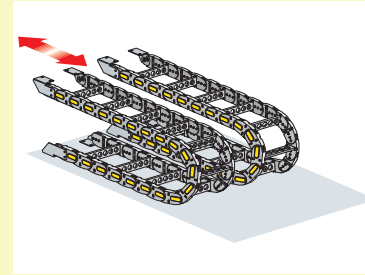

Chains positioned in parallel.

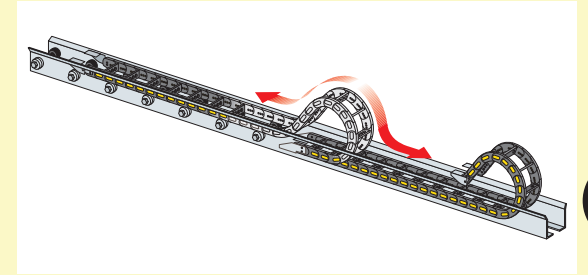

Long horizontal - 1 chain (see page 22).

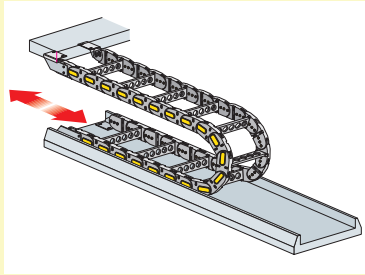

Horizontal with mobile point below (to the car).

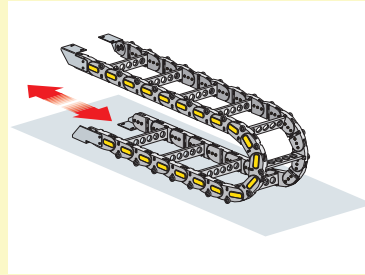

Horizontal with mobile point below.

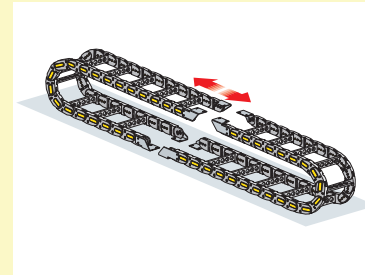

Chain making a ring configuration.

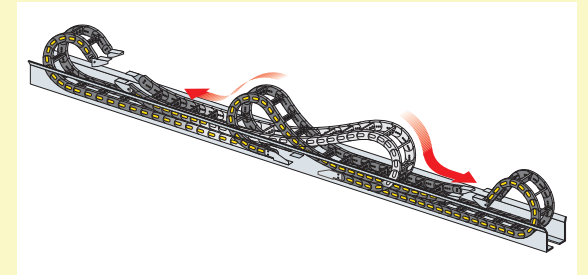

Long horizontal - 2 chains (see page 22).

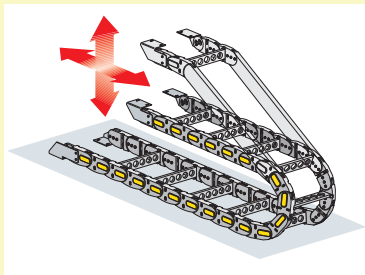

Combination of both vertical and horizontal movement.

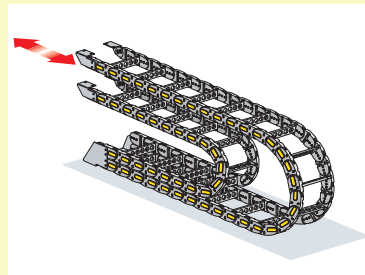

Superimposed chains.

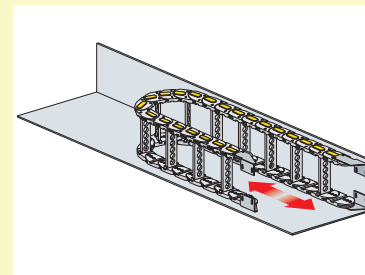

Horizontal with chain mounted on its side (see page 21).

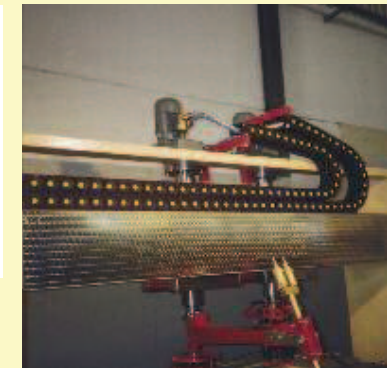

Model 700 chains in nylon superimposed on a machine which works with marble.

# Mounting Variations

## Chains Placed Vertically

Brevetti Stendalto chains also provide answers to problems concerning vertical motion. Thanks to their particular design Brevetti Stendalto cable chains can also be used in applications with extremely long travel distances.

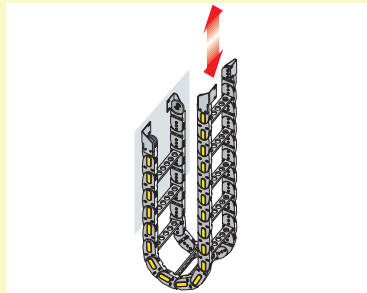

Vertical with curve below  
(see page 20).

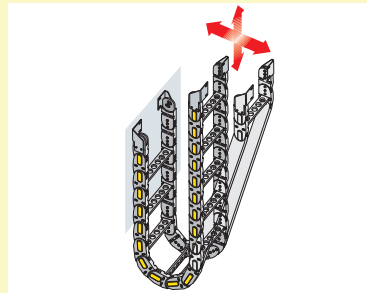

Combination of both vertical and horizontal movement.

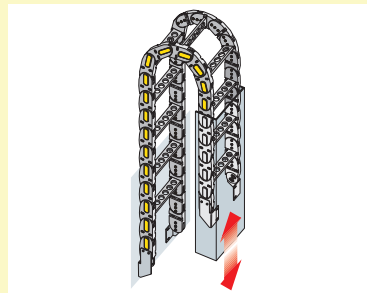

Vertical with curve above  
(see page 20).

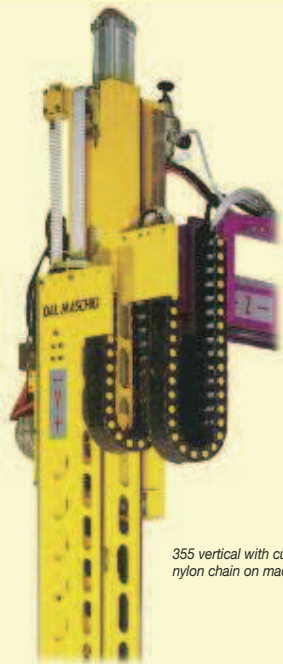

355 vertical with curve below  
nylon chain on machine tool.

## Chains with Circular Motion

The problems regarding circular motion are easily resolved with the chains from the ROBOT series, an exclusive Brevetti Stendalto product. It is also possible to use the chains in counter-rotation configuration by mounting them on their side.

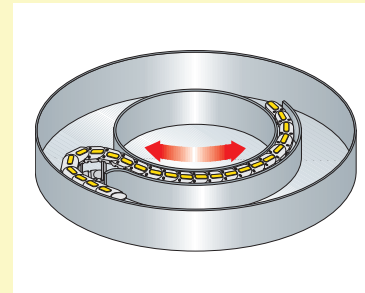

Chain for circular movement - 1 chain  
(see page 26).

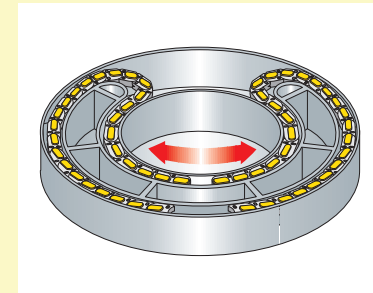

Chain for circular movement - 2 chains  
(see page 26).

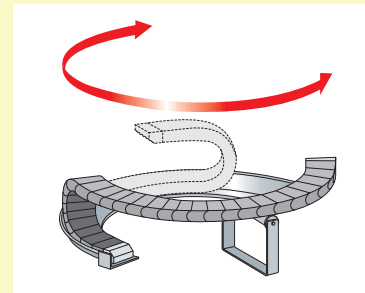

ROBOT type chain for circular motion.  
(see page 28).



Robot for welding with chains  
in nylon.



## Self-Supporting Capacity

A fundamental element in cable chains is the pre-set Z (Fig. A).

This determines the self-supporting capacity, a characteristic which allows the cable chain to support not only its own weight, but also the weight of the cables/hoses placed in it and to keep its parallel or slightly curved upward position (Fig. B).

The diagram of self-supporting capacity (Fig. C), indicates the weight relation of cables/hoses per linear meter to the lengths of self-supporting chain travel. The red-area indicates the difference between min/max chain widths, while the widest version has the lowest self-support capacity. With the application of cable chains with  $\frac{LS}{2}$  and weights not included in the area of the  $^2$  diagram of self-supporting capacity, it's

necessary to use the appropriate support rollers (see page 30), in order to confirm chain reliability in exceptional applications.

All the H-heights reported into this catalogue are not including any Z-value due to the preload, therefore, whenever limitations to the maximum allowable height are required, you should refer to Brevetti Stendalto's Technical Dptm.

Brevetti Stendalto chains, thanks to their specific construction, reach remarkably high values of self-supporting capacity and acceleration with long periods of motion, reaching millions of cycles.

For particular applications (e.g. vertical travel), the chains can be provided without pre-set.



Fig. A

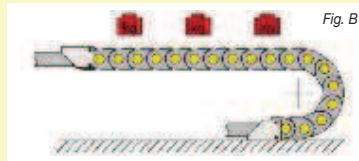

Fig. B

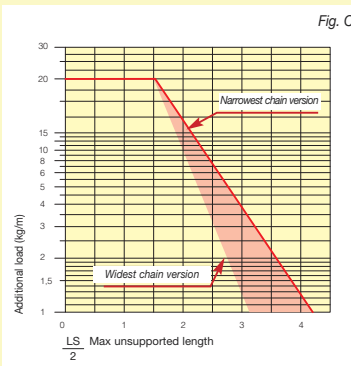

Fig. C



Nylon chain, type 310, in a self-supporting state.

## Determining the Chain length

### Fixed point at the centre of total travel.

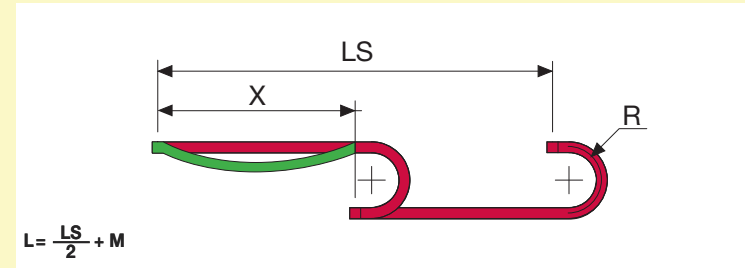

The chain length (**L**) is calculated by summarising the half stroke  $\frac{LS}{2}$  to the nominal value (**M**) of the bending radius. The value is then rounded up the multiply of the chain's pitch for nylon cable chains and to an odd multiply for steel chains.

### Fixed point not positioned at the centre of total travel.

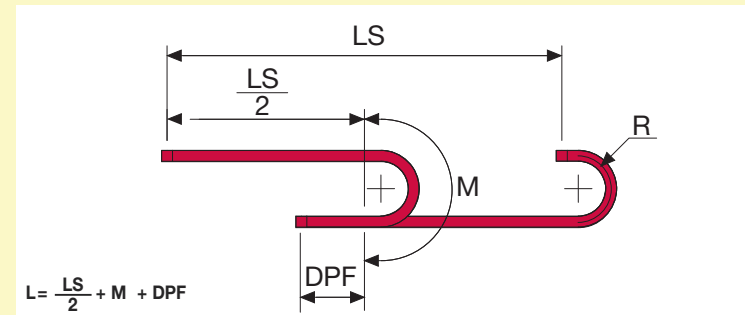

The chain length (**L**) is calculated by summarising the half stroke  $\frac{LS}{2}$  to the nominal value (**M**) of the bending radius and the distance (**DPF**) from fixed point to centre of total stroke. The value is then rounded up the multiply of the chain's pitch for nylon cable chains and to an odd multiply for steel chains.

Where:

**L** = Length of chain

$\frac{LS}{2}$  = Half travel distance

**M** = Length of curve ( $\pi \times R$ ) + ( $2 \times P$ )

**DPF** = Distance from fixed point to centre of total stroke

**P** = Pitch

## Going Further

### Vertical Applications

The problems related to vertical applications are solved by using Brevetti Stendalto cable chains. It is however necessary to respect the following:

The use of standard cable chains for vertical applications could result in difficulties due to the pre-set. we therefore recommend to specify: "without pre-set for vertical applications" when ordering. By doing this the cable chain will be delivered to you without pre-set.



The placement of the cable/hoses is very important to ensure the application works properly. Cables/hoses have to be fixed at both ends using the appropriate accessories so as not to make their weight disturb the cable chain. In this type of application the cable chain should only guide the cables/hoses during their movement.

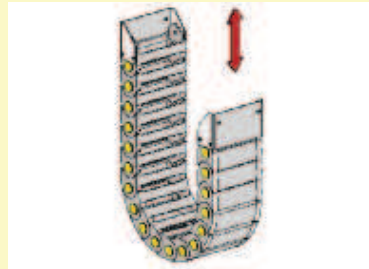

If the application only concerns one vertical movement the cable chain does not need any particular support.

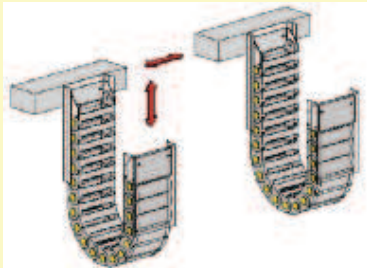

If the cable chain also moves across and/or longitudinally, certain measures have to be taken laterally. For special applications, frames with completely closed guiding systems are available.

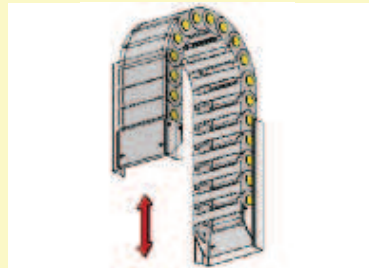

When applying the cable chain in this way some support is needed to avoid the chain to unbalance itself outwardly. Generally the cable chain must be supported both on the fixed and mobile points.



## Going Further

### Horizontal Applications on Their Sides

Brevetti Stendalto cable chains can be mounted on their sides.

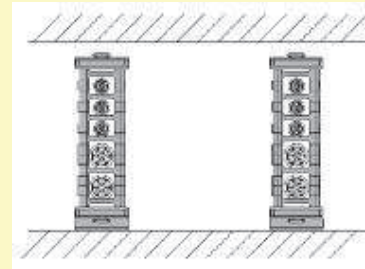

This kind of mounting becomes necessary when there is a limited space upwards and mounting the chain normally would take up too much space.

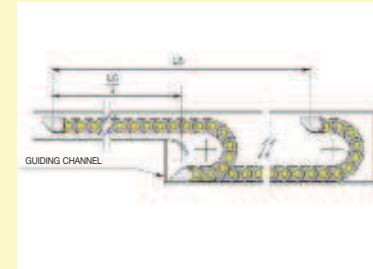

For particularly long applications a guiding channel can be designed.

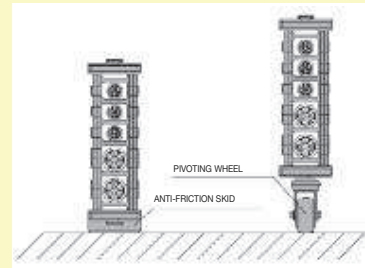

To make the movement easier and to reduce any friction on the cable chain, special changeable anti-friction skids or pivoting wheels have been designed.

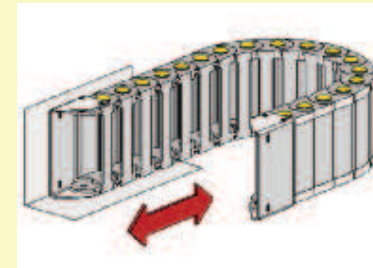

If there is no possibility for a plane to support the cable chain during its movement, Brevetti Stendalto chains can be applied without support taking into consideration the following factors:

- total travel distance LS
- added weight
- velocity and acceleration
- frequency of usage

For this kind of application, it is recommended to discuss with our technical office.

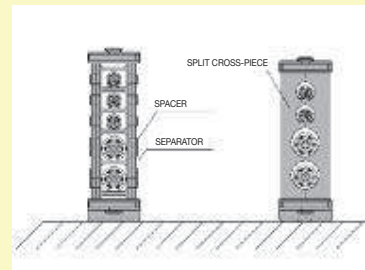

Particular attention should be drawn to determine the section of the cable chain, in fact, the mounting on its side of the chain means that cables/hoses have a tendency of bunching towards the ground and being squashed.

To avoid this, there are special spacers which are positioned between the separators or otherwise special split aluminium or PVC cross pieces to be applied.

# Going Further

## Long Horizontal Travel Distance

Cable chains are used more frequently on long travel distances as a valid alternative to the traditional systems of conductor bars or to festoon systems, and offer the following advantages:

- The possibility of the combined transportation of hydraulic cables/tubes.
- The possibility of use also in critical environments (humidity, textile dust, negative chemical and atmospheric components etc.).
- High velocities and values of acceleration.
- Notably shorter installation times.
- Drastic reduction in the time taken for maintenance.

The special aspect of the cable chains in the

Sliding series is the integrated sliding skid which permit the chains to slide on themselves reducing the friction due to the special polymers used.

The dimensions of the skid allow the chain to keep itself stable in applications with high velocities.

On request it's possible to produce cable chains with special polyamides for applying in particularly aggressive environments.

The triple pins guarantee more reliability and strength even in applications with the added weight being very high. The chains in the Sliding series have been tested using torsion, wear and tear tests passing the tensile yield stress with extremely good results, above high normal values (e.g. 318 21000 N).

2

*In these applications, the chain without self-supporting capacity, slides in its own guiding channels. For the first half of the travel distance the chain slides on itself, whilst in the second half it is supported by its own rollers or plates for sliding.*

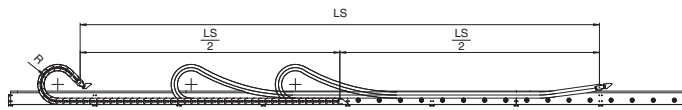

*In double chain applications, the chains slide on themselves in both directions.*

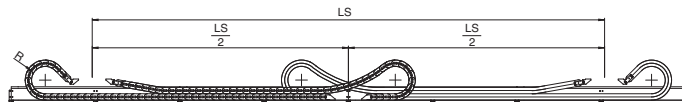

*A particular of the skid in the sliding of the chains in the Sliding series.*

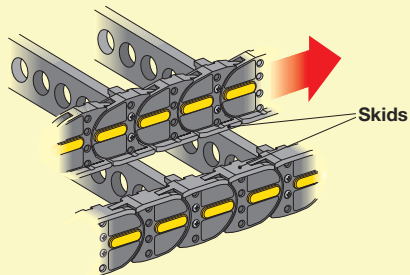

318 type chain.



318 type chain.

2



# Going Further

## Guide Channels for Sliding

For good results when using cable chain in an application with a long travelling distance it is necessary to respect the following instructions when installing the guide channel for sliding:

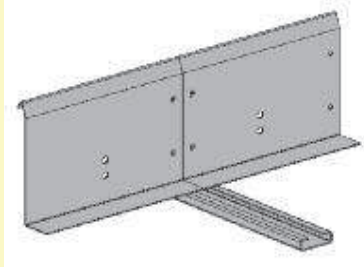

Verify that the sides are aligned properly to avoid any internal edges in the guide channel which could disturb the cable chain's route.

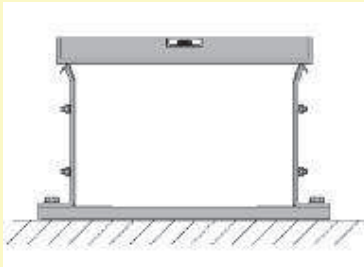

Verify that the plane on which the guide channel for sliding is mounted is perfectly aligned and smooth.

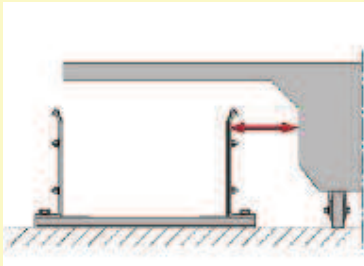

Verify that the distance between the guide channel for sliding and the towing arm is the same for the whole travelling distance.

2

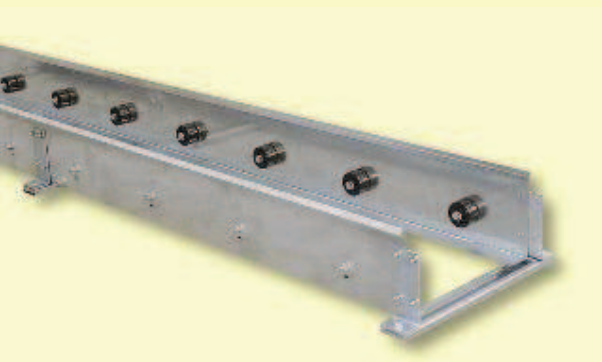

Guide channel for chains of the Sliding series.

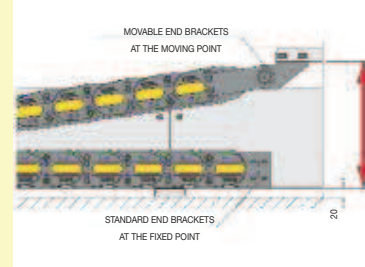

Install the cable chain with the standard end brackets at the fixed point and with the movable end brackets at the moving point respecting the height listed in the catalogue.

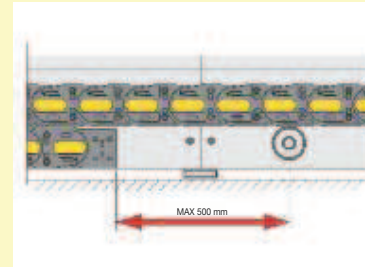

Reduce as much as possible the distance between the fixed point of the cable chain and the starting point of the rollers or sliding plane.

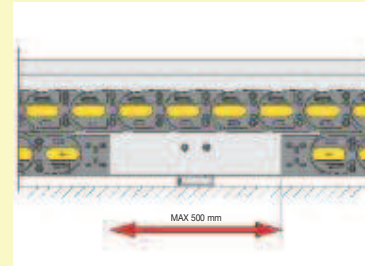

In the case of a double chain application ensure that the distance between the two fixed points doesn't exceed 500mm.

## How to Install the Cable Chains in the Guide Channel

For a perfect installation of the cable chain in the guide channel you should take the following steps:

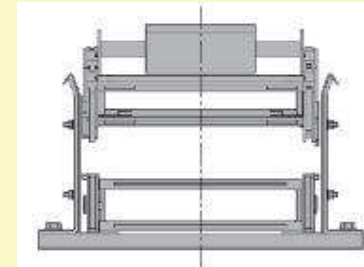

Install the mobile point of the cable chain aligning it exactly to the longitudinal travel distance in such a way so that during its movement it does not touch the internal part of the guide channel (Fig. A).

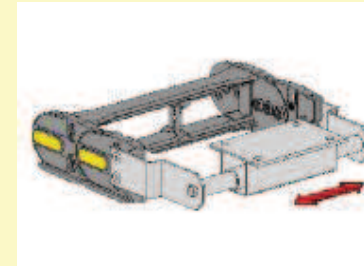

To facilitate this operation Brevetti Stendalto has developed and created a special movable end bracket which guarantees a perfect alignment between the chain and the towing arm (Fig. B).

2



# Going Further

## Rotating Horizontally

For certain applications it is necessary that the cable chains perform an opposite movement from that determined by the radius of the curvature (counter-radius chains). All Brevetti Stendalto chains, except those from the

PROTECTION series, can be supplied with this counter-radius. Generally the chains with counter-radius are used to resolve the problems relative to rotations where, in this case, it would not be possible to use cable chains from the ROBOT series.

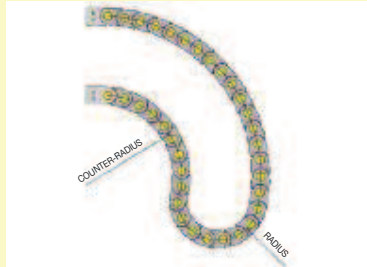

With the use of counter-radius chains it is possible to create rotations both on small and large equipment (e.g. parabolic antennas, rotating tables, cranes, telescopes).

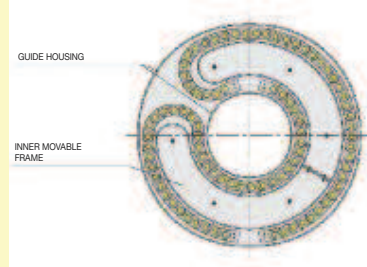

For applications with rotations over 180° it is necessary to use two cable chains. For a correct usage they should be guided both internally and externally. A special inner movable frame, mounted on anti-friction skids or pivoting wheels in combination to the guide housing guarantees the rotation.

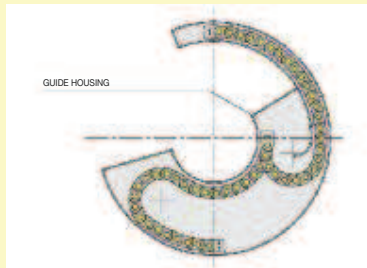

For applications with rotations up to 180° it is possible to use only one cable chain. For a correct usage it should be installed with a guide housing.

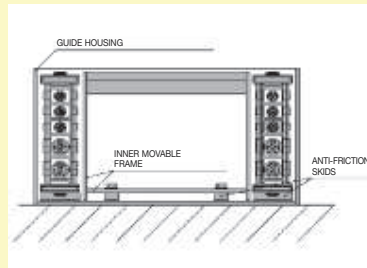

To facilitate the sliding and reduce the friction of the cable chain, special changeable skids or pivoting wheels are taken into account. With this kind of application it is also possible to rotate vertically. Seen the particular aspects of these applications we advise you to contact and consult our technical office.

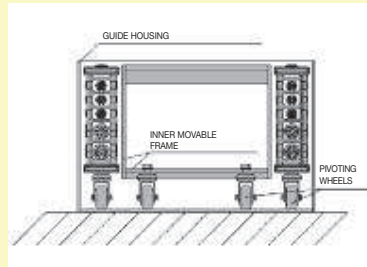

## Application of Horizontally Rotating Chains

Chains can reach a maximum rotation of 540°. For a correct usage they should be guided both internally and externally.

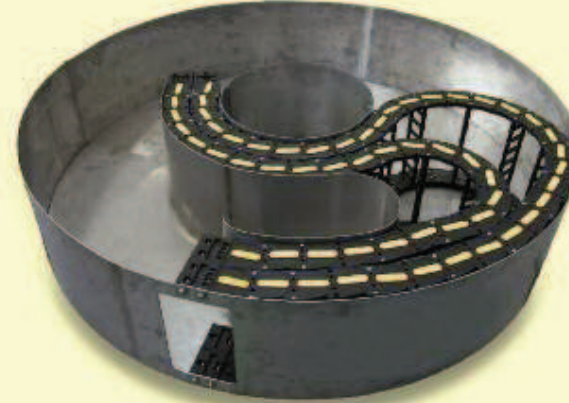

Application with 2 superimposed chains. Rotation 180°

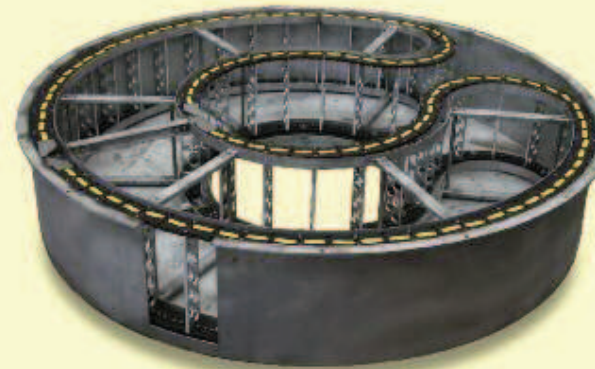

Application with 2 chains. Rotation 370°

### Rotation with ROBOT Type Chains

In its continuous technological evolution, Brevetti Stendalto has revolutionised since 1989 the concept of circular chains introducing the chains from the "ROBOT" series that, due to the particular construction of the links, permit them to rotate up to 540°.

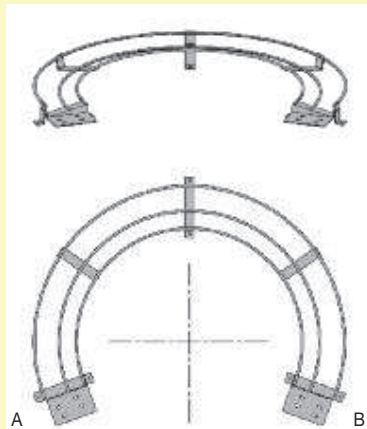
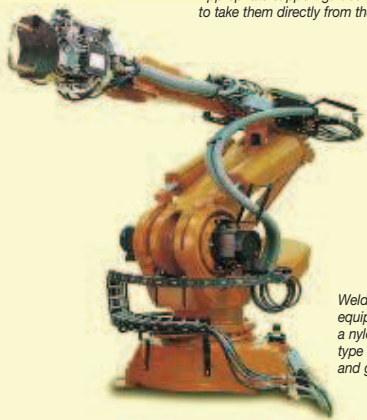

Fig. A

The stability of the chains permits rotations at higher velocities without the need for guiding supports. Only the base on which the cable leans has to have a configuration inclined to make its own travel distance easier. Appropriate support guides are available if it is not possible to take them directly from the machine.



Welding robot equipped with a nylon cable chain type 510 and guide support.

The chains from the "ROBOT" series, like all Brevetti Stendalto chains, can be modified for work in special applications.

When the use of one cable chain is not sufficient to contain all the cables/hoses it's possible to use several chains in the same application to increase the space to hold them.

### Supporting Hook

This must be selected according to the method of chain fixation.

-Left type with left fixed point chain (A)

-Right type with right fixed point chain (B)

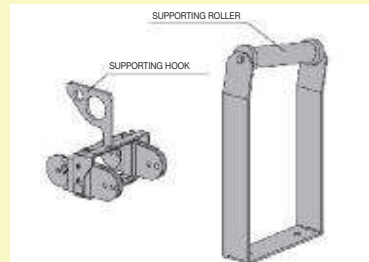

The chains from the "ROBOT" series are self-supporting and they do not need any support up to 200°. For applications with rotations exceeding that value it is necessary to use its own appropriate accessories. To reduce the problems of taking up too much space which generally is the case with the supports, especially on robots, Brevetti Stendalto has developed a series of supports which are capable of solving the problem.

### Applications with Robot Series Chains

Using support rollers or support hooks, chains can reach a maximum rotation of 540°.

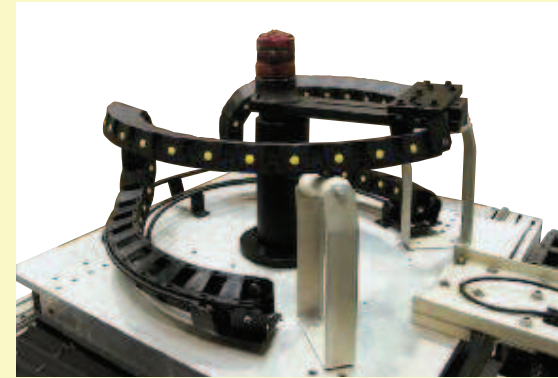

Support rollers view.



Support hooks view.

# Going Further

## Support Roller Units

For applications of cable chains with  $\frac{LS}{2}$  and weights not included in the area of the diagram of self-supporting capacity it is

necessary to use the appropriate support rollers.

To decide on the number of support rollers needed, note the following:

### One Support Roller when:

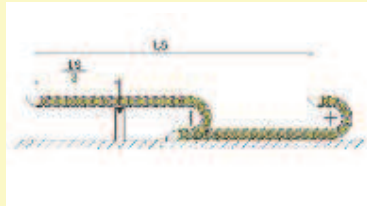

The length  $\frac{LS}{3}$  is included in the values of the diagram showing self-supporting capacity.

### Two Support Rollers when:

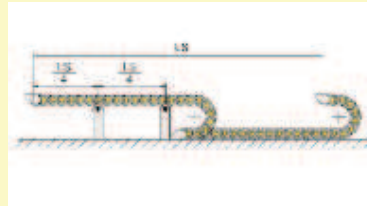

The length  $\frac{LS}{4}$  is included in the values of the diagram showing self-supporting capacity.

### Support Roller for Nylon Chains

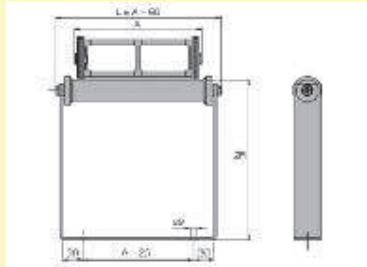

### Support Roller for Steel Chains

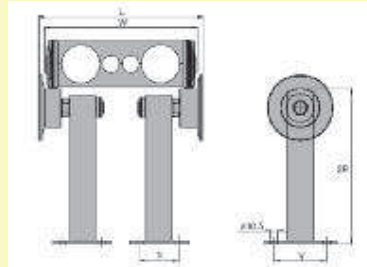

Chain Type	X	Y	L
20	70	100	W+22
30	70	100	W+22
35	70	100	W+26
40	70	100	W+26
45	130	180	W+26

## Ways of Mounting End Brackets

The end brackets make the installation of the chains possible. They are available both in nylon and in steel. The end brackets in nylon, due to their particular construction with holes for mounting on three sides, allow the chain to be installed in the four positions seen below. For the end bracket in steel instead it is necessary to specify the position of mounting. If this is not specified it will be supplied in Pos.1.

Our technical office is at your disposal to solve any installation query.

Pos. 1

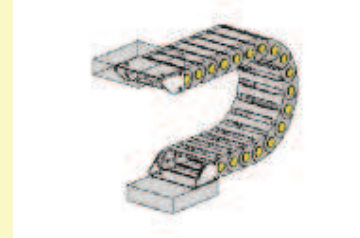

Pos. 2

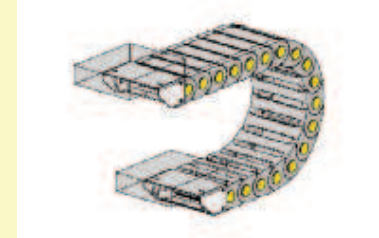

Pos. 3

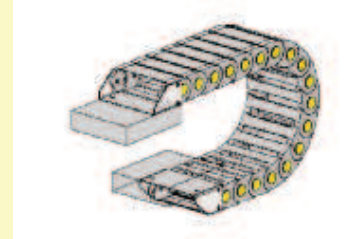

Pos. 4

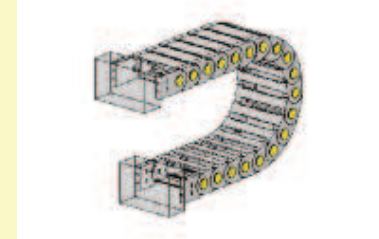

Pos. 5

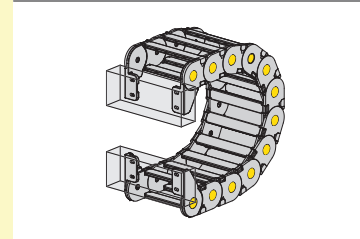

Pos. 6

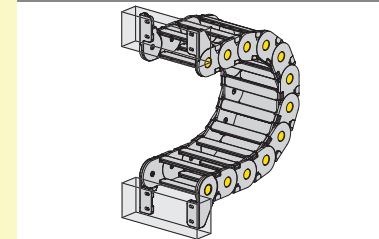

# Going Further

## Guide Channel

For a correct functioning of the cable chain it is necessary that during its movement it lies on a flat surface. If these conditions do not exist a guide channel is necessary.

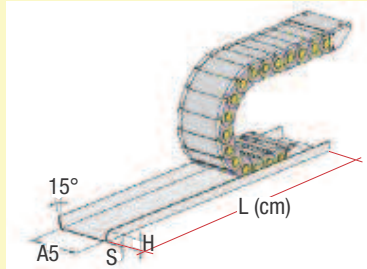

2

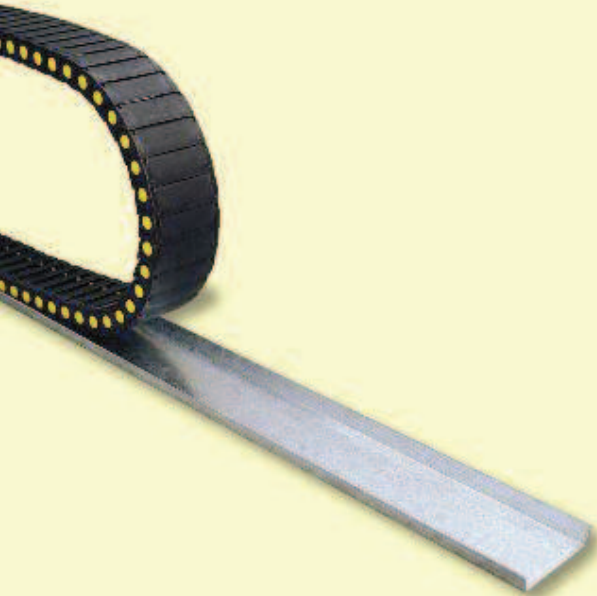

Chain type	A5 mm	H mm	S mm
200...	A+2	10	1,5
250...	A+2	10	1,5
30090-30091	A+2	15	1,5
325LI/LE...	A+2	25	1,5
325L... / 325PI...	A+2	25	1,5
335...	A+2	30	1,5
339...	A+2	30	1,5
300A...	A+2	15	1,5
300...	A+2	15	1,5
305A...	A+2	20	1,5
305...	A+2	20	1,5
355A...	A+2	25	1,5
355...	A+2	25	1,5
400...	A+2	25	1,5
435...	A+2	30	1,5
445...	A+2	30	1,5
660A...	A+2	30	1,5
770A...	A+2	30	1,5
475...	A+2	50	1,5
306...	A+2	30	1,5
307...	A+2	30	1,5
308...	A+2	40	1,5
309...	A+2	50	1,5
310T...	A+2	80	1,5
660...	A+2	30	1,5
770...	A+2	30	1,5
20...	W+2	30	1,5
30...	W+2	40	1,5
35...	W+2	50	
40...*			
45...*			

\*Seen the particular aspects of these chains we advise consultation with our technical office.

The guide channel is delivered in laminar zinc in pieces of 2000 mm. It is available on request in stainless steel.

Guide channel for chain type 355.

## Split Cross Pieces Heavy/Sliding Series

The chains from the Heavy and Sliding series are developed with two side-bands of chain connected with split cross pieces that can be

chosen between a wide number of styles to suit most various requests.

### Standard Versions:

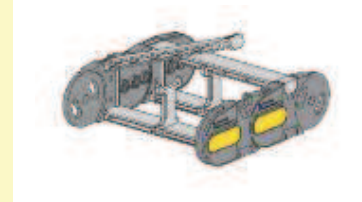

The new nylon split cross piece can open by an easy to open hinge, offering a security.

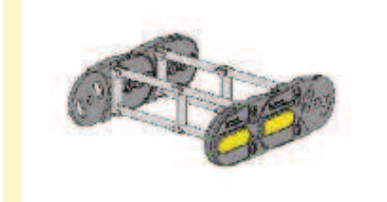

Aluminium rods screwed at the links. Maximum strength in every application. Possibilities in customising it's width. A separation of cables system.

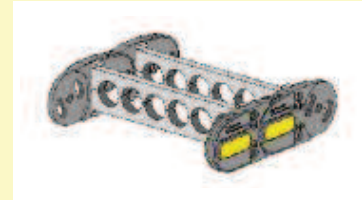

Nylon split cross pieces with holes. Many possibilities of choice between the standard models or special version on request.

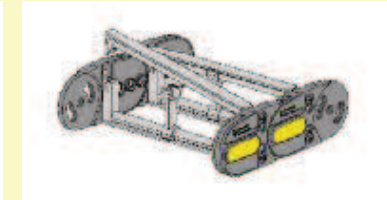

Nylon split cross pieces which open by a zip, to facilitate the operations of positioning the cables internally in the chain.

### Special Versions:



Split cross pieces made on request. The ideal solution in the case of numerous cables with limited amount of space.



Larger split cross pieces. For the transportation of hoses of notable dimensions.

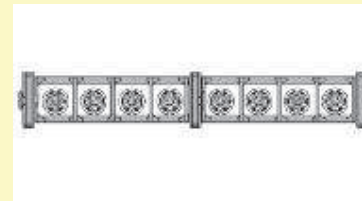

Multiple side-band chains. If it was necessary to increase the self-supporting capacity and the stability when having a large number of cables.

2



# Materials Used

The Brevetti Stendalto cable chains in nylon are developed with a special polyamide reinforced with glass fibre, BRYLON 6. The high resistance to tension, the low coefficient of friction together with the general characteristics of the most evolved compound thermoplastics, allow the cable chains to be used in all environments and temperatures. The main characteristics of BRYLON 6 are:

## Self-Extinguishing

Brylon 6 has the certificate UL94HB. On request the use of the polyamide V0 or V2 can be used. The resistance at eventual sparks is good.

## UV Rays

Brylon 6 is resistant to UV rays and it's therefore suitable for external applications.

## Chemical Resistance

Brylon 6 is generally resistant to oils, grease, petrol, ammonia and water (sea water). Problems could arise with the presence of acids. (See the detailed table showing resistance to various chemical agents).

## The Colouring.

The standard colouring of the Brevetti Stendalto cable chains is to have the links in black and the pins in yellow.

This combination, apart from being eye-catching represents a further security measure, the chain

## Working Temperature

Brevetti Stendalto cable chains made of polymers can be used in application with a temperature range between -25° +125°. In case of application with "continuous" temperature lower than -15° and higher than +95°, the mechanical values could be reduced. In both the cases Brevetti Stendalto is able to offer solutions using special compounds; please consult us. On request it is possible to create and develop cable chains using special polyamides to be used in the following applications:

## Ex-Proof

Cable chains complying with ATEX Directive 94/9/CE. Nylon cable chains, to be used in explosion high-risk environments, can be supplied made of the special material BRYLON AD. For further information please refer to Brevetti Stendalto's Technical Office.



## Clean room-proof

To be used in clean rooms. The standard version of the cable chain 305A009 has been tested and proved to be Class 1. For further information you may require the proper documentation to our technical department.



being a body in movement. The high production flexibility of Brevetti Stendalto, permits the creation of nylon cable chains in various colour combinations which can be adjusted to the colours of the equipment.

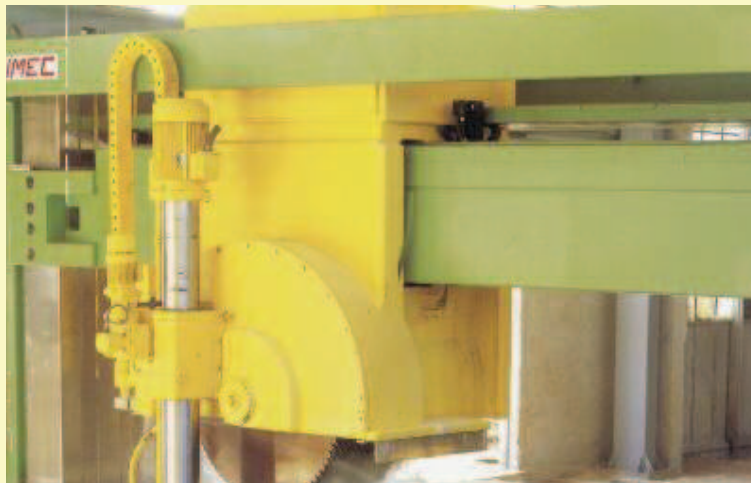

Colour options.

**Links**  
standard colour: black  
colours by request: yellow,  
red, blue, green, grey.

**Pins**  
standard colour: yellow  
colours by request: black,  
red, blue, green.

700 yellow nylon chain with  
the pins in black.

## BRYLON 6 Technical Data

Norms	Properties	Units	Typical values	
			Dry	Conditioned
<b>Thermal properties</b>				
DSC	Melting point (10° C/min.)	°C	222	
ASTM - D 696	Coefficient of linear thermal expansion	X10 <sup>-4</sup> K <sup>-1</sup>	28	
ASTM D 648	Heat distortion temperature			
ISO 75	1.82 N/mm <sup>2</sup>	°C	210	
DIN 53461	0.45 N/mm <sup>2</sup>	°C	220	
U. L. 94	Flammability		H.B.	
IEC 695-2-1	Incandescent wire Temperature Thickness	°C mm	650 3	
<b>Flammability</b>				
ASTM-D 257	Volume resistivity	Ohm cm	10 <sup>13</sup>	10 <sup>11</sup>
ASTM-D 257	Surface resistivity	Ohm	10 <sup>13</sup>	10 <sup>11</sup>
ASTM-D 149	Dielectric strength	KV/mm	22	
ASTM-D 150	Dielectric constant (10 Hz)	—	3.8	4.5
ASTM-D 150	Dissipation factor (10Hz)	—	0.02	0.09
<b>Physical properties</b>				
ASTM-D 792	Density	g/cm <sup>3</sup>	1.38	
ASTM-D 570	Water absorption at 23°C in water for 24 hours	%	0.90	
<b>Mechanical properties</b>				
ASTM-D 638	Tensile yield stress	N/mm <sup>2</sup>	195	115
ISO R/527				
DIN 53455	Ultimate elongation	%	2.6	4
ASTM-D 638				
ISO R/527	Tensile modulus of elasticity	N/mm <sup>2</sup>	10600	6900
DIN 53457				
ASTM-D 790	Flexural strength	N/mm <sup>2</sup>	310	190
ISO 178				
DIN 53452				
ASTM-D 790	Flexural modulus	N/mm <sup>2</sup>	10500	6800
ISO 178				
ASTM-D 256	Unnotched Izod impact strength	J/m	140	300
ISO 180/4C	Notched Izod impact strength	KJ/m <sup>2</sup>	110	125
ASTM-D 785	Rockwell hardness	Scala R	122	114

## Chemical Resistance

Chemical agents	BRYLON 6			STEEL	
	Concentration %	Amorphous	Crystal	Concentration %	
Methyl acetate	100	RB3	RB2	100	RB
Acetone	100	RB4	RB	100	RB
Acetic acid (aqueous solution)	40	AF	AF	40	AF
Acetic acid (aqueous solution)	10	AF	AF	10	AF
Acetic acid		AF	AF		AF
Citric acid	10	AD 15	RD	10	AD
Hydrochloric acid (aqueous solution)	36	S	S	36	S
Hydrochloric acid (aqueous solution)	10	AF	AF	10	S
Hydrochloric acid (aqueous solution)	2	AF	AD	2	S
Chromic acid (aqueous solution)	10	AF	AF	10	AF
Chromic acid (aqueous solution)	1	RD	RD	1	AF
Hydrofluoric acid	40	AF	AF	40	S
Formic acid (aqueous solution)	85	S	S	85	AD
Formic acid (aqueous solution)	40	S	AF	40	AD
Phosphoric acid (aqueous solution)	10	AF	AF	10	S
Oleic acid	100	RB3	RB3	100	RD
Sulphuric acid	98	S	S	98	S
Sulphuric acid (aqueous solution)	40	AF	AF	40	S
Sulphuric acid (aqueous solution)	10	AF	AF	10	S
Sulphuric acid (aqueous solution)	2	AF	AD	2	S
Tartaric acid (aqueous solution)		RD	RB		RD
Water		RB10	RB9		RD
Chlorine water		RD	RD		AD
Ethyl alcohol	96	RD17	RB3	96	RB
Ammonia	10	RB11	RB	10	AF
Petrol	100	RB1	RB	100	RB
Bitumen		RD	RD		RB
Potassium carbonate	100	RB	RB	100	AF
Sodium carbonate	10	RB10	RB3	10	AF
Ammonium chloride (aqueous solution)	10	RB	RB	10	AF
Calcium chloride (aqueous solution)	20	S	S	20	AF
Calcium chloride (aqueous solution)	10	RB	RB	10	AF
Sodium chloride	10	RB	RB	10	AF
Formaldehyde (aqueous solution)	30	RD	RD	30	AD
Fat		RB	RB		RB
Milk		RB	RB		RB
Mercury		RB	RB		RB
Oils		RB	RB		RB
Oil		RB	RB		RB
Paraffin oil		RB	RB		RB
Silicon oil		RB	RB		RB
Diesel oil		RB	RB		RB
Mineral oil		RB	RB		RB
Ozone		AF	AF		AF
Oil		RB	RB		S
Potassium hydroxide (aqueous solution)	10	RB9	RB3	10	S
Sodium hydroxide (aqueous solution)	50	RD	RD	50	S
Sodium hydroxide (aqueous solution)	10	RB5	RB	10	S
Sodium hydroxide (aqueous solution)	5	RB9	RB	5	S
Aluminium sulphate	10	RB	RB	10	AF
Soap (aqueous solution)		AF	AF		RB
Tincture of iodine		AF	AF		AD
Trichloroethylene		RD5	RD4		RB
Vaseline		RB	RB		RB

Dry  
H<sub>2</sub>O < 0,15%

Conditioned  
equilibrium moisture content  
at 23° - 50% R.H.

The table shows the  
resistance to chemical  
agents of BRYLON 6 and  
Steel.

**RB**  
Very good resistance.

**RD**  
Good resistance.

**AD**  
Limited resistance.

**AF**  
Poor resistance.

**S**  
Soluble.

**Amorphous**  
Polymer in amorphous state.

**Crystal**  
Polymer in crystalline state.

The number by resistance  
value side shows which is  
the % weight increase due  
to swelling.

All data contained in this  
publication are laboratory  
and design values, to be  
verified in practical  
applications.

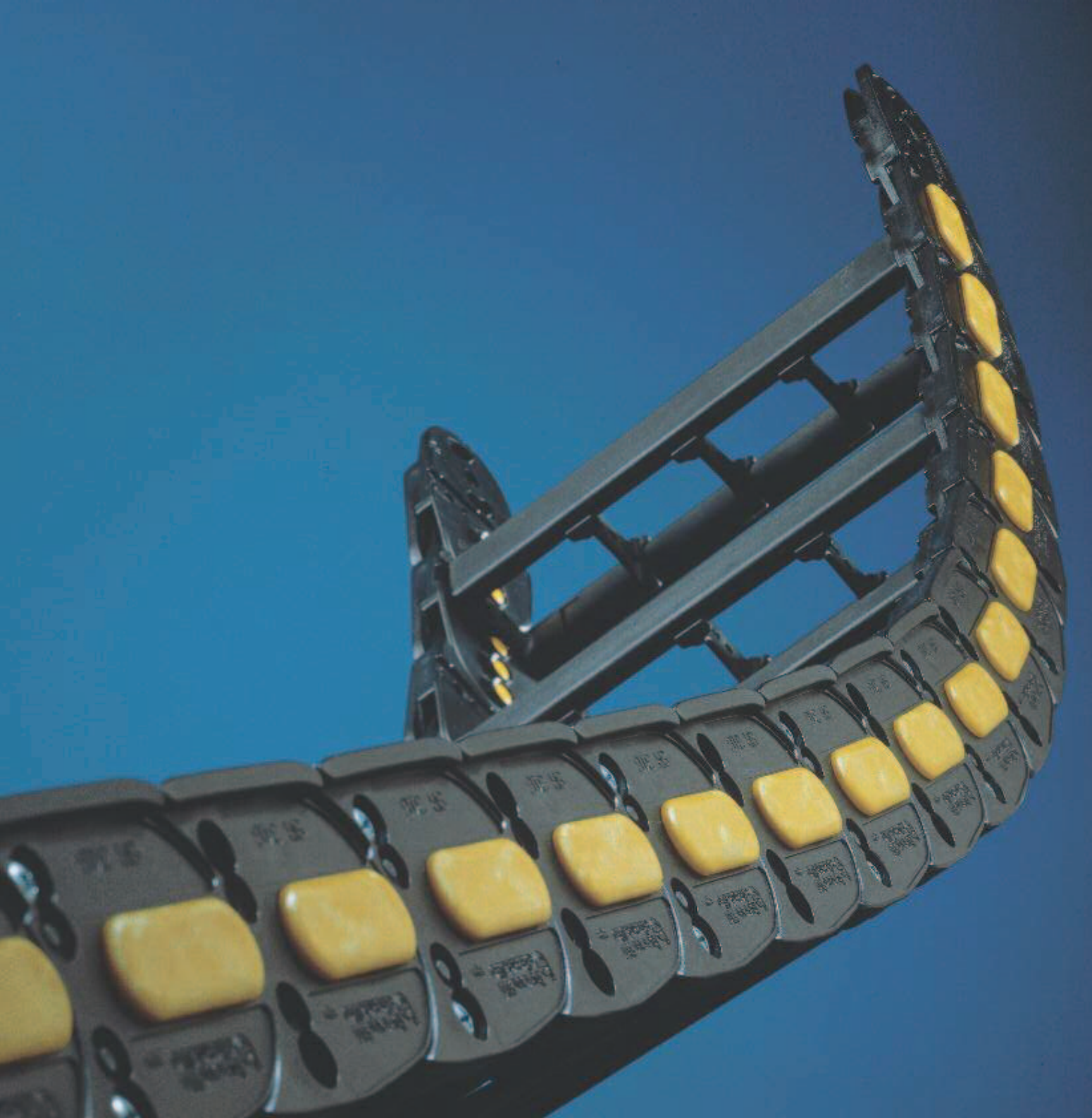

## Nylon Cable Chain

Light Series	page 38
Medium Series	page 56
Heavy Series	page 84
Protection Series	page 116
Sliding Series	page 150
Robot Series	page 184



## Nylon Cable Chains Light Series

200 Series	page 40
250L-250LI-250LE Series	page 42
325LI/LE Series	page 44
325L Series	page 46
335L-335LI-335LE Series	page 48
339 Series	page 50
Channel guide for long travel distance	
For 250L-300 Series	page 52
For 325L-325LI/LE/PI-335L/LI/LE-339 Series	page 54

Cross pieces open and close with a "Snap-Fit" action

Nylon separator. Cables can be laid apart from each other

Inner surface of chain completely smooth

Steel or nylon end brackets with tiewrap clamp

A large surface allows the chain to slide on itself

3



## 200 Nylon Cable Chain

### Inner height (D) 12 mm

Single link construction with central anti-friction pivot.  
Very smooth chain, particularly suitable for small automatic machines like printers, measurements equipment etc.

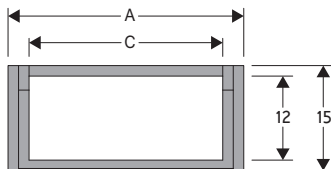

### Technical characteristics when self-supported

Speed	10 m/s
Acceleration	50 m/s <sup>2</sup>

For higher requirements please consult our technical dept.

A	B	C	D	R	Weight/m	Chain
mm	mm	mm	mm	mm	kg	Part Number
18	15	12	12	018-030-040	0,13	20012 □□□ *
31	15	25	12	018-030-040	0,14	20025 □□□ *
41	15	35	12	018-030-040	0,15	20035 □□□ *

\*Complete the code by inserting the value of the radius (R): Ex. 20012 □ □ □ □ □

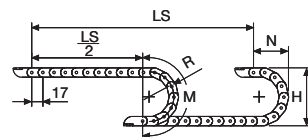

R	H	N	M
mm	mm	mm	mm
018	51	45	95
030	75	55	130
040	95	70	165

Length of chain (L)  
Half travel distance ( $\frac{LS}{2}$ )  
plus length of curve (M)

$$L = \frac{LS}{2} + M$$

### Self-Supporting Capacity Diagram

The maximum length of the self-supporting capacity ( $\frac{LS}{2}$ ) in relationship to the weight of the cables and hoses contained per linear metre.

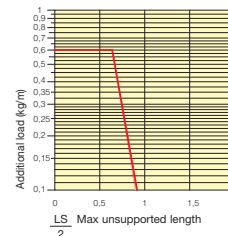

### End Brackets

The end brackets set allows the two ends of the chain to be attached to the equipment.

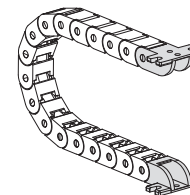
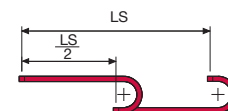
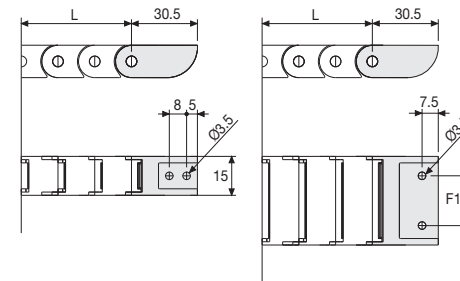

Fig. A Chain fixed outside the radius. (Fig A)



The red marking in the diagram area considers the difference of weight between various widths of chain.



For applications with  $\frac{LS}{2}$  and weights not included in the area of the diagram showing self-supporting capacity, verify the possible use of support rollers (see page 30).

Chain Type	F1 mm	F mm
20025...	13	41
20035...	23	51

### Nylon Type Part Numbers

Complete Set Assembled	
Chain Type	End Brackets Set
20012...	AN20012KM□□**
20025...	AN20025KM□□**
20035...	AN20035KM□□**

Complete Set Unassembled	
Chain Type	End Brackets Set
20012	AN20012K
20025...	AN20025K
20035...	AN20035K

\*\* 1=Pos.1; 2=Pos.2; 3=Pos.3

## 200 Nylon Cable Chain

## 250L/LI/LE Nylon Cable Chain

### Inner height (D) 17 mm

Single link construction.  
Non-opening version (250L).  
Version with opening frames from inner radius (250LI) or from outer radius (250LE).  
Vertical separators available.

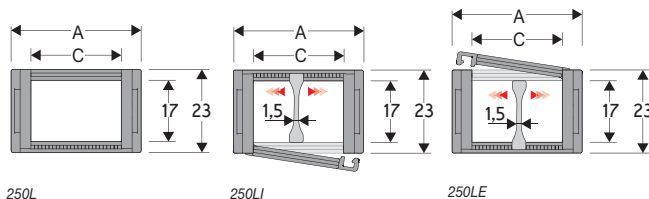

### Separator

- Unassembled Part.no S250L  
- Assembled Part.no S250LMC

### Technical characteristics when self-supported

Speed 10 m/s  
Acceleration 50 m/s<sup>2</sup>

For higher requirements please consult our technical dept.

For sliding applications, technical data can slightly change according to frequency, added weight and environment.

**SLIDING VERSION**  
to be ordered with pivoting end brackets set

A	B	C	D	R	Weight/m	Chain
mm	mm	mm	mm	mm	kg	Part Number
26	23	15	17	028-038-045-060-075-100	0,34	250L(LI)(LE)015 □□□ *
36	23	25	17	028-038-045-060-075-100	0,37	250L(LI)(LE)025 □□□ *
46	23	35	17	028-038-045-060-075-100	0,40	250L(LI)(LE)035 □□□ *
61	23	50	17	028-038-045-060-075-100	0,43	250L(LI)(LE)050 □□□ *

\*Complete the code by inserting the value of the radius (R): Ex. 250LI035 □□ □□

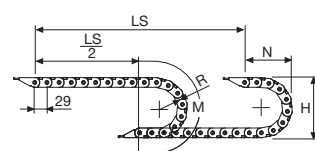

R	H	N	M	N1	M1
mm	mm	mm	mm	mm	mm
028	79	68,5	146	120	255
038	99	78,5	177	125	270
045	113	85,5	199	250	530
060	143	100,5	246	400	850
075	173	115,5	294	505	1085
100	223	140,5	372	650	1405

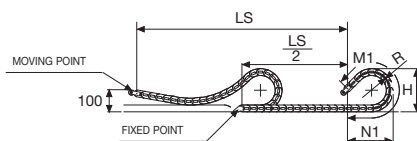

Length of chain (L)  
Half travel distance ( $\frac{LS}{2}$ )  
plus length of curve (M) o (M1)

$$L = \frac{LS}{2} + M \text{ o } M1$$

### 250L

Non-opening  
Sliding



### 250LI

Frames opening from inner radius  
No Sliding



### 250LE

Frames opening from outer radius  
No Sliding



### Self-Supporting Capacity Diagram

The maximum length of the self-supporting capacity ( $\frac{LS}{2}$ ) in relationship to the weight of the cables and hoses contained per linear metre.

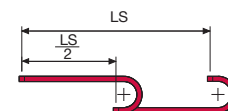
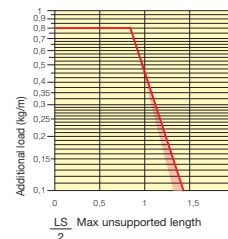

The red marking in the diagram area considers the difference of weight between various widths of chain.

For applications with  $\frac{LS}{2}$  and weights not included in the area of the diagram showing self-supporting capacity, verify the possible use of support rollers (see page 30).

### End Brackets

The end brackets set allows the two ends of the chain to be attached to the equipment. End brackets are equipped with tiewrap clamps.

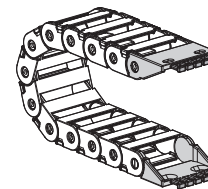
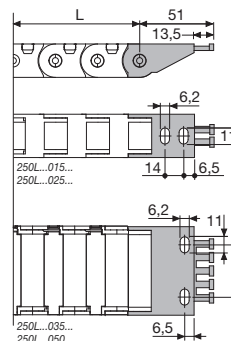

Fig. A  
Chain fixed outside the radius. (Fig A) See end brackets mounting variations page 31.



Chain	F1
Type	mm
250L...035...	21
250L...050...	36

### Nylon Type Part Numbers

Complete Set Assembled	End Brackets
Chain	Set
250L	AN250L□□□*KM□**

Complete Set Unassembled	End Brackets
Chain	Set
250L	AN250L□□□*K□**

\*\* Inner width (C)  
\*\* 1=Pos.1; 2=Pos.2; 3=Pos.3  
5=Pos.5; 6=Pos.6

## 250L

## 250LI

## 250LE

Nylon Cable Chain

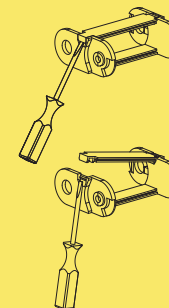

How to open the cover.

For further information please consult Brevetti Stendalto's Technical Office

## 325LI/325LE Nylon Cable Chain with opening frames

### Inner height (D) 25 mm

Single link construction with central large anti-friction pivot, for high torsion and tensile resistance.

Frames opening from inner radius (325LI) or from outer radius (325LE).

Vertical separators available.

Used with guide channels, this chain is particularly suitable for long distance travel.

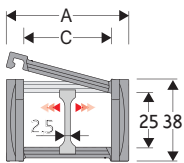

Separator	
- Unassembled	Part.no S325L
- Assembled	Part.no S325LMC

### Technical characteristics when self-supported

Speed	10 m/s
Acceleration	50 m/s <sup>2</sup>

For higher requirements please consult our technical dept.

A	B	C	D	R	Weight/m	Chain
mm	mm	mm	mm	mm	kg	Part Number
57	38	40	25	050-060-075-100-125-150	0,90	325LI(LE)040 □□□ *
77	38	60	25	050-060-075-100-125-150	0,95	325LI(LE)060 □□□ *
93	38	76	25	050-060-075-100-125-150	1,05	325LI(LE)076 □□□ *
120	38	103	25	050-060-075-100-125-150	1,15	325LI(LE)103 □□□ *

\*Complete the code by inserting the value of the radius (R): Ex. 325LI040 □ □ □ □

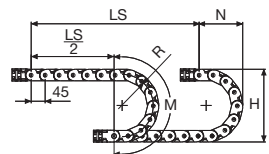

R	H	N	M	N1	M1
mm	mm	mm	mm	mm	mm
050	138	115	250	145	300
060	158	125	280	155	335
075	188	140	325	185	420
100	238	165	405	275	635
125	288	190	485	360	855
150	338	215	565	445	1075

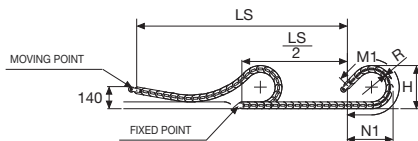

Length of chain (L)  
Half travel distance ( $\frac{LS}{2}$ )  
plus length of curve (M) or (M1)

$$L = \frac{LS}{2} + M \text{ or } M1$$

For sliding applications, technical data can slightly change according to frequency, added weight and environment.

**SLIDING VERSION**  
to be ordered with pivoting end brackets set

### Self-Supporting Capacity Diagram

The maximum length of the self-supporting capacity ( $\frac{LS}{2}$ ) in relationship to the weight of the cables and hoses contained per linear metre.

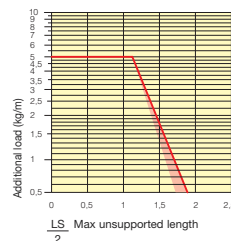

### End Brackets

The end brackets set allows the two ends of the chain to be attached to the equipment. EBs tiwrap clamps and/or centre-distance reducers fully available under request.

#### Nylon Type

#### Bright Zinc Plated Steel Type\*\*\*

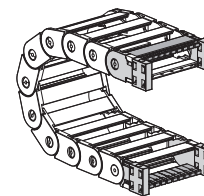

Fig. A  
Chain fixed outside/inside the radius. (Fig A)

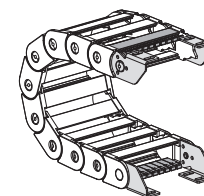
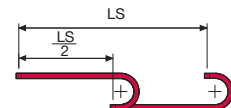
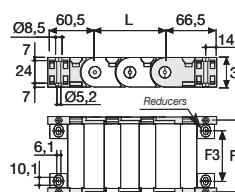

Fig. B  
Chain fixed outside the radius. (Fig B)  
See end brackets mounting variations page 31.



The red marking in the diagram area considers the difference of weight between various widths of chain.

For applications with  $\frac{LS}{2}$  and weights not included in the area of the diagram showing self-supporting capacity, verify the possible use of support rollers (see page 30).



Chain type	F mm	F3 mm
325L...040	51	22
325L...060	71	42
325L...076	87	58
325L...103	114	85

#### Nylon Type Part Numbers

Complete Set Assembled Chain End Brackets Type	Set
325L...	AN325L□□□*KM

Complete Set Unassembled Chain End Brackets Type	Set
325L...	AN325L□□□*K

Tiewrap Clamp Part Number
Assembled
CFC325L□□□*KM
Unassembled
CFC325L□□□*K

Centre-distance Reducers Set Part Number
Unassembled
AQF325K

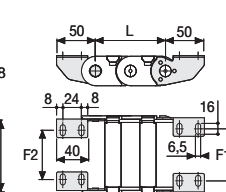

Chain Type	F2 mm	F1 mm
325L...040	22	25,5
325L...060	42	45,5
325L...076	58	61,5
325L...103	85	88,5

#### Bright Zinc Plated Steel Type Part Numbers

Complete Set Unassembled Chain End Brackets Type	Set
325L...	A325LK

Tiewrap Clamp Part Number
Assembled
CFC325L□□□*KM
Unassembled
CFC325L□□□*K

\* Inner width (C)  
\*\*\* Available on request in stainless steel

## 325LI 325LE Nylon Cable Chain with opening frames

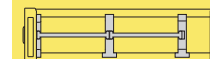

Separation System  
To choose the separators, see page 196

### Nylon end brackets centre-distance reducers

Reducers mounted on the inner radius

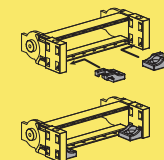

Reducers mounted on the outer radius

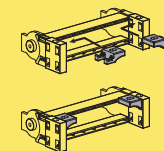

Suitable to long travel distance.  
To choose the guide channel see page 54

For further information please consult Brevetti Stendalto's Technical Office



## 325L Nylon Cable Chain

### Inner height (D) 25 mm

Single link construction with central large anti-friction pivot, for high torsion and tensile resistance.

Vertical separators available.

Used with guide channels, this chain is particularly suitable for long distance travel.

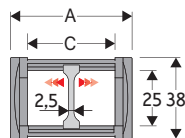

### Separator

- Unassembled	Part.no S325L
- Assembled	Part.no S325LMC

### Technical characteristics when self-supported

Speed	10 m/s
Acceleration	50 m/s <sup>2</sup>

For higher requirements please consult our technical dept.

A	B	C	D	R	Weight/m	Chain
mm	mm	mm	mm	mm	kg	Part Number
57	38	40	25	050-060-075-100-125-150	0,90	325L040 □□□ *
77	38	60	25	050-060-075-100-125-150	0,95	325L060 □□□ *
93	38	76	25	050-060-075-100-125-150	1,05	325L076 □□□ *
120	38	103	25	050-060-075-100-125-150	1,15	325L103 □□□ *

\*Complete the code by inserting the value of the radius (R): Ex. 325L040 □□□ □□

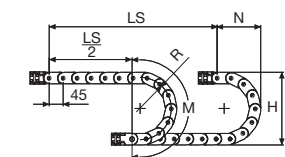

R	H	N	M	N1	M1
mm	mm	mm	mm	mm	mm
050	138	115	250	145	300
060	158	125	280	155	335
075	188	140	325	185	420
100	238	165	405	275	635
125	288	190	485	360	855
150	338	215	565	445	1075

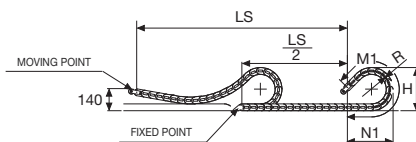

For sliding applications, technical data can slightly change according to frequency, added weight and environment.

SLIDING VERSION to be ordered with pivoting end brackets set

Length of chain (L)  
Half travel distance ( $\frac{LS}{2}$ )  
plus length of curve (M) or (M1)

$$L = \frac{LS}{2} + M \text{ or } M1$$

### Self-Supporting Capacity Diagram

The maximum length of the self-supporting capacity ( $\frac{LS}{2}$ ) in relationship to the weight of the cables and hoses contained per linear metre.

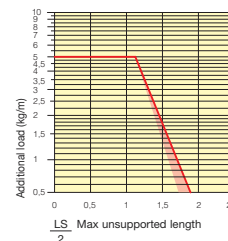

### End Brackets

The end brackets set allows the two ends of the chain to be attached to the equipment. EBs tiwrap clamps and/or centre-distance reducers fully available under request.

### Nylon Type

### Bright Zinc Plated Steel Type\*\*\*

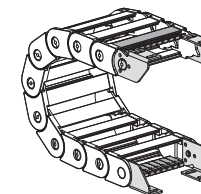
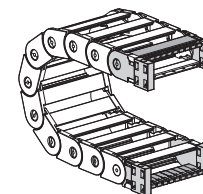
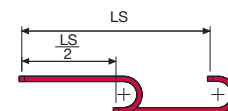

Fig. A Chain fixed outside/inside the radius. (Fig A)

Fig. B Chain fixed outside or inside the radius. (Fig B)



The red marking in the diagram area considers the difference of weight between various widths of chain.

For applications with  $\frac{LS}{2}$  and weights not included in the area of the diagram showing self-supporting capacity, verify the possible use of support rollers (see page 30).

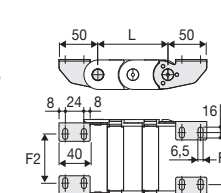
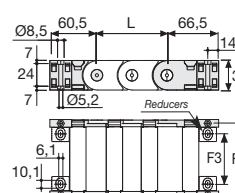

Chain type	F mm	F3 mm
325L040	51	22
325L060	71	42
325L076	87	58
325L103	114	85

Chain Type	F2 mm	F1 mm
325L040	22	25,5
325L060	42	45,5
325L076	58	61,5
325L103	85	88,5

### Nylon Type Part Numbers

Complete Set Assembled Chain End Brackets Type	Set
325L...	AN325L□□□*KM

Complete Set Unassembled Chain End Brackets Type	Set
325L...	AN325L□□□*K

Tiewrap Clamp Part Number
Assembled
CFC325L□□□*KM
Unassembled
CFC325L□□□*K

Centre-distance Reducers Set Part Number
Unassembled
AQF325K

### Bright Zinc Plated Steel Type Part Numbers

Complete Set Unassembled Chain End Brackets Type	Set
325L...	A325LK

Tiewrap Clamp Part Number
Assembled
CFC325L□□□*KM
Unassembled
CFC325L□□□*K

Centre-distance Reducers Set Part Number
Unassembled
AQF325K

\* Inner width (C)  
\*\*\* Available on request in stainless steel

## 325L Nylon Cable Chain

### Nylon end brackets centre-distance reducers

Reducers mounted on the inner radius

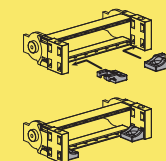

Reducers mounted on the outer radius

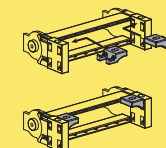

Suitable to long travel distance. To choose the guide channel see page 54

For further information please consult Brevetti Stendalto's Technical Office

## 335L/LI/LE Nylon Cable Chain

### Inner height (D) 35 mm

Single link construction with central large anti-friction pivot, for high torsion and tensile resistance.

Non-opening version (335L).

Version with opening frames from inner radius (335LI) or from outer radius (335LE).

Vertical separators available.

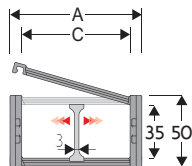

### Separator

- Unassembled	Part.no S4353
- Assembled	Part.no S4353MC

### Technical characteristics when self-supported

Speed	10 m/s
Acceleration	50 m/s <sup>2</sup>

For higher requirements please consult our technical dept.

A	B	C	D	R	Weight/m	Chain
mm	mm	mm	mm	mm	kg	Part Number
56,5	50	40	35	065-075-100-125-150-200	1,08	335L(LI)(LE)040 □□□ *
66,5	50	50	35	065-075-100-125-150-200	1,12	335L(LI)(LE)050 □□□ *
76,5	50	60	35	065-075-100-125-150-200	1,16	335L(LI)(LE)060 □□□ *
92,5	50	76	35	065-075-100-125-150-200	1,22	335L(LI)(LE)076 □□□ *
119,5	50	103	35	065-075-100-125-150-200	1,32	335L(LI)(LE)103 □□□ *
141,5	50	125	35	065-075-100-125-150-200	1,40	335L(LI)(LE)125 □□□ *
166,5	50	150	35	065-075-100-125-150-200	1,50	335L(LI)(LE)150 □□□ *

\*Complete the code by inserting the value of the radius (R): Ex. 335L(LI)(LE)040 □□□□□

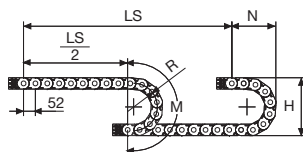

R	H	N	M	N1	M1
mm	mm	mm	mm	mm	mm
065	180	169	310	220	465
075	200	179	340	260	560
100	250	204	420	350	790
125	300	229	500	445	1025
150	350	254	580	540	1260
200	450	304	735	730	1725

Length of chain (L)  
Half travel distance ( $\frac{LS}{2}$ )  
plus length of curve (M) or (M1)

$$L = \frac{LS}{2} + M \text{ or } M1$$

For sliding applications, technical data can slightly change according to frequency, added weight and environment.

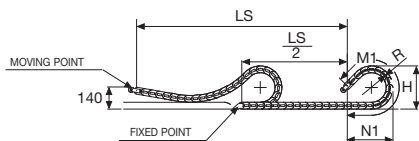

**SLIDING VERSION**  
to be ordered with pivoting end brackets set

### 335L Non-opening



### 335LI Frames opening from inner radius



### 335LE Frames opening from outer radius



### Self-Supporting Capacity Diagram

The maximum length of the self-supporting capacity ( $\frac{LS}{2}$ ) in relationship to the weight of the cables and hoses contained per linear metre.

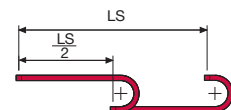
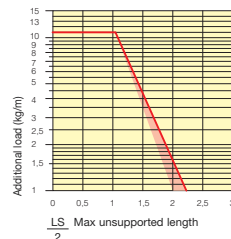

The red marking in the diagram area considers the difference of weight between various widths of chain.

For applications with  $\frac{LS}{2}$  and weights not included in the area of the diagram showing self-supporting capacity, verify the possible use of support rollers (see page 30).

### End Brackets

The end brackets set allows the two ends of the chain to be attached to the equipment.

Set complete with tiewrap clamps available on request.

### Nylon Type

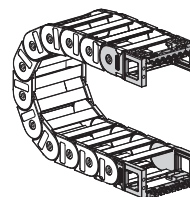
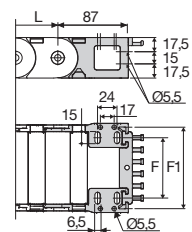

Fig. A  
The chain can be fixed frontally, inner or outer radius. (Fig A)



Chain type	F mm	F1 mm
335L...040	25	51
335L...050	35	61
335L...060	45	71
335L...076	61	87
335L...103	88	114
335L...125	110	136
335L...150	135	161

### Nylon Type Part Numbers

Complete Set Assembled Chain Type	End Brackets Set
335 AN335L□□□*KM□□*	

Complete Set Unassembled Chain Type	End Brackets Set
335 AN335L□□□*K	

Tiewrap Clamp	Part Number
335	PFN335□□□*

\* Inner width (C)  
\*\* 1=Pos.1; 2=Pos.2; 3=Pos.3

## 335L 335LI 335LE Nylon Cable Chain

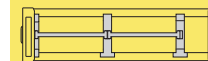

Separation System  
To choose the separators, see page 196

How to open the cover.

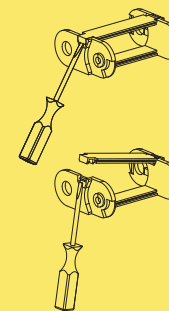

Suitable to long travel distance.  
To choose the guide channel see page 54

For further information please consult Brevetti Standalto's Technical Office

## 339 Nylon Cable Chain

### Inner height (D) 39 mm

Single link construction with central large anti-friction pivot, for high torsion and tensile resistance. Non-opening version. Short pitch and very small bending radius design makes these chains suitable for applications with the smallest available spaces. These series can be easily used for long distance travels with the corresponding guide channels.

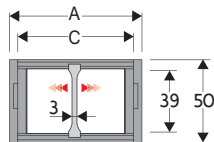

Separator	
- Unassembled	Part.no S339
- Assembled	Part.no S339MC

### Technical characteristics when self-supported

Speed	10 m/s
Acceleration	50 m/s <sup>2</sup>

For higher requirements please consult our technical dept.

A	B	C	D	R	Weight/m	Chain
mm	mm	mm	mm	mm	kg	Part Number
60	50	40	39	050-075-100	1,48	339040 □□□ *
80	50	60	39	050-075-100	1,48	339060 □□□ *
96	50	76	39	050-075-100	1,65	339076 □□□ *

\*Complete the code by inserting the value of the radius (R): Ex. 339076 □□□ □□

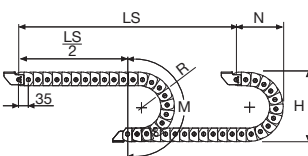

R	H	N	M	N1	M1
mm	mm	mm	mm	mm	mm
050	156	115	230	140	275
075	206	135	305	215	470
100	256	160	385	310	705

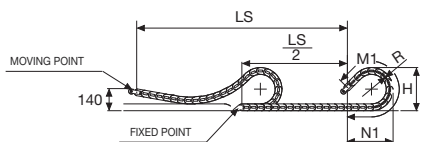

Length of chain (L)  
 Half travel distance ( $\frac{LS}{2}$ )  
 plus length of curve (M) or (M1)  
 $L = \frac{LS}{2} + M \text{ or } M1$

For sliding applications, technical data can slightly change according to frequency, added weight and environment.

SLIDING VERSION to be ordered with pivoting end brackets set

### Self-Supporting Capacity Diagram

The maximum length of the self-supporting capacity ( $\frac{LS}{2}$ ) in relationship to the weight of the cables and hoses contained per linear metre.

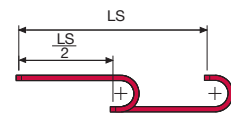
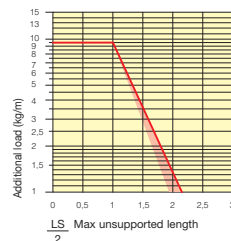

The red marking in the diagram area considers the difference of weight between various widths of chain.

For applications with  $\frac{LS}{2}$  and weights not included in the area of the diagram showing self-supporting capacity, verify the possible use of support rollers (see page 30).

### Bright Zinc Plated Steel End Brackets\*\*\*

The end brackets set allows the two ends of the chain to be attached to the equipment.

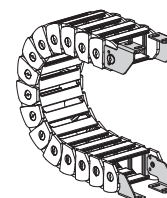
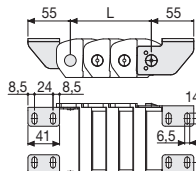

Fig. A Chain fixed outside the radius. (Fig A) See end brackets mounting variations page 31



Chain Type	F mm
339040	21
339060	41
339076	57

### Bright Zinc Plated Steel Type Part Numbers

Complete Set	Unassembled Chain	End Brackets
Type	Set	
339...	A339K	

\*\*\* Available on request in stainless steel

## 339 Nylon Cable Chain

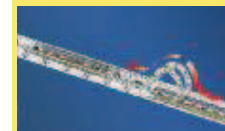

Suitable to long travel distance. To choose the guide channel see page 54

For further information please consult Brevetti Standalto's Technical Office





# Guide Channel

## 250L-300

Special channel guide allows the use of the chain for long travel distance. Available in galvanised steel and, on request, in stainless steel.

### Single Chain Application

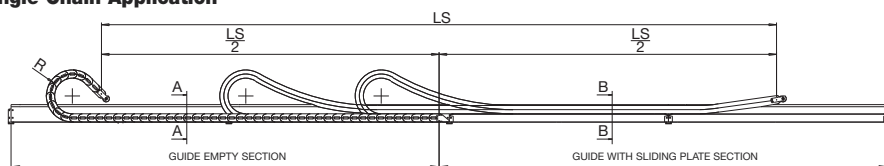

### Double Chain Application

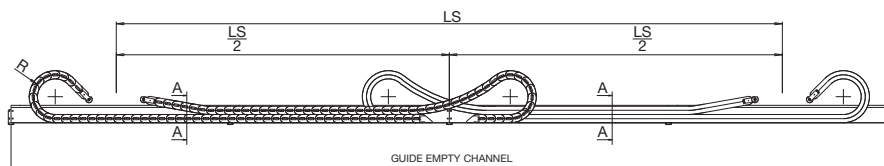

Channel guide is available in kit form composed of:  
 side walls 2 m standard length  
 joining plates  
 fixing screws

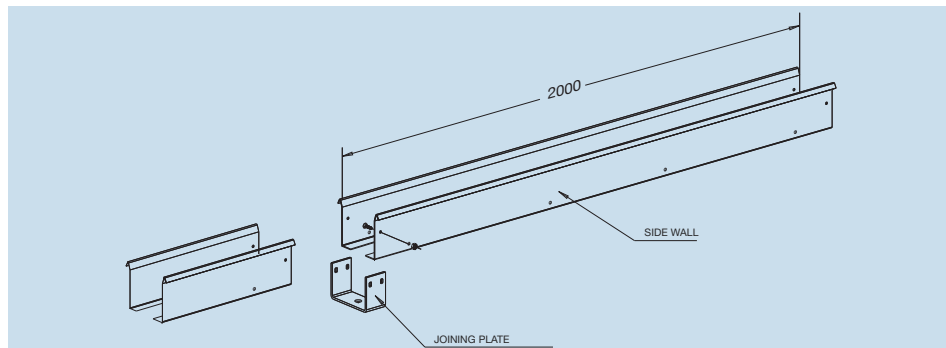

### Guide Empty Section

Section A-A

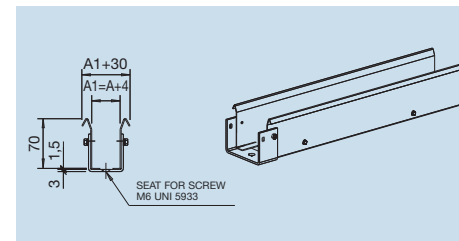

<b>Part Number</b>	<b>CS250...</b>
How to order	
Chain part number	250L035060
Guide channel part number	CS250L035

### Guide Sliding Plate Section

Section B-B

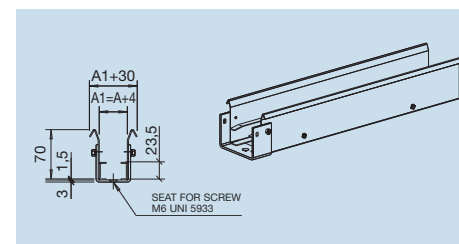

<b>Part Number</b>	<b>CA250...</b>
How to order	
Chain part number	250L035060
Guide channel part number	CA250L035

## Guide Channel

### 325L-325LI/LE/PI-335L/LI/LE-339

Special channel guide allows the use of the chain for long travel distance. Available in galvanised steel and, on request, in stainless steel.

#### Single Chain Application

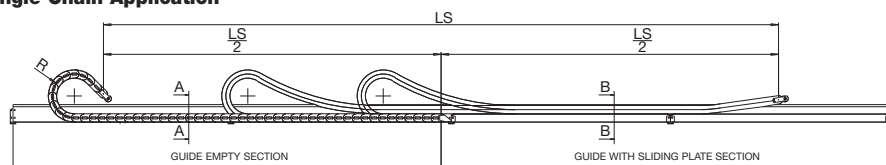

#### Double Chain Application

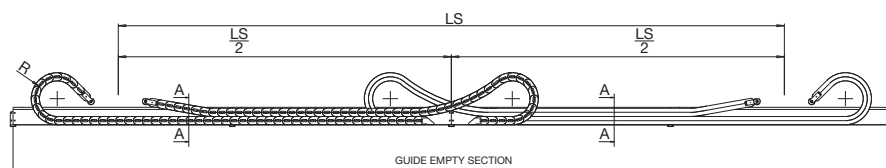

Channel guide is available in kit form composed of:  
side walls 2 m standard length  
joining plates  
fixing screws

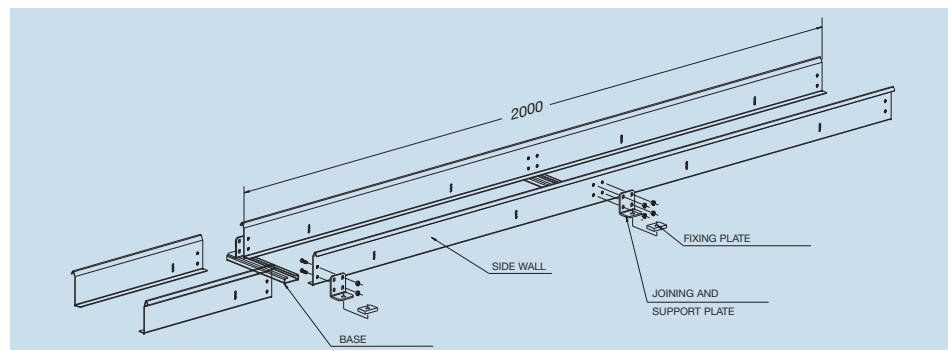

#### Guide Empty Section

Section A-A

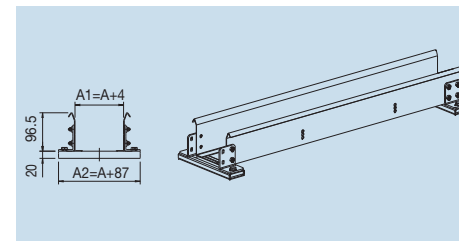

#### Part Number

CS325L-LI-LE

How to order

Chain part number 325L040050

Chain part number 325LI040050

Chain part number 325LE040050

Guide channel

part number CS325L040

#### Guide Sliding Plate Section 325...

Section B-B

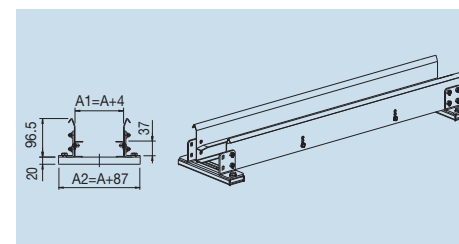

#### Part Number

CA325L-LI-LE

How to order

Chain part number 325L040050

Chain part number 325LI040050

Chain part number 325LE040050

Guide channel

part number CA325040

#### Guide Sliding Plate Section 335 - 339

Section B-B

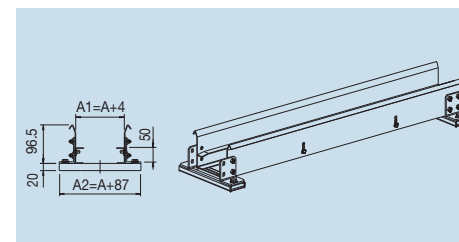

#### Part Number

CA339...

How to order

Chain part number 339040050

Guide channel

part number CA339040



## Nylon Cable Chains Medium Series

300A Series	page 58
300 Series	page 60
305A Series	page 62
305 Series	page 64
355A Series	page 66
355 Series	page 68
400 Series	page 70
435MU Series	page 72
445MU Series	page 74
660A Series	page 76
770A Series	page 78
475MU Series	page 80

Channel guide for long travel distance	
For chains 305-355-435MU	page 82
For chains 445MU-660A-770A	page 178
Horizontal Separation	page 196

Cross pieces open and close with a "Snap-Fit" action

Nylon separator. Cables can be laid apart from each other

Tiewrap clamp for an optimal conduct fixing

Steel or nylon end brackets

Inner surface of chain completely smooth

Single connecting Pivot Pin which offers high integrity in high performance applications

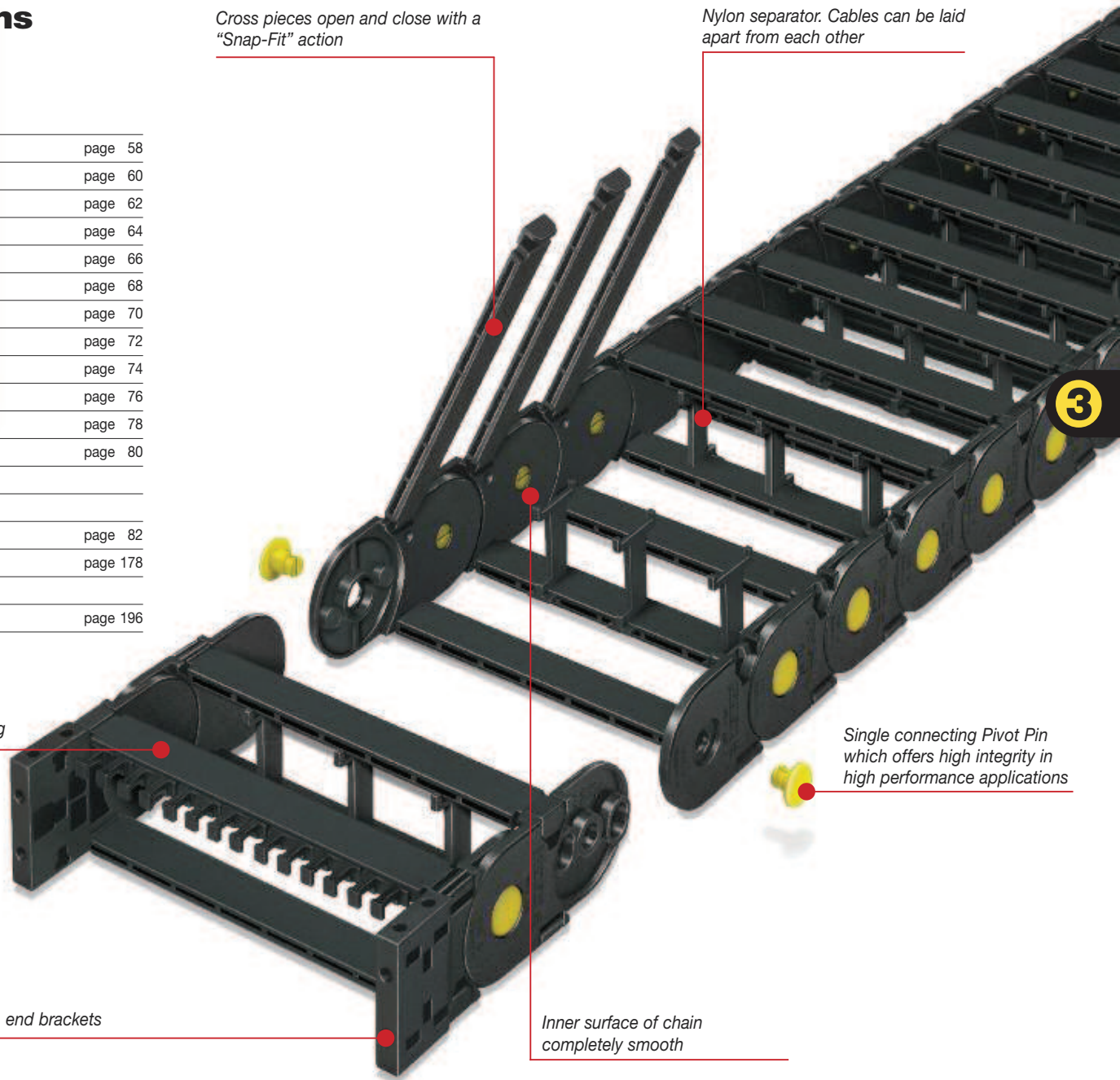



## 300A Nylon Cable Chain with opening frames

### Inner height (D) 18 mm

Single link construction with anti-friction single-pin. Frames opening from inner radius. Vertical separators available. The wide frames on out radius offer good protection, when operating horizontally.

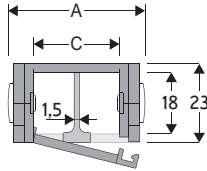

Separator	
- Unassembled	Part.no S300A
- Assembled	Part.no S300AMC
Pin	
	Part.no PG300A

### Technical characteristics when self-supported

Speed	10 m/s
Acceleration	50 m/s <sup>2</sup>

For higher requirements please consult our technical dept.

A	B	C	D	R	Weight/m	Chain
mm	mm	mm	mm	mm	kg	Part Number
27	23	15	18	040-060-080-120	0,41	300A015 □□□ *
37	23	25	18	040-060-080-120	0,45	300A025 □□□ *
62	23	50	18	040-060-080-120	0,55	300A050 □□□ *
87	23	75	18	040-060-080-120	0,65	300A075 □□□ *

\*Complete the code by inserting the value of the radius (R): Ex. 300A015 □ □ □ □

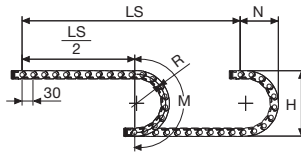

Length of chain (L)  
Half travel distance ( $\frac{LS}{2}$ )  
plus length of curve (M)

$$L = \frac{LS}{2} + M$$

R	H	N	M
mm	mm	mm	mm
040	103	85	185
060	143	105	250
080	183	125	315
120	263	165	440

### Self-Supporting Capacity Diagram

The maximum length of the self-supporting capacity ( $\frac{LS}{2}$ ) in relationship to the weight of the cables and hoses contained per linear metre.

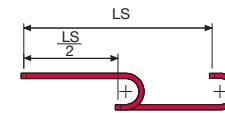
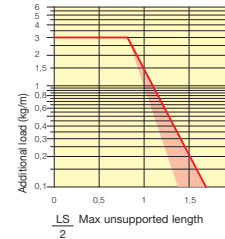

The red marking in the diagram area considers the difference of weight between various widths of chain.

For applications with  $\frac{LS}{2}$  and weights not included in the area of the diagram showing self-supporting capacity, verify the possible use of support rollers (see page 30).

### End Brackets

The end brackets set allows the two ends of the chain to be attached to the equipment. Set complete with tiewrap clamps available on request.

#### Nylon Type

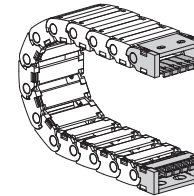

Fig. A Chain fixed outside the radius. (Fig A)

#### Bright Zinc Plated Steel Type\*\*\*

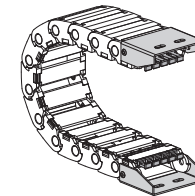
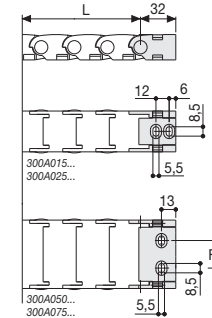
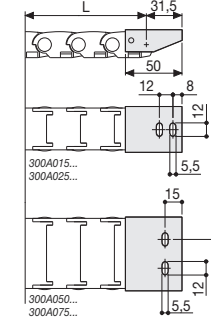

Fig. B Chain fixed outside the radius. (Fig B) See end brackets mounting variations page 31.



Chain Type	F mm
300A050	25
300A075	50



Chain Type	F mm
300A050	25
300A075	50

### Nylon Type Part Numbers

Complete Set Assembled Chain Type	End Brackets Set
300A...	AN300A □□□ *KM

Complete Set Unassembled Chain Type	End Brackets Set
300A...	AN300A □□□ *K

Tiewrap Clamp	Part Number
Assembl.	CFC300 □□□ *KM
Unassembl.	CFC300 □□□ *K

### Bright Zinc Plated Steel Type Part Numbers

Complete Set Assembled Chain Type	End Brackets Set
300A...	A300A □□□ *KM

Complete Set Unassembled Chain Type	End Brackets Set
300A...	A300A □□□ *K

Tiewrap Clamp	Part Number
Assembl.	CFC300 □□□ *KM
Unassembl.	CFC300 □□□ *K

\* Inner width (C)  
\*\*\* Available on request in stainless steel

3

3

## 300A Nylon Cable Chain with opening frames

How to open the cover.

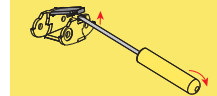
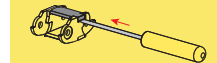

Special tool to remove the connecting pivots: Part Number PZ10.



For further information please consult Brevetti Stendalto's Technical Office



## 300 Nylon Cable Chain

### Inner height (D) 17 mm

Single link construction with anti-friction single-pin. Non-opening. The chain is an extremely strong 18 mm chain, particularly suitable for high frequency/acceleration operations, like on laser cutting heads, in which the chain is highly stressed, due to high acceleration in all 3 directions.

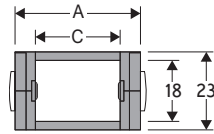

Pin
Part.no PG300

### Technical characteristics when self-supported

Speed	10 m/s
Acceleration	50 m/s <sup>2</sup>

For higher requirements please consult our technical dept.

A	B	C	D	R	Weight/m	Chain
mm	mm	mm	mm	mm	kg	Part Number
30	23	14	18	040-060-080-120	0,38	300015 □□□ *
41	23	25	18	040-060-080-120	0,43	300025 □□□ *
52	23	36	18	040-060-080-120	0,48	300035 □□□ *

\*Complete the code by inserting the value of the radius (R): Ex. 300015 □□□ □□

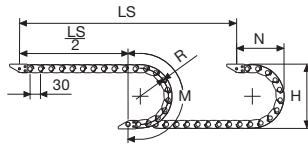

R	H	N	M	N1	M1
mm	mm	mm	mm	mm	mm
40	103	85	185	185	385
60	143	105	248	410	865
80	183	125	315	545	1165
120	263	165	440	750	1640

For sliding applications, technical data can slightly change according to frequency, added weight and environment.

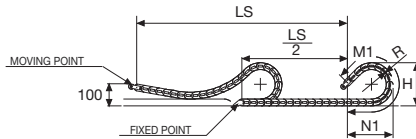

Length of chain (L)  
Half travel distance ( $\frac{LS}{2}$ )  
plus length of curve (M) or (M1)

$$L = \frac{LS}{2} + M \text{ or } M1$$

### Self-Supporting Capacity Diagram

The maximum length of the self-supporting capacity ( $\frac{LS}{2}$ ) in relationship to the weight of the cables and hoses contained per linear metre.

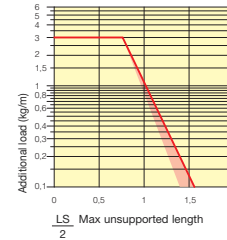

### Bright Zinc Plated Steel End Brackets\*\*\*

The end brackets set allows the two ends of the chain to be attached to the equipment.

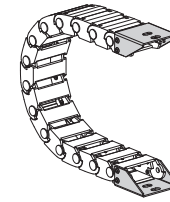
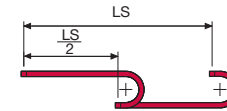
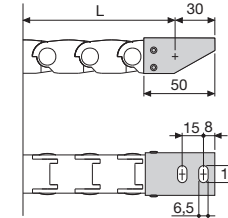

Fig. A  
Chain fixed outside the radius. (Fig A)  
See end brackets mounting variations page 31.



The red marking in the diagram area considers the difference of weight between various widths of chain.



For applications with  $\frac{LS}{2}$  and weights not included in the area of the diagram showing self-supporting capacity, verify the possible use of support rollers (see page 30).

### Bright Zinc Plated Steel Type Part Numbers

Complete Set Assembled	Chain	End Brackets
Type	Set	Set
300015...	AP300KM □□	**
300025...	AG300KM □□	**
300035...	A300035KM □□	**

Complete Set Unassembled	Chain	End Brackets
Type	Set	Set
300015...	AP300K □□	**
300025...	AG300K □□	**
300035...	A300035K □□	**

\*\* 1=Pos.1; 2=Pos.2; 3=Pos.3

\*\*\* Available on request in stainless steel

## 300 Nylon Cable Chain



Suitable to long travel distance. To choose the guide channel see page 54

Special tool to remove the connecting pivots: Part Number PZ10.



For further information please consult Brevetti Stendalto's Technical Office

## 305A Nylon Cable Chain with removable frames

### Inner height (D) 24 mm

Double share single link joining construction with large anti-friction single-pin. Frames removable from inner radius. Vertical separators are available. Wide frames on outer radius offer good protection. Due to its design with double-share lateral side, the chain is very robust, meanwhile offering very low friction.

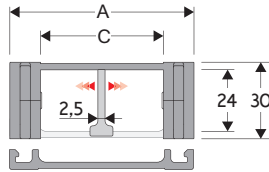

Separator	
- Unassembled	Part.no S305
- Assembled	Part.no S305MC
Pin	
	Part.no PG305

### Technical characteristics when self-supported

Speed	10 m/s
Acceleration	50 m/s <sup>2</sup>

For higher requirements please consult our technical dept.

A	B	C	D	R	Weight/m	Chain
mm	mm	mm	mm	mm	kg	Part Number
54	30	30	24	50	0,85	305A008
54	30	30	24	70	0,85	305A010
54	30	30	24	120	0,85	305A020
54	30	30	24	150	0,85	305A050
74	30	50	24	50	0,95	305A009
74	30	50	24	70	0,95	305A030
74	30	50	24	120	0,95	305A040
74	30	50	24	150	0,95	305A060

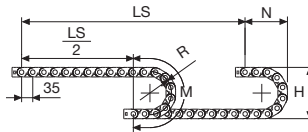

Length of chain (L)  
Half travel distance ( $\frac{LS}{2}$ )  
plus length of curve (M)

$$L = \frac{LS}{2} + M$$

R	H	N	M
mm	mm	mm	mm
50	130	105	230
70	170	120	290
120	270	175	450
150	330	205	545



### Self-Supporting Capacity Diagram

The maximum length of the self-supporting capacity ( $\frac{LS}{2}$ ) in relationship to the weight of the cables and hoses contained per linear metre.

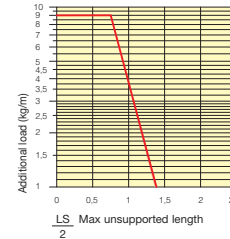

### End Brackets

The end brackets set allows the two ends of the chain to be attached to the equipment.

#### Nylon Type

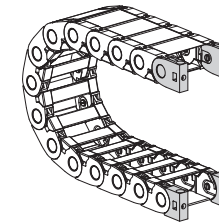

Fig. A The chain can be fixed frontally, inner or outer radius. (Fig A)

#### Bright Zinc Plated Steel Type\*\*\*

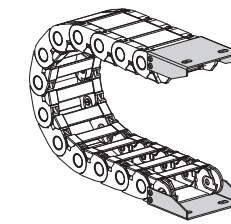
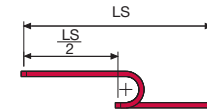
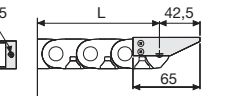
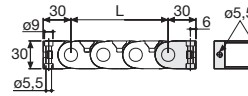

Fig. B Chain fixed outside the radius. (Fig B) See end brackets mounting variations page 31.



The red marking in the diagram area considers the difference of weight between various widths of chain.



Chain Type	F mm
305A C=30	42,5
305A C=50	62,5

Chain Type	F mm
305A C=30	30,5
305A C=50	50,5

### Nylon Type Part Numbers

Complete Set Assembled	
Chain Type	End Brackets Set
305A C=30	AN305KM
305A C=50	AN305KM

Complete Set Unassembled	
Chain Type	End Brackets Set
305A C=30	AN305K
305A C=50	AN305K

### Bright Zinc Plated Steel Type Part Numbers

Complete Set Assembled	
Chain Type	End Brackets Set
305A C=30	AP305AKM1
305A C=50	AG305AKM1

Complete Set Unassembled	
Chain Type	End Brackets Set
305A C=30	AP305AK1
305A C=50	AG305AK1

\*\*\* Available on request in stainless steel

## 305A Nylon Cable Chain with removable frames



How to open the cover.

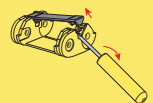
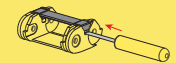

Special tool to remove the connecting pivots: Part Number PZ1010.



For further information please consult Brevetti Stendalto's Technical Office



## 305 Nylon Cable Chain

### Inner height (D) 23 mm

Double share single link joining construction with large anti-friction single-pin. Non-opening. Vertical separators are available. Due to its design with double-share lateral side, the chain is very robust, meanwhile offering very low friction. Used with guide channels, this chain is particularly suitable for long distance travel.

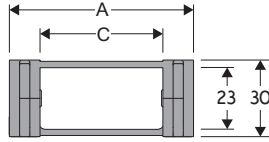

Separator*	
- Unassembled	Part.no S305
- Assembled	Part.no S305MC
<b>Pin</b>	
	Part.no PG305

\*Separator not to be used in long-stroke applications

### Technical characteristics when self-supported

Speed	10 m/s
Acceleration	50 m/s <sup>2</sup>

For higher requirements please consult our technical dept.

A	B	C	D	R	Weight/m	Chain
mm	mm	mm	mm	mm	kg	Part Number
54	30	30	23	50	0,90	305008
54	30	30	23	70	0,90	305010
54	30	30	23	120	0,90	305020
54	30	30	23	150	0,90	305050
74	30	50	23	50	1,00	305009
74	30	50	23	70	1,00	305030
74	30	50	23	120	1,00	305040
74	30	50	23	150	1,00	305060

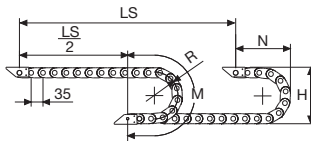

For sliding applications, technical data can slightly change according to frequency, added weight and environment.

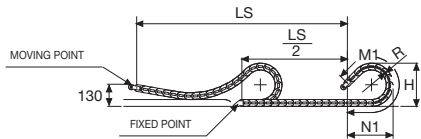

R	H	N	M	N1	M1
mm	mm	mm	mm	mm	mm
50	130	105	230	125	270
70	170	120	290	160	365
120	270	175	450	330	800
150	330	205	545	435	1065

Length of chain (L)  
Half travel distance ( $\frac{LS}{2}$ )  
plus length of curve (M) or (M1)

$$L = \frac{LS}{2} + M \text{ or } M1$$

**SLIDING VERSION**  
to be ordered with pivoting end brackets set

### Self-Supporting Capacity Diagram

The maximum length of the self-supporting capacity ( $\frac{LS}{2}$ ) in relationship to the weight of the cables and hoses contained per linear metre.

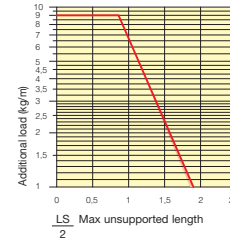

### End Brackets

The end brackets set allows the two ends of the chain to be attached to the equipment.

#### Nylon Type

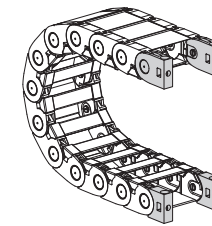

Fig. A  
The chain can be fixed frontally, inner or outer radius. (Fig A)

#### Bright Zinc Plated Steel Type\*\*\*

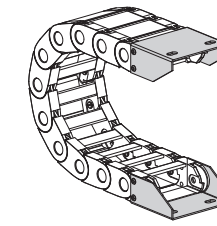
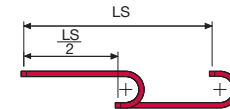
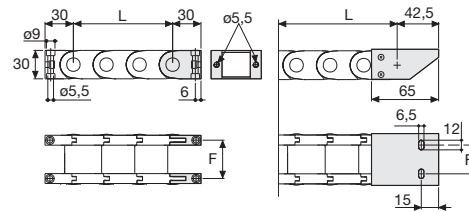

Fig. B  
Chain fixed outside the radius. (Fig B)  
See end brackets mounting variations page 31.



The red marking in the diagram area considers the difference of weight between various widths of chain.



For applications with  $\frac{LS}{2}$  and weights not included in the area of the diagram showing self-supporting capacity, verify the possible use of support rollers (see page 30).

Chain Type	F mm
305 C=30	40,5
305 C=50	60,5

Chain Type	F mm
305 C=30	30,5
305 C=50	51,5

### Nylon Type Part Numbers

Complete Set Assembled	End Brackets Set
Chain Type	Set
305 C=30	AN305KM
305 C=50	AN305KM

Complete Set Unassembled	End Brackets Set
Chain Type	Set
305 C=30	AN305K
305 C=50	AN305K

### Bright Zinc Plated Steel Type Part Numbers

Complete Set Assembled	End Brackets Set
Chain Type	Set
305 C=30	AP305KM□**
305 C=50	AG305KM□**

Complete Set Unassembled	End Brackets Set
Chain Type	Set
305 C=30	AP305K□**
305 C=50	AG305K□**

\*\* 1=Pos.1; 2=Pos.2; 3=Pos.3  
\*\*\* Available on request in stainless steel

## 305 Nylon Cable Chain



Suitable to long travel distance. To choose the guide channel see page 82

Special tool to remove the connecting pivots: Part Number PZ1010.



For further information please consult Brevetti Stendalto's Technical Office

## 355A Nylon Cable Chain with removable frames

### Inner height (D) 31 mm

Double share single link joining construction with large anti-friction single-pin. Frames removable from inner radius. Vertical separators are available. Wide frames on outer radius offer good protection. Due to its design with double-share lateral side, the chain is very robust, meanwhile offering very low friction.

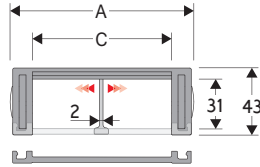

Separator	
- Unassembled	Part.no S355
- Assembled	Part.no S355MC
Pin	
	Part.no PG355

### Technical characteristics when self-supported

Speed	10 m/s
Acceleration	50 m/s <sup>2</sup>

For higher requirements please consult our technical dept.

A	B	C	D	R	Weight/m	Chain
mm	mm	mm	mm	mm	kg	Part Number
74	43	45	31	75	1,40	355A045
74	43	45	31	100	1,40	355A046
74	43	45	31	150	1,40	355A047
74	43	45	31	200	1,40	355A048
94	43	65	31	75	1,50	355A065
94	43	65	31	100	1,50	355A066
94	43	65	31	150	1,50	355A067
94	43	65	31	200	1,50	355A068
124	43	95	31	75	1,70	355A095
124	43	95	31	100	1,70	355A096
124	43	95	31	150	1,70	355A097
124	43	95	31	200	1,70	355A098

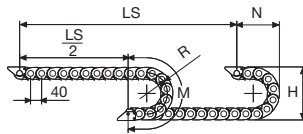

R	H	N	M
mm	mm	mm	mm
75	194	140	315
100	244	165	395
150	344	215	555
200	444	265	710

Length of chain (L)  
Half travel distance ( $\frac{LS}{2}$ )  
plus length of curve (M)

$$L = \frac{LS}{2} + M$$

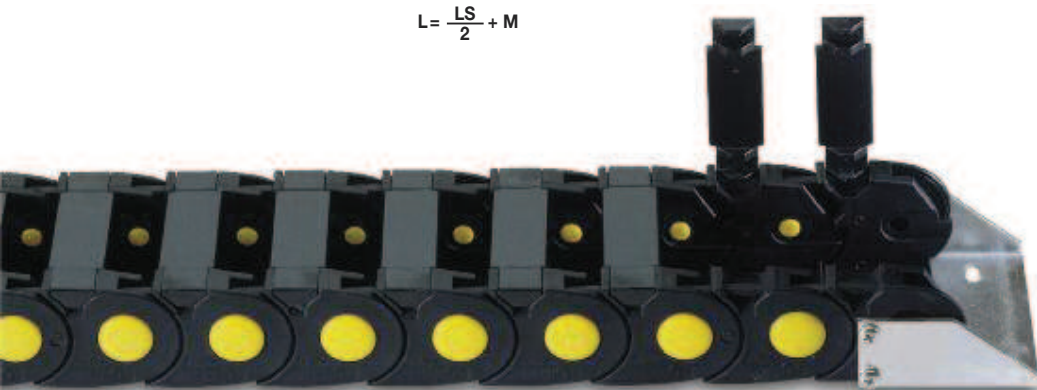

### Self-Supporting Capacity Diagram

The maximum length of the self-supporting capacity ( $\frac{LS}{2}$ ) in relationship to the weight of the cables and hoses contained per linear metre.

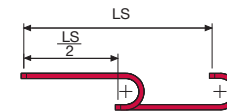
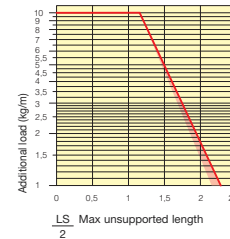

The red marking in the diagram area considers the difference of weight between various widths of chain.

For applications with  $\frac{LS}{2}$  and weights not included in the area of the diagram showing self-supporting capacity, verify the possible use of support rollers (see page 30).

### End Brackets

The end brackets set allows the two ends of the chain to be attached to the equipment.

#### Nylon Type

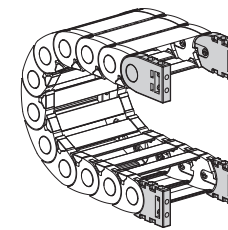

Fig. A  
The chain can be fixed frontally, inner or outer radius. (Fig A)

#### Bright Zinc Plated Steel Type\*\*\*

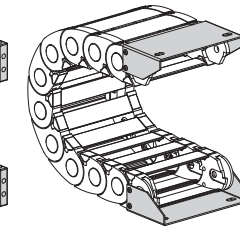
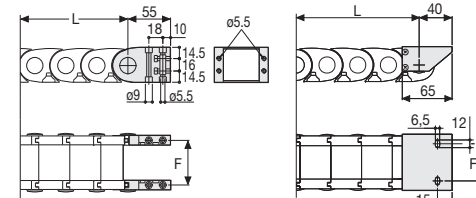

Fig. B  
Chain fixed outside the radius. (Fig B)  
See end brackets mounting variations page 31.



Chain Type	F mm
355A C=45	59
355A C=65	79
355A C=95	109

Chain Type	F mm
355A C=45	50
355A C=65	70
355A C=95	100

### Nylon Type Part Numbers

Complete Set Assembled Chain Type	End Brackets Set
355A C=45	AN355KM
355A C=65	AN355KM
355A C=95	AN355KM

Complete Set Unassembled Chain Type	End Brackets Set
355A C=45	AN355K
355A C=65	AN355K
355A C=95	AN355K

### Bright Zinc Plated Steel Type Part Numbers

Complete Set Assembled Chain Type	End Brackets Set
355A C=45	AP355AKM1
355A C=65	AM355AKM1
355A C=95	AG355AKM1

Complete Set Unassembled Chain Type	End Brackets Set
355A C=45	AP355AK1
355A C=65	AM355AK1
355A C=95	AG355AK1

\*\*\* Available on request in stainless steel

## 355A Nylon Cable Chain with removable frames



How to open the cover.

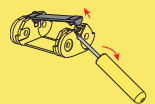
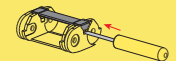

Special tool to remove the connecting pivots:  
Part Number PZ101.



For further information please consult Brevetti Stendalto's Technical Office

## 355 Nylon Cable Chain

### Inner height (D) 30 mm

Double share single link joining construction with large anti-friction single-pin. Non-opening. Vertical separators are available. Due to its design with double-share lateral side, the chain is very robust, meanwhile offering very low friction. Used with guide channels, this chain is particularly suitable for long distance travel.

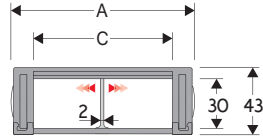

### Separator\*

- Unassembled	Part.no S355
- Assembled	Part.no S355MC

### Pin

Part.no PG355
---------------

\*Separator not to be used in long-stroke applications

### Technical characteristics when self-supported

Speed	10 m/s
Acceleration	50 m/s <sup>2</sup>

For higher requirements please consult our technical dept.

A	B	C	D	R	Weight/m	Chain
mm	mm	mm	mm	mm	kg	Part Number
74	43	45	30	54	1,35	355044
74	43	45	30	75	1,35	355045
74	43	45	30	100	1,35	355046
74	43	45	30	150	1,35	355047
74	43	45	30	200	1,35	355048
94	43	65	30	54	1,45	355064
94	43	65	30	75	1,45	355065
94	43	65	30	100	1,45	355066
94	43	65	30	150	1,45	355067
94	43	65	30	200	1,45	355068
124	43	95	30	54	1,65	355094
124	43	95	30	75	1,65	355095
124	43	95	30	100	1,65	355096
124	43	95	30	150	1,65	355097
124	43	95	30	200	1,65	355098

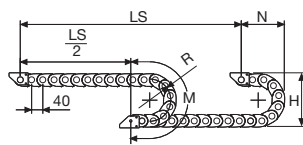

R	H	N	M	N1	M1
mm	mm	mm	mm	mm	mm
54	152	120	250	135	290
75	194	140	315	190	420
100	244	165	395	275	640
150	344	215	555	450	1075
200	444	265	710	620	1515

Length of chain (L)  
 Half travel distance ( $\frac{LS}{2}$ )  
 plus length of curve (M) or (M1)  
 $L = \frac{LS}{2} + M$  or  $M1$

For sliding applications, technical data can slightly change according to frequency, added weight and environment.

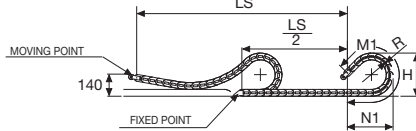

SLIDING VERSION to be ordered with pivoting end brackets set

### Self-Supporting Capacity Diagram

The maximum length of the self-supporting capacity ( $\frac{LS}{2}$ ) in relationship to the weight of the cables and hoses contained per linear metre.

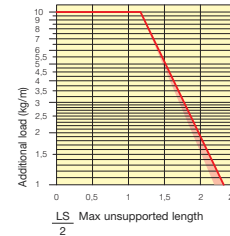

### End Brackets

The end brackets set allows the two ends of the chain to be attached to the equipment.

#### Nylon Type

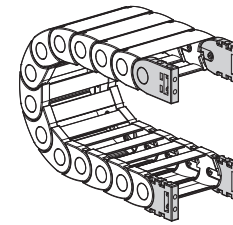

Fig. A The chain can be fixed frontally, inner or outer radius. (Fig A)

#### Bright Zinc Plated Steel Type\*\*\*

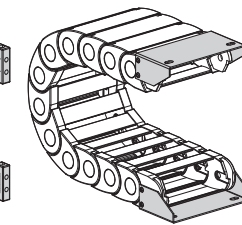
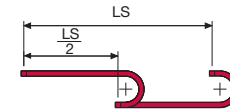
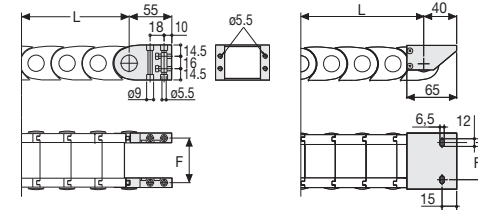

Fig. B Chain fixed outside the radius. (Fig B) See end brackets mounting variations page 31.



The red marking in the diagram area considers the difference of weight between various widths of chain.



Chain Type	F mm
355 C=45	57
355 C=65	77
355 C=95	107

Chain Type	F mm
355 C=45	50
355 C=65	70
355 C=95	100

### Nylon Type Part Numbers

Complete Set Assembled Chain Type	End Brackets Set
355 C=45	AN355KM
355 C=65	AN355KM
355 C=95	AN355KM

Complete Set Unassembled Chain Type	End Brackets Set
355 C=45	AN355K
355 C=65	AN355K
355 C=95	AN355K

### Bright Zinc Plated Steel Type Part Numbers

Complete Set Assembled Chain Type	End Brackets Set
355 C=45	AP355KM□**
355 C=65	AM355KM□**
355 C=95	AG355KM□**

Complete Set Unassembled Chain Type	End Brackets Set
355 C=45	AP355K□**
355 C=65	AM355K□**
355 C=95	AG355K□**

\*\* 1=Pos.1; 2=Pos.2; 3=Pos.3  
 \*\*\* Available on request in stainless steel

## 355 Nylon Cable Chain



Suitable to long travel distance. To choose the guide channel see page 82

Special tool to remove the connecting pivots: Part Number PZ10.



For further information please consult Brevetti Stendalto's Technical Office



## 400 Nylon Cable Chain with removable frames

### Inner height (D) 25 mm

Double share single link joining construction with large anti-friction single-pin. Frames removable from inner radius. Vertical separators are available. Wide frames on outer radius offer good protection. Due to its design with double-share lateral side, the chain is very robust, meanwhile offering very low friction.

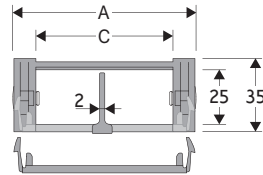

Separator	
- Unassembled	Part.no S400
- Assembled	Part.no S400MC
Pin	
	Part.no PG305

### Technical characteristics when self-supported

Speed	10 m/s
Acceleration	50 m/s <sup>2</sup>

For higher requirements please consult our technical dept.

A	B	C	D	R	Weight/m	Chain
mm	mm	mm	mm	mm	kg	Part Number
62	35	40	25	50	1,10	400040
62	35	40	25	75	1,10	400041
62	35	40	25	100	1,10	400042
62	35	40	25	150	1,10	400043
82	35	60	25	50	1,25	400060
82	35	60	25	75	1,25	400061
82	35	60	25	100	1,25	400062
82	35	60	25	150	1,25	400063

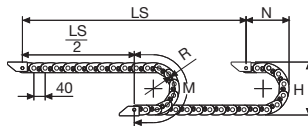

R	H	N	M
mm	mm	mm	mm
50	138	110	240
75	188	135	315
100	238	160	395
150	338	210	555

Length of chain (L)  
Half travel distance ( $\frac{LS}{2}$ )  
plus length of curve (M)

$$L = \frac{LS}{2} + M$$

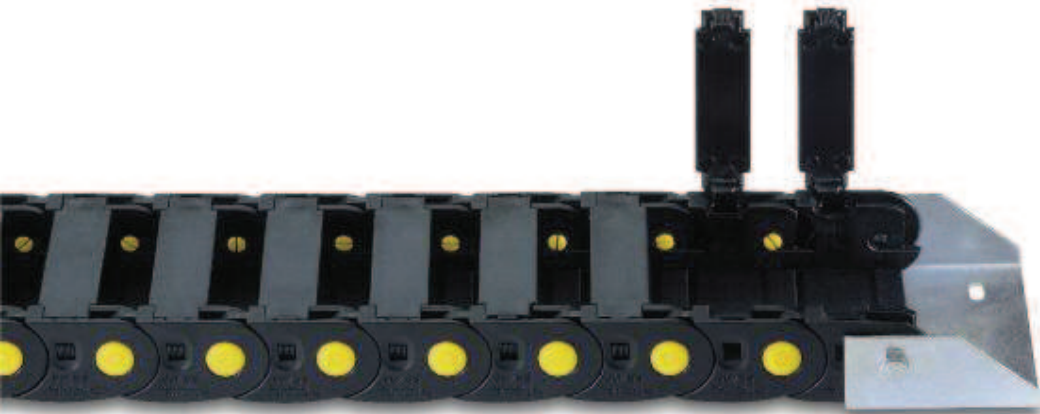

### Self-Supporting Capacity Diagram

The maximum length of the self-supporting capacity ( $\frac{LS}{2}$ ) in relationship to the weight of the cables and hoses contained per linear metre.

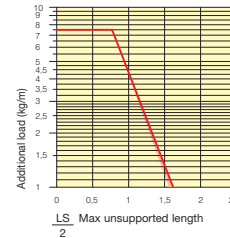

### End Brackets

The end brackets set allows the two ends of the chain to be attached to the equipment.

#### Nylon Type

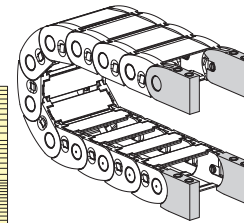

Fig. A Chain fixed outside/inside the radius. (Fig A)

#### Bright Zinc Plated Steel Type\*\*\*

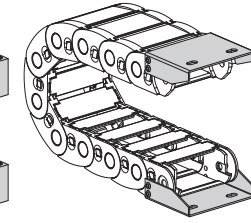
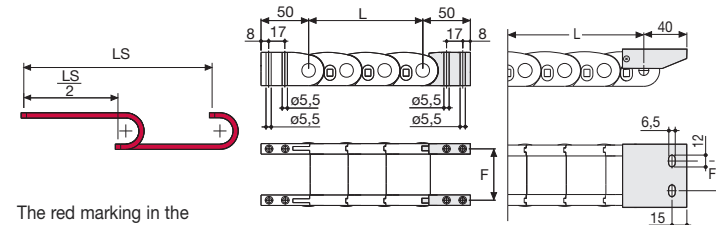

Fig. B Chain fixed outside the radius. (Fig B) See end brackets mounting variations page 31.



The red marking in the diagram area considers the difference of weight between various widths of chain.

For applications with  $\frac{LS}{2}$  and weights not included in the area of the diagram showing self-supporting capacity, verify the possible use of support rollers (see page 30).

Chain Type	F mm
400 C=40	50
400 C=60	70

Chain Type	F mm
400 C=40	30
400 C=60	50

### Nylon Type Part Numbers

Complete Set Assembled Chain Type	End Brackets Set
400 C=40	AN400KM
400 C=60	AN400KM

### Bright Zinc Plated Steel Type Part Numbers

Complete Set Assembled Chain Type	End Brackets Set
400 C=40	AP400KM1
400 C=60	AG400KM1

Complete Set Unassembled Chain Type	End Brackets Set
400 C=40	AN400K
400 C=60	AN400K

Complete Set Unassembled Chain Type	End Brackets Set
400 C=40	AP400K1
400 C=60	AG400K1

\*\*\* Available on request in stainless steel

## 400 Nylon Cable Chain with removable frames

How to open the cover.

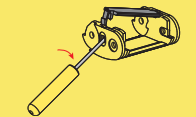
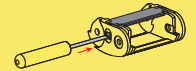

Special tool to remove the connecting pivots: Part Number PZ101.



For further information please consult Brevetti Stendalto's Technical Office

## 435MU Nylon Cable Chain with opening frames

### Inner height (D) 35 mm

Sideband & Frame construction with large anti-friction single-pin. Frames opening from inner radius (435MI) or from outer radius (435ME). Vertical separators are available. This standard 35 mm chain offers very high load capacities, despite its compact construction.

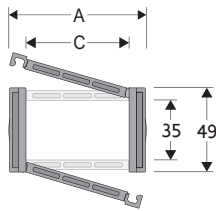

### Separator

- Unassembled	Part.no S4353
- Assembled*	Part.no S4353MCI
- Assembled**	Part.no S4353MCE

### Pin

Part.no PG4353

\* for chain opening outer radius  
\*\* for chain opening inner radius

### Technical characteristics when self-supported

Speed	10 m/s
Acceleration	50 m/s <sup>2</sup>

For higher requirements please consult our technical dept.

A	B	C	D	R	Weight/m	Chain
mm	mm	mm	mm	mm	kg	Part Number
60	49	40	35	060-075-100-125-150-200	1,10	435MU040 □□□ *
70	49	50	35	060-075-100-125-150-200	1,15	435MU050 □□□ *
80	49	60	35	060-075-100-125-150-200	1,20	435MU060 □□□ *
96	49	76	35	060-075-100-125-150-200	1,30	435MU076 □□□ *
117	49	97	35	060-075-100-125-150-200	1,35	435MU097 □□□ *
123	49	103	35	060-075-100-125-150-200	1,45	435MU103 □□□ *
145	49	125	35	060-075-100-125-150-200	1,55	435MU125 □□□ *
170	49	150	35	060-075-100-125-150-200	1,70	435MU150 □□□ *

\*Complete the code by inserting the value of the radius (R): Ex. 435MU040 □□□ □□

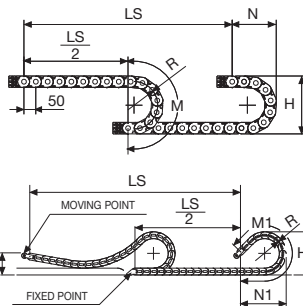

R	H	N	M	N1	M1
mm	mm	mm	mm	mm	mm
060	169	135	290	195	410
075	199	155	340	250	540
100	249	175	415	335	760
125	299	200	495	420	975
150	349	230	575	505	1195
200	449	275	730	680	1635

Length of chain (L)  
Half travel distance ( $\frac{LS}{2}$ )  
plus length of curve (M) or (M1)  
 $L = \frac{LS}{2} + M$  or  $M1$

For sliding applications, technical data can slightly change according to frequency, added weight and environment.

**SLIDING VERSION**  
to be ordered with pivoting end brackets set

### Self-Supporting Capacity Diagram

The maximum length of the self-supporting capacity ( $\frac{LS}{2}$ ) in relationship to the weight of the cables and hoses contained per linear metre.

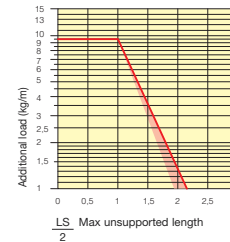

### End Brackets

The end brackets set allows the two ends of the chain to be attached to the equipment. Set complete with tiewrap clamps available on request.

#### Nylon Type

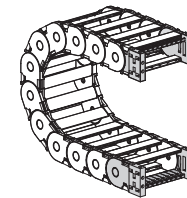

Fig. A  
The chain can be fixed frontally, inner or outer radius. (Fig A)

#### Nylon Type

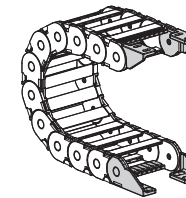
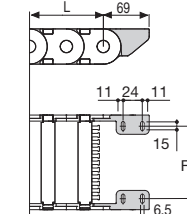
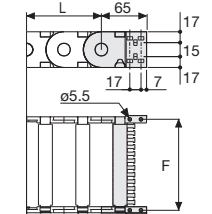

Fig. B  
Chain fixed outside the radius. (Fig B)  
See end brackets mounting variations page 31.



Chain Type	F mm
435MU040	51
435MU050	61
435MU060	71
435MU076	87
435MU097	108
435MU103	114
435MU125	136
435MU150	161

Chain Type	F mm
435MU040	26,5
435MU050	36,5
435MU060	46,5
435MU076	62,5
435MU097	83,5
435MU103	89,5
435MU125	111,5
435MU150	136,5

### Nylon Type Part Numbers

Complete Set Assembled	AN435M □□□ *KM
Complete Set Unassembled	AN435M □□□ *K

### Tiewrap Clamp Part Numbers

Complete Set Assembled	CFC435M □□□ *KM
Complete Set Unassembled	CFC435M □□□ *K

### Nylon Type Part Numbers

Complete Set Assembled	AN435KM □□□ **
Complete Set Unassembled	AN435K □□□ **

### Tiewrap Clamp Part Numbers

Complete Set Assembled	CFC435M □□□ *KM
Complete Set Unassembled	CFC435M □□□ *K

\*\*\*\*1=Pos.1; 2=Pos.2; 3=Pos.3  
\* 1=Pos.1; 2=Pos.2; 3=Pos.3  
5=Pos.5; 6=Pos.6

## 435MU Nylon Cable Chain with opening frames

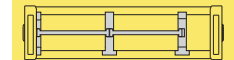

Separation System  
To choose the separators see page. 196

### Bright Zinc Plated Steel Type\*\*\*

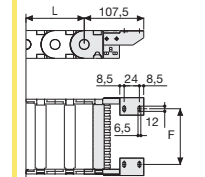
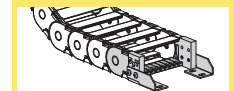

F = A-30

### Bright Zinc Plated Steel Type Part Numbers

Complete Set Assembled	A435M □□□ *KM □ **
Complete Set Unassembled	A435M □□□ *K □ **

### Tiewrap Clamp Part Numbers

Complete Set Assembled	CFC435M □□□ *KM
Complete Set Unassembled	CFC435M □□□ *K

\* Inner width (C)  
\* 1=Pos.1; 2=Pos.2; 3=Pos.3  
\*\*\* Available on request in stainless steel

## 445MU Nylon Cable Chain with opening frames

### Inner height (D) 45 mm

Chain with side-bands and holding pin. Openable outside / inside radius mounted on all the links. Internal separation available and customizable.

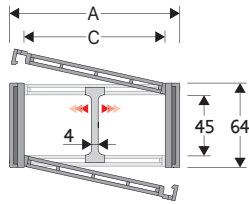

Separator	
- Unassembled	Part.no S445UF
- Assembled**	Part.no S445UFMCI
- Assembled**	Part.no S445UFMCE
Strong-hold separator	
for C > 200 mm	
- Unassembled	Part.no S445SH
- Assembled	Part.no S445SHMC
Pin	
	Part.no PG445

\* for chain opening outer radius  
\*\* for chain opening inner radius

### Technical characteristics when self-supported

Speed	10 m/s
Acceleration	50 m/s <sup>2</sup>

For higher requirements please consult our technical dept.

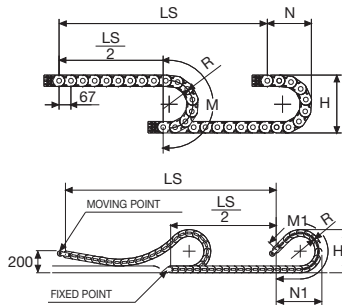

For sliding applications, technical data can slightly change according to frequency, added weight and environment.

**SLIDING VERSION**  
to be ordered with pivoting end brackets set

Length of chain (L)  
Half travel distance ( $\frac{LS}{2}$ )  
plus length of curve (M) or (M1)

$$L = \frac{LS}{2} + M \text{ or } M1$$

\*Complete the code by inserting the value of the radius (R): Ex. 445MU050 □□□□

A	B	C	D	R	Weight/m	Chain
mm	mm	mm	mm	mm	kg	Part Number
72	64	50	45	075-100-125-150-175-200-250-300	1,64	445MU050 □□□□*
83	64	61	45	075-100-125-150-175-200-250-300	1,64	445MU061 □□□□*
97	64	75	45	075-100-125-150-175-200-250-300	1,76	445MU075 □□□□*
103	64	81	45	075-100-125-150-175-200-250-300	1,79	445MU081 □□□□*
107	64	85	45	075-100-125-150-175-200-250-300	1,82	445MU085 □□□□*
117	64	95	45	075-100-125-150-175-200-250-300	1,86	445MU095 □□□□*
122	64	100	45	075-100-125-150-175-200-250-300	1,87	445MU100 □□□□*
129	64	107	45	075-100-125-150-175-200-250-300	1,90	445MU107 □□□□*
139	64	117	45	075-100-125-150-175-200-250-300	1,93	445MU117 □□□□*
147	64	125	45	075-100-125-150-175-200-250-300	2,01	445MU125 □□□□*
158	64	136	45	075-100-125-150-175-200-250-300	2,07	445MU136 □□□□*
172	64	150	45	075-100-125-150-175-200-250-300	2,13	445MU150 □□□□*
197	64	175	45	075-100-125-150-175-200-250-300	2,25	445MU175 □□□□*
222	64	200	45	075-100-125-150-175-200-250-300	2,39	445MU200 □□□□*
233	64	211	45	075-100-125-150-175-200-250-300	2,44	445MU211 □□□□*
247	64	225	45	075-100-125-150-175-200-250-300	2,52	445MU225 □□□□*
274	64	252	45	075-100-125-150-175-200-250-300	2,66	445MU252 □□□□*
283	64	261	45	075-100-125-150-175-200-250-300	2,70	445MU261 □□□□*
308	64	286	45	075-100-125-150-175-200-250-300	2,81	445MU286 □□□□*
334	64	312	45	075-100-125-150-175-200-250-300	2,92	445MU312 □□□□*
356	64	334	45	075-100-125-150-175-200-250-300	3,05	445MU334 □□□□*
384	64	362	45	075-100-125-150-175-200-250-300	3,18	445MU362 □□□□*

R	H	N	M	N1	M1
mm	mm	mm	mm	mm	mm
075	214	180	370	225	465
100	264	200	450	340	740
125	314	225	530	460	1020
150	364	250	605	580	1300
175	414	275	685	700	1575
200	464	300	765	820	1855
250	564	350	920	1055	2410
300	664	400	1080	1295	2970

### Self-Supporting Capacity Diagram

The maximum length of the self-supporting capacity ( $\frac{LS}{2}$ ) in relationship to the weight of the cables and hoses contained per linear metre.

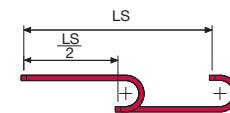
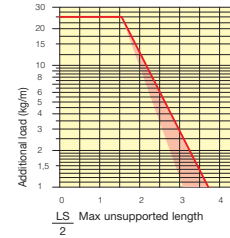

The red marking in the diagram area considers the difference of weight between various widths of chain.

For applications with  $\frac{LS}{2}$  and weights not included in the area of the diagram showing self-supporting capacity, verify the possible use of support rollers (see page 30).

### End Brackets

The end brackets set allows the two ends of the chain to be attached to the equipment. Set complete with tiewrap clamps available on request.

#### Nylon Type

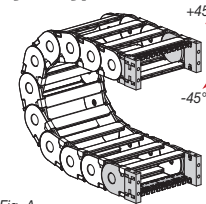

Fig. A  
The chain can be fixed frontally, inner or outer radius. (Fig A)

#### Nylon Type

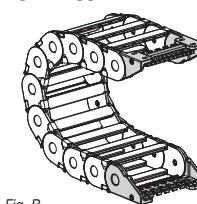
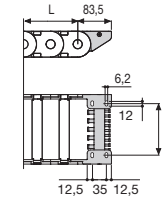
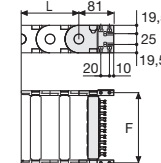

Fig. B  
Chain fixed outside the radius. (Fig B)  
See end brackets mounting variations page 31.



Chain Type	F mm
445MU050	63
445MU061	74
445MU075	88
445MU081	94
445MU085	98
445MU095	108
445MU100	113
445MU107	120
445MU117	130
445MU125	138
445MU136	149
445MU150	163
445MU175	188
445MU200	213
445MU211	224
445MU225	238
445MU252	265
445MU261	274
445MU286	299
445MU312	325
445MU334	347
445MU362	375

#### Nylon Type Part Numbers

Complete Set Assembled	AN445M □□□*KM
Complete Set Unassembled	AN445M □□□*K

#### Tiewrap Clamp Part Numbers

Complete Set Assembled	CFC445M □□□*KM
Complete Set Unassembled	CFC445M □□□*K

Chain Type	F mm
445MU050	28
445MU061	39
445MU075	53
445MU081	59
445MU085	63
445MU095	73
445MU100	78
445MU107	85
445MU117	95
445MU125	103
445MU136	114
445MU150	128
445MU175	153
445MU200	178
445MU211	189
445MU225	203
445MU252	230
445MU261	239
445MU286	264
445MU312	290
445MU334	312
445MU362	340

#### Nylon Type Part Numbers

Complete Set Assembled	AN445KM □□□**
Complete Set Unassembled	AN445K □□□**

#### Tiewrap Clamp Part Numbers

Complete Set Assembled	SFCT445 □□□*KM
Complete Set Unassembled	SFCT445 □□□*K

\*\*1=Pos.1; 2=Pos.2; 3=Pos.3  
\*\*\*1=Pos.1; 2=Pos.2; 3=Pos.3  
5=Pos.5; 6=Pos.6

## 445MU Nylon Cable Chain with opening frames



**END-BRACKETS for SLIDING**  
1- Different fixing combinations.  
2- Aluminum drawn with combs, cable gland mounted either on the fixed point or on the moving point.  
3- Space created for nut housing.

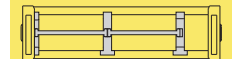

Separation System page. 196

### Bright Zinc Plated Steel Type\*\*\*

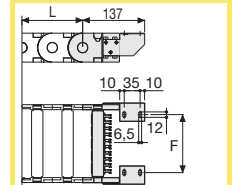

F = A-44

### Bright Zinc Plated Steel Type Part Numbers

Complete Set Assembled	A445M □□□*KM □**
Complete Set Unassembled	A445M □□□*K □**

### Tiewrap Clamp Part Numbers

Complete Set Assembled	CFC445M □□□*KM
Complete Set Unassembled	CFC445M □□□*K

\* Inner width (C)  
\*\* 1=Pos.1; 2=Pos.2; 3=Pos.3  
\*\*\* Available on request in stainless steel



## 660A Nylon Cable Chain with opening frames

### Inner height (D) 37 mm

Double share Sideband & Frame construction with large anti-friction single-pin. Frames opening from inner radius. As standard the chain comes with frames every second link, on request with frames every link. Vertical and horizontal modular separator system is available.

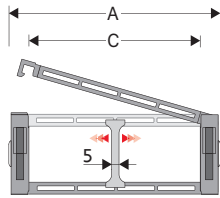

Separator	
- Unassembled	Part.no S306SM
- Assembled	Part.no S306SMMC
Strong-hold separator for C > 200 mm	
- Unassembled	Part.no S660AH
- Assembled	Part.no S660AHMC
Pin	
	Part.no PG660

### Technical characteristics when self-supported

Speed	6 m/s
Acceleration	30 m/s <sup>2</sup>

For higher requirements please consult our technical dept.

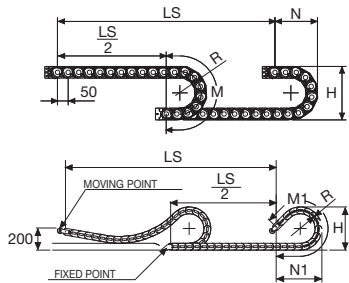

For sliding applications, technical data can slightly change according to frequency, added weight and environment.

Length of chain (L)  
 Half travel distance ( $\frac{LS}{2}$ )  
 plus length of curve (M) or (M1)  
 $L = \frac{LS}{2} + M$  or  $M1$

**SLIDING VERSION**  
 to be ordered with pivoting end brackets set

\*Complete the code by inserting the value of the radius (R): Ex. 660A050 [1] [5] [0]  
 Chain equipped with nylon frame every pitch: complete the code by inserting the letter D.  
 Ex. 660A050150 [D]

R	H	N	M	N1	M1
mm	mm	mm	mm	mm	mm
100	255	180	415	205	470
150	355	230	575	360	855
200	455	280	730	535	1290
250	555	330	885	705	1730

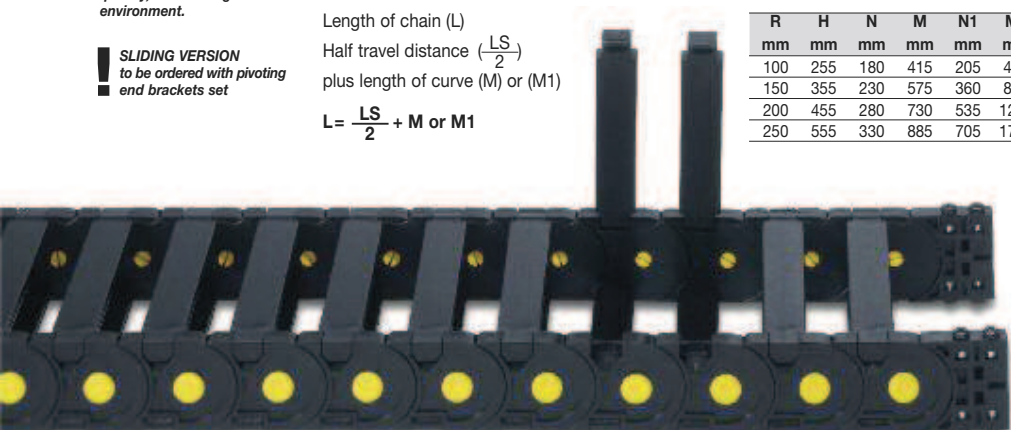

Version with frames mounted on every pitch.

### Self-Supporting Capacity Diagram

The maximum length of the self-supporting capacity ( $\frac{LS}{2}$ ) in relationship to the weight of the cables and hoses contained per linear metre.

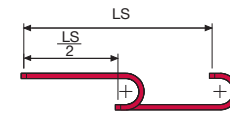
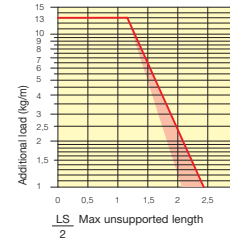

The red marking in the diagram area considers the difference of weight between various widths of chains assembled with nylon frames every second pitch.

For applications with  $\frac{LS}{2}$  and weights not included in the area of the diagram showing self-supporting capacity, verify the possible use of support rollers (see page 30).

### End Brackets

The end brackets set allows the two ends of the chain to be attached to the equipment. Set complete with tie-wrap clamps available on request.

#### Nylon Type

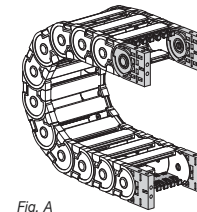
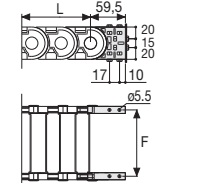

Fig. A The chain can be fixed frontally, inner or outer radius. (Fig A) See end brackets mounting variations page 31.



Chain Type	F mm
660A050	61
660A061	72
660A075	86
660A081	92
660A085	96
660A095	106
660A100	111
660A107	118
660A117	128
660A125	136
660A136	147
660A150	161
660A175	186
660A200	211
660A211	222
660A225	236
660A252	263
660A261	272
660A286	297
660A312	323
660A334	345
660A362	373

#### Nylon Type Part Numbers

Complete Set Assembled Chain	End Brackets
Type	Set
660A...	AN660AKM

Complete Set Unassembled Chain	End Brackets
Type	Set
660A...	AN660AK

Tiewrap Clamp	
Assembl.	CFC660A □□□ *KM
Unassembl.	CFC660A □□□ *K

#### Bright Zinc Plated Steel Type\*\*\*

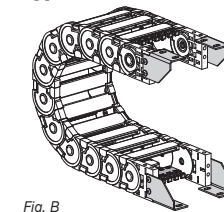
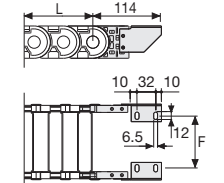

Fig. B Chain fixed outside the radius. (Fig B) See end brackets mounting variations page 31.



Chain Type	F mm
660A050	38
660A061	49
660A075	63
660A081	69
660A085	73
660A095	83
660A100	88
660A107	95
660A117	105
660A125	113
660A136	124
660A150	138
660A175	163
660A200	188
660A211	199
660A225	213
660A252	240
660A261	249
660A286	274
660A312	300
660A334	333
660A362	350

#### Bright Zinc Plated Steel Type Part Numbers

Complete Set Assembled Chain	End Brackets
Type	Set
660A...	A660AKM □**

Complete Set Unassembled Chain	End Brackets
Type	Set
660A...	A660AK □**

Tiewrap Clamp	
Assembl.	CFC660A □□□ *KM
Unassembl.	CFC660A □□□ *K

\* Inner width (C)  
 \*\* 1=Pos.1; 2=Pos.2; 3=Pos.3  
 \*\*\* Available on request in stainless steel

## 660A Nylon Cable Chain with opening frames

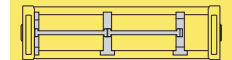

Separation System To choose the separators see page 196

### How to open the cover.

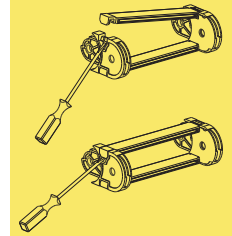

Suitable to long travel distance in frame every pitch version. To choose the guide channel see page 178

Special tool to remove the connecting pivots: Part Number PZ010.



For further information please consult Brevetti Stendalto's Technical Office

## 770A Nylon Cable Chain with opening frames

### Inner height (D) 60 mm

Double share Sideband & Frame construction with large anti-friction single-pin. Frames opening from inner radius. As standard the chain comes with frames every second link, on request with frames every link. Vertical and horizontal modular separator system is available.

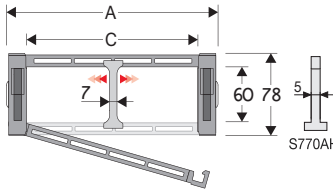

Separator	
- Unassembled	Part.no S770A
- Assembled	Part.no S770AMC
Strong-hold separator for C > 200 mm	
- Unassembled	Part.no S770AH
- Assembled	Part.no S770AHMC
Pin	
	Part.no PG770

### Technical characteristics when self-supported

Speed	6 m/s
Acceleration	30 m/s <sup>2</sup>

For higher requirements please consult our technical dept.

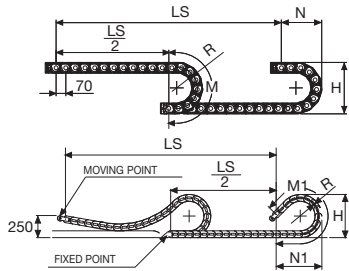

For sliding applications, technical data can slightly change according to frequency, added weight and environment.

SLIDING VERSION  
to be ordered with pivoting end brackets set

Length of chain (L)  
Half travel distance ( $\frac{LS}{2}$ )  
plus length of curve (M) or (M1)

$$L = \frac{LS}{2} + M \text{ or } M1$$

A	B	C	D	R	Weight/m	Chain Part Number
mm	mm	mm	mm	mm	kg	
80	78	45	60	130-150-200-250-300	2,25	770A045 □□□ *
91	78	56	60	130-150-200-250-300	2,25	770A056 □□□ *
105	78	70	60	130-150-200-250-300	2,31	770A070 □□□ *
111	78	76	60	130-150-200-250-300	2,32	770A076 □□□ *
115	78	80	60	130-150-200-250-300	2,34	770A080 □□□ *
125	78	90	60	130-150-200-250-300	2,36	770A090 □□□ *
130	78	95	60	130-150-200-250-300	2,36	770A095 □□□ *
137	78	102	60	130-150-200-250-300	2,38	770A102 □□□ *
147	78	112	60	130-150-200-250-300	2,39	770A112 □□□ *
155	78	120	60	130-150-200-250-300	2,43	770A120 □□□ *
166	78	131	60	130-150-200-250-300	2,46	770A131 □□□ *
180	78	145	60	130-150-200-250-300	2,49	770A145 □□□ *
205	78	170	60	130-150-200-250-300	2,55	770A170 □□□ *
230	78	195	60	130-150-200-250-300	2,62	770A195 □□□ *
241	78	206	60	130-150-200-250-300	2,65	770A206 □□□ *
255	78	220	60	130-150-200-250-300	2,68	770A220 □□□ *
282	78	247	60	130-150-200-250-300	2,75	770A247 □□□ *
291	78	256	60	130-150-200-250-300	2,77	770A256 □□□ *
316	78	281	60	130-150-200-250-300	2,82	770A281 □□□ *
342	78	307	60	130-150-200-250-300	2,88	770A307 □□□ *
364	78	329	60	130-150-200-250-300	2,94	770A329 □□□ *
392	78	357	60	130-150-200-250-300	3,01	770A357 □□□ *

\*Complete the code by inserting the value of the radius (R): Ex. 770A045 □ □ □ □ □  
Chain equipped with nylon frame every pitch: complete the code by inserting the letter D.  
Ex. 770A045150 □ □

R	H	N	M	N1	M1
mm	mm	mm	mm	mm	mm
130	338	240	555	305	685
150	378	260	615	340	785
200	478	310	770	515	1220
250	578	365	930	690	1660
300	678	410	1085	865	2095

### Self-Supporting Capacity Diagram

The maximum length of the self-supporting capacity ( $\frac{LS}{2}$ ) in relationship to the weight of the cables and hoses contained per linear metre.

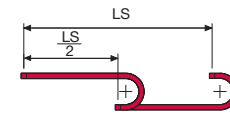
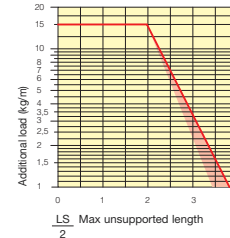

The red marking in the diagram area considers the difference of weight between various widths of chains assembled with nylon frames every second pitch.

For applications with  $\frac{LS}{2}$  and weights not included in the area of the diagram showing self-supporting capacity, verify the possible use of support rollers (see page 30).

### End Brackets

The end brackets set allows the two ends of the chain to be attached to the equipment. Set complete with tiewrap clamps available on request.

### Nylon Type

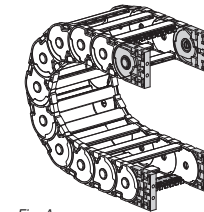
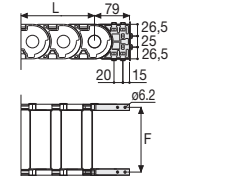

Fig. A  
The chain can be fixed frontally, inner or outer radius. (Fig A) See end brackets mounting variations page 31.



Chain Type	F mm
770A045	61
770A056	72
770A070	86
770A076	92
770A080	96
770A090	106
770A095	111
770A102	118
770A112	128
770A120	136
770A131	147
770A145	161
770A170	186
770A195	211
770A206	222
770A220	236
770A247	263
770A256	272
770A281	297
770A307	323
770A329	345
770A357	373

### Nylon Type Part Numbers

Complete Set Assembled	End Brackets
Chain Type	Set
770A...	AN770AKM

Complete Set Unassembled	End Brackets
Chain Type	Set
770A...	AN770AK

Tiewrap Clamp
Assembl. CFC770A □□□*KM
Unassembl. CFC770A □□□*K

## 770A Nylon Cable Chain with opening frames

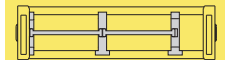

Separation System  
To choose the separators see page 196

### How to open the cover.

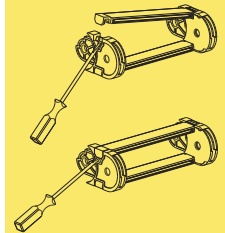

Suitable to long travel distance in frame every pitch version. To choose the guide channel see page 178

Special tool to remove the connecting pivots:  
Part Number PZ010.



For further information please consult Brevetti Stendalto's Technical Office

## 475MU Nylon Cable Chain with opening frames

**Inner height (D) 75,5 mm**  
Chain with side-bands and holding pin.  
Openable outside / inside radius  
mounted on all the links.  
Internal separation available  
and customizable.

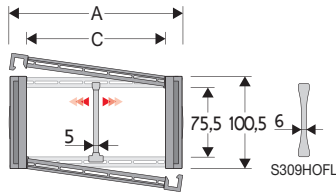

**Separator**  
- Sfuso Part.no S309S/3178  
- Montato\*\* Part.no S309S/3178MCI  
- Montato\*\* Part.no S309S/3178 MCE

**Strong-hold separator**  
per C > 250 mm  
- Sfuso Part.no S309HOFL  
- Montato Part.no S309HOFLMC

**Pin**  
Part.no PG475

\* for chain opening outer radius  
\*\* for chain opening inner radius

### Technical characteristics when self-supported

Speed	8 m/s
Acceleration	40 m/s <sup>2</sup>

For higher requirements please consult our technical dept.

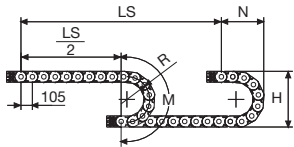

Length of chain (L)  
Half travel distance ( $\frac{LS}{2}$ )  
plus length of curve (M)

$$L = \frac{LS}{2} + M$$

R	H	N	M
mm	mm	mm	mm
150	400,5	310	690
180	460,5	335	775
200	500,5	355	840
250	600,5	405	995
300	700,5	460	1155
350	800,5	505	1310
400	900,5	560	1470

A	B	C	D	R	Weight/m	Chain
mm	mm	mm	mm	mm	kg	Part Number
112	100,5	74	75,5	150-180-200-250-300-350-400	3,70	475MU074 □□□ *
132	100,5	94	75,5	150-180-200-250-300-350-400	3,80	475MU094 □□□ *
157	100,5	119	75,5	150-180-200-250-300-350-400	3,85	475MU119 □□□ *
164	100,5	126	75,5	150-180-200-250-300-350-400	3,90	475MU126 □□□ *
187	100,5	149	75,5	150-180-200-250-300-350-400	3,95	475MU149 □□□ *
227	100,5	189	75,5	150-180-200-250-300-350-400	4,05	475MU189 □□□ *
262	100,5	224	75,5	150-180-200-250-300-350-400	4,15	475MU224 □□□ *
288	100,5	250	75,5	150-180-200-250-300-350-400	4,25	475MU250 □□□ *
312	100,5	274	75,5	150-180-200-250-300-350-400	4,30	475MU274 □□□ *
338	100,5	300	75,5	150-180-200-250-300-350-400	4,37	475MU300 □□□ *
362	100,5	324	75,5	150-180-200-250-300-350-400	4,45	475MU324 □□□ *
388	100,5	350	75,5	150-180-200-250-300-350-400	4,55	475MU350 □□□ *
412	100,5	374	75,5	150-180-200-250-300-350-400	4,60	475MU374 □□□ *
467	100,5	429	75,5	150-180-200-250-300-350-400	4,80	475MU429 □□□ *
536	100,5	498	75,5	150-180-200-250-300-350-400	5,00	475MU498 □□□ *

\*Complete the code by inserting the value of the radius (R): Ex. 475MU119 □□□ □  
Chain equipped with nylon frame every pitch: complete the code by inserting the letter D.  
Ex. 475MU119150 □

### Self-Supporting Capacity Diagram

The maximum length of the self-supporting capacity ( $\frac{LS}{2}$ ) in relationship to the weight of the cables and hoses contained per linear metre.

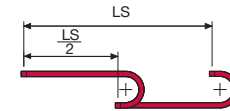
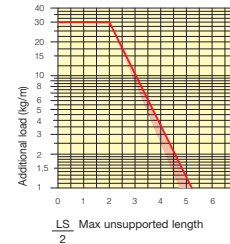

The red marking in the diagram area considers the difference of weight between various widths of chains assembled with nylon frames every second pitch.

For applications with  $\frac{LS}{2}$  and weights not included in the area of the diagram showing self-supporting capacity, verify the possible use of support rollers (see page 30).

### Bright Zinc Plated Steel End Brackets\*\*\*

The end brackets set allows the two ends of the chain to be attached to the equipment. Set complete with tiewrap clamps available on request.

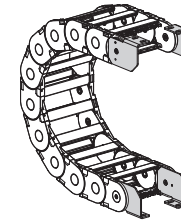
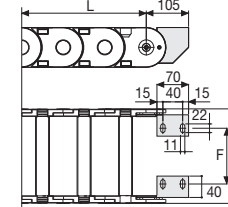

Fig. A  
Chain fixed outside the radius. (Fig A)  
See end brackets mounting variations page 31.



Chain Type	F mm
475MU074	35
475MU094	55
475MU119	80
475MU126	87
475MU149	110
475MU189	150
475MU224	185
475MU250	211
475MU274	235
475MU300	261
475MU324	285
475MU350	311
475MU374	335
475MU429	390
475MU498	459

### Bright Zinc Plated Steel Type Part Numbers

Complete Set Assembled	End Brackets
Chain	Set
Type	Set
475...	A475M□□□*KM□□**

Complete Set Unassembled	End Brackets
Chain	Set
Type	Set
475...	A475M□□□*K□□**

**Tiewrap Clamp**  
Assembl. CFC475M □□□\*KM  
Unassembl. CFC475M □□□\*K  
\* Inner width (C)  
\*\* 1=Pos.1; 2=Pos.2; 3=Pos.3  
\*\*\* Available on request in stainless steel

## 475MU Nylon Cable Chain with opening frames

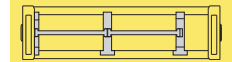

**Separation System**  
To choose the separators see page 196

How to open the cover.

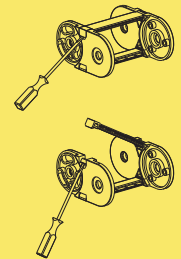

For further information please consult Brevetti Stendalto's Technical Office



## Guide Channel 305-355-435MU

Special Channel guide allows the use of the chain for long travel distance. Available in galvanised steel and, on request, in stainless steel

### Single Chain Application

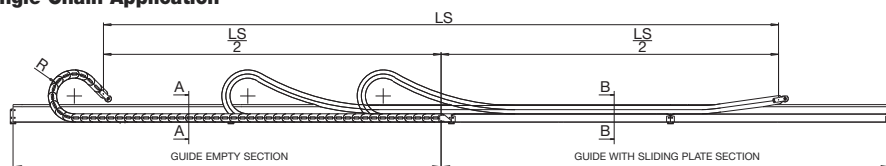

### Double Chain Application

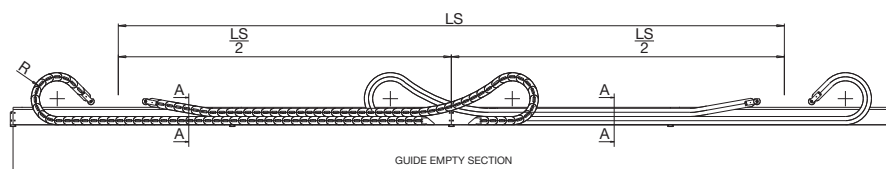

Channel guide is available in kit composed by:  
side walls 2 m standard length  
joining plates  
fixing screws

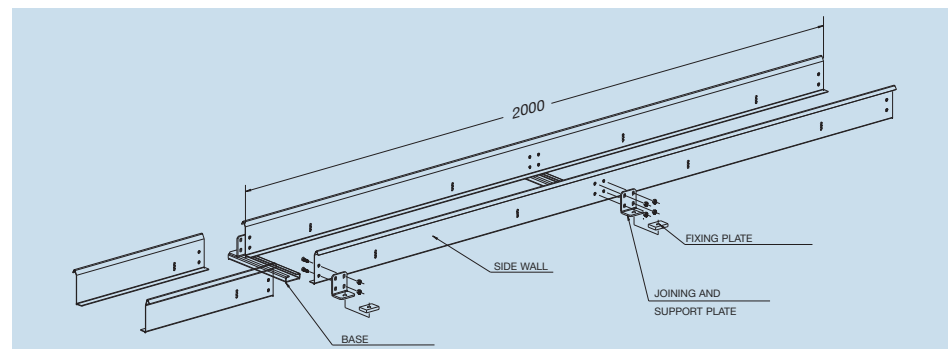

### Guide Empty Section 305-355-435

Section A-A

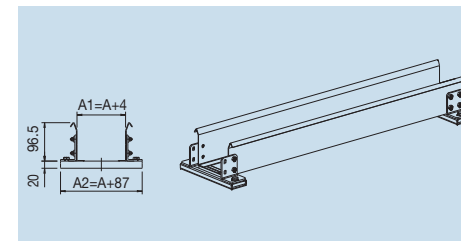

<b>Part Number</b>	CS305...
How to order	
Chain part number	305008
Guide channel part number	CS305008

<b>CS355...</b>	
How to order	
Chain part number	355045
Guide channel part number	CS355045

<b>CS435...</b>	
How to order	
Chain part number	435050060
Guide channel part number	CS435050

### Guide Sliding Plate Section 305

Section B-B

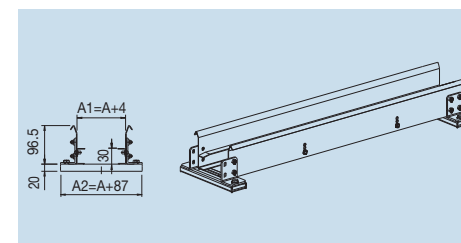

<b>Part Number</b>	CA305...
How to order	
Chain part number	305008
Guide channel part number	CA305008

### Guide Sliding Plate Section 355

Section B-B

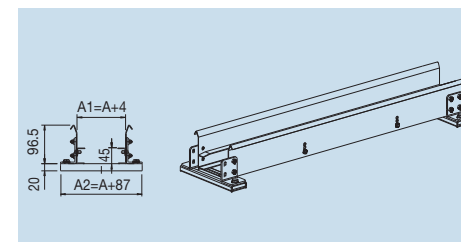

<b>Part Number</b>	CA355...
How to order	
Chain part number	355045
Guide channel part number	CA355045

### Guide Sliding Plate Section 435

Section B-B

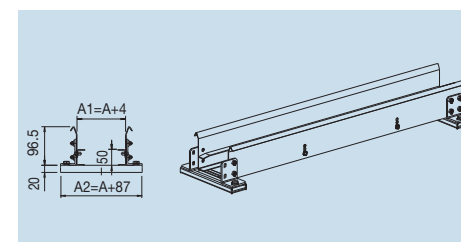

<b>Part Number</b>	CA435...
How to order	
Chain part number	435050060
Guide channel part number	CA435050



## Nylon Cable Chains Heavy Series

H45SC Series	page 86
H57SC Series	page 88
H80SC/SA Series	page 90
H110SC/SA Series	page 92
H110T Series	page 94
306SU Series	page 96
306B Series	page 98
307SU Series	page 100
307B Series	page 102
307E Series	page 104
308SU Series	page 106
308B Series	page 108
308E Series	page 110
309SU Series	page 112
309B Series	page 114
Horizontal Separation	page 196

Wide range of cross pieces  
available in the following types:  
Open and close, with a  
"Snap-Fit" action  
Aluminium Rods  
With Pre-Drilled Holes

Nylon separator. Cables can be laid  
apart from each other

Steel or nylon end brackets

Inner surface of chain  
completely smooth

Triple connecting Pivot Pin  
which offers high integrity in  
high performance applications

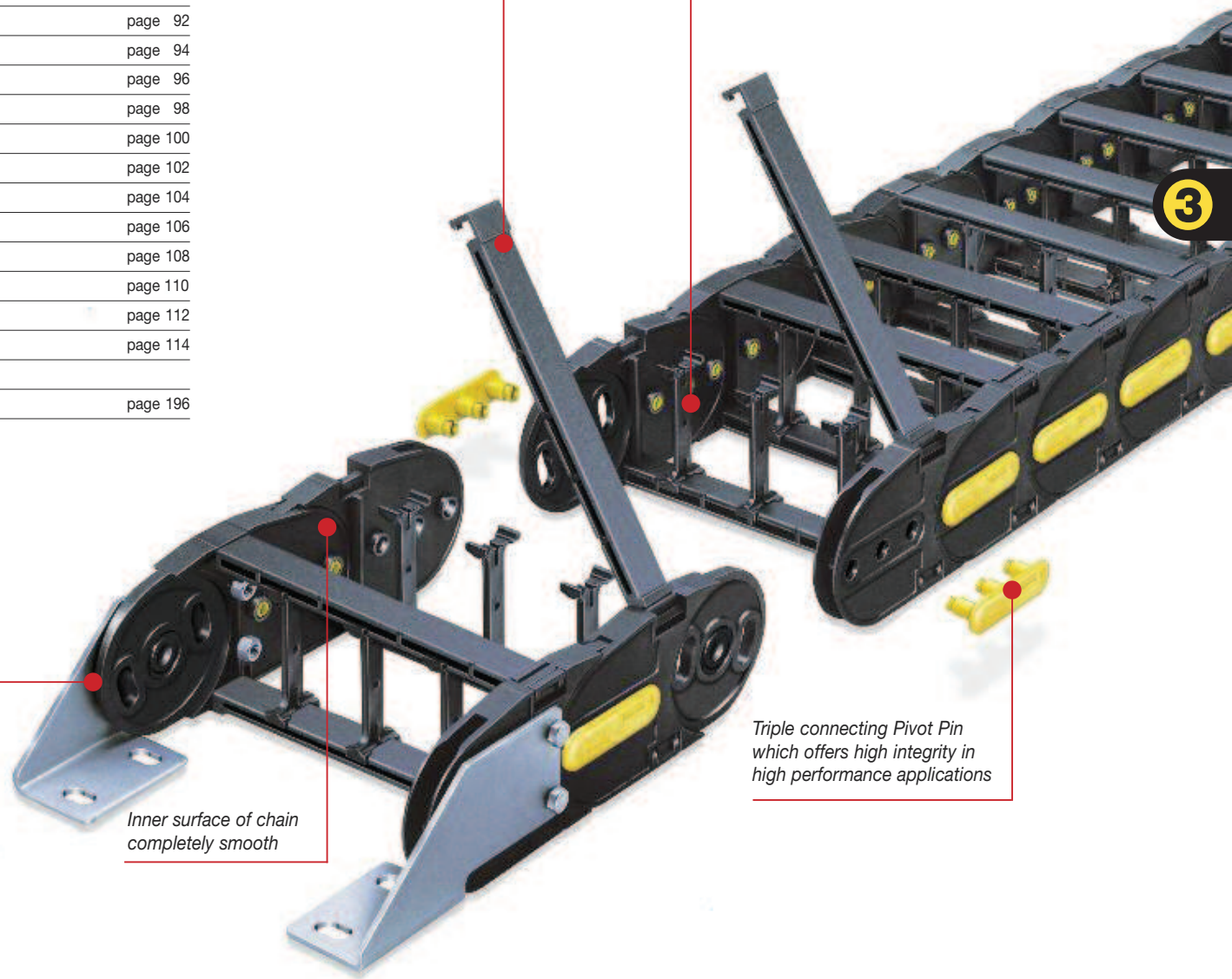

## H45SC Nylon cable chain with opening frames

### Inner height (D) 45 mm

Sideband construction with quickly removable pin. Frames openable from either side on both inner and outer radius. As standard the chain comes with frames every second link, on request with frames every link. Vertical and horizontal modular separator system is available.

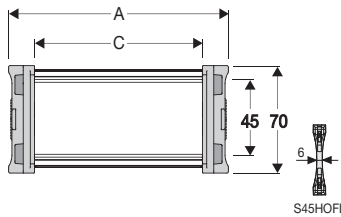

Separator	
-Unassembled	Part.no S45CF3
-Assembled*	Part.no S45CF3MCI
-Assembled**	Part.no S45CF3MCE
Strong-hold Separator	
for C > 250 mm	
-Unassembled	Part.no S45HOFL
-Assembled	Part.no S45HOFL
Pin	
	Part.no PNH45RS

\* for chain opening outer radius  
\*\* for chain opening inner radius

### 3 Technical Characteristics when self-supporting

Speed	8 m/s
Acceleration	40 m/s <sup>2</sup>

For higher requirements please consult our technical dept.

For sliding applications, characteristics techniques may vary depending on the frequency, added weight and work environment.

A	B	C	D	R	Weight/m	Chain
mm	mm	mm	mm	mm	kg	Part Number
113	70	75	45	075-100-125-150-175-200-250-300	2,29	H45SC075 □□□ *
138	70	100	45	075-100-125-150-175-200-250-300	2,37	H45SC100 □□□ *
163	70	125	45	075-100-125-150-175-200-250-300	2,44	H45SC125 □□□ *
188	70	150	45	075-100-125-150-175-200-250-300	2,52	H45SC150 □□□ *
213	70	175	45	075-100-125-150-175-200-250-300	2,60	H45SC175 □□□ *
238	70	200	45	075-100-125-150-175-200-250-300	2,67	H45SC200 □□□ *
263	70	225	45	075-100-125-150-175-200-250-300	2,75	H45SC225 □□□ *
288	70	250	45	075-100-125-150-175-200-250-300	2,83	H45SC250 □□□ *
313	70	275	45	075-100-125-150-175-200-250-300	2,91	H45SC275 □□□ *
338	70	300	45	075-100-125-150-175-200-250-300	2,99	H45SC300 □□□ *
388	70	350	45	075-100-125-150-175-200-250-300	3,14	H45SC350 □□□ *
438	70	400	45	075-100-125-150-175-200-250-300	3,30	H45SC400 □□□ *

\*Complete the code by inserting the value of the radius (R): Ex. H45SC100 □ □ □ □ □  
Chain equipped with nylon frame every pitch: complete the code by inserting the letter D. Ex. H45SC100250 □ □

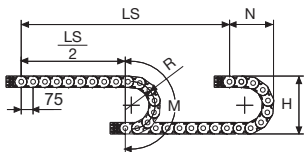

Length of chain (L)  
Half travel distance ( $\frac{LS}{2}$ )  
plus length of curve (M) or (M1)

$$L = \frac{LS}{2} + M \text{ or } M1$$

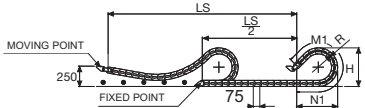

R	H	N	M	N1	M1
mm	mm	mm	mm	mm	mm
075	220	185	390	265	540
100	270	210	465	275	595
125	320	235	545	395	870
150	370	260	625	515	1150
175	420	285	700	635	1430
200	470	310	780	750	1705
250	570	360	940	990	2265
300	670	410	1095	1225	2820

### Self-Supporting Capacity Diagram

The maximum length of the self-supporting capacity or in admissible sagging in relationship to the weight of the cables and hoses contained per linear metre.

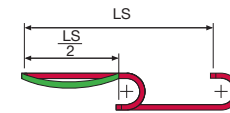
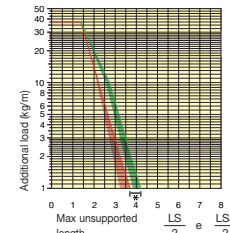

\*If the chain is in the **ADMISSIBLE SAGGING** area (between GREEN and RED area) version with frames on every link is necessary.

The area in the diagram considers the difference of weight between various widths.

Red for self-supporting chain, green for chain in admissible sagging.

For applications with ( $\frac{LS}{2}$ ) and weights not included in the diagram of self-supporting capacity, verify the possible use of support rollers (see page 30).

### End Brackets

The end brackets set allows the two ends of the chain to be attached to the equipment. Set complete with tiwrap clamps available on request.

#### Nylon Type

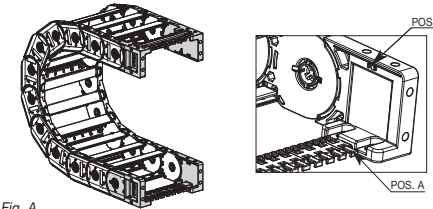
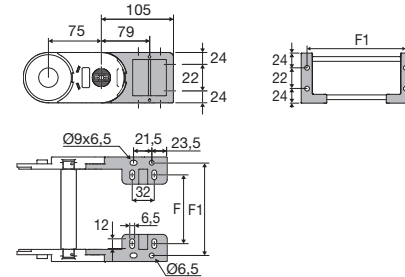

Fig. A  
The chain can be fixed frontally, inner and outer radius (Fig A)



Chain Type	F mm
H45SC075	91
H45SC100	116
H45SC125	141
H45SC150	166
H45SC175	191
H45SC200	216
H45SC225	241
H45SC250	266
H45SC275	291
H45SC300	316
H45SC350	366
H45SC400	416

Chain Type	F mm
H45SC075	55,5
H45SC100	80,5
H45SC125	105,5
H45SC150	130,5
H45SC175	155,5
H45SC200	180,5
H45SC225	205,5
H45SC250	230,5
H45SC275	255,5
H45SC300	280,5
H45SC350	330,5
H45SC400	380,5

### Nylon Type Part Numbers

Complete Set Assembled  
Chain End Brackets  
Type set

H45SC... ANH45SC□□□K□□\*\*

Complete Set Unassembled  
Chain End Brackets  
Type set

H45SC... ANH45SC□□□K□□

\*\* 1=Pos.1; 2=Pos.2; 3=Pos.3

### Tiewrap Clamp

Complete Set Assembled  
Chain Tiewrap Clamp  
Type set

Pos. A SFCTH45□□□\*KMA  
Pos. B SFCTH45□□□\*KM

Complete Set Unassembled  
Mounting Tiewrap Clamp  
Position set

Pos. A SFCTH45□□□\*KA  
Pos. B SFCTH45□□□\*K

\* Inner Width C

## H45SC Nylon cable chain with opening frames

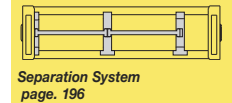

Separation System  
page. 196

### How to open the frame



### How to release the pin junction

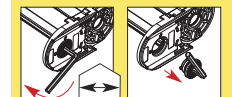

8 mm

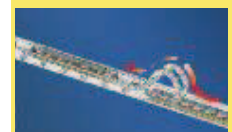

Suitable to long travel distance in frame every pitch version.

For further informations please consult Brevetti Stendalto's Technical Office



## H57SC

### Nylon cable chain with opening frames

#### Inner height (D) 57 mm

Sideband construction with quickly removable pin. Frames openable from either side on both inner and outer radius. As standard the chain comes with frames every second link, on request with frames every link. Vertical and horizontal modular separator system is available.

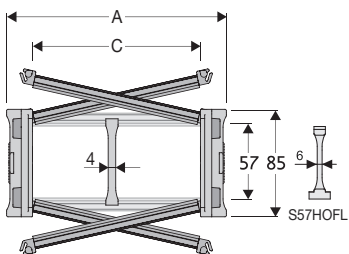

Separator	
-Unassembled	Part.no S57CF3
-Assembled*	Part.no S57CF3MCI
-Assembled**	Part.no S57CF3MCE
Strong-hold Separator	
for C > 250 mm	
-Unassembled	Part.no S57HOFL
-Assembled	Part.no S57HOFL
Pin	
Part.no PNH57RS	

\* for chain opening outer radius  
\*\* for chain opening inner radius

#### Technical Characteristics when self-supporting

Speed	8 m/s
Acceleration	40 m/s <sup>2</sup>

For higher requirements please consult our technical dept.

For sliding applications, characteristics techniques may vary depending on the frequency, added weight and work environment.

A	B	C	D	R	Weight/m	Chain
mm	mm	mm	mm	mm	kg	Part Number
113	85	75	57	150-180-200-250-300-350-400	3,03	H57SC075 □□□ *
138	85	100	57	150-180-200-250-300-350-400	3,09	H57SC100 □□□ *
163	85	125	57	150-180-200-250-300-350-400	3,16	H57SC125 □□□ *
188	85	150	57	150-180-200-250-300-350-400	3,22	H57SC150 □□□ *
213	85	175	57	150-180-200-250-300-350-400	3,29	H57SC175 □□□ *
238	85	200	57	150-180-200-250-300-350-400	3,35	H57SC200 □□□ *
263	85	225	57	150-180-200-250-300-350-400	3,42	H57SC225 □□□ *
288	85	250	57	150-180-200-250-300-350-400	3,48	H57SC250 □□□ *
313	85	275	57	150-180-200-250-300-350-400	3,55	H57SC275 □□□ *
338	85	300	57	150-180-200-250-300-350-400	3,61	H57SC300 □□□ *
388	85	350	57	150-180-200-250-300-350-400	3,74	H57SC350 □□□ *
438	85	400	57	150-180-200-250-300-350-400	3,88	H57SC400 □□□ *

\*Complete the code by inserting the value of the radius (R): Ex. H57SC100 □□□ □□  
Chain equipped with nylon frame every pitch: complete the code by inserting the letter D. Ex. H57SC100250 □□

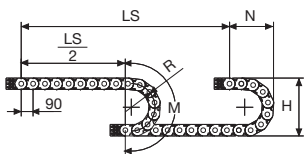

Length of chain (L)  
Half travel distance ( $\frac{LS}{2}$ )  
plus length of curve (M) or (M1)

$$L = \frac{LS}{2} + M \text{ or } M1$$

R	H	N	M	N1	M1
mm	mm	mm	mm	mm	mm
150	385	283	655	565	1235
180	445	313	750	705	1570
200	485	333	810	805	1605
250	585	383	970	1040	2350
300	685	433	1125	1275	2905
350	785	483	1280	1510	3460
400	885	533	1440	1750	4020

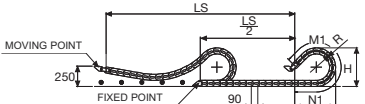

Version with frames mounted on every pitch

#### Self-Supporting Capacity Diagram

The maximum length of the self-supporting capacity or in admissible sagging ( $\frac{LS}{2}$ ) in relationship to the weight of the cables and hoses contained per linear metre.

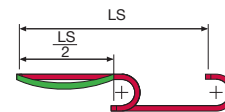
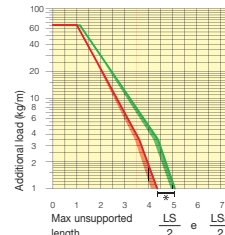

\*If the chain is in the **ADMISSIBLE SAGGING area** (between GREEN and RED area) version with frames on every link is necessary.

The area in the diagram considers the difference of weight between various widths of chain with nylon frame every second link.

Red for self-supporting chain, green for chain in admissible sagging.

For applications with ( $\frac{LS}{2}$ ) and weights not included in the diagram of self-supporting capacity, verify the possible use of support rollers (see page 30).

#### End Brackets

The end brackets set allows the two ends of the chain to be attached to the equipment. Set complete with tiewrap clamps available on request.

#### Nylon Type

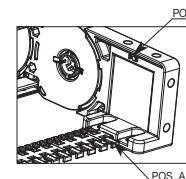
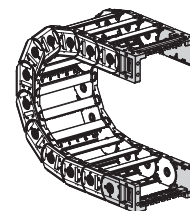
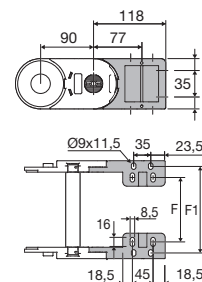

Fig. A The chain can be fixed frontally, inner and outer radius (Fig A)



Chain Type	F mm
H57SC075	51
H57SC100	76
H57SC125	101
H57SC150	126
H57SC175	151
H57SC200	176
H57SC225	201
H57SC250	226
H57SC275	251
H57SC300	276
H57SC350	326
H57SC400	376

Chain Type	F1 mm
H57SC075	98
H57SC100	123
H57SC125	148
H57SC150	173
H57SC175	198
H57SC200	223
H57SC225	248
H57SC250	273
H57SC275	298
H57SC300	323
H57SC350	373
H57SC400	423

#### Nylon Type Part Numbers

Complete Set Assembled Chain Type	End Brackets set
H57SC...	ANH57KM□*
Complete Set Unassembled Chain Type	End Brackets set
H57SC...	ANH57K

\*\* 1=Pos.1; 2=Pos.2; 3=Pos.3

#### Tiewrap Clamp

Complete Set Assembled Chain Type	End Brackets set
Pos. A	SFCTH57□□□*KMA
Pos. B	SFCTH57□□□*KMB
Complete Set Unassembled Mounting Position	Tiewrap Clamp set
Pos. A	SFCTH57□□□*KA
Pos. B	SFCTH57□□□*KB

\* Inner Width C

## H57SC

### Nylon cable chain with opening frames



**H57B**  
On request can be supplied with rods made of stainless steel or bright zinc plated steel.



**H57T**  
On request can be supplied with drawn made of stainless steel or bright zinc plated steel.

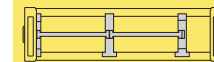

Separation System page. 196

How to open the frame



How to release the pin junction

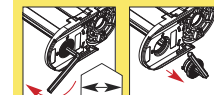

8 mm



Suitable to long travel distance with covers on all the pitches.

For further informations please consult Brevetti Stendalto's Technical Office

## H80SC Nylon Chain with opening frame with a snap

**Inner height (D) 80,5 mm**  
Sideband construction with quickly removable pin. Frames openable from either side on both inner and outer radius. As standard the chain comes with frames every link. Vertical and horizontal modular separator system is available.

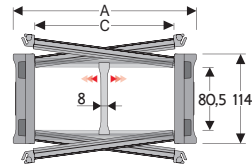

Separator	
- Unassembled	Part.no SH80SCF6
- Assembled*	Part.no SH80SCF6MCI
- Assembled**	Part.no SH80SCF6MCE
Strong-hold Separator	
for C > 250 mm	
- Unassembled	Part.no SH80HOF6L
- Assembled	Part.no SH80HOF6LMC

\* for chain opening outer radius  
\*\* for chain opening inner radius

### Technical characteristics when self-supported

Speed	8 m/s
Acceleration	40 m/s <sup>2</sup>

For higher requirements please consult our technical dept.

For siding applications, characteristics techniques may vary depending on the frequency, added weight and work environment.

R	H	N	M	N1	M1
mm	mm	mm	mm	mm	mm
200	514	377	870	810	1775
250	614	427	1030	1050	2330
300	714	477	1185	1285	2885
350	814	527	1340	1525	3445
400	914	577	1500	1760	4000
500	1114	677	1815	2235	5115
600	1314	777	2125	2705	6225

A	B	C	D	R	Weight/m	Chain
mm	mm	mm	mm	mm	kg	Part Number
205	114	150	80,5	200-250-300-350-400-500-600	6,70	H80SC150 □□□*
230	114	175	80,5	200-250-300-350-400-500-600	6,87	H80SC175 □□□*
255	114	200	80,5	200-250-300-350-400-500-600	7,04	H80SC200 □□□*
280	114	225	80,5	200-250-300-350-400-500-600	7,20	H80SC225 □□□*
305	114	250	80,5	200-250-300-350-400-500-600	7,37	H80SC250 □□□*
330	114	275	80,5	200-250-300-350-400-500-600	7,52	H80SC275 □□□*
355	114	300	80,5	200-250-300-350-400-500-600	7,66	H80SC300 □□□*
380	114	325	80,5	200-250-300-350-400-500-600	7,86	H80SC325 □□□*
405	114	350	80,5	200-250-300-350-400-500-600	8,05	H80SC350 □□□*
430	114	375	80,5	200-250-300-350-400-500-600	8,23	H80SC375 □□□*

\*Complete the code by inserting the value of the radius (R): Ex. H80SC200 □□□□□

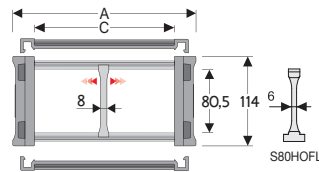

Separator	
- Unassembled	Part.no S80
- Assembled*	Part.no S80MCI
- Assembled**	Part.no S80MCE
Strong-hold Separator	
for C > 250 mm	
- Unassembled	Part.no S80HOF6L
- Assembled	Part.no S80HOF6LMC
Pin	
	Part.no PNH80RS

\* for chain opening outer radius  
\*\* for chain opening inner radius

### H80SA Version with openable frame by both sides

A	B	C	D	R	Weight/m	Chain
mm	mm	mm	mm	mm	kg	Part Number
129	114	74	80,5	200-250-300-350-400-500-600	5,99	H80SA074 □□□*
149	114	94	80,5	200-250-300-350-400-500-600	6,10	H80SA094 □□□*
174	114	119	80,5	200-250-300-350-400-500-600	6,22	H80SA119 □□□*
181	114	126	80,5	200-250-300-350-400-500-600	6,23	H80SA126 □□□*
484	114	429	80,5	200-250-300-350-400-500-600	8,22	H80SA429 □□□*
553	114	498	80,5	200-250-300-350-400-500-600	8,77	H80SA498 □□□*

\*Complete the code by inserting the value of the radius (R): Ex. H80SA119 □□□□□

### Self-Supporting Capacity Diagram

The maximum length of the self-supporting capacity or in admissible sagging ( $\frac{LS}{2}$ ) in relationship to the weight of the cables and hoses contained per linear metre.

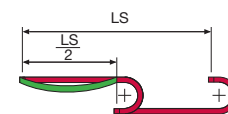
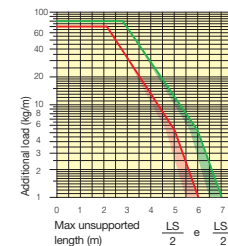

\*If the chain is in the **ADMISSIBLE SAGGING** area (between GREEN and RED area) version with frames on every link is necessary.

The area in the diagram considers the difference of weight between various widths of chain with nylon frame every second link.

Red for self-supporting chain, green for chain in admissible sagging.

For applications with ( $\frac{LS}{2}$ ) and weights not included in the diagram of self-supporting capacity, verify the possible use of support rollers (see page 30).

### End Brackets

The end brackets set allows the two ends of the chain to be attached to the equipment. Set complete with tiewrap clamps available on request.

### Nylon Type

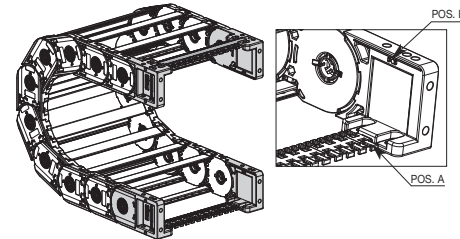
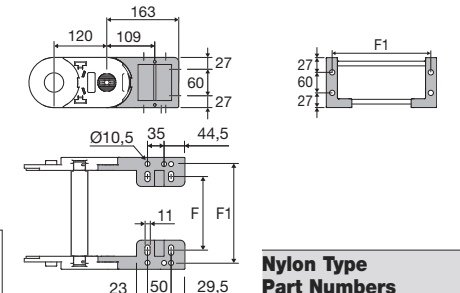

Fig. A  
The chain can be fixed frontally, inner and outer radius (Fig A)



Chain Type	F mm	F1 mm
H80SC150	124	177,5
H80SC175	149	202,5
H80SC200	174	227,5
H80SC225	199	252,5
H80SC250	224	277,5
H80SC275	249	302,5
H80SC300	274	327,5
H80SC325	299	352,5
H80SC350	324	377,5
H80SC375	349	402,5

### Nylon Type Part Numbers

Assembled Chain Type	End Brackets set
H80SC	ANH80KM□□**

Unassembled Chain Type	End Brackets set
H80SC	ANH80K*

### Tiewrap Clamp

Complete Set Assembled Mounting Position	Tiewrap Clamp set
Pos. A	SFCTH80□□□*KA
Pos. B	SFCTH80□□□*KM

Complete Set Unassembled Mounting Position	Tiewrap Clamp set
Pos. A	SFCTH80□□□*KA
Pos. B	SFCTH80□□□*K

\* Inner Width C  
\*\* 1=Pos.1; 2=Pos.2; 3=Pos.3  
\*\*\* For 074 and 094 shares assembly is only on position B

## H80SC Nylon chain with opening frame with a snap



**H80B**  
On request can be supplied with rods made of stainless steel or aluminium.



**H80T**  
On request can be supplied with drawn made of aluminium.

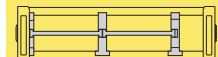

Separation System  
page. 196

How to open  
the frame



How to release  
the pin junction

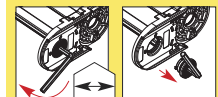

10 mm



Suitable to long travel distance  
with covers on all the pitches.

For further informations please  
consult Brevetti Stendalto's  
Technical Office

## H110SC Nylon Chain with opening frame with a snap

**Inner height (D) 115 mm**  
Sideband construction with quickly removable pin. Frames openable from either side on both inner and outer radius. As standard the chain comes with frames every link. Vertical and horizontal modular separator system is available.

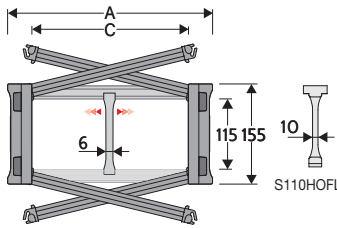

Separator	
- Unassembled	Part.no S110F3
- Assembled*	Part.no S110F3MCI
- Assembled**	Part.no S110F3MCE
Strong - Hold Separator for C > 250 mm	
- Unassembled	Part.no S110HOFL
- Assembled	Part.no S110HOFLMC
Pin	
	Part.no PNH110RS

\* for chain opening outer radius  
\*\* for chain opening inner radius

### Technical characteristics when self-supported

Speed	8 m/s
Acceleration	40 m/s <sup>2</sup>

For higher requirements please consult our technical dept.

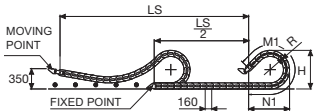
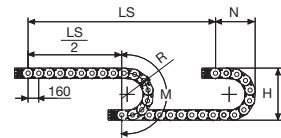

For sliding applications, characteristics techniques may vary depending on the frequency, added weight and work environment.

R	H	N	M	N1	M1
mm	mm	mm	mm	mm	mm
200	557	418	950	855	1820
250	657	468	1110	1095	2375
300	757	518	1265	1335	2935
400	957	618	1580	1805	4045
500	1157	718	1895	2280	5160
600	1357	818	2205	2750	6270
700	1557	918	2520	3225	7385
750	1657	968	2680	3460	7940

A	B	C	D	R	Weight/m	Chain
mm	mm	mm	mm	mm	kg	Part Number
205	155	150	115	200-250-300-400-500-600-700-750	8,66	110SC150 □□□*
230	155	175	115	200-250-300-400-500-600-700-750	8,79	110SC175 □□□*
255	155	200	115	200-250-300-400-500-600-700-750	8,91	110SC200 □□□*
280	155	225	115	200-250-300-400-500-600-700-750	9,03	110SC225 □□□*
305	155	250	115	200-250-300-400-500-600-700-750	9,16	110SC250 □□□*
330	155	275	115	200-250-300-400-500-600-700-750	9,27	110SC275 □□□*
355	155	300	115	200-250-300-400-500-600-700-750	9,38	110SC300 □□□*
380	155	325	115	200-250-300-400-500-600-700-750	9,53	110SC325 □□□*
405	155	350	115	200-250-300-400-500-600-700-750	9,70	110SC350 □□□*
430	155	375	115	200-250-300-400-500-600-700-750	9,80	110SC375 □□□*

\*Complete the code by inserting the value of the radius (R): Ex. 110SC350 [2][5][0]

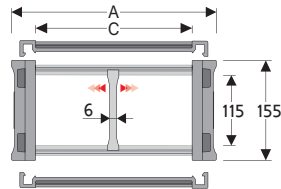

Separator	
- Unassembled	Part.no S110F3/8687
- Assembled*	Part.no S110F3/8687/MCI
- Assembled**	Part.no S110F3/8687/MCE
Strong - Hold Separator for C > 250 mm	
- Unassembled	Part.no S110HOFL/8688
- Assembled	Part.no S110HOFL/8688/MC
Pin	
	Part.no PNH110RS

\* for chain opening outer radius  
\*\* for chain opening inner radius

### SA Version with openable frame by both sides

A	B	C	D	R	Weight/m	Chain
mm	mm	mm	mm	mm	kg	Part Number
484	155	429	115	200-250-300-400-500-600-700-750	9,85	110SA429 □□□*
553	155	498	115	200-250-300-400-500-600-700-750	10,2	110SA498 □□□*

\*Complete the code by inserting the value of the radius (R): Ex. 110SC429 [2][5][0]

### Self-Supporting Capacity Diagram

The maximum length of the self-supporting capacity or in admissible sagging ( $\frac{LS}{2}$ ) in relationship to the weight of the cables and hoses contained per linear metre.

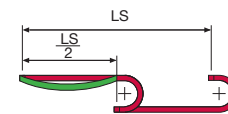
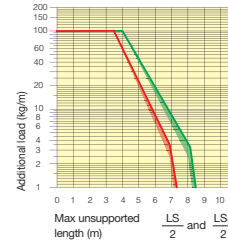

\*If the chain is in the ADMISSIBLE SAGGING area (between GREEN and RED area) version with frames on every link is necessary.

The area in the diagram considers the difference of weight between various widths of chain with nylon frame every second link.

Red for self-supporting chain, green for chain in admissible sagging.

For applications with ( $\frac{LS}{2}$ ) and weights not included in the diagram of self-supporting capacity, verify the possible use of support rollers (see page 30).

### Bright Zinc Plated Steel End Brackets

The end brackets set allows the two ends of the chain to be attached to the equipment. Set complete with tiewrap clamps available on request.

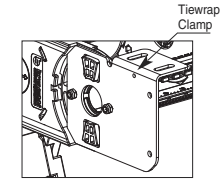
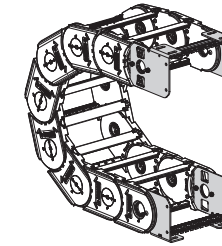
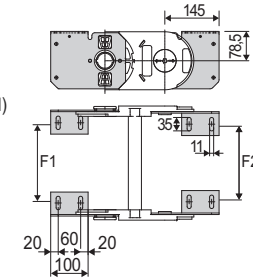

Fig. A Chain fixed outside/inside the radius. (Fig A) See mounting options page 31

Length of chain ( $L - \frac{LS}{2}$ )  
Half travel distance ( $\frac{LS}{2}$ ) plus length of curve (M) or (M1)

$$L = \frac{LS}{2} + M \text{ or } M1$$



Separation System page. 196

Chain Type	F1 mm
110SC150	120
110SC175	145
110SC200	170
110SC225	195
110SC250	220
110SC275	245
110SC300	270
110SC325	295
110SC350	320
110SC375	344
110SA429	399
110SA498	468
Special widths	F = C-65

Chain Type	F2 mm
110SC150	112
110SC175	137
110SC200	162
110SC225	187
110SC250	212
110SC275	237
110SC300	262
110SC325	287
110SC350	312
110SC375	336
110SA429	391
110SA498	460
Special widths	F = C-93

### Bright Zinc Plated Steel Type Part Number

Complete Set Assembled Chain type	End Brackets kit
110SC	A110SC □□□ KM □□*
110SA	A110SA □□□ KM □□*

Complete Set Unassembled Chain type	End Brackets kit
110SC	A110SC □□□ K □□*
110SA	A110SA □□□ K □□*

Available on request in stainless steel.  
\*\* 1=Pos.1; 2=Pos.2; 3=Pos.3  
See mounting variations page 31

### Tiewrap Clamp kit mounted on female attachment

Part Number	
Assembled	SFCT110 □□□ *FKM
Unassembled	SFCT110 □□□ *FK

### Tiewrap Clamp kit mounted on male attachment

Part Number	
Assembled	SFCT110 □□□ *MKM
Unassembled	SFCT110 □□□ *MK

\*Inner width (C)

## H110SC Nylon chain with opening frame with a snap



**H110B**  
On request can be supplied with rods made of stainless steel or bright zinc plated steel.

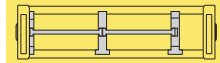

Separation System page. 196

### How to open the frame



### How to release the pin junction

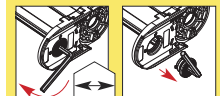

10 mm



Suitable to long travel distance with covers on all the pitches.

For further informations please consult Brevetti Stendalto's Technical Office



## H110T Nylon chain with aluminium draw plates

### Inner height (D) 112,5 mm

Sideband construction with quickly removable pin.  
Alu-draw frames are un-screwable from inner and outer radius.  
As standard the chain comes with frames every link.  
Vertical separators system available.

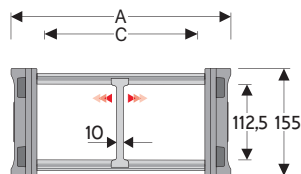

Separator	
- Unassembled	Part.no S310TCF9
- Assembled	Part.no S310TCF9MC
Pin	
	Part.no PNH110RS

### Technical characteristics when self-supported

Speed	4 m/s
Acceleration	20 m/s <sup>2</sup>

For higher requirements please consult our technical dept.

For sliding applications, characteristics techniques may vary depending on the frequency, added weight and work environment.

A	B	C	D	R	Weight/m	Chain
mm	mm	mm	mm	mm	kg	Part Number
255	155	200	112,5	200-250-300-400-500-600-700-750	9,93	110T200 □□□ *
355	155	300	112,5	200-250-300-400-500-600-700-750	10,96	110T300 □□□ *
455	155	400	112,5	200-250-300-400-500-600-700-750	12,00	110T400 □□□ *
555	155	500	112,5	200-250-300-400-500-600-700-750	13,04	110T500 □□□ *
655	155	600	112,5	200-250-300-400-500-600-700-750	14,08	110T600 □□□ *
C+55	155	...	112,5	200-250-300-400-500-600-700-750		110T □□□□□ **

\*Complete the code by inserting the value of the radius (R): Ex. 110T200 □□□□

\*\*Complete the code by inserting the value of the quote C and the radius (R): Ex. 110T□□□□□□□□

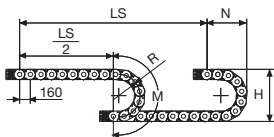
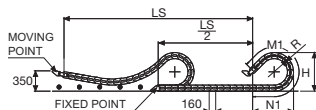

Length of chain (L)

Half travel distance ( $\frac{LS}{2}$ )

plus length of curve (M) or (M1)

$$L = \frac{LS}{2} + M \text{ or } M1$$

R	H	N	M	N1	M1
mm	mm	mm	mm	mm	mm
200	557	418	950	855	1820
250	657	468	1110	1095	2375
300	757	518	1265	1335	2935
400	957	618	1580	1805	4045
500	1157	718	1895	2280	5160
600	1357	818	2205	2750	6270
700	1557	918	2520	3225	7385
750	1657	968	2680	3460	7940

### Self-Supporting Capacity Diagram

The maximum length of the self-supporting capacity or in admissible sagging ( $\frac{LS}{2}$ ) in relationship to the weight of the cables and hoses contained per linear metre.

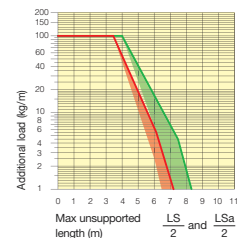
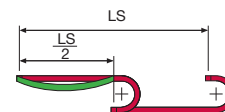

Fig. A Chain fixed outside/inside the radius. (Fig A) See mounting options page 31



\*If the chain is in the **ADMISSIBLE SAGGING** area (between GREEN and RED area) version with frames on every link is necessary.

The area in the diagram considers the difference of weight between various widths of chain with nylon frame every second link.

Red for self-supporting chain, green for chain in admissible sagging.

For applications with ( $\frac{LS}{2}$ ) and weights not included in the diagram of self-supporting capacity, verify the possible use of support rollers (see page 30).

### Bright Zinc Plated Steel End Bracket\*\*\*

The end brackets set allows the two ends of the chain to be attached to the equipment. Set complete with tiewrap clamps available on request.

### Bright Zinc Plated Steel Type

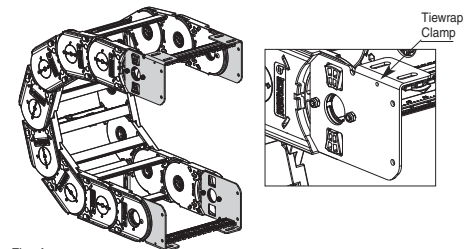
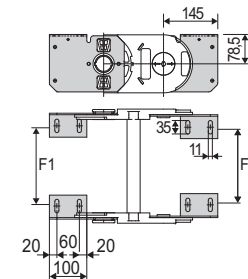

Fig. A Chain fixed outside/inside the radius. (Fig A) See mounting options page 31



Chain Type	F1 mm
110T200	170
110T300	270
110T400	370
110T500	470
110T600	570
Special widths	F=C-30

Catena Tipo	F2 mm
110T200	162
110T300	262
110T400	362
110T500	462
110T600	562
Special widths	F=C-38

### Bright Zinc Plated Steel Type Part Number

Complete Set assembled Chain Type	End Brackets Set	Part Number
110T...	A110T□□□KM□□	Assembled SFCT110□□□*MKM Unassembled SFCT110□□□*FK
Complete Set Unassembled Chain Type	End Brackets Set	Part Number
110T...	A110T□□□K□□	Assembled SFCT110□□□*MKM Unassembled SFCT110□□□*MK

\*\* 1= Pos.1; 2= Pos.2; 3= Pos.3  
\*\*\* On request stainless steel

### Tiewrap Clamp kit mounted on female attachment

Complete Set assembled Chain Type	End Brackets Set	Part Number
110T...	A110T□□□KM□□	Assembled SFCT110□□□*MKM Unassembled SFCT110□□□*FK
Complete Set Unassembled Chain Type	End Brackets Set	Part Number
110T...	A110T□□□K□□	Assembled SFCT110□□□*MKM Unassembled SFCT110□□□*MK

\*\* Inner width (C)

## H110B Nylon chain with aluminium draw plates



**H110B**  
On request can be supplied with rods made of stainless steel or bright zinc plated steel.

### How to release the pin junction

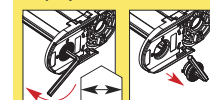

CH.10 mm

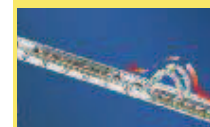

Suitable to long travel distance with covers on all the pitches.

For further informations please consult Brevetti Stendalto's Technical Office

## 306SU

### Nylon Cable Chain with opening frames

#### Inner height (D) 37 mm

Strong double share Sideband & Frame construction with large anti-friction triple-pin. Frames opening from inner and outer radius.

As standard the chain comes with frames every second link, on request with frames every link.

Vertical and horizontal modular separator system is available.

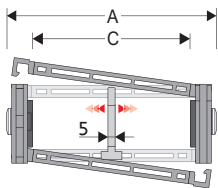

Separator	
- Unassembled	Part.no S306SM
- Assembled*	Part.no S306SMMC
Strong-hold separator	
for C > 250 mm	
- Unassembled	Part.no S660AH
- Assembled*	Part.no S660AHMCI
- Assembled**	Part.no S660AHMCE
<b>Pin</b>	Part.no PG307

\* for chain opening outer radius  
\*\* for chain opening inner radius

#### Technical characteristics when self-supported

Speed	4 m/s
Acceleration	10 m/s <sup>2</sup>

For higher requirements please consult our technical dept.

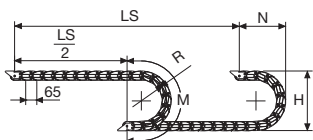

Length of chain (L)

Half travel distance ( $\frac{LS}{2}$ )

plus length of curve (M)

$$L = \frac{LS}{2} + M$$

R	H	N	M
mm	mm	mm	mm
075	208	170	370
107	272	205	470
150	358	245	605
200	458	295	760
250	558	345	920
300	658	395	1075

A	B	C	D	R	Weight/m	Chain
mm	mm	mm	mm	mm	kg	Part Number
79	55	43	37	075-107-150-200-250-300	1,61	306SU043 □□□ *
90	55	54	37	075-107-150-200-250-300	1,61	306SU054 □□□ *
104	55	68	37	075-107-150-200-250-300	1,68	306SU068 □□□ *
110	55	74	37	075-107-150-200-250-300	1,70	306SU074 □□□ *
114	55	78	37	075-107-150-200-250-300	1,72	306SU078 □□□ *
124	55	88	37	075-107-150-200-250-300	1,74	306SU088 □□□ *
129	55	93	37	075-107-150-200-250-300	1,74	306SU093 □□□ *
136	55	100	37	075-107-150-200-250-300	1,76	306SU100 □□□ *
146	55	110	37	075-107-150-200-250-300	1,77	306SU110 □□□ *
154	55	118	37	075-107-150-200-250-300	1,82	306SU118 □□□ *
165	55	129	37	075-107-150-200-250-300	1,85	306SU129 □□□ *
179	55	143	37	075-107-150-200-250-300	1,89	306SU143 □□□ *
204	55	168	37	075-107-150-200-250-300	1,96	306SU168 □□□ *
229	55	193	37	075-107-150-200-250-300	2,04	306SU193 □□□ *
240	55	204	37	075-107-150-200-250-300	2,07	306SU204 □□□ *
254	55	218	37	075-107-150-200-250-300	2,11	306SU218 □□□ *
281	55	245	37	075-107-150-200-250-300	2,19	306SU245 □□□ *
290	55	254	37	075-107-150-200-250-300	2,22	306SU254 □□□ *
315	55	279	37	075-107-150-200-250-300	2,29	306SU279 □□□ *
341	55	305	37	075-107-150-200-250-300	2,34	306SU305 □□□ *
363	55	327	37	075-107-150-200-250-300	2,41	306SU327 □□□ *
391	55	355	37	075-107-150-200-250-300	2,49	306SU355 □□□ *

\*Complete the code by inserting the value of the radius (R): Ex. 306SU110 [7] [5] [0]

Chain equipped with nylon frame every pitch: complete the code by inserting the letter D.  
Ex. 306SU110150 [D]



Version with frames mounted on every pitch.

#### Self-Supporting Capacity Diagram

The maximum length of the self-supporting capacity ( $\frac{LS}{2}$ ) in relationship to the weight of the cables and hoses contained per linear metre.

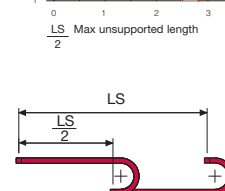
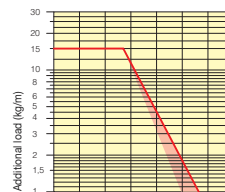

The red marking in the diagram area considers the difference of weight between various widths of chains assembled with nylon frames every second pitch.

For applications with  $\frac{LS}{2}$  and weights not included in the area of the diagram showing self-supporting capacity, verify the possible use of support rollers (see page 30).

#### End Brackets

The end brackets set allows the two ends of the chain to be attached to the equipment. Set complete with tiwrap clamps available on request.

#### Nylon Type

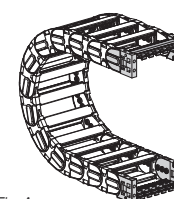

Fig. A The chain can be fixed frontally, inner or outer radius. (Fig A)

#### Nylon Type

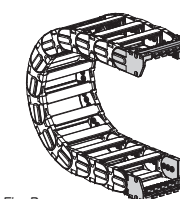
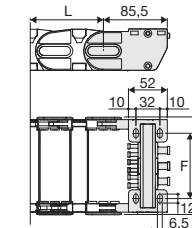
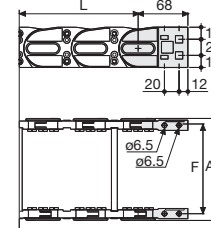

Fig. B Chain fixed outside the radius. (Fig B) See end brackets mounting variations page 31.



Chain Type	F mm
306SU043	61
306SU054	72
306SU068	86
306SU074	92
306SU078	96
306SU098	106
306SU093	111
306SU100	118
306SU110	128
306SU118	136
306SU129	147
306SU143	161
306SU168	186
306SU193	211
306SU204	222
306SU218	236
306SU245	263
306SU254	272
306SU279	297
306SU305	323
306SU327	345
306SU355	373

Chain Type	F mm
306SU043	36
306SU054	47
306SU068	61
306SU074	67
306SU078	71
306SU098	81
306SU093	86
306SU100	93
306SU110	103
306SU118	111
306SU129	122
306SU143	136
306SU168	161
306SU193	186
306SU204	197
306SU218	211
306SU245	238
306SU254	247
306SU279	272
306SU305	298
306SU327	320
306SU355	348

#### Nylon Type Part Numbers

Complete Set Assembled	End Brackets
Chain	Set
306SU...	AN306KM

Complete Set Unassembled	End Brackets
Chain	Set
306SU...	AN306K
Tiewrap Clamp	
Assembl. CFC306S □□□ *KM	Unassembl. CFC306S □□□ *K

#### Nylon Type Part Numbers

Complete Set Assembled	End Brackets
Chain	Set
306SU...	ANL306KM □**

Complete Set Unassembled	End Brackets
Chain	Set
306SU...	ANL306K □**
Tiewrap Clamp	
Assembl. SFCTL306 □□□ *KM	Unassembl. SFCTL306S □□□ *K

\* Inner width (C)  
\*\* 1=Pos.1; 2=Pos.2; 3=Pos.3  
\*\*\* Available on request in stainless steel

## 306SU Nylon Cable Chain with opening frames



Separation System To choose the separators see page. 196

#### Bright Zinc Plated Steel Type\*\*\*

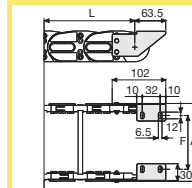
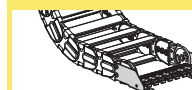

$$F = A - 43$$

#### Bright Zinc Plated Steel Type Part Numbers

Complete Set Assembled	End Brackets
Chain	Set
306SU...	A306SKM □**

Complete Set Unassembled	End Brackets
Chain	Set
306SU...	A306SK □**
Tiewrap Clamp	
Assembl. SFCT306S □□□ *KM	Unassembl. SFCT306S □□□ *K

\* Inner width (C)  
\*\* 1=Pos.1; 2=Pos.2; 3=Pos.3  
\*\*\* Available on request in stainless steel

## 306B Nylon Cable Chain with un-screwable aluminium rods

### Inner height (D) 30 mm

Strong double share Sideband & Frame construction with large anti-friction triple-pin. Alu-rod frames are un-screwable from inner and outer radius. As standard the chain comes with frames every second link, on request with frames every link. Vertical and horizontal separator systems are available.

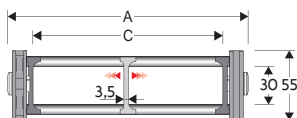

Separator	
- Unassembled	Part.no S2000F
- Assembled	Part.no S2000FMC
Pin	
	Part.no PG307

### Technical characteristics when self-supported

Speed	4 m/s
Acceleration	10 m/s <sup>2</sup>

For higher requirements please consult our technical dept.

A	B	C	D	R	Weight/m	Chain
mm	mm	mm	mm	mm	kg	Part Number
115	55	75	30	075-107-150-200-250-300	1,60	306B075 □ *
140	55	100	30	075-107-150-200-250-300	1,65	306B100 □ *
190	55	150	30	075-107-150-200-250-300	1,80	306B150 □ *
240	55	200	30	075-107-150-200-250-300	1,90	306B200 □ *
290	55	250	30	075-107-150-200-250-300	2,00	306B250 □ *
340	55	300	30	075-107-150-200-250-300	2,15	306B300 □ *
C+40	55	.....	30	075-107-150-200-250-300		306B □ □ □ □ **

\*Complete the code by inserting the value of the radius (R): Ex. 306B075 □

Where: 1=075; 2=107; 3=150; 4=200; 5=250; 6=300.

\*\*Complete the code by inserting the value of the quote C and the radius (R): Ex. 306B □ □ □ □ □

Chain equipped with aluminium rods every pitch: complete the code by inserting the letter D.

Ex. 306B0751 □

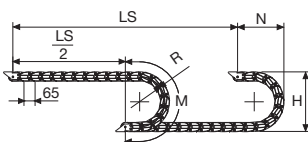

Length of chain (L)

Half travel distance ( $\frac{LS}{2}$ )

plus length of curve (M)

$$L = \frac{LS}{2} + M$$

R	H	N	M
mm	mm	mm	mm
075	208	170	370
107	272	205	470
150	358	245	605
200	458	295	760
250	558	345	920
300	658	395	1075

### Self-Supporting Capacity Diagram

The maximum length of the self-supporting capacity ( $\frac{LS}{2}$ ) in relationship to the weight of the cables and hoses contained per linear metre.

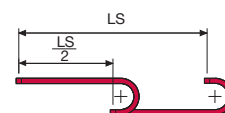
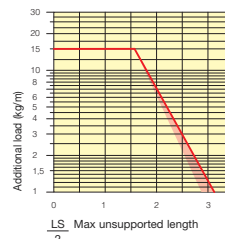

The red marking in the diagram area considers the difference of weight between various widths of chains assembled with rods every second pitch.

For applications with  $\frac{LS}{2}$  and weights not included in the area of the diagram showing self-supporting capacity, verify the possible use of support rollers (see page 30).

### End Brackets

The end brackets set allows the two ends of the chain to be attached to the equipment. Set complete with tiewrap clamps available on request.

#### Nylon Type

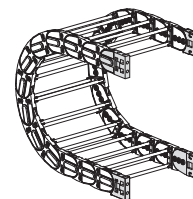

Fig. A The chain can be fixed frontally, inner or outer radius. (Fig A)

#### Nylon Type

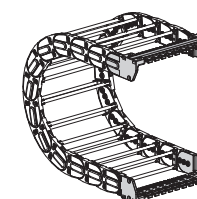
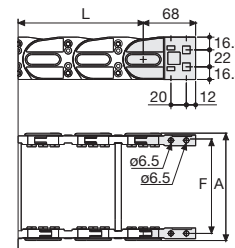
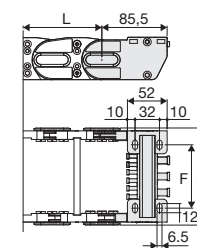

Fig. B Chain fixed outside the radius. (Fig B) See end brackets mounting variations page 31.



Chain Type	F mm
306B075	96
306B100	121
306B150	171
306B200	221
306B250	271
306B300	321

Special widths F=A-19



Chain Type	F mm
306B075	71
306B100	96
306B150	146
306B200	196
306B250	246
306B300	296

Special widths F=A-44

### Nylon Type Part Numbers

Complete Set Assembled	
Chain	End Brackets
Type	Set
306B...	AN306KM
Complete Set Unassembled	
Chain	End Brackets
Type	Set
306B...	AN306K

### Nylon Type Part Numbers

Complete Set Assembled	
Chain	End Brackets
Type	Set
306B...	ANL306KM □ □ *
Complete Set Unassembled	
Chain	End Brackets
Type	Set
306B...	ANL306K □ □ *

Tiewrap Clamp	
Assembl.	SFCTL306 □ □ □ □ *KM
Unassembl.	SFCTL306B □ □ □ □ *K

## 306B Nylon Cable Chain with un-screwable aluminium rods

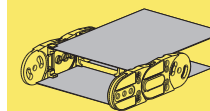

Steel laminar cover.

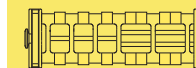

Supplementary movable separators.

### Bright Zinc Plated Steel Type\*\*\*

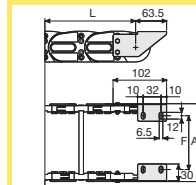
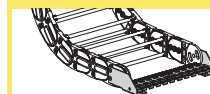

F = A-44

### Bright Zinc Plated Steel Type Part Numbers

Complete Set Assembled	
Chain	End Brackets
Type	Set
306B...	A306KM □ □ **
Complete Set Unassembled	
Chain	End Brackets
Type	Set
306B...	A306K □ □ **

\* Inner width (C)  
\*\* 1=Pos.1; 2=Pos.2; 3=Pos.3  
\*\*\* Available on request in stainless steel



Version with Alu-rods on every second pitch.



## 307SU

### Nylon Cable Chain with opening frames

#### Inner height (D) 47 mm

Strong double share Sideband & Frame construction with large anti-friction triple-pin. Frames opening from inner and outer radius.

As standard the chain comes with frames every second link, on request with frames every link.

Vertical and horizontal modular separator system is available.

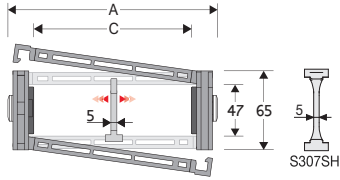

Separator	
- Unassembled	Part.no S307S
- Assembled*	Part.no S307SMCI
- Assembled**	Part.no S307SMCE
Strong-hold separator	
for C > 250 mm	
- Unassembled	Part.no S307SH
- Assembled*	Part.no S307SHMCI
- Assembled**	Part.no S307SHMCE
- Pin	Part.no PG307

\* for chain opening outer radius  
\*\* for chain opening inner radius

#### Technical characteristics when self-supported

Speed	8 m/s
Acceleration	40 m/s <sup>2</sup>

For higher requirements please consult our technical dept.

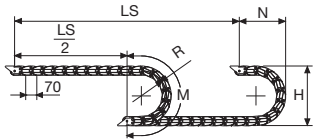

Length of chain (L)

Half travel distance ( $\frac{LS}{2}$ )

plus length of curve (M)

$$L = \frac{LS}{2} + M$$

R	H	N	M
mm	mm	mm	mm
075	219	180	375
090	249	195	425
120	309	225	520
140	349	245	580
200	469	305	770
250	569	355	925

A	B	C	D	R	Weight/m	Chain
mm	mm	mm	mm	mm	kg	Part Number
80	65	42	47	075-090-120-140-200-250	1,86	307SU042 □□□ *
91	65	53	47	075-090-120-140-200-250	1,86	307SU053 □□□ *
105	65	67	47	075-090-120-140-200-250	1,92	307SU067 □□□ *
111	65	73	47	075-090-120-140-200-250	1,94	307SU073 □□□ *
115	65	77	47	075-090-120-140-200-250	1,96	307SU077 □□□ *
125	65	87	47	075-090-120-140-200-250	1,97	307SU087 □□□ *
130	65	92	47	075-090-120-140-200-250	1,97	307SU092 □□□ *
137	65	99	47	075-090-120-140-200-250	1,99	307SU099 □□□ *
147	65	109	47	075-090-120-140-200-250	2,00	307SU109 □□□ *
155	65	117	47	075-090-120-140-200-250	2,05	307SU117 □□□ *
166	65	128	47	075-090-120-140-200-250	2,07	307SU128 □□□ *
180	65	142	47	075-090-120-140-200-250	2,10	307SU142 □□□ *
205	65	167	47	075-090-120-140-200-250	2,16	307SU167 □□□ *
230	65	192	47	075-090-120-140-200-250	2,23	307SU192 □□□ *
241	65	203	47	075-090-120-140-200-250	2,26	307SU203 □□□ *
255	65	217	47	075-090-120-140-200-250	2,30	307SU217 □□□ *
282	65	244	47	075-090-120-140-200-250	2,37	307SU244 □□□ *
291	65	253	47	075-090-120-140-200-250	2,39	307SU253 □□□ *
316	65	278	47	075-090-120-140-200-250	2,47	307SU278 □□□ *
342	65	304	47	075-090-120-140-200-250	2,50	307SU304 □□□ *
364	65	326	47	075-090-120-140-200-250	2,56	307SU326 □□□ *
392	65	354	47	075-090-120-140-200-250	2,63	307SU354 □□□ *

\*Complete the code by inserting the value of the radius (R): Ex. 307SU117 □ □ □ □ □

Chain equipped with nylon frame every pitch: complete the code by inserting the letter D.  
Ex. 307SU117140 □ □ □ □ □



Version with frames mounted on every pitch.

#### Self-Supporting Capacity Diagram

The maximum length of the self-supporting capacity ( $L_{S2}$ ) in relationship to the weight of the cables and hoses contained per linear metre.

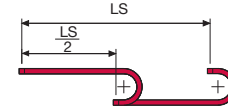
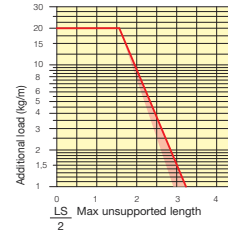

The red marking in the diagram area considers the difference of weight between various widths of chains assembled with nylon frames every second pitch.

For applications with  $\frac{LS}{2}$  and weights not included in the area of the diagram showing self-supporting capacity, verify the possible use of support rollers (see page 30).

#### End Brackets

The end brackets set allows the two ends of the chain to be attached to the equipment. Set complete with tiewrap clamps available on request.

##### Nylon Type

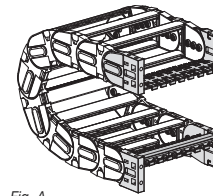

Fig. A  
The chain can be fixed frontally, inner or outer radius. (Fig A)

##### Bright Zinc Plated Steel Type\*\*\*

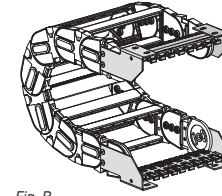
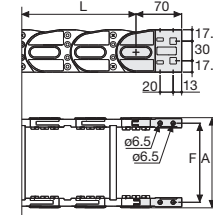

Fig. B  
Chain fixed outside the radius. (Fig B)  
See end brackets mounting variations page 31.



Chain Type	F mm
307SU042	61
307SU053	72
307SU067	86
307SU073	92
307SU077	96
307SU087	106
307SU092	111
307SU099	118
307SU109	128
307SU117	136
307SU128	147
307SU142	161
307SU167	186
307SU192	211
307SU203	222
307SU217	236
307SU244	263
307SU253	272
307SU278	297
307SU304	323
307SU326	345
307SU354	373

#### Nylon Type Part Numbers

Complete Set Assembled	Chain	End Brackets
Type	Set	Set
307SU...	AN307KM	

Complete Set Unassembled	Chain	End Brackets
Type	Set	Set
307SU...	AN307K	

Tiewrap Clamp	Assembl.	CFC307S	□□□ *KM
Unassembl.	CFC307S	□□□ *K	

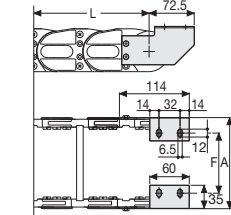

Chain Type	F mm
307SU042	31
307SU053	42
307SU067	56
307SU073	62
307SU077	66
307SU087	76
307SU092	81
307SU099	88
307SU109	98
307SU117	106
307SU128	117
307SU142	131
307SU167	156
307SU192	181
307SU203	192
307SU217	206
307SU244	233
307SU253	242
307SU278	267
307SU304	293
307SU326	315
307SU354	343

#### Bright Zinc Plated Steel Type Part Numbers

Complete Set Assembled	Chain	End Brackets
Type	Set	Set
307SU...	A307SKM □□*	

Complete Set Unassembled	Chain	End Brackets
Type	Set	Set
307SU...	A307SK □□*	

Tiewrap Clamp	Assembl.	SFCT307S	□□□ *KM
Unassembl.	SFCT307S	□□□ *K	

\* Inner width (C)  
\*\* 1=Pos.1; 2=Pos.2; 3=Pos.3  
\*\*\* Available on request in stainless steel

## 307SU Nylon Cable Chain with opening frames

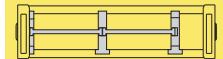

Separation System  
To choose the separators see page 196.

#### How to open the cover.

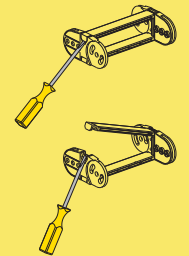

Special tool to remove the connecting pivots:  
Part Number PZ036.



For further information please consult Brevetti Stendalto's Technical Office

## 307B Nylon Cable Chain with un-screwable aluminium rods

### Inner height (D) 40 mm

Strong double share Sideband & Frame construction with large anti-friction triple-pin. Alu-rod frames are un-screwable from inner and outer radius. As standard the chain comes with frames every second link, on request with frames every link. Vertical and horizontal separator systems are available.

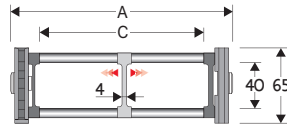

Separator	
- Unassembled	Part.no S307
- Assembled	Part.no S307MC
Pin	
	Part.no PG307

### Technical characteristics when self-supported

Speed	8 m/s
Acceleration	40 m/s <sup>2</sup>

For higher requirements please consult our technical dept.

A	B	C	D	R	Weight/m	Chain
mm	mm	mm	mm	mm	kg	Part Number
117	65	75	40	075-090-120-140-200-250	1,80	307B075 □ *
142	65	100	40	075-090-120-140-200-250	1,85	307B100 □ *
192	65	150	40	075-090-120-140-200-250	1,95	307B150 □ *
242	65	200	40	075-090-120-140-200-250	2,05	307B200 □ *
292	65	250	40	075-090-120-140-200-250	2,15	307B250 □ *
342	65	300	40	075-090-120-140-200-250	2,25	307B300 □ *
C+42	65	.....	40	075-090-120-140-200-250		307B □ □ □ □ **

\*Complete the code by inserting the value of the radius (R): Ex. 307B075 □

Where: 0=090; 1=120; 2=140; 3=200; 4=250; 7=075

\*\*Complete the code by inserting the value of the quote C and the radius (R): Ex. 307B □ □ □ □ □

Chain equipped with aluminium rods every pitch: complete the code by inserting the letter D.

Ex. 307B0751 □

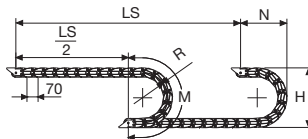

Length of chain (L)  
Half travel distance ( $\frac{LS}{2}$ )  
plus length of curve (M)

$$L = \frac{LS}{2} + M$$

R	H	N	M
mm	mm	mm	mm
075	219	180	375
090	249	195	425
120	309	225	520
140	349	245	580
200	469	305	770
250	569	355	925

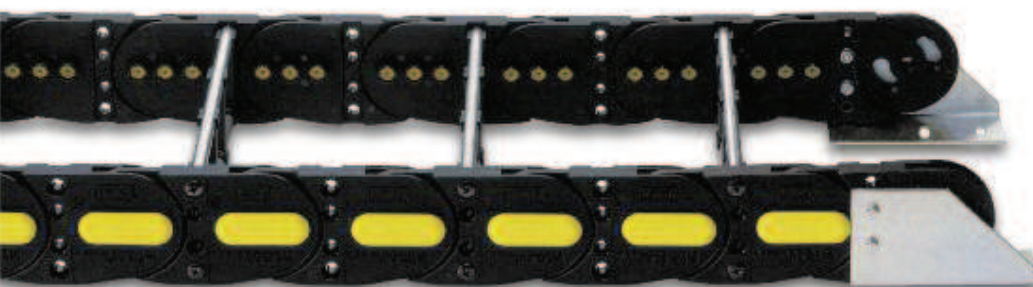

Version with Alu-rods on every second pitch.

### Self-Supporting Capacity Diagram

The maximum length of the self-supporting capacity ( $\frac{LS}{2}$ ) in relationship to the weight of the cables and hoses contained per linear metre.

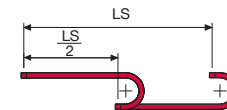
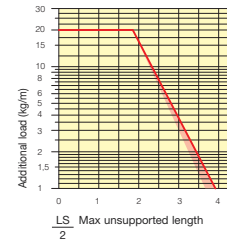

The red marking in the diagram area considers the difference of weight between various widths of chains assembled with rods every second pitch.

For applications with  $\frac{LS}{2}$  and weights not included in the area of the diagram showing self-supporting capacity, verify the possible use of support rollers (see page 30).

### End Brackets

The end brackets set allows the two ends of the chain to be attached to the equipment. Set complete with tiewrap clamps available on request.

#### Nylon Type

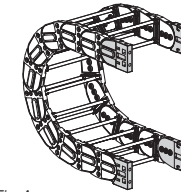

Fig. A  
The chain can be fixed frontally, inner or outer radius. (Fig A)

#### Bright Zinc Plated Steel Type\*\*\*

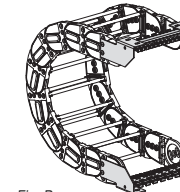
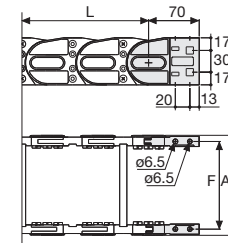
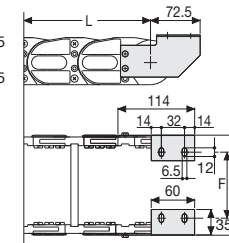

Fig. B  
Chain fixed outside the radius. (Fig B)  
See end brackets mounting variations page 31.



Chain Type	F mm
307B075	98
307B100	123
307B150	173
307B200	223
307B250	273
307B300	323

Special widths F=A-19



Chain Type	F mm
307B075	68
307B100	93
307B150	143
307B200	193
307B250	243
307B300	293

Special widths F=A-49

### Nylon Type Part Numbers

Complete Set	Assembled Chain	End Brackets
Type	Set	
307B...	AN307KM	

Complete Set	Unassembled Chain	End Brackets
Type	Set	
307B...	AN307K	

### Bright Zinc Plated Steel Type Part Numbers

Complete Set	Assembled Chain	End Brackets
Type	Set	
307B...	A307KM □ □ □ □	

Complete Set	Unassembled Chain	End Brackets
Type	Set	
307B...	A307K □ □ □ □	

#### Tiewrap Clamp

Assembl. SFCT307B □ □ □ □ \*KM  
Unassembl. SFCT307B □ □ □ □ \*K

\* Inner width (C)

\*\* 1=Pos.1; 2=Pos.2; 3=Pos.3

\*\*\* Available on request in stainless steel

## 307B Nylon Cable Chain with un-screwable aluminium rods



Supplementary movable separators.

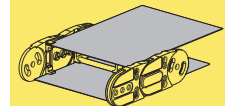

Steel laminar cover.

Special tool to remove the connecting pivots:  
Part Number PZ036.



For further information please consult Brevetti Stendalto's Technical Office

## 307E Nylon Cable Chain with alu-drawn frames

### Inner height (D) 46,5 mm

Strong side-bands chain with dovetailed links and triple low friction pins. Alu-drawn frames mounted each second pitch full-pitch frames version available on demand. Special C size available on demand. Vertical and horizontal separator systems are available.

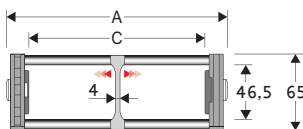

Separator	
- Unassembled	Part.no S307EF
- Assembled	Part.no S307EFMC
Pin	
	Part.no PG307

### Technical characteristics when self-supported

Speed	8 m/s
Acceleration	40 m/s <sup>2</sup>

For higher requirements please consult our technical dept.

A	B	C	D	R	Weight/m	Chain
mm	mm	mm	mm	mm	kg	Part Number
113	65	75	46,5	075-090-120-140-170-200-250	1,95	307E075□□□*
138	65	100	46,5	075-090-120-140-170-200-250	2,00	307E100□□□*
188	65	150	46,5	075-090-120-140-170-200-250	2,15	307E150□□□*
238	65	200	46,5	075-090-120-140-170-200-250	2,25	307E200□□□*
288	65	250	46,5	075-090-120-140-170-200-250	2,35	307E250□□□*
338	65	300	46,5	075-090-120-140-170-200-250	2,50	307E300□□□*
C+38	65	.....	46,5	075-090-120-140-170-200-250		307E□□□□□**

\*Complete the code by inserting the value of the radius (R): Ex. 307E075□1□2□

\*\*Complete the code by inserting the value of the quote C and the radius (R): Ex. 307E□1□2□3□1□2□

Chain equipped with alu-drawn frames full-pitch: complete the code by inserting the letter D.

Ex. 307E075120□

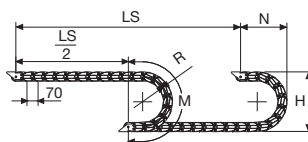

Length of chain (L)  
Half travel distance ( $\frac{LS}{2}$ )  
plus length of curve (M)

$$L = \frac{LS}{2} + M$$

R	H	N	M
mm	mm	mm	mm
075	219	180	380
090	249	195	425
120	309	225	520
140	349	245	580
170	409	275	675
200	469	305	770
250	569	355	930

### Self-Supporting Capacity Diagram

The maximum length of the self-supporting capacity ( $\frac{LS}{2}$ ) in relationship to the weight of the cables and hoses contained per linear metre.

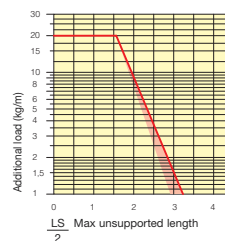

### End Brackets

The end brackets set allows the two ends of the chain to be attached to the equipment. Set complete with tiewrap clamps available on request.

#### Nylon Type

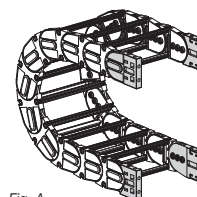

Fig. A  
The chain can be fixed frontally, inner or outer radius. (Fig A)

#### Bright Zinc Plated Steel Type\*\*\*

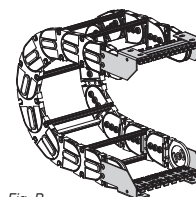
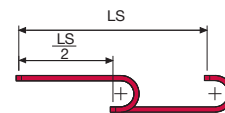
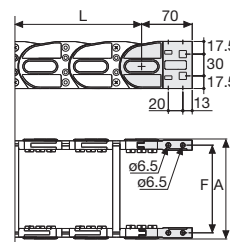

Fig. B  
Chain fixed outside the radius. (Fig B)  
See end brackets mounting variations page 31.



The red marking in the diagram area considers the difference of weight between various widths of chains assembled with alu-drawn frames every second pitch.

For applications with  $\frac{LS}{2}$  and weights not included in the area of the diagram showing self-supporting capacity, verify the possible use of support rollers (see page 30).



Chain Type	F mm
307E075	94
307E100	119
307E150	169
307E200	219
307E250	269
307E300	319

Special widths F=A-19

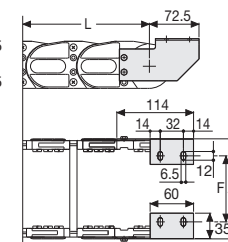

Chain Type	F mm
307E075	64
307E100	89
307E150	139
307E200	189
307E250	239
307E300	289

Special widths F=A-49

### Nylon Type Part Numbers

Complete Set Assembled Chain Type	End Brackets Set
307E...	AN307KM

Complete Set Unassembled Chain Type	End Brackets Set
307E...	AN307K

### Bright Zinc Plated Steel Type Part Numbers

Complete Set Assembled Chain Type	End Brackets Set
307E...	A307EKM□**

Complete Set Unassembled Chain Type	End Brackets Set
307E...	A307EK□**

**Tiewrap Clamp**  
Assembl. SFCT307E□□□\*KM  
Unassembl. SFCT307E□□□\*K

\* Inner width (C)  
\*\* 1=Pos.1; 2=Pos.2; 3=Pos.3  
\*\*\* Available on request in stainless steel

## 307E Nylon Cable Chain with alu-drawn frames



How to open alu-drawn frames

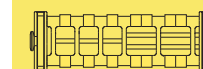

Supplementary movable separators.

Special tool to remove the connecting pivots: Part Number PZ036.



For further information please consult Brevetti Stendalto's Technical Office

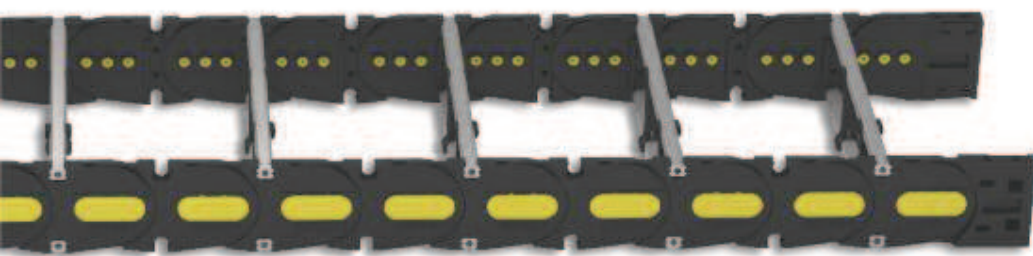

Version alu-drawn frames mounted every second pitch.



## Nylon Cable Chain with opening frames

### Inner height (D) 57 mm

Strong double share Sideband & Frame construction with large anti-friction triple-pin. Frames opening from inner and outer radius. As standard the chain comes with frames every second link, on request with frames every link. Vertical and horizontal modular separator system is available.

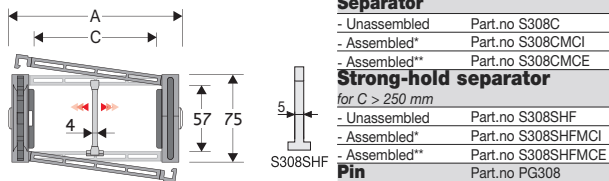

Separator	
- Unassembled	Part.no S308C
- Assembled*	Part.no S308CMCI
- Assembled**	Part.no S308CMCE
Strong-hold separator	
for C > 250 mm	
- Unassembled	Part.no S308SHF
- Assembled*	Part.no S308SHFMCJ
- Assembled**	Part.no S308SHFMCE
Pin	
	Part.no PG308

\* for chain opening outer radius  
\*\* for chain opening inner radius

### Technical characteristics when self-supported

Speed	8 m/s
Acceleration	40 m/s <sup>2</sup>

For higher requirements please consult our technical dept.

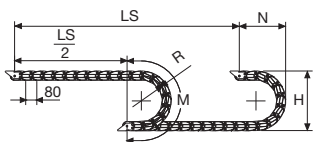

Length of chain (L)

Half travel distance ( $\frac{LS}{2}$ )

plus length of curve (M)

$$L = \frac{LS}{2} + M$$

R	H	N	M
mm	mm	mm	mm
135	345	255	585
150	375	270	635
180	435	300	725
200	475	320	790
230	535	350	885
280	635	400	1040
300	675	420	1105
400	875	520	1420
600	1175	720	2045

A	B	C	D	R	Weight/m	Chain
mm	mm	mm	mm	mm	kg	Part Number
82	75	38	57	135-150-180-200-230-280-300-400-600	2,46	308SU038 □□□*
93	75	49	57	135-150-180-200-230-280-300-400-600	2,46	308SU049 □□□*
107	75	63	57	135-150-180-200-230-280-300-400-600	2,51	308SU063 □□□*
113	75	69	57	135-150-180-200-230-280-300-400-600	2,53	308SU069 □□□*
117	75	73	57	135-150-180-200-230-280-300-400-600	2,54	308SU073 □□□*
127	75	83	57	135-150-180-200-230-280-300-400-600	2,56	308SU083 □□□*
132	75	88	57	135-150-180-200-230-280-300-400-600	2,56	308SU086 □□□*
139	75	95	57	135-150-180-200-230-280-300-400-600	2,58	308SU095 □□□*
149	75	105	57	135-150-180-200-230-280-300-400-600	2,59	308SU105 □□□*
157	75	113	57	135-150-180-200-230-280-300-400-600	2,62	308SU113 □□□*
168	75	124	57	135-150-180-200-230-280-300-400-600	2,65	308SU124 □□□*
182	75	138	57	135-150-180-200-230-280-300-400-600	2,67	308SU138 □□□*
207	75	163	57	135-150-180-200-230-280-300-400-600	2,73	308SU163 □□□*
232	75	188	57	135-150-180-200-230-280-300-400-600	2,79	308SU188 □□□*
243	75	199	57	135-150-180-200-230-280-300-400-600	2,81	308SU199 □□□*
257	75	213	57	135-150-180-200-230-280-300-400-600	2,84	308SU213 □□□*
284	75	240	57	135-150-180-200-230-280-300-400-600	2,90	308SU240 □□□*
293	75	249	57	135-150-180-200-230-280-300-400-600	2,92	308SU249 □□□*
318	75	274	57	135-150-180-200-230-280-300-400-600	2,99	308SU274 □□□*
344	75	300	57	135-150-180-200-230-280-300-400-600	3,02	308SU300 □□□*
366	75	322	57	135-150-180-200-230-280-300-400-600	3,07	308SU322 □□□*
394	75	350	57	135-150-180-200-230-280-300-400-600	3,13	308SU350 □□□*

\*Complete the code by inserting the value of the radius (R): Ex. 308SU105 □□□□□

Chain equipped with nylon frame every pitch: complete the code by inserting the letter D.  
Ex. 308SU105150 □□

### Self-Supporting Capacity Diagram

The maximum length of the self-supporting capacity ( $\frac{LS}{2}$ ) in relationship to the weight of the cables and hoses contained per linear metre.

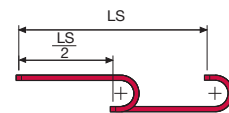
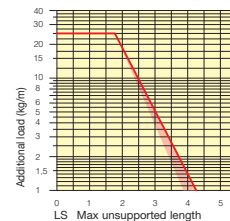

The red marking in the diagram area considers the difference of weight between various widths of chains assembled with nylon frames every second pitch.

For applications with  $\frac{LS}{2}$  and weights not included in the area of the diagram showing self-supporting capacity, verify the possible use of support rollers (see page 30).

### End Brackets

The end brackets set allows the two ends of the chain to be attached to the equipment. Set complete with tiewrap clamps available on request.

#### Nylon Type

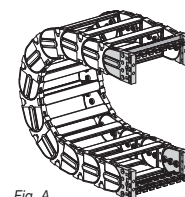
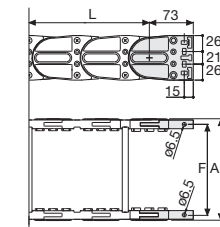

Fig. A The chain can be fixed frontally, inner or outer radius. (Fig A)



Chain Type	F mm
308SU038	62
308SU049	73
308SU063	87
308SU069	93
308SU073	97
308SU083	107
308SU088	112
308SU095	119
308SU105	129
308SU113	137
308SU124	148
308SU138	162
308SU163	187
308SU188	212
308SU199	223
308SU213	237
308SU240	264
308SU249	273
308SU274	298
308SU300	324
308SU322	346
308SU350	374

#### Nylon Type Part Numbers

Chain Type	End Brackets Set
308SU...	AN308SKM

Chain Type	End Brackets Set
308SU...	AN308SK

Tiewrap Clamp	
Assembl.	CFC308S □□□*KM
Unassembl.	CFC308S □□□*K

#### Bright Zinc Plated Steel Type\*\*\*

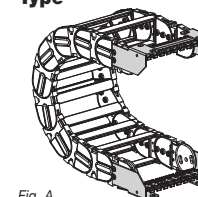
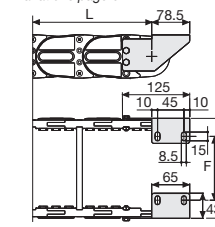

Fig. A Chain fixed outside the radius. (Fig A) See end brackets mounting variations page 31.



Chain Type	F mm
308SU038	-
308SU049	31
308SU063	45
308SU069	51
308SU073	55
308SU083	65
308SU088	70
308SU095	77
308SU105	87
308SU113	95
308SU124	106
308SU138	120
308SU163	145
308SU188	170
308SU199	181
308SU213	195
308SU240	222
308SU249	231
308SU274	256
308SU300	282
308SU322	304
308SU350	332

#### Bright Zinc Plated Steel Type Part Numbers

Chain Type	End Brackets Set
308SU...	A308SKM □□*

Chain Type	End Brackets Set
308SU...	A308SK □□*

Tiewrap Clamp	
Assembl.	SFCT308S □□□*KM
Unassembl.	SFCT308S □□□*K

\* Inner width (C)

\*\* 1=Pos.1; 2=Pos.2; 3=Pos.3

\*\*\* Available on request in stainless steel

## 308SU Nylon Cable Chain with opening frames



Separation System To choose the separators see page. 196

How to open the cover.

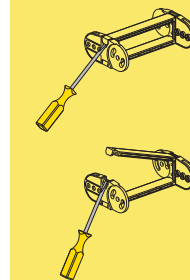

Protection version

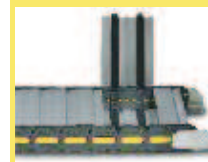

Protection version see page 144

For further information please consult Brevetti Stendaito's Technical Office







## Nylon Cable Chain with opening frames

**Inner height (D) 75,5 mm**  
Strong double share Sideband & Frame construction with large anti-friction triple-pin. Frames opening from inner and outer radius.  
As standard the chain comes with frames every second link, on request with frames every link.  
Vertical and horizontal modular separator system is available.

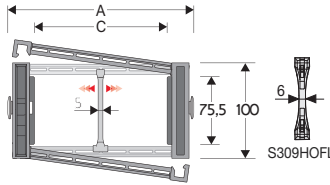

Separator	
- Unassembled	Part.no S309S/3178
- Assembled*	Part.no S309S/3178MCI
- Assembled**	Part.no S309S/3178MCE
Strong-hold separator	
for C > 250 mm	
- Unassembled	Part.no S309HOFL
- Assembled	Part.no S309HOFLMC
Pin	
- Assembled	Part.no PG309H

\* for chain opening outer radius  
\*\* for chain opening inner radius

### Technical characteristics when self-supported

Speed	8 m/s
Acceleration	40 m/s <sup>2</sup>

For higher requirements please consult our technical dept.

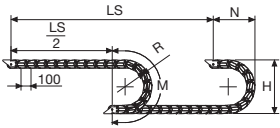

Length of chain (L)  
Half travel distance ( $\frac{LS}{2}$ )  
plus length of curve (M)

$$L = \frac{LS}{2} + M$$

A	B	C	D	R	Weight/m	Chain Part Number
mm	mm	mm	mm	mm	kg	
117	100	64	75,5	150-200-250-300-350-400-500-600	4,03	309SU064□□□*
137	100	84	75,5	150-200-250-300-350-400-500-600	4,09	309SU084□□□*
162	100	109	75,5	150-200-250-300-350-400-500-600	4,17	309SU109□□□*
169	100	116	75,5	150-200-250-300-350-400-500-600	4,20	309SU116□□□*
192	100	139	75,5	150-200-250-300-350-400-500-600	4,27	309SU139□□□*
232	100	179	75,5	150-200-250-300-350-400-500-600	4,40	309SU179□□□*
267	100	214	75,5	150-200-250-300-350-400-500-600	4,51	309SU214□□□*
293	100	240	75,5	150-200-250-300-350-400-500-600	4,60	309SU240□□□*
317	100	264	75,5	150-200-250-300-350-400-500-600	4,67	309SU264□□□*
343	100	290	75,5	150-200-250-300-350-400-500-600	4,75	309SU290□□□*
367	100	314	75,5	150-200-250-300-350-400-500-600	4,83	309SU314□□□*
393	100	340	75,5	150-200-250-300-350-400-500-600	4,90	309SU340□□□*
417	100	364	75,5	150-200-250-300-350-400-500-600	4,99	309SU364□□□*
472	100	419	75,5	150-200-250-300-350-400-500-600	5,20	309SU419□□□*
541	100	488	75,5	150-200-250-300-350-400-500-600	5,40	309SU488□□□*

\*Complete the code by inserting the value of the radius (R): Ex. 309SU116 □□□□□  
Chain equipped with nylon frame every pitch: complete the code by inserting the letter D.  
Ex. 309SU116250 □□

R	H	N	M
mm	mm	mm	mm
150	406	300	675
200	506	350	830
250	606	400	985
300	706	455	1145
350	806	500	1300
400	906	555	1460
500	1106	650	1770
600	1306	750	2085

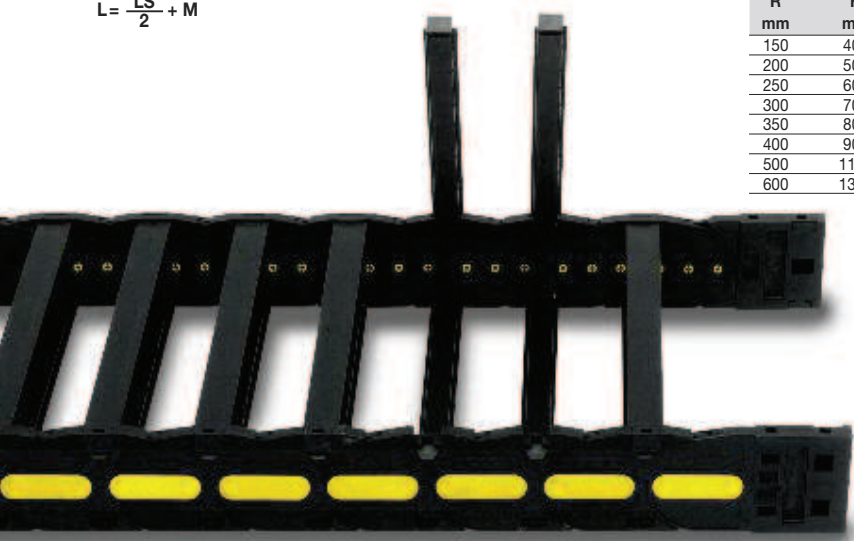

Version with frames mounted on every pitch.

### Self-Supporting Capacity Diagram

The maximum length of the self-supporting capacity ( $\frac{LS}{2}$ ) in relationship to the weight of the cables and hoses contained per linear metre.

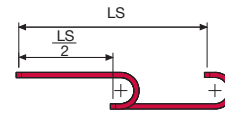
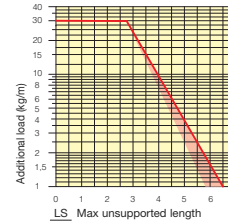

The red marking in the diagram area considers the difference of weight between various widths of chains assembled with nylon frames every second pitch.

For applications with  $\frac{LS}{2}$  and weights not included in the area of the diagram showing self-supporting capacity, verify the possible use of support rollers (see page 30).

### End Brackets

The end brackets set allows the two ends of the chain to be attached to the equipment. Set complete with tiewrap clamps available on request.

#### Nylon Type

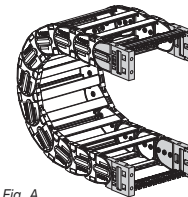

Fig. A  
The chain can be fixed frontally, inner or outer radius. (Fig A)

#### Bright Zinc Plated Steel Type\*\*\*

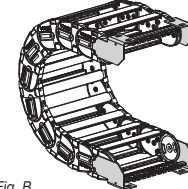
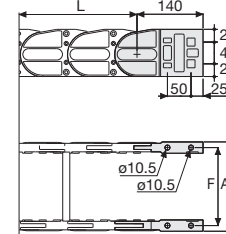
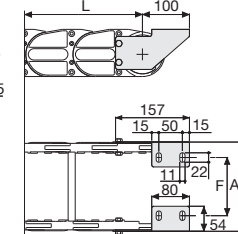

Fig. B  
Chain fixed outside the radius. (Fig B)  
See end brackets mounting variations page 31.



Chain Type	F mm
309SU064	92
309SU084	112
309SU109	137
309SU116	144
309SU139	167
309SU179	207
309SU214	242
309SU240	268
309SU264	292
309SU290	318
309SU314	342
309SU340	368
309SU364	392
309SU419	447
309SU488	516



Chain Type	F mm
309SU064	50
309SU084	70
309SU109	95
309SU116	102
309SU139	125
309SU179	165
309SU214	200
309SU240	226
309SU264	250
309SU290	276
309SU314	300
309SU340	326
309SU364	350
309SU419	405
309SU488	474

### Nylon Type Part Numbers

Complete Set Assembled Chain	End Brackets Set
309SU...	AN309KM □□□□
Complete Set Unassembled Chain	End Brackets Set
309SU...	AN309K
Tiewrap Clamp	
Assembl.	CFC309S □□□□*KM
Unassembl.	CFC309S □□□□*K

### Bright Zinc Plated Steel Type Part Numbers

Complete Set Assembled Chain	End Brackets Set
309SU...	A309SKM □□□□**
Complete Set Unassembled Chain	End Brackets Set
309SU...	A309SK □□□□**
Tiewrap Clamp	
Assembl.	SFCT309S □□□□*KM
Unassembl.	SFCT309S □□□□*K

\*Inner width (C)  
\*\*1=Pos.1; 2=Pos.2; 3=Pos.3  
\*\*\* Available on request in stainless steel

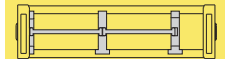

Separation System  
To choose the separators see page 196

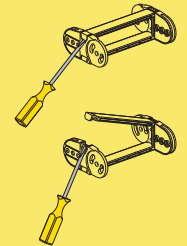

How to open the cover.

### Protection version

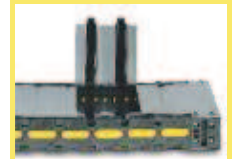

Protection version see page 148

For further information please consult Brevetti Stendaito's Technical Office

## 309B Nylon Cable Chain with un-screwable aluminium rods

### Inner height (D) 70 mm

Strong double share Sideband & Frame construction with large anti-friction triple-pin. Alu-rod frames are un-screwable from inner and outer radius. As standard the chain comes with frames every second link, on request with frames every link. Vertical and horizontal separator systems are available.

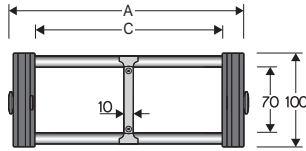

Separator	
- Unassembled	Part.no S309C
- Assembled	Part.no S309CMC
Pin	
	Part.no PG309H

### Technical characteristics when self-supported

Speed	8 m/s
Acceleration	40 m/s <sup>2</sup>

For higher requirements please consult our technical dept.

A	B	C	D	R	Weight/m	Chain
mm	mm	mm	mm	mm	kg	Part Number
153	100	100	70	150-200-250-300-350-400-500-600	4,20	309B100 □*
203	100	150	70	150-200-250-300-350-400-500-600	4,40	309B150 □*
253	100	200	70	150-200-250-300-350-400-500-600	4,55	309B200 □*
303	100	250	70	150-200-250-300-350-400-500-600	4,70	309B250 □*
353	100	300	70	150-200-250-300-350-400-500-600	4,85	309B300 □*
453	100	400	70	150-200-250-300-350-400-500-600	5,20	309B400 □*
C+53	100	.....	70	150-200-250-300-350-400-500-600		309B □□□ □**

\*Complete the code by inserting the value of the radius (R): Ex. 309B150 □  
Where: 1=150 2=200; 3=250; 4=300; 5=350; 6=400; 7=500; 8=600

\*\*Complete the code by inserting the value of the quote C and the radius (R): Ex. 309B □□□□□  
Chain equipped with aluminium rods every pitch: complete the code by inserting the letter D.  
Ex. 309B1502 □

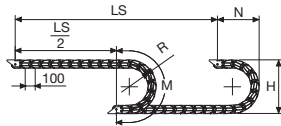

Length of chain (L)  
Half travel distance ( $\frac{LS}{2}$ )  
plus length of curve (M)

$$L = \frac{LS}{2} + M$$

R	H	N	M
mm	mm	mm	mm
150	406	300	675
200	506	350	830
250	606	400	985
300	706	455	1145
350	806	500	1300
400	906	555	1460
500	1106	650	1770
600	1306	750	2085

### Self-Supporting Capacity Diagram

The maximum length of the self-supporting capacity ( $\frac{LS}{2}$ ) in relationship to the weight of the cables and hoses contained per linear metre.

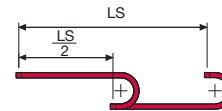
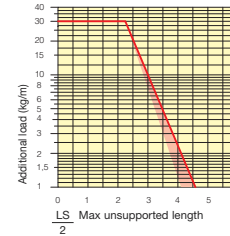

The red marking in the diagram area considers the difference of weight between various widths of chains assembled with rods every second pitch.

For applications with  $\frac{LS}{2}$  and weights not included in the area of the diagram showing self-supporting capacity, verify the possible use of support rollers (see page 30).

### End Brackets

The end brackets set allows the two ends of the chain to be attached to the equipment. Set complete with tiewrap clamps available on request.

#### Nylon Type

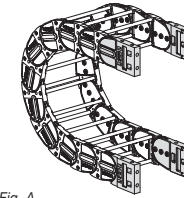

Fig. A  
The chain can be fixed frontally. See end brackets mounting variations page 31.

#### Bright Zinc Plated Steel Type\*\*\*

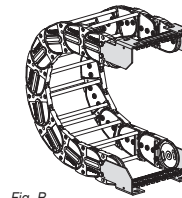
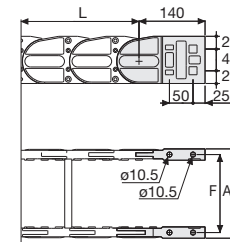

Fig. B  
Chain fixed outside the radius. (Fig B) See end brackets mounting variations page 31.



Chain Type	F mm
309B100	129
309B150	179
309B200	229
309B250	279
309B300	329
309B400	429
Special widths F=A-24	

#### Nylon Type Part Numbers

Complete Set Assembled Chain Type	End Brackets Set
309B...	AN309KM

Complete Set Unassembled Chain Type	End Brackets Set
309B...	AN309K

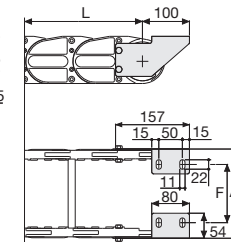

Chain Type	F mm
309B100	87
309B150	137
309B200	187
309B250	237
309B300	287
309B400	387
Special widths F=A-66	

#### Bright Zinc Plated Steel Type Part Numbers

Complete Set Assembled Chain Type	End Brackets Set
309B...	A309KM □**

Complete Set Unassembled Chain Type	End Brackets Set
309B...	A309K □**

#### Tiewrap Clamp

Assembl. SFCT309B □□□\*KM  
Unassembl. SFCT309B □□□\*K

\* Inner width (C)  
\*\* 1=Pos.1; 2=Pos.2; 3=Pos.3

\*\*\* Available on request in stainless steel

## 309B Nylon Cable Chain with un-screwable aluminium rods

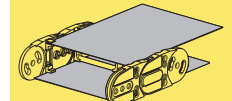

Steel laminar cover.

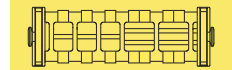

Supplementary movable separators.

### Version with aluminium draw plates



On request available with aluminium draw plates

Example Part Number:  
309T □□□□□□\*\*

\* Inner width (C)  
\*\* Bending radius (R)

For further information please consult Brevetti Stendalto's Technical Office





## Nylon Cable Chains Protection Series

H57PC/PN Series	seite 118
H80PC/PA Series	seite 120
H110PC/PA Series	seite 122
325PI Series	seite 124
335PS Series	seite 126
435PU Series	seite 128
445PU Series	seite 130
445PS Series	seite 132
445AU Series	seite 134
475PU Series	seite 136
660 Series	seite 138
770 Series	seite 140
306CU Series	seite 142
308CU Series	seite 144
309C Series	page 146
309CU Series	page 148



Special End Brackets on moving end of chain



Quickly removable covers with a "Snap-Fit" action

Completely enclosed design to protect chain contents from steel and wood chips, dust, etc.

Inner surface of chain completely smooth

Nylon separator cables can be laid apart from each other

Connecting Pivot Pin which offers high integrity in high performance applications

3



## H57PC

### Nylon chain with opening aluminium covers

#### Inner height (D) 53,5 mm

Sideband construction with quickly removable pin.  
Covers openable from either side on both inner and outer radius.  
Vertical and horizontal modular separator system are available.

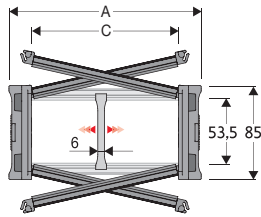

#### Separator

- Unassembled	Part.no S57UA
- Assembled	Part.no S57UAMCI
- Assembled	Part.no S57UAMCE

#### Pin

Part.no PNH57RS
-----------------

\* for chain opening outer radius  
\*\* for chain opening inner radius

#### Technical characteristics when self-supported

Speed	8 m/s
Acceleration	40 m/s <sup>2</sup>

For higher requirements please consult our technical dept.

For sliding applications, characteristics techniques may vary depending on the frequency, added weight and work environment.

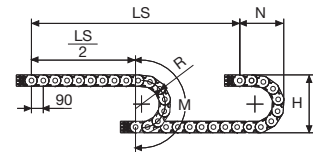

#### H57PN Version nylon covers

A	B	C	D	R	Weight/m	Chain
mm	mm	mm	mm	mm	kg	Part Number
188	85	150	57	150-180-200-250-300-350-400	4,47	H57PN150 □□□*
238	85	200	57	150-180-200-250-300-350-400	4,92	H57PN200 □□□*
288	85	250	57	150-180-200-250-300-350-400	5,45	H57PN250 □□□*

\*Complete the code by inserting the value of the radius (R): Ex. H57PN188 □□□□

\*\*H57PN with R 150: not to be used in sliding applications.

R	H	N	M	N1	M1
mm	mm	mm	mm	mm	mm
150**	385	283	655	-	-
180	445	430	750	705	1570
200	485	480	810	805	1795
250	585	530	970	1040	2350
300	685	580	1125	1275	2905
350	785	680	1280	1510	3460
400	885	780	1440	1750	4020

Length of chain (L)  
Half travel distance ( $\frac{LS}{2}$ )  
plus length of curve (M) or (M1)

$$L = \frac{LS}{2} + M \text{ or } M1$$

#### Separator

- Unassembled	Part.no S57CF3
- Assembled*	Part.no S57CF3MCI
- Assembled**	Part.no S57CF3MCE

\* for chain opening outer radius  
\*\* for chain opening inner radius

#### Self-Supporting Capacity Diagram

The maximum length of the self-supporting capacity or in admissible sagging ( $\frac{LS}{2}$ ) in relationship to the weight of the cables and hoses contained per linear metre.

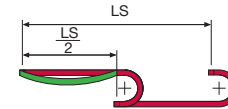
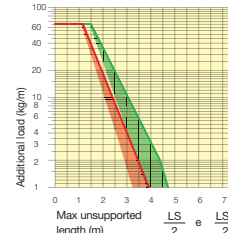

The area in the diagram considers the difference of weight between various widths of chain.

Red for self-supporting chain, green for chain in admissible sagging.

For applications with ( $\frac{LS}{2}$ ) and weights not included in the diagram of self-supporting capacity, verify the possible use of support rollers (see page 30).

#### End Brackets

The end brackets set allows the two ends of the chain to be attached to the equipment. Set complete with tiwrap clamps available on request.

#### Nylon version

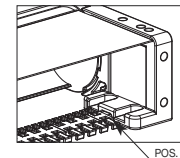
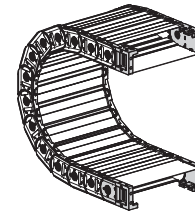
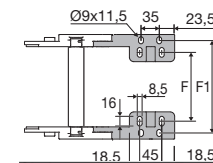
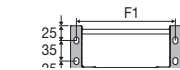
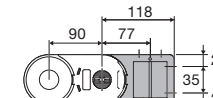

Fig. A  
The chain can be fixed frontally, inner or outer radius. (Fig A)



Chain Type	F
mm	mm
H57PC075	51
H57PC100	76
H57PC125	101
H57PC150	126
H57PC175	151
H57PC200	176
H57PC225	201
H57PC250	226
H57PC275	251
H57PC300	276
H57PC350	326
H57PC400	376

#### Nylon Type Part Numbers

Complete Set Assemble Chain	End Brackets
Type	Set
H57P...	ANH57P□□□*KM□**

Complete Set Unassemble Chain	End Brackets
Type	Set
H57P...	ANH57P□□□*K

Chain Type	F1
mm	mm
H57PC075	98
H57PC100	123
H57PC125	148
H57PC150	173
H57PC175	198
H57PC200	223
H57PC225	248
H57PC250	273
H57PC275	298
H57PC300	323
H57PC350	373
H57PC400	423

#### Tiewrap Clamp

Complete Set Assembled Mounting Position	Assembled Tiewrap Clamp set
Pos. A	SFCTH57□□□*KMA

Complete Set Unassembled Mounting Position	Unassembled Tiewrap Clamp set
Pos. A	SFCTH57□□□*KA

\* Inner Width C

## H57PC Nylon chain with opening aluminium covers

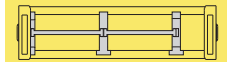

Separation System  
To choose the separators see page. 196



How to open the cover



Easy opening of the pin junction.

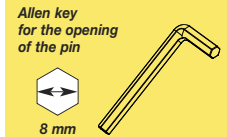

Allen key for the opening of the pin



Suitable to long travel distance.

For further information please consult Brevetti Stendalto's Technical Office

## H80PC

### Nylon chain with aluminium covers

#### Inner height (D) 77 mm

Sideband construction with quickly removable pin. Covers openable from either side on both inner and outer radius. Vertical and horizontal modular separator system are available.

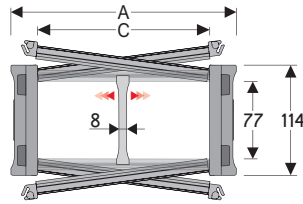

#### Separator

- Unassembled Part.no SH80SCF6
- Assembled\* Part.no SH80SCF6MCI
- Assembled\*\* Part.no SH80SCF6MCE

\* for chain opening outer radius  
\*\* for chain opening inner radius

#### Technical characteristics when self-supported

Speed	8 m/s
Acceleration	40 m/s <sup>2</sup>

For higher requirements please consult our technical dept.

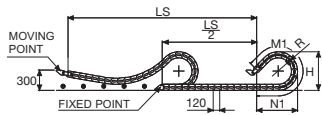
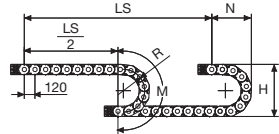

For sliding applications, characteristics techniques may vary depending on the frequency, added weight and work environment.

A	B	C	D	R	Weight/m	Chain
mm	mm	mm	mm	mm	kg	Part Number
205	114	150	77	200-250-300-350-400-500-600	8,51	H80PC150 □□□*
230	114	175	77	200-250-300-350-400-500-600	8,98	H80PC175 □□□*
255	114	200	77	200-250-300-350-400-500-600	9,44	H80PC200 □□□*
280	114	225	77	200-250-300-350-400-500-600	9,91	H80PC225 □□□*
305	114	250	77	200-250-300-350-400-500-600	10,38	H80PC250 □□□*
330	114	275	77	200-250-300-350-400-500-600	10,83	H80PC275 □□□*
355	114	300	77	200-250-300-350-400-500-600	11,27	H80PC300 □□□*
380	114	325	77	200-250-300-350-400-500-600	11,77	H80PC325 □□□*
405	114	350	77	200-250-300-350-400-500-600	12,26	H80PC350 □□□*
430	114	375	77	200-250-300-350-400-500-600	12,74	H80PC375 □□□*

\*Complete the code by inserting the value of the radius (R): Ex. H80PC150 □□□□

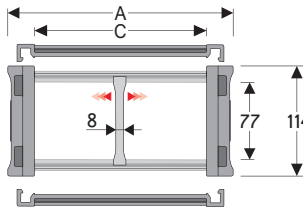

#### Separator

- Unassembled Part.no S80F
- Assembled\* Part.no S80FMCI
- Assembled\*\* Part.no S80FMCE

#### Pin

Cod. PNH80RS

\* for chain opening outer radius  
\*\* for chain opening inner radius

## H80PA

### Version with openable covers by both sides

R	H	N	M	N1	M1
mm	mm	mm	mm	mm	mm
200	514	377	870	810	1775
250	614	427	1030	1050	2330
300	714	477	1185	1285	2885
350	814	527	1340	1525	3445
400	914	577	1500	1760	4000
500	1114	677	1815	2235	5115
600	1314	777	2125	2705	6225

A	B	C	D	R	Weight/m	Chain
mm	mm	mm	mm	mm	kg	Part Number
129	114	74	77	200-250-300-350-400-500-600	6,78	H80PA074 □□□*
149	114	94	77	200-250-300-350-400-500-600	7,18	H80PA094 □□□*
174	114	119	77	200-250-300-350-400-500-600	7,61	H80PA119 □□□*
181	114	126	77	200-250-300-350-400-500-600	7,74	H80PA126 □□□*
484	114	429	77	200-250-300-350-400-500-600	13,1	H80PA429 □□□*
553	114	498	77	200-250-300-350-400-500-600	14,3	H80PA498 □□□*

\*Complete the code by inserting the value of the radius (R): Ex. H80PA119 □□□□

#### Self-Supporting Capacity Diagram

The maximum length of the self-supporting capacity or in admissible sagging ( $-\frac{LS}{2}$ ) in relationship to the weight of the cables and hoses contained per linear metre.

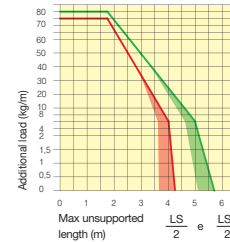

#### End Brackets

The end brackets set allows the two ends of the chain to be attached to the equipment. Set complete with tiewrap clamps available on request.

#### Nylon Version

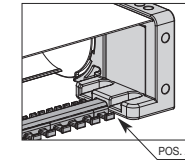
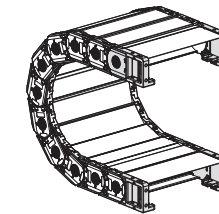
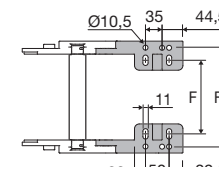
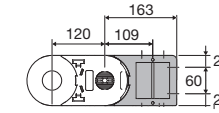
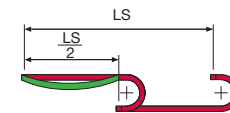

Fig. A  
The chain can be fixed frontally, inner or outer radius. (Fig A)



The area in the diagram considers the difference of weight between various widths of chain.

Red for self-supporting chain, green for chain in admissible sagging.

For applications with ( $-\frac{LS}{2}$ ) and weights not included in the diagram of self-supporting capacity, verify the possible use of support rollers (see page 30).

Length of chain (L)  
Half travel distance ( $-\frac{LS}{2}$ ) plus length of curve (M) or (M1)

$$L = -\frac{LS}{2} + M \text{ or } M1$$

Chain Type	F mm	F1 mm
H80PC150	124	177,5
H80PC175	149	202,5
H80PC200	174	227,5
H80PC225	199	252,5
H80PC250	224	277,5
H80PC275	249	302,5
H80PC300	274	327,5
H80PC325	299	352,5
H80PC350	324	377,5
H80PC375	349	402,5

#### Nylon Type Part Numbers

Chain Type	End Brackets Set
H80PC ANH80P□□□* KM□**	

Chain Type	End Brackets Set
H80PC ANH80P□□□* K	

\* Inner width C  
\*\* 1=Pos.1; 2=Pos.2; 3=Pos.3

#### Tiewrap Clamp

Pos. A	Part Number
--------	-------------

Assembled SFCTH80 □□□\* KMA

Unassembled SFCTH80 □□□\* KA

\* Inner width C

\*\* Not available for quote C 074 and C 094

## H80PC

### Nylon chain with aluminium covers

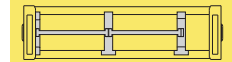

Separation System  
To choose the separators see page. 196

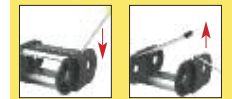

How to open the cover



Easy opening of the pin junction.

Allen key for the opening of the pin



Suitable to long travel distance.

For further information please consult Brevetti Stendalto's Technical Office

## H110PC Nylon chain with opening aluminium covers

**Inner height (D) 107 mm**  
 Sideband construction with quickly removable pin.  
 Covers openable from either side on both inner and outer radius. Vertical and horizontal modular separator system are available.

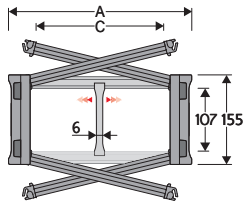

Separator	
- Unassembled	Part.no S110F3
- Assembled*	Part.no S110F3MCI
- Assembled**	Part.no S110F3MCE
Pin	
	Part.no PNH110RS

\* for chain opening outer radius  
 \*\* for chain opening inner radius

### Technical characteristics when self-supported

Speed	10 m/s
Acceleration	50 m/s <sup>2</sup>

For higher requirements please consult our technical dept.

For sliding applications, characteristics techniques may vary depending on the frequency, added weight and work environment.

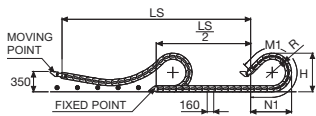
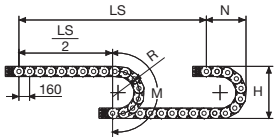

R	H	N	M	N1	M1
250	657	468	1110	1095	2375
300	757	518	1265	1335	2935
400	957	618	1580	1805	4045
500	1157	718	1895	2280	5160
600	1357	818	2205	2750	6270
700	1557	918	2520	3225	7385
750	1657	968	2680	3460	7940

A	B	C	D	R	Weight/m	Chain
205	155	150	107	250-300-400-500-600-700-750	11,06	110PC150 □□□*
230	155	175	107	250-300-400-500-600-700-750	11,59	110PC175 □□□*
255	155	200	107	250-300-400-500-600-700-750	12,11	110PC200 □□□*
280	155	225	107	250-300-400-500-600-700-750	12,63	110PC225 □□□*
305	155	250	107	250-300-400-500-600-700-750	13,16	110PC250 □□□*
330	155	275	107	250-300-400-500-600-700-750	13,67	110SC275 □□□*
355	155	300	107	250-300-400-500-600-700-750	14,18	110SC300 □□□*
380	155	325	107	250-300-400-500-600-700-750	14,73	110PC325 □□□*
405	155	350	107	250-300-400-500-600-700-750	15,30	110PC350 □□□*
430	155	375	107	250-300-400-500-600-700-750	15,81	110PC375 □□□*

\*Complete the code by inserting the value of the radius (R): Ex. 110PC350 [2][5][0]

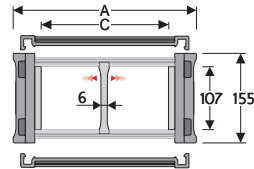

Separator	
- Unassembled	Part.no S110F3/8687
- Assembled*	Part.no S110F3/8687MCI
- Assembled**	Part.no S110F3/8687MCE
Pin	
	Part.no PNH110RS

\* for chain opening outer radius  
 \*\* for chain opening inner radius

## H110PA

Version with openable frame by both sides

A	B	C	D	R	Weight/m	Chain
484	155	429	107	250-300-400-500-600-700-750	16,90	110PA429 □□□*
553	155	498	107	250-300-400-500-600-700-750	18,27	110PA498 □□□*

\*Complete the code by inserting the value of the radius (R): Ex. 110PC429 [2][3][0]

### Self-Supporting Capacity Diagram

The maximum length of the self-supporting capacity or in admissible sagging ( $\frac{LS}{2}$ ) in relationship to the weight of the cables and hoses contained per linear metre.

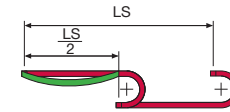
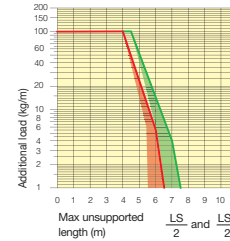

The area in the diagram considers the difference of weight between various widths of chain.

Red for self-supporting chain, green for chain in admissible sagging.

For applications with ( $\frac{LS}{2}$ ) and weights not included in the diagram of self-supporting capacity, verify the possible use of support rollers (see page 30).

Length of chain (L)  
 Half travel distance ( $\frac{LS}{2}$ ) plus length of curve (M) or (M1)

$$L = \frac{LS}{2} + M \text{ or } M1$$

### Bright Zinc Plated Steel End Brackets

The end brackets set allows the two ends of the chain to be attached to the equipment. Set complete with tiewrap clamps available on request.

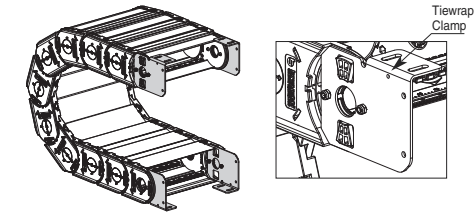
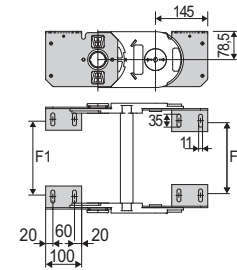

Fig. A Chain fixed outside or inside the radius. (Fig A)



Chain Type	F1 mm
110PC150	120
110PC175	145
110PC200	170
110PC225	195
110PC250	220
110PC275	245
110PC300	270
110PC325	295
110PC350	320
110PC375	344
110PA429	399
110PA498	468
Special widths	F= C-65

Chain Type	F2 mm
110PC150	112
110PC175	137
110PC200	162
110PC225	187
110PC250	212
110PC275	237
110PC300	262
110PC325	287
110PC350	312
110PC375	336
110PA429	391
110PA498	460
Special widths	F= C-93

### Bright Zinc Plated Steel Type Part Number

Complete Set Assembled Chain type	End Brackets Set
110PC A110PC □□□ KM □□*	
110PA A110PA □□□ KM □□*	

Complete Set Unassembled Chain type	End Brackets Set
110PC A110PC □□□ K □□*	
110PA A110PA □□□ K □□*	

Available on request in stainless steel.  
 \*\* 1=Pos.1; 2=Pos.2; 3=Pos.3  
 See mounting variations page 31

### Tiewrap Clamp kit mounted on female attachment

Part Number	
Assembled	SFCT110 □□□ *FKM
Unassembled	SFCT110 □□□ *FK
* Inner width (C)	

### Tiewrap Clamp kit mounted on male attachment

Part Number	
Assembled	SFCT110 □□□ *MKM
Unassembled	SFCT110 □□□ *MK
* Inner width (C)	

## H110PC Nylon chain with opening aluminium covers

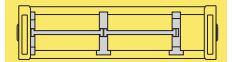

Separation System To choose the separators see page. 196



How to open the covers



Easy opening of the pin junction.

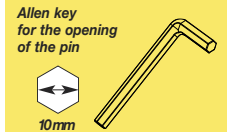

Allen key for the opening of the pin



Suitable to long travel distance.

For further information please consult Brevetti Stendaito's Technical Office



# Serie Protection

## 325PI Nylon Cable Chain with opening frames

### Inner height (D) 25 mm

Single link construction with central large anti-friction pivot, for high torsion and tensile resistance.

Frames opening from inner radius. Vertical separators available.

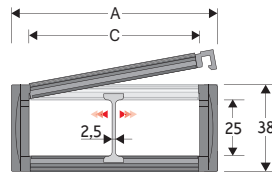

### Separator

- Unassembled	Part.no S325L
- Assembled	Part.no S325LMC

### Technical characteristics when self-supported

Speed	10 m/s
Acceleration	50 m/s <sup>2</sup>

For higher requirements please consult our technical dept.

For sliding applications, technical data can slightly change according to frequency, added weight and environment.

A	B	C	D	R	Weight/m	Chain
mm	mm	mm	mm	mm	kg	Part Number
57	38	40	25	075-100-125-150	1,15	325PI040 □□□ *
77	38	60	25	075-100-125-150	1,30	325PI060 □□□ *
93	38	76	25	075-100-125-150	1,40	325PI076 □□□ *
120	38	103	25	075-100-125-150	1,70	325PI103 □□□ *

\*Complete the code by inserting the value of the radius (R): Ex. 325PI040 □ □ □ □

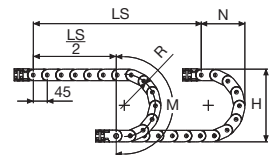

R	H	N	M	N1	M1
mm	mm	mm	mm	mm	mm
075	188	140	325	185	420
100	238	165	405	275	635
125	288	190	485	360	855
150	338	215	565	445	1075

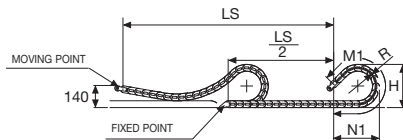

**SLIDING VERSION**  
to be ordered with pivoting end brackets set

Length of chain (L)  
Half travel distance ( $\frac{LS}{2}$ )  
plus length of curve (M) or (M1)  
 $L = \frac{LS}{2} + M$  or  $M1$

### Self-Supporting Capacity Diagram

The maximum length of the self-supporting capacity ( $\frac{LS}{2}$ ) in relationship to the weight of the cables and hoses contained per linear metre.

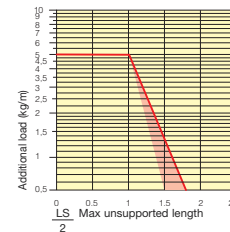

### End Brackets

The end brackets set allows the two ends of the chain to be attached to the equipment. Set complete with tiewrap clamps available on request.

#### Nylon Type

#### Bright Zinc Plated Steel Type\*\*\*

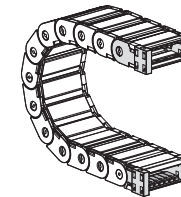

Fig. A  
Chain fixed outside/inside the radius. (Fig A)

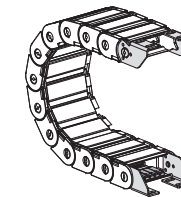
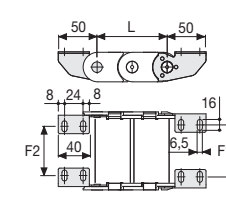
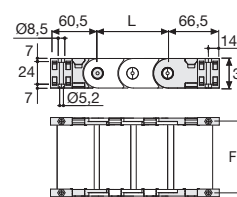
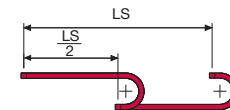

Fig. B  
Chain fixed outside or inside the radius. (Fig B)



The red marking in the diagram area considers the difference of weight between various widths of chain.

For applications with  $\frac{LS}{2}$  and weights not included in the area of the diagram showing self-supporting capacity, verify the possible use of support rollers (see page 30).

Chain Type	F mm
325PI...040	51
325PI...060	71
325PI...076	87
325PI...103	114

Chain Type	F2 mm	F1 mm
325PI...040	22	25,5
325PI...060	42	45,5
325PI...076	58	61,5
325PI...103	85	88,5

### Nylon Type Part Numbers

Complete Set Assembled Chain Type	End Brackets Set
325PI... AN325P□□□*KM	

Complete Set Unassembled Chain Type	End Brackets Set
325PI... AN325P□□□*K	

Tiewrap Clamp Part Number
Assembled CFC325L □□□*KM
Unassembled CFC325L □□□*K

### Bright Zinc Plated Steel Type Part Numbers

Complete Set Assembled Chain Type	End Brackets Set
325PI... A325LK	

Tiewrap Clamp Part Number
Assembled CFC325L □□□*KM
Unassembled CFC325L □□□*K

\*Inner width (C)  
\*\*\*Available on request in stainless steel

# Serie Protection

## 325PI Nylon Cable Chain with opening frames

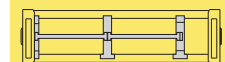

Separation System  
To choose the separators see page. 196



Suitable to long travel distance in frame every pitch version. To choose the guide channel see page 54

For further information please consult Brevetti Standalto's Technical Office

## 335PS

### Nylon cable chain with nylon cover openable to snap

#### Inner height (D) 35 mm

The chain has single link. Nylon cover is opened only on inner radius. Supplementary movable separators.

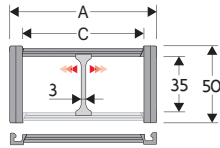

#### Separator

- Unassembled	Part. no S4353
- Assembled	Part. no S4353MC

#### Technical characteristics when self-supported

Speed	10 m/s
acceleration	50 m/s <sup>2</sup>

For higher requirements please consult our technical dept.

A	B	C	D	R	Weight/m	Chain
mm	mm	mm	mm	mm	kg	Part Number
66,5	50	50	35	100-125-150-200	1,35	335PS050 □□□ *
92,5	50	76	35	100-125-150-200	1,57	335PS076 □□□ *
119,5	50	103	35	100-125-150-200	1,81	335PS103 □□□ *
166,5	50	150	35	100-125-150-200	2,21	335PS150 □□□ *

\*Complete the code by inserting the value of the radius (R): Ex. 335PS050 □□ □□ □□

R	H	N	M	N1	M1
mm	mm	mm	mm	mm	mm
100	250	204	420	350	790
125	300	229	500	445	1025
150	350	254	580	540	1260
200	450	304	735	730	1725

Length of chain (L)  
Half travel distance ( $\frac{LS}{2}$ )  
plus length of curve (M) or (M1)

$$L = \frac{LS}{2} + M \text{ or } M1$$

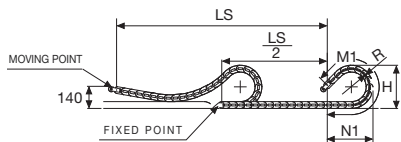
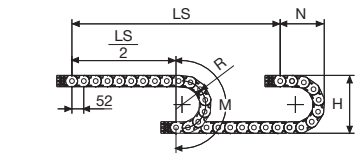

**SLIDING VERSION**  
to be ordered with pivoting end brackets set

For sliding applications, characteristics techniques may vary depending on the frequency, added weight and work environment.

#### Self-Supporting Capacity Diagram

The maximum length of the self-supporting capacity ( $\frac{LS}{2}$ ) in relationship to the weight of the cables and hoses contained per linear metre.

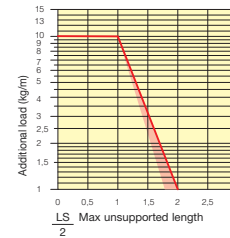

#### End Brackets

The end brackets set allows the two ends of the chain to be attached to the equipment. Set complete with tiewrap clamps available on request.

#### Nylon Type

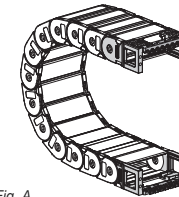
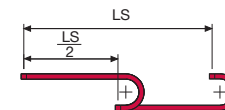
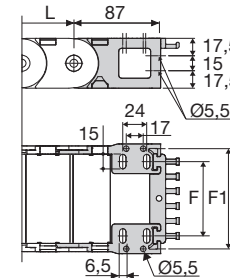

Fig. A  
The chain can be fixed frontally, inner or outer radius. (Fig A)



The red marking in the diagram area considers the difference of weight between various widths of chain.

For applications with  $\frac{LS}{2}$  and weights not included in the area of the diagram showing self-supporting capacity, verify the possible use of support rollers (see page 30).



Chain type	F mm	F1 mm
335P...050	35	61
335P...076	61	87
335P...103	88	114
335P...150	135	161

#### Nylon Type Part Numbers

Complete Set Assembled Chain	End Brackets Set
Type	Set
335	AN335P□□□*KM□□**

Complete Set Unassembled Chain	End Brackets Set
Type	Set
335	AN335P□□□*K

Tiewrap Clamp	Part Number
335	PFN335□□□*

\* Inner width (C)

\*\* 1=Pos.1; 2=Pos.2; 3=Pos.3

## 335PS Nylon cable chain with nylon cover openable to snap





## 445PU

### Nylon Protection Cable Chain with opening covers

Inner height (D) 45 mm

Sideband & Frame construction with large anti-friction single-pin. Vertical separators are available.

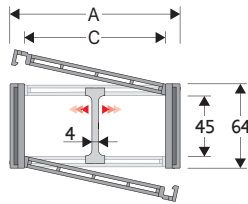

#### Separator

- Unassembled	Part.no S445UF
- Assembled*	Part.no S445UFMCI
- Assembled**	Part.no S445UFMCE

#### Pin

Part.no PG445

\* for chain opening outer radius  
\*\* for chain opening inner radius

#### Technical characteristics when self-supported

Speed	10 m/s
Acceleration	50 m/s <sup>2</sup>

For higher requirements please consult our technical dept.

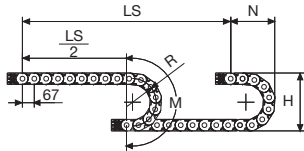

Length of chain (L)

Half travel distance ( $\frac{LS}{2}$ )

plus length of curve (M)

$$L = \frac{LS}{2} + M$$

R mm	H mm	N mm	M mm
100	264	200	450
125	314	225	530
150	364	250	605
175	414	275	685
200	464	300	765
250	564	350	920
300	664	400	1080

A mm	B mm	C mm	D mm	R mm	Weight/m kg	Chain Part Number
72	64	50	45	100-125-150-175-200-250-300	1,83	445PU050 □□□ *
83	64	61	45	100-125-150-175-200-250-300	1,87	445PU061 □□□ *
97	64	75	45	100-125-150-175-200-250-300	2,05	445PU075 □□□ *
103	64	81	45	100-125-150-175-200-250-300	2,10	445PU081 □□□ *
107	64	85	45	100-125-150-175-200-250-300	2,15	445PU085 □□□ *
117	64	95	45	100-125-150-175-200-250-300	2,23	445PU095 □□□ *
122	64	100	45	100-125-150-175-200-250-300	2,26	445PU100 □□□ *
129	64	107	45	100-125-150-175-200-250-300	2,31	445PU107 □□□ *
139	64	117	45	100-125-150-175-200-250-300	2,38	445PU117 □□□ *
147	64	125	45	100-125-150-175-200-250-300	2,49	445PU125 □□□ *
158	64	136	45	100-125-150-175-200-250-300	2,60	445PU136 □□□ *
172	64	150	45	100-125-150-175-200-250-300	2,71	445PU150 □□□ *
197	64	175	45	100-125-150-175-200-250-300	2,93	445PU175 □□□ *
222	64	200	45	100-125-150-175-200-250-300	3,17	445PU200 □□□ *
233	64	211	45	100-125-150-175-200-250-300	3,26	445PU211 □□□ *
247	64	225	45	100-125-150-175-200-250-300	3,39	445PU225 □□□ *
274	64	252	45	100-125-150-175-200-250-300	3,64	445PU252 □□□ *
283	64	261	45	100-125-150-175-200-250-300	3,71	445PU261 □□□ *
308	64	286	45	100-125-150-175-200-250-300	3,92	445PU286 □□□ *
334	64	312	45	100-125-150-175-200-250-300	4,13	445PU312 □□□ *
356	64	334	45	100-125-150-175-200-250-300	4,35	445PU334 □□□ *
384	64	362	45	100-125-150-175-200-250-300	4,59	445PU362 □□□ *

\*Complete the code by inserting the value of the radius (R): Ex. 445PU050 □□□ □□

#### Self-Supporting Capacity Diagram

The maximum length of the self-supporting capacity ( $\frac{LS}{2}$ ) in relationship to the weight of the cables and hoses contained per linear metre.

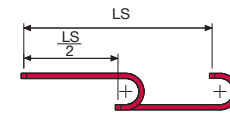
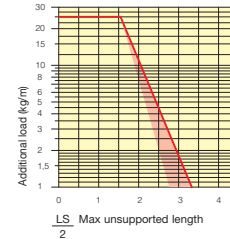

The red marking in the diagram area considers the difference of weight between various widths of chain.

For applications with  $\frac{LS}{2}$  and weights not included in the area of the diagram showing self-supporting capacity, verify the possible use of support rollers (see page 30).

#### End Brackets

The end brackets set allows the two ends of the chain to be attached to the equipment. Set complete with tiewrap clamps available on request.

#### Nylon Type

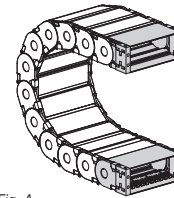

Fig. A The chain can be fixed frontally, inner or outer radius. (Fig A)

#### Nylon Type

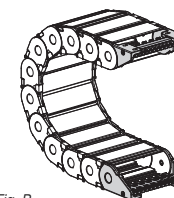
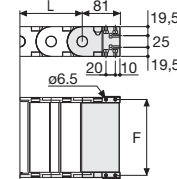

Fig. B Chain fixed outside the radius. (Fig B) See end brackets mounting variations page 31.



Chain Type	F mm
445PU050	63
445PU061	74
445PU075	88
445PU081	94
445PU085	98
445PU095	108
445PU100	113
445PU107	120
445PU117	130
445PU125	138
445PU136	149
445PU150	163
445PU175	188
445PU200	213
445PU211	224
445PU225	238
445PU252	265
445PU261	274
445PU286	289
445PU312	325
445PU334	347
445PU362	375

#### Nylon Type Part Numbers

Complete Set Assembled	AN445P□□□*KM
Complete Set Unassembled	AN445P□□□*K

#### Tiewrap Clamp Part Numbers

Complete Set Assembled	CFC445M□□□*KM
Complete Set Unassembled	CFC445M□□□*K

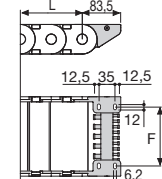

Chain Type	F mm
445PU050	28
445PU061	39
445PU075	53
445PU081	59
445PU085	63
445PU095	73
445PU100	78
445PU107	85
445PU117	95
445PU125	103
445PU136	114
445PU150	128
445PU175	153
445PU200	178
445PU211	189
445PU225	203
445PU252	230
445PU261	239
445PU286	254
445PU312	290
445PU334	312
445PU362	340

#### Nylon Type Part Numbers

Complete Set Assembled	AN445KM□□□□
Complete Set Unassembled	AN445K□□□□

#### Tiewrap Clamp Part Numbers

Complete Set Assembled	SFCT445□□□□*KM
Complete Set Unassembled	SFCT445□□□□*K

\*\*\*1=Pos.1; 2=Pos.2; 3=Pos.3  
5=Pos.5; 6=Pos.6

## 445PU Nylon Protection Cable Chain with opening covers

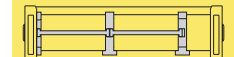

Separation System To choose the separators see page. 196

#### Bright Zinc Plated Steel Type\*\*\*

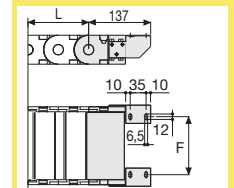
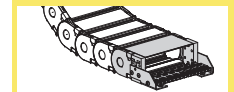

$$F = A - 44$$

#### Bright Zinc Plated Steel Type Part Numbers

Complete Set Assembled	A445P□□□*KM□□**
Complete Set Unassembled	A445P□□□*K□□**

\* Inner width (C)  
\*\* 1=Pos.1; 2=Pos.2; 3=Pos.3  
\*\*\* Available on request in stainless steel

For further information please consult Brevetti Stendalto's Technical Office

# Serie Protection

## 445PS Nylon Protection Cable Chain with opening covers

### Inner height (D) 41 mm

Sideband construction with anti-friction single-pin.  
Covers openable only inner radius.  
Vertical separator system are available.

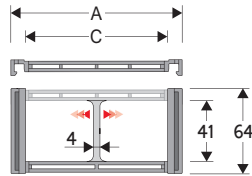

Separator	
- Unassembled	Part.no S445CNF
- Assembled	Part.no S445CNFMC
Pin	
	Part.no PG445

### Technical characteristics when self-supported

Speed	10 m/s
Acceleration	50 m/s <sup>2</sup>

For higher requirements please consult our technical dept.

A	B	C	D	R	Weight/m	Chain
mm	mm	mm	mm	mm	kg	Part Number
83	64	61	41	100-125-150-175-200-250-300	1,87	445PS061 □□□ *
97	64	75	41	100-125-150-175-200-250-300	2,05	445PS075 □□□ *
147	64	125	41	100-125-150-175-200-250-300	2,49	445PS125 □□□ *

\*Complete the code by inserting the value of the radius (R): Ex. Es. 445PS061 □ □ □ □ □

For sliding applications, characteristics techniques may vary depending on the frequency, added weight and work environment.

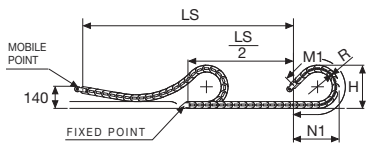
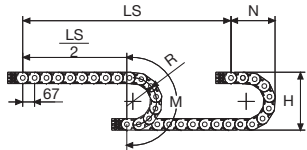

**SLIDING VERSION**  
to be ordered with pivoting end brackets set

R	H	N	M	N1	M1
mm	mm	mm	mm	mm	mm
100	264	200	450	340	740
125	314	225	530	460	1020
150	364	250	605	580	1300
175	414	275	685	700	1575
200	464	300	765	820	1855
250	564	350	920	1055	2410
300	664	400	1080	1295	2970

Length of chain (L)  
Half travel distance ( $\frac{LS}{2}$ )  
plus length of curve (M) or (M1)

$$L = \frac{LS}{2} + M \text{ or } M1$$

### Self-Supporting Capacity Diagram

The maximum length of the self-supporting capacity ( $\frac{LS}{2}$ ) in relationship to the weight of the cables and hoses contained per linear metre.

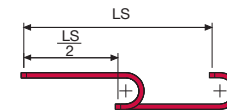
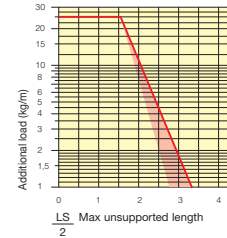

The red marking in the diagram area considers the difference of weight between various widths of chain.

For applications with  $\frac{LS}{2}$  and weights not included in the area of the diagram showing self-supporting capacity, verify the possible use of support rollers (see page 30).

### End Brackets

The end brackets set allows the two ends of the chain to be attached to the equipment. Set complete with tiewrap clamps available on request.

#### Nylon version

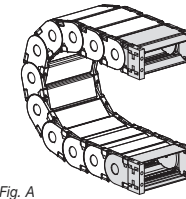

Fig. A  
The chain can be fixed frontally, inner or outer radius. (Fig A)

#### Nylon version

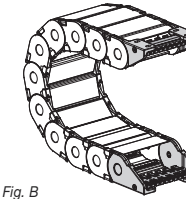
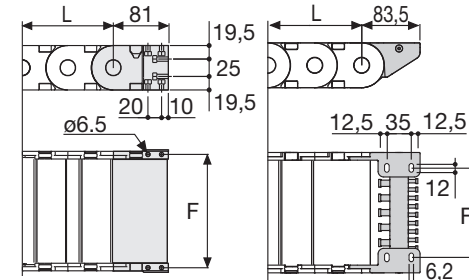

Fig. B  
Chain fixed outside the radius. (Fig B)  
See end brackets mounting variations page 31.



Chain type	F mm
445PS 061	74
445PS 075	88
445PS 125	138

Chain type	F mm
445PS 061	39
445PS 075	53
445PS 125	103

### Nylon Type Part Numbers

Complete Set Assembled  
AN445PS □□□ \*KM

Complete Set Unassembled  
AN445PS □□□ \*K

### Nylon Type Part Numbers

Complete Set Assembled  
AN445PSKM □ \*\*\*\*

Complete Set Unassembled  
AN445PSK □ \*\*\*\*

### Tiewrap Clamp Part Number

Complete Set Assembled  
SFCT445 □□□ \*KM

Complete Set Unassembled  
SFCT445 □□□ \*K

\*\*\*\*1=Pos.1; 2=Pos.2; 3=Pos.3  
5=Pos.5; 6=Pos.6

## Serie Protection

### 445PS Nylon Protection Cable Chain with opening covers



#### S445CNF

This separator can be mounted in 2 ways different ensuring the same reliable resistance.

#### MOBILE separator



mounted outside the premises the separator can move

#### FIXED Separator



mounted inside the seats assumes a fixed position.

For further information please consult Brevetti Stendalto's Technical Office

## 445AU

### Nylon Protection Cable Chain with opening aluminium covers

**Inner height (D) 45 mm**

Sideband & Frame construction with large anti-friction single-pin. Vertical separators are available.

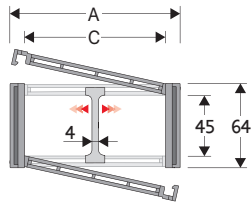

#### Separator

- Unassembled	Part.no S445UF
- Assembled*	Part.no S445UFMCI
- Assembled**	Part.no S445UFMCE

#### Pin

Part.no PG445

\* for chain opening outer radius  
\*\* for chain opening inner radius

#### Technical characteristics when self-supported

Speed	10 m/s
Acceleration	50 m/s <sup>2</sup>

For higher requirements please consult our technical dept.

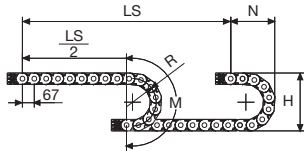

Length of chain (L)  
Half travel distance ( $\frac{LS}{2}$ )  
plus length of curve (M)

$$L = \frac{LS}{2} + M$$

R	H	N	M
mm	mm	mm	mm
100	264	200	450
125	314	225	530
150	364	250	605
175	414	275	685
200	464	300	765
250	564	350	920
300	664	400	1080

A	B	C	D	R	Weight/m	Chain
mm	mm	mm	mm	mm	kg	Part Number
72	64	50	45	100-125-150-175-200-250-300	2,13	445AU050 □□□ *
83	64	61	45	100-125-150-175-200-250-300	2,24	445AU061 □□□ *
97	64	75	45	100-125-150-175-200-250-300	2,49	445AU075 □□□ *
103	64	81	45	100-125-150-175-200-250-300	2,59	445AU081 □□□ *
107	64	85	45	100-125-150-175-200-250-300	2,65	445AU085 □□□ *
117	64	95	45	100-125-150-175-200-250-300	2,79	445AU095 □□□ *
122	64	100	45	100-125-150-175-200-250-300	2,85	445AU100 □□□ *
129	64	107	45	100-125-150-175-200-250-300	2,95	445AU107 □□□ *
139	64	117	45	100-125-150-175-200-250-300	3,08	445AU117 □□□ *
147	64	125	45	100-125-150-175-200-250-300	3,24	445AU125 □□□ *
158	64	136	45	100-125-150-175-200-250-300	3,41	445AU136 □□□ *
172	64	150	45	100-125-150-175-200-250-300	3,61	445AU150 □□□ *
197	64	175	45	100-125-150-175-200-250-300	3,97	445AU175 □□□ *
222	64	200	45	100-125-150-175-200-250-300	4,35	445AU200 □□□ *
233	64	211	45	100-125-150-175-200-250-300	4,51	445AU211 □□□ *
247	64	225	45	100-125-150-175-200-250-300	4,73	445AU225 □□□ *
274	64	252	45	100-125-150-175-200-250-300	5,13	445AU252 □□□ *
283	64	261	45	100-125-150-175-200-250-300	5,26	445AU261 □□□ *
308	64	286	45	100-125-150-175-200-250-300	5,63	445AU286 □□□ *
334	64	312	45	100-125-150-175-200-250-300	6,00	445AU312 □□□ *
356	64	334	45	100-125-150-175-200-250-300	6,33	445AU334 □□□ *
384	64	362	45	100-125-150-175-200-250-300	6,73	445AU362 □□□ *

\*Complete the code by inserting the value of the radius (R): Ex. 445AU050 □ □ □ □ □



#### Self-Supporting Capacity Diagram

The maximum length of the self-supporting capacity ( $\frac{LS}{2}$ ) in relationship to the weight of the cables and hoses contained per linear metre.

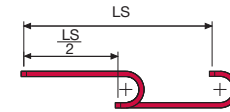
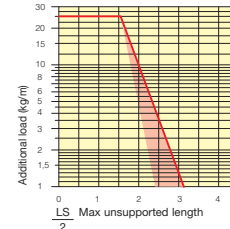

The red marking in the diagram area considers the difference of weight between various widths of chain.

For applications with  $\frac{LS}{2}$  and weights not included in the area of the diagram showing self-supporting capacity, verify the possible use of support rollers (see page 30).

#### End Brackets

The end brackets set allows the two ends of the chain to be attached to the equipment. Set complete with tiewrap clamps available on request.

#### Nylon Type

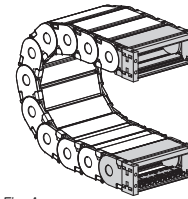
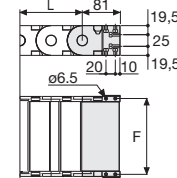

Fig. A  
The chain can be fixed frontally, inner or outer radius. (Fig A)



Chain Type	F mm
445AU050	63
445AU061	74
445AU075	88
445AU081	94
445AU085	98
445AU095	108
445AU100	113
445AU107	120
445AU117	130
445AU125	138
445AU136	149
445AU150	163
445AU175	188
445AU200	213
445AU211	224
445AU225	238
445AU252	265
445AU261	274
445AU286	299
445AU312	325
445AU334	347
445AU362	375

#### Nylon Type Part Numbers

Complete Set Assembled	AN445A □□□ *KM
Complete Set Unassembled	AN445A □□□ *K

#### Tiewrap Clamp Part Numbers

Complete Set Assembled	CFC445M □□□ *KM
Complete Set Unassembled	CFC445M □□□ *K

#### Nylon Type

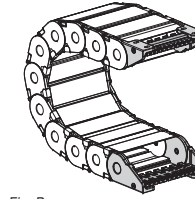
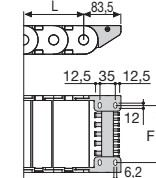

Fig. B  
Chain fixed outside the radius. (Fig B)  
See end brackets mounting variations page 31.



Chain Type	F mm
445AU050	28
445AU061	39
445AU075	53
445AU081	59
445AU085	63
445AU095	73
445AU100	78
445AU107	85
445AU117	95
445AU125	103
445AU136	114
445AU150	128
445AU175	153
445AU200	178
445AU211	189
445AU225	203
445AU252	230
445AU261	239
445AU286	264
445AU312	290
445AU334	312
445AU362	340

#### Nylon Type Part Numbers

Complete Set Assembled	AN445KM □□□□
Complete Set Unassembled	AN445K □□□□

#### Tiewrap Clamp Part Numbers

Complete Set Assembled	SFCT445 □□□□ *KM
Complete Set Unassembled	SFCT445 □□□□ *K

\*\*\*\*1=Pos.1; 2=Pos.2; 3=Pos.3  
5=Pos.5; 6=Pos.6

## 445AU Nylon Protection Cable Chain with opening aluminium covers

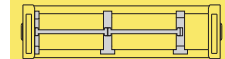

Separation System  
To choose the separators see page. 196

#### Bright Zinc Plated Steel Type\*\*\*

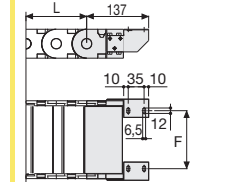
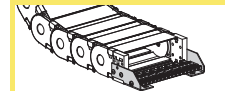

$$F = A - 44$$

#### Bright Zinc Plated Steel Type Part Numbers

Complete Set Assembled	A445A □□□ *KM □□ **
Complete Set Unassembled	A445A □□□ *K □□ **

\* Inner width (C)  
\*\* 1=Pos.1; 2=Pos.2; 3=Pos.3  
\*\*\* Available on request in stainless steel

For further information please consult Brevetti Stendalto's Technical Office



## 475PU

### Nylon Protection Cable Chain with opening covers

**Inner height (D) 75,5 mm**  
Sideband & Frame construction with large anti-friction single-pin. Vertical and horizontal modular separator system is available.

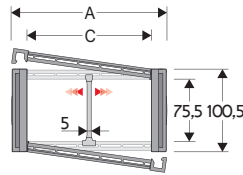

Separator	
- Unassembled	Part.no S309S
- Assembled*	Part.no S309SMCI
- Assembled**	Part.no S309SMCE
Pin	
	Part.no PG475

\* for chain opening outer radius  
\*\* for chain opening inner radius

#### Technical characteristics when self-supported

Speed	8 m/s
Acceleration	40 m/s <sup>2</sup>

For higher requirements please consult our technical dept.

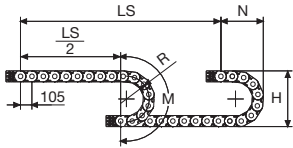

Length of chain (L)  
Half travel distance ( $\frac{LS}{2}$ )  
plus length of curve (M)  
 $L = \frac{LS}{2} + M$

R	H	N	M
mm	mm	mm	mm
180	460,5	335	775
200	500,5	355	840
250	600,5	405	995
300	700,5	460	1155
350	800,5	505	1310
400	900,5	560	1470

A	B	C	D	R	Weight/m	Chain
mm	mm	mm	mm	mm	kg	Part Number
112	100,5	74	75,5	180-200-250-300-350-400	4,60	475PU074 □□□ *
132	100,5	94	75,5	180-200-250-300-350-400	4,80	475PU094 □□□ *
157	100,5	119	75,5	180-200-250-300-350-400	5,10	475PU119 □□□ *
164	100,5	126	75,5	180-200-250-300-350-400	5,15	475PU126 □□□ *
187	100,5	149	75,5	180-200-250-300-350-400	5,40	475PU149 □□□ *
227	100,5	189	75,5	180-200-250-300-350-400	5,80	475PU189 □□□ *
262	100,5	224	75,5	180-200-250-300-350-400	6,20	475PU224 □□□ *
288	100,5	250	75,5	180-200-250-300-350-400	6,50	475PU250 □□□ *
312	100,5	274	75,5	180-200-250-300-350-400	6,75	475PU274 □□□ *
338	100,5	300	75,5	180-200-250-300-350-400	7,05	475PU300 □□□ *
362	100,5	324	75,5	180-200-250-300-350-400	7,30	475PU324 □□□ *
388	100,5	350	75,5	180-200-250-300-350-400	7,55	475PU350 □□□ *
412	100,5	374	75,5	180-200-250-300-350-400	7,85	475PU374 □□□ *
467	100,5	429	75,5	180-200-250-300-350-400	8,50	475PU429 □□□ *
536	100,5	498	75,5	180-200-250-300-350-400	9,20	475PU498 □□□ *

\*Complete the code by inserting the value of the radius (R): Ex. 475PU119 □□□ □□

#### Self-Supporting Capacity Diagram

The maximum length of the self-supporting capacity ( $\frac{LS}{2}$ ) in relationship to the weight of the cables and hoses contained per linear metre.

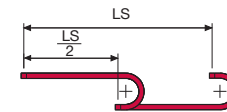
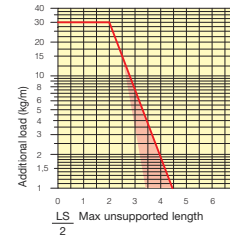

The red marking in the diagram area considers the difference of weight between various widths of chain.

For applications with  $\frac{LS}{2}$  and weights not included in the area of the diagram showing self-supporting capacity, verify the possible use of support rollers (see page 30).

#### Bright Zinc Plated Steel End Brackets\*\*\*

The end brackets set allows the two ends of the chain to be attached to the equipment.

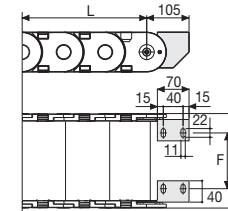
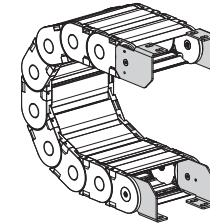

Chain Type	F mm
475PU074	35
475PU094	55
475PU119	80
475PU126	87
475PU149	110
475PU189	150
475PU224	185
475PU250	211
475PU274	235
475PU300	261
475PU324	285
475PU350	311
475PU374	335
475PU498	459

#### Bright Zinc Plated Steel Type Part Numbers

Complete Set Assembled	End Brackets
Chain	Set
475...	A475P□□□*KM□□**

Complete Set Unassembled	End Brackets
Chain	Set
475...	A475P□□□*K□□**

\*\* 1=Pos.1; 2=Pos.2; 3=Pos.3  
\*\*\* Available on request in stainless steel

Fig. A  
Chain fixed outside the radius. (Fig A)  
See end brackets mounting variations page 31.

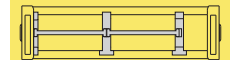

Separation System  
To choose the separators see page. 196

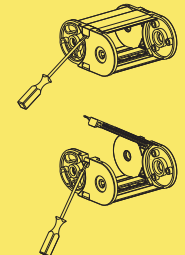

How to open the cover.

For further information please consult Brevetti Stendalto's Technical Office

## 660 Nylon Protection Cable Chain with opening covers

### Inner height (D) 36 mm

Double share Sideband & Frame construction with large anti-friction single-pin. Covers are opening from inner radius.

Vertical separators are available.

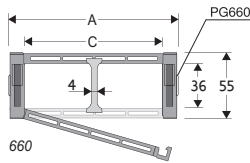

### Separator

- Unassembled Part.no S660  
- Assembled Part.no S660MC

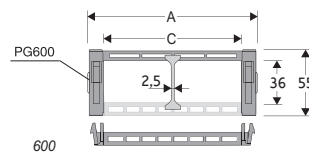

### Separator

- Unassembled Part.no S600  
- Assembled Part.no S600MC

### Technical characteristics when self-supported

Speed	6 m/s
Acceleration	30 m/s <sup>2</sup>

For higher requirements please consult our technical dept.

A	B	C	D	R	Weight/m	Chain
mm	mm	mm	mm	mm	kg	Part Number
79	55	50	36	100-150-200-250	1,90	660050 □□□ *
129	55	100	36	100-150-200-250	2,40	660100 □□□ *
179	55	150	36	100-150-200-250	3,00	60015 □ **

\*Complete the code by inserting the value of the radius (R): Ex. 660050 □ □ □ □

\*\*Complete the code by inserting the value of the radius (R): Ex. 60015 □

Where: 0=100; 1=150; 2=200; 3=250

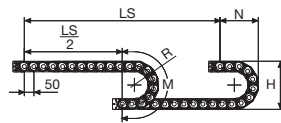

Length of chain (L)  
Half travel distance ( $\frac{LS}{2}$ )  
plus length of curve (M)

$$L = \frac{LS}{2} + M$$

R	H	N	M
mm	mm	mm	mm
100	255	180	415
150	355	230	575
200	455	280	730
250	555	330	885

### Self-Supporting Capacity Diagram

The maximum length of the self-supporting capacity ( $\frac{LS}{2}$ ) in relationship to the weight of the cables and hoses contained per linear metre.

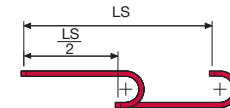
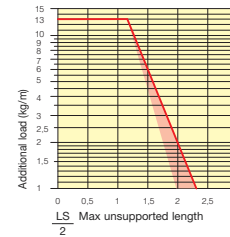

The red marking in the diagram area considers the difference of weight between various widths of chain.

For applications with  $\frac{LS}{2}$  and weights not included in the area of the diagram showing self-supporting capacity, verify the possible use of support rollers (see page 30).

### End Brackets

The end brackets set allows the two ends of the chain to be attached to the equipment.

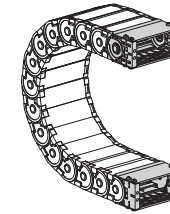
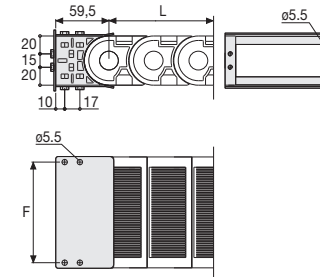

Fig. A  
The chain can be fixed frontally, inner or outer radius. (Fig A)



Chain	F
Type	mm
660 C=50	62
660 C=100	112
600 C=150	162

### Nylon Type Part Numbers

Complete Set Assembled Chain	End Brackets
Type	Set
660 C=50	AN660050KM
660 C=100	AN660100KM
600 C=150	AL600KM

Complete Set Unassembled Chain	End Brackets
Type	Set
660 C=50	AN660050K
660 C=100	AN660100K
600 C=150	AL600K

## 660 Nylon Protection Cable Chain with opening covers

How to open the cover.

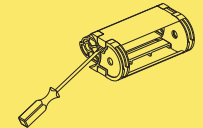
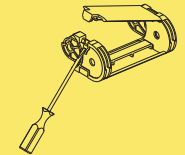

Special tool to remove the connecting pivots:  
Part Number PZ010.



For further information please consult Brevetti Standalto's Technical Office

## 770 Nylon Protection Cable Chain with opening covers

### Inner height (D) 51 mm

Double share Sideband & Frame construction with large anti-friction single-pin. Covers are opening from inner radius.

Vertical separators are available.

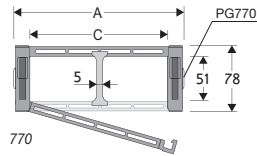

770

### Separator

- Unassembled Part.no S770  
- Assembled Part.no S770MC

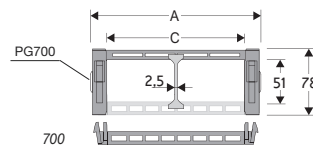

700

### Separator

- Unassembled Part.no S700  
- Assembled Part.no S700MC

### Technical characteristics when self-supported

Speed	6 m/s
Acceleration	30 m/s <sup>2</sup>

For higher requirements please consult our technical dept.

A	B	C	D	R	Weight/m	Chain
mm	mm	mm	mm	mm	kg	Part Number
120	78	85	51	150-200-250-300	3,30	770085 □□□ *
135	78	100	51	150-200-250-300	3,90	770100 □□□ *
185	78	150	51	150-200-250-300	4,10	770150 □□□ *
235	78	200	51	150-200-250-300	4,50	770200 □□□ *
285	78	250	51	150-200-250-300	5,00	70025 □□ **

\*Complete the code by inserting the value of the radius (R): Ex. 770085 □□□□

\*\*Complete the code by inserting the value of the radius (R): Ex. 70025 □□

Where: 0=150; 1=200; 2=250; 3=300

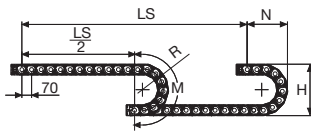

Length of chain (L)  
Half travel distance ( $\frac{LS}{2}$ )  
plus length of curve (M)

$$L = \frac{LS}{2} + M$$

R	H	N	M
mm	mm	mm	mm
150	378	260	615
200	478	310	770
250	578	365	930
300	678	410	1085

### Self-Supporting Capacity Diagram

The maximum length of the self-supporting capacity ( $\frac{LS}{2}$ ) in relationship to the weight of the cables and hoses contained per linear metre.

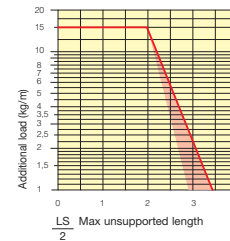

### End Brackets

The end brackets set allows the two ends of the chain to be attached to the equipment.

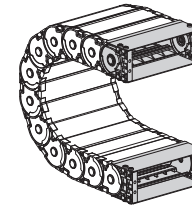
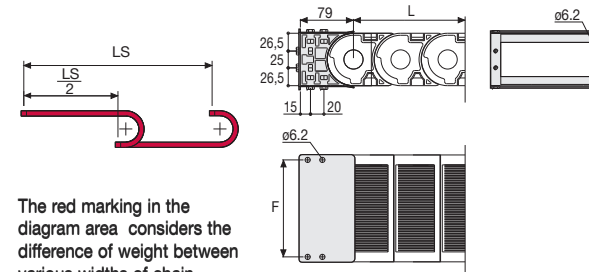

Fig. A  
The chain can be fixed frontally, inner or outer radius. (Fig A)



The red marking in the diagram area considers the difference of weight between various widths of chain.

For applications with  $\frac{LS}{2}$  and weights not included in the area of the diagram showing self-supporting capacity, verify the possible use of support rollers (see page 30).

Chain Type	F mm
770 C=85	100
770 C=100	115
770 C=150	165
770 C=200	215
700 C=250	265

### Nylon Type Part Numbers

Complete Set Assembled Chain	End Brackets
Type	Set
770...	AN770 □□□ *KM
700 C=250	AL700KM

Complete Set Unassembled Chain	End Brackets
Type	Set
770...	AN770 □□□ *K
700 C=250	AL700K

\* Inner width (C)

## 770 Nylon Protection Cable Chain with opening covers

How to open the cover.

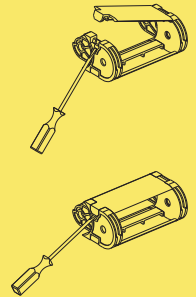

Special tool to remove the connecting pivots:  
Part Number PZ10.



For further information please consult Brevetti Standalto's Technical Office



## 306CU Nylon Protection Cable Chain with opening aluminium covers

### Inner height (D) 37 mm

Strong double share Sideband & Frame construction with large anti-friction triple-pin.

Covers are opening from inner and outer radius.

Vertical separators are available.

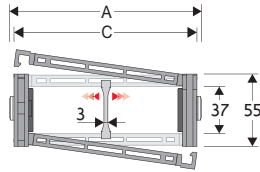

Separator	
- Unassembled	Part.no S306SM
- Assembled	Part.no S306SMMC
Pin	
	Part.no PG309H

### Technical characteristics when self-supported

Speed	8 m/s
Acceleration	40 m/s <sup>2</sup>

For higher requirements please consult our technical dept.

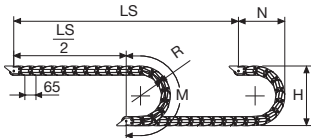

Length of chain (L)

Half travel distance ( $\frac{LS}{2}$ )

plus length of curve (M)

$$L = \frac{LS}{2} + M$$

R	H	N	M
mm	mm	mm	mm
107	272	205	470
150	358	245	605
200	458	295	760
250	558	345	920
300	658	395	1075

A	B	C	D	R	Weight/m	Chain Part Number
mm	mm	mm	mm	mm	kg	
79	55	43	37	107-150-200-250-300	1,85	306CU043 □□□ *
90	55	54	37	107-150-200-250-300	1,90	306CU054 □□□ *
104	55	68	37	107-150-200-250-300	2,04	306CU068 □□□ *
110	55	74	37	107-150-200-250-300	2,09	306CU074 □□□ *
114	55	78	37	107-150-200-250-300	2,15	306CU078 □□□ *
124	55	88	37	107-150-200-250-300	2,20	306CU088 □□□ *
129	55	93	37	107-150-200-250-300	2,22	306CU093 □□□ *
136	55	100	37	107-150-200-250-300	2,27	306CU100 □□□ *
146	55	110	37	107-150-200-250-300	2,33	306CU110 □□□ *
154	55	118	37	107-150-200-250-300	2,42	306CU118 □□□ *
165	55	129	37	107-150-200-250-300	2,50	306CU129 □□□ *
179	55	143	37	107-150-200-250-300	2,61	306CU143 □□□ *
204	55	168	37	107-150-200-250-300	2,80	306CU168 □□□ *
229	55	193	37	107-150-200-250-300	3,00	306CU193 □□□ *
240	55	204	37	107-150-200-250-300	3,08	306CU204 □□□ *
254	55	218	37	107-150-200-250-300	3,19	306CU218 □□□ *
281	55	245	37	107-150-200-250-300	3,40	306CU245 □□□ *
290	55	254	37	107-150-200-250-300	3,47	306CU254 □□□ *
315	55	279	37	107-150-200-250-300	3,77	306CU279 □□□ *
341	55	305	37	107-150-200-250-300	3,84	306CU305 □□□ *
363	55	327	37	107-150-200-250-300	4,01	306CU327 □□□ *
391	55	355	37	107-150-200-250-300	4,22	306CU355 □□□ *

\*Complete the code by inserting the value of the radius (R): Ex. 306CU110 [7] [5] [0]

### Self-Supporting Capacity Diagram

The maximum length of the self-supporting capacity ( $\frac{LS}{2}$ ) in relationship to the weight of the cables and hoses contained per linear metre.

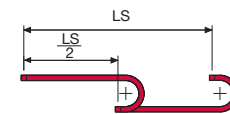
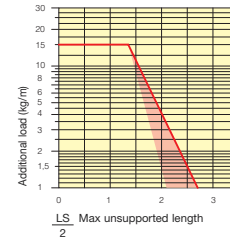

The red marking in the diagram area considers the difference of weight between various widths of chains assembled with nylon frames every second pitch.

For applications with  $\frac{LS}{2}$  and weights not included in the area of the diagram showing self-supporting capacity, verify the possible use of support rollers (see page 30).

### End Brackets

The end brackets set allows the two ends of the chain to be attached to the equipment. Set complete with tiewrap clamps available on request.

#### Nylon Type

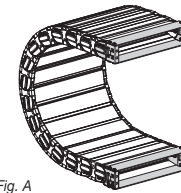

Fig. A  
The chain can be fixed frontally, inner or outer radius. (Fig A)

#### Nylon Type

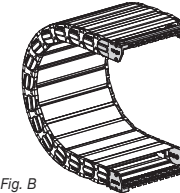
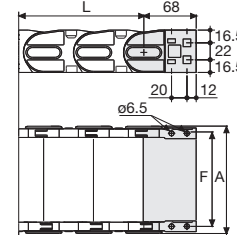
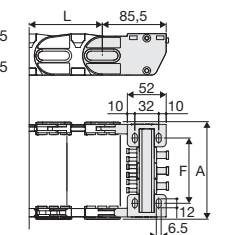

Fig. B  
Chain fixed outside the radius. (Fig B)  
See end brackets mounting variations page 31.



Chain Type	F mm
306CU043	61
306CU054	72
306CU068	86
306CU074	92
306CU078	96
306CU088	106
306CU093	111
306CU100	118
306CU110	128
306CU118	136
306CU129	147
306CU143	161
306CU168	186
306CU193	211
306CU204	222
306CU218	236
306CU245	263
306CU254	272
306CU279	297
306CU305	323
306CU327	345
306CU355	373



Chain Type	F mm
306CU043	36*
306CU054	47
306CU068	61
306CU074	67
306CU078	71
306CU088	81
306CU093	86
306CU100	93
306CU110	103
306CU118	111
306CU129	122
306CU143	136
306CU168	161
306CU193	186
306CU204	197
306CU218	211
306CU245	238
306CU254	247
306CU279	272
306CU305	298
306CU327	320
306CU355	348

### Nylon Type Part Numbers

Complete Set Assembled Chain	End Brackets Set
306 AN306C□□□*KM	
Complete Set Unassembled Chain	End Brackets Set
306 AN306C□□□*K	

### Nylon Type Part Numbers

Complete Set Assembled Chain	End Brackets Set
306 ANL306KM □**	
Complete Set Unassembled Chain	End Brackets Set
306 ANL306K □**	

Tiewrap Clamp  
Assembl. SFCTL306□□□\*KM  
Unassembl. SFCTL306□□□\*K

\*The F dimension (36) can not mount the tiewrap clamp.

## 306CU Nylon Protection Cable Chain with opening aluminium covers

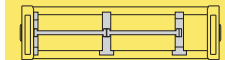

Separation System  
To choose the separators see page. 196

### Bright Zinc Plated Steel Type\*\*\*

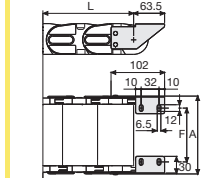
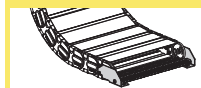

F = A-43

### Bright Zinc Plated Steel Type Part Numbers

Complete Set Assembled Chain	End Brackets Set
306 A306CU□□□*KM □**	
Complete Set Unassembled Chain	End Brackets Set
306 A306CU□□□*K □**	

Tiewrap Clamp  
Assembl. SFCT306S□□□\*KM  
Unassembl. SFCT306S□□□\*K

\*Inner width (C)  
\*\* 1=Pos.1; 2=Pos.2; 3=Pos.3  
\*\*\* Available on request in stainless steel

## 308CU Nylon Protection Cable Chain with opening aluminium covers

### Inner height (D) 57 mm

Strong double share Sideband & Frame construction with large anti-friction triple-pin.

Covers are opening from inner and outer radius.

Vertical separators are available.

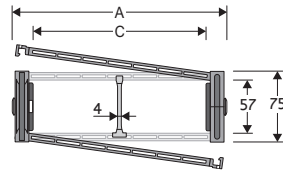

### Separator

- Unassembled	Part.no S308C
- Assembled	Part.no S308CMCI for chain opening outer radius
- Assembled	Part.no S308CMCE for chain opening inner radius
<b>Pin</b>	Part.no PG308

### Technical characteristics when self-supported

Speed	8 m/s
Acceleration	40 m/s <sup>2</sup>

For higher requirements please consult our technical dept.

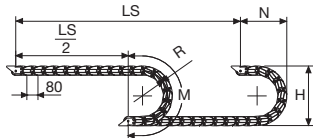

Length of chain (L)

Half travel distance ( $\frac{LS}{2}$ )

plus length of curve (M)

$$L = \frac{LS}{2} + M$$

R mm	H mm	N mm	M mm
150	375	270	635
180	435	300	725
200	475	320	790
230	535	350	885
280	635	400	1040
300	675	420	1105
400	875	520	1420
600	1175	750	2045

A mm	B mm	C mm	D mm	R mm	Weight/m kg	Chain Part Number
82	75	38	57	150-180-200-230-280-300-400-600	2,90	308CU038 □□□ *
93	75	49	57	150-180-200-230-280-300-400-600	3,01	308CU049 □□□ *
107	75	63	57	150-180-200-230-280-300-400-600	3,19	308CU063 □□□ *
113	75	69	57	150-180-200-230-280-300-400-600	3,27	308CU069 □□□ *
117	75	73	57	150-180-200-230-280-300-400-600	3,35	308CU073 □□□ *
127	75	83	57	150-180-200-230-280-300-400-600	3,43	308CU083 □□□ *
132	75	88	57	150-180-200-230-280-300-400-600	3,48	308CU088 □□□ *
139	75	95	57	150-180-200-230-280-300-400-600	3,56	308CU095 □□□ *
149	75	105	57	150-180-200-230-280-300-400-600	3,67	308CU105 □□□ *
157	75	113	57	150-180-200-230-280-300-400-600	3,77	308CU113 □□□ *
168	75	124	57	150-180-200-230-280-300-400-600	3,91	308CU124 □□□ *
182	75	138	57	150-180-200-230-280-300-400-600	4,06	308CU138 □□□ *
207	75	163	57	150-180-200-230-280-300-400-600	4,36	308CU163 □□□ *
232	75	188	57	150-180-200-230-280-300-400-600	4,65	308CU188 □□□ *
243	75	199	57	150-180-200-230-280-300-400-600	4,78	308CU199 □□□ *
257	75	213	57	150-180-200-230-280-300-400-600	4,94	308CU213 □□□ *
284	75	240	57	150-180-200-230-280-300-400-600	5,25	308CU240 □□□ *
293	75	249	57	150-180-200-230-280-300-400-600	5,37	308CU249 □□□ *
318	75	274	57	150-180-200-230-280-300-400-600	5,48	308CU274 □□□ *
344	75	300	57	150-180-200-230-280-300-400-600	5,95	308CU300 □□□ *
366	75	322	57	150-180-200-230-280-300-400-600	6,20	308CU322 □□□ *
394	75	350	57	150-180-200-230-280-300-400-600	6,11	308CU350 □□□ *

\*Complete the code by inserting the value of the radius (R): Ex. 308CU105 □□□ □□□

### Self-Supporting Capacity Diagram

The maximum length of the self-supporting capacity ( $\frac{LS}{2}$ ) in relationship to the weight of the cables and hoses contained per linear metre.

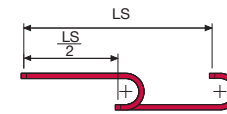
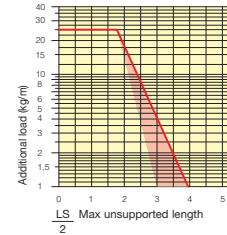

The red marking in the diagram area considers the difference of weight between various widths of chains assembled with nylon frames every second pitch.

For applications with  $\frac{LS}{2}$  and weights not included in the area of the diagram showing self-supporting capacity, verify the possible use of support rollers (see page 30).

### End Brackets

The end brackets set allows the two ends of the chain to be attached to the equipment. Set complete with tiewrap clamps available on request.

#### Nylon Type

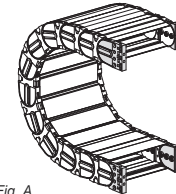

Fig. A  
The chain can be fixed frontally, inner or outer radius. (Fig A)

#### Bright Zinc Plated Steel Type\*\*\*

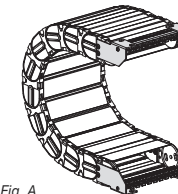
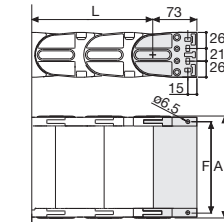

Fig. A  
Chain fixed outside the radius. (Fig A)  
See end brackets mounting variations page 31.



Chain Type	F mm
308CU038	62
308CU049	73
308CU063	87
308CU069	93
308CU073	97
308CU083	107
308CU088	112
308CU095	119
308CU105	129
308CU113	137
308CU124	148
308CU138	162
308CU163	187
308CU188	212
308CU199	223
308CU213	237
308CU240	264
308CU249	273
308CU274	298
308CU300	324
308CU322	346
308CU350	374

#### Nylon Type Part Numbers

Complete Set Assembled Chain	End Brackets Set
308	AN308C□□□*KM

Complete Set Unassembled Chain	End Brackets Set
308	AN308C□□□*K

Chain Type	F mm
308CU038	31
308CU049	31
308CU063	45
308CU069	51
308CU073	55
308CU083	65
308CU088	70
308CU095	77
308CU105	87
308CU113	95
308CU124	106
308CU138	120
308CU163	145
308CU188	170
308CU199	181
308CU213	195
308CU240	222
308CU249	231
308CU274	256
308CU300	282
308CU322	304
308CU350	332

#### Bright Zinc Plated Steel Type Part Numbers

Complete Set Assembled Chain	End Brackets Set
308	A308CU□□□*KM□**

Complete Set Unassembled Chain	End Brackets Set
308	A308CU□□□*K□**

#### Tiewrap Clamp

Assembl. SFCT308S □□□*KM
Unassembl. SFCT308S □□□*K

\* Inner width (C)  
\*\* 1=Pos.1; 2=Pos.2; 3=Pos.3

\*\*\* Available on request in stainless steel

## 308CU Nylon Protection Cable Chain with opening aluminium covers

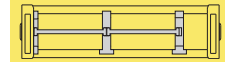

Separation System  
To choose the separators see page. 196

## 309C Nylon Protection Cable Chain with opening covers

### Inner height (D) 72 mm

Strong double share Sideband & Frame construction with large anti-friction triple-pin.  
Covers are opening from outer radius  
Vertical and horizontal separator systems are available.

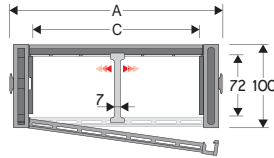

### Separator

- Unassembled	Part.no S309PO
- Assembled	Part.no S309POMC
<b>Pin</b>	Part.no PG309

### Technical characteristics when self-supported

Speed	8 m/s
Acceleration	40 m/s <sup>2</sup>

For higher requirements please consult our technical dept.

A	B	C	D	R	Weight/m	Chain
mm	mm	mm	mm	mm	kg	Part Number
253	100	200	72	200-250-300-350-400-500	5,7	<b>309C200</b> □□□ *
353	100	300	72	200-250-300-350-400-500	6,8	<b>309C300</b> □□□ *
453	100	400	72	200-250-300-350-400-500	7,9	<b>309C400</b> □□□ *

\*Complete the code by inserting the value of the radius (R): Ex. 309C200 □□□ □□

R	H	N	M
mm	mm	mm	mm
200	506	350	830
250	606	400	985
300	706	455	1145
350	806	500	1300
400	906	555	1460
500	1106	650	1770

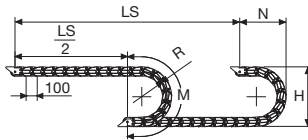

Length of chain (L)  
Half travel distance ( $\frac{LS}{2}$ )  
plus length of curve (M)

$$L = \frac{LS}{2} + M$$

### Self-Supporting Capacity Diagram

The maximum length of the self-supporting capacity ( $\frac{LS}{2}$ ) in relationship to the weight of the cables and hoses contained per linear metre.

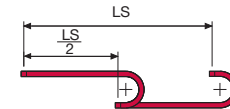
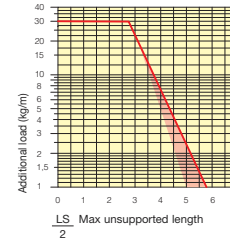

The red marking in the diagram area considers the difference of weight between various widths of chain.

For applications with  $\frac{LS}{2}$  and weights not included in the area of the diagram showing self-supporting capacity, verify the possible use of support rollers (see page 30).

### End Brackets

The end brackets set allows the two ends of the chain to be attached to the equipment.

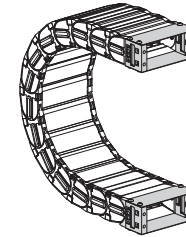
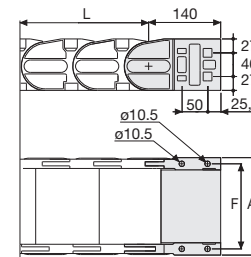

Fig. A  
The chain can be fixed frontally, inner or outer radius. (Fig A)



Chain	F
Type	mm
309C200	229
309C300	329
309C400	429

### Nylon Type Part Numbers

Complete Set Assembled	
Chain	End Brackets
Type	Set
309C200	AN309C200KM
309C300	AN309C300KM
309C400	AN309C400KM

Complete Set Unassembled	
Chain	End Brackets
Type	Set
309C200	AN309C200K
309C300	AN309C300K
309C400	AN309C400K

## 309C Nylon Protection Cable Chain with opening covers

How to open the cover.

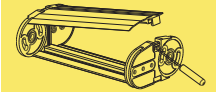
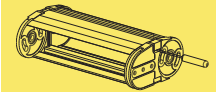



## 309CU Nylon Protection Cable Chain with opening aluminium covers

**Inner height (D) 75,5 mm**  
Strong double share Sideband & Frame construction with large anti-friction triple-pin.  
Covers are opening from inner and outer radius.  
Vertical separators are available.

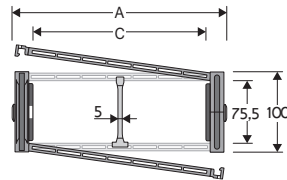

Separator	
- Unassembled	Part.no S309S/3178
- Assembled	Part.no S309S/3178MCI for chain opening outer radius
- Assembled	Part.no S309S/3178MCE for chain opening inner radius
Pin	
	Part.no PG309H

### Technical characteristics when self-supported

Speed	8 m/s
Acceleration	40 m/s <sup>2</sup>

For higher requirements please consult our technical dept.

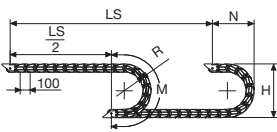

Length of chain (L)  
Half travel distance ( $\frac{LS}{2}$ )  
plus length of curve (M)

$$L = \frac{LS}{2} + M$$

A	B	C	D	R	Weight/m	Chain
mm	mm	mm	mm	mm	kg	Part Number
117	100	64	75,5	200-250-300-350-400-500-600	4,84	309CU064 □□□ *
137	100	84	75,5	200-250-300-350-400-500-600	5,12	309CU084 □□□ *
162	100	109	75,5	200-250-300-350-400-500-600	5,47	309CU109 □□□ *
169	100	116	75,5	200-250-300-350-400-500-600	5,58	309CU116 □□□ *
192	100	139	75,5	200-250-300-350-400-500-600	5,90	309CU139 □□□ *
232	100	179	75,5	200-250-300-350-400-500-600	6,47	309CU179 □□□ *
267	100	214	75,5	200-250-300-350-400-500-600	6,97	309CU214 □□□ *
293	100	240	75,5	200-250-300-350-400-500-600	7,35	309CU240 □□□ *
317	100	264	75,5	200-250-300-350-400-500-600	7,68	309CU264 □□□ *
343	100	290	75,5	200-250-300-350-400-500-600	8,04	309CU290 □□□ *
367	100	314	75,5	200-250-300-350-400-500-600	8,39	309CU314 □□□ *
393	100	340	75,5	200-250-300-350-400-500-600	8,74	309CU340 □□□ *
417	100	364	75,5	200-250-300-350-400-500-600	9,09	309CU364 □□□ *
472	100	419	75,5	200-250-300-350-400-500-600	9,98	309CU419 □□□ *
541	100	488	75,5	200-250-300-350-400-500-600	10,86	309CU488 □□□ *

\*Complete the code by inserting the value of the radius (R): Ex. 309CU □□□ □□ □□

R	H	N	M
mm	mm	mm	mm
200	506	350	830
250	606	400	985
300	706	455	1145
350	806	500	1300
400	906	555	1460
500	1106	650	1770
600	1306	750	2085

### Self-Supporting Capacity Diagram

The maximum length of the self-supporting capacity ( $\frac{LS}{2}$ ) in relationship to the weight of the cables and hoses contained per linear metre.

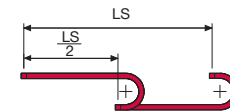
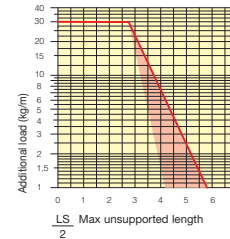

The red marking in the diagram area considers the difference of weight between various widths of chains assembled with nylon frames every second pitch.

For applications with  $\frac{LS}{2}$  and weights not included in the area of the diagram showing self-supporting capacity, verify the possible use of support rollers (see page 30).

### End Brackets

The end brackets set allows the two ends of the chain to be attached to the equipment. Set complete with tie-wrap clamps available on request.

#### Nylon Type

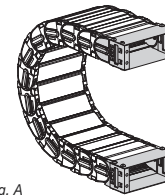

Fig. A  
The chain can be fixed frontally, inner or outer radius. (Fig A)

#### Bright Zinc Plated Steel Type\*\*\*

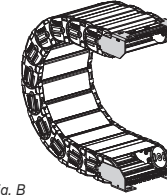
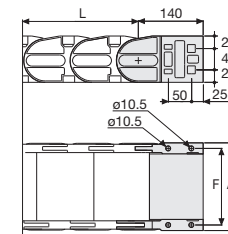

Fig. B  
Chain fixed outside the radius. (Fig B)  
See end brackets mounting variations page 31.



Chain Type	F mm
309CU064	92
309CU084	112
309CU109	137
309CU116	144
309CU139	167
309CU179	207
309CU214	242
309CU240	268
309CU264	292
309CU290	318
309CU314	342
309CU340	368
309CU364	392
309CU419	447
309CU488	516

#### Nylon Type Part Numbers

Complete Set Assembled Chain Type	End Brackets Set
309	AN309C□□□*KM

Complete Set Unassembled Chain Type	End Brackets Set
309	AN309C□□□*K

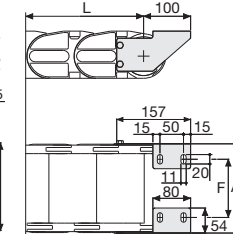

Chain Type	F mm
309CU064	50
309CU084	70
309CU109	95
309CU116	102
309CU139	125
309CU179	165
309CU214	200
309CU240	226
309CU264	250
309CU290	276
309CU314	300
309CU340	326
309CU364	350
309CU419	405
309CU488	474

#### Bright Zinc Plated Steel Type Part Numbers

Complete Set Assembled Chain Type	End Brackets Set
309	A309CU□□□*KM□□

Complete Set Unassembled Chain Type	End Brackets Set
309	A309CU□□□*K□□

Tiewrap Clamp  
Assembl. SFCT309S□□□\*KM  
Unassembl. SFCT309S□□□\*K

\* Inner width (C)  
\*\* 1=Pos.1; 2=Pos.2; 3=Pos.3  
\*\*\* Available on request in stainless steel

## 309CU Nylon Protection Cable Chain with opening aluminium covers

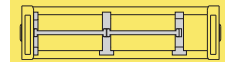

Separation System  
To choose the separators see page. 196



## Nylon Cable Chains Sliding Series

326SU Series	page 152
326B Series	page 154
328SU Series	page 156
328B Series	page 158
319ZE Series	page 160
319B Series	page 162
329B Series	page 164
329SU Series	page 166
329CD Series	page 168
478MU Series	page 170
478PU Series	page 172
60PU Series	page 174
80PU Series	page 176
Channel guide for long travel distance	
For 445-660A-770A-326-328 20P-30P-60-H45-H57 Series	page 178
For 478-319-329-80-35P-35PC-40P-H80-H110 Series	page 180
For 326-328-60-H57 Series	page 182

*Inner surface of chain completely smooth*

*Special End Brackets on moving end of chain*

*Triple connecting Pivot Pin which offers high integrity in high performance applications*

*Nylon separator. Cables can be laid apart from each other*

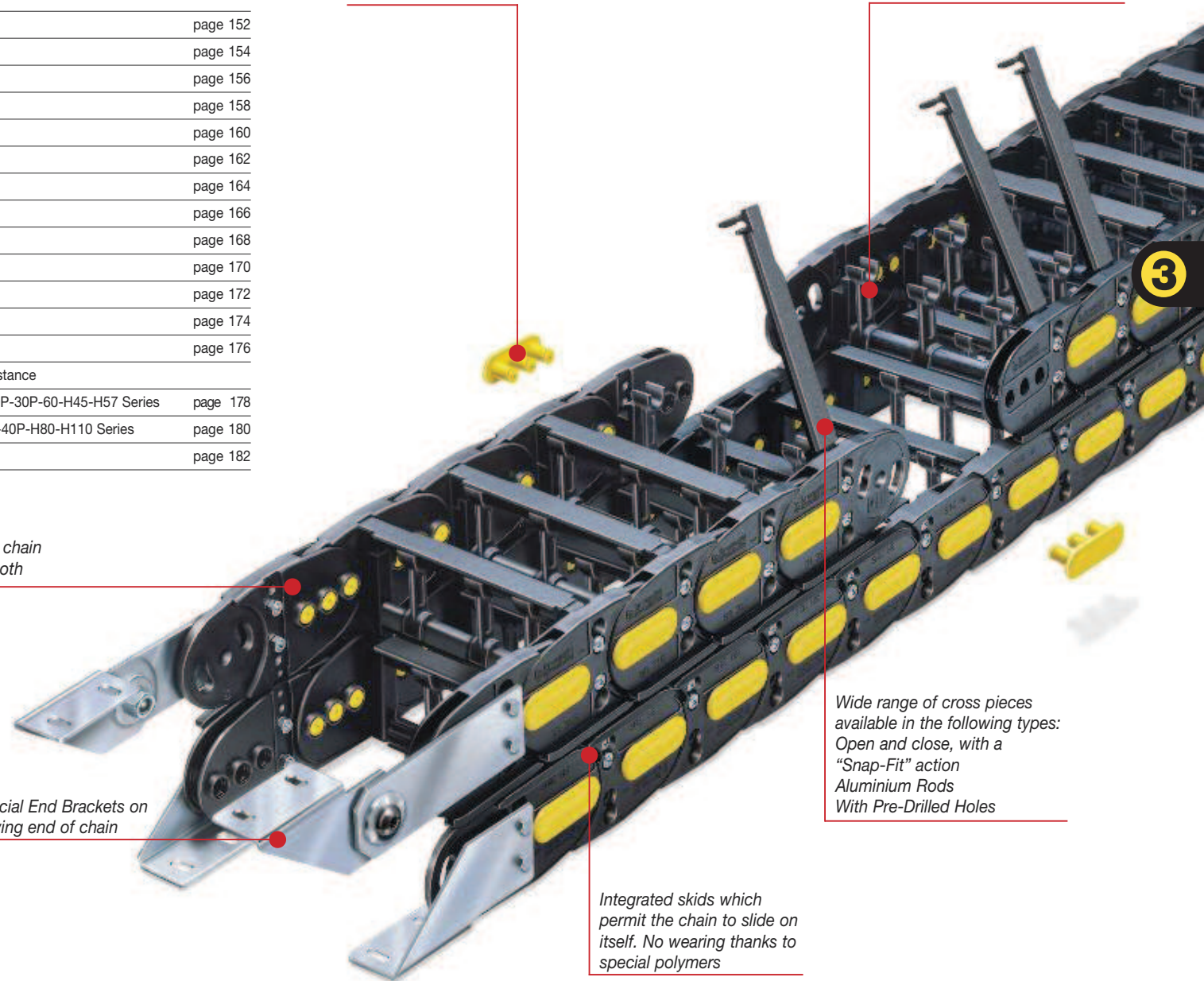

*Wide range of cross pieces available in the following types:  
Open and close, with a "Snap-Fit" action  
Aluminium Rods  
With Pre-Drilled Holes*

*Integrated skids which permit the chain to slide on itself. No wearing thanks to special polymers*



## 326SU Nylon Sliding Cable Chain with opening frames

### Inner height (D) 37 mm

Strong double share Sideband & Frame construction with large anti-friction triple-pin. The chain incorporates large sliding-skid surfaces to offer durability, even with high speed/loads. Frames opening from inner radius and outer radius. As standard the chain comes with frames every second link, on request with frames every link. Modular separator systems are available.

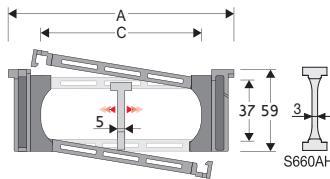

Separator	
- Unassembled	Part.no S306SM
- Assembled	Part.no S306SMMC
Strong-hold separator for C > 200 mm	
- Unassembled	Part.no S660AH
- Assembled	Part.no S660AHMCI for chain opening outer radius
- Assembled	Part.no S660AHMCE for chain opening inner radius
Pin	
	Part.no PG307

### Technical characteristics

Speed	2 m/s
Acceleration	4 m/s <sup>2</sup>

For higher requirements please consult our technical dept.

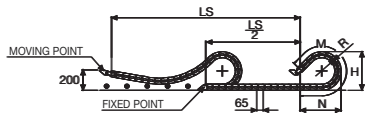

Length of chain (L)

Half travel distance ( $\frac{LS}{2}$ )

plus length of curve (M)

$$L = \frac{LS}{2} + M$$

R	H	N	M
mm	mm	mm	mm
107	272	280	625
150	358	430	1000
200	458	605	1440
250	558	775	1875
300	658	945	2315

A	B	C	D	R	Weight/m	Chain
mm	mm	mm	mm	mm	kg	Part Number
106	59	61	37	107-150-200-250-300	1,33	326SU061 □□□ *
117	59	72	37	107-150-200-250-300	1,33	326SU072 □□□ *
131	59	86	37	107-150-200-250-300	1,40	326SU086 □□□ *
137	59	92	37	107-150-200-250-300	1,41	326SU092 □□□ *
141	59	96	37	107-150-200-250-300	1,43	326SU096 □□□ *
151	59	106	37	107-150-200-250-300	1,46	326SU106 □□□ *
156	59	111	37	107-150-200-250-300	1,46	326SU111 □□□ *
163	59	118	37	107-150-200-250-300	1,48	326SU118 □□□ *
173	59	128	37	107-150-200-250-300	1,49	326SU128 □□□ *
181	59	136	37	107-150-200-250-300	1,54	326SU136 □□□ *
192	59	147	37	107-150-200-250-300	1,57	326SU147 □□□ *
206	59	161	37	107-150-200-250-300	1,61	326SU161 □□□ *
231	59	186	37	107-150-200-250-300	1,68	326SU186 □□□ *
256	59	211	37	107-150-200-250-300	1,75	326SU211 □□□ *
267	59	222	37	107-150-200-250-300	1,79	326SU222 □□□ *
281	59	236	37	107-150-200-250-300	1,83	326SU236 □□□ *
308	59	263	37	107-150-200-250-300	1,91	326SU263 □□□ *
317	59	272	37	107-150-200-250-300	1,93	326SU272 □□□ *
342	59	297	37	107-150-200-250-300	2,00	326SU297 □□□ *
368	59	323	37	107-150-200-250-300	2,06	326SU323 □□□ *
390	59	345	37	107-150-200-250-300	2,10	326SU345 □□□ *
418	59	373	37	107-150-200-250-300	2,21	326SU373 □□□ *

\*Complete the code by inserting the value of the radius (R): Ex. 326SU118 □ □ □ □ □

Chain equipped with nylon frame every pitch: complete the code by inserting the letter D.

Ex. 326SU118150 □ □

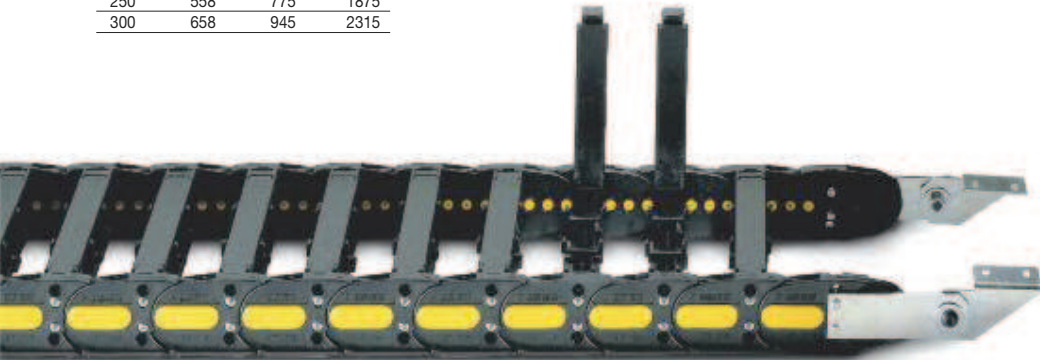

Version with frames mounted on every pitch.

### End Brackets

The end brackets set allows the two ends of the chain to be attached to the equipment. One set includes two pivoting end brackets to be installed at the moving point and two standard steel end brackets to be installed at the fixed point.

**Bright Zinc Plated Steel Movable Type\*\*\*** (moving point)  
**Bright Zinc Plated Steel Type\*\*\*** (fixed point)

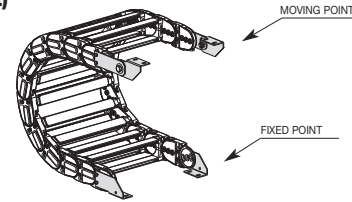
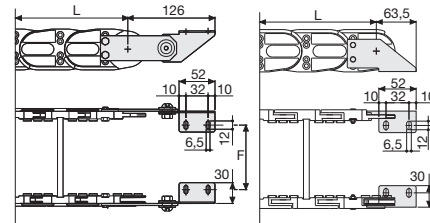

Fig. A  
Chain fixed outside the radius. (Fig A)



Chain Type	F mm
326SU061	58
326SU072	69
326SU086	83
326SU092	89
326SU096	93
326SU106	103
326SU111	108
326SU118	115
326SU128	125
326SU136	133
326SU147	144
326SU161	158
326SU186	183
326SU211	208
326SU222	219
326SU236	233
326SU263	260
326SU272	269
326SU297	294
326SU323	320
326SU345	342
326SU373	370

### Bright Zinc Plated Steel Type Part Numbers

Complete Set Assembled Chain	End Brackets Set
Type	Set
326SU...	A326KM

Complete Set Unassembled Chain	End Brackets Set
Type	Set
326SU...	A326K

\*\*\* Available on request in stainless steel

## 326SU Nylon Sliding Cable Chain with opening frames

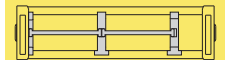

Separation System  
To choose the separators see page. 196

How to open the cover.

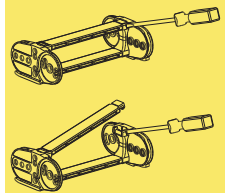

Special tool to remove the connecting pivots:  
Part Number PZ036.



For further information please consult Brevetti Stendalto's Technical Office



## 326B Nylon Sliding Cable Chain with un-screwable aluminium rods

### Inner height (D) 30 mm

Strong double share Sideband & Frame construction with large anti-friction triple-pin. The chain incorporates large sliding-skid surfaces to offer durability, even with high speed/loads. The Alu-rod frames are un-screwable from inner and outer radius. As standard the chain comes with frames every second link, on request with frames every link. Separator systems are available.

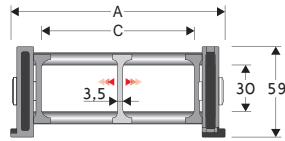

Separator	
- Unassembled	Part.no S2000F
- Assembled	Part.no S2000FMC
Pin	
	Part.no PG307

### Technical characteristics

Speed	2 m/s
Acceleration	4 m/s <sup>2</sup>

For higher requirements please consult our technical dept.

A	B	C	D	R	Weight/m	Chain
mm	mm	mm	mm	mm	kg	Part Number
115	59	75	30	107-150-200-250-300	1,75	326B075 □□□ *
140	59	100	30	107-150-200-250-300	1,80	326B100 □□□ *
190	59	150	30	107-150-200-250-300	1,90	326B150 □□□ *
240	59	200	30	107-150-200-250-300	2,05	326B200 □□□ *
290	59	250	30	107-150-200-250-300	2,15	326B250 □□□ *
340	59	300	30	107-150-200-250-300	2,25	326B300 □□□ *
C+40	59	.....	30	107-150-200-250-300		326B □□□ □□□ **

\*Complete the code by inserting the value of the radius (R): Ex. 326B100 □ □ □ □

\*\*Complete the code by inserting the value of the quote C and the radius (R): Ex. 326B □ □ □ □ □ □ □ □

Chain equipped with aluminium rods every pitch: complete the code by inserting the letter D. Ex. 326B100150 □ □

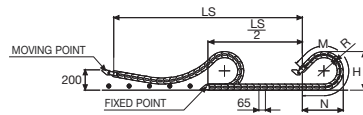

R	H	N	M
mm	mm	mm	mm
107	272	280	625
150	358	430	1000
200	458	605	1440
250	558	775	1875
300	658	945	2315

Length of chain (L)

Half travel distance ( $\frac{LS}{2}$ )

plus length of curve (M)

$$L = \frac{LS}{2} + M$$



Version with Alu-rods on every second pitch.

### End Brackets

The end brackets set allows the two ends of the chain to be attached to the equipment. One set includes two pivoting end brackets to be installed at the moving point and two standard steel end brackets to be installed at the fixed point.

**Bright Zinc Plated Steel Movable Type\*\*\***  
(moving point)

**Bright Zinc Plated Steel Type\*\*\***  
(fixed point)

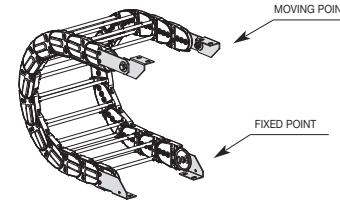
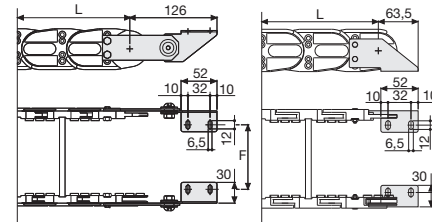

Fig. A  
Chain fixed outside the radius. (Fig A)



Chain Type	F mm
326B075	67
326B100	92
326B150	142
326B200	192
326B250	242
326B300	292

Special widths F=A-48

### Bright Zinc Plated Steel Type Part Numbers

Complete Set Assembled	
Chain	End Brackets
Type	Set
326B...	A326KM

Complete Set Unassembled	
Chain	End Brackets
Type	Set
326B...	A326K

\*\*\* Available on request in stainless steel

## 326B Nylon Sliding Cable Chain with un-screwable aluminium rods

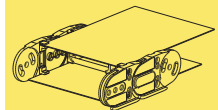
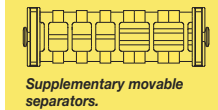

Special tool to remove the connecting pivots:  
Part Number PZ036.



For further information please consult Brevetti Standalto's Technical Office

## 328SU Nylon Sliding Cable Chain with opening frames

### Inner height (D) 57 mm

Strong double share Sideband & Frame construction with large anti-friction triple-pin. The chain incorporates large sliding-skid surfaces to offer durability, even with high speed/loads. Frames opening from inner radius and outer radius. As standard the chain comes with frames every second link, on request with frames every link. Modular separator systems are available.

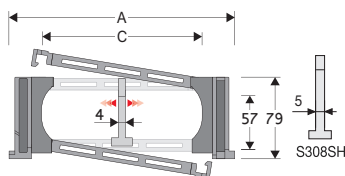

Separator	
- Unassembled	Part.no S308C
- Assembled	Part.no S308CMCI for chain opening outer radius
- Assembled	Part.no S308CMCE for chain opening inner radius
Strong-hold separator for C > 200 mm	
- Unassembled	Part.no S308SHF
- Assembled	Part.no S308SHMCI
- Assembled	Part.no S308SHMCE
Pin	
	Part.no PG328TP

### Technical characteristics

Speed	3,5 m/s
Acceleration	8 m/s <sup>2</sup>

For higher requirements please consult our technical dept.

A	B	C	D	R	Weight/m	Chain
mm	mm	mm	mm	mm	kg	Part Number
119	79	61	57	150-180-200-230-280-400	2,70	328SU061 □□□ *
130	79	72	57	150-180-200-230-280-400	2,73	328SU072 □□□ *
144	79	86	57	150-180-200-230-280-400	2,76	328SU086 □□□ *
150	79	92	57	150-180-200-230-280-400	2,78	328SU092 □□□ *
154	79	96	57	150-180-200-230-280-400	2,80	328SU096 □□□ *
164	79	106	57	150-180-200-230-280-400	2,82	328SU106 □□□ *
169	79	111	57	150-180-200-230-280-400	2,82	328SU111 □□□ *
176	79	118	57	150-180-200-230-280-400	2,82	328SU118 □□□ *
186	79	128	57	150-180-200-230-280-400	2,86	328SU128 □□□ *
194	79	136	57	150-180-200-230-280-400	2,89	328SU136 □□□ *
205	79	147	57	150-180-200-230-280-400	2,89	328SU147 □□□ *
219	79	161	57	150-180-200-230-280-400	2,94	328SU161 □□□ *
244	79	186	57	150-180-200-230-280-400	3,01	328SU186 □□□ *
269	79	211	57	150-180-200-230-280-400	3,06	328SU211 □□□ *
280	79	222	57	150-180-200-230-280-400	3,08	328SU222 □□□ *
294	79	236	57	150-180-200-230-280-400	3,14	328SU236 □□□ *
321	79	263	57	150-180-200-230-280-400	3,20	328SU263 □□□ *
330	79	272	57	150-180-200-230-280-400	3,20	328SU272 □□□ *
355	79	297	57	150-180-200-230-280-400	3,29	328SU297 □□□ *
381	79	323	57	150-180-200-230-280-400	3,31	328SU323 □□□ *
403	79	345	57	150-180-200-230-280-400	3,36	328SU345 □□□ *
431	79	373	57	150-180-200-230-280-400	3,49	328SU373 □□□ *

\*Complete the code by inserting the value of the radius (R): Ex. 328SU118 □□□ □□

Chain equipped with nylon frame every pitch: complete the code by inserting the letter D.  
Ex. 328SU118150 □□

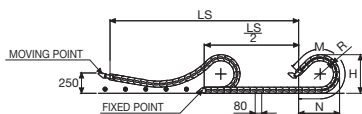

Length of chain (L)

Half travel distance ( $\frac{LS}{2}$ )

plus length of curve (M)

$$L = \frac{LS}{2} + M$$

R	H	N	M
mm	mm	mm	mm
150	379	425	955
180	439	530	1220
200	479	600	1395
230	539	700	1655
280	639	875	2095
400	879	1285	3145

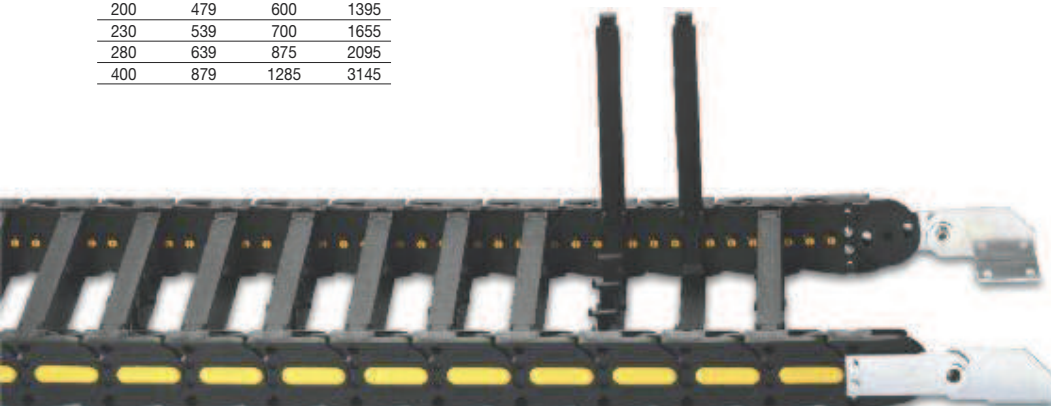

Version with frames mounted on every pitch.

### End Brackets

The end brackets set allows the two ends of the chain to be attached to the equipment. One set includes two pivoting end brackets to be installed at the moving point and two standard steel end brackets to be installed at the fixed point.

**Bright Zinc Plated Steel Movable Type\*\*\***  
**Bright Zinc Plated Steel Type\*\*\* (fixed point)**

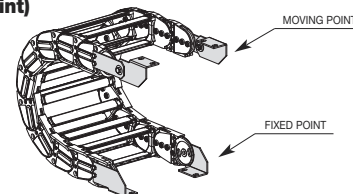
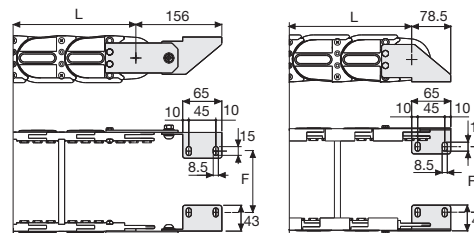

Fig. A  
Chain fixed outside the radius. (Fig A)



Chain Type	F mm
328SU061	44
328SU072	55
328SU086	69
328SU092	75
328SU096	79
328SU106	89
328SU111	94
328SU118	101
328SU128	111
328SU136	119
328SU147	130
328SU161	144
328SU186	169
328SU211	194
328SU222	205
328SU236	219
328SU263	246
328SU272	255
328SU297	280
328SU323	306
328SU345	328
328SU373	356

### Bright Zinc Plated Steel Type Part Numbers

Complete Set Assembled	Chain	End Brackets
Type	Set	
328SU...	A328KM	

Complete Set Unassembled	Chain	End Brackets
Type	Set	
328SU...	A328K	

\*\*\* Available on request in stainless steel

## 328SU Nylon Sliding Cable Chain with opening frames

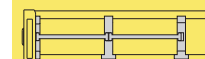

Separation System  
To choose the separators see page. 196

How to open the cover.

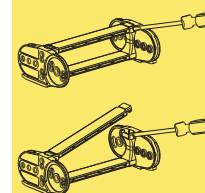

Special tool to remove the connecting pivots:  
Part Number PZ038.



For further information please consult Brevetti Stendalto's Technical Office





## 319ZE

### Nylon Sliding Cable Chain with opening frames

#### Inner height (D) 75,5 mm

Strong double share Sideband & Frame construction with large anti-friction triple pin. The chain features screwed-on interchangeable sliding skids to offer durability even with high speed and loads. Frames open from outer radius. As standard the chain comes with frames every second link, on request with frames every link. Modular separation systems are available.

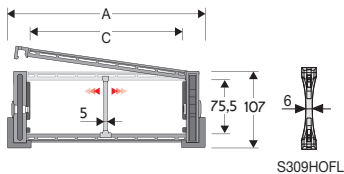

Separator	
- Unassembled	Part.no S309S/3178
- Assembled	Part.no S309/3178SMC
Strong-hold separator	
for C > 250 mm	
- Unassembled	Part.no S309HOFL
- Assembled	Part.no S309HOFLMC
Pin	
	Part.no PG329
Sliding skid	
	Part.no PAT329

#### Technical characteristics

Speed 4 m/s

Acceleration 13 m/s<sup>2</sup>

For higher requirements please consult our technical dept.

A	B	C	D	R	Weight/m	Chain
mm	mm	mm	mm	mm	kg	Part Number
148	107	84	75,5	200-250-300-350-400-500	4,53	319ZE084 □□□ *
173	107	109	75,5	200-250-300-350-400-500	4,61	319ZE109 □□□ *
180	107	116	75,5	200-250-300-350-400-500	4,64	319ZE116 □□□ *
203	107	139	75,5	200-250-300-350-400-500	4,71	319ZE139 □□□ *
243	107	179	75,5	200-250-300-350-400-500	4,84	319ZE179 □□□ *
278	107	214	75,5	200-250-300-350-400-500	4,95	319ZE214 □□□ *
304	107	240	75,5	200-250-300-350-400-500	5,04	319ZE240 □□□ *
328	107	264	75,5	200-250-300-350-400-500	5,11	319ZE264 □□□ *
354	107	290	75,5	200-250-300-350-400-500	5,19	319ZE290 □□□ *
378	107	314	75,5	200-250-300-350-400-500	5,27	319ZE314 □□□ *
404	107	340	75,5	200-250-300-350-400-500	5,34	319ZE340 □□□ *
428	107	364	75,5	200-250-300-350-400-500	5,43	319ZE364 □□□ *
483	107	419	75,5	200-250-300-350-400-500	5,64	319ZE419 □□□ *
552	107	488	75,5	200-250-300-350-400-500	5,85	319ZE488 □□□ *

\*Complete the code by inserting the value of the radius (R): Ex. 319ZE116 [2] [5] [0]  
Chain equipped with nylon frame every pitch: complete the code by inserting the letter D.  
Ex. 319ZE116250 [D]

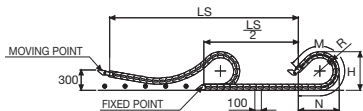

Length of chain (L)

Half travel distance ( $\frac{LS}{2}$ ) plus length of curve (M)

$$L = \frac{LS}{2} + M$$

R	H	N	M
mm	mm	mm	mm
200	506	595	1345
250	606	765	1780
300	706	940	2220
350	806	1110	2655
400	906	1280	3095
500	1106	1625	3970

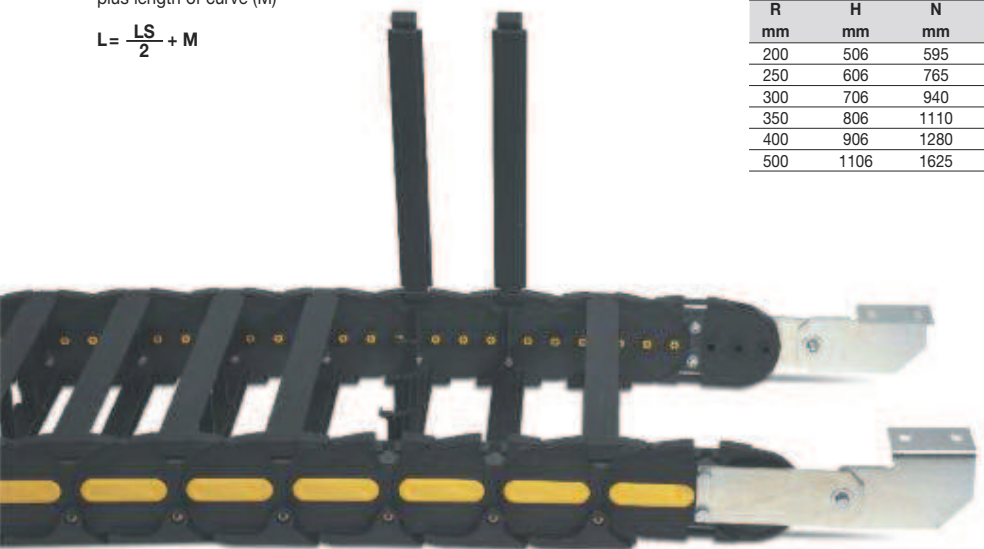

Version with frames mounted on every pitch.

#### End Brackets

The end brackets set allows the two ends of the chain to be attached to the equipment. One set includes two pivoting end brackets to be installed at the moving point and two standard steel end brackets to be installed at the fixed point.

#### Bright Zinc Plated Steel Movable Type\*\*\* (moving point)

#### Bright Zinc Plated Steel Type\*\*\* (fixed point)

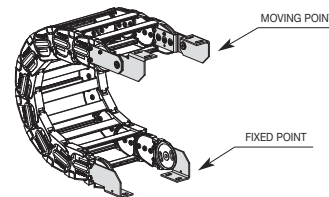
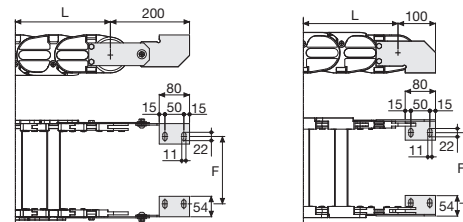

Fig. A  
Chain fixed outside the radius. (Fig A)



Chain Type	F mm
319ZE064	40
319ZE084	60
319ZE109	85
319ZE116	92
319ZE139	115
319ZE179	155
319ZE214	190
319ZE240	216
319ZE264	240
319ZE290	266
319ZE314	290
319ZE340	316
319ZE364	340
319ZE419	395
319ZE488	464

#### Bright Zinc Plated Steel Type Part Numbers

Complete Set Assembled	Chain	End Brackets
Type	Set	
319ZE...	A319KM	

Complete Set Unassembled	Chain	End Brackets
Type	Set	
319ZE...	A319K	

\*\*\* Available on request in stainless steel

## 319ZE Nylon Sliding Cable Chain with opening frames

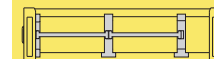

Separation System  
To choose the separators see page. 196

How to open the cover.

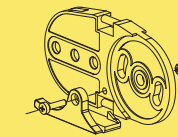
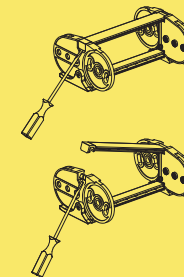

Sliding skid

For further information please consult Brevetti Stendalto's Technical Office

## 319B Nylon Sliding Cable Chain with un-screwable aluminium rods

**Inner height (D) 70 mm**  
Strong double share Sideband & Frame construction with large anti-friction triple pin. The chain features screwed-on interchangeable sliding skids to offer durability even with high speed and loads. Aluminium rods are removable from inner and outer radius side. As standard the chain comes with rods every second link, on request with rods every link. Separation systems are available.

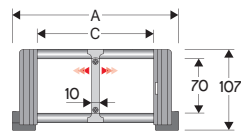

Separator	
- Unassembled	Part.no S309C
- Assembled	Part.no S309CMC
Pin	
	Part.no PG329
Sliding skid	
	Part.no PAT329

Technical characteristics	
Speed	4 m/s
Acceleration	13 m/s <sup>2</sup>

For higher requirements please consult our technical dept.

A	B	C	D	R	Weight/m	Chain
mm	mm	mm	mm	mm	kg	Part Number
164	107	100	70	200-250-300-350-400-500	4,25	319B100 □ *
214	107	150	70	200-250-300-350-400-500	4,45	319B150 □ *
264	107	200	70	200-250-300-350-400-500	4,60	319B200 □ *
314	107	250	70	200-250-300-350-400-500	4,75	319B250 □ *
364	107	300	70	200-250-300-350-400-500	4,90	319B300 □ *
464	107	400	70	200-250-300-350-400-500	5,25	319B400 □ *
C+64	107	.....	70	200-250-300-350-400-500		319B □ □ □ □ **

\*Complete the code by inserting the value of the radius (R): Ex. 319B150 □  
Where: 2=200; 3=250; 4=300; 5=350; 6=400; 7=500  
\*\*Complete the code by inserting the value of the quote C and the radius (R): Ex. 319B □ □ □ □ □  
Chain equipped with aluminium rods every pitch: complete the code by inserting the letter D.  
Ex. 319B1502 □

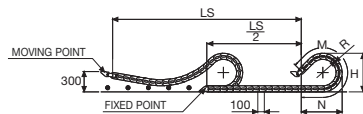

Length of chain (L)  
Half travel distance ( $\frac{LS}{2}$ )  
plus length of curve (M)

$$L = \frac{LS}{2} + M$$

R	H	N	M
mm	mm	mm	mm
200	506	595	1345
250	606	765	1780
300	706	940	2220
350	806	1110	2655
400	906	1280	3095
500	1106	1625	3970



Version with Alu-rods on every second pitch.

### End Brackets

The end brackets set allows the two ends of the chain to be attached to the equipment. One set includes two pivoting end brackets to be installed at the moving point and two standard steel end brackets to be installed at the fixed point.

**Bright Zinc Plated Steel Movable Type\*\*\* (moving point)**      **Bright Zinc Plated Steel Type\*\*\* (fixed point)**

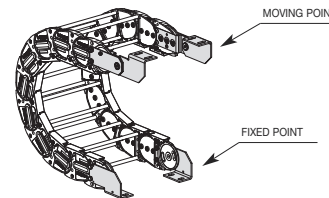
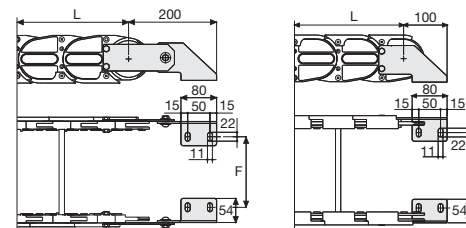

Fig. A  
Chain fixed outside the radius. (Fig A)



Chain	F
Type	mm
319B100	76
319B150	126
319B200	176
319B250	226
319B300	276
319B400	376

Special widths F=A-88

### Bright Zinc Plated Steel Type Part Numbers

Complete Set Assembled	
Chain	End Brackets
Type	Set
319B...	A319KM

Complete Set Unassembled	
Chain	End Brackets
Type	Set
319B...	A319K

\*\*\* Available on request in stainless steel

## 319B Nylon Sliding Cable Chain with un-screwable aluminium rods



Supplementary movable separators.

### Version with aluminium draw plates



On request available with aluminium draw plates

Example Part Number:  
319T □ □ □ □ □ □ □ □ \*\*

\* Inner width (C)  
\*\* Bending radius (R)

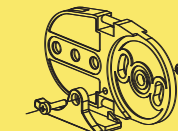

Sliding skid

For further information please consult Brevetti Stendalto's Technical Office

## 329B Nylon Sliding Cable Chain with un-screwable aluminium rods

### Inner height (D) 70 mm

Strong double share Sideband & Frame construction with large anti-friction triple-pin. The chain incorporates large sliding-skid surfaces to offer durability, even with high speed/loads. The Alu-rod frames are un-screwable from inner and outer radius. As standard the chain comes with frames every second link, on request with frames every link. Separator systems are available.

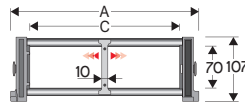

Separator	
- Unassembled	Part.no S309C
- Assembled	Part.no S309CMC
Pin	
	Part.no PG329

### Technical characteristics

Speed	3 m/s
Acceleration	13 m/s <sup>2</sup>

For higher requirements please consult our technical dept.

A	B	C	D	R	Weight/m	Chain
mm	mm	mm	mm	mm	kg	Part.no
164	107	100	70	150-200-250-300-350-400-500-600	4,25	329B100□□□*
214	107	150	70	150-200-250-300-350-400-500-600	4,45	329B150□□□*
264	107	200	70	150-200-250-300-350-400-500-600	4,60	329B200□□□*
314	107	250	70	150-200-250-300-350-400-500-600	4,75	329B250□□□*
364	107	300	70	150-200-250-300-350-400-500-600	4,90	329B300□□□*
464	107	400	70	150-200-250-300-350-400-500-600	5,25	329B400□□□*
C+64	107	.....	70	150-200-250-300-350-400-500-600		329B□□□□**

\*Complete the code by inserting the value of the radius (R): Ex. 329B150□□□□□

\*\*Complete the code by inserting the value of the quote C and the radius (R): Ex. 329B□□□□□□□□

Chain equipped with aluminium rods every pitch: complete the code by inserting the letter D.

Ex. 329B150200□□

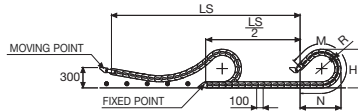

Length of chain (L)  
Half travel distance ( $\frac{LS}{2}$ )  
plus length of curve (M)

$$L = \frac{LS}{2} + M$$

R	H	N	M
mm	mm	mm	mm
150	406	415	905
200	506	595	1345
250	606	765	1780
300	706	940	2220
350	806	1110	2655
400	906	1280	3095
500	1106	1625	3970
600	1306	1965	4845

### End Brackets

The end brackets set allows the two ends of the chain to be attached to the equipment. One set includes two pivoting end brackets to be installed at the moving point and two standard steel end brackets to be installed at the fixed point.

### Bright Zinc Plated Steel Movable Type\*\*\* (moving point)

### Bright Zinc Plated Steel Type\*\*\* (fixed point)

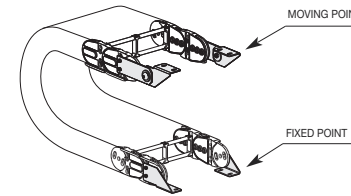
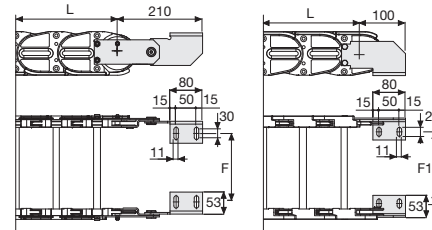

Fig. A  
Chain fixed outside the radius. (Fig A)



Chain Type	F mm	Chain Type	F1 mm
329B100	76	329B100	87
329B150	126	329B150	137
329B200	176	329B200	187
329B250	226	329B250	237
329B300	276	329B300	287
329B400	376	329B400	387

Special widths F=A-88      Special widths F1=A-77

### Bright Zinc Plated Steel Type Part Numbers

Complete Set Assembled	
Chain Type	End Brackets Set
329B...	A329BKM

Complete Set Unassembled	
Chain Type	End Brackets Set
329B...	A329BK

\*\*\* Available on request in stainless steel

## 329B Nylon Sliding Cable Chain with un-screwable aluminium rods



Supplementary movable separators.

For further information please consult Brevetti Standalto's Technical Office



# Serie Sliding

## 329SU Nylon Sliding Cable Chain with opening frames

**Inner height (D) 75,5 mm**  
Strong double share Sideband & Frame construction with large anti-friction triple-pin. The chain incorporates large sliding-skid surfaces to offer durability, even with high speed/loads. Frames are opening from inner radius or outer radius. Vertical separators are available

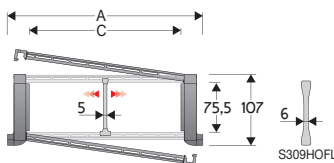

Separator	
- Unassembled	Part.no S309S/3178
- Assembled*	Part.no S309S/3178MCI
- Assembled**	Part.no S309S/3178MCE
Strong-hold separator	
for C > 250 mm	
- Unassembled	Part.no S309HOF
- Assembled*	Part.no S309HOFLMC
<b>Pin</b>	Part.no PG329

\* for chain opening outer radius  
\*\* for chain opening inner radius

### Technical characteristics

Speed	3 m/s
Acceleration	13 m/s <sup>2</sup>

For higher requirements please consult our technical dept.

A	B	C	D	R	Weight/m	Chain
mm	mm	mm	mm	mm	kg	Part Number
148	107	84	75,5	150-200-250-300-350-400-500-600	4,25	329SU084 □□□ *
173	107	109	75,5	150-200-250-300-350-400-500-600	4,33	329SU109 □□□ *
180	107	116	75,5	150-200-250-300-350-400-500-600	4,36	329SU116 □□□ *
203	107	139	75,5	150-200-250-300-350-400-500-600	4,43	329SU139 □□□ *
243	107	179	75,5	150-200-250-300-350-400-500-600	4,56	329SU179 □□□ *
278	107	214	75,5	150-200-250-300-350-400-500-600	4,67	329SU214 □□□ *
304	107	240	75,5	150-200-250-300-350-400-500-600	4,76	329SU240 □□□ *
328	107	264	75,5	150-200-250-300-350-400-500-600	4,83	329SU264 □□□ *
354	107	290	75,5	150-200-250-300-350-400-500-600	4,91	329SU290 □□□ *
378	107	314	75,5	150-200-250-300-350-400-500-600	4,99	329SU314 □□□ *
404	107	340	75,5	150-200-250-300-350-400-500-600	5,06	329SU340 □□□ *
428	107	364	75,5	150-200-250-300-350-400-500-600	5,15	329SU364 □□□ *
483	107	419	75,5	150-200-250-300-350-400-500-600	5,36	329SU419 □□□ *
552	107	488	75,5	150-200-250-300-350-400-500-600	5,57	329SU488 □□□ *

\*Complete the code by inserting the value of the radius (R); Ex. 329SU116 [2][5][0]  
Chain equipped with nylon frame every pitch: complete the code by inserting the letter D.  
Ex. 329SU116250 [D]

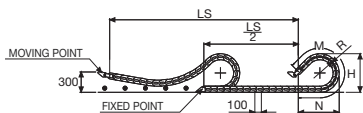

Length of chain (L)  
Half travel distance ( $\frac{LS}{2}$ )  
plus length of curve (M)

$$L = \frac{LS}{2} + M$$

R	H	N	M
mm	mm	mm	mm
150	406	415	905
200	506	595	1345
250	606	765	1780
300	706	940	2220
350	806	1110	2655
400	906	1280	3095
500	1106	1625	3970
600	1306	1965	4845

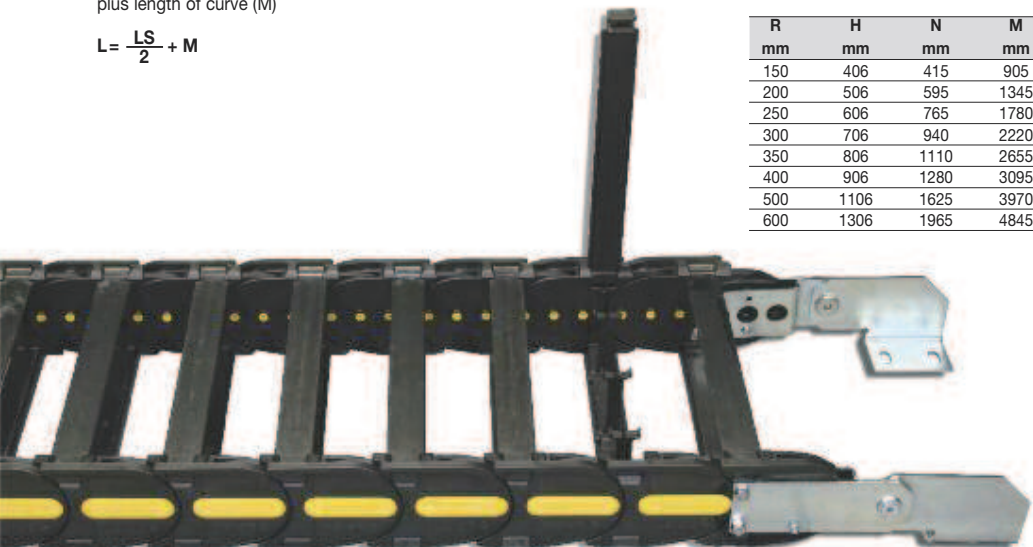

### End Brackets

The end brackets set allows the two ends of the chain to be attached to the equipment. One set includes two pivoting end brackets to be installed at the moving point and two standard steel end brackets to be installed at the fixed point.

**Bright Zinc Plated Steel Movable Type\*\*\* (moving point)**

**Bright Zinc Plated Steel Type\*\*\* (fixed point)**

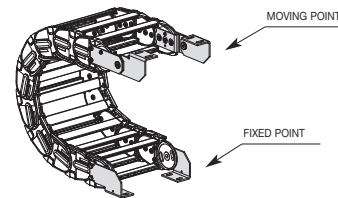
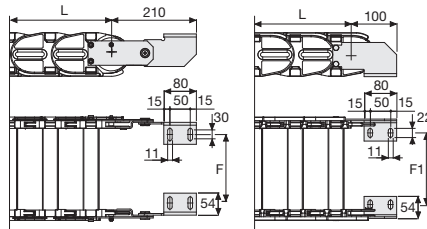

Fig. A  
Chain fixed outside the radius. (Fig A)



Chain Type	F mm
329SU084	60
329SU109	85
329SU116	92
329SU139	115
329SU179	155
329SU214	190
329SU240	216
329SU264	240
329SU290	266
329SU314	290
329SU340	316
329SU364	340
329SU419	395
329SU488	464

Chain Type	F1 mm
329SU084	71
329SU109	96
329SU116	103
329SU139	126
329SU179	166
329SU214	201
329SU240	227
329SU264	251
329SU290	277
329SU314	301
329SU340	327
329SU364	351
329SU419	406
329SU488	475

### Bright Zinc Plated Steel Type Part Numbers

Complete Set Assembled	Chain	End Brackets
Type	Set	Set
329SU..	A329SU□□□*K	M

Complete Set Unassembled	Chain	End Brackets
Type	Set	Set
329SU..	A329SU□□□*K	M

\* Inner width (C)  
\*\*\* Available on request in stainless steel

### Serie Sliding

## 329SU Nylon Sliding Cable Chain with opening frames

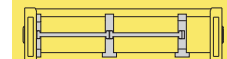

Separation System  
To choose the separators see page. 196

### How to open the cover

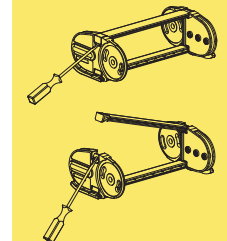

For further information please consult Brevetti Stendalto's Technical Office

## 329CD Nylon Sliding Cable Chain with opening aluminium covers

### Inner height (D) 75,5 mm

Strong double share Sideband & Frame construction with large anti-friction triple-pin. The chain incorporates large sliding-skid surfaces to offer durability, even with high speed/loads. Aluminium covers are opening from inner radius or outer radius.

Vertical separators are available

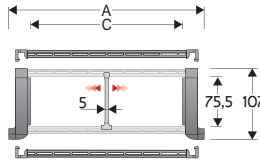

### Separator

- Unassembled	Part.no S309S/3178
- Assembled	Part.no S309S/3178MCI for chain opening outer radius
- Assembled	Part.no S309S/3178MCE for chain opening inner radius
<b>Pin</b>	Part.no PG329

### Technical characteristics

Speed	3 m/s
Acceleration	13 m/s <sup>2</sup>

For higher requirements please consult our technical dept.

A	B	C	D	R	Weight/m	Chain
mm	mm	mm	mm	mm	kg	Part Number
148	107	84	75,5	200-250-300-350-400-500-600	5,70	329CD084 □□□ *
173	107	109	75,5	200-250-300-350-400-500-600	6,11	329CD109 □□□ *
180	107	116	75,5	200-250-300-350-400-500-600	6,24	329CD116 □□□ *
203	107	139	75,5	200-250-300-350-400-500-600	6,62	329CD139 □□□ *
243	107	179	75,5	200-250-300-350-400-500-600	7,33	329CD179 □□□ *
278	107	214	75,5	200-250-300-350-400-500-600	7,96	329CD214 □□□ *
304	107	240	75,5	200-250-300-350-400-500-600	8,40	329CD240 □□□ *
328	107	264	75,5	200-250-300-350-400-500-600	8,80	329CD264 □□□ *
354	107	290	75,5	200-250-300-350-400-500-600	9,26	329CD290 □□□ *
378	107	314	75,5	200-250-300-350-400-500-600	9,68	329CD314 □□□ *
404	107	340	75,5	200-250-300-350-400-500-600	10,12	329CD340 □□□ *
428	107	364	75,5	200-250-300-350-400-500-600	10,55	329CD364 □□□ *
483	107	419	75,5	200-250-300-350-400-500-600	11,73	329CD419 □□□ *
552	107	488	75,5	200-250-300-350-400-500-600	12,91	329CD488 □□□ *

\*Complete the code by inserting the value of the radius (R): Ex. 329CD116 [2] [5] [0]

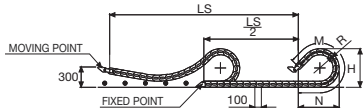

Length of chain (L)

Half travel distance ( $\frac{LS}{2}$ )  
plus length of curve (M)

$$L = \frac{LS}{2} + M$$

R	H	N	M
mm	mm	mm	mm
200	506	595	1345
250	606	765	1780
300	706	940	2220
350	806	1110	2655
400	906	1280	3095
500	1106	1625	3970
600	1306	1965	4845

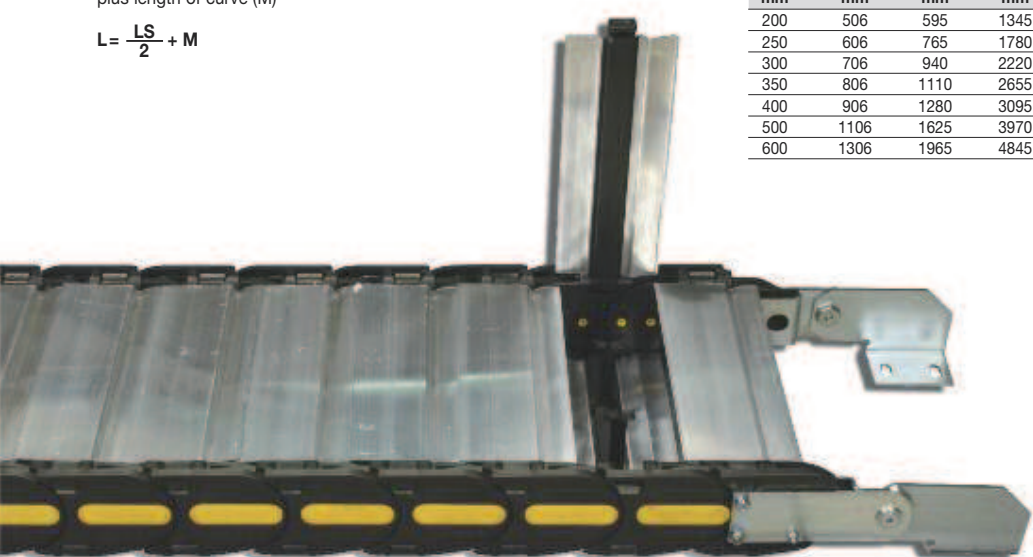

### End Brackets

The end brackets set allows the two ends of the chain to be attached to the equipment. One set includes two pivoting end brackets to be installed at the moving point and two standard steel end brackets to be installed at the fixed point.

### Bright Zinc Plated Steel Movable Type\*\*\* (moving point)

### Bright Zinc Plated Steel Type\*\*\* (fixed point)

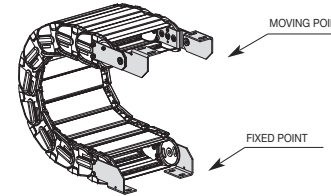
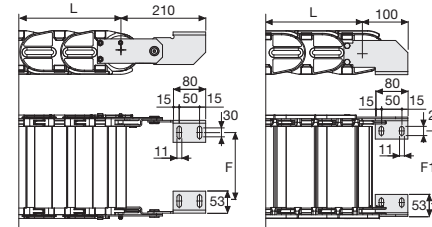

Fig. A  
Chain fixed outside the radius. (Fig A)



Chain Type	F mm	Chain Type	F1 mm
329CD084	60	329CD084	71
329CD109	85	329CD109	96
329CD116	92	329CD116	103
329CD139	115	329CD139	126
329CD179	155	329CD179	166
329CD214	190	329CD214	201
329CD240	216	329CD240	227
329CD264	240	329CD264	251
329CD290	266	329CD290	277
329CD314	290	329CD314	301
329CD340	316	329CD340	327
329CD364	340	329CD364	351
329CD419	395	329CD419	406
329CD488	464	329CD488	475

### Bright Zinc Plated Steel Type Part Numbers

Complete Set Assembled	Chain	End Brackets
Type	Set	Set
329CD..	A329CD□□□*KM	

Complete Set Unassembled	Chain	End Brackets
Type	Set	Set
329CD..	A329CD□□□*K	

\* Inner width (C)

\*\*\* Available on request in stainless steel

## 329CD Nylon Sliding Cable Chain with opening aluminium covers

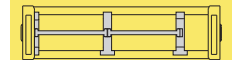

Separation System  
To choose the separators see page. 196

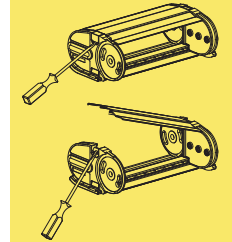

How to open the cover

For further information please consult Brevetti Stendalto's Technical Office

## 478MU

### Nylon Cable Chain with opening frames

#### Inner height (D) 75,5 mm

Sideband & Frame construction with large anti-friction single-pin.

As standard the chain comes with frames every second link, on request with frames every link.

Modular separator systems are available

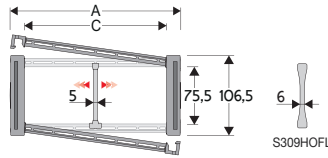

Separator	
- Unassembled	Part.no S309S/3178
- Assembled*	Part.no S309S/3178MCI
- Assembled**	Part.no S309S/3178MCE
Strong-hold separator	
for C > 250 mm	
- Unassembled	Part.no S309HOFL
- Assembled	Part.no S309HOFLMC
Pin	
	Part.no PG475

\* for chain opening outer radius  
\*\* for chain opening inner radius

#### Technical characteristics

Speed	3 m/s
Acceleration	8 m/s <sup>2</sup>

For higher requirements please consult our technical dept.

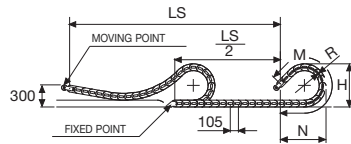

Length of chain (L)

Half travel distance ( $\frac{LS}{2}$ )

plus length of curve (M)

$$L = \frac{LS}{2} + M$$

R	H	N	M
mm	mm	mm	mm
180	466,5	495	1155
200	506,5	570	1330
250	606,5	745	1765
300	706,5	920	2205
350	806,5	1090	2640
400	906,5	1265	3080

A	B	C	D	R	Weight/m	Chain
mm	mm	mm	mm	mm	kg	Part number
112	106,5	74	75,5	180-200-250-300-350-400	3,70	478MU074 □□□ *
132	106,5	94	75,5	180-200-250-300-350-400	3,80	478MU094 □□□ *
157	106,5	119	75,5	180-200-250-300-350-400	3,85	478MU119 □□□ *
164	106,5	126	75,5	180-200-250-300-350-400	3,90	478MU126 □□□ *
187	106,5	149	75,5	180-200-250-300-350-400	3,95	478MU149 □□□ *
227	106,5	189	75,5	180-200-250-300-350-400	4,05	478MU189 □□□ *
262	106,5	224	75,5	180-200-250-300-350-400	4,15	478MU224 □□□ *
288	106,5	250	75,5	180-200-250-300-350-400	4,25	478MU250 □□□ *
312	106,5	274	75,5	180-200-250-300-350-400	4,30	478MU274 □□□ *
338	106,5	300	75,5	180-200-250-300-350-400	4,37	478MU300 □□□ *
362	106,5	324	75,5	180-200-250-300-350-400	4,45	478MU324 □□□ *
388	106,5	350	75,5	180-200-250-300-350-400	4,55	478MU350 □□□ *
412	106,5	374	75,5	180-200-250-300-350-400	4,60	478MU374 □□□ *
467	106,5	429	75,5	180-200-250-300-350-400	4,80	478MU429 □□□ *
536	106,5	498	75,5	180-200-250-300-350-400	5,00	478MU498 □□□ *

\* Complete the code by inserting the value of the radius (R): Ex. 478MU119 □ □ □ □ □  
Chain equipped with nylon frame every pitch: complete the code by inserting the letter D.  
478MU119150 □

#### End Brackets

The end brackets set allows the two ends of the chain to be attached to the equipment. One set includes two pivoting end brackets to be installed at the moving point and two standard steel end brackets to be installed at the fixed point.

**Bright Zinc Plated Steel Movable Type\*\*\***     **Bright Zinc Plated Steel Type\*\*\* (moving point) (fixed point)**

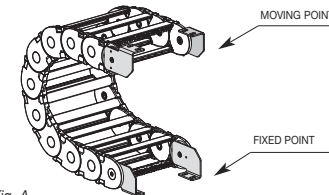
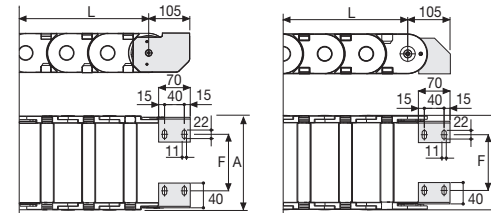

Fig. A  
Chain fixed outside the radius. (Fig A)



Chain Type	F mm
478MU074	35
478MU094	55
478MU119	80
478MU126	87
478MU149	110
478MU189	150
478MU224	185
478MU250	211
478MU274	235
478MU300	261
478MU324	285
478MU350	311
478MU374	335
478MU467	390
478MU498	459

#### Bright Zinc Plated Steel Type Part Numbers

Complete Set Assembled Chain Type	End Brackets Set
478MU	A478M□□□*KM

Complete Set Unassembled Chain Type	End Brackets Set
478MU.	A478M□□□*K

Tiewrap Clamp	Part Number
Assembled	CFC478M□□□*KM
Unassembled	CFC478M□□□*K

\* Inner width (C)  
\*\*\* Available on request in stainless steel

## 478MU

Nylon Cable Chain with opening frames

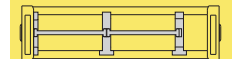

Separation System  
To choose the separators see page. 196

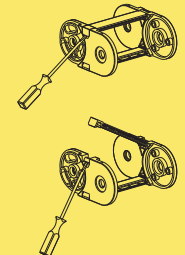

How to open the cover.

For further information please consult Brevetti Stendalto's Technical Office



## 478PU Nylon Cable Chain with opening frames

### Inner height (D) 75,5 mm

Sideband & Frame construction with large anti-friction single-pin.

Covers are opening from inner radius or from outer radius. Vertical and horizontal modular separator system are available.

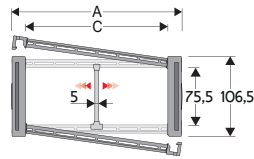

Separator	
- Unassembled	Part.no S309S/3178
- Assembled*	Part.no S309S/3178MCI
- Assembled**	Part.no S309S/3178MCE
Pin	
	Part.no PG475

\* for chain opening outer radius  
\*\* for chain opening inner radius

### Technical characteristics

Speed	3 m/s
Acceleration	8 m/s <sup>2</sup>

For higher requirements please consult our technical dept.

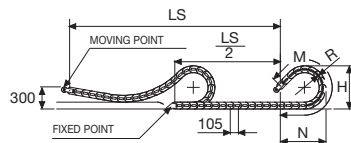

Length of chain (L)

Half travel distance ( $\frac{LS}{2}$ )

plus length of curve (M)

$$L = \frac{LS}{2} + M$$

R	H	N	M
mm	mm	mm	mm
180	466,5	495	1155
200	506,5	570	1330
250	606,5	745	1765
300	706,5	920	2205
350	806,5	1090	2640
400	906,5	1265	3080

A	B	C	D	R	Weight/m	Chain
mm	mm	mm	mm	mm	kg	Part number
112	106,5	74	75,5	180-200-250-300-350-400	4,60	478PU074 □□□ *
132	106,5	94	75,5	180-200-250-300-350-400	4,80	478PU094 □□□ *
157	106,5	119	75,5	180-200-250-300-350-400	5,10	478PU119 □□□ *
164	106,5	126	75,5	180-200-250-300-350-400	5,15	478PU126 □□□ *
187	106,5	149	75,5	180-200-250-300-350-400	5,40	478PU149 □□□ *
227	106,5	189	75,5	180-200-250-300-350-400	5,80	478PU189 □□□ *
262	106,5	224	75,5	180-200-250-300-350-400	6,20	478PU224 □□□ *
288	106,5	250	75,5	180-200-250-300-350-400	6,50	478PU250 □□□ *
312	106,5	274	75,5	180-200-250-300-350-400	6,75	478PU274 □□□ *
338	106,5	300	75,5	180-200-250-300-350-400	7,05	478PU300 □□□ *
362	106,5	324	75,5	180-200-250-300-350-400	7,30	478PU324 □□□ *
388	106,5	350	75,5	180-200-250-300-350-400	7,55	478PU350 □□□ *
412	106,5	374	75,5	180-200-250-300-350-400	7,85	478PU374 □□□ *
467	106,5	429	75,5	180-200-250-300-350-400	8,50	478PU429 □□□ *
536	106,5	498	75,5	180-200-250-300-350-400	9,20	478PU498 □□□ *

\*Complete the code by inserting the value of the radius (R): Ex. 478PU119 □□□ □□

### End Brackets

The end brackets set allows the two ends of the chain to be attached to the equipment. One set includes two pivoting end brackets to be installed at the moving point and two standard steel end brackets to be installed at the fixed point.

**Bright Zinc Plated Steel Movable Type\*\*\***     **Bright Zinc Plated Steel Type\*\*\* (moving point) (fixed point)**

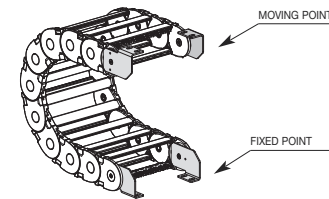
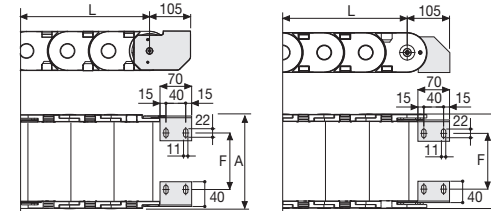

Fig. A Chain fixed outside the radius. (Fig A)



Chain Type	F mm
478PU074	35
478PU094	55
478PU119	80
478PU126	87
478PU149	110
478PU189	150
478PU224	185
478PU250	211
478PU274	235
478PU300	261
478PU324	285
478PU350	311
478PU374	335
478PU429	390
478PU498	459

### Bright Zinc Plated Steel Type Part Numbers

Complete Set Assembled	End Brackets
Chain	Set
478PU...	A478P□□□*KM

Complete Set Unassembled	End Brackets
Chain	Set
478PU...	A478P□□□*K

Tiewrap Clamp	Part Number
Assembled	CFC478M□□□*KM
Unassembled	CFC478M□□□*K

\* Inner width (C)  
\*\*\* Available on request in stainless steel

## 478PU Nylon Cable Chain with opening frames

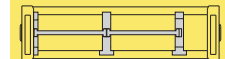

Separation System  
To choose the separators see page. 196

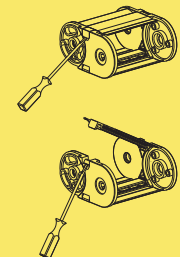

How to open the cover.

For further information please consult Brevetti Stendalto's Technical Office

## 60PU/R1

### Nylon Cable Chain with opening frames

**Inner height (D) 60,5 mm**  
Sideband & Frame construction with large anti-friction single-pin. Frames opening from inner and outer radius.

As standard the chain comes with frames every second link, on request with frames every link. Vertical separators are available

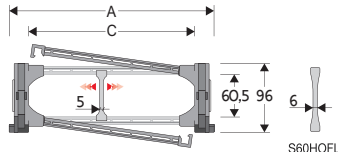

Separator	
- Unassembled	Part.no S60SMF
- Assembled	Part.no S60SMFMC
Strong-hold separator	
for C > 250 mm	
- Unassembled	Part.no S60HOFL
- Assembled	Part.no S60HOFLMC
Pin	
Part.no PNE60-PNI60	

#### Technical characteristics

Speed	5 m/s
Acceleration	13 m/s <sup>2</sup>

For higher requirements please consult our technical dept.

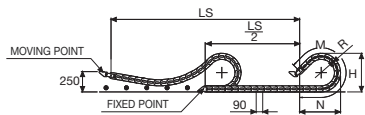

Length of chain (L)

Half travel distance ( $\frac{LS}{2}$ )

plus length of curve (M)

$$L = \frac{LS}{2} + M$$

R	H	N	M
mm	mm	mm	mm
200	490	715	1625
250	590	925	2130
300	690	1130	2635
400	890	1550	3645

A	B	C	D	R	Weight/m	Chain
mm	mm	mm	mm	mm	kg	Part number
169	96	115	60,5	200-250-300-400	5,37	60PU115 □□□ *
189	96	135	60,5	200-250-300-400	5,46	60PU135 □□□ *
214	96	160	60,5	200-250-300-400	5,52	60PU160 □□□ *
221	96	167	60,5	200-250-300-400	5,54	60PU167 □□□ *
244	96	190	60,5	200-250-300-400	5,61	60PU190 □□□ *
284	96	230	60,5	200-250-300-400	5,77	60PU230 □□□ *
319	96	265	60,5	200-250-300-400	5,91	60PU265 □□□ *
345	96	291	60,5	200-250-300-400	5,99	60PU291 □□□ *
369	96	315	60,5	200-250-300-400	6,07	60PU315 □□□ *
395	96	341	60,5	200-250-300-400	6,17	60PU341 □□□ *
419	96	365	60,5	200-250-300-400	6,26	60PU365 □□□ *
445	96	391	60,5	200-250-300-400	6,34	60PU391 □□□ *
469	96	415	60,5	200-250-300-400	6,43	60PU415 □□□ *
524	96	470	60,5	200-250-300-400	6,75	60PU470 □□□ *
593	96	539	60,5	200-250-300-400	7,08	60PU539 □□□ *

\*Complete the code by inserting the value of the radius (R): Ex. 60PU115 □ □ □ □ □

Chain equipped with nylon frame every pitch: complete the code by inserting the letter D. 60PU115250 □ □

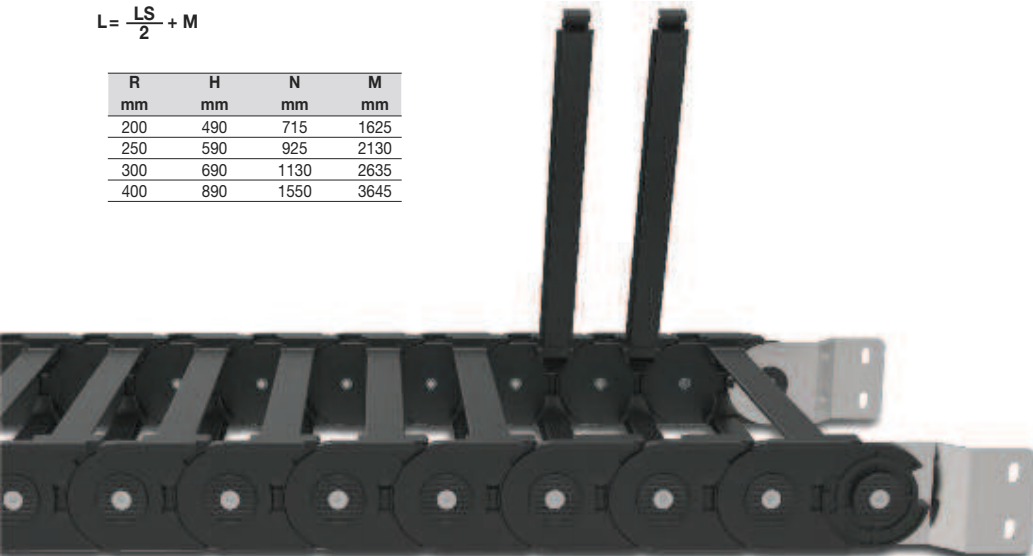

Version with frames mounted on every pitch.

#### End Brackets

The end brackets set allows the two ends of the chain to be attached to the equipment. One set includes two pivoting end brackets to be installed at the moving point and two standard steel end brackets to be installed at the fixed point.

**Bright Zinc Plated Steel Movable Type\*\*\***     **Bright Zinc Plated Steel Type\*\*\* (moving point) (fixed point)**

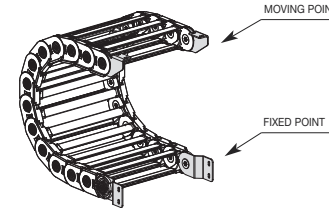
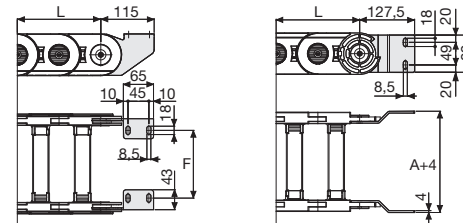

Fig. A  
Chain fixed outside the radius. (Fig A)



Chain Type	F mm
60PU115	95
60PU135	115
60PU160	140
60PU167	147
60PU190	170
60PU230	210
60PU265	245
60PU291	271
60PU315	295
60PU341	321
60PU365	345
60PU391	371
60PU415	395
60PU470	450
60PU539	519

#### Bright Zinc Plated Steel Type Part Numbers

Complete Set Assembled	
Chain	End Brackets
Type	Set
60PU...	A60PKM□*

Complete Set Unassembled	
Chain	End Brackets
Type	Set
60PU...	A60PK□*

\* 1=Pos.1; 2=Pos.2; 3=Pos.3

\*\*\* Available on request in stainless steel

## 60PU Nylon Cable Chain with opening frames

## 60R1 Nylon cables chain with I-Roller system

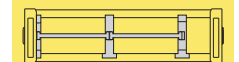
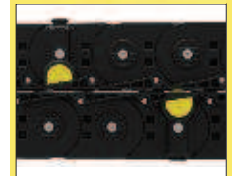

Separation System  
To choose the separators see page. 196

How to open the cover.

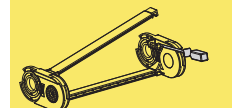
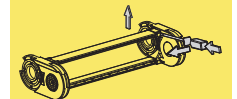

For further information please consult Brevetti Standalto's Technical Office

## 80PU/R1

### Nylon Cable Chain with opening frames

#### Inner height (D) 80,5 mm

Strong double share Sideband & Frame construction with large anti-friction single pin. The chain features screwed-on interchangeable sliding skids to offer durability even with high speed and loads. Frames opening from inner and outer radius. As standard the chain comes with frames every second link, on request with frames every link.

Separation systems are available.

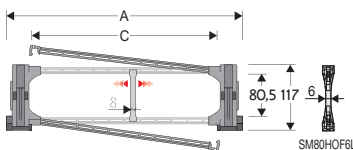

Separator	
- Unassembled	Part.no S80F
- Assembled*	Part.no S80FMCI
- Assembled**	Part.no S80FMCE
Strong-hold separator for C > 250 mm	
- Unassembled	Part.no SM80HOF6L
- Assembled	Part.no SM80HOF6LMC
Pin	
	Part.no PNE80-PNI80
Sliding skid	
	Part.no PAT80

\* for chain opening outer radius  
\*\* for chain opening inner radius

#### Technical characteristics

Speed	5 m/s
Acceleration	13 m/s <sup>2</sup>

For higher requirements please consult our technical dept.

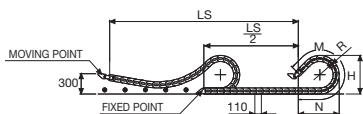

Length of chain (L)

Half travel distance ( $\frac{LS}{2}$ )  
plus length of curve (M)

$$L = \frac{LS}{2} + M$$

R	H	N	M
mm	mm	mm	mm
200	510	695	1555
250	610	905	2060
300	710	1115	2565
400	910	1530	3575
500	1110	1945	4580
700	1510	2785	6600

A	B	C	D	R	Weight/m	Chain
mm	mm	mm	mm	mm	kg	Part number
195	117	115	80,5	200-250-300-400-500-700	8,60	80PU115 □□□ *
215	117	135	80,5	200-250-300-400-500-700	8,67	80PU135 □□□ *
240	117	160	80,5	200-250-300-400-500-700	8,73	80PU160 □□□ *
247	117	167	80,5	200-250-300-400-500-700	8,75	80PU167 □□□ *
270	117	190	80,5	200-250-300-400-500-700	8,80	80PU190 □□□ *
310	117	230	80,5	200-250-300-400-500-700	8,93	80PU230 □□□ *
345	117	265	80,5	200-250-300-400-500-700	9,05	80PU265 □□□ *
371	117	291	80,5	200-250-300-400-500-700	9,11	80PU291 □□□ *
395	117	315	80,5	200-250-300-400-500-700	9,17	80PU315 □□□ *
421	117	341	80,5	200-250-300-400-500-700	9,25	80PU341 □□□ *
445	117	365	80,5	200-250-300-400-500-700	9,33	80PU365 □□□ *
471	117	391	80,5	200-250-300-400-500-700	9,40	80PU391 □□□ *
495	117	415	80,5	200-250-300-400-500-700	9,47	80PU415 □□□ *
550	117	470	80,5	200-250-300-400-500-700	9,75	80PU470 □□□ *
619	117	539	80,5	200-250-300-400-500-700	10,00	80PU539 □□□ *

\*Complete the code by inserting the value of the radius (R): Ex. 80PU115 □ □ □ □

Chain equipped with nylon frame every pitch: complete the code by inserting the letter D.  
80PU115250 □ □

#### End Brackets

The end brackets set allows the two ends of the chain to be attached to the equipment. One set includes two pivoting end brackets to be installed at the moving point and two standard steel end brackets to be installed at the fixed point.

**Bright Zinc Plated Steel Movable Type\*\*\*** (moving point)  
**Bright Zinc Plated Steel Type\*\*\*** (fixed point)

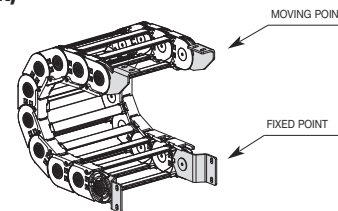
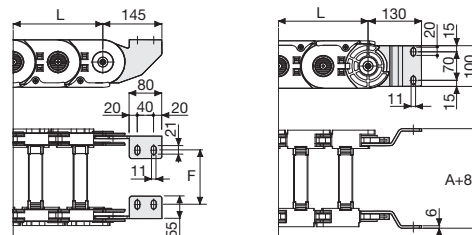

Fig. A  
Chain fixed outside the radius. (Fig A)



Chain Type	F mm
80PU115	92
80PU135	112
80PU160	137
80PU167	144
80PU190	167
80PU230	207
80PU265	242
80PU291	268
80PU315	292
80PU341	318
80PU365	342
80PU391	368
80PU415	392
80PU470	447
80PU539	516

#### Bright Zinc Plated Steel Type Part Numbers

Complete Set Assembled Chain	End Brackets Set
80PU...	A80PKM□*

Complete Set Unassembled Chain	End Brackets Set
80PU...	A80PK□*

\* 1=Pos.1; 2=Pos.2; 3=Pos.3

\*\*\* Available on request in stainless steel

## 80PU Nylon Cable Chain with opening frames

Separation System  
To choose the separators see page. 196

## 80R1 Nylon cables chain with I-Roller system



How to open the cover.

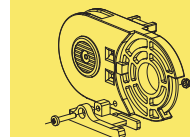
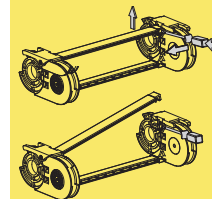

Sliding skid

For further information please consult Brevetti Stendalto's Technical Office



## Guide Channel

445-660A-770A-326-328-20P-30P-60-H45-H57

Special guide channel allows the use of the chain for long travel distance. Available in galvanised steel and, on request, in stainless steel.

### Single Chain Application

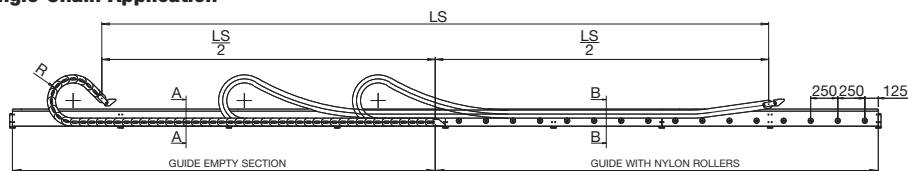

### Double Chain Application

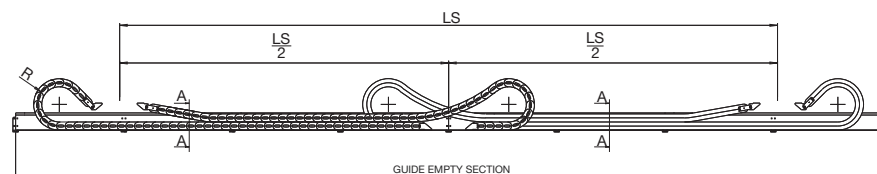

Channel guide is available in assembling kit composed by:  
 side walls 2 m standard length  
 joining and support plates  
 fixing screws  
 base  
 sliding device (nylon wheel/steel or plastic plate)

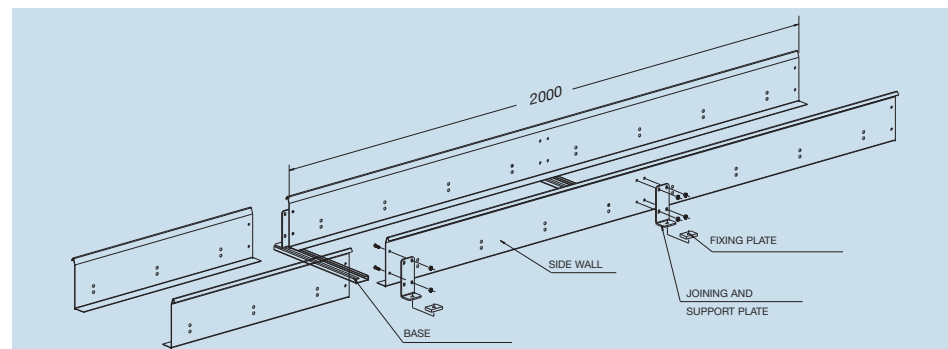

### Empty Guide Section

Section A-A

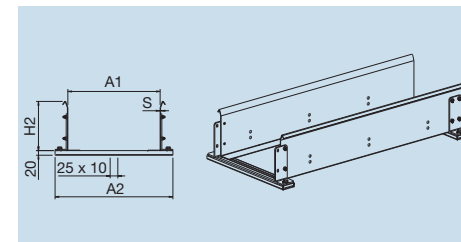

#### Part Number

CS326...

How to order

Chain part number **326B100150**

Guide channel part number **CS326B100**

### Serie Sliding

Chain	H2	H1
mm	mm	mm
445	160	64
660A	160	59
326	160	59
770A	160	79
328	160	79
60	190	96
H57	190	96
20P	160	59
30P	190	81,5
H45	160	79

### Guide with Nylon Rollers

Section B-B

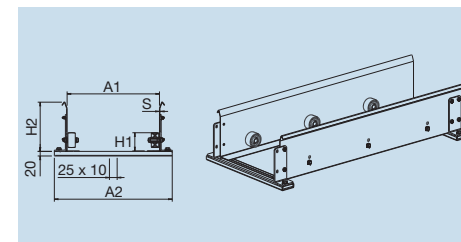

#### Part Number

CR326...

How to order

Chain part number **326B100150**

Guide channel part number **CR326B100**

Chain	S	A1	A2
mm	mm	mm	mm
445	1,5	A+4	A+87
H45	1,5	A+4	A+87
H57	1,5	A+4	A+87
660A	1,5	A+4	A+87
326	1,5	A+4	A+87
770A	1,5	A+4	A+87
328	1,5	A+4	A+87
60	1,5	A+4	A+87
20P	1,5	A+4	A+87
30P	2	A+4	A+88

### Guide with Steel Sliding Plate

Section B-B

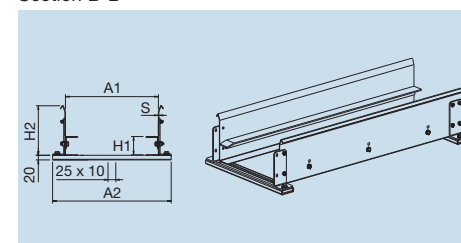

#### Part Number

CA326...

How to order

Chain part number **326B100150**

Guide channel part number **CA326B100**

### Guide with Plastic Sliding Plate

Section B-B

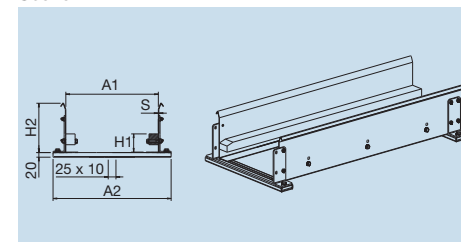

#### Part Number

CP326...

How to order

Chain part number **326B100150**

Guide channel part number **CP326B100**

For further information please consult Brevetti Stendalto's Technical Office

## Guide Channel

### 478-319-329-80-35P-35PC-40P-H80-H110

Special guide channel allows the use of the chain for long travel distance  
Available in galvanised steel and, on request, in stainless steel.

#### Single Chain Application

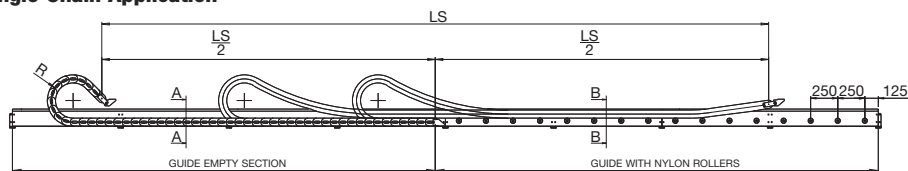

#### Double Chain Application

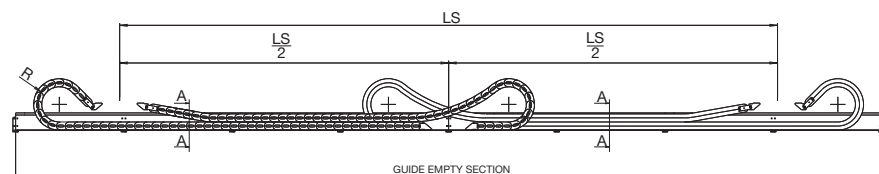

Channel guide is available in assembling kit composed by:  
side walls 2 m standard length  
joining and support plates  
fixing screws  
base  
sliding device (nylon wheel/steel or plastic plate)

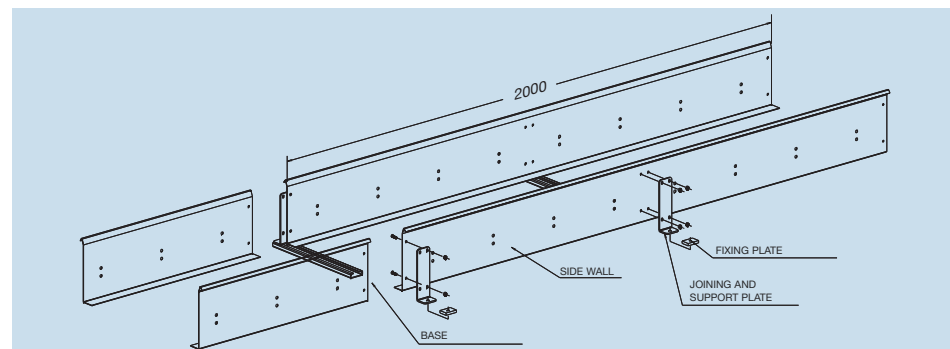

#### Empty Guide Section

Section A-A

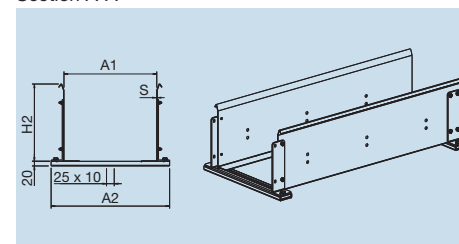

#### Part Number

CS319...  
How to order  
Chain part number 319B100200  
Guide channel part number CS319B100

#### Guide with Nylon Rollers

Section B-B

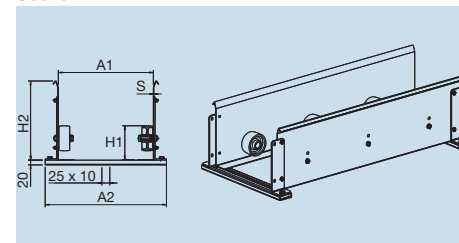

#### Part Number

CR319...  
How to order  
Chain part number 319B100200  
Guide channel part number CR319B100

#### Guide with Steel Sliding Plate

Section B-B

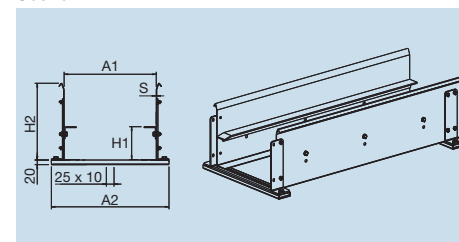

#### Part Number

CA319...  
How to order  
Chain part number 319B100200  
Guide channel part number CA319B100

#### Guide with Plastic Sliding Plate

Section B-B

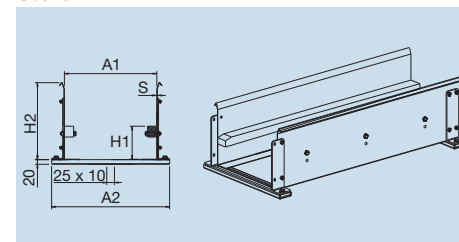

#### Part Number

CP319...  
How to order  
Chain part number 319B100200  
Guide channel part number CP319B100

# Serie Sliding

Chain	H2	H1
mm	mm	mm
319	250	107
329	250	107
80	250	117
35P	250	107
35CP	250	107
40	325	161,5
478	250	107
H80	250	117
H110	324	155

Chain	S	A1	A2
mm	mm	mm	mm
319	1,5	A+8	A+91
329	1,5	A+8	A+91
80	2	A+8	A+92
35P	2	A+8	A+92
35CP	2	A+8	A+92
40	3	A+8	A+94
478	1,5	A+8	A+91
H80	2	A+8	A+92
H110	2,5	A+8	A+93

## Aluminium Guide Channel

### 326-328-60-H57

Special aluminium guide channel allows the use of the chain for long travel distance.

#### Single Chain Application

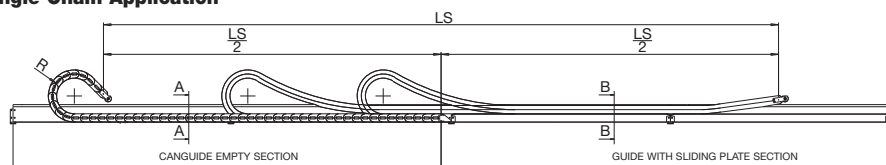

#### Double Chain Application

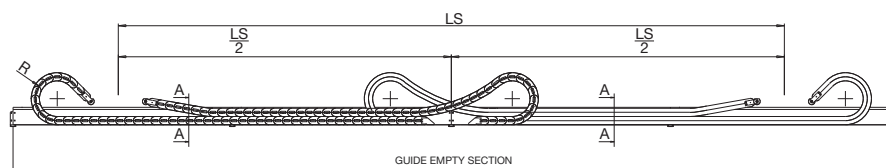

Channel guide is available in kit composed by:

- side walls 2 m standard length
- joining and fixing plates
- fixing screws
- base profile
- supporting parts ( nylon wheels or plastic support plate )

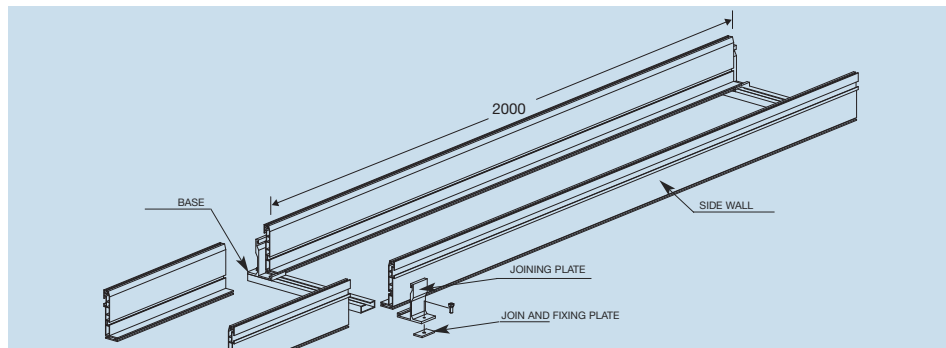

#### Empty Guide Section

Section A-A

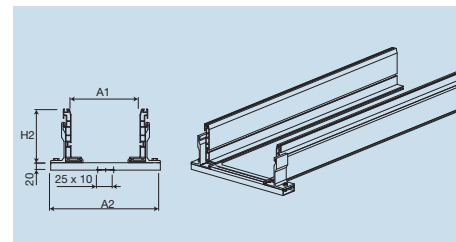

#### Part Number

CSA326...	
How to order	
Chain part number	326B100150
Guide channel part number	CSA326B100

#### CSA60...

Chain part number	60PI391250
Guide channel part number	CSA60-391

#### Guide with Nylon Rollers

Section B-B

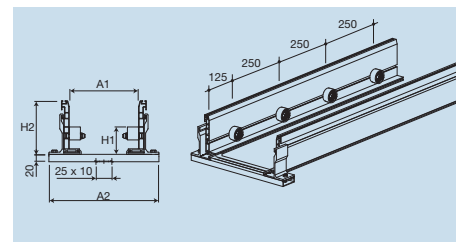

#### Part Number

CRA326...	
How to order	
Chain part number	326B100150
Guide channel part number	CRA326B100

#### CRA60...

Chain part number	60PI391250
Guide channel part number	CRA60-391

#### Guide with Plastic Sliding Plate

Section B-B

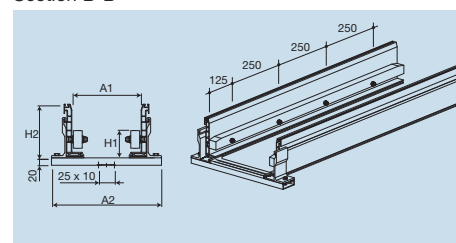

#### Part Number

CPA326...	
How to order	
Chain part number	326B100150
Guide channel part number	CPA326B100

#### CPA60...

Chain part number	60PI391250
Guide channel part number	CPA60-391

Chain	H2	H1
	mm	mm
326	145	59
328	200	79
60	200	96
H57	200	96

Chain	A1	A2
	mm	mm
326	A+4	A+114
328	A+4	A+114
60	A+4	A+114
H57	A+4	A+114



## Nylon Cable Chains Robot Series

495 Series	page 186
500 Series	page 188
510TN Series	page 190
515TN Series	page 190
545 Series	page 192
599 Series	page 194



*Quickly removable covers for easy installation of the cables/hoses*

*Internal separations for the subdivisions of the cables/hoses*



*Double pin; high strength in every condition*

*Support guide for a correct functioning of the chain*

*Inner surface without edges*

*Special end brackets will ensure a perfect fitting of the chain*

**3**

# 495

## Circular Nylon Cable Chain with removable frames

### Inner height (D) 35 mm

Double share Sideband & Frame construction with large anti-friction single-pin.

Frames removable from inner radius.

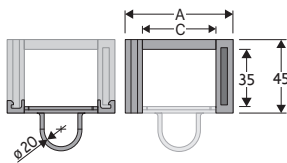

Pin
Part.no PG305

### Technical characteristics

Speed	180°/s
Acceleration	180°/s <sup>2</sup>

For higher requirements please consult our technical dept.

A	B	C	D	R	Weight/pitch	Chain
mm	mm	mm	mm	mm	kg	Part Number
69	45	45	35	100	0,100	495

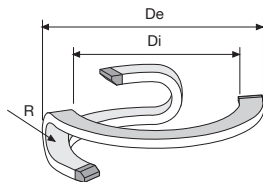

R	Di	De
mm	mm	mm
100	600	755

### Length of Chain

Chain	Degrees	No
Part Numbers	of Rotation	of Pitches
495	90	13
495	180	18
495	270	22
495	360	26

### Steel End Brackets

The end brackets set, containing two steel plates screwed to the links, allows the two ends of the chain to be attached to the equipment. The end brackets are installed in one position offering the possibility of attaching the chain externally. (Fig. A)

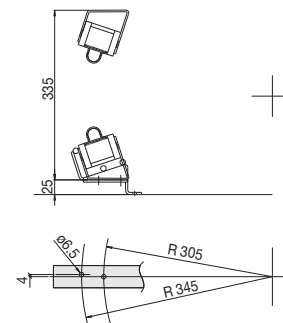

Fig. A

### Support Guide

For correct functioning of the chain it is necessary that the installation is done in a specific position.

For this reason Brevetti Stendalto has observed and created a support guide which can do this. (Fig. B)

For particular applications it is possible to create support guides with attachment plates and special dimensions.

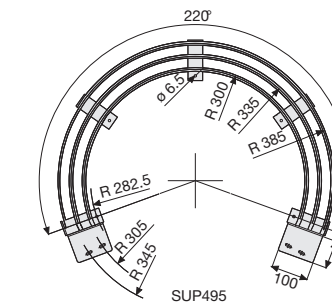

Fig. B

### Steel End Brackets Part Numbers

Complete Set Assembled	
Chain	End Brackets
Type	Set
495...	A495KM
Complete Set Unassembled	
Chain	End Brackets
Type	Set
495...	A495K

For applications with rotations exceeding 200° it is necessary to use the appropriate accessories for supporting the cable chain. (see page 29).



## 495

### Circular Nylon Cable Chain with removable frames



## 500 Circular Nylon Cable Chain

### Inner height (D) 30 mm

Single link construction.  
Frames opening from inner radius.  
Internal separation available.

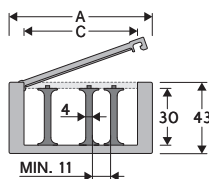

### Separator

- Unassembled	Part.no S500
- Assembled	Part.no S500MC

### Technical characteristics

Speed	180°/s
Acceleration	180°/s <sup>2</sup>

For higher requirements please consult our technical dept.

A	B	C	D	R	Weight/pitch	Chain
mm	mm	mm	mm	mm	kg	Part Number
86,5	43	68,5	30	100	0,086	50010
86,5	43	68,5	30	150	0,086	50020

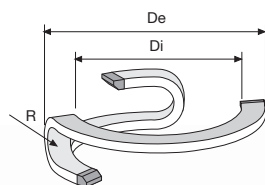

R	Di	De
mm	mm	mm
100	630	830
150	630	830

### Length of Chain

Chain	Degrees	No
Part Numbers	of Rotation	of Pitches
50010	90	13
50010	180	17
50010	270	21
50010	360	26
50020	90	15
50020	180	19
50020	270	24
50020	360	28

### Steel End Brackets

The end brackets set, containing two steel plates screwed to the links, allows the two ends of the chain to be attached to the equipment. The end brackets are installed in one position offering the possibility of attaching the chain externally. (Fig. A)

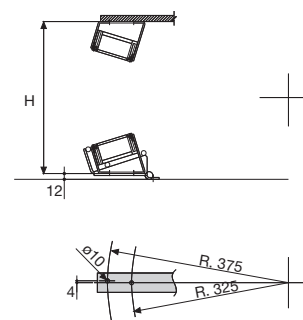

Fig. A

### Support Guide

For correct functioning of the chain it is necessary that the installation is done in a specific position. For this reason Brevetti Stendalto has observed and created a support guide which can do this. (Fig. B) For particular applications it is possible to create support guides with attachment plates and special dimensions.

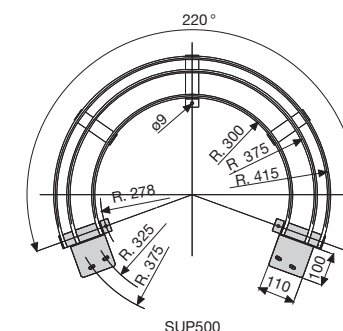

Fig. B

Chain	H
Type	
50010	330
50020	410

For applications with rotations exceeding 200° it is necessary to use the appropriate accessories for supporting the cable chain. (see page 29).

### Steel End Brackets Part Numbers

Complete Set Assembled	
Chain	End Brackets
Type	Set
50010	A50010NKM
50020	A50020NKM
Complete Set Unassembled	
Chain	End Brackets
Type	Set
50010	A50010NK
50020	A50020NK





# 510TN-515TN

## Circular Nylon Cable Chain with opening frames

**Inner height (D) 46 mm**  
 Double share Sideband & Frame construction with large anti-friction twin-pin.  
 Frames opening from inner radius.

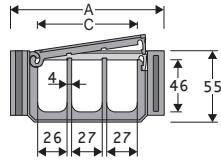

<b>Pin 510TN</b>	Part.no PG511
<b>Pin 515TN</b>	Part.no PG515-B515

**Technical characteristics**

Speed	180°/s
Acceleration	180°/s <sup>2</sup>

For higher requirements please consult our technical dept.

A	B	C	D	R	Weight/pitch	Chain
mm	mm	mm	mm	mm	kg	Part Number
132	55	88	46	125	0,200	510TN
132	55	88	46	175	0,200	515TN

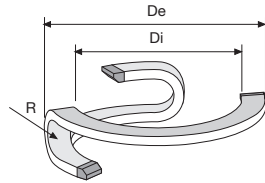

Chain Part Number	R mm	Di mm	De mm
510TN	125	940	1220
515TN	175	1060	1340

**Length of Chain**

Chain Part Numbers	Degrees of Rotation	No of Pitches
510TN	90	13
510TN	180	17
510TN	270	22
510TN	360	27
515TN	90	17
515TN	180	23
515TN	270	29
515TN	360	35

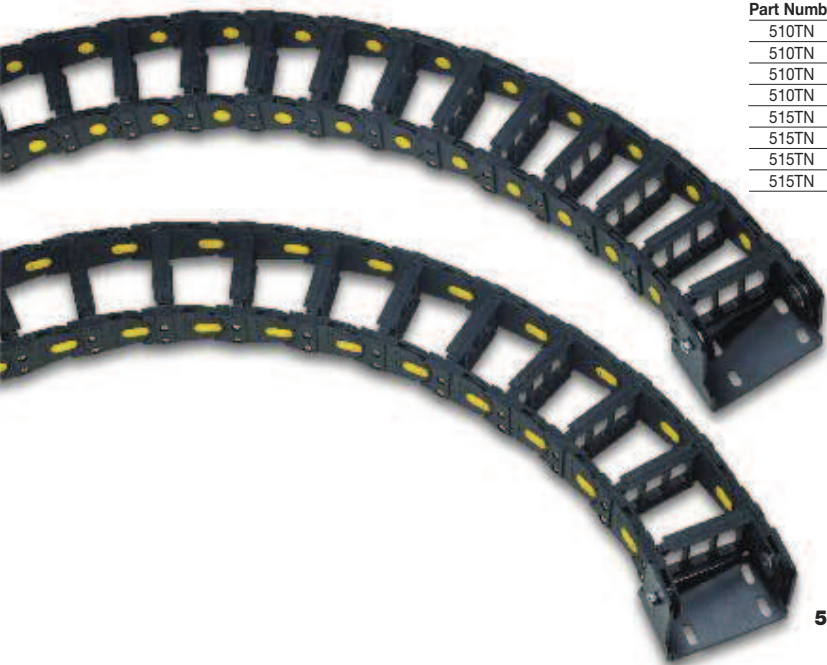

**515TN**

**510TN**

**Steel End Brackets**

The end brackets set, containing two steel plates screwed to the links, allows the two ends of the chain to be attached to the equipment. The end brackets are installed in one position offering the possibility of attaching the chain externally. (Fig. A)

**510TN**

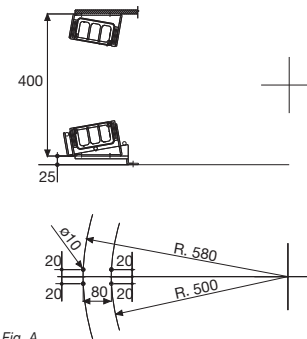

Fig. A

**515TN**

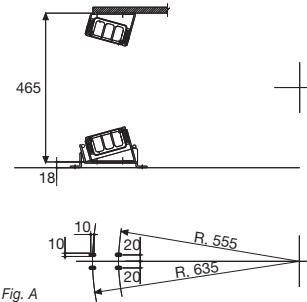

Fig. A

**Steel End Brackets Part Numbers**

Complete Set Assembled	
Chain Type	End Brackets Set
510TN	A510TNKM
515TN	A515TNKM
Complete Set Unassembled	
Chain Type	End Brackets Set
510TN	A510TNK
515TN	A515TNK

**Support Guide**

For correct functioning of the chain it is necessary that the installation is done in a specific position. For this reason Brevetti Stendalto has observed and created a support guide which can do this. (Fig. B) For particular applications it is possible to create support guides with attachment plates and special dimensions.

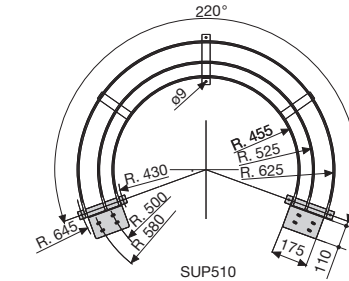

Fig. B

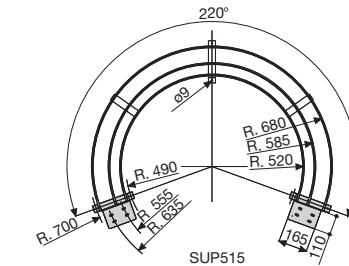

Fig. B

For applications with rotations exceeding 200° it is necessary to use the appropriate accessories for supporting the cable chain. (see page 29).

# 510TN

# 515TN

**Circular Nylon Cable Chain with opening frames**



# 545

## Circular Nylon Cable Chain with opening frames

**Inner height (D) 46 mm**  
 Double share Sideband & Frame construction with large anti-friction single-pin.  
 Frames opening from inner radius.

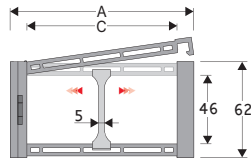

Separator	
- Unassembled	Part.no S445UF
- Assembled	Part.no S445UFMC
Pin	
	Part.no PG545

**Technical characteristics**

Speed	180°/s
Acceleration	180°/s <sup>2</sup>

For higher requirements please consult our technical dept.

A	B	C	D	R	Weight/pitch	Chain
mm	mm	mm	mm	mm	kg	Part Number
123	62	100	46	100	0,200	545SI100100

R	Di	De
mm	mm	mm
100	485	760

**Length of Chain**

Chain	Degrees	No
Part Numbers	of Rotation	of Pitches
545	90	14
545	180	18
545	270	22
545	360	27

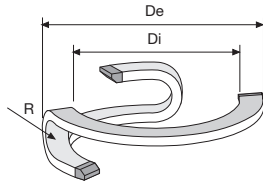

**Steel End Brackets**

The end brackets set, containing two steel plates screwed to the links, allows the two ends of the chain to be attached to the equipment. The end brackets are installed in one position offering the possibility of attaching the chain externally. (Fig. A)

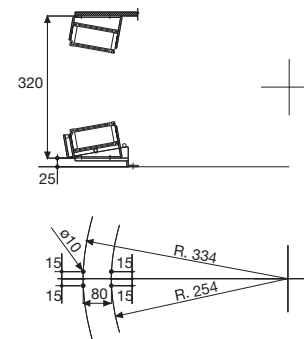

Fig. A

**Support Guide**

For correct functioning of the chain it is necessary that the installation is done in a specific position. For this reason Brevetti Stendalto has observed and created a support guide which can do this. (Fig. B) For particular applications it is possible to create support guides with attachment plates and special dimensions.

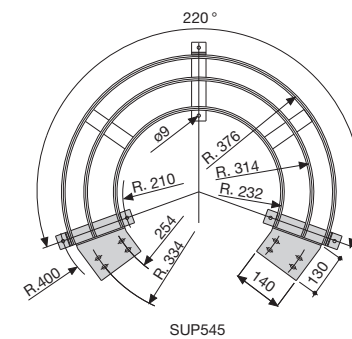

Fig. B

**Steel End Brackets Part Numbers**

Complete Set Assembled	
Chain	End Brackets
Type	Set
545	A545KM
Complete Set Unassembled	
Chain	End Brackets
Type	Set
545	A545K

For applications with rotations exceeding 200° it is necessary to use the appropriate accessories for supporting the cable chain. (see page 29).



# 545

## Circular Nylon Cable Chain with opening frames

# 599

## Circular Nylon Cable Chain with un-screwable aluminium frames

**Inner height (D) 59 mm**

Strong double share Sideband & Frame construction with three single-pins in steel for high torsion resistance. Alu-frames are un-screwable from inner and outer radius.

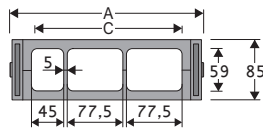

**Technical characteristics**

Speed	180°/s
Acceleration	180°/s <sup>2</sup>

For higher requirements please consult our technical dept.

A	B	C	D	R	Weight/pitch	Chain Part Number
mm	mm	mm	mm	mm	kg	
272	85	210	59	220	0,900	599

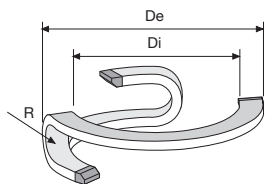

R	Di	De
mm	mm	mm
220	1400	2000

**Length of Chain**

Chain Part Numbers	Degrees of Rotation	No of Pitches
599	90	14
599	180	19
599	270	23
599	360	28

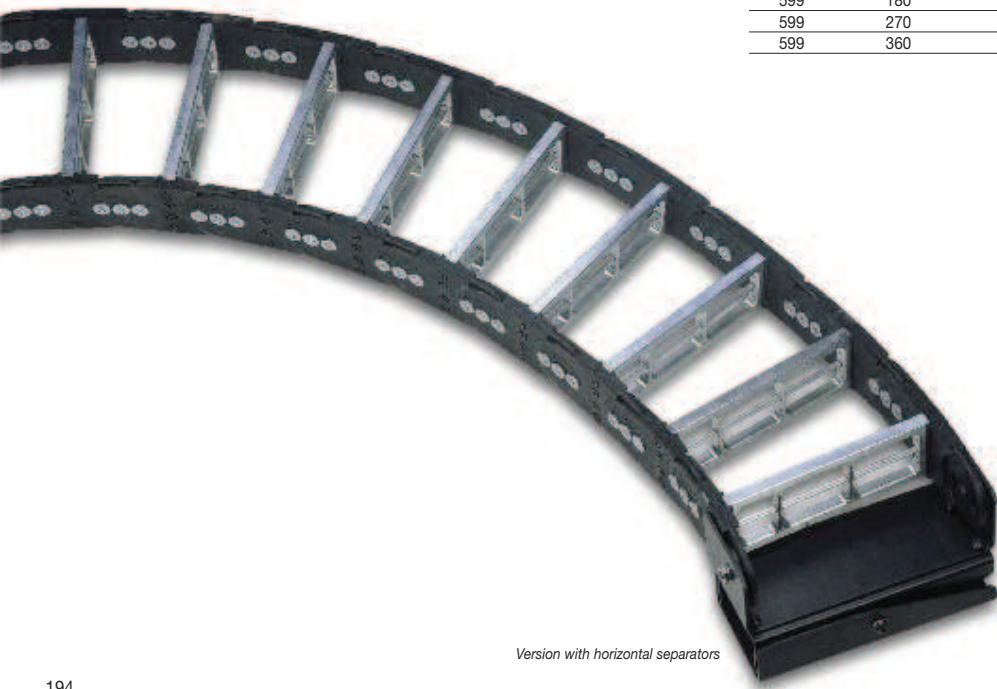

Version with horizontal separators

**Steel End Brackets**

The end brackets set, containing two steel plates screwed to the links, allows the two ends of the chain to be attached to the equipment. The end brackets are installed in one position offering the possibility of attaching the chain externally. (Fig. A)

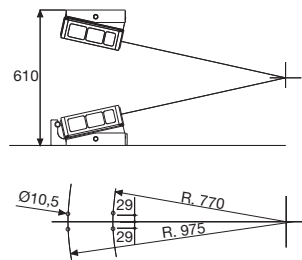

Fig. A

**Support Guide**

For correct functioning of the chain it is necessary that the installation is done in a specific position. For this reason Brevetti Stendalto has observed and created a support guide which can do this. (Fig. B) For particular applications it is possible to create support guides with attachment plates and special dimensions.

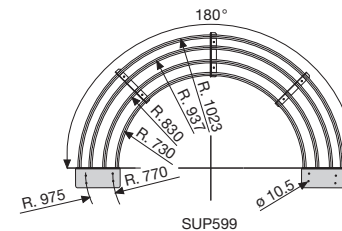

Fig. B

**Steel End Brackets Part Numbers**

Complete Set Assembled	
Chain	End Brackets
Type	Set
599	A599KM
Complete Set Unassembled	
Chain	End Brackets
Type	Set
599	A599K

For applications with rotations exceeding 200° it is necessary to use the appropriate accessories for supporting the cable chain. (see page 29).

# 599

## Circular Nylon Cable Chain with un-screwable aluminium frames





## Steel Cable Chains Steel Series

20LT Series	pag. 200
20LC Series	pag. 202
30LT Series	pag. 204
30LC Series	pag. 206
35LT Series	pag. 208
35LC Series	pag. 210
40LT Series	pag. 212
40LC Series	pag. 214
42LT Series	pag. 216
45T Series	pag. 218

*Completely enclosed design  
to protect chain contents from  
steel and wood chips, dust, etc.*

Cable drag chains in steel for long travel distance	pag. 220
Special offshore applications	pag. 225

*Opening  
and removable  
cover frames*

*Large selection  
of chain-frames:  
- aluminium draw plates  
cut to size;  
- aluminium drilled  
frames, according  
to customer drawings*

*Special tough construction  
with double spring washer,  
antifriction plates  
and rivet fixing*







# 20LC

## Bright Zinc Plated Steel chain with aluminium covers

### Inner height (D) 31 mm

Bright Zinc Plated Steel chain<sup>1</sup>.  
The cover is of Aluminium.  
You can request the quote C with special quote.

<sup>(1)</sup> available in Stainless Steel.

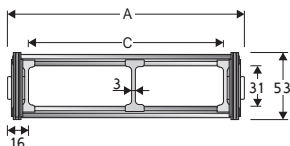

Separator	
- Unassembled	Part.no S20LTF
- Assembled	Part.no S20LTFMC

### Technical characteristics when self-supported

Speed	0,5 m/s
Acceleration	2 m/s <sup>2</sup>

For higher requirements please consult our technical dept.

For sliding applications, characteristics techniques may vary depending on the frequency, added weight and work environment.

### Aluminium draw Plates with Nylon Separators

A	B	C	D	R	Weight/m	Chain
mm	mm	mm	mm	mm	kg	Part Number
111	53	79	31	115-150-205-250-305	5,73	20LC079 □□□ *
136	53	104	31	115-150-205-250-305	6,21	20LC104 □□□ *
186	53	154	31	115-150-205-250-305	7,18	20LC154 □□□ *
236	53	204	31	115-150-205-250-305	8,15	20LC204 □□□ *
286	53	254	31	115-150-205-250-305	9,12	20LC254 □□□ *
336	53	304	31	115-150-205-250-305	10,09	20LC304 □□□ *
C+32	53	....	31	115-150-205-250-305		20LC □□□□□□ **

\*Complete the code by inserting the value of the radius (R): Ex. 20LC154 □□□□

\*\*Complete the code by inserting the value of the quote C and the radius (R): Ex. 20LC □□□□□□□□

R	H*	N	M	N1	M1
mm	mm	mm	mm	mm	mm
115	296	220	515	500	1080
150	366	255	625	675	1485
205	476	310	795	885	2005
250	566	360	940	1030	2385
305	676	410	1110	1190	2825

\* The height H should be increased by 10 mm/m approx. because of preload. In case of limitation to available space, refer to the Technical Dptm.

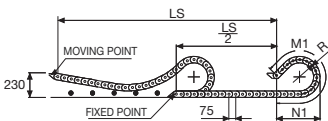
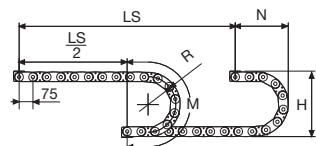

Length of chain (L)

Half travel distance ( $\frac{LS}{2}$ )

plus length of curve (M) or (M1)

$$L = \frac{LS}{2} + M \text{ or } M1$$

### Self-Supporting Capacity Diagram

The maximum length of the self-supporting capacity ( $\frac{LS}{2}$ ) in relationship to the weight of the cables and hoses contained per linear metre.

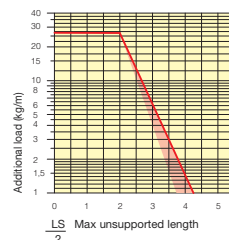

### Bright Zinc Plated Steel End Brackets

The end brackets set containing four steel plates screwed to the links allows the two ends of the chain to be attached to the equipment.

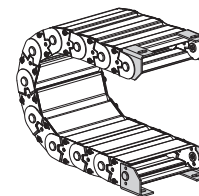
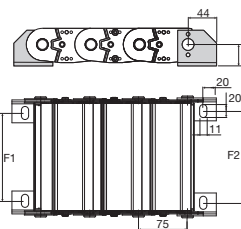
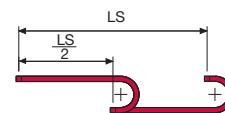

Fig. A Chain fixed outer radius (Fig A)



The red marking in the diagram area considers the difference of weight between various widths of chain.

For applications with  $\frac{LS}{2}$  and weights not included in the area of the diagram showing self-supporting capacity, verify the possible use of support rollers (see page 30).

Chain type	F1 mm	F2 mm
20LC079	61	67
20LC104	86	92
20LC154	136	142
20LC204	186	192
20LC254	236	242
20LC304	286	292

Special widths

F1=A-50 F2=A-44

### Bright Zinc Plated Steel Type Part Number

Complete Set Assembled Chain type	End Brackets Set
20LC...	A20LCKM□□**

Complete Set Unassembled Chain type	End Brackets Set
20LC...	A20CLK

\*\* 1=Pos.1; 2=Pos.2; 3=Pos.3

## 20LC

### Zinc plated steel chain with aluminium covers



Suitable to long travel distance. See page 220

## 30LT Bright Zinc Plated Steel Cable Chains

### Inner height (D) 52 mm

Zinc coated ultra-high-strength steel cable chain.  
Available with aluminium frames (LT) or with aluminium holed cross-pieces (LA) mounted each second link.  
Full-links frames assembling available on demand.  
Inner width C can be required at the needed size.  
Stainless steel 316L available on demand.

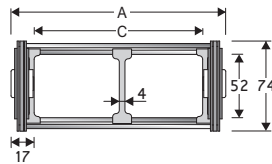

### Separator

- Unassembled Part.no. S308CO
- Assembled Part.no. S308COMC

### Aluminium frames with nylon separators

A	B	C	D	R	Weight/m	Chain
mm	mm	mm	mm	mm	kg	Part Number
140	74	106	52	150-220-250-305-400-535	6,20	30LT106□□□*
190	74	156	52	150-220-250-305-400-535	6,44	30LT156□□□*
240	74	206	52	150-220-250-305-400-535	6,68	30LT206□□□*
290	74	256	52	150-220-250-305-400-535	6,92	30LT256□□□*
340	74	306	52	150-220-250-305-400-535	7,16	30LT306□□□*
390	74	356	52	150-220-250-305-400-535	7,40	30LT356□□□*
440	74	406	52	150-220-250-305-400-535	7,65	30LT406□□□*
490	74	456	52	150-220-250-305-400-535	7,89	30LT456□□□*
540	74	506	52	150-220-250-305-400-535	8,13	30LT506□□□*
C+34	74	....	52	150-220-250-305-400-535		30LT□□□□□**

\*Complete the code by inserting the value of the radius (R). Ex. 30LT156□□□\*

\*\*Complete the code by inserting the value of the quote C and the radius (R). Ex. 30LT□□□□□\*

Chain equipped with aluminium draw plates every pitch: complete the code by inserting the letter D. Ex. 30LT156250□

### Machined Cross Frame

Machined cross frames 30LA available on request for bending radius listed below. Custom solutions for machined cross frames realization, based on customer's and/or specific requirements. Please contact Brevetti Stendalto's Technical Department for further information.

R	H*	N	M	N1	M1
mm	mm	mm	mm	mm	mm
150	388	290	670	830	1770
220	528	360	890	1145	2515
250	588	385	980	1255	2800
305	698	440	1150	1450	3285
400	888	540	1450	1740	4065
535	1158	675	1880	2110	5105

\*The height H should be increased by 10 mm/m approx. because of preload. In case of limitation to the available space, refer to the Technical Deptm.

### Technical characteristics

Speed	0,5 m/s
Acceleration	2 m/s <sup>2</sup>

For higher requirements please consult our technical dept.

For sliding applications, characteristics techniques may vary depending on the frequency, added weight and work environment.

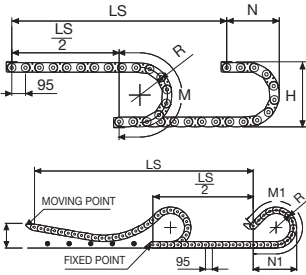

Length of chain (L)  
Half travel distance ( $\frac{LS}{2}$ )  
plus length of curve (M) or (M1)

$$L = \frac{LS}{2} + M \text{ or } M1$$

### Self-Supporting Capacity Diagram

The maximum length of the self-supporting capacity ( $\frac{LS}{2}$ ) in relationship to the weight of the cables and hoses contained per linear metre.

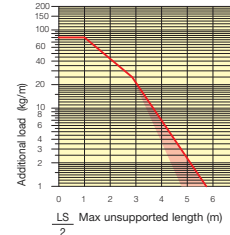

### Bright Zinc Plated Steel End Brackets

The end brackets set, containing four steel plates screwed to the links allows the two ends of the chain to be attached to the equipment.

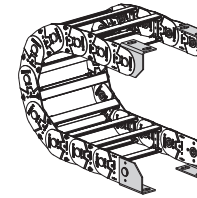
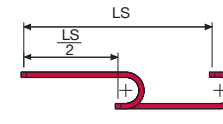
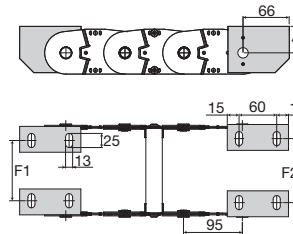

Fig. A  
Chain fixed outer radius. (Fig A)



The red marking in the diagram area considers the difference of weight between various widths of chain assembled with frames every second pitch.

For applications with  $\frac{LS}{2}$  and weights not included in the area of the diagram showing self-supporting capacity, verify the possible use of support rollers (see page 30).

Chain Type	F1 mm	F2 mm
30LT106	77	83
30LT156	127	133
30LT206	177	183
30LT256	227	233
30LT306	277	283
30LT356	327	333
30LT406	377	383
30LT456	427	433
30LT506	477	483

Special widths  
F1=A-63 F2=A-57

### Bright Zinc Plated Steel Type Part Numbers

Complete Set Assembled	
Chain	End Brackets
Type	Set
30LT...	A30LKM□□**
Complete Set Unassembled	
Chain	End Brackets
Type	Set
30LT...	A30LK

\*\* 1=Pos.1; 2=Pos.2; 3=Pos.3

## 30LT Bright Zinc Plated Steel Cable Chains

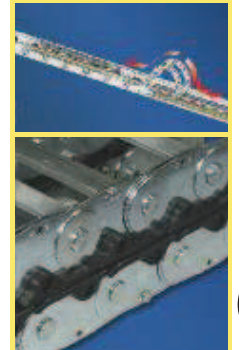

Suitable to long travel distance. See page 221

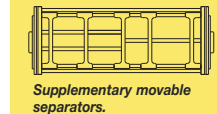

Supplementary movable separators.

For further information please consult Brevetti Stendalto's Technical Office.

## 30LC

### Bright zinc plated steel cable chain with aluminium covers

#### Inner height (D) 52 mm

Bright Zinc Plated Steel Cable Chain with aluminium cover and the quote C can be in special size. Available it can be done in Stainless steel.

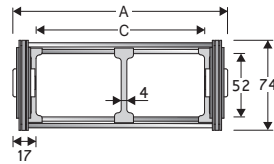

#### Separator

- Unassembled Part.no S308CO
- Assembled Part.no S308COMC

#### Aluminium frames with nylon separators

A	B	C	D	R	Weight/m	Chain
mm	mm	mm	mm	mm	kg	Part Number
140	74	106	52	150-220-250-305-400-535	7,96	30LC106□□□*
190	74	156	52	150-220-250-305-400-535	8,87	30LC156□□□*
240	74	206	52	150-220-250-305-400-535	9,79	30LC206□□□*
290	74	256	52	150-220-250-305-400-535	10,70	30LC256□□□*
340	74	306	52	150-220-250-305-400-535	11,61	30LC306□□□*
390	74	356	52	150-220-250-305-400-535	12,53	30LC356□□□*
440	74	406	52	150-220-250-305-400-535	13,44	30LC406□□□*
490	74	456	52	150-220-250-305-400-535	14,36	30LC456□□□*
540	74	506	52	150-220-250-305-400-535	15,27	30LC506□□□*
C+34	74	....	52	150-220-250-305-400-535		30LC□□□□□**

\*Complete the code by inserting the value of the radius (R); Ex. 30LC156□□□□

\*\*Complete the code by inserting the value of the quote C and the radius (R); Ex. 30LC□□□□□□□□

R	H*	N	M	N1	M1
mm	mm	mm	mm	mm	mm
150	388	290	670	830	1770
220	528	360	890	1145	2515
250	588	385	980	1255	2800
305	698	440	1150	1450	3285
400	888	540	1450	1740	4065
535	1158	675	1880	2110	5105

\*The height H should be increased by 10 mm/m approx. because of preload. In case of limitation to the available space, refer to the Technical Dptm.

#### Technical characteristics

Speed	0,5 m/s
Acceleration	2 m/s <sup>2</sup>

For higher requirements please consult our technical dept.

For sliding applications, characteristics techniques may vary depending on the frequency, added weight and work environment.

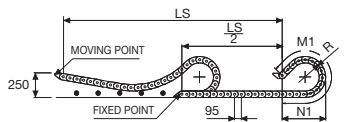
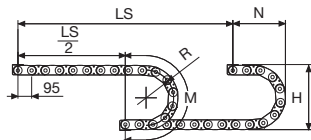

#### Self-Supporting Capacity Diagram

The maximum length of the self-supporting capacity ( $\frac{LS}{2}$ ) in relationship to the weight of the cables and hoses contained per linear metre.

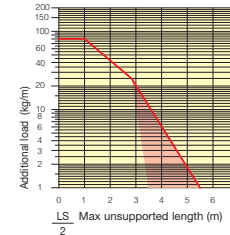

#### Bright Zinc Plated Steel End Brackets

The end brackets set, containing four steel plates screwed to the links allows the two ends of the chain to be attached to the equipment.

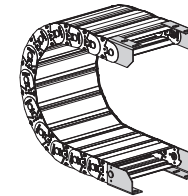
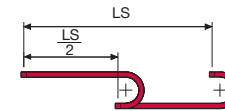
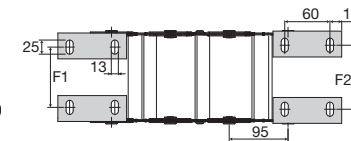

Fig. A Chain fixed outer radius. (Fig A)



The red marking in the diagram area considers the difference of weight between various widths of chain.

Chain Type	F1 mm	F2 mm
30LC106	77	83
30LC156	127	133
30LC206	177	183
30LC256	227	233
30LC306	277	283
30LC356	327	333
30LC406	377	383
30LC456	427	433
30LC506	477	483
Special widths		
F1=A-63	F2=A-57	

#### Bright Zinc Plated Steel Type Part Numbers

Complete Set Assembled	End Brackets
Chain	Set
30LC...	A30LCKM□□**

Complete Set Unassembled	End Brackets
Chain	Set
30LC...	A30LCK

\*\* 1=Pos.1; 2=Pos.2; 3=Pos.3

## 30LC Bright zinc plated steel cable chain with aluminium covers



Suitable to long travel distance. See page 221



## 35LT

### Bright zinc plated steel cable chain with Alu-frames

#### Inner height (D) 65 mm

Bright Zinc Plated Steel Cable Chain.<sup>1</sup> Aluminium Holed cross pieces designed or Alu-frame are mounted each second link. Quote C can be in special size.

<sup>(1)</sup> available in Stainless Steel.

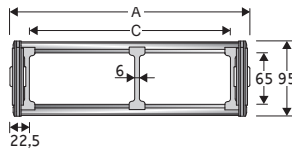

#### Separator

- Unassembled	Part.no	ST3500F
- Assembled	Part.no	ST3500FMC

#### Technical characteristics when self-supported

Speed	0,5 m/s
Acceleration	2 m/s <sup>2</sup>

For higher requirements please consult our technical dept.

#### Aluminium frames with nylon separators

A	B	C	D	R	Weight/m	Chain
mm	mm	mm	mm	mm	kg	Part Number
149	95	104	65	200-250-300-350-400-450-500-600	10,30	35LT104□□□*
199	95	154	65	200-250-300-350-400-450-500-600	10,67	35LT154□□□*
249	95	204	65	200-250-300-350-400-450-500-600	11,04	35LT204□□□*
299	95	254	65	200-250-300-350-400-450-500-600	11,41	35LT254□□□*
349	95	304	65	200-250-300-350-400-450-500-600	11,78	35LT304□□□*
399	95	354	65	200-250-300-350-400-450-500-600	12,15	35LT354□□□*
449	95	404	65	200-250-300-350-400-450-500-600	12,52	35LT404□□□*
499	95	454	65	200-250-300-350-400-450-500-600	12,89	35LT454□□□*
549	95	504	65	200-250-300-350-400-450-500-600	13,26	35LT504□□□*
C+45	95	....	65	200-250-300-350-400-450-500-600		35LT□□□□□**

\*Complete the code by inserting the value of the radius (R). Ex. 35LT154□□□□

\*\*Complete the code by inserting the value of the quote C and the radius (R). Ex. 35LT□□□□□□□□□□  
Chain equipped with aluminium draw plates every pitch: complete the code by inserting the letter D. Ex. 35LT154250□□

#### Machined Cross Frame

Machined cross frames 35LA available on request for bending radius listed below. Custom solutions for machined cross frames realization, based on customer's and/or specific requirements. Please contact Brevetti Stendalto's Technical Department for further information.

R	H*	N	M	N1	M1
mm	mm	mm	mm	mm	mm
200	512	375	880	1100	2360
250	612	425	1040	1310	2870
300	712	480	1200	1495	3335
350	812	525	1350	1670	3775
400	912	575	1510	1825	4190
450	1012	625	1670	1975	4595
500	1112	675	1825	2120	4985
600	1312	775	2140	2390	5750

\*The height H should be increased by 10 mm/m approx. because of preload. In case of limitation to the available space, refer to the Technical Dept.

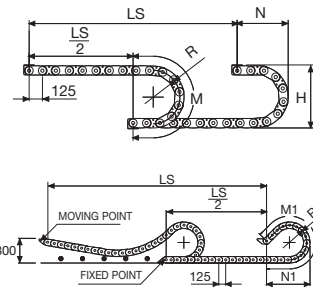

Length of chain (L)

Half travel distance ( $\frac{LS}{2}$ )

plus length of curve (M) or (M1)

$$L = \frac{LS}{2} + M \text{ or } M1$$

#### Self-Supporting Capacity Diagram

The maximum length of the self-supporting capacity ( $\frac{LS}{2}$ ) in relationship to the weight of the cables and hoses contained per linear metre.

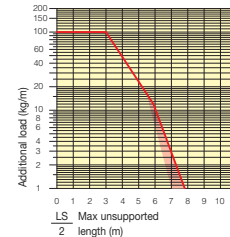

#### Bright Zinc Plated Steel End Brackets

The end brackets set, containing four steel plates screwed to the links allows the two ends of the chain to be attached to the equipment.

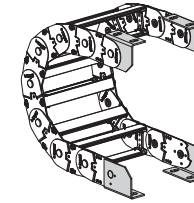
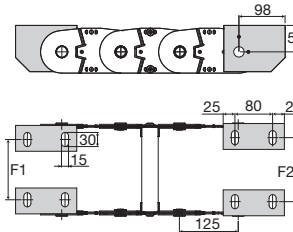

Fig. A Chain fixed outer radius (Fig A)



Chain type	F1 mm	F2 mm
35LT104	78	86
35LT154	128	136
35LT204	178	186
35LT254	228	236
35LT304	278	286
35LT354	328	336
35LT404	378	386
35LT454	428	436
35LT504	478	486

Special widths  
F1=A-71,5 F2=A-63,5

#### Bright Zinc Plated Steel Type Part Numbers

Complete Set Assembled	Chain	End Brackets
type		Set
35LT...		A35LKM□**
Complete Set Unassembled	Chain	End Brackets
type		Set
35LT...		A35LK

\*\* 1=Pos.1; 2=Pos.2; 3=Pos.3

## 35LT Bright zinc plated steel cable chain with Alu-frames



Suitable to long travel distance See page 222



Supplementary movable separators.

For further information please consult Brevetti Stendalto's Technical Office

## 35LC

### Stainless steel cable chain with the aluminium covers

#### Inner height (D) 65 mm

Bright Zinc Plated Steel Cable Chain with aluminium cover and the quote C can be in special size. Available it can be done in Stainless steel.

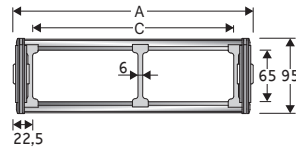

#### Separator

- Unassembled	Part.no	ST3500F
- Assembled	Part.no	ST3500MFC

#### Technical characteristics when self-supported

Speed	0,5 m/s
Acceleration	2 m/s <sup>2</sup>

For higher requirements please consult our technical dept.

For sliding applications, characteristics techniques may vary depending on the frequency, added weight and work environment.

#### Aluminium frames with nylon separators

A	B	C	D	R	Weight/m	Chain
mm	mm	mm	mm	mm	kg	Part Number
149	95	104	65	200-250-300-350-400-450-500-600	12,20	35LC104□□□*
199	95	154	65	200-250-300-350-400-450-500-600	13,23	35LC154□□□*
249	95	204	65	200-250-300-350-400-450-500-600	14,26	35LC204□□□*
299	95	254	65	200-250-300-350-400-450-500-600	15,29	35LC254□□□*
349	95	304	65	200-250-300-350-400-450-500-600	16,32	35LC304□□□*
399	95	354	65	200-250-300-350-400-450-500-600	17,35	35LC354□□□*
449	95	404	65	200-250-300-350-400-450-500-600	18,37	35LC404□□□*
499	95	454	65	200-250-300-350-400-450-500-600	19,40	35LC454□□□*
549	95	504	65	200-250-300-350-400-450-500-600	20,43	35LC504□□□*
C+45	95	....	65	200-250-300-350-400-450-500-600		35LC□□□□□**

\*Complete the code by inserting the value of the radius (R). Ex. 35LC154□□□□

\*\*Complete the code by inserting the value of the quote C and the radius (R). Ex. 35LC1□□□□□□□

R	H*	N	M	N1	M1
mm	mm	mm	mm	mm	mm
200	512	375	880	1100	2360
250	612	425	1040	1310	2870
300	712	480	1200	1495	3335
350	812	525	1350	1670	3775
400	912	575	1510	1825	4190
450	1012	625	1670	1975	4595
500	1112	675	1825	2120	4985
600	1312	775	2140	2390	5750

\*The height H should be increased by 10 mm/m approx. because of preload. In case of limitation to the available space, refer to the Technical Dept.

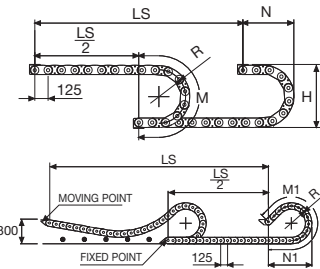

Length of chain (L)  
 Half travel distance ( $\frac{LS}{2}$ )  
 plus length of curve (M) or (M1)  

$$L = \frac{LS}{2} + M \text{ or } M1$$

#### Self-Supporting Capacity Diagram

The maximum length of the self-supporting capacity ( $\frac{LS}{2}$ ) in relationship to the weight of the cables and hoses contained per linear metre.

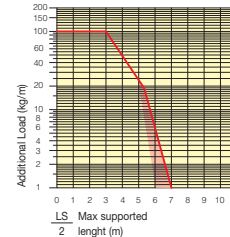

#### Bright Zinc Plated Steel End Brackets

The end brackets set, containing four steel plates screwed to the links allows the two ends of the chain to be attached to the equipment.

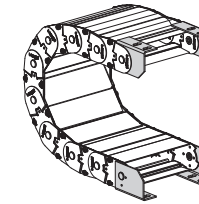
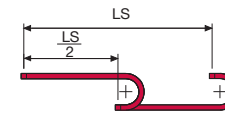
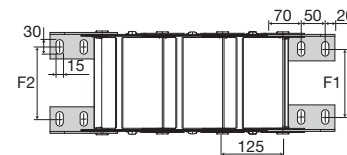
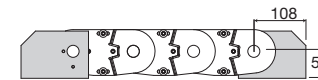

Fig. A Chain fixed outer radius (Fig A)



The red marking in the diagram area considers the difference of weight between various widths of chain.

For applications with  $\frac{LS}{2}$  and weights not included in the area of the diagram showing self-supporting capacity, verify the possible use of support rollers (see page 30).

#### Chain Type

Chain Type	F1 mm	F2 mm
35LC104	78	86
35LC154	128	136
35LC204	178	186
35LC254	228	236
35LC304	278	286
35LC354	328	336
35LC404	378	386
35LC454	428	436
35LC504	478	486

Special widths  
 F1=A-71,5 F2=A-63,5

#### Bright Zinc Plated Steel Type Part Numbers

Complete Set Assemble	End Brackets
Chain type	Set
35LC...	A35LCKM□□**

Complete Set Unassemble	End Brackets
Chain type	Set
35LC...	A35LCK

\*\* 1=Pos.1; 2=Pos.2; 3=Pos.3

## 35LC Stainless steel cable chain with the aluminium covers



Suitable to long travel distance See page 223





## 40LC Zinc plated steel chain with aluminium cover

**Inner height (D) 104,5 mm**  
Bright Zinc Plated Steel Cable Chain with aluminium cover and the quote C can be in special size. Available it can be done in Stainless steel.

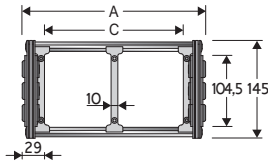

Separator	
- Unassembled	Part.no S310TCF9
- Assembled	Part.no S310TCF9MC

### Technical characteristics when self-supported

Speed	0,5 m/s
Acceleration	2 m/s <sup>2</sup>

For higher requirements please consult our technical dept.

### Aluminium Draw Plates with nylon separators

A	B	C	D	R	Weight/m	Chain
mm	mm	mm	mm	mm	kg	Part Number
208	145	150	104,5	250-300-350-400-450-500-550-600-700-750-850	22,47	40LC150 □□□ *
258	145	200	104,5	250-300-350-400-450-500-550-600-700-750-850	23,84	40LC200 □□□ *
308	145	250	104,5	250-300-350-400-450-500-550-600-700-750-850	25,20	40LC250 □□□ *
358	145	300	104,5	250-300-350-400-450-500-550-600-700-750-850	26,56	40LC300 □□□ *
458	145	400	104,5	250-300-350-400-450-500-550-600-700-750-850	29,28	40LC400 □□□ *
558	145	500	104,5	250-300-350-400-450-500-550-600-700-750-850	31,01	40LC500 □□□ *
C+58	145	...	104,5	250-300-350-400-450-500-550-600-700-750-850		40LC □□□□□□□ **

\*Complete the code by inserting the value of the radius (R): Ex. 40LC150 □ □ □ □ □

\*\*Complete the code by inserting the value of the quote C and the radius (R): Ex. 40LC □ □ □ □ □ □ □ □ □ □ □ □

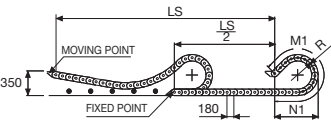
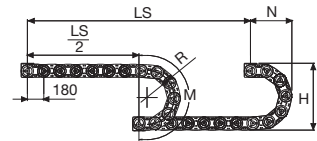

Length of chain (L)  
Half travel distance ( $\frac{LS}{2}$ )  
plus length of curve (M) or (M1)

$$L = \frac{LS}{2} + M \text{ or } M1$$

R	H*	N	M	N1	M1
mm	mm	mm	mm	mm	mm
250	650	510	1150	1545	3285
300	750	555	1305	1755	3790
350	850	605	1460	1950	4265
400	950	655	1620	2125	4715
450	1050	710	1780	2295	5150
500	1150	755	1930	2455	5570
550	1250	805	2090	2605	5975
600	1350	855	2245	2755	6375
700	1550	955	2560	3035	7155
750	1650	1010	2720	3170	7535
850	1850	1105	3030	3430	8280
1000	2150	1255	3500	-	-

\* The height H should be increased by 10 mm/m approx. because of preload. In case of limitation to the available space, refer to the Technical Dptm.

### Self-Supporting Capacity Diagram

The maximum length of the self-supporting capacity ( $\frac{LS}{2}$ ) in relationship to the weight of the cables and hoses contained per linear metre.

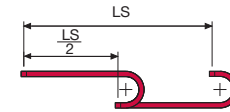
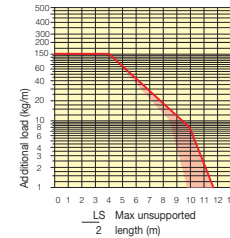

The red marking in the diagram area considers the difference of weight between various widths of chain.

For applications with  $\frac{LS}{2}$  and weights not included in the area of the diagram showing self-supporting capacity, verify the possible use of support rollers (see page 30).

### Bright Zinc Plated Steel End Brackets

The end brackets set, containing four steel plates screwed to the links allows the two ends of the chain to be attached to the equipment.

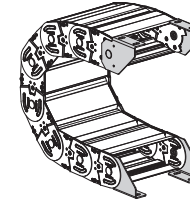
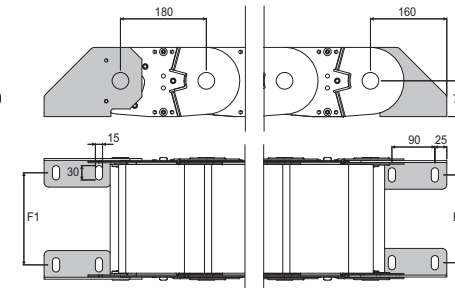

Fig. A  
Chain fixed outer radius (Fig A)  
See mounting variations page 31



Chain type	F1 mm	F2 mm
40LC150	144	135
40LC200	194	185
40LC250	244	235
40LC300	294	285
40LC400	394	385
40LC500	494	485

Special Widths

F1=A-64 F2=A-73

### Bright Zinc Plated Steel Type Part Numbers

Complete Set Assembled	Chain	End Brackets
Type	Set	
40LC		A40LCKM □ *

Complete Set Unassembled	Chain	End Brackets
Type	Set	
40LC		A40LCK

\*\* 1=Pos.1; 2=Pos.2; 3=Pos.3  
Mount Variant page 31

## 40LC Zinc plated steel chain with aluminium cover

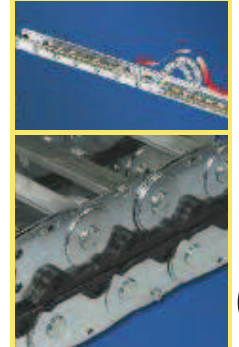

Suitable to long travel distance  
See page 233

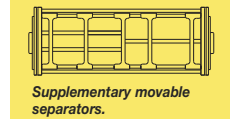

Supplementary movable separators.

For further information please consult Brevetti Standalto's Technical Office

## 42LT Bright zinc plated steel cable chain with Alu-frames

### Inner height (D) 138 mm

Bright Zinc Plated Steel Cable Chain,<sup>1</sup>  
Aluminium Holed cross pieces designed  
or Alu-frame are mounted every link.  
Quote C can be in special size.

<sup>(1)</sup> available in Stainless Steel.

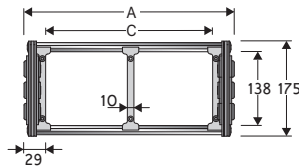

### Separator

- Unassembled	Part.no S42TCF9
- Assembled	Part.no S42TCF9MC

### Technical characteristics when self-supported

Speed	0,5 m/s
Acceleration	2 m/s <sup>2</sup>

For higher requirements please consult our  
technical dept.

For sliding applications, characteristics  
techniques may vary depending on the  
frequency, added weight and work environment.

### Aluminium draw plates with nylon separators

A	B	C	D	R	Weight/m	Chain
mm	mm	mm	mm	mm	kg	Part Number
208	175	150	138	250-300-350-400-450-500-550-600-700-750-850	22,84	42LT150 □□□ *
258	175	200	138	250-300-350-400-450-500-550-600-700-750-850	23,30	42LT200 □□□ *
308	175	250	138	250-300-350-400-450-500-550-600-700-750-850	23,76	42LT250 □□□ *
358	175	300	138	250-300-350-400-450-500-550-600-700-750-850	24,22	42LT300 □□□ *
458	175	400	138	250-300-350-400-450-500-550-600-700-750-850	25,15	42LT400 □□□ *
558	175	500	138	250-300-350-400-450-500-550-600-700-750-850	26,07	42LT500 □□□ *
C+58	175	....	138	250-300-350-400-450-500-550-600-700-750-850		42LT □□□□□□ **

\*Complete the code by inserting the value of the radius (R): 42LT150 □□□ □

\*\*Complete the code by inserting the value of the quota C and the radius (R): Es. 42LT □□□□□□□□

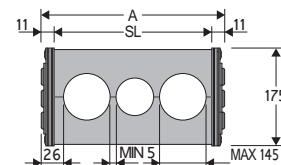

### Machined Cross Frame

Machined cross frames (42LA) available on  
request for bending radius listed below.  
Custom solutions for machined cross frames  
realization, based on customer's and/or  
specific requirements. Please contact Brevetti  
Stendalto's Technical Department for further  
information.

R	H*	N	M	N1	M1
mm	mm	mm	mm	mm	mm
250	720	510	1150	1545	3285
300	820	555	1305	1755	3790
350	920	605	1460	1950	4265
400	1020	655	1620	2125	4715
450	1120	710	1780	2295	5150
500	1220	755	1930	2455	5570
550	1320	805	2090	2605	5975
600	1420	855	2245	2755	6375
700	1620	955	2560	3035	7155
750	1720	1010	2720	3170	7535
850	1920	1105	3030	3430	8280
1000	2220	1255	3500	-	-

\*The height H should be increased by 10 mm/m  
approx. because of preload. In case of limitation to  
the available space, refer to the Technical Deptm.

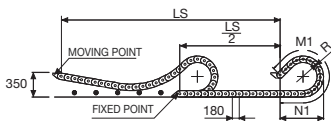
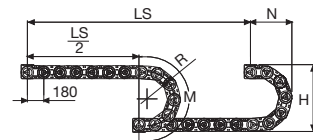

Length of chain (L)

Half travel distance ( $\frac{LS}{2}$ )

plus length of curve (M) or (M1)

$$L = \frac{LS}{2} + M \text{ or } M1$$

### Self-Supporting Capacity Diagram

The maximum length of the  
self-supporting capacity  
( $\frac{LS}{2}$ ) in relationship to the  
weight of the cables and  
hoses contained per linear  
metre.

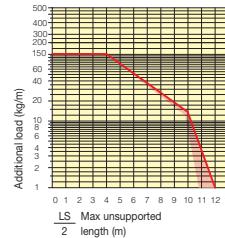

### Bright Zinc Plated Steel End Brackets

The end brackets set, containing four steel plates screwed  
to the links allows the two ends of the chain to be attached  
to the equipment.

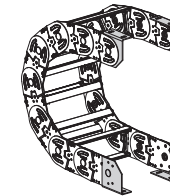
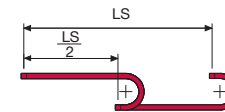
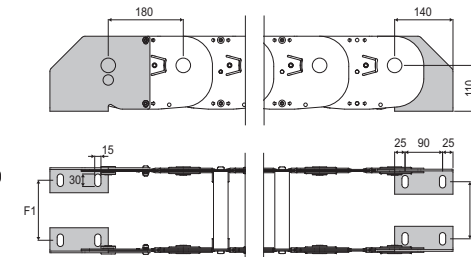

Fig. A  
Chain fixed outer radius (Fig A). See mounting variations page 31



The red marking in the  
diagram area considers the  
difference of weight between  
various widths of chain.

For applications with  $\frac{LS}{2}$   
and weights not included in  
the area of the diagram  
showing self-supporting  
capacity, verify the possible  
use of support rollers  
(see page 30).



Chain Type	F1 mm	Chain type	F2 mm
42LT150	144	42LT150	135
42LT200	194	42LT200	185
42LT250	244	42LT250	235
42LT300	294	42LT300	285
42LT400	394	42LT400	385
42LT500	494	42LT500	485
Special Widths	F=A-64	Special Widths	F=A-73

### Bright Zinc Plated Steel Type Part Numbers

Complete Set Assembled	End Brackets
Chain type	Set
42LT...	A42LKM □ **

Complete Set Unassembled	End Brackets
Chain type	Set
42LT...	A42LK

\*\* 1=Pos.1; 2=Pos.2; 3=Pos.3  
See mounting variations page 31

## 42LT Bright zinc plated steel cable chain with Alu-frames

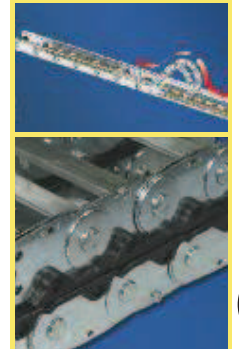

Suitable to long travel distance  
See page 220

## 45T Cable Chains in Bright Zinc Plated Steel

### Inner height (D) 182 mm

Double share link construction. Triple-ribose fixing and standard large washer and nylon anti-friction disk to assure smooth and durable movement. Un-screwable Alu-draw frames (T) are standard mounted every link. Alu-drilled plates (TL) are mounted every second link with an Alu-draw frames every other link. Separator systems available. Also available in Stainless Steel.

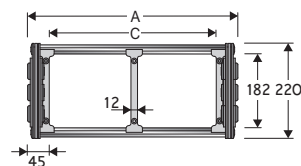

Separator	
- Unassembled	Part.no ST4500F1C
- Assembled	Part.no ST4500F1CM

### Aluminium Draw Plates with Separators in Nylon

A	B	C	D	R	Weight/m	Chain
mm	mm	mm	mm	mm	kg	Part Number
390	220	300	182	400-600-800-1000-1250-1500	40,97	45T300 □□□ *
440	220	350	182	400-600-800-1000-1250-1500	41,31	45T350 □□□ *
490	220	400	182	400-600-800-1000-1250-1500	41,64	45T400 □□□ *
540	220	450	182	400-600-800-1000-1250-1500	41,97	45T450 □□□ *
590	220	500	182	400-600-800-1000-1250-1500	42,30	45T500 □□□ *
690	220	600	182	400-600-800-1000-1250-1500	42,97	45T600 □□□ *
C+90	220	....	182	400-600-800-1000-1250-1500		45T □□□□□□ **

\*Complete the code by inserting the value of the radius (R): Ex. 45T300 □ □ □ □

\*\*Complete the code by inserting the value of the quote C and the radius (R): Ex. 45T □ □ □ □ □ □ □ □

### Technical characteristics when self-supported

Speed	0,5 m/s
Acceleration	2 m/s <sup>2</sup>

For higher requirements please consult our technical dept.

4

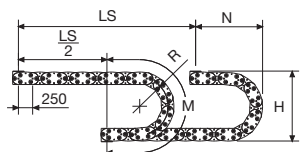

Length of chain (L)

Half travel distance ( $\frac{LS}{2}$ ) plus length of curve (M)

$$L = \frac{LS}{2} + M$$

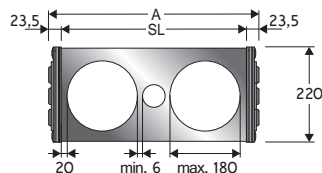

### Machined Cross Frame

Machined cross frames (45LT) available on request for bending radius listed below.

Custom solutions for machined cross frames realization, based on customer's and/or specific requirements.

Please contact Brevetti Stendalto's Technical Department for further information.

R	H*	N	M
mm	mm	mm	mm
400	1060	770	1760
600	1460	970	2390
800	1860	1170	3020
1000	2260	1370	3650
1250	2760	1620	4430
1500	3260	1870	5220

\*The height H should be increased by 10 mm/m approx. because of preload. In case of limitation to the available space, refer to the Technical Dptm.

### Self-Supporting Capacity Diagram

The maximum length of the self-supporting capacity ( $\frac{LS}{2}$ ) in relationship to the weight of the cables and hoses contained per linear metre.

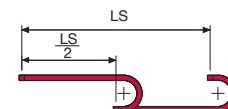
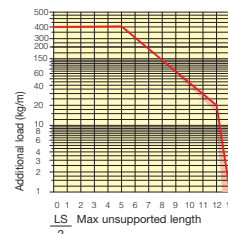

The red marking in the diagram area considers the difference of weight between various widths of chains assembled with aluminium draw plates every second pitch.

For applications with  $\frac{LS}{2}$  and weights not included in the area of the diagram showing self-supporting capacity, verify the possible use of support rollers (see page 30).

### Bright Zinc Plated Steel End Brackets

The end brackets set, containing four steel plates screwed to the links allows the two ends of the chain to be attached to the equipment.



Fig. A Chain fixed outside the radius, (Fig A) See end brackets mounting variations page 31.

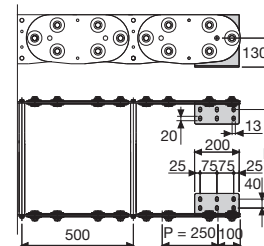

Chain Type	F mm
45T300	285
45T350	335
45T400	385
45T450	435
45T500	485
45T600	585
Special widths F=A-105	

### Bright Zinc Plated Steel Type Part Numbers

Complete Set Assembled Chain	End Brackets
Type	Set
45...	A45KM □ **
Complete Set Unassembled Chain	End Brackets
Type	Set
45...	A45K

\*\* 1=Pos.1; 2=Pos.2; 3=Pos.3 See end brackets mounting variations page 31.

## 45T Cable Chain in Bright Zinc Plated Steel

4



Supplementary movable separators.

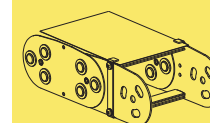

Steel laminar cover.

For further information please consult Brevetti Stendalto's Technical Office



## Sliding cable chains in bright zinc plated steel

### Technical characteristics when self-supported

Speed	2 m/s
Acceleration	2 m/s <sup>2</sup>

For higher requirements please consult our technical dept.

### 20LPT with aluminium draw plates

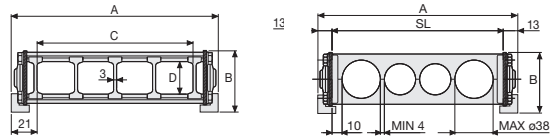

A	B	C	D	R	Weight/m	Chain
mm	mm	mm	mm	mm	kg	Part Number
121	58,5	79	32	115-150-205-250-305	4,82	20LPT079 □□□ *
146	58,5	104	32	115-150-205-250-305	4,97	20LPT104 □□□ *
196	58,5	154	32	115-150-205-250-305	5,27	20LPT154 □□□ *
246	58,5	204	32	115-150-205-250-305	5,57	20LPT204 □□□ *
296	58,5	254	32	115-150-205-250-305	5,87	20LPT254 □□□ *
346	58,5	304	32	115-150-205-250-305	6,17	20LPT304 □□□ *
C+42	58,5	....	32	115-150-205-250-305		20LPT □□□□□ **

\*Complete the code by inserting the value of the radius (R): Ex. 20LPT154 [2] [5] [0]

\*\*Complete the code by inserting the value of the quote C and the radius (R): Ex. 20LPT [1] [2] [3] [2] [5] [0]  
Chain equipped with aluminium draw plates every pitch: complete the code by inserting the letter D: Ex. 20LPT154250 [0]

### Aluminium split cross pieces created by design

A	B	R	Chain
mm	mm	mm	Part Number
SL+26	58,5	115-150-205-250-305	20LPA □□□□□ ***

\*\*\*Complete the code by inserting the value of the quote SL and the radius (R): Ex. 20LPA [1] [5] [0] [2] [5] [0]

### 20LPC with aluminium covers

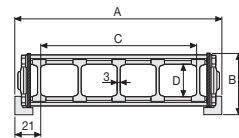

A	B	C	D	R	Weight/m	Chain
mm	mm	mm	mm	mm	kg	Part Number
121	58,5	79	31	115-150-205-250-305	6,59	20LPC079 □□□ *
146	58,5	104	31	115-150-205-250-305	7,08	20LPC104 □□□ *
196	58,5	154	31	115-150-205-250-305	8,05	20LPC154 □□□ *
246	58,5	204	31	115-150-205-250-305	9,02	20LPC204 □□□ *
296	58,5	254	31	115-150-205-250-305	9,99	20LPC254 □□□ *
346	58,5	304	31	115-150-205-250-305	10,96	20LPC304 □□□ *
C+42	58,5	....	31	115-150-205-250-305		20LPC □□□□□ **

\*Complete the code by inserting the value of the radius (R): Ex. 20LPC154 [2] [5] [0]

\*\*Complete the code by inserting the value of the quote C and the radius (R): Ex. 20LPC [1] [2] [3] [2] [5] [0]

### 30LPT with aluminium draw plates

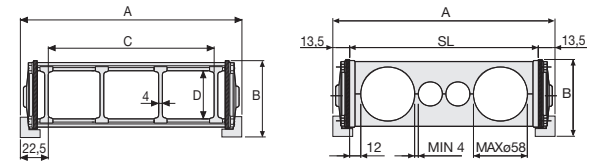

A	B	C	D	R	Weight/m	Chain
mm	mm	mm	mm	mm	kg	Part Number
151	81,5	106	52	150-220-250-305-400-535	6,71	30LPT106 □□□ *
201	81,5	156	52	150-220-250-305-400-535	6,95	30LPT156 □□□ *
251	81,5	206	52	150-220-250-305-400-535	7,20	30LPT206 □□□ *
301	81,5	256	52	150-220-250-305-400-535	7,44	30LPT256 □□□ *
351	81,5	306	52	150-220-250-305-400-535	7,68	30LPT306 □□□ *
401	81,5	356	52	150-220-250-305-400-535	7,92	30LPT356 □□□ *
451	81,5	406	52	150-220-250-305-400-535	8,16	30LPT406 □□□ *
501	81,5	456	52	150-220-250-305-400-535	8,41	30LPT456 □□□ *
551	81,5	506	52	150-220-250-305-400-535	8,65	30LPT506 □□□ *
C+45	81,5	....	52	150-220-250-305-400-535		30LPT □□□□□ **

\*Complete the code by inserting the value of the radius (R): Ex. 30LPT156 [2] [5] [0]

\*\*Complete the code by inserting the value of the quote C and the radius (R): Ex. 30LPT [5] [5] [1] [2] [5] [0]  
Chain equipped with aluminium draw plates every pitch: complete the code by inserting the letter D: Ex. 30LPT156250 [0]

### Aluminium split cross pieces created by design

A	B	R	Chain
mm	mm	mm	Part Number
SL+27	81,5	150-220-250-305-400-535	30LPA □□□□□ ***

\*\*\*Complete the code by inserting the value of the SL and the radius (R): Es. 30LPA [1] [5] [0] [2] [5] [0]

### 30LPC with aluminium covers

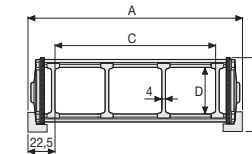

A	B	C	D	R	Weight/m	Chain
mm	mm	mm	mm	mm	kg	Part Number
151	81,5	106	52	150-220-250-305-400-535	8,38	30LPC106 □□□ *
201	81,5	156	52	150-220-250-305-400-535	9,30	30LPC156 □□□ *
251	81,5	206	52	150-220-250-305-400-535	10,21	30LPC206 □□□ *
301	81,5	256	52	150-220-250-305-400-535	11,13	30LPC256 □□□ *
351	81,5	306	52	150-220-250-305-400-535	12,04	30LPC306 □□□ *
401	81,5	356	52	150-220-250-305-400-535	12,95	30LPC356 □□□ *
451	81,5	406	52	150-220-250-305-400-535	13,87	30LPC406 □□□ *
501	81,5	456	52	150-220-250-305-400-535	14,79	30LPC456 □□□ *
551	81,5	506	52	150-220-250-305-400-535	15,70	30LPC506 □□□ *
C+45	81,5	....	52	150-220-250-305-400-535		30LPC □□□□□ **

\*Complete the code by inserting the value of the radius (R): Ex. 30LPC156 [2] [5] [0]

\*\*Complete the code by inserting the value of the quote C and the radius (R): Ex. 30LPC [1] [2] [3] [2] [5] [0]



Sliding low-friction skids fastened to the links allow chains running on themselves, all the while granting them to get more longer strokes. Aluminium Draw Plates with nylon separations or aluminium split cross piece created by design. Separators system available.

<sup>(1)</sup> Available in Stainless steel

## Sliding cable chains in bright zinc plated steel

### Technical characteristics when self-supported

Speed	2 m/s
Acceleration	2 m/s <sup>2</sup>

For higher requirements please consult our technical dept.

### 35LPT with aluminium draw plates

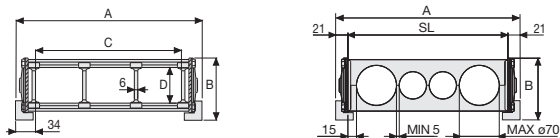

A	B	C	D	R	Weight/m	Chain
mm	mm	mm	mm	mm	kg	Part Number
172	107	104	65	200-250-300-350-400-450-500-600	11,49	35LPT104 □□□*
222	107	154	65	200-250-300-350-400-450-500-600	11,86	35LPT154 □□□*
272	107	204	65	200-250-300-350-400-450-500-600	12,23	35LPT204 □□□*
322	107	254	65	200-250-300-350-400-450-500-600	12,60	35LPT254 □□□*
372	107	304	65	200-250-300-350-400-450-500-600	12,97	35LPT304 □□□*
422	107	354	65	200-250-300-350-400-450-500-600	13,33	35LPT354 □□□*
472	107	404	65	200-250-300-350-400-450-500-600	13,70	35LPT404 □□□*
522	107	454	65	200-250-300-350-400-450-500-600	14,07	35LPT454 □□□*
572	107	504	65	200-250-300-350-400-450-500-600	14,44	35LPT504 □□□*
C+68	107	....	65	200-250-300-350-400-450-500-600		35LPT □□□□□□**

\*Complete the code by inserting the value of the radius (R): Ex. 35PT154 □□□□

\*\*Complete the code by inserting the value of the quote C and the radius (R): Ex. 35PT □□□□□□

Chain equipped with aluminium draw plates every pitch: complete the code by inserting the letter D. Ex. 35LPT154350□

### Aluminium split cross pieces created by design

A	B	R	Chain
mm	mm	mm	Part Number
SL+42	107	200-250-300-350-400-450-500-600	35LPA □□□□□□**

\*\*Complete the code by inserting the value of SL and the radius (R): Ex. 35LPA □□□□□□□□

### 35LPC with aluminium covers

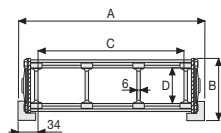

A	B	C	D	R	Weight/m	Chain
mm	mm	mm	mm	mm	kg	Part Number
172	107	104	65	200-250-300-350-400-450-500-600	13,26	35LPC104 □□□□*
222	107	154	65	200-250-300-350-400-450-500-600	14,29	35LPC154 □□□□*
272	107	204	65	200-250-300-350-400-450-500-600	15,32	35LPC204 □□□□*
322	107	254	65	200-250-300-350-400-450-500-600	16,35	35LPC254 □□□□*
372	107	304	65	200-250-300-350-400-450-500-600	17,38	35LPC304 □□□□*
422	107	354	65	200-250-300-350-400-450-500-600	18,41	35LPC354 □□□□*
472	107	404	65	200-250-300-350-400-450-500-600	19,44	35LPC404 □□□□*
522	107	454	65	200-250-300-350-400-450-500-600	20,46	35LPC454 □□□□*
572	107	504	65	200-250-300-350-400-450-500-600	21,49	35LPC504 □□□□*
C+68	107	....	65	200-250-300-350-400-450-500-600		35LPC □□□□□□**

\*Complete the code by inserting the value of the radius (R): Ex. 35LC154□□□□

\*\*Complete the code by inserting the value of the quote C and the radius (R): Ex. 35LPC□□□□□□

### 40LPT with aluminium draw plates

A	B	C	D	R	Weight/m	Chain
mm	mm	mm	mm	mm	kg	Part Number
230	161,5	150	112,5	250-300-350-400-450-500-550-600-700-750-850	20,71	40LPT150 □□□*
280	161,5	200	112,5	250-300-350-400-450-500-550-600-700-750-850	21,17	40LPT200 □□□*
330	161,5	250	112,5	250-300-350-400-450-500-550-600-700-750-850	21,63	40LPT250 □□□*
380	161,5	300	112,5	250-300-350-400-450-500-550-600-700-750-850	22,09	40LPT300 □□□*
480	161,5	400	112,5	250-300-350-400-450-500-550-600-700-750-850	23,02	40LPT400 □□□*
580	161,5	500	112,5	250-300-350-400-450-500-550-600-700-750-850	23,94	40LPT500 □□□*
C+80	161,5	....	112,5	250-300-350-400-450-500-550-600-700-750-850		40LPT □□□□□□**

\*Complete the code by inserting the value of the radius (R): Ex. 40LPT150 □□□□

\*\*Complete the code by inserting the value of the quote C and the radius (R): Ex. 40LPT □□□□□□□□

### Aluminium split cross pieces created by design

A	B	R	Chain
mm	mm	mm	Part Number
SL+44	161,5	250-300-350-400-450-500-550-600-700-750-850	40LPA □□□□□□□□**

\*\*Complete the code by inserting the value of SL and of the radius (R): Ex. 40LTA □□□□□□□□

### 40LPC with aluminium covers

A	B	C	D	R	Weight/m	Chain
mm	mm	mm	mm	mm	kg	Part Number
230	161,5	150	104	250-300-350-400-450-500-550-600-700-750-850	23,96	40LPC150 □□□□*
280	161,5	200	104	250-300-350-400-450-500-550-600-700-750-850	25,33	40LPC200 □□□□*
330	161,5	250	104	250-300-350-400-450-500-550-600-700-750-850	26,69	40LPC250 □□□□*
380	161,5	300	104	250-300-350-400-450-500-550-600-700-750-850	28,05	40LPC300 □□□□*
480	161,5	400	104	250-300-350-400-450-500-550-600-700-750-850	30,77	40LPC400 □□□□*
580	161,5	500	104	250-300-350-400-450-500-550-600-700-750-850	33,50	40LPC500 □□□□*
C+80	161,5	....	104	250-300-350-400-450-500-550-600-700-750-850		40LPC □□□□□□**

\*Complete the code by inserting the value of the radius (R): Ex. 40LPC150 □□□□

\*\*Complete the code by inserting the value of the quote C and the radius (R): Ex. 40LPC □□□□□□□□

### 42LPT with aluminium covers

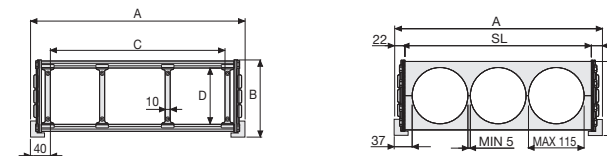

A	B	C	D	R	Weight/m	Chain
mm	mm	mm	mm	mm	kg	Part Number
230	191,5	150	138	250-300-350-400-450-500-550-600-700-750-850	24,25	42LPT150 □□□□*
280	191,5	200	138	250-300-350-400-450-500-550-600-700-750-850	24,71	42LPT200 □□□□*
330	191,5	250	138	250-300-350-400-450-500-550-600-700-750-850	25,17	42LPT250 □□□□*
380	191,5	300	138	250-300-350-400-450-500-550-600-700-750-850	25,63	42LPT300 □□□□*
430	191,5	400	138	250-300-350-400-450-500-550-600-700-750-850	26,56	42LPT400 □□□□*
580	191,5	500	138	250-300-350-400-450-500-550-600-700-750-850	27,48	42LPT500 □□□□*
C+80	191,5	....	138	250-300-350-400-450-500-550-600-700-750-850		42LPT □□□□□□**

\*Complete the code by inserting the value of the radius (R): Ex. 42LPT150 □□□□

\*\*Complete the code by inserting the value of the quote C and the radius (R): Ex. 42LPT □□□□□□□□



Sliding low-friction skids fastened to the links allow chains running on themselves, all the while granting them to get more longer strokes. Aluminium Draw Plates with nylon separators or aluminium split cross piece created by design. Separators system available.

<sup>(1)</sup> Available in Stainless steel

### 40LPT

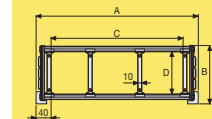

### 40LPA

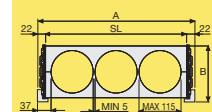

### 40LPC

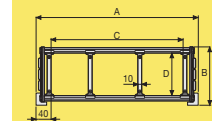

For further information please consult Brevetti Stendalto's Technical Office

## Cable Drag Chains in Steel for Long Travel Distance

The use of cable chains in applications with particularly long travel distances offers many benefits. The possibilities of the combined transportation of high power cables, signal cables and hydraulic hoses, together with ease of use and no need for maintenance, are the unquestionable advantages of the system. Specific applications, characterised by particularly aggressive conditions in the environment, require cable chains in steel. Brevetti Stendalto has offered for many years, with positive results their own system based on the use of two steel drag chains and a travelling internal supporting frame. The chains are arranged in a closed loop configuration, having

a fixed bracket and a movable towing bracket. A secondary similar closed loop, made of steel wire rope, drives the supporting frame along the entire travel at a suitable speed, thus ensuring a continuous support to relieve all stresses. In addition to this a trough is arranged to contain and guide the chain system along the total travel. The chains are fitted with wheels on ball bearings, to keep to a minimum the friction on the supporting frame. The supporting frame can be made both in galvanised steel, or if requested, in stainless steel.

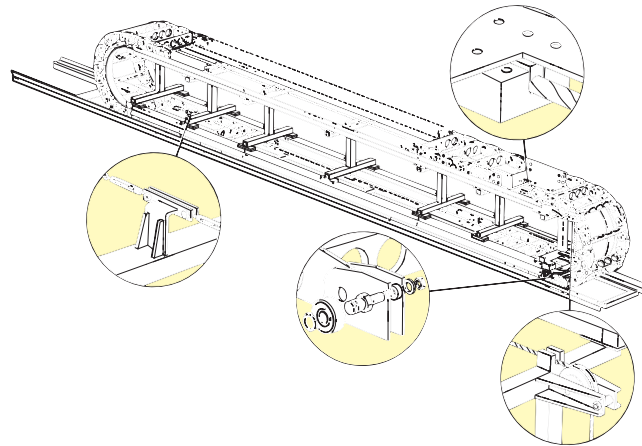

35 chains with supporting frame applied to De Icing equipment at München airport (Germany). The length of the travel distance is 90 m and it's velocity is 90 m per minute.



## Special off-shore Applications

The Brevetti Stendalto steel cable chains have been used in Off-shore applications for many years. The high standard of quality required and the special materials needed are characteristics in these kinds of applications.

On request cable chains of special dimensions which have been personalised according to the clients needs are being used.

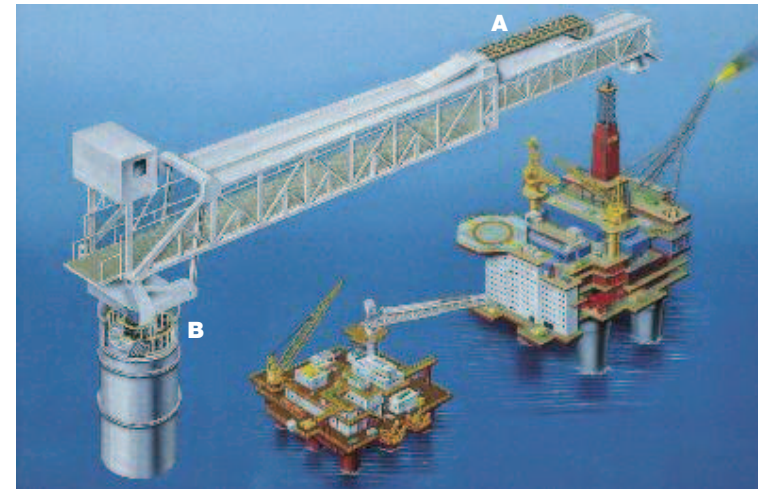

Platform "Oseberg"

A: 45 chain in stainless steel 316L

B: 45 chain in stainless steel 316L for rotations of  $\pm 180^\circ$



Platform "Tiffany"

Specially designed chains in stainless steel 316L  
Length of travel distance: 27 m  
Total weight of the chains: 13 Ton.



# Steel Cable Conduit

- Construction:** steel helix-wire conduit with packingless link junction
- Material:** cold-milled non-alloy steel grade St 3 (1.0330), DIN 1624, bright zinc-plated
- Quality:** highly flexible, resistant against traction and compression
- Use:** protection of electric cables and flexible hoses

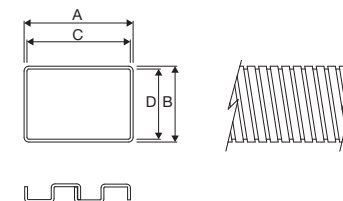

DIMENSIONS and CHARACTERISTICS								
Outer dimensions		Inner dimensions		Bend radius		Maximum unsupported length ( m )	Weight $\pm 10\%$ ( kg/m )	Part number
A x B	Tolerance	C x D	Tolerance	Radius	Tolerance			
50 x 30	+ 1	47,0 x 26,8	- 1	70	- 10	1,5 - 2,0	2,00	GPC015□□□□*□**
50 x 50	+ 1	46,8 x 46,8	- 1	120	- 10	1,5 - 2,0	2,50	GPC025□□□□*□**
85 x 45	+ 1	81,0 x 40,8	- 1	100	- 10	2	3,00	GPC038□□□□*□**
65 x 65	+ 1	60,8 x 60,8	- 1	130	- 10	2	2,14	GPC042□□□□*□**
85 x 60	+ 1	81,0 x 55,8	- 1	130	- 10	2	3,50	GPC051□□□□*□**
115 x 60	+ 1	110,2 x 54,8	- 1	130	- 20	2	4,80	GPC069□□□□*□**
115 x 80	+ 1	110,0 x 74,6	- 1	170	- 20	2,0 - 2,5	5,30	GPC092□□□□*□**
140 x 90	+ 1	135,0 x 84,6	- 1	180	- 20	2,0 - 2,5	6,60	GPC126□□□□*□**
175 x 80	+ 1	169,8 x 74,4	- 1	170	- 20	2,0 - 2,5	7,20	GPC140□□□□*□**
140 x 110	+ 1	134,4 x 104,0	- 1	250	- 20	2,0 - 2,5	6,12	GPC154□□□□*□**
175 x 110	+ 1	169,6 x 104,2	- 1	250	- 20	3	8,20	GPC193□□□□*□**
220 x 110	$\pm 1,5$	214,4 x 104,4	- 1	250	- 20	3	7,82	GPC242□□□□*□**

\*Complete the code by inserting flange type: e.g. GPC1015□□□□□□□□□□

\*\*Complete the code by inserting flange mounting version: e.g. GPC1015FSF1□□

# Steel Cable Conduit

# Steel Cable Conduit

## Flanges

### STANDARD FLANGES FS

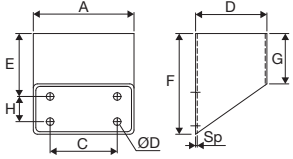

DIMENSIONS and CHARACTERISTICS									
Part number	Standard flanges								
	A	B	C	ØD	E	F	G	H	Thk.
GPC015...	54	34	20	7	45,0	60	30	-	2,0
GPC025...	54	54	20	7	45,0	60	30	-	2,0
GPC038...	90	50	50	7	67,5	90	45	-	2,0
GPC042...	70	70	50	7	67,5	90	45	-	2,0
GPC051...	90	65	50	7	67,5	90	45	-	2,0
GPC069...	120	65	80	9	70,0	120	60	40	2,0
GPC092...	120	85	80	9	70,0	120	60	40	2,0
GPC126...	145	95	105	9	70,0	120	60	40	2,0
GPC140...	180	85	140	9	97,5	165	80	50	2,0
GPC154...	145	115	140	9	97,5	165	80	50	2,0
GPC193...	180	115	140	9	97,5	165	80	50	2,0
GPC242...	225	115	150	9	97,5	165	80	50	2,0

### FRONTAL FLANGES TYPE F1

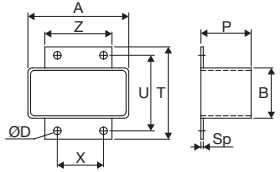

DIMENSIONS and CHARACTERISTICS									
Part number	Frontal flanges type 1								
	A	B	P	T	U	Z	X	ØD	Thk.
GPC015...	54	34	30	70	55	35	18	7	2,0
GPC038...	90	50	45	85	70	65	45	7	2,0
GPC069...	120	65	60	110	90	80	60	9	2,0
GPC140...	180	85	80	130	110	120	90	9	2,0

### FRONTAL FLANGES TYPE F2

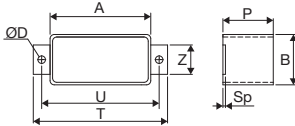

DIMENSIONS and CHARACTERISTICS									
Part number	Frontal flanges type 2								
	A	B	P	T	U	Z	ØD	Thk.	
GPC015...	54	34	30	90	75	15	7	2,0	
GPC038...	90	50	45	120	105	30	7	2,0	
GPC069...	120	65	60	160	140	35	9	2,0	
GPC140...	180	85	80	220	200	40	9	2,0	

### FRONTAL FLANGES TYPE F3

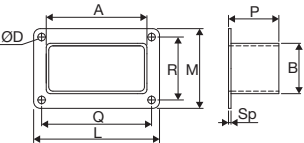

DIMENSIONS and CHARACTERISTICS									
Part number	Frontal flanges type 3								
	A	B	L	M	ØD	P	Q	R	Thk.
GPC015...	54	34	85	65	7	30	70	50	2
GPC025...	54	54	85	85	7	30	70	70	2
GPC038...	90	50	120	80	7	45	105	65	2
GPC042...	70	70	100	100	7	45	105	85	2
GPC051...	90	65	120	95	7	45	105	80	2
GPC069...	120	65	150	95	9	60	135	80	2
GPC092...	120	85	150	115	9	60	135	100	2
GPC126...	145	95	175	125	9	60	160	110	2
GPC140...	180	85	210	115	9	80	195	100	2
GPC154...	145	115	175	145	9	80	160	130	2
GPC193...	180	115	210	145	9	80	195	130	2
GPC242...	225	115	255	145	9	100	240	130	2

## Determining conduit length

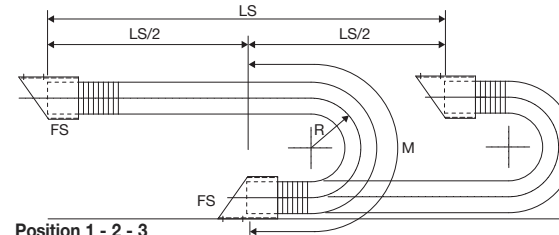

Position 1 - 2 - 3

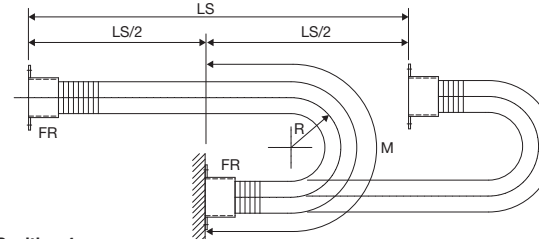

Position 4

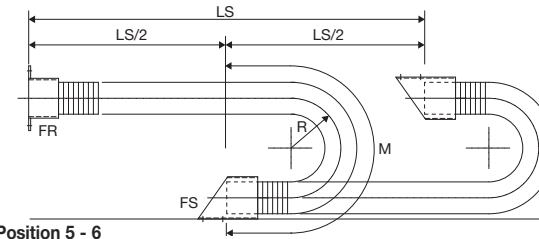

Position 5 - 6

Conduits can be supplied up to a maximum length of 5 m.  
If the unsupported length (LS/2) is more than 2.5 m, it is necessary to use support rollers.

Conduit length  
 $L = LS/2 + M$

Bend radius	M
70	290
100	414
120	497
130	538
170	704
180	745
250	1035

## Flanges and mounting versions

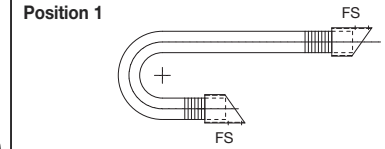

Position 1

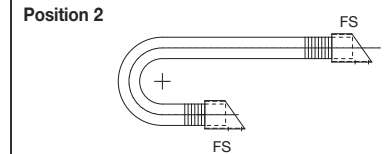

Position 2

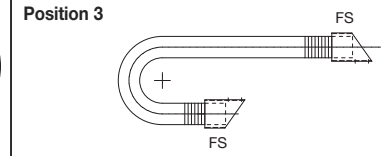

Position 3

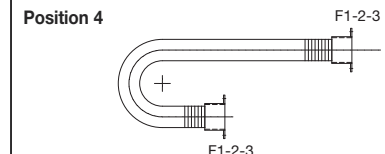

Position 4

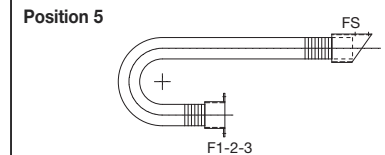

Position 5

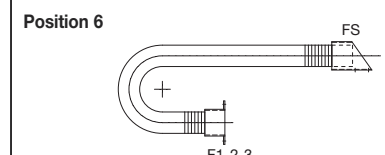

Position 6



## Flexible Cables for Cable Chains

### Characteristics

Brevetti Stendalto, aware of the continuous development of the high technology production processes, offers a number of flexible and high flexible cables, constructed according to the most recent technologies. These high flexible cables enable a continuous operation for multi-shift-work under conditions of extreme bending stress<sup>(1)</sup>, for example industrial robots, machine tools and for the working of wood, automation systems etc.

The protection control according to the DIN VDE rules, gives a certificate showing the high standard of quality of the Brevetti Stendalto cables.

The wide choice of products composed of different types of cables, allows us to answer to the growing demand from all parts of the technical department.

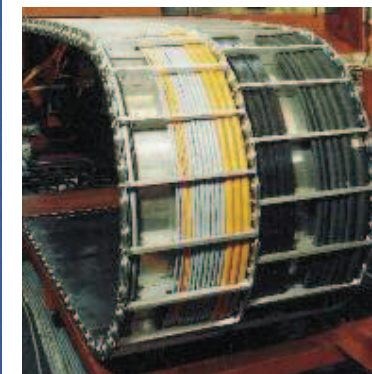

<sup>(1)</sup> The Brevetti Stendalto cables have been tested with accelerations exceeding 20 m/s<sup>2</sup> and speed of 6 m/s.



# Flexible Cables

## Installation

For correct installation of cables in the cable chain, it is important to follow the guidelines listed below:

- 1- The cables have to be installed and unrolled from the drum carefully to avoid damage. It is therefore important to follow the indications in Fig.1. The coil should not be unrolled from the centre, but it should be placed on a support or on a turning plane and then be unrolled starting from the external ends.
- 2- Check the minimum allowed bending radius of the chosen cable and compare it with the bending radius of the chain. For a correct installation, the last mentioned should be larger compared to the bending radius of the cable.
- 3- There must be at least 10%-20% free space between the cable diameters and the internal dimensions of the chain. Install the cables/hoses symmetrically in the chain with the larger and heavier towards the outside and the smaller and lighter in the centre. Further, it is necessary to separate the cables using the separators, available for all the chains, or the split cross pieces with holes done in the appropriate sizes according to the external diameter of the cable.
- 4- The cables/hoses must be placed and installed in such a way so that they can move freely side ways during the movement of the chain and also so that in the bending curve they do not cause any tension or traction on the cable chain.
- 5- The cables/hoses must be installed and fixed using the appropriate accessories (see pages 226/227), at both extremities of the chain.
- 6- Verify the installation of the cables in the chains with Brevetti Stendalto's technical office or request a personalised project by filling in the appropriate module (page 229).

Fig. 1

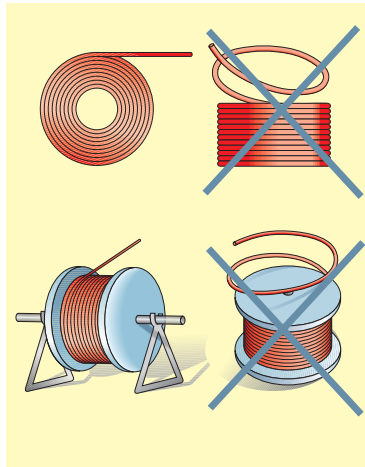
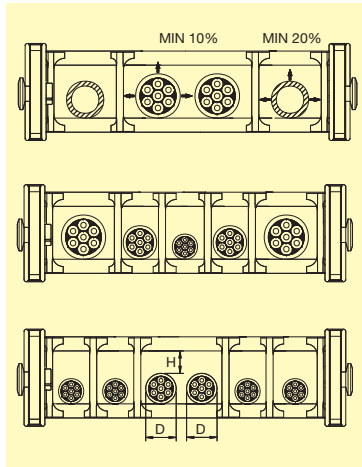
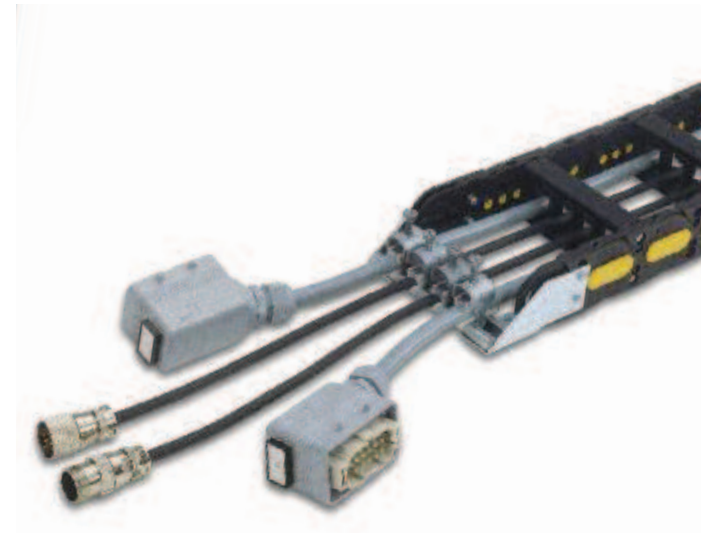

Fig. 2



## Ready to Install Chains with Electrical Cables

On request chain ready to be used with cables and plugs connected. Please contact our sales departments for further information.



## With Hydraulic Hoses

On request chain ready to be used with hydraulic hoses. Please contact our sales departments for further information.



## Custom-Built Packaging

For very large chains, example offshore applications, harbour cranes, steel mills, Brevetti Stendalto offers on request custom-built

packaging, for save transport and facilitated assembling on-site.

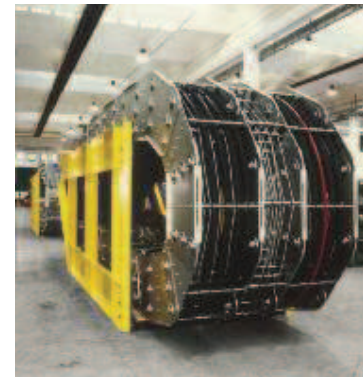

## Flexible Cables

### Tiewrap Clamp in Nylon

To allow easy fixing of the cables at the chain's end brackets, Brevetti Stendalto offers strong nylon tiewrap clamps.

The tiewrap is mounted on to a steel profile to assure a strong support.

This fixing system is available for our Heavy, Sliding and Protection series.



### Steel Cable Clamps

The steel cable clamps connect the cable to the extremities of the chain.

The plastic counter pressure cradle with the integrated screw tighten and fix the cable.

The smooth surface and the design of the cradles guarantee high stability and avoid any damage to the cables.

Special versions are available on request.

Fixing set is composed by the following parts:

- steel clamps with pressure cradle
- counter pressure cradle
- doublesided cradle for double and triple clamps
- steel mounting rails



Fig. A

## Zinc-plated Steel cable clamps

C-profile rail

Part.no	Length
6000002	Standard 1000 mm; available on request with different length

Single clamp in zinc-plated steel with 1 pressure cradle and 1 counter pressure cradle

Part.no	Diameter mm	L	H max-
6000614C	06-14	20	64
6001418C	14-18	22	73
6001822C	18-22	26	77
6002226C	22-26	30	81
6002630C	26-30	34	85
6003034C	30-34	38	90
6003438C	34-38	43	100
6003842C	38-42	47	113
6004246C	42-46	52	120
6004650C	46-50	58	130
6005054C	50-54	68	139
6005458C	54-58	75	147
6005864C	58-64	82	155
6006470C	64-70	90	163

Double clamp in zinc-plated steel set complete with 1 pressure cradle, 1 double sided cradle and 1 counter pressure cradle

Part.no	Diameter mm	L	H max-
6020608C	06-08	20	64
6020810C	08-10	20	88
6021014C	10-14	20	88
6021418C	14-18	21	94
6021822C	18-22	26	110
6022226C	22-26	30	121
6022630C	26-30	34	128
6023034C	30-34	38	134
6023438C	34-38	43	156
6023842C	38-42	47	165

Triple clamp in zinc-plated steel set complete with 1 pressure cradle, with plastic insert, 2 double sided cradles and 1 counter pressure cradle

Part.no	Diameter mm	L	H max-
6031012C	10-12	16	87
6031214C	12-14	17	97
6031416C	14-16	19	102
6031618C	16-18	22	112
6031820C	18-20	24	116
6032022C	20-22	26	129
6032224C	22-24	28	133
6032426C	24-26	31	143
6032628C	26-28	33	150
6032830C	28-30	35	158

Counter pressure cradle

Part.no	Diameter mm	Part.no	Diameter mm
6100612	06-12	6103842	38-42
6101214	12-14	6104246	42-46
6101618	14-18	6104650	46-50
6101822	18-22	6105054	50-54
6102226	22-26	6105458	54-58
6102630	26-30	6105864	58-64
6103034	30-34	6106470	64-70
6103438	34-38		

Doublesided cradle

Part.no	Diameter mm	Part.no	Diameter mm
6201012	10-12	6202426	22-26
6201214	12-14	6202830	26-30
6201416	14-16	6203034	30-34
6201618	16-18	6203438	34-38
6201822	18-22	6203842	38-42

Plastic insert for triple clamp

Part.no	Diameter mm	Part.no	Diameter mm
6300612X	10-12	6201822X	20-24
6301214X	12-14	6202226X	24-26
6301416X	14-16	6202630X	26-30
6301618X	16-20		

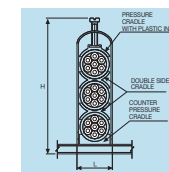
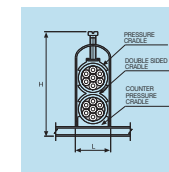
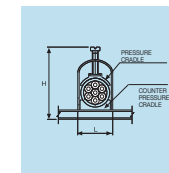
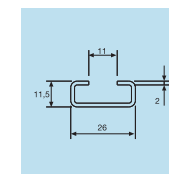







All rights reserved. No part of this publication may be reproduced, translated or transmitted in any form or by any means.  
All informations contained in this publication should be taken only as a guide for the use of Brevetti Stendalto products; no responsibility can be accepted for any error or omission. Brevetti Stendalto S.p.A. reserved the rights, without notice, to change design and construction of any products.  
Printed by July 2018.



CABLE **CHAINS** CABLE **CHAINS** CABLE **CHAINS** CABLE **CHAINS**

[www.brevettistendalto.com](http://www.brevettistendalto.com)

Your local distributor



**Brevetti Stendalto S.p.A.**

Viale G.B. Stucchi 66/8  
20900 Monza (MB) Italy  
Tel. +39 039 204901  
Fax +39 039 834250  
Internet: [www.brevettistendalto.com](http://www.brevettistendalto.com)  
E-mail: [info@brevettistendalto.it](mailto:info@brevettistendalto.it)

