

BANNER[®]
more sensors, more solutions

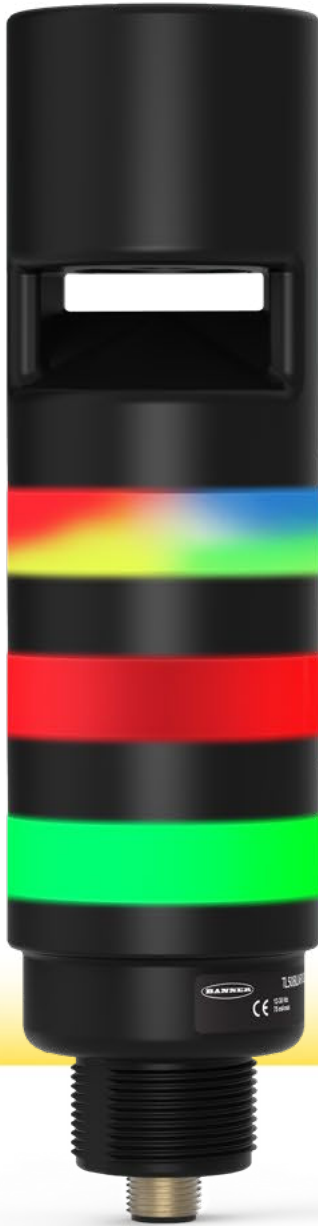

Lighting & Indication

5th edition



LED Task Lights



Tower Lights



Indicators



Touch Buttons and Pick-to-Light

Contents

Light Up the Visual Factory	2
--	----------

Banner's Lighting and Indication Solutions

LED Lighting.....	13
-------------------	----

Robust, high-quality and energy-efficient LED Lighting products have sleek designs and are ideal for a wide range of industrial and mobile applications.

Signal Tower Lights.....	45
--------------------------	----

Premium LED-based, stylish Signal Tower Lights are completely flexible with preassembled or modular models to suit application needs, and have a wide range of mounting accessories for quick and easy installation.

Indicators.....	63
-----------------	----

Rugged Indicators require no additional protective enclosure and are flexible in design, size and mounting for a unique indication solution.

Touch Buttons and Pick-to-Light	97
---------------------------------------	----

Touch Buttons come in a variety of options for lighting and touch functions and have unique, rugged packages that require no additional protective enclosure.

Rugged, unique Pick-to-Light products help reduce assembly time and increase quality for online and offline operator guidance processes.

Vision Lighting.....	140
----------------------	-----

New Products.....	142
--------------------------	------------

How to Reach Us	144
------------------------------	------------

Light Up the Visual Factory

Enhance your Visual Management Efforts with Banner's Lighting and Indicators.



Illuminate the Work Area with LED Lighting

page 13

- Boost Worker Productivity
- Improve Product Quality
- Reduce Energy Costs

Electrical Panel Lighting

Machine Lighting

Workstation Lighting

Visual Inspection Station

Sensor Emulation

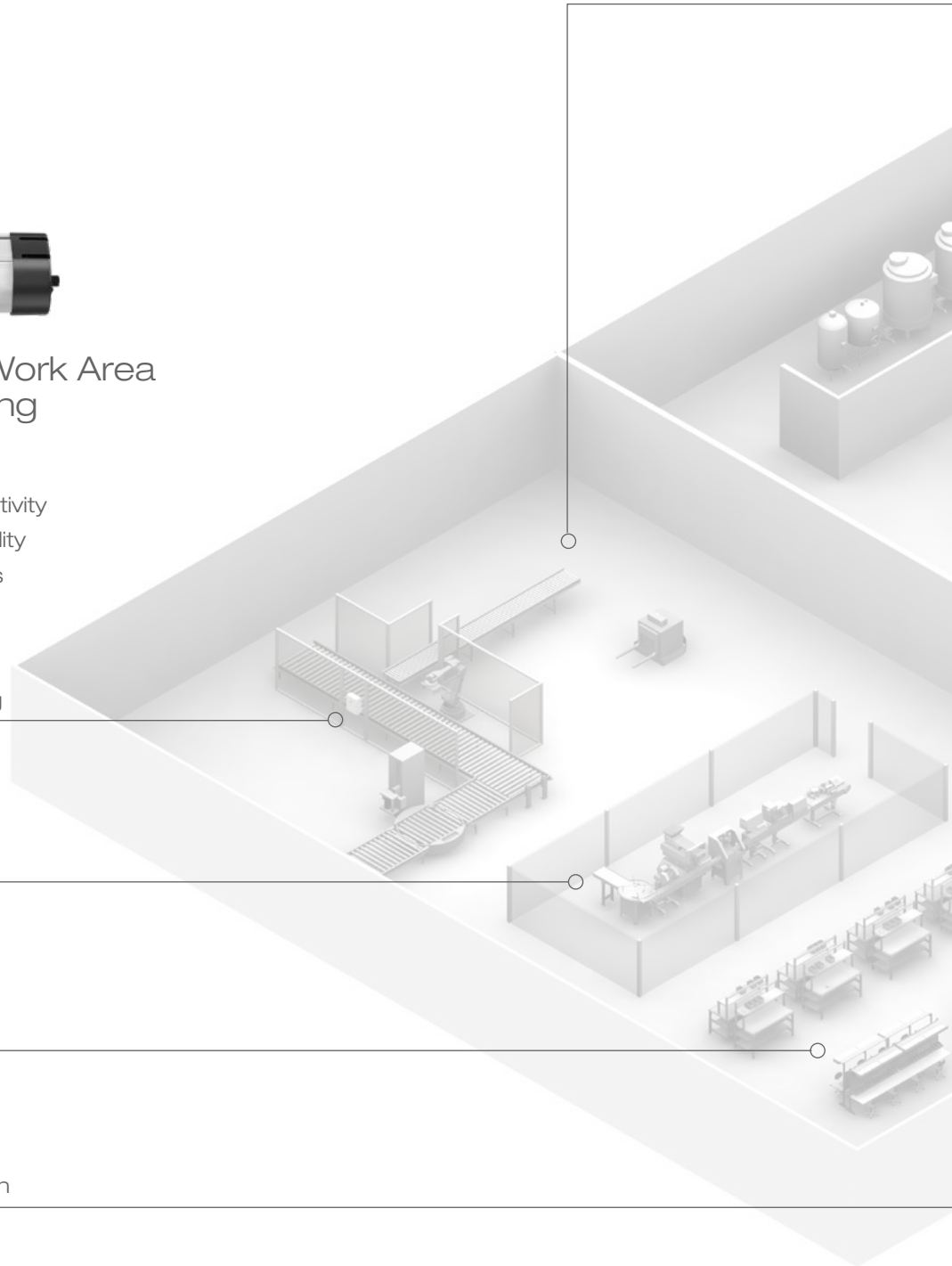

Communicate Status

pages 45, 63

- Empower Operators
- Alert Supervisors
- Accelerate Resolution



Machine and
Process Status

Call for
Parts

Loading Dock/Bay
Communication

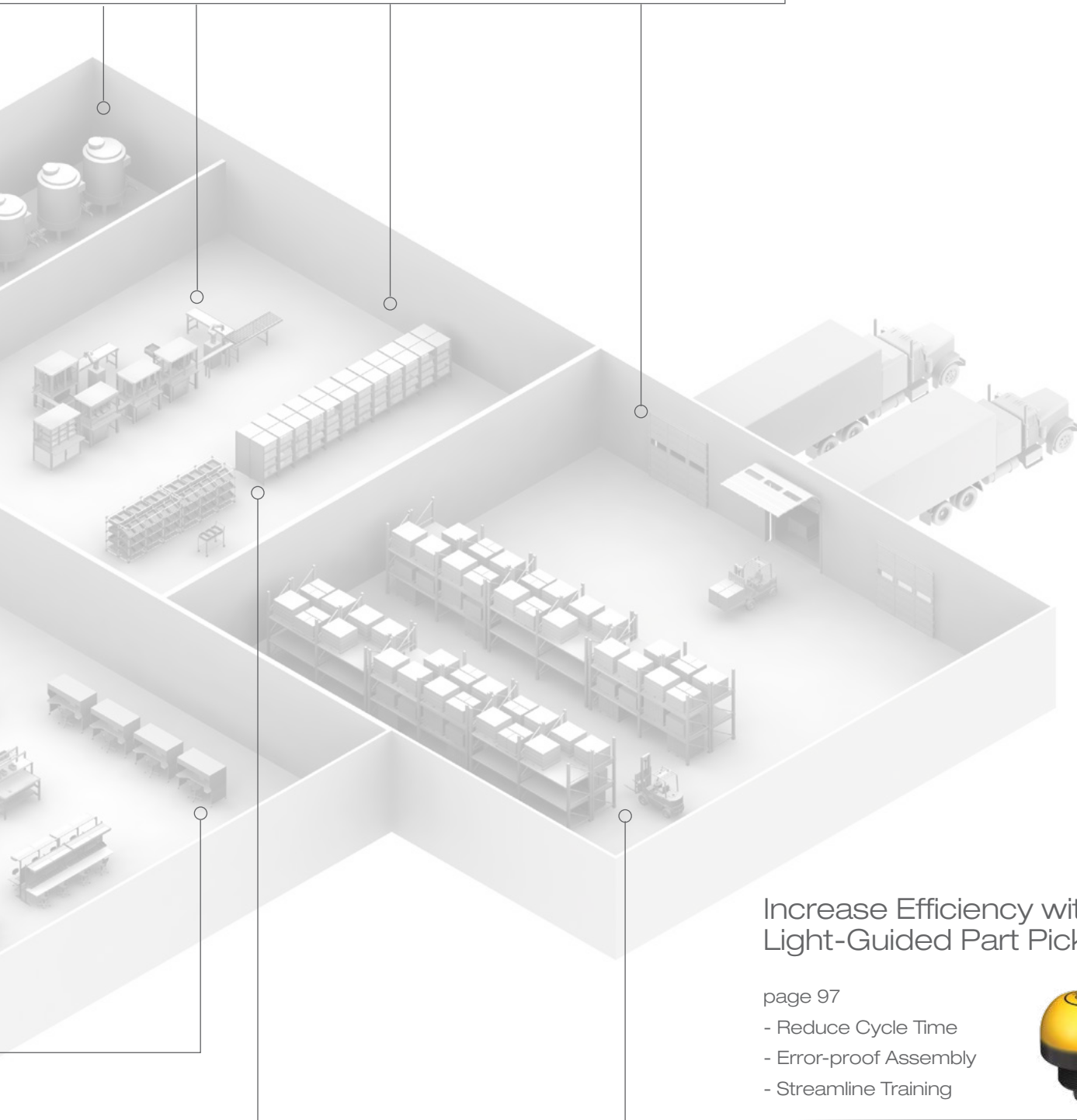

Increase Efficiency with Light-Guided Part Picking

page 97

- Reduce Cycle Time
- Error-proof Assembly
- Streamline Training



Pick-to-Light for
Assembly and Kitting

Pick-to-Light for
Warehouse and Logistics

Lights to See

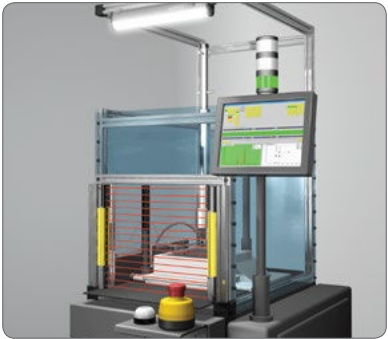
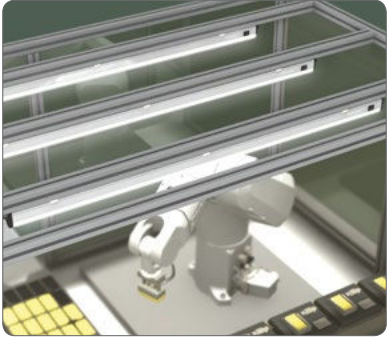

Increase productivity, improve product quality and reduce costs with Banner's industrial LED lighting products. Banner has a suitable model for the harshest environments – even chemical, extreme temperature and washdown areas.

Boost Productivity – Proper light levels increase the speed and accuracy of visual task performance, reducing assembly times and increasing output.

Enhance Inspection – White, colored and multicolored options in different form factors allow for control of color, intensity and angle, improving detection of part defects during assembly and inspection.

Reduce Costs – Industrial grade construction and electronics provide ultra-long lifetimes, energy savings and fast installation

Lights to Follow

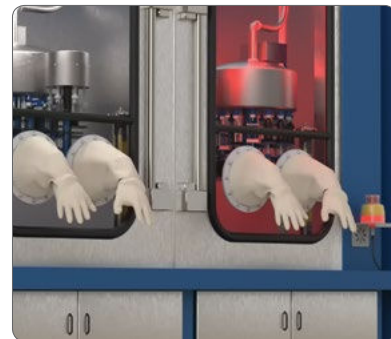
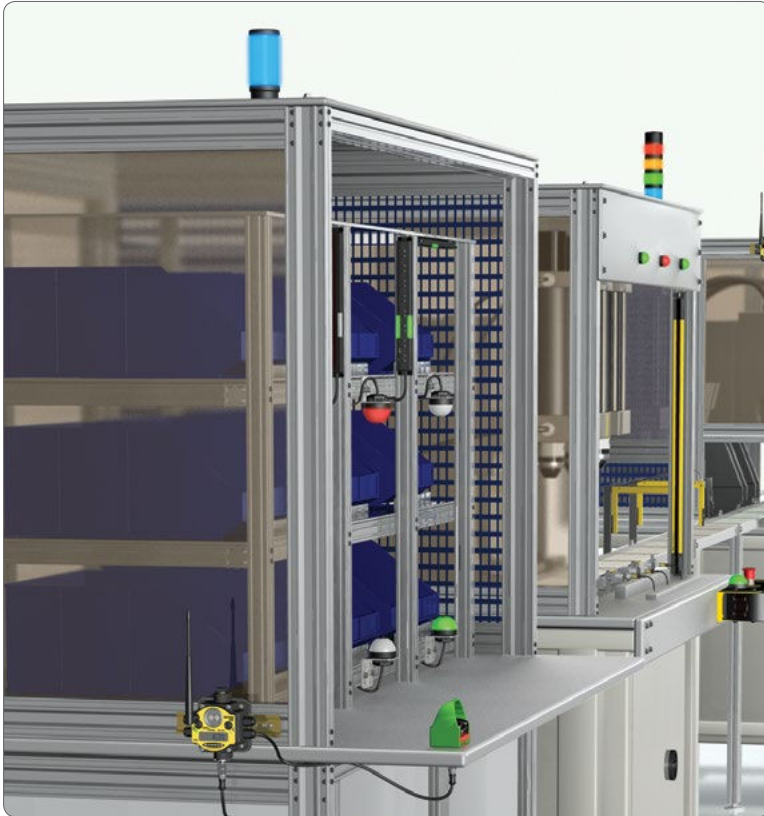

Highly visible indicators with real-time feedback provide guidance and status information for assembly and kitting applications.

Accelerate Processes – Colored indicators guide operators quickly to the correct part location and accelerate training procedures.

Improve Quality – Integrated feedback drives increased operator accuracy and provides quality control metrics.

Save Time – Varied hardware solutions and mounting options are easily installed and updated.

Give Equipment a Voice

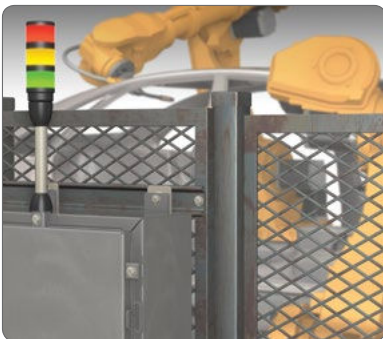

Machine status indicators with clear on and off states provide improved communication across the manufacturing floor. Wireless options simplify installation, facilitate remote monitoring and data collection, and allow for rapid status communication in and out of the plant.

Reduce Downtime – Immediate attention to problems as they occur reduces downtime, improves quality and reduces safety issues.

Speed Recognition – Status is conveyed through color, position, text, symbols or audible alarm. No time is lost deciphering the information.

Speak Globally – Products are certified for use around the world and conform with international standards. Rely on Banner's vast network to support you fully.

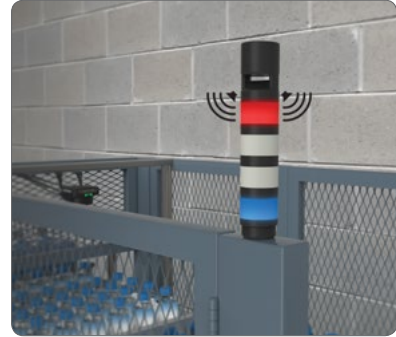

Operators and supervisors with clear information when and where they need it react quickly and correctly, resulting in efficient problem resolution. Long term gains in overall equipment effectiveness follow from continued monitoring and data analysis.

Empower Operators – Illuminated indicators, touch buttons and E-stops show status clearly, giving workers the ability to act quickly and confidently when problems occur.

Alert Supervisors – Tower lights, indicators and advanced lights communicate machine, work cell and inventory status, helping supervisors identify and resolve issues effectively

Maximize Uptime - Wireless and standard devices can track machine and operator performance, allowing for effective scheduling of maintenance and changeovers.

Trends

Illumination + Indication

Multiply the value of your device - adding indication to illumination unlocks countless new applications. EZ-STATUS models are bright and versatile.

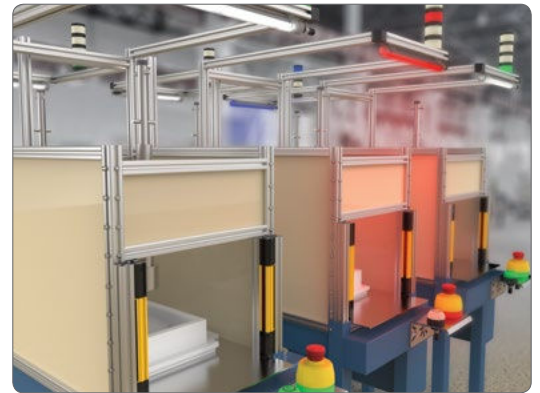

Supply Chain Simplification

Standardizing on a single, flexible model simplifies ordering and spare parts without sacrificing functionality.



Cascadeable lights



Multiple colors in one unit with flexible I/O configuration



Magnetic mounting options for easy installation and portability

Customization

Work with Banner on a variety of modifications to get exactly the solution you need.



Light sections can be permanently laser marked with custom text or images

Variety of audible options, including programmable



Wireless options to avoid costly wiring runs



Color and animation options available



IO-Link

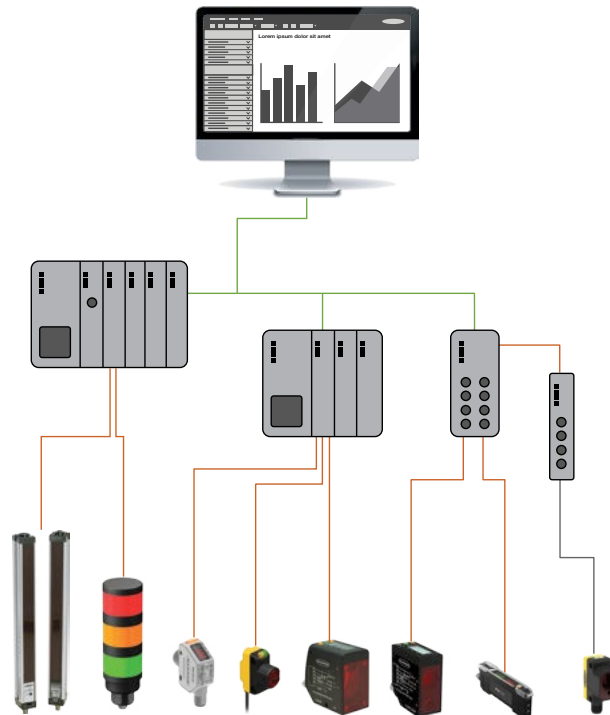

What is IO-Link?

IO-Link (IEC61131-9) is an open standard serial communication protocol that allows for the bi-directional exchange of data from sensors and devices that support IO-Link and are connected to a master. The IO-Link master can transmit this data over various networks, fieldbuses, or backplane buses, making the data accessible for immediate action or long-term analysis via an industrial information system (PLC, HMI, etc.). Each IO-Link sensor has an IODD (IO Device Description) file that describes the device and its IO-Link capabilities.

5 Advantages of IO-Link

1. Standardized and Reduced Wiring

IO-Link devices do not require any special or complicated wiring, but can be connected using the same cost-effective standard unshielded 3-wire cables as conventional discrete I/O. In addition, IO-Link also eliminates the need for analog sensors and reduces the variety of cord sets required for sensors, which saves inventory costs. IO-Link also supports a master-slave configuration with passive connection points, which further reduces wiring requirements.

2. Increased Data Availability

Access to sensor-level data helps ensure the smooth operation of system components, streamlines device replacement, and enables optimized machine maintenance schedules—all of which save costs and reduce the risk of machine downtime.

This wealth of valuable data made available through IO-Link is integral for the Industrial Internet of Things (IIoT) and Industry 4.0 initiatives.

3. Remote Configuration and Monitoring

With IO-Link, users can read and change device parameters through the control system software, enabling fast configuration and commissioning that saves time and resources. In addition, IO-Link allows operators to dynamically change the sensor parameters from the control system as needed—such as in the case of product changeover—which reduces downtime and allows machines to accommodate greater product diversity.

In addition, the ability to monitor sensor outputs, receive real-time status alerts, and adjust settings from virtually anywhere allows users to identify and resolve problems that arise on the sensor level in a timely manner. This capability reduces costly downtime and improves overall efficiencies.

4. Simple Device Replacement

In addition to the ability to remotely adjust sensor settings, IO-Link's data storage capability also allows for automated parameter reassignment in case of device replacement (also known as Auto-Device Replacement or ADR). Users can import existing sensor parameter values into a replacement sensor for seamless replacement, getting the new device up and running as quickly as possible.

5. Extended Diagnostics

IO-Link provides users with visibility into errors and health status from each device. This means that users can see not only what the sensor is doing but also how well it is performing—a valuable insight into a machine's efficiency. In addition, extended diagnostics allow users to easily identify when a sensor is malfunctioning and diagnose the problem without shutting down the line or machine.

The combination of real-time and historic data not only reduces troubleshooting efforts as issues arise but also allows for optimization of machine maintenance schedules, saving costs and increasing efficiency in the long term.

Wireless Monitoring and Status Indication

Wireless monitoring and indication products from Banner Engineering can increase productivity, reduce downtime, and provide data to optimize your operation. Banner's wireless products eliminate expensive cable runs, are easy to install and set up, and can integrate machines that were not previously network capable.

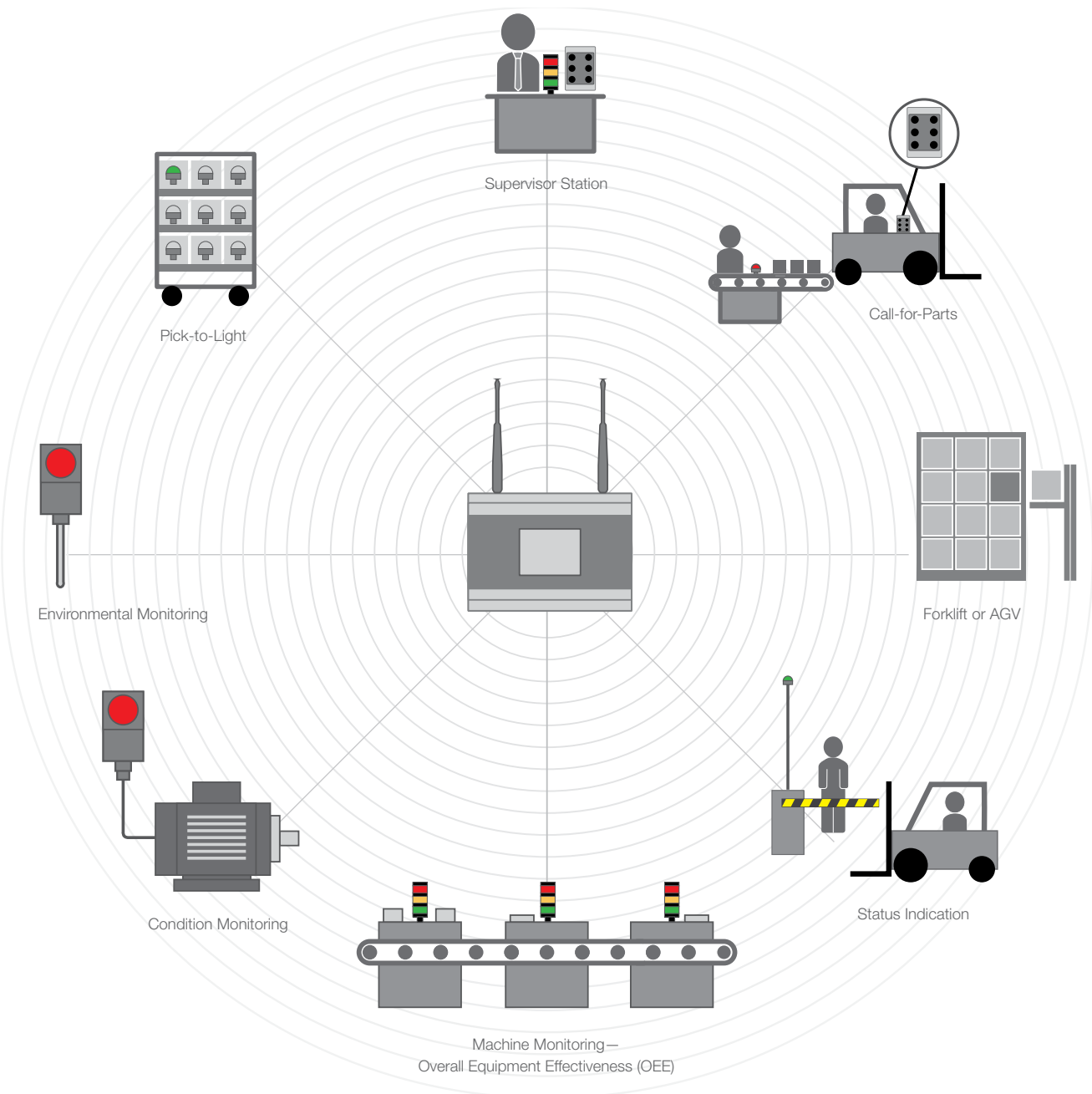

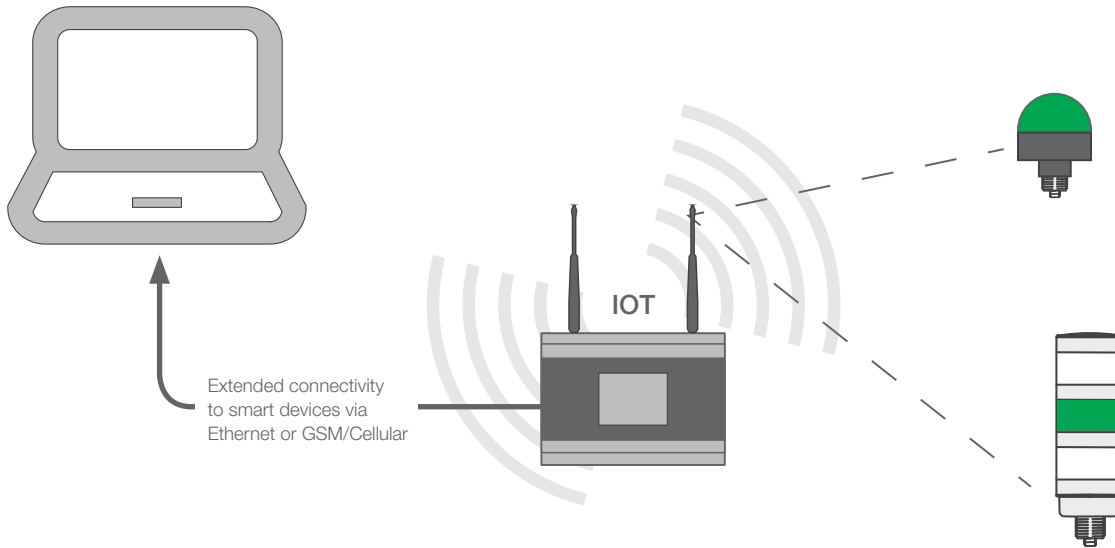

Wireless TL70 Tower Light

A bright 70 mm tower light with wireless networking provides local and remote status information and has inputs for process monitoring.
page 48



Wireless Q120 6-Button Pendant

The wireless Q120 6-button pendant is an autonomous node with six independent push button inputs and six sets of LED indicators.



Wireless K70 Touch Button

The K70 touch button is an ergonomic solid state switch with integrated multicolor indication functions. Bidirectional wireless communication provides a simple operator interface for pick-to-light, call button, and general industrial applications.
page 108



Wireless Q45U Node

The Q45 universal node works with all Sure Cross® sensors with a 1-wire serial interface.



Wireless K70 Indicator

Bright, multicolor K70 indicators offer status indication and remote monitoring in a compact package for greater versatility in deployment.
page 72



Control Your Wireless Networks with the DXM100 Controller

The DXM100 is an industrial wireless controller developed to facilitate Ethernet connectivity and Industrial Internet of Things (IIoT) applications.



Node

The Node collects data and wirelessly transmits this data to the Gateway.



Gateway

The Gateway accepts data and interfaces to the control system and plant networks or can be wired directly to discrete I/O devices.





LED Lighting

Banner Engineering's industrial LED lighting products are high-quality and energy-efficient lights that provide bright illumination for up to 50,000 hours. Robust, vibration-resistant housings and sleek designs make Banner Engineering's LED lighting ideal for a wide range of industrial applications, including machine lighting, enclosure lighting, visual inspection illumination and work cell lighting.

Selection Guide



Page	16	26	20	22	24
Family Name	WLS28-2	WLS27	WLS15	WLB32	WLB92
Length (mm)	145 to 1130	145 to 1130	220 to 1200	285 to 1130	550 and 1100
AC/DC	DC	DC	DC	AC and DC	AC and DC
Lumens per Foot (300 mm)	650	650	350	650	1750
Dual/Multi Color Options					
Color Options					
IP Rating	IP50 (unsealed) IP67, IP69K (sealed)	IP66, IP67, IP69K	IP66, IP67	IP50	IP40
Cascadeable					



30

30

32

34

36

38

WLC60

WLH60
High Temp

WLC90

WLA

WL50S

WL50-2

340 and 640

340 and 640

89 x 91

105 x 180 to
360 x 180

ø 50

ø 50

DC

DC

DC

DC

DC

DC

1300

1000

700

550

295

185



IP68, IP68g, IP69K

IP68, IP69K

IP68, IP68g, IP69K

IP67, IP69K

IP67, IP69K

IP67, IP69K





WLS28-2 LED Strip Lights

- Compact, space-saving design
- Rugged, water-resistant IP69K option
- Available in 8 lengths from 145 to 1130 mm
- Lensed models or choice of clear or diffuse window
- Cascade models for connecting multiple lights end-to-end, minimizing wiring
- UV 365 nm and 395 nm wavelength models available for UV fluorescent and non-fluorescent applications
- High/Lo/Off switch and non-switch models available
- Low power consumption less than 9 watts per foot
- Optional snap clips for easy installation and repositioning
- Automatic temperature protection built into the unit. Above 50 °C, the light dims to manage heat and protect product lifetime

Single-Color

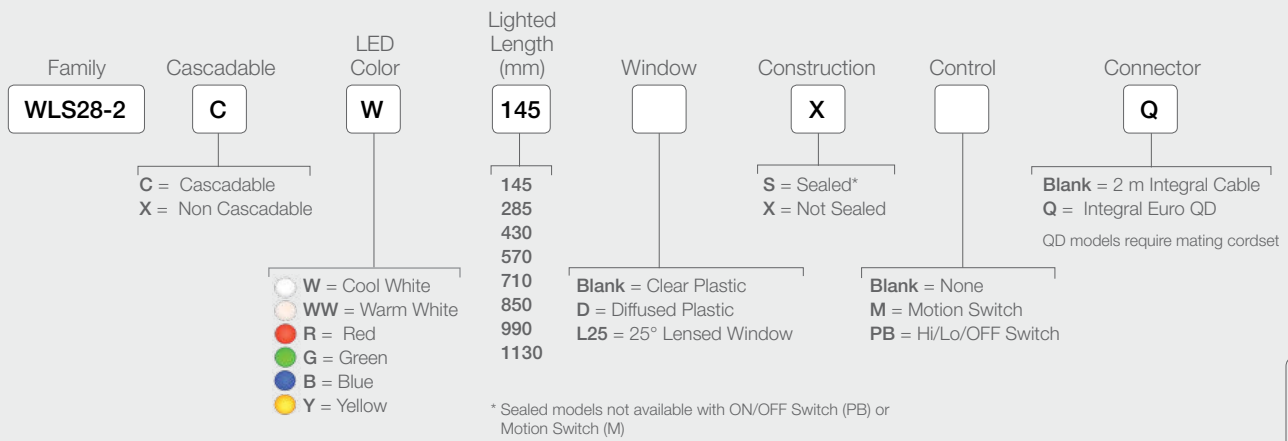

Dual-Color

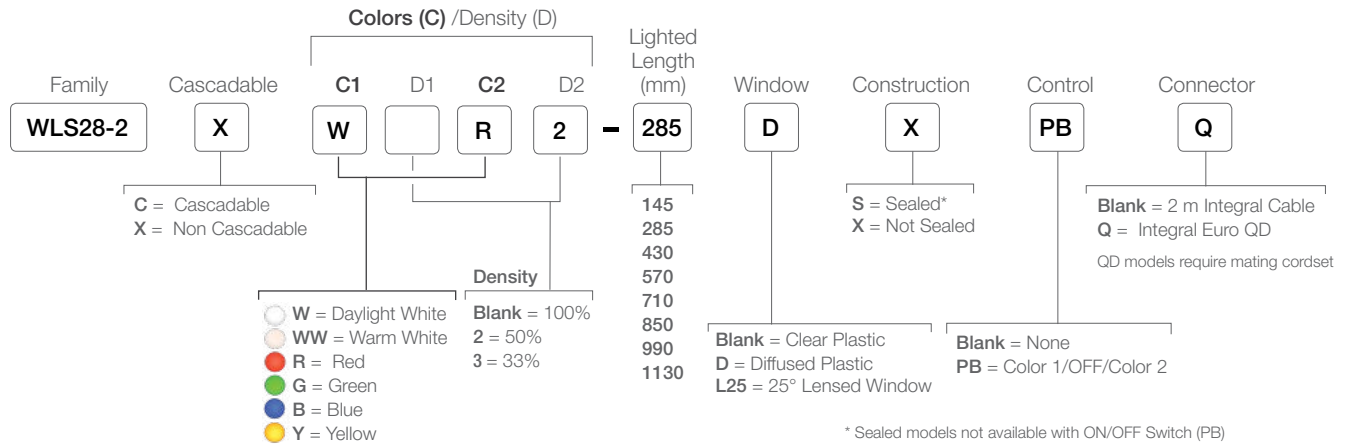

UV Models

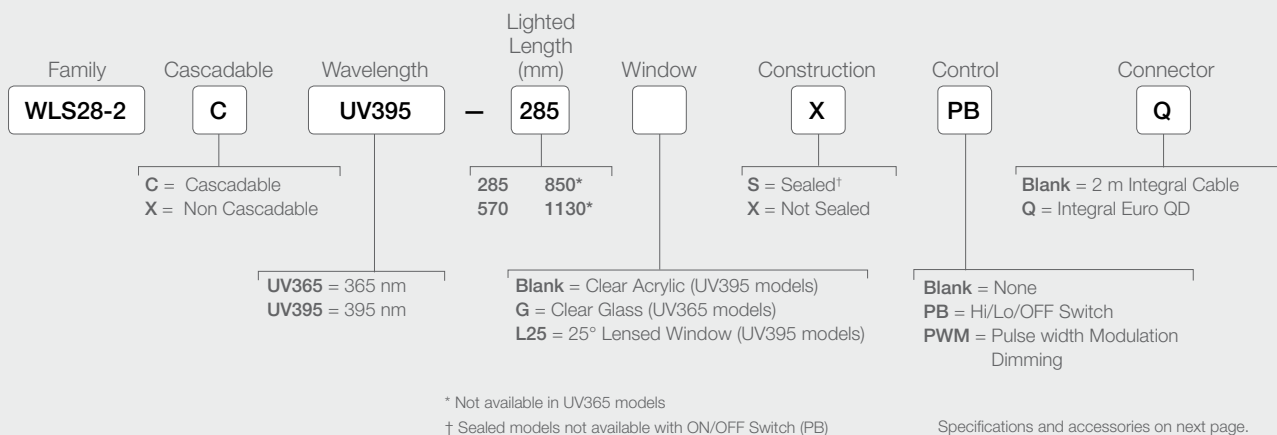

Supply Voltage	12 to 30 V dc
Construction	Housing: Clear anodized aluminum End Caps: Painted zinc Window: Polycarbonate.
Environmental Rating	Non-sealed Models: IEC IP50 Sealed Models: IEC IP67/IP69K per DIN 40050
Operating Temperature	-40 to +70 °C (-40 to +158 °F)
Certifications	



Single-Color

Length (mm)	Lumens* (Typical @ 25 °C)						Typical Wattage** (Watts)
	Cool White	Warm White	Red	Green	Blue	Yellow	
145	325	325	55	180	40	50	3.6
285	650	650	110	360	80	100	7.2
430	975	975	165	540	120	150	11.0
570	1300	1300	220	720	160	200	14.6
710	1625	1625	275	900	200	250	18.5
850	1950	1950	330	1080	240	300	22.1
990	2275	2275	385	1260	280	350	25.9
1130	2600	2600	440	1440	320	400	29.8

*Lumen values lowered by 35% on diffused window models
**Typical operating wattage is measured at 24 V dc

Dual-Color

Length (mm)	Lumens* (Typical @ 25 °C)					Typical Wattage** (Watts)
	Daylight White	Red	Green	Blue	Yellow	
285	475	200	300	110	150	7.2
570	950	400	600	220	300	14.6
850	1425	600	900	330	450	22.1
1130	1900	800	1200	440	600	29.8

*Lumen values lowered by 35% on diffused window models
**Typical operating wattage is measured at 24 V dc

Top Mount



SMBWLS28RA
(included with light)

Side Mount



SMBWLS28SM

Magnetic Mount Shown with SMBWLS28RA



SMBWLSMAG
SMBWLSMAGR
Protective cover for magnet sold separately

Snap Mount



SMBWLS28SP



PSD-24-4
Class 2 Power Supply
Input: 90-264 V ac 1.5A
Output: 24 V dc 3.9A
2 m (6.5') 4-Pin Euro Connector



WLS28-2PBQ
In-Line Switch with M12 Connectors



WLS28-2MQ
In-Line Motion Detection Switch with M12 Connectors



4-Pin M12/Euro-Style
Straight connector models listed; for right-angle, add RA to the end of the model number (example, MQDC-406RA)

MQDC-406
2 m (6.5')
MQDC-415
5 m (15')
MQDC-430
9 m (30')

4-Pin M12/Euro-Style
Double-Ended (straight male/straight female connectors)

MQDEC-401SS
0.3 m (1')
MQDEC-403SS
1 m (3')
MQDEC-406SS
2 m (6.5')

4-Pin M12/Euro-Style
Splitter

CSB-M1241M1241
0.3 m (1') male trunk;
2 x 0.3 m (1') female branches

Additional cordset lengths and accessories are available at bannerengineering.com

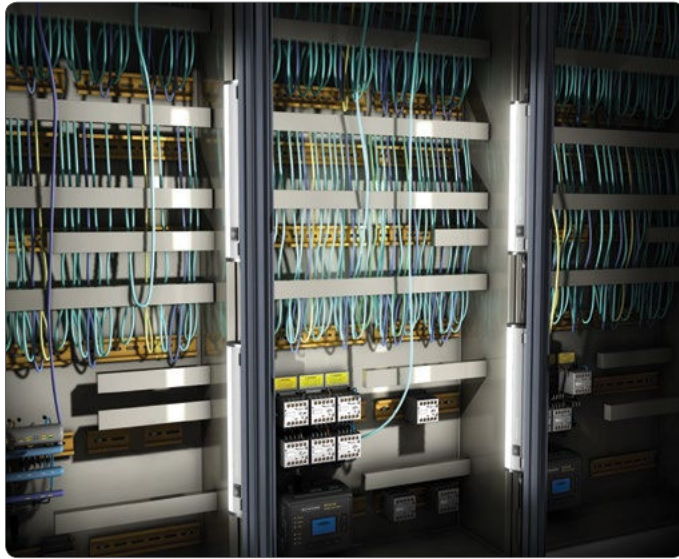

WLB32

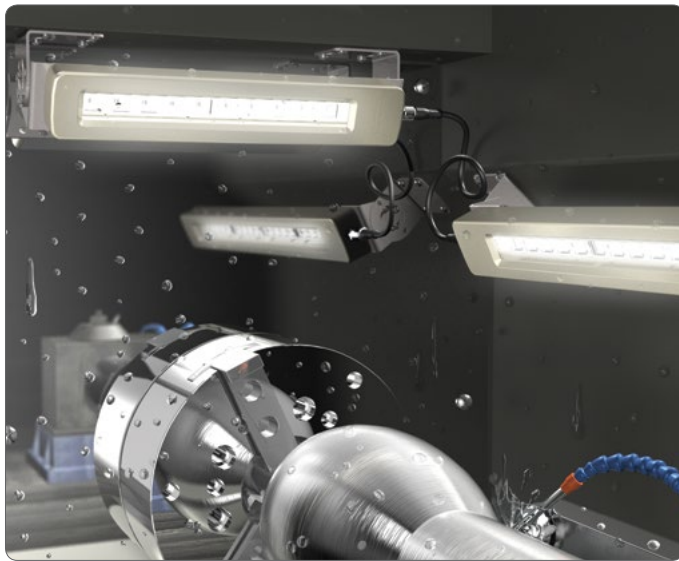

WLC60

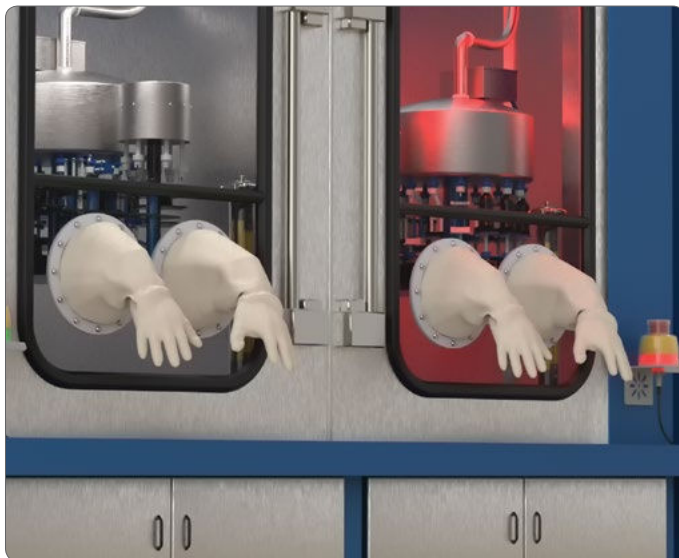

WLS27



WLS15 LED Strip Lights

- Low-profile design for easy installation in tight spaces
- 12 or 24 V dc operation in one model
- Completely sealed with an IP67 rating for use in wet or dusty environments
- The rugged construction and polycarbonate shell resists shock and vibration while remaining lightweight
- LED lighting technology saves energy and minimizes replacement costs
- Brackets and connectors are available to keep installation simple
- Draws half the current of other lights for a low power device and high energy savings
- Offers stability in the presence of line voltage fluctuations

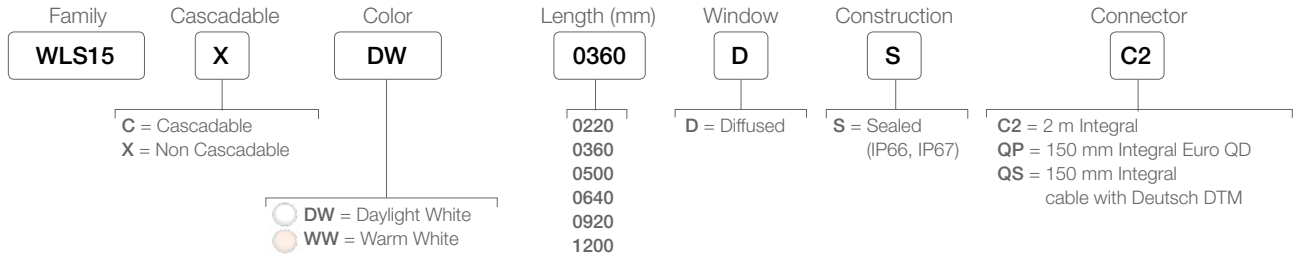

Supply Voltage and Current | 12 V dc or 24 V dc nominal

Construction | Clear anodized aluminum inner housing; Polycarbonate outer housing, Polyamide end caps

Environmental Rating | Rated IEC IP66 and IEC IP67
Suitable for wet locations per UL 2108

Operating Conditions | **Temperature:** -40 to +60 °C
Storage Temperature: -40 to +70 °C

Certifications | 

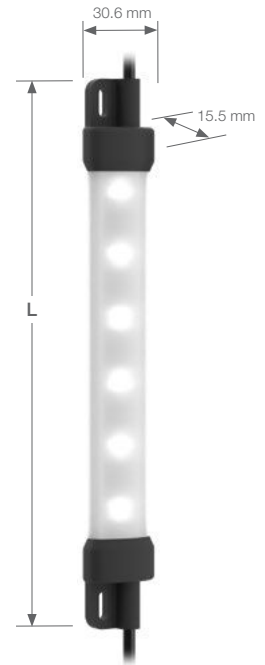

Length (mm)	Typical Current (A) at 25 °C		Maximum Current (A) at -40 °C		Lumens	
	12 V dc	24 V dc	12 V dc	24 V dc	Daylight White	Warm White
0220	0.19	0.10	0.24	0.12	175	170
0360	0.38	0.20	0.48	0.24	350	340
0500	0.57	0.30	0.72	0.36	525	510
0640	0.76	0.40	0.96	0.48	700	680
0920	1.14	0.60	1.44	0.72	1050	1020
1200	1.52	0.80	1.92	0.96	1400	1360



4-Pin M12/ Euro-Style
 Straight connector models listed; for right-angle, add RA to the end of the model number (example, MQDC-406RA)

4-Pin M12/Euro-Style
 Double-Ended (straight male/straight female connectors)

4-Pin M12/Euro-Style
 Splitter

MQDC-406
 2 m (6.5')

MQDC-415
 5 m (15')

MQDC-430
 9 m (30')

MQDEC-401SS
 0.3 m (1')

MQDEC-403SS
 1 m (3')

MQDEC-406SS
 2 m (6.5')

CSB-M1241M1241
 0.3 m (1') male trunk;
 2 x 0.3 m (1') female branches

4-Pin M12/Euro-Style
 Splitter

CSB-M1241M1241
 0.3 m (1') male trunk;
 2 x 0.3 m (1') female branches

4-Pin M12/Euro-Style
 Splitter

CSB-M1241M1241
 0.3 m (1') male trunk;
 2 x 0.3 m (1') female branches

Deutsch
 4-Pin M12/Euro-Style Splitter

Deutsch
 Single-ended cordset with straight connectors

Deutsch
 Double-ended cordset with straight connectors

CSB-M1241M1241
 0.3 m (1') male trunk;
 2 x 0.3 m (1') female branches

DTMC-206
 2 m (6.5')

DTMC-215
 5 m (15')

DTMC-230
 9 m (30')

DTMEC-2005
 0.16 m (0.5')

DTMEC-206
 2 m (6')

DTMEC-230
 9 m (30')

Additional cordset lengths and accessories are available at bannerengineering.com



WLB32 LED Light Bar

- Energy efficient for overall cost savings
- High/Low/Off switch allows users to customize light levels
- Available as cascadable models for a continuous length of lighting, with a minimum of wiring
- Metal housing, shatterproof window
- Easy installation with snap clips, or a choice of magnetic or angle brackets
- Available in AC or DC models
- Available in 285 mm, 570 mm, 850 mm or 1130 mm
- Motion detection models are ideal for locations that cannot use a physical switch or where the placement of the switch is not useful
- Models featuring an eye shield window block direct line of sight to the domed window to increase eye comfort

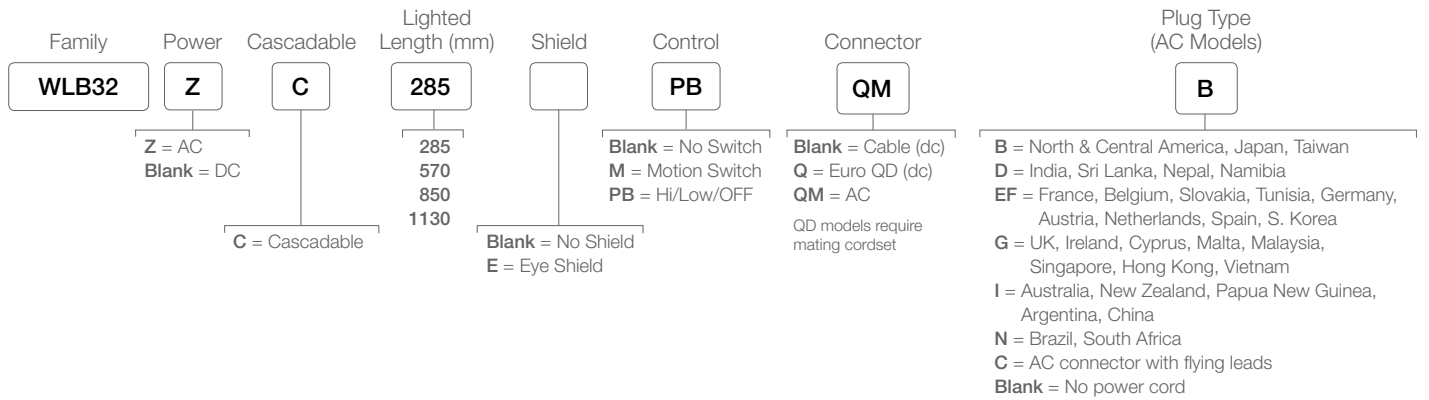

Operating Voltage	12 to 30 V dc (dc models) 90 to 264 V ac (ac models)
Lumen Output	≈ 650/ft
LED Lifetime	50,000 hours
Color Temperature	Daylight White — 5000 k
Switch	High = 100% intensity Low = 50% intensity
Environmental Rating	IP50 — Dry location only
Certifications	CE, UL LISTED, cUL US, cRUL US



Length (mm)	Lumens (Typical @ 25 °C)	AC Models Typical Wattage* (Watts)	DC Models Typical Wattage* (Watts)
	Daylight White		
285	650	9	7.4
570	1300	18	14.8
850	1950	27	22.2
1130	2600	36	29.6

* Typical operating wattage is measured at 120 V ac or 24 V dc, depending on model

AC Cascade and Power Cordsets

(DC Cascade and Power cordsets shown on page 25)



1 Power Cordset
1.8 m (6')

LQMAC-306	Flying Leads
LQMAC-306B	North & Central America, Japan, Taiwan
LQMAC-306D	India, Sri Lanka, Nepal, Namibia
LQMAC-306EF	France, Belgium, Slovakia, Tunisia, Germany, Austria, Netherlands, Spain, S. Korea
LQMAC-306G	UK, Ireland, Cyprus, Malta, Malaysia, Singapore, Hong Kong, Vietnam
LQMAC-306I	Australia, New Zealand, Papua New Guinea, Argentina, China
LQMAC-306N	Brazil

2 Double-Ended Cascading Cordset
Male straight/Male straight connectors

LQMAEC-3005SS	0.15 m (0.5')
LQMAEC-301SS	0.31 m (1.0')
LQMAEC-303SS	0.91 m (3.0')

Additional cordset lengths and accessories are available at bannerengineering.com





WLB92 Industrial Light Bar

- Increase worker productivity and ergonomics with bright, high-quality, uniform light
- Durable light stands up in your environment with a rugged metal housing and shatterproof light cover
- No maintenance time or cost with long-life, energy-efficient LEDs
- Flexibility to place light where needed with ac and dc models
- Easy installation with variety of mounting options: surface, swivel, snap and hanging brackets
- Available in daylight white, warm white, blue, red, yellow and green
- AC models are DLC qualified and have a five year warranty

DC Models

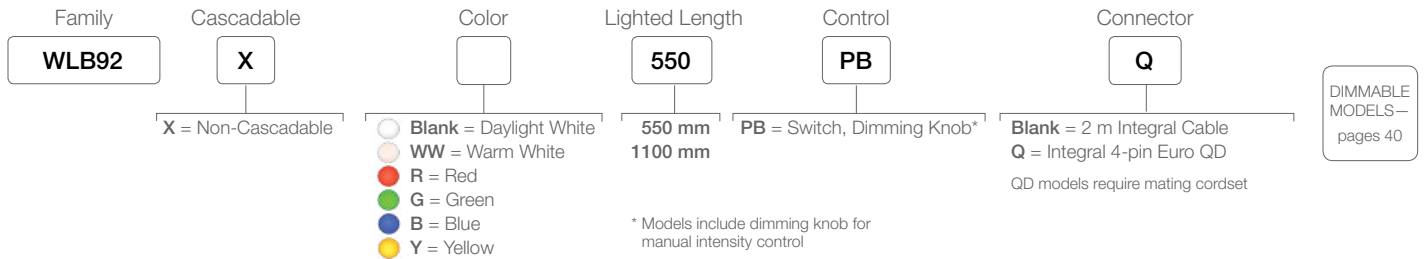

AC Models

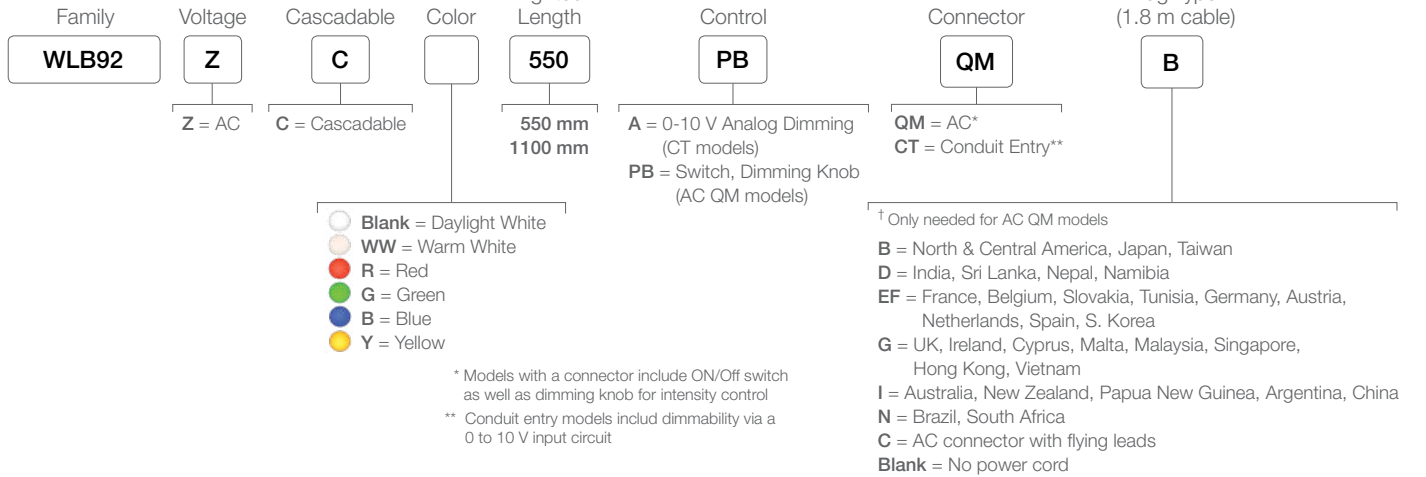

Operating Voltage

24 V dc (dc models)
100 to 277 V ac (ac models)

Construction

Housing: Anodized aluminum
Window: Polycarbonate

LED Lifetime

50,000 hours

Color Temperature

Daylight White — 5000 k
Warm White — 3000 k

Environmental Rating

IEC IP40

Certifications

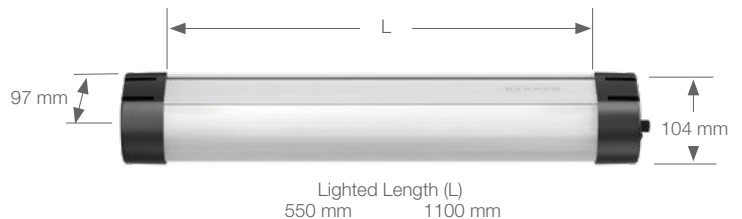

Length (mm)	Lumens (Typical @ 25 °C)						AC Models Typical Wattage* (Watts)	DC Models Typical Wattage* (Watts)
	Daylight White	Warm White	Green	Red	Yellow	Blue		
550	3510	3510	1430	745	620	405	34	35
1100	7150	7150	2975	1545	1295	840	70	70

* Typical operating wattage is measured at 120 V ac or 24 V dc, depending on model



LMBWLB92



LMBWLB92-CLIP



LMBWLB92S



LMBWLB92HK5



LMBWLB92RAS

AC Power Cordset 1.8 m (6')

for use with models using QM connector.
Cascadable model cables available on page 19.



LQMAC-306

Flying Leads

LQMAC-306B

North & Central America, Japan, Taiwan

LQMAC-306D

India, Sri Lanka, Nepal, Namibia

LQMAC-306EF

France, Belgium, Slovakia, Tunisia, Germany, Austria, Netherlands, Spain, S. Korea

LQMAC-306G

UK, Ireland, Cyprus, Malta, Malaysia, Singapore, Hong Kong, Vietnam

LQMAC-306I

Australia, New Zealand, Papua New Guinea, Argentina, China

LQMAC-306N

Brazil, South Africa



For use with DC models
4-Pin M12/Euro-Style
Straight connector models listed; for right-angle, add **RA** to the end of the model number (example, **MQDC-406RA**)

MQDC-406
2 m (6.5')
MQDC-415
5 m (15')
MQDC-430
9 m (30')

Additional accessories are available at bannerengineering.com



WLS27 LED Strip Lights

- Cylindrical shape design, ideal for laminar airflow applications
- Rugged, water-resistant IP66, IP67 and IP69K construction
- Chemically resistant copolyester housing
- Available in eight lengths from 145 mm to 1130 mm
- Daisy chain power to multiple lights
- Capability to dim lights using the wiring pinout (Hi/Lo/Off)
- Optional snap clips for easy installation and repositioning
- Automatic temperature protection built into the unit. Above 50 °C, the light dims to manage heat and protect product lifetime

Single Color

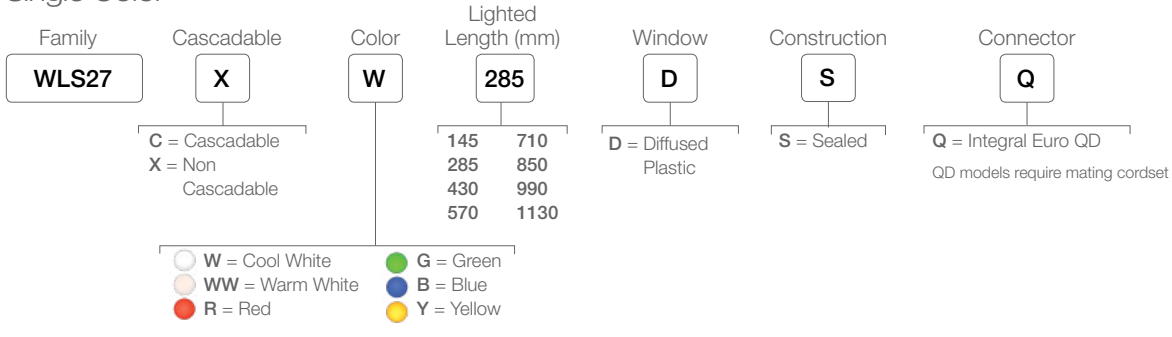

Dual-Color

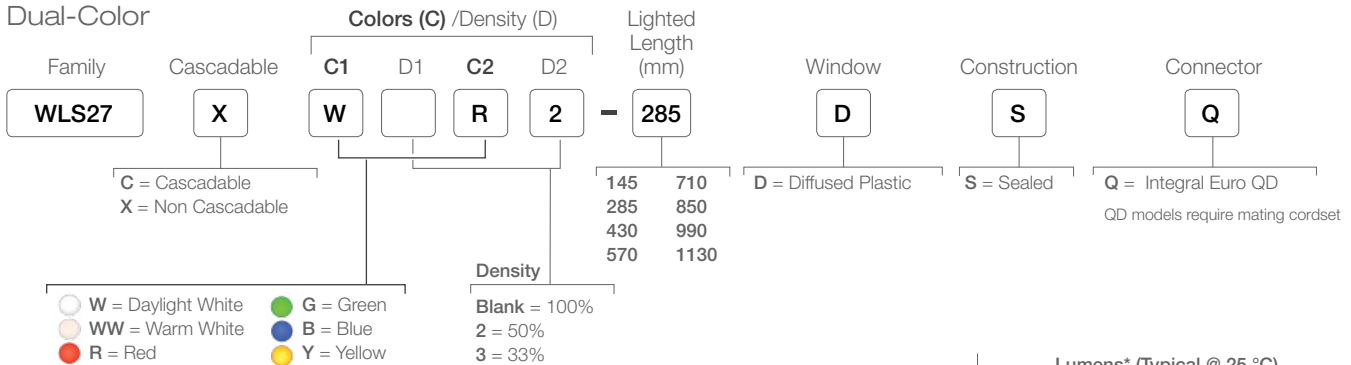

Supply Voltage	12 to 30 V dc
Construction	Housing: Copolyester
LED Lifetime	50,000 hours
Environmental Rating	IEC IP67, IP66, IP69K per DIN 40050
Operating Temperature	-40 to +70 °C (-40 to +158 °F)
Certifications	

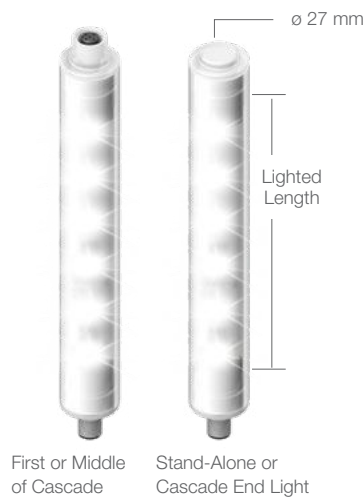

Length (mm)	Lumens* (Typical @ 25 °C)						Typical Wattage** (Watts)
	Cool White	Warm White	Red	Green	Blue	Yellow	
145	325	325	55	180	40	50	4
285	660	660	110	360	80	100	7
430	975	975	65	540	120	150	11
570	1300	1300	220	720	160	200	15
710	1625	1625	275	900	200	250	19
850	1950	1950	330	1080	240	300	22
990	2275	2275	385	1260	280	350	26
1130	2600	2600	440	1440	320	400	30

* Lumen values lowered by 35% on diffused window models
 ** Typical operating wattage is measured at 24 V dc

Length (mm)	Lumens (Typical @ 25 °C)					Typical Wattage* (Watts)
	White	Red	Green	Blue	Yellow	
145	238	100	150	55	75	4
285	475	200	300	110	150	7
430	713	300	450	165	225	11
570	950	400	600	220	300	15
710	1188	500	750	275	375	18
850	1425	600	900	330	450	22
990	1663	700	1050	385	525	26
1130	1900	800	1200	440	600	30

*Typical operating wattage is measured at 24 V dc



- ① Power Cordsets
4 pin M12 Euro-style
- ① Power Cordsets - Washdown
4 pin M12 Euro-style
- ② Double-Ended
(straight male/straight female connectors) 4-Pin M12/Euro-Style
- Splitter
4-Pin M12/Euro-Style

MQDC-406
MQDC-406RA
 2 m (6.5')

MQDC-WDSS-0406
 2 m (6.5')

MQDEC-401SS
 0.3 m (1')

CSB-M1241M1241
 0.3 m (1') male trunk;
 2 x 0.3 m (1') female branches

Additional cordset lengths and accessories are available at bannerengineering.com



WLS27 Multicolor LED Strip Lights

- Three- and five-color models with EZ-STATUS™ combine illumination and indication in one robust light fixture
- Rugged, water-resistant IEC IP69K rating
- Four available lengths from 285 mm to 1130 mm
- Daisy chain power to multiple lights

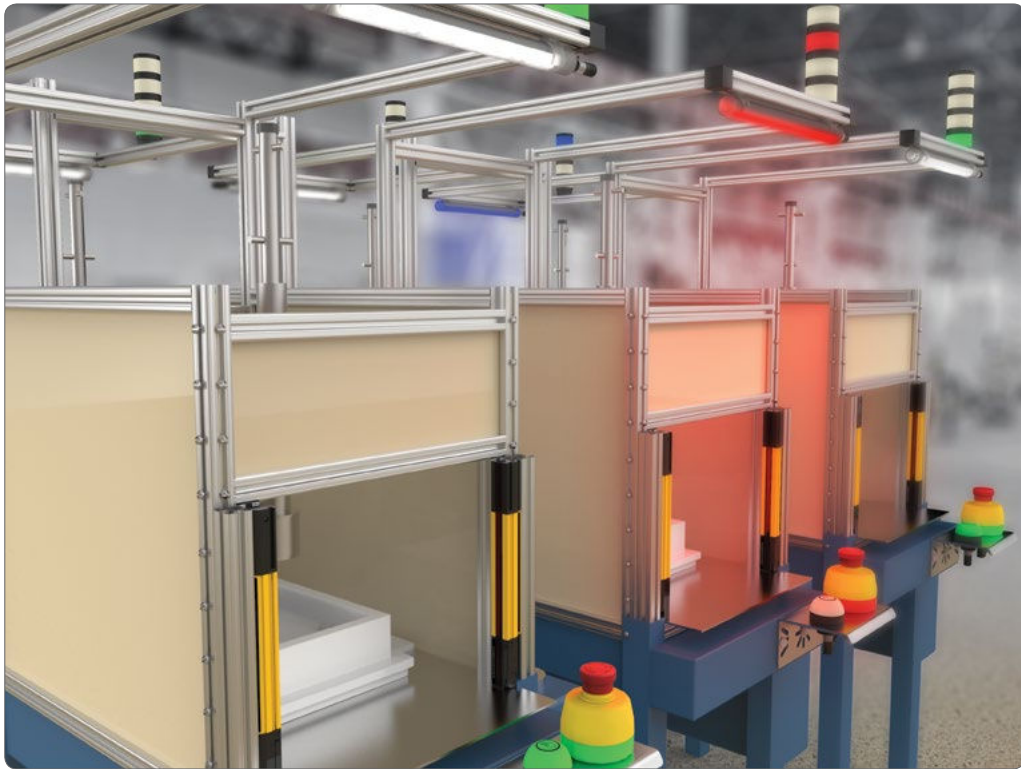
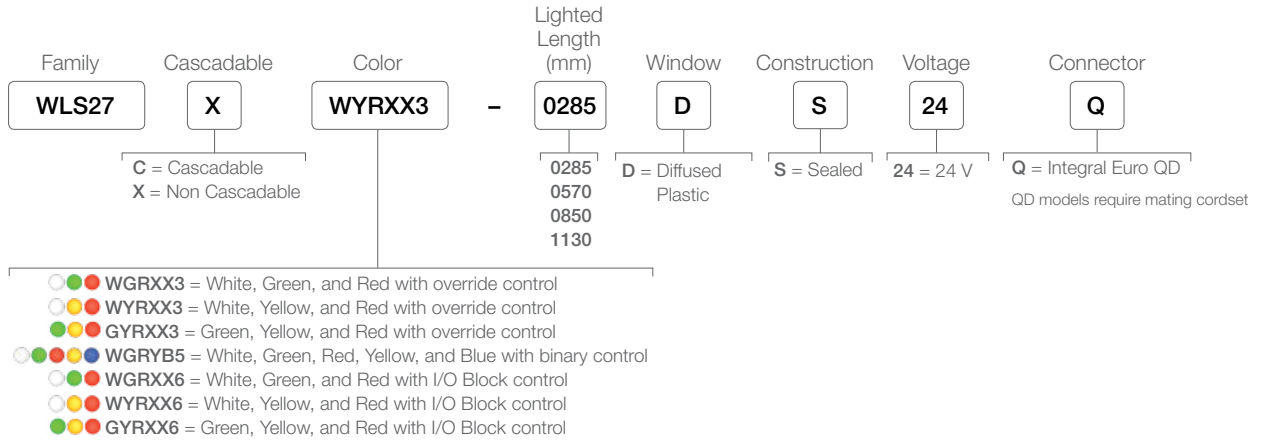

Supply Voltage: 24 V dc

Construction: Housing: Copolyester

LED Lifetime: 50,000 hours

Environmental Rating: IEC IP66, IP67, IP69K per DIN 40050

Operating Temperature: -40 to +50 °C (-40 to +122 °F)

Certifications:

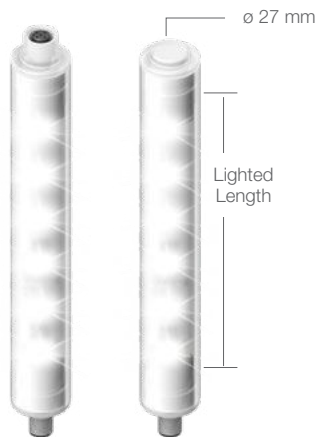

First or Middle of Cascade Stand-Alone or Cascade End Light

Length (mm)	Lumens (Typical @ 25 °C)					Typical Wattage* (Watts)
	White	Red	Green	Blue	Yellow	
285	650	185	400	125	570	7
570	1300	370	800	250	1140	12
850	1950	555	1200	375	1710	22
1130	2600	740	1600	500	2280	30

*Typical operating wattage is measured at 24 V dc

Accessories are listed on pages 26



Heavy-Duty LED Lights

- Oil, chemical, and water resistant with IP67, IP68g, and IP69K ratings
- High brightness paired with advanced glare-reducing optics
- Easy-to-install with a wide variety of mounting solutions
- Resistant to vibration and shock
- Input voltage of 12–30 V dc
- Models have four discrete intensity level settings
- Available with stainless steel or nickel-plated aluminum housing
- High temperature models now available in a black E-coated aluminum housing

WLC60 Standard

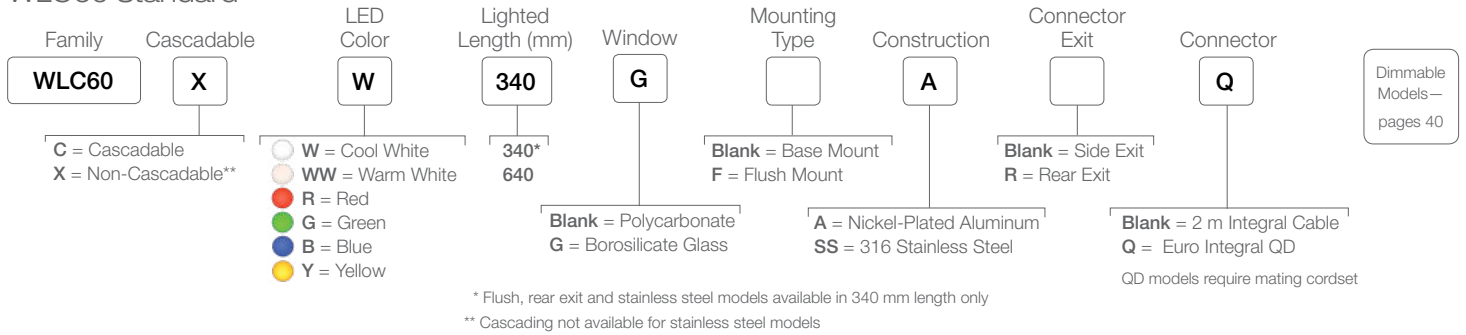

WLH60 High-Temp

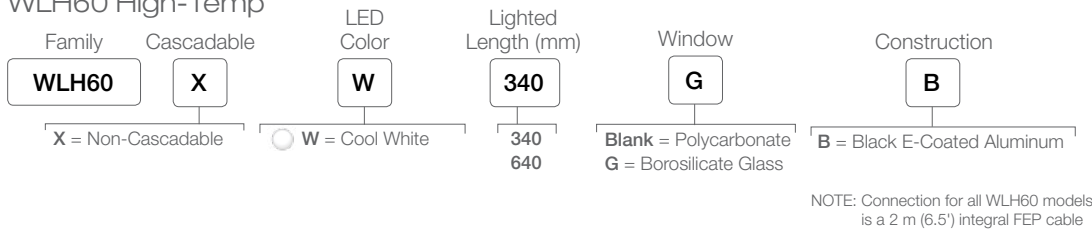

Supply Voltage	WLC60: 12 to 30 V dc WLH60: 21 to 28 V dc
Construction	WLC60 Housing: Nickel-plated aluminum or 316 Stainless steel WLH60 Housing: Black electro-coated aluminum Window: Polycarbonate or Borosilicate Glass
Environmental Rating	Rated IEC IP68, IP68g, IP69K per DIN 40050
Operating Temperature	WLC60: -40 to +70 °C (-40 to +158 °F) WLH60: -40 to +100 °C (-40 to +212 °F)
Certifications	

Length (mm)	WLC60 Lumens (Typical @ 25 °C)		Length (mm)	WLH60 Lumens (Typical @ 25 °C)	
	Cool White	Typical Wattage* (Watts)		Cool White	Typical Wattage* (Watts)
340	1300	14.2	340	1150	14.2
640	2600	28.1	640	2300	28.1

*Typical operating wattage is measured at 24 V dc

*Typical operating wattage is measured at 24 V dc

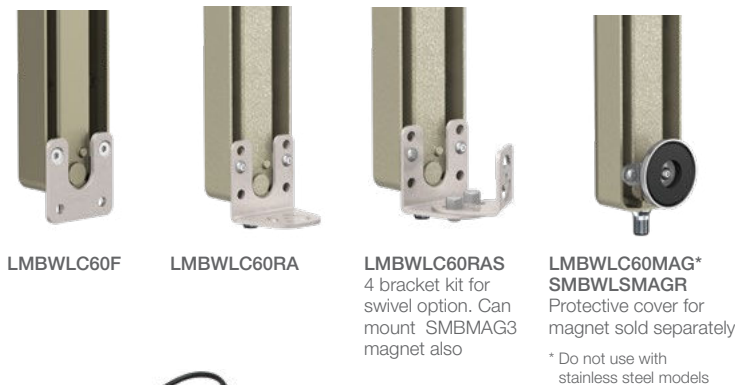
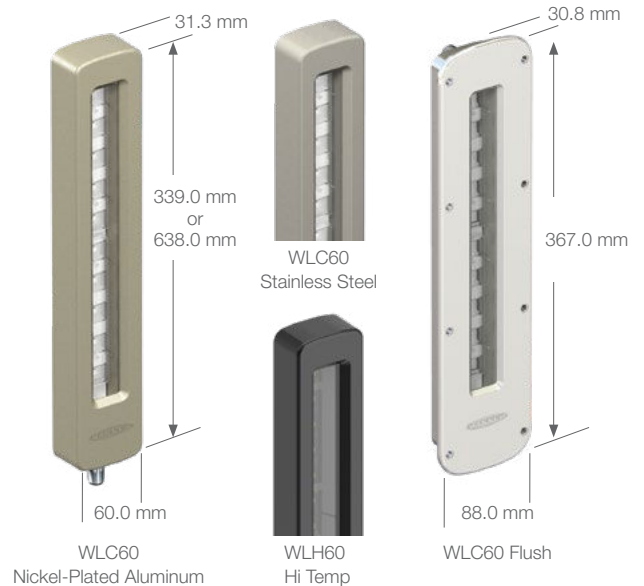

4-Pin M12/Euro-Style
Straight connector models listed; for right-angle, add RA to the end of the model number (example, MQDC-406RA)

MQDC-406
2 m (6.5')
MQDC-415
5 m (15')
MQDC-430
9 m (30')

4-Pin M12/Euro-Style
Double-Ended (straight male/straight female connectors)

MQDEC-401SS-PUR
0.3 m (1')
MQDEC-403SS-PUR
1 m (3')
MQDEC-406SS-PUR
2 m (6.5')

4-Pin M12/ Euro-Style
Washdown
Straight connector models only

MQDC-WDSS-0406
2 m (6.5')
MQDC-WDSS-0415
5 m (15')
MQDC-WDSS-0430
9 m (30')

Additional accessories are available at bannerengineering.com



WLC90 Heavy-Duty LED Light

- Oil, chemical and water resistant with IP67, IP68g and IP69K ratings
- Vast operating temperature range internal monitoring circuit dims the LEDs to a safe level at extreme temperatures
- Three lens choices to suit many application needs
- Pan-and-tilt brackets for versatile mounting to direct the light in any direction
- Models have three discrete intensity level settings

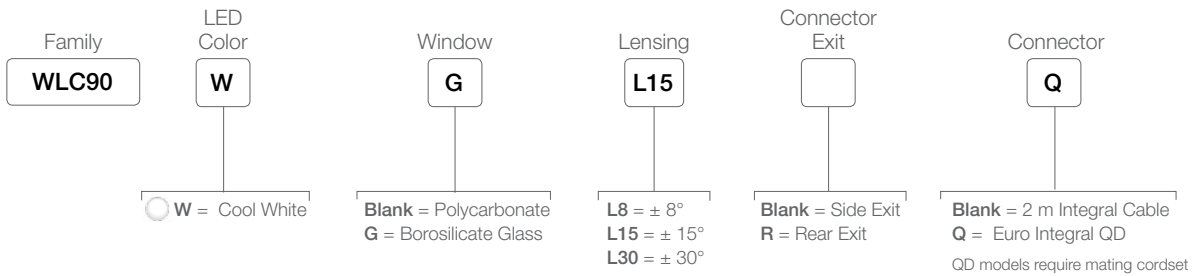

DIMMABLE MODELS—
pages 40

Supply Voltage	12 to 30 V dc
Construction	Housing: Nickel-plate aluminum Window: polycarbonate or borosilicate glass
Environmental Rating	Rated IEC IP68, IP68g, IP69K per DIN 40050
Operating Temperature	-40 to +70 °C (-40 to +158 °F)
Certifications	

Lumens (Typical @ 25 °C)	Typical Wattage* (Watts)
Cool White	
625	8.1

*Typical operating wattage is measured at 24 V dc

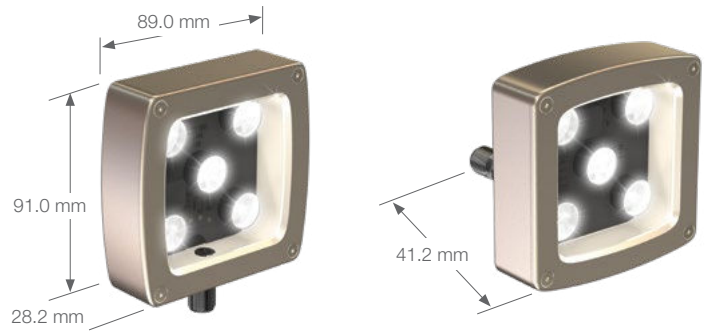

Rear-Exit Models



Side-Exit Models



SMBAMS70AS

LMBWLC90PT



4-Pin M12/Euro-Style
 Straight connector models listed; for right-angle, add RA to the end of the model number (example, MQDC-406RA)

MQDC-406
2 m (6.5')
MQDC-415
5 m (15')
MQDC-430
9 m (30')



4-Pin M12/ Euro-Style Washdown
 Straight connector models only

MQDC-WDSS-0406
2 m (6.5')
MQDC-WDSS-0415
5 m (15')
MQDC-WDSS-0430
9 m (30')



PSD-24-4
 Class 2 Power Supply
 Input: 90-264 V ac 1.5A
 Output: 24 V dc 3.9A
 2 m (6.5') 4-Pin Euro Connector

Additional accessories are available at bannerengineering.com



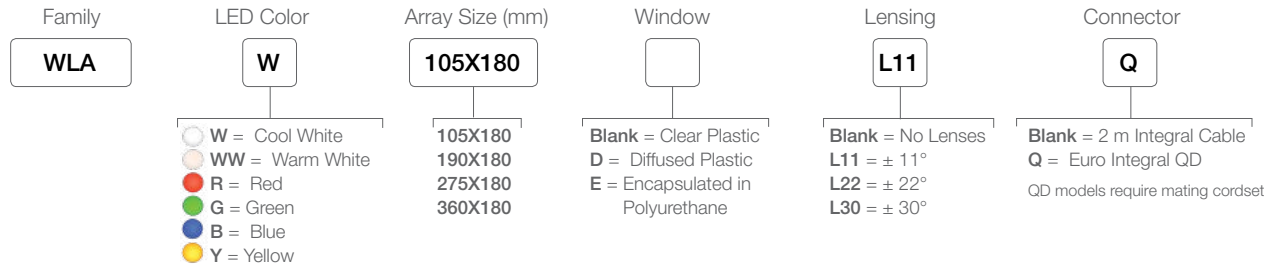

WLA LED Area Lights

- High power solid state LED array with cool white, warm white, red, green, blue or yellow light
- Illuminates a large area with an even pattern of light and no shadows
- Available in four sizes
- Designed for area and machine lighting
- Rugged thermoplastic housing rated to IP69K
- Lensed models provide a concentrated, intense light beam
- Cabled and Quick Disconnect models available



DIMMABLE MODELS— pages 40

Supply Voltage	12 to 30 V dc
Construction	Housing: PBT Window: Acrylic or polyurethane Connector: Nickel-plated brass or PVC-jacketed cable
Environmental Rating	Rated IEC IP67 and IP69K, per DIN 40050
Operating Temperature	-20 to +50 °C (-4 to +122 °F)
Certifications	  Encapsulated models not UL listed



Size (mm)	Lumens* (Typical @ 25 °C)						Typical Wattage** (Watts)
	Cool White	Warm White	Red	Green	Blue	Yellow	
105x180	550	435	125	325	95	275	9.6
190x180	1100	870	250	650	190	550	19.2
275x180	1650	1305	375	975	285	825	28.8
360x180	2200	1740	500	1300	380	1100	38.4

* Lumen values lowered by 35% on diffused window models
 **Typical operating wattage is measured at 24 V dc



4-Pin M12/Euro-Style
 Straight connector models listed; for right-angle, add RA to the end of the model number (example, MQDC-406RA)

MQDC-406
 2 m (6.5')
 MQDC-415
 5 m (15')
 MQDC-430
 9 m (30')

4-Pin M12/ Euro-Style Washdown
 Straight connector models only

MQDC-WDSS-0406
 2 m (6.5')
 MQDC-WDSS-0415
 5 m (15')
 MQDC-WDSS-0430
 9 m (30')



PSD-24-4
 Class 2 Power Supply
 Input: 90-264 V ac 1.5A
 Output: 24 V dc 3.9A
 2 m (6.5') 4-Pin Euro Connector

Additional accessories are available at bannerengineering.com



WL50S LED Spot Lights

- Highly concentrated, focused light available in three colors (white, red, or green)
- Lenses come in three angles to cover area of concentration
- Illuminates a large area with an even pattern of light and no shadows
- 12 to 30 V dc operation
- Cabled and quick-disconnect models available
- 56 mm diameter with flat profile and 30 mm mounting base
- Rugged sealed housing rated to IP69K
- Available in a chemically resistant 316 stainless steel housing for use in harsh environments

Family
WL50S

Black
Anodized
Aluminum

LED Color
W

W = White
G = Green
R = Red

Lens Angle
L11

L5 = ±5° (small)
L11 = ±11° (large)
L20 = ±20° (largest)

Connector
Q

Blank = 2 m Integral Cable
Q = Euro Integral QD
QD models require mating cordset

Family
WL50S

Stainless
Steel

LED Color
W

W = White
G = Green
R = Red

Housing
SS

SS = Stainless
Steel

Window Material
G

Blank = Acrylic
G = Glass

Lens Angle
L11

L5 = ±5° (small)
L11 = ±11° (large)
L20 = ±20° (largest)

Connector
Q

Q = Euro Integral QD
QD models require mating cordset

Dimmable
Models—
pages 40

Supply Voltage

12 to 30 V dc

Construction

Housing: Black anodized aluminum or
Stainless Steel with FDA-grade silicone
gasket and Viton® o-ring seal
Window: Polycarbonate or glass window
Connector: Nickel-plated QD connector or
PVC-jacketed cable
Mounting Nut: Black zinc-plated steel or Stainless
Steel mounting nut

Environmental Rating

IEC IP67, IP69K per DIN 40050

Operating Temperature

-20 to +50 °C (-4 to +122 °F)

Certifications



Lens	Lumens (Typical @ 25 °C)			Typical Wattage* (Watts)
	Cool White	Green	Red	
±5°	295	210	110	4.3
±11°	285	200	105	
±20°	270	190	100	

*Typical operating wattage is measured at 24 V dc



SMB30FA



SMB30SC



SMBAMS30P



SMBAMS30RA



FLX18 Flex Arm Mounts
See page 42 for more information



4-Pin M12/Euro-Style
Straight connector models
listed; for right-angle, add RA
to the end of the model number
(example, MQDC-406RA)

MQDC-406
2 m (6.5')
MQDC-415
5 m (15')
MQDC-430
9 m (30')



**4-Pin M12/ Euro-Style
Washdown**
Straight connector models only

MQDC-WDSS-0406
2 m (6.5')
MQDC-WDSS-0415
5 m (15')
MQDC-WDSS-0430
9 m (30')

Additional accessories are available at
bannerengineering.com



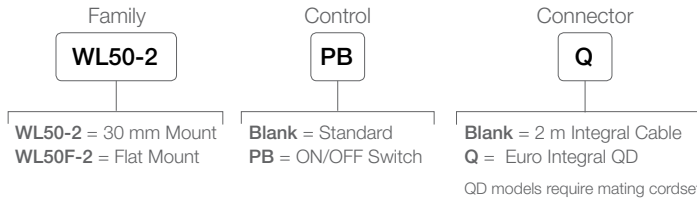

WL50-2 LED Work Lights

- Designed for enclosure or area lighting use with an optional flex arm mount for adjustable, industrial task lighting
- Standard or push-button models available
- Flat-mount or 30 mm base-mount models available
- Rugged, sealed polycarbonate housing rated to IP69K (standard models) or IP67 (push-button models)
- 12 to 30 V dc operation
- Cabled and quick-disconnect models available
- Low power consumption less than 3 watts



Dimmable
Models—
pages 40

Supply Voltage	12 to 30 V dc
Construction	Housing: Polycarbonate Connector: Nickel-plated brass or PVC-jacketed cable
Environmental Rating	Standard Models: IP69K per DIN 40050 Push-Button Models: IEC IP67
Operating Temperature	-40 to +50 °C (-40 to +122 °F)
Certifications	  



Lumens (Typical @ 25 °C)	Typical Wattage* (Watts)
Cool White	
185	2.4

*Typical operating wattage is measured at 24 V dc

Mounting Options for Flat Mount Models



Screw Mount



VELCRO® Brand
VELCOIN® Fasteners
(included)

Mounting Options for 30 mm Mount Models



FLX18 Flex Arm Mounts
See page 42 for more information



**4-Pin M12/
Euro-Style**
straight connector models listed;
for right-angle models, add RA
to the end of the model number
(example, MQDC-406RA)

MQDC-406
2 m (6.5')
MQDC-415
5 m (15')
MQDC-430
9 m (30')

Additional accessories are available at bannerengineering.com



LC6P1T shown

LED Dimming Controller & Dimmable LED Lights

- Works with special models of the strip lights, heavy-duty lights, area lights, spot lights and work lights
- High-frequency modulation allows for precise intensity control and flicker-free illumination
- Allows for control of multiple lights with one module
- LED Pulse-Width Modulation (PWM) versions of LED lights can be controlled by other PWM output devices as well as Banner's controller
- Ability to control intensity from zero to 100 percent to suit the level required for the application
- Helps further increase energy savings, helping to reduce overall energy costs

WLS27 LED Strip Lights



page 26

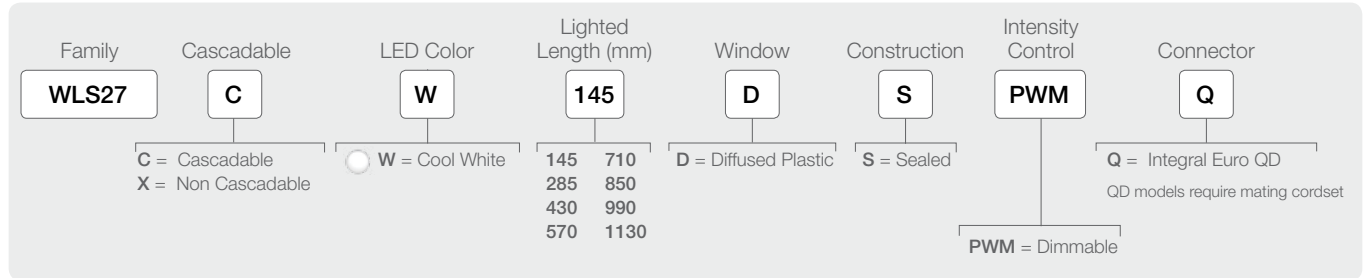

WLS28-2 LED Strip Lights



page 16

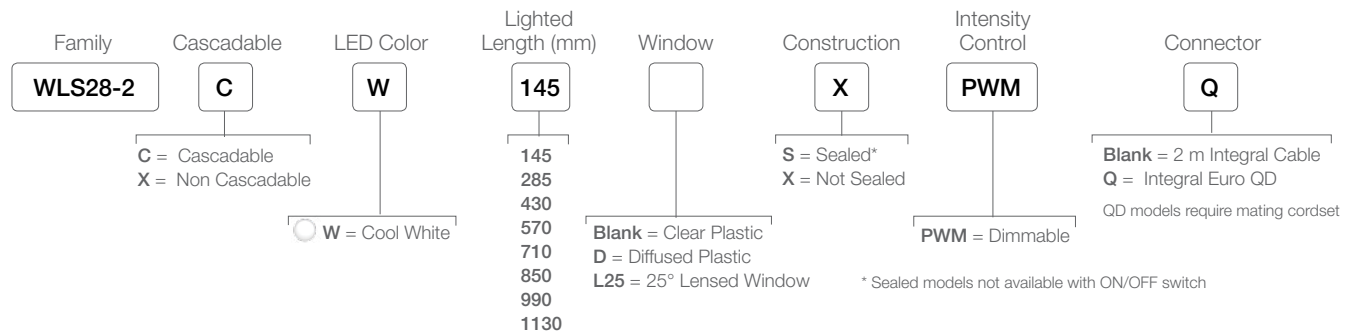

WLB92 DC Models



page 24

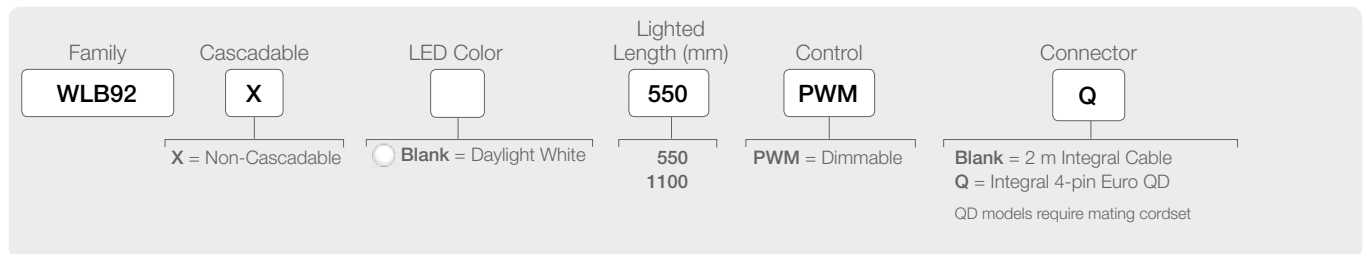



page 34

WLA LED Area Lights

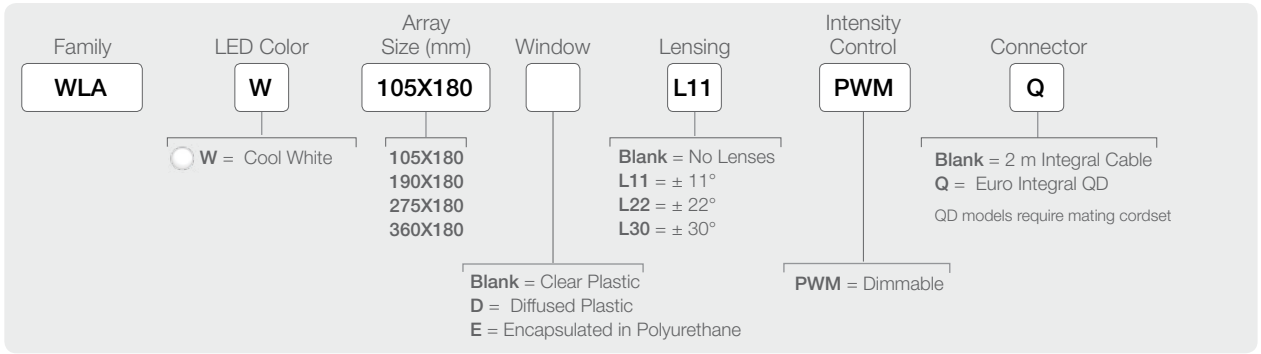

page 32

WLC90 Heavy-Duty LED Light

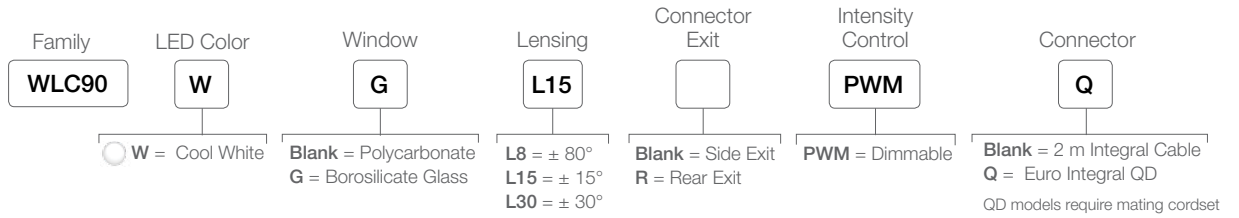

WLC60 Heavy-Duty LED Light



page 30

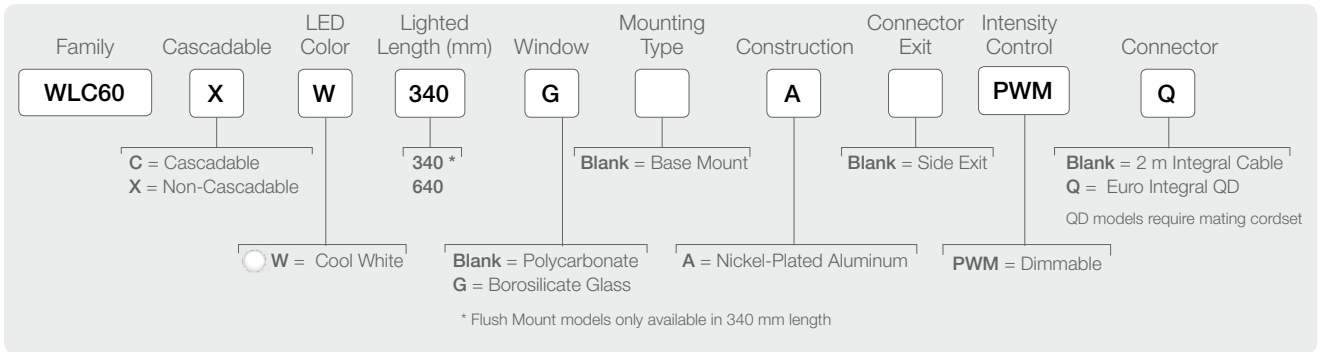

page 36





















page 38

WL50S and WL50-2 also have the PWM option available. Contact factory for more information.



Flex Arm

- Versatile mounting options including magnetic mount, clamp mount and flange mount
- Vinyl coated to protect against moisture
- Adjustable arm allows for easy repositioning of light to suit many application needs
- Concentrate light exactly where needed
- Portability with magnetic and clamp mount options
- Available for use with spot lights, work lights and vision spot lights

Models	Base Connection	Light Connection	Brackets		
FLX18-1212	 1/2-14 NPSM	 1/2-14 NPSM (Male) Use with: WL50-2 WL50-2PB	 SMB22	 SMBFLXMAG	 LMB12RA
FLX18-F12	 3-Hole Flange	 1/2-14 NPSM (Male) Use with: WL50-2 WL50-2PB	Direct Mount		
FLX18-12M30	 1/2-14 NPSM	 M30 x 1.5 (Female) Use with: WL50-2 WL50-2PB WL50S	 SMB22	 SMBFLXMAG	 LMBE12RA
FLX18-DM30	 2 x 1/4-20W 1.375 spacing	 M30 x 1.5 (Female) Use with: WL50-2 WL50-2PB WL50S	 SMBFLXCLAMP	 SMBFLXMAGD	
FLX18-FM30	 3-Hole Flange	 M30 x 1.5 (Female) Use with: WL50-2 WL50-2PB WL50S	Direct Mount		







Signal Tower Lights

Multi-segment LED tower lights give machines a voice, conveying critical information in a clear, visual manner. AC and DC voltage, fourteen color options, six audible alarm styles, multiple intensity levels, three connection types and optional wireless or IO-Link communication give almost limitless possibilities in both preassembled and field configured units.

Selection Guide



Tower Lights

Page	48	52	54	56	58
Family Name	TL70	TL50	TL50C	TL50BL	CL50
DC or AC Power	AC or DC	AC or DC	AC or DC	AC or DC	AC or DC
Audible Options					
Daylight Visible					
Segment Diameter (mm)	70	50	50	50	50
Mounting Hole Diameter (mm)	30	30	30	30	30
Multiple Colors per Light Segment					
IP Rating	IP65	IP67	IP67	IP67	IP67
IO-Link					
Wireless					
Modular Construction					

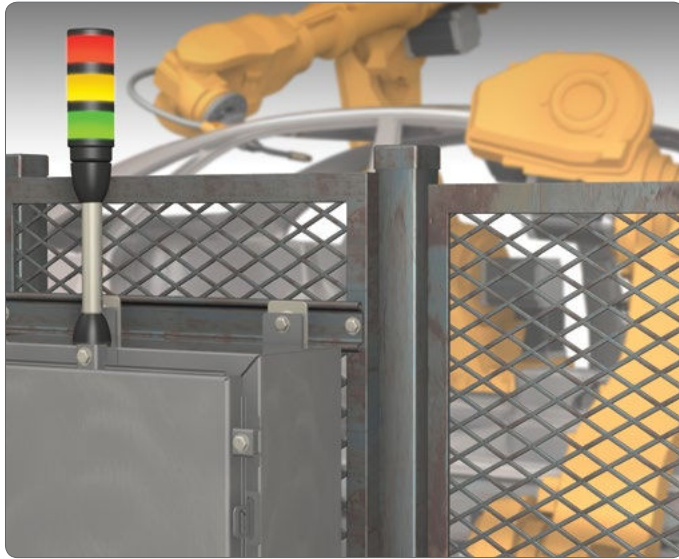

TL50

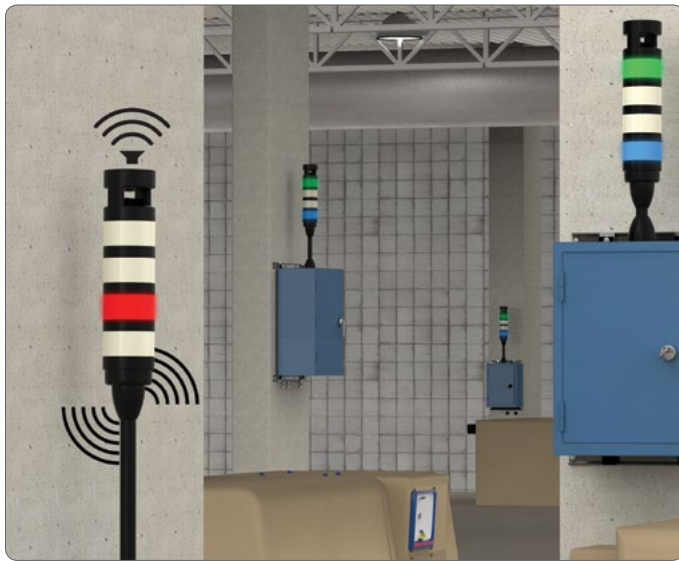

TL70 Wireless



CL50



TL70 Tower Lights

- 70 mm diameter with bright, colored LEDs for long range visibility
- Light segments appear gray when off to eliminate false indication from ambient light
- Modular design and simple wiring for fast field configuration; preassembled models also available
- Rugged, water-resistant IP65 housing with UV stabilized material
- Top-mounted audible modules from 75 to 101 dB, including multi-tone and programmable audible models allow for custom alerts or announcements; all work with the same standard bases
- Wireless base and segment models quickly enable remote monitoring and control of status lights; unleash IIOT capability
- Match your machine with a choice of black or gray housing

Build Your Own Tower Light

Standard Base

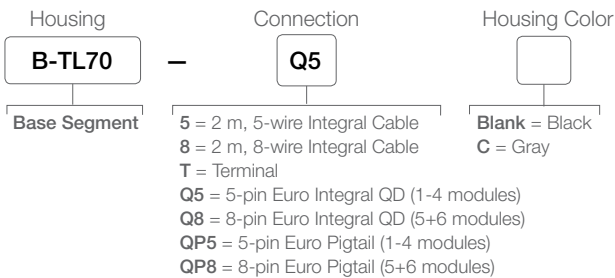

AC Base

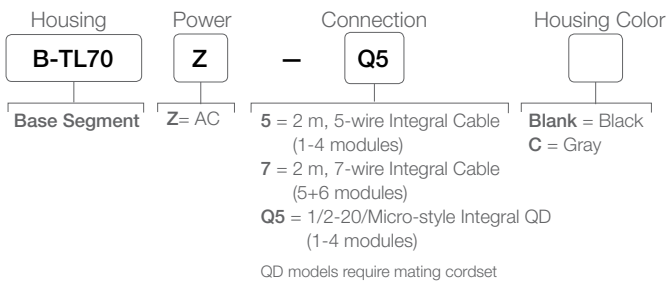

Wireless Base

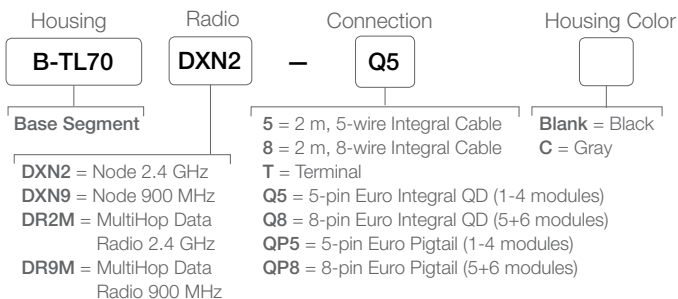

* To have color name etched on a segment, add -L to the end of the model number

Single-Color Light Segments

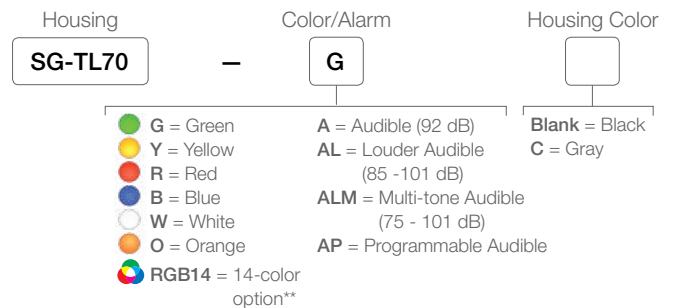

Multicolor Light Segments

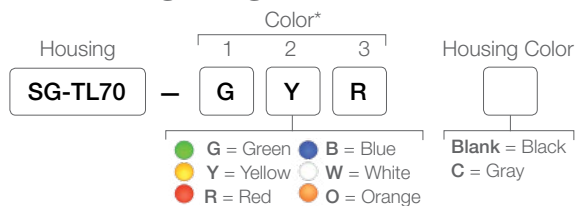

Wireless Communication Segment

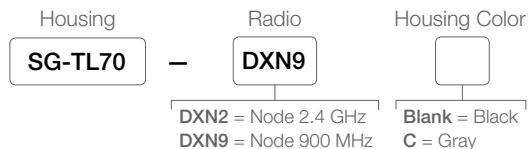

** Green, Yellow, Red, Blue, White, Cyan, Magenta, Orange, Amber, Lime Green, Spring Green, Sky Blue, Violet and Rose



The wireless communication segment quickly twists onto any TL70 base, enabling remote monitoring and control without requiring constant power or expensive wiring.

Order a Preassemble Tower Light

Preassembled TL70

Color**/Position

Housing: **TL70**

1: **G** 2: **Y** 3: **R** 4: **B** 5: **W** 6: **O**

Audible* 

Housing Color 

Connection: **Q**

G = Green **B** = Blue
Y = Yellow **W** = White
R = Red **O** = Orange

Blank = None
A = Audible (92 dB)
AL = Louder Audible (85 - 101 dB)
ALM = Multi-tone Audible** (75 - 101 dB)
AP = Programmable Audible

Blank = Black
C = Gray

Blank = 2 m Integral Cable
T = Terminal Wired
Q = Euro Integral QD
QP = Euro Pigtail QD
 QD models require mating cordset

* For audible only, leave colors blank
** Not available with 6 light models

Preassembled TL70 AC

Color**/Position

Housing: **TL70Z**

1: **G** 2: **Y** 3: **R** 4: **B** 5: **W** 6: **O**

Audible* 

Housing Color 

Connection: **Q**

G = Green **B** = Blue
Y = Yellow **W** = White
R = Red **O** = Orange

Blank = None
A = Audible (92 dB)
AL = Louder Audible (85 - 101 dB)
ALM = Multi-tone Audible** (75 - 101 dB)
AP = Programmable Audible

Blank = Black
C = Gray

Blank = 2 m Integral Cable
Q = 1/2-20/Micro-style Integral QD
 QD models require mating cordset

* For audible only, leave colors blank
** Not available with 6 light models

Preassembled TL70 Wireless

Color**/Position

Housing: **TL70**

Radio: **DXN2**

1: **G** 2: **Y** 3: **R** 4: **B** 5: **W** 6: **O**

Audible* 

Housing Color 

Connection: **Q**

G = Green **W** = White
Y = Yellow **O** = Orange
R = Red **B** = Blue
Blank = None

Blank = None
A = Audible (92 dB)
AL = Louder Audible (85 - 101 dB)
ALM = Multi-tone Audible** (75 - 101 dB)
AP = Programmable Audible

Blank = Black
C = Gray

Blank = 2 m Integral Cable
Q = Euro Integral QD
QP = Euro Pigtail QD
 QD models require mating cordset

DXN2 = Node 2.4 GHz
DXN9 = Node 900 MHz
DR2M = MultiHop Data Radio 2.4 GHz
DR9M = MultiHop Data Radio 900 MHz

* For audible only, leave colors blank
** Not available with 6 light models



Laser
Marking
Available

Color Count	AC Tower Height (H)	AC Tower Height with Audible (H)	DC Tower Height (H)	DC Tower Height with Audible (H)
1	155.6 mm	212.3 mm	87.6 mm	144.3 mm
2	205.3 mm	262.0 mm	137.3 mm	194.0 mm
3	255.0 mm	311.7 mm	187.0 mm	243.7 mm
4	304.7 mm	361.4 mm	236.7 mm	293.4 mm
5	354.4 mm	411.1 mm	286.4 mm	343.1 mm
6	404.1 mm	NA	336.1 mm	NA

Supply Voltage

12 to 30 V dc
100 to 240 V ac

Construction

Bases and Covers: Polycarbonate
Light Segment: Polycarbonate

Environmental Rating

IP65

Operating Temperature

-40 to +50 °C (-40 to +122 °F)

Certifications



Accessories are listed on pages 61



TL50 Tower Lights

- Available in models featuring IO-Link communication for easy integration into most industrial networks and remote control and monitoring of light and audible segments in the fixture
- Built-to-order configure your model today using our online tool
- Installs directly on machine quickly and easily with pre-wired or quick-disconnect options no assembly required
- Features a completely self-contained design no controller needed
- Displays up to 7 colors in a single tower choice of 10 colors in standard brightness and 5 colors in high brightness tower lights
- Allows multiple lights to be on simultaneously
- Eliminates false indication from ambient light; indicators appear gray when off
- Available in Universal AC Voltage models



Standard and High-Brightness

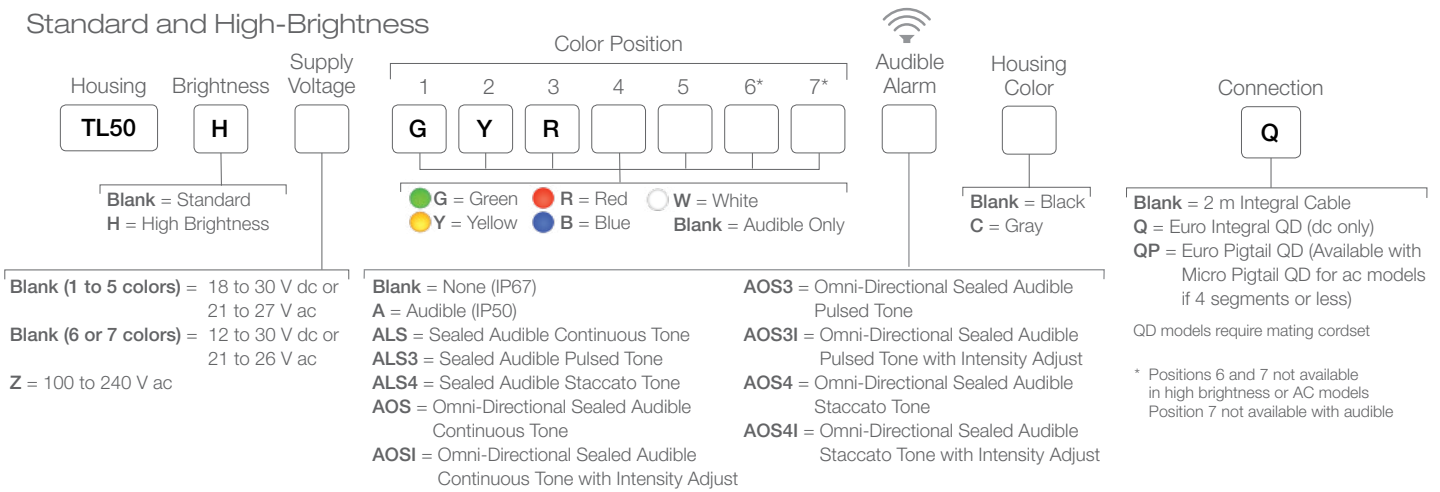

Standard with IO-Link

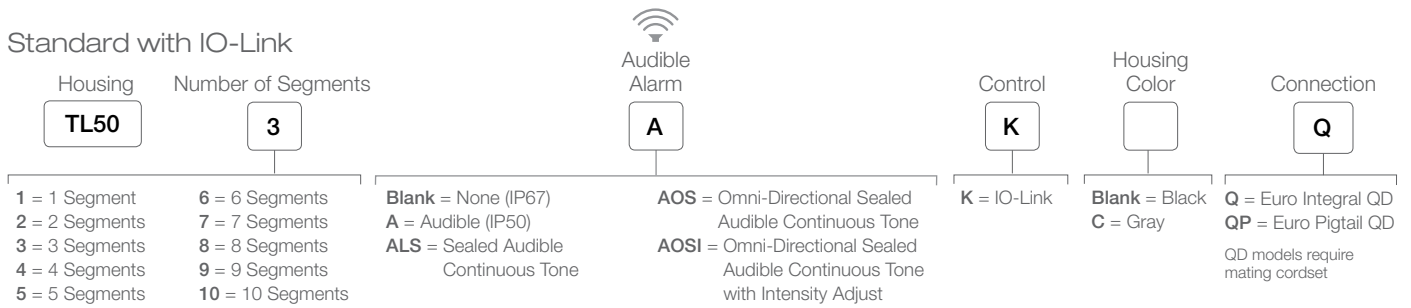

Supply Voltage	18 to 30 V dc or 21-27 V ac; 100 to 240 V ac >5 segments: 12-30 V dc or 21-26 V ac
Construction	Bases and Covers: ABS Light Segment: Polycarbonate
Environmental Rating	General-Purpose and Sealed Audible: IEC IP67 Standard Audible: IEC IP50
Operating Temperature	General-Purpose: -40 to +50 °C (-40 to +122 °F) Standard and Sealed Audible: -20 to +50 °C (-4 to +122 °F)
Certifications	CE, UL LISTED



Audible
max. intensity 92 db @ 1 meter (typical)

Sealed Audible
max. intensity 94 db @ 1 meter (typical)

Sealed Omni-Directional Audible
Standard: max. intensity 99 db @ 1 meter (typical)
Intensity Adjust: max. intensity 95 db @ 1 meter (typical)

Laser Marking Available

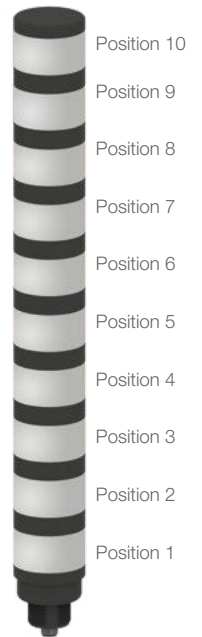

	Tower Height (H)			100 to 240 V AC
	General-Purpose IP67	Audible IP50	Sealed Audible IP67	
0	—	92.0 mm	74.4 mm	88.4 mm
1	61.2 mm	92.0 mm	115.1 mm	129.1 mm
2	101.9 mm	132.7 mm	155.8 mm	169.8 mm
3	142.6 mm	173.4 mm	196.5 mm	210.5 mm
4	183.3 mm	214.1 mm	237.2 mm	251.2 mm
5	224.0 mm	254.8 mm	277.9 mm	291.1 mm
6	264.7 mm	295.5 mm	318.6 mm	332.6 mm
7	305.4 mm	339.2 mm	359.3 mm	373.3 mm
8	346.1 mm	379.9 mm	400.0 mm	414.0 mm
9	386.8 mm	420.6 mm	440.7 mm	454.7 mm
10	427.5 mm	461.3 mm	481.4 mm	495.4 mm

Add 69 mm to any of these heights to get total height

Area in gray are IO-Link models only. Not available in AC.

Accessories are listed on pages 61



TL50C Compact Tower Lights

- Ideal for status indication on small to mid-size pieces of equipment
- Displays up to five stacked colors in one tower with universal ac voltage and up to seven stacked colors in one tower with standard dc voltage
- Half the height of standard TL50 models
- Bright, uniform lighted segments with 10 color choices available
- Available with standard, sealed or Omni-Directional audible
- Compact, sleek, rugged design with IP67 models available
- DC models work down to 12 volts, allowing for use in battery-powered mobile equipment



Standard Compact

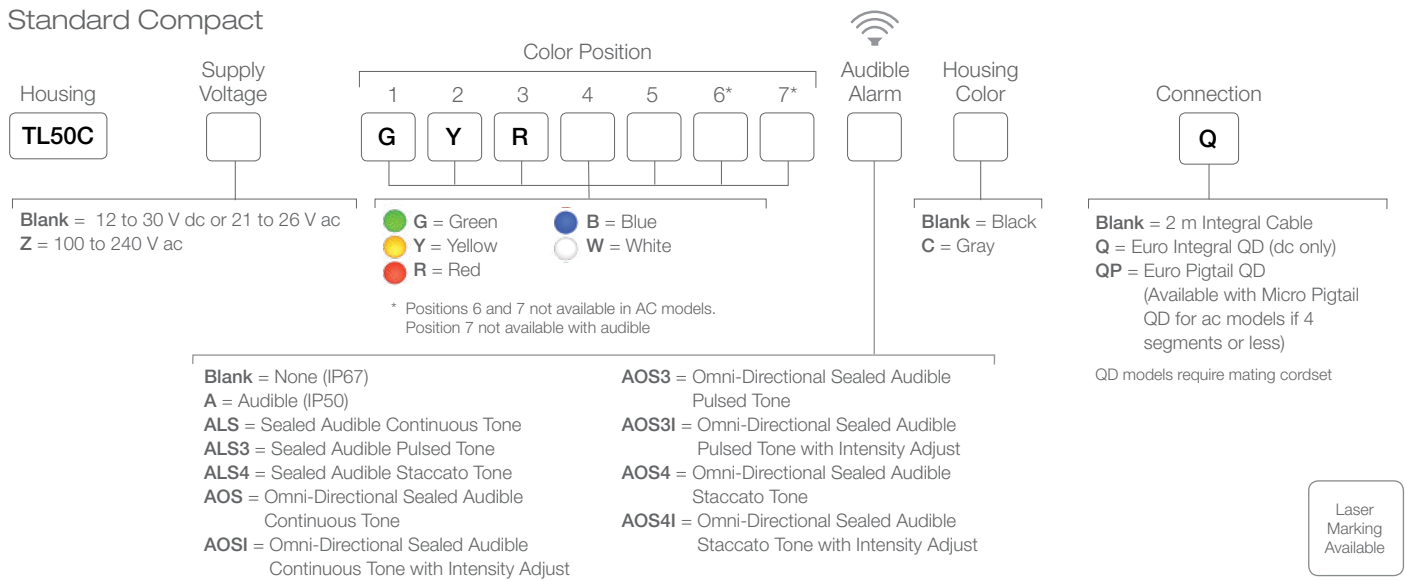

Compact with IO-Link

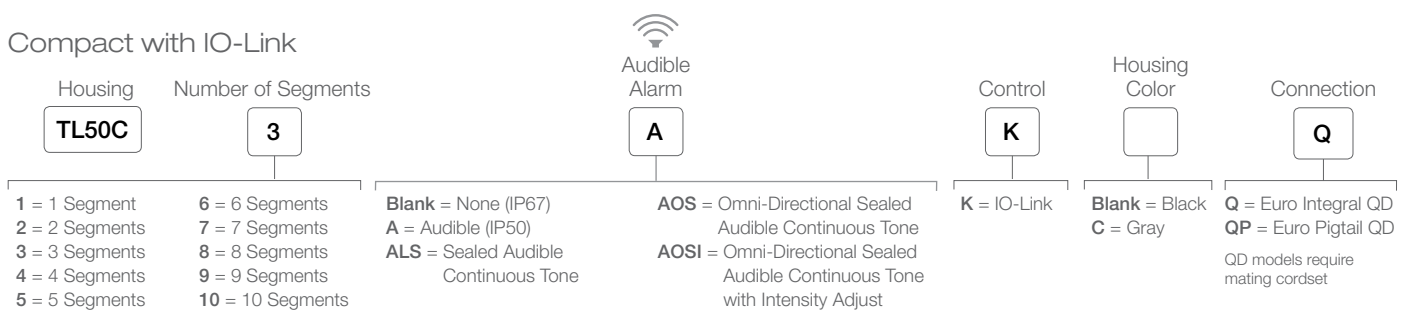

Supply Voltage 12 to 30 V dc or 21-27 V ac; 100 to 240 V ac

Construction Bases and Covers: ABS
Light Segment: Polycarbonate

Environmental Rating General-Purpose and Sealed Audible: IEC IP67
Standard Audible: IEC IP50

Operating Temperature General-Purpose: -40 to +50 °C (-40 to +122 °F)
Standard and Sealed Audible: -20 to +50 °C (-4 to +122 °F)

Certifications



Audible
max. intensity 92 db @ 1 meter (typical)

Sealed Audible
max. intensity 94 db @ 1 meter (typical)

Sealed Omni-Directional Audible
Standard: max. intensity 99 db @ 1 meter (typical)
Intensity Adjust: max. intensity 95 db @ 1 meter (typical)



Tower Height (H)	Tower Height (H)			100 to 240 V AC
	General-Purpose IP67	Audible IP50	Sealed Audible IP67	
1	46.2 mm	77.1 mm	100.2 mm	114.2 mm
2	72.0 mm	102.9 mm	126.0 mm	140.0 mm
3	97.8 mm	128.7 mm	151.8 mm	165.8 mm
4	123.6 mm	154.5 mm	177.6 mm	191.6 mm
5	149.4 mm	180.3 mm	203.4 mm	217.4 mm
6	175.2 mm	206.1 mm	229.2 mm	243.4 mm
7	201.0 mm	231.9 mm	255.0 mm	269.2 mm
8	226.8 mm	257.7 mm	280.8 mm	295.0 mm
9	252.6 mm	283.5 mm	306.6 mm	320.8 mm
10	278.4 mm	309.3 mm	332.4 mm	346.6 mm

Add 69 mm to any of these heights to get total height

Area in gray are IO-Link models only. Not available in AC.

Accessories are listed on pages 61



TL50BL Beacon Tower Lights

- Housing is UV stabilized, making it suitable for use in outdoor environments
- Highly visible indication for indoor or outdoor applications
- Compact, stylish design with rotating and flashing options
- Audible alert: continuous, pulsed and staccato models available
- Omni-Directional audible models provide clear annunciation in the noisiest environments
- Models available with rugged, water-resistant IP67 housing



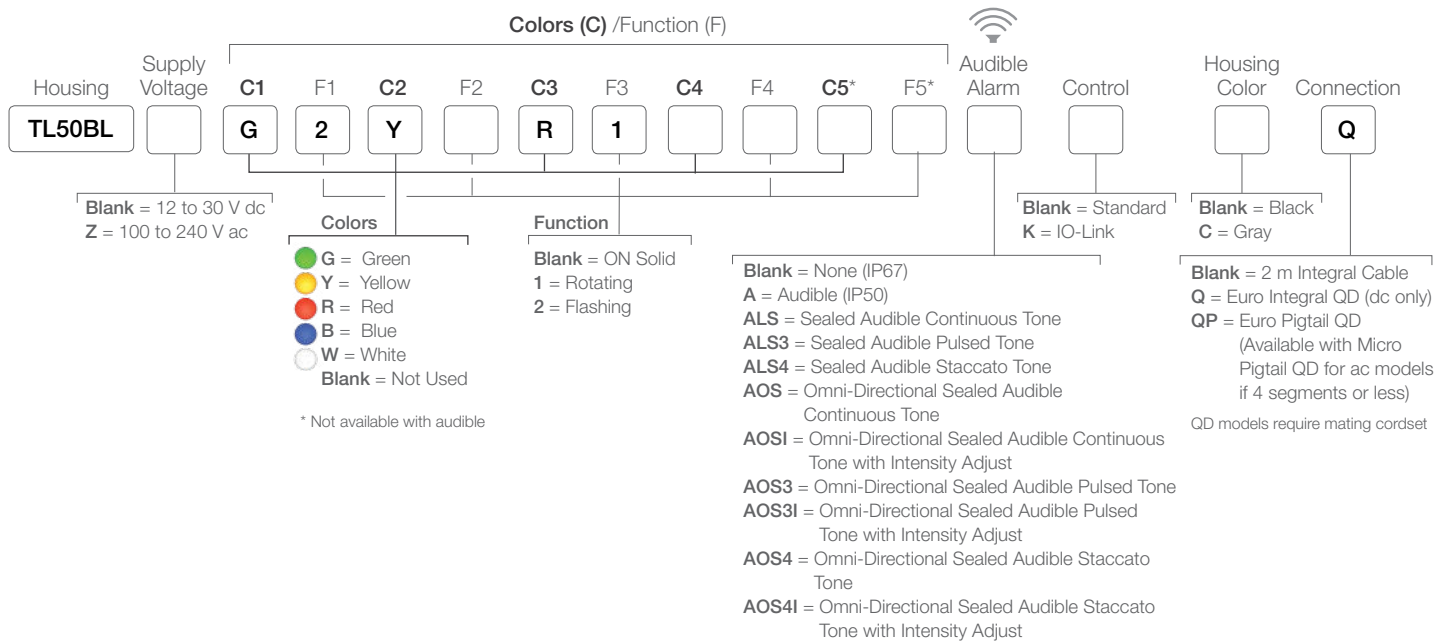

Supply Voltage	12 to 30 V dc or 21-27 V ac 100 to 240 V ac		<p>Audible max. intensity 92 db @ 1 meter (typical)</p> <p>Sealed Audible max. intensity 94 db @ 1 meter (typical)</p> <p>Sealed Omni-Directional Audible Standard: max. intensity 99 db @ 1 meter (typical) Intensity Adjust: max. intensity 95 db @ 1 meter (typical)</p>	
Construction	Bases and Covers: ABS Light Segment: Polycarbonate			
Environmental Rating	General-Purpose and Sealed Audible: IEC IP67 Standard Audible: IEC IP50			
Operating Temperature	General-Purpose: -40° to +50° C (-40° to +122° F) Standard and Sealed Audible: -20° to +50° C (-4° to +122° F)			
Certifications				



Color Count	Tower Height (H)				100 to 240 V AC
	General-Purpose IP67	Audible [†] IP50	Sealed Audible IP67	Sealed Omni-Directional	
1	46.2 mm	77.1 mm	100.2 mm	114.2 mm	
2	72.0 mm	102.9 mm	126.0 mm	140.0 mm	Add 69 mm to any of these heights to get total height
3	97.8 mm	128.7 mm	151.8 mm	165.8 mm	
4	123.6 mm	154.5 mm	177.6 mm	191.6 mm	
5	149.4 mm	—	—	—	

[†] Tower Height (H) with top unscrewed approximately 3.5 mm to allow sound to escape

Accessories are listed on pages 61



CL50 Column Lights

- Rugged, cost-effective, and easy-to-install multicolor indicators
- Illumination provides easy-to-see operator guidance and equipment status indication at long distances
- One-, two-, or three-color models available
- The LED light sources provide long life with low power consumption
- 100 to 240 V ac operation or 18 to 30 V dc operation
- Compact devices are completely self-contained—no controller needed—and IEC IP67 rated
- Immune to EMI and RFI interference
- No assembly required

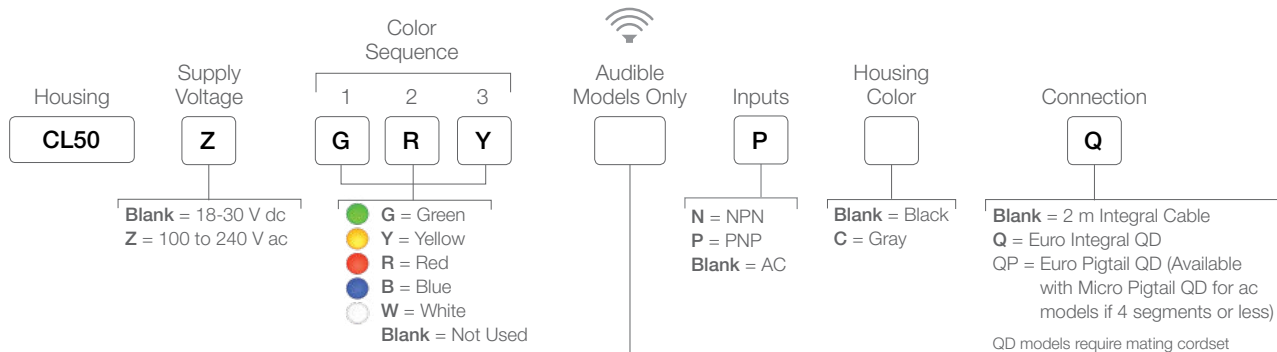

- Blank = None (IP67)
- A = Audible (IP50)
- ALS = Sealed Audible Continuous Tone
- ALS3 = Sealed Audible Pulsed Tone
- ALS4 = Sealed Audible Staccato Tone
- AOS = Omni-Directional Sealed Audible Continuous Tone
- AOSI = Omni-Directional Sealed Audible Continuous Tone–Intensity Adjust
- AOS3 = Omni-Directional Sealed Audible Pulsed Tone
- AOS3I = Omni-Directional Sealed Audible Pulsed Tone–Intensity Adjust
- AOS4 = Omni-Directional Sealed Audible Staccato Tone
- AOS4I = Omni-Directional Sealed Audible Staccato Tone–Intensity Adjust

Supply Voltage | 12 to 30 V dc or 21 to 27 V ac
100 to 240 V ac

Construction | Bases and Covers: ABS
Light Segment: Polycarbonate

Environmental Rating | General-Purpose and Sealed Audible: IEC IP67
Standard Audible: IEC IP50

Operating Temperature | General-Purpose:
–40° to +50° C (–40° to +122° F)
Standard and Sealed Audible:
–20° to +50° C (–4° to +122° F)

Certifications |  



Audible
max. intensity 92 db @ 1 meter (typical)

Sealed Audible
max. intensity 94 db @ 1 meter (typical)

Sealed Omni-Directional Audible
Standard: max. intensity 99 db @ 1 meter (typical)
Intensity Adjust: max. intensity 95 db @ 1 meter (typical)

Laser Marking Available



General-Purpose

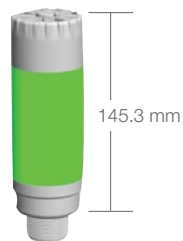

Audible



Sealed Audible



Sealed Omni-Directional Audible



100 to 240 V ac

Accessories are listed on pages 61

Cordsets for DC Models

4-Pin M12/Euro-Style

use with 3-color models

Straight connector models listed; for right-angle models, add RA to the end of model number (example, MQDC-406RA)

5-Pin M12/Euro-Style

use with 4-color models

Straight connector models listed; for right-angle models, add RA to the end of model number (example, MQDC1-506RA)

8-Pin M12/Euro-Style

use with 5+ -color models

Straight connector models listed; for right-angle models, add RA to the end of model number (example, MQDC2S-806RA)



MQDC-406
2 m (6.5')
MQDC-415
5 m (15')
MQDC-430
9 m (30')

MQDC1-506
2 m (6.5')
MQDC1-515
5 m (15')
MQDC1-530
9 m (30')

MQDC2S-806
2 m (6.5')
MQDC2S-815
5 m (15')
MQDC2S-830
9 m (30')

Mounting Brackets



SMB30MM



SMB30A



SMBAMS30P



SMB30RAVK

Cordsets for AC Models

4-Pin Micro-Style

Straight connector models listed; for right-angle models, add RA to the end of model number (example, MQAC2-406RA)

5-Pin Micro-Style

Straight connector models



MQAC2-406
2 m (6.5')
MQAC2-415
5 m (15')
MQAC2-430
9 m (30')

MQAC2-506
2 m (6.5')
MQAC2-515
5 m (15')
MQAC2-530
9 m (30')

Sealed Right-Angle Brackets



LMBE12RA



LMB30RA



LMBE12RAC



LMB30RAC



Controller

LC80T
5 Toggle switches
ON-OFF-FLASH function

LC80R
12-Position rotary
switches ON-OFF-FLASH
function



Laser Marking

Light sections can be permanently marked with custom text or images

Accessories

Elevated Mount System (for TL70)

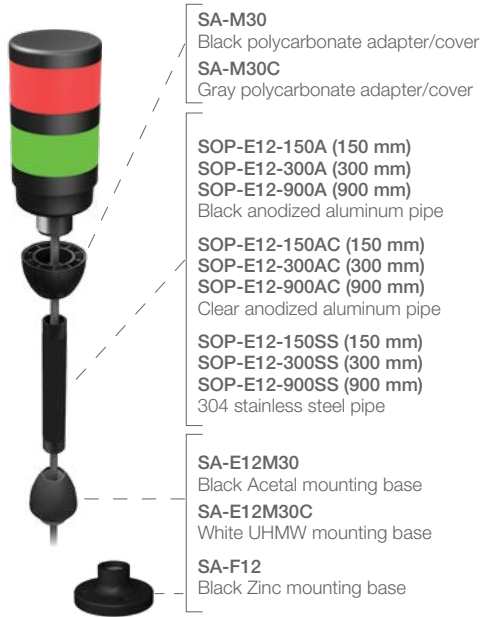

Elevated Mount System (for other models)

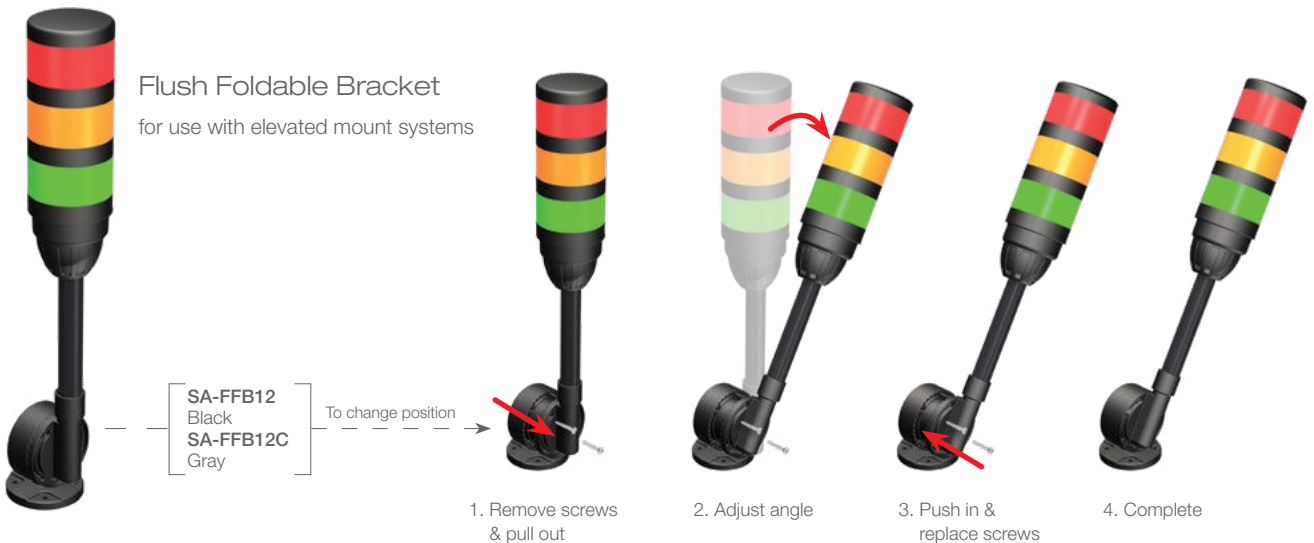
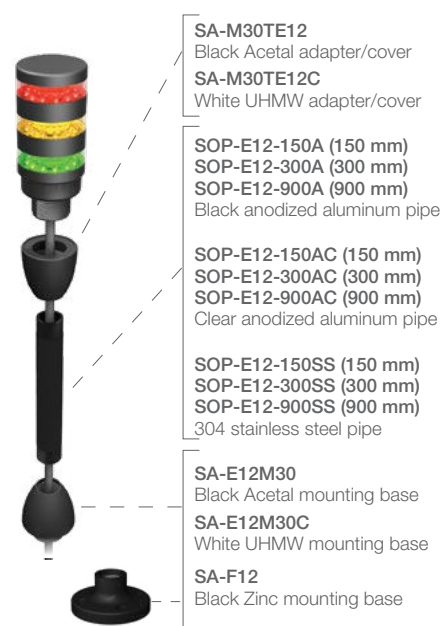

Additional accessories are available at bannerengineering.com



LINE 1

LINE 2

POWER ON

FAULT

POWER ON

FAULT



LAMP TEST

CYCLE ENABLE

LAMP TEST

CYCLE ENABLE



LAMP TEST

CYCLE HOLD

LAMP TEST

CYCLE HOLD





Indicators

Banner's Indicators offer a wide variety of bright, highly visible models ranging from daylight visible to multiple colors in one device. Indicators have a rugged design for long-term use and require no additional protective box. Flexibility in design, size and mounting provides a unique solution for many indication applications.

Selection Guide



Base Mount

Page	66	68	72	74	78
Family Name	K30L2 K50L2	K30L K50L	K70L	K90L	K50BL
Dome Size (mm)	30 50	30 50	70	90	50
Mounting Hole Diameter (mm)	22 30	22 30	30	30	30
AC/DC Power Option	DC	AC or DC	DC	DC	AC or DC
Audible Alarm Options					
Daylight Visible Options					
Multiple Colors per Light Segment	1-7 colors 7+ with IO-Link	K30: 1-3 K50: 1-5	1-5	1-5	1-3 depending on model
IP67 Options	IP66, IP67, IP69K	IP67, IP69K		IP67	IP67, IP69K
IO-Link					
Flashing or Strobing Options					
Hazardous Area Models		page 82			
Modbus Models		page 80			page 80



Flat Mount

Barrel Mount

92	88	90	94	84	86
K80 Segmented	K50FL	K80	SP Series	S18L/S22L	S22L2 Flush
80	50	50	50	18	20
NA	NA	NA	NA	18/22	22
DC	DC	AC or DC	AC or DC	DC	DC
	1-5	1-5	1-3	1-3	1-7
IP67	IP67, IP69K	IP67	IP67	IP67, IP69K	IP66, IP67, IP69K



K50L2 and K30L2 Domed Indicators

- Bright, even indication in red, green, blue, yellow, cyan, magenta, and white
- Rugged IP66, IP67, and IP69K polycarbonate housing protects against impact and withstands high-pressure, high-temperature washdown to ensure reliable performance in challenging environments
- Models constructed from FDA-grade materials available for use in food and beverage applications
- Simple wiring plan enables quick installation and allows users to consolidate controller outputs
- An optional audible alarm provides a distinct, loud notification of status (K50L2 models only)
- IO-Link enables full control of color, flashing, dimming, and advanced animations like rotation, strobing, 2-color display, 2-color rotation, 2-color flashing, and chase

K50L2

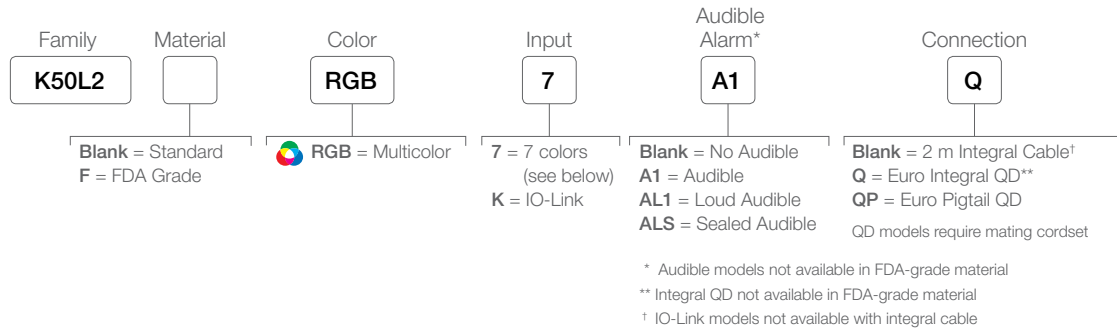

K30L2

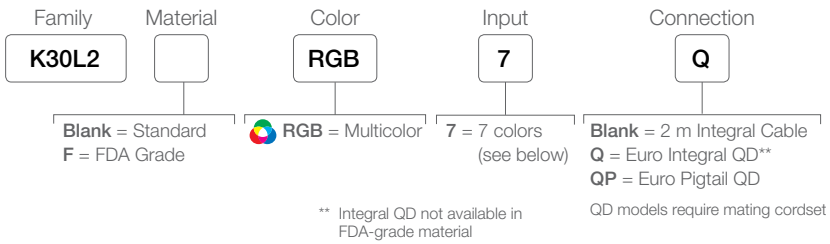

Seven colors now available in one unit

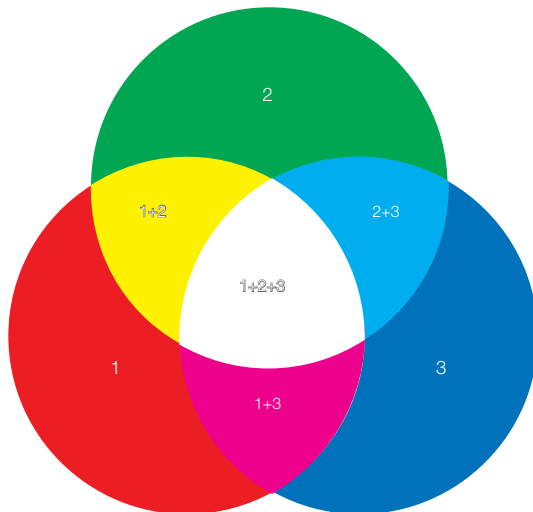

	Input 1	Input 2	Input 3
Red	ON		
Green		ON	
Blue			ON
Yellow	ON	ON	
Cyan		ON	ON
Magenta	ON		ON
White	ON	ON	ON



K50L and K30L Domed Indicators

- Rugged, cost-effective and easy-to-install indicators
- Illuminated dome provides easy-to-see operator guidance and indication of equipment status
- Compact devices are completely self-contained — no controller needed
- Displays up to five colors
- Immune to EMI and RFI interference

One-, Two- or Three-Color Indicators 18 to 30 V dc

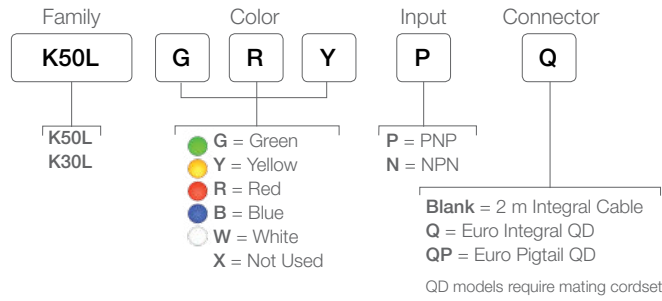

One-, Two- or Three-Color Indicators 85 to 120 V ac

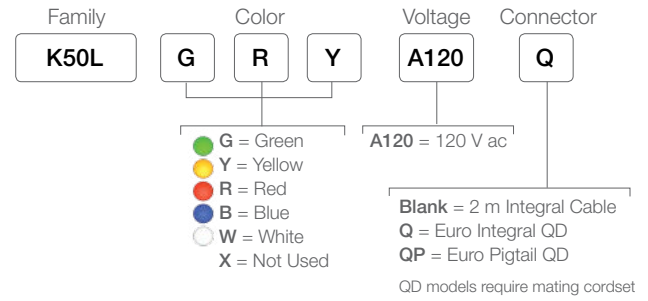

One-, Two- or Three-Color Audible Indicators

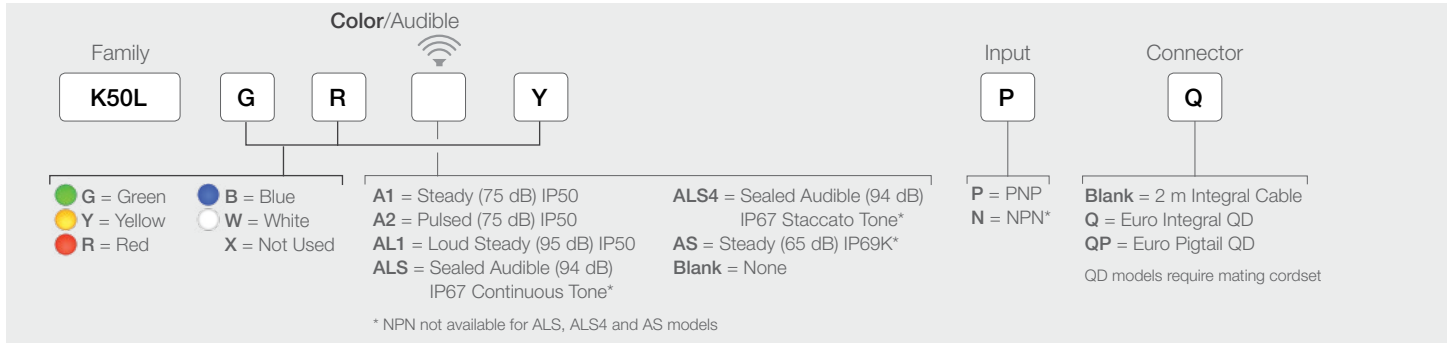

Three-Color Multifunction Indicators

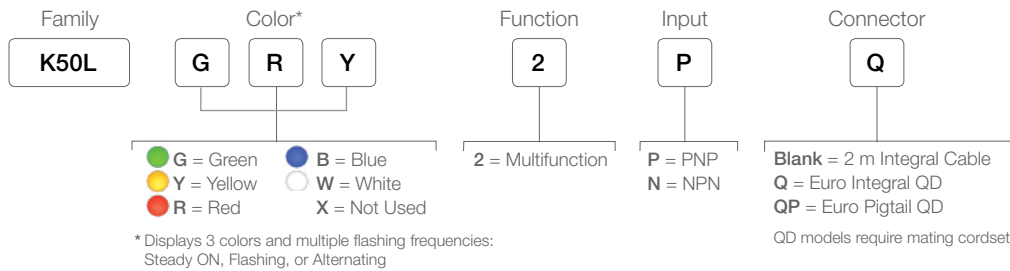

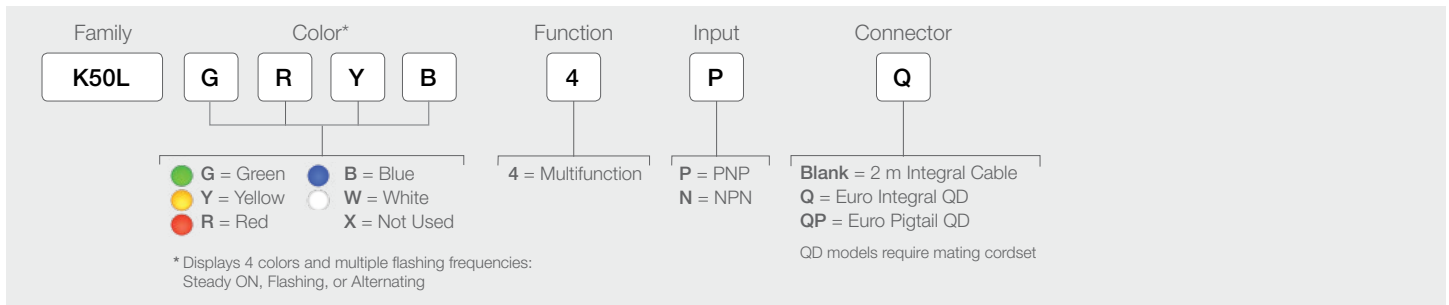

Four-Color Multifunction Indicators

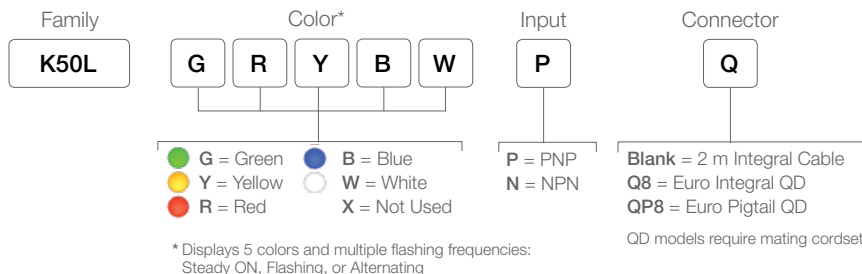

Five-Color Multifunction Indicators



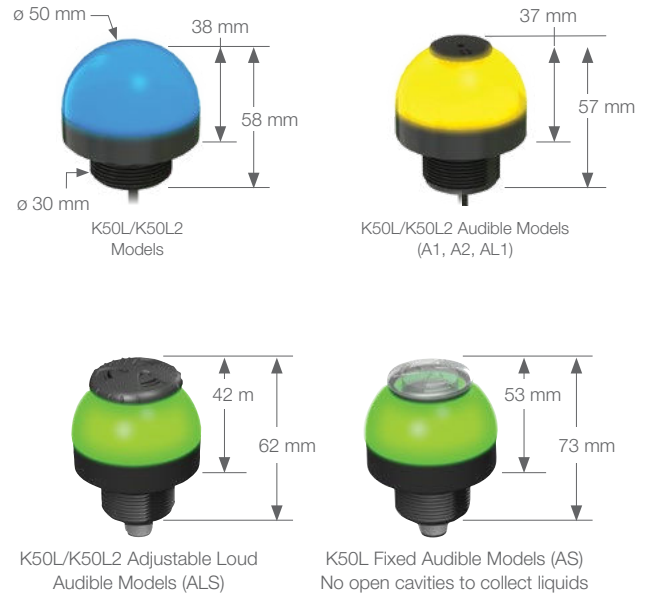

K50L/K30L Specifications

Supply Voltage	K50L Sealed Audible: 12 to 30 V dc K50L AC: 85 to 130 V ac K50L standard: 18 to 30 V dc K30L: 10 to 30 V dc
Construction	Base: polycarbonate Translucent Dome: polycarbonate
Environmental Rating	Standard Models: IEC IP67 Integral QD models meet DIN 40050 (IP69K) Standard Audible Models (A1, A2, AL1): IP50 Fixed Audible Sealed Models (AS): IEC IP67/ IP69K per DIN 40050 Adjustable Loud Audible Sealed Models (ALS, ALS4): IEC IP67/ IP69K per DIN 40050
Operating Temperature	Sealed Audible: -20 to +50 °C (-4 to +122 °F) All Other Models: -40 to +50 °C (-40 to +122 °F)
Certifications	   Audible:



K50L2/K30L2 Specifications

Power	K50L2: 10 to 30 V dc; 220mA Max. at 10 V dc; 100mA Max. at 30 V dc K30L2: 10 to 30 V dc; 60mA Max. at 10 V dc; 30mA Max. at 30 V dc
Operating Conditions	-40 to +50 °C (-40 to +122 °F)
Construction	Base: polycarbonate Translucent Dome: polycarbonate
Environmental Rating	K50L2: Standard: IEC IP66/IP67/IP69K Standard Audible: IEC IP50 Sealed Audible: IEC IP66/IP67/IP69K K30L2: IEC IP66/IP67/IP69K
Certifications	 



Accessories



SMB30A



SMB30SC



SMB30FA



SMB30FVK



SMB22A



SMBAMS22P



SMBAMS22RA



SA-FFB12
Black flush foldable bracket for use with elevated mount systems



SA-FFB12C
Gray flush foldable bracket for use with elevated mount systems

see page 61 for additional information on this bracket

Cordsets for DC Models



4-Pin M12/Euro-Style

use with 3-color models

Straight connector models listed; for right-angle models, add RA to the end of model number (example, MQDC-406RA)

- MQDC-406**
2 m (6.5')
- MQDC-415**
5 m (15')
- MQDC-430**
9 m (30')

5-Pin M12/Euro-Style

use with 4-color models

Straight connector models listed; for right-angle models, add RA to the end of model number (example, MQDC1-506RA)

- MQDC1-506**
2 m (6.5')
- MQDC1-515**
5 m (15')
- MQDC1-530**
9 m (30')

8-Pin M12/Euro-Style

use with 5+ -color models

Straight connector models listed; for right-angle models, add RA to the end of model number (example, MQDC2S-806RA)

- MQDC2S-806**
2 m (6.5')
- MQDC2S-815**
5 m (15')
- MQDC2S-830**
9 m (30')

Cordsets for AC Models



4-Pin Micro-Style

Straight connector models listed; for right-angle models, add RA to the end of model number (example, MQAC2-406RA)

- MQAC2-406**
2 m (6.5')
- MQAC2-415**
5 m (15')
- MQAC2-430**
9 m (30')

5-Pin Micro-Style

Straight connector models

- MQAC2-506**
2 m (6.5')
- MQAC2-515**
5 m (15')
- MQAC2-530**
9 m (30')

Elevated Mount System



Additional accessories are available at bannerengineering.com





K70L 70 mm Domed Indicators

- Bright, uniform indicator light
- All models have flashing input control
- Models are available with up to five colors in one device
- Rugged IP65-rated design
- 12 V to 30 V dc operation
- Wireless models simplify installation and provide a simple operator interface for pick-to-light, call button and general industrial applications

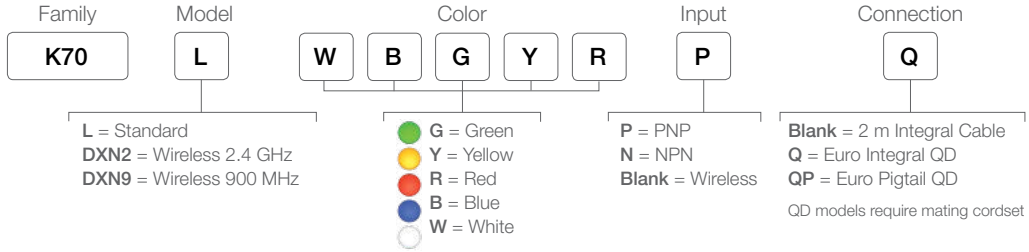
Standard and Wireless



Supply Voltage and Current	12 V to 30 V dc; 200 mA Max. at 12 V dc; 90 mA Max. at 30 V dc
Supply Protection Circuitry	Protected against reverse polarity, transient voltages
Construction	Base: polycarbonate Translucent Dome: polycarbonate
Environmental Rating	IEC IP65
Operating Temperature	-40 to 50 °C
Certifications	  



Elevated Mount System

 SMB30A	 SMB30MM	 SA-M30 Black polycarbonate adapter/cover SA-M30C Gray polycarbonate adapter/cover	 MQDC1-506 2 m (6.5') MQDC1-515 5 m (15') MQDC1-530 9 m (30')
 SMBAMS30P	 SSA-MBK-EEC1	 SOP-E12-150A (150 mm) SOP-E12-300A (300 mm) SOP-E12-900A (900 mm) Black anodized aluminum pipe SOP-E12-150AC (150 mm) SOP-E12-300AC (300 mm) SOP-E12-900AC (900 mm) Clear anodized aluminum pipe SOP-E12-150SS (150 mm) SOP-E12-300SS (300 mm) SOP-E12-900SS (900 mm) 304 stainless steel pipe	5-Pin M12/Euro-Style use with 4-color models Straight connector models listed; for right-angle models, add RA to the end of model number (example, MQDC1-506RA)
		SA-E12M30 Black Acetal mounting base SA-E12M30C White UHMW mounting base	8-Pin M12/Euro-Style use with 5+ -color models Straight connector models listed; for right-angle models, add RA to the end of model number (example, MQDC2S-806RA)
		SA-FFB12 Black flush foldable bracket for use with elevated mount systems SA-FFB12C Gray flush foldable bracket for use with elevated mount systems	MQDC2S-806 2 m (6.5') MQDC2S-815 5 m (15') MQDC2S-830 9 m (30')

See page 61 for additional information on this bracket



Additional accessories are available at bannerengineering.com

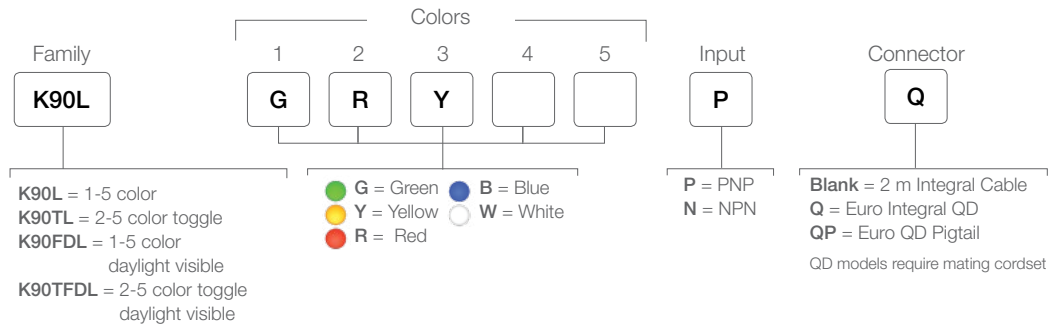

K90L 90 mm Domed Indicators

- Bright, uniform indicator light
- Models are available with up to five colors in one device
- Rugged IP67-rated design
- 12 to 30 V dc operation
- Illuminated dome provides easy-to-see operator guidance
- K90TL models alternate between colors when multiple inputs are active
- K90L models have an auxiliary input line for flashing an active input



Supply Voltage	12 to 30 V dc
Construction	Base: polycarbonate Translucent Dome: polycarbonate
Environmental Rating	IP67
Operating Temperature	-40 to +50° C (-40 to +122 °F)
Certifications	 

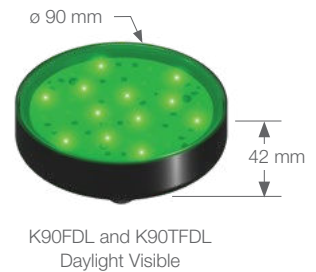
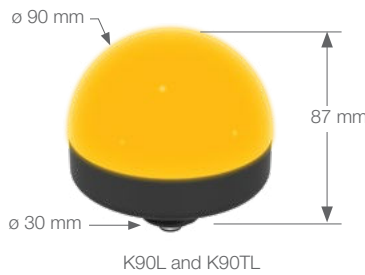

Elevated Mount System

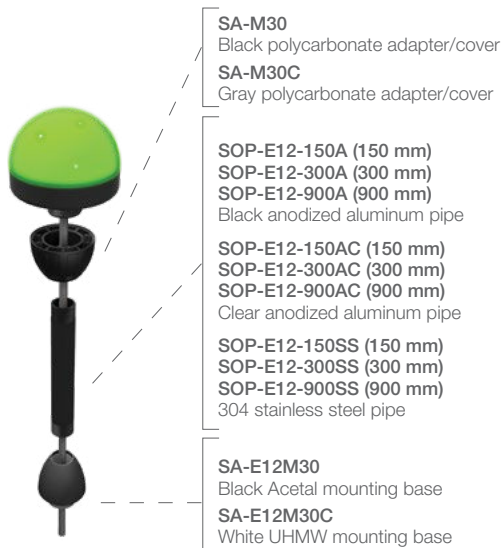

5-Pin M12/Euro-Style
use with 4-color models

Straight connector models listed; for right-angle models, add RA to the end of model number (example, MQDC1-506RA)



MQDC1-506
2 m (6.5')
MQDC1-515
5 m (15')
MQDC1-530
9 m (30')

8-Pin M12/Euro-Style
use with 5+ -color models

Straight connector models listed; for right-angle models, add RA to the end of model number (example, MQDC2S-806RA)

MQDC2S-806
2 m (6.5')
MQDC2S-815
5 m (15')
MQDC2S-830
9 m (30')

Additional accessories are available at bannerengineering.com



K50 Beacon Omni-Directional High-Intensity Indicators

- Continuous, strobing and rotating models available
- Intense levels of light output for outdoor applications
- 12-30 V dc models are ideal for battery-powered mobile applications
- LED lighting emits from the perimeter and top view on some models
- Rugged, sealed thermoplastic housing rated for IP67 and IP69K
- Cabled and quick-disconnect models available

One-, Two-, or Three-Color DC

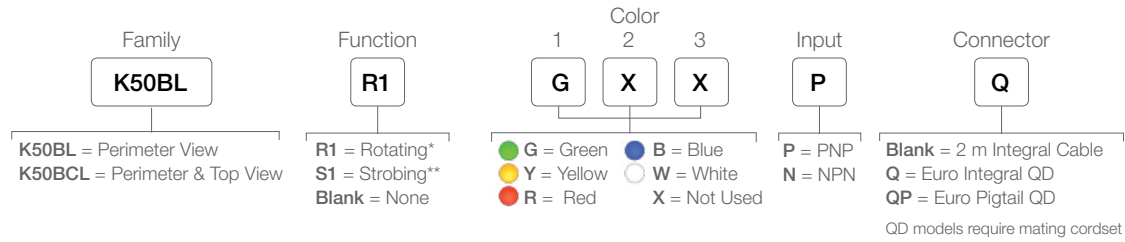

* Rotating only available on K50BL 1-color models
** Strobing only available on K50BCL 1-color models

One- Color AC



Supply Voltage

12 to 30 V dc
85 to 130 V ac
100 to 250 V ac

Construction

Base and covers: polycarbonate

Environmental Rating

IEC IP67 and IP69K, per DIN 40050

Operating Temperature

-40 to +50 °C (-40 to +122 °F)

Certifications



- SA-M30E12**
Black Acetal adapter/cover
- SA-M30E12C**
White UHMW adapter/cover
- SOP-E12-150A (150 mm)**
SOP-E12-300A (300 mm)
SOP-E12-900A (900 mm)
Black anodized aluminum pipe
- SOP-E12-150SS (150 mm)**
SOP-E12-300SS (300 mm)
SOP-E12-900SS (900 mm)
304 stainless steel pipe
- SA-E12M30**
Black Acetal mounting base
- SA-E12M30C**
White UHMW mounting base



4-Pin M12/ Euro-Style
Straight connector models listed;
for right-angle models, add RA
to the end of model number
(example, MQDC-406RA)

MQDC-406
2 m (6.5')
MQDC-415
5 m (15')
MQDC-430
9 m (30')

3-Pin M12/Micro-Style
Straight connector models listed;
for right-angle models, add RA
to the end of model number
(example, MQDC-306RA)

MQDC-306
2 m (6.5')
MQDC-315
5 m (15')
MQDC-330
9 m (30')

Additional accessories are available at
bannerengineering.com



see page 61 for additional
information on this folding bracket



K50L Daylight Visible Directional Indicators

- Intense levels of light output for outdoor applications
- Rugged, cost-effective and easy-to-install
- Compact devices are completely self-contained — no controller needed
- Up to three colors in one housing
- Immune to ambient light, EMI and RFI interference
- 50 mm diameter with flat profile and 30 mm mounting base
- Available in both 18 to 30 V dc and 85 to 130 V ac power options

One- or Three- Color Indicators, 15 to 30 V dc

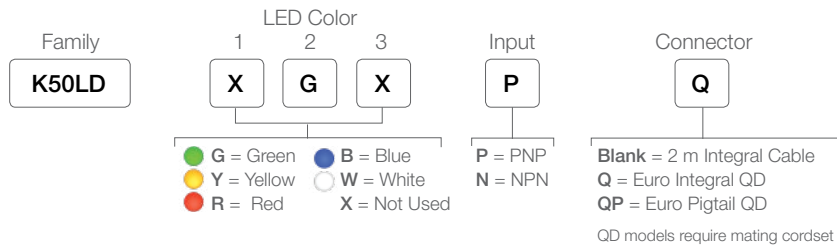

One- Color Indicators, 85 to 130 V ac

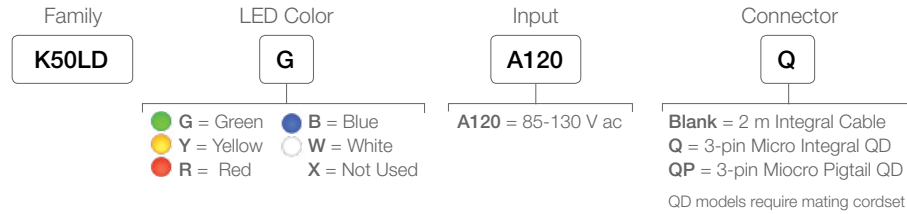

Supply Voltage	15 to 30 V dc 85 to 130 V ac
Construction	Polycarbonate; fully encapsulated
Environmental Rating	IEC IP67
Operating Temperature	-40 to +50 °C (-40 to +122 °F)
Certifications	CE



Additional accessories are available at bannerengineering.com



4-Pin M12/ Euro-Style
Straight connector models listed;
for right-angle models, add RA to
the end of model number
(example, MQDC-406RA)

MQDC-406
2 m (6.5')
MQDC-415
5 m (15')
MQDC-430
9 m (30')

3-Pin M12/Micro-Style
Straight connector models listed;
for right-angle models, add RA to
the end of model number
(example, MQDC-306RA)

MQDC-306
2 m (6.5')
MQDC-315
5 m (15')
MQDC-330
9 m (30')



K50 Modbus Indicators

- Rugged, compact multi-color indicators in several package types
- Built-in flashing and strobing capability
- High intensity models for outdoor applications
- Fully encapsulated IP67/IP69K construction
- Modbus RTU communication minimizes the cabling requirements

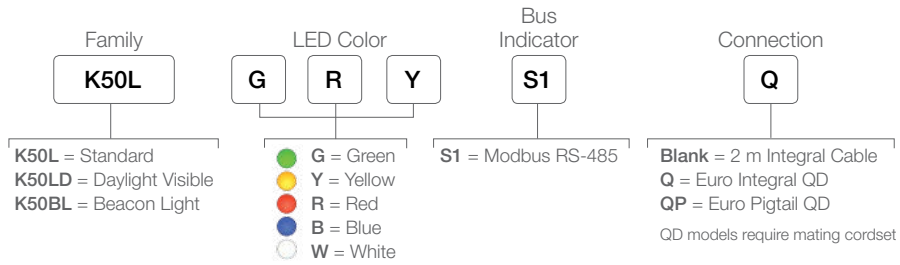

Supply Voltage	12 to 30 V dc
Construction	Base: Polycarbonate Covers: Polycarbonate LEDs on LD Models: Acrylic
Environmental Rating	IEC IP67/IP69K per DIN 40050
Operating Temperature	-40 to +50 °C (-40 to +122 °F)
Certifications	



K50BL Models

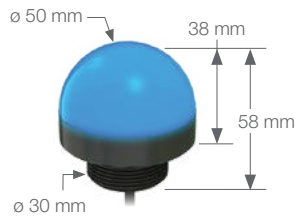

K50L Models



K50LD Models



SMB30A



SMB30FA



SMB30SC



SMBAMS30P

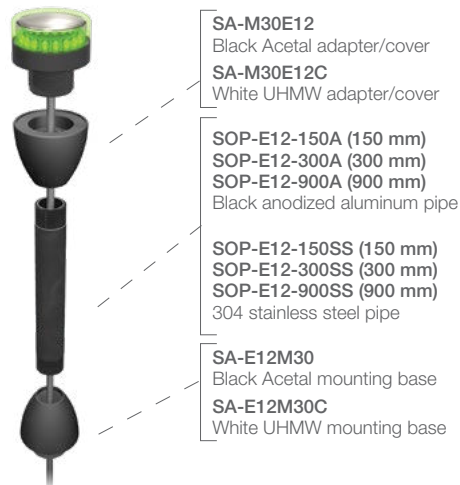

see page 61 for additional information on this folding bracket

Additional accessories are available at bannerengineering.com



K50 and K30 Hazardous Indicators

- Up to three colors in one device and five colors to choose from
- Models rated to IP67 and IP69K for use in harsh environments
- Unique design appears gray when off, eliminating false indication from ambient light
- Easy mounting and configuration
- Extensive approvals ensure indicator lights are safe to use in most classified zones or areas.
- Worldwide IECEx approval for quicker access into countries outside Europe and North America

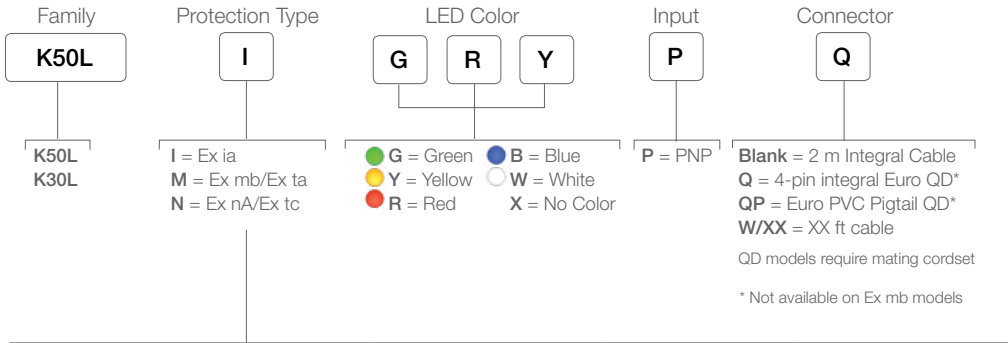

Indicator Family	Protection Method	Suitable for ATEX	Suitable for NEC & CEC	
Ex ia	Intrinsically Safe	Gas Zones: 0, 1, & 2 Dust Zones: 20, 21, & 22 Mines	Gas zones: 0, 1, & 2	Class I Division 1 & 2 Class II/III Division 1 & 2
Ex mb/Ex ta	Encapsulation/Enclosure	Gas Zones: 1 & 2 Dust Zones: 20, 21 & 22	Gas zones: 1 & 2	Class I Division 2 Class II/III Division 1 & 2**
Ex nA/Ex tc	Non-Sparking/Enclosure	Gas Zones: 2 Dust Zones: 22	Gas zones: 2	Class I Division 2 Class II/III Division 2**

** Available on K50L models only

- Supply Voltage**
Ex ia: 8 to 30 V dc
Ex mb/Ex ta and Ex nA/Ex tc: 10 to 30 V dc
- Construction**
Base: polycarbonate
Translucent Dome: polycarbonate
- Environmental Rating**
IP67, IP69K
- Operating Temperature**
-40 to +50 °C (-40 to +122 °F)
- Certifications**

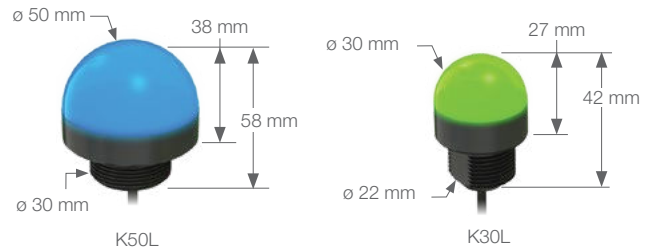

4-Pin M12/Euro-Style
 Straight connector models listed;
 for right-angle models, add RA
 to the end of model number
 (example, MQDC-406RA)

- MQDC-406**
2 m (6.5')
- MQDC-415**
5 m (15')
- MQDC-430**
9 m (30')

Additional accessories are available at
bannerengineering.com



S18L & S22L Barrel Indicators

- Gasketed face flange for sealing to enclosures
- IP69K rated to withstand harsh wash-down environments
- Daylight visible models are also available for areas with high levels of ambient light
- M12 Euro connector models available for plug-and-play indication
- 10 to 30 V dc operating range allows for use in battery-powered mobile applications
- Terminal-wired models available to simplify panel wiring
- Up to three independent colors in one unit
- Translucent face appears gray when off to avoid false indication
- Multiple colors available, including green, red, yellow, blue, white, orange
- Available with PNP or NPN input, depending on model

Standard

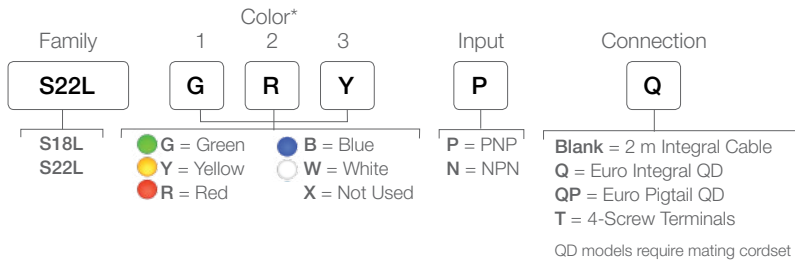

Laser Marking Available

Daylight Visible

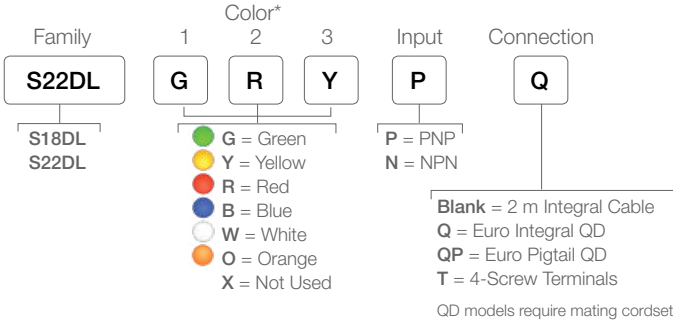

Daylight Visible High-Intensity

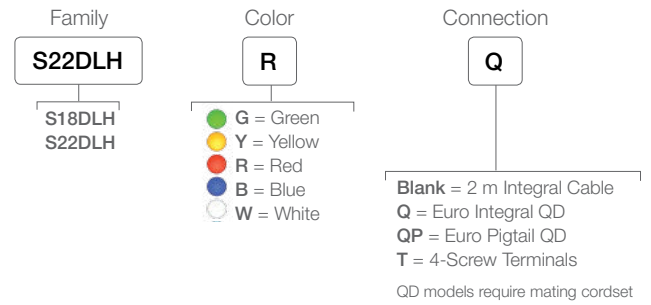

* Single-color models are available and should be ordered as PNP, but can be wired for either PNP or NPN input

Supply Voltage

General Purpose: 10 to 30 V dc
 High-Intensity Models: 9 to 30 V dc

Construction

Housing: UV stabilized polycarbonate
 Mounting Nut: PBT
 Sealing Washer: Nitrile

Environmental Rating

IEC IP67, IP69K, per DIN 40050

Operating Temperature

General Purpose: -40 to +50 °C (-40 to +122 °F)
 Other Models: -40 to +60 °C (-40 to +140 °F)

Certifications

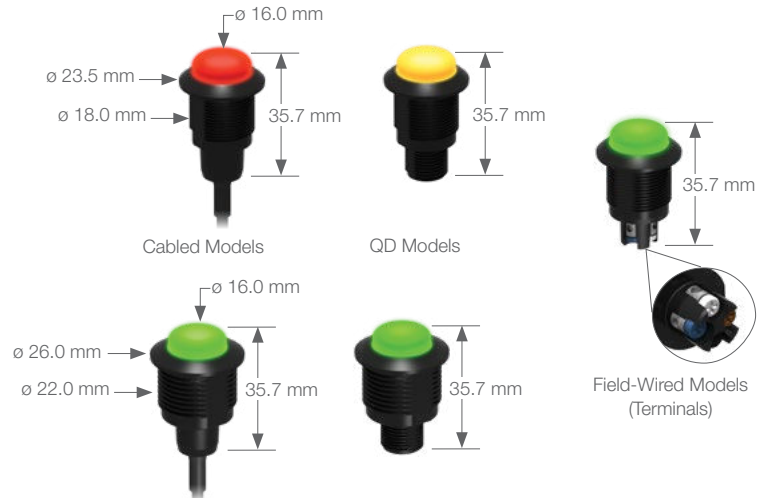

SMB18A
use with S18L



SMB18FA
use with S18L



SMB22A
use with S22L



SMBAMS18RA
use with S18L



SMBC18
for use with S18L
on 28 mm pipe



SMBAMS22RA
use with S22L



4-Pin M12/Euro-Style
 Straight connector models listed;
 for right-angle models, add RA
 to the end of model number
 (example, MQDC-406RA)

MQDC-406
2 m (6.5')
MQDC-415
5 m (15')
MQDC-430
9 m (30')

Additional accessories are available at
bannerengineering.com



S22L2 Flush Mount Indicator

- Bright, even indication in red, green, blue, yellow, cyan, magenta, and white
- Models constructed from FDA-grade materials available for use in food and beverage applications
- Terminal connector options for fast, economical installation in panels
- Flush design matches S22 Touch buttons, see page 102



Supply Voltage

10 to 30 V dc

Construction

Housing: Polycarbonate or FDA grade plastic, depending on model
 Translucent dome: Polycarbonate or FDA grade plastic, depending on model
 Mounting Nut: PBT or FDA food grade plastic

Environmental Rating

Standard: UL Type 4x, 13
 FDA Grade: UL Type 4x (indoor)
 Cable, Pigtail, QD models: IEC IP66, IP67, IP69K per DIN 40050-9
 Terminal models: IEC IP66, IP69K per DIN 40050-9 on front only

Operating Conditions

Temperature: -40 to +50 °C
 Storage Temperature: -40 to +70 °C

Certifications

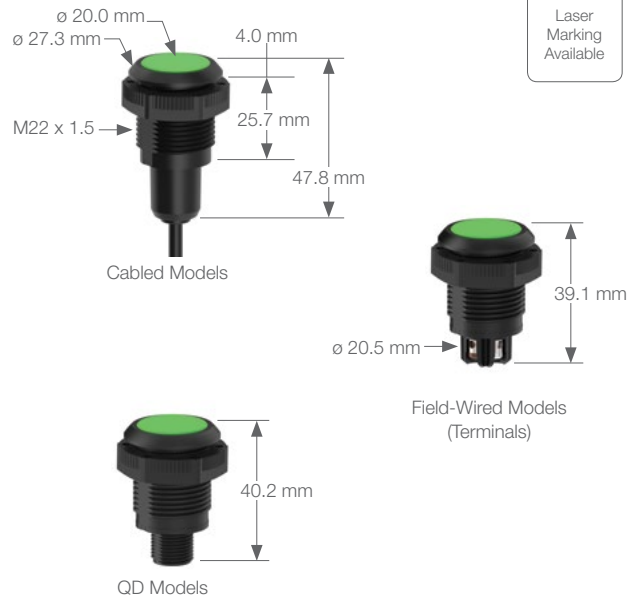

5-Pin Euro-Style

Straight connector models listed; for right-angle models, add RA to the end of model number (example, MQDC1-506RA)

- MQDC1-506**
2 m (6.5')
- MQDC1-515**
5 m (15')
- MQDC1-530**
9 m (30')

5-pin M12 Euro-Style Washdown Cordset
 Straight connector models only

- MQDC-WDSS-0506**
2 m (6.5')
- MQDC-WDSS-0515**
5 m (15')
- MQDC-WDSS-0530**
9 m (30')

Additional accessories are available at bannerengineering.com



K50FL Flat-Mount Domed Indicators

- Rugged, cost-effective and easy-to-install indicators
- Low power consumption LED design will provide years of reliable service
- Fully encapsulated IP67, IP69K
- Illuminated dome provides easy-to-see operator guidance and indication of equipment status
- Compact devices are completely self-contained — no controller needed
- 18 to 30 V dc operation
- Displays up to five colors
- Immune to EMI and RFI interference

One-, Two- or Three-Color, 18 to 30 V dc

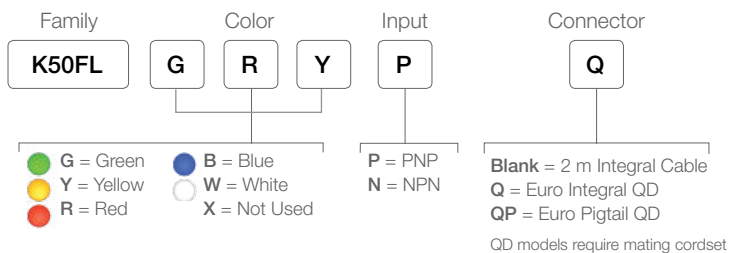

Three-Color Multifunction

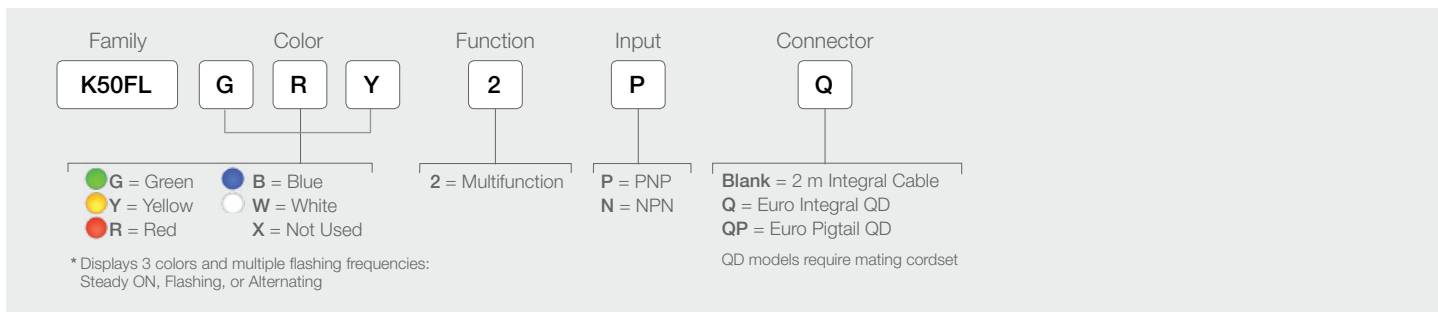

Four-Color Multifunction

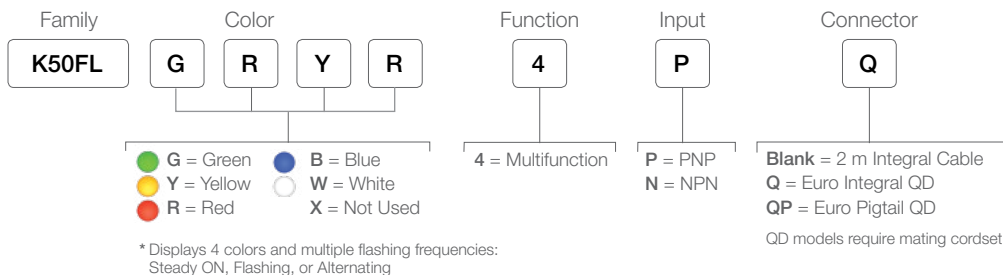

Five-Color Multifunction

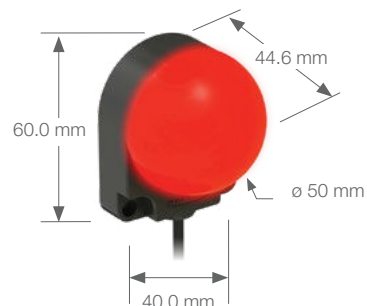
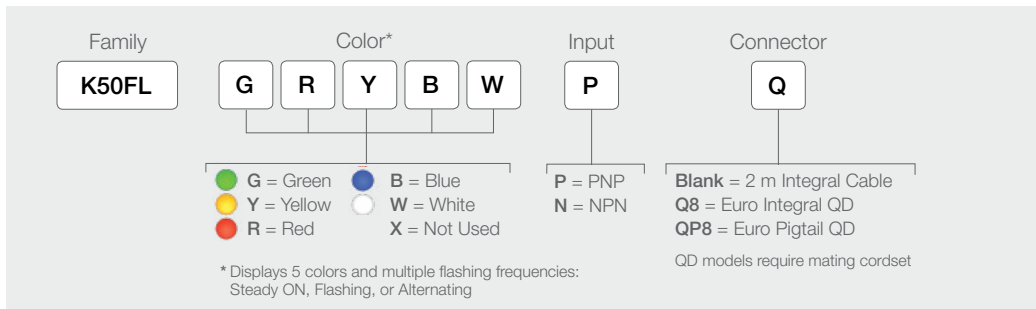

Supply Voltage	18 to 30 V dc
Construction	Base: ABS Dome: Polycarbonate
Environmental Rating	IP67, IP69K
Operating Temperature	-40 to +50 °C (-40 to +122 °F)
Certifications	CE

4-Pin M12/Euro-Style
 Straight connector models listed;
 for right-angle models, add RA
 to the end of model number
 (example, MQDC-406RA)

4-Pin	5-Pin	8-Pin
MQDC-406 2 m (6.5')	MQDC1-506 2 m (6.5')	MQDC2-806 2 m (6.5')
MQDC-415 5 m (15')	MQDC1-515 5 m (15')	MQDC2-815 5 m (15')
MQDC-430 9 m (30')	MQDC1-530 9 m (30')	MQDC2-830 9 m (30')



K80FL and K80FDL Flat-Mount Indicators

- Selection of solid or flashing light operation with internal DIP Switch
- Multicolor, single segment
- Bright, even LED light gray when OFF
- Unique shape for use in various indication applications
- Sealed to IP67 for durability in many environments
- Large, flat face allows for clear indication from greater distances
- Transparent self-adhesive cover labels can be printed for easy identification
- Daylight visible models available

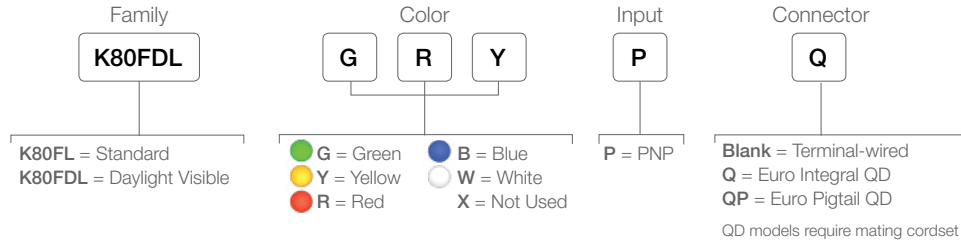

Supply Voltage	12 to 30 V dc
Construction	Base: Polycarbonate Translucent Face: Acrylic
Environmental Rating	IEC IP67
Operating Conditions	-40 to +50 °C (-40 to +122 °F)
Certifications	CE



SMBDX80DIN
for mounting to 35 mm DIN Rail



4-Pin M12/Euro-Style
 Straight connector models listed;
 for right-angle models, add RA
 to the end of model number
 (example, MQDC-406RA)

- MQDC-406**
2 m (6.5')
- MQDC-415**
5 m (15')
- MQDC-430**
9 m (30')

Additional accessories are available at
bannerengineering.com



K80 Segmented Indicators

- Individual color quadrants can be lighted separately or in combination
- For error-proofing and "Andon" applications
- Provides operator guidance, even for those with limited color recognition ability
- Optional labels for enhanced segment identification
- Mounts easily on flat surface or pipe for elevated use
- PNP (sourcing) or NPN (sinking) input type, depending on model
- Flash functionality available on one-color models

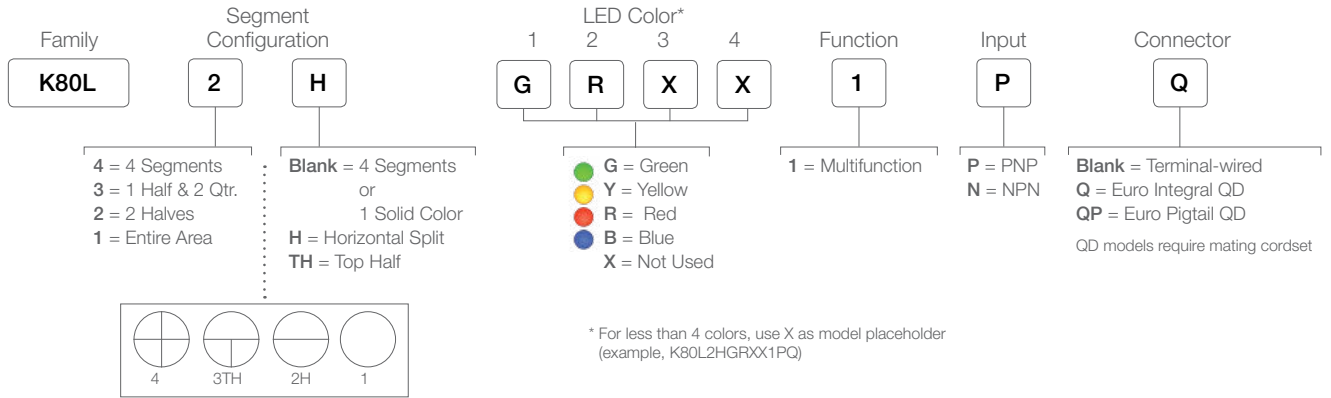

Supply Voltage | 18 to 30 V dc

Construction | Base: ABS/Polycarbonate
Translucent Face: Acrylic

Environmental Rating | IEC IP67

Operating Temperature | -40 to +50 °C (-40 to +122 °F)

Certifications | **CE**

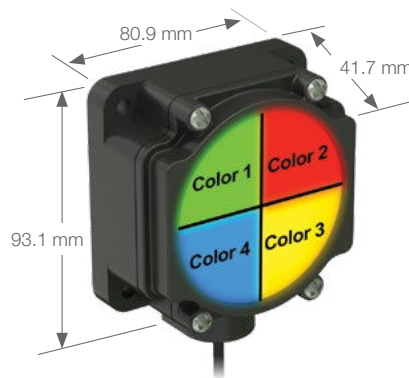

2-Segment



3-Segment



4-Segment



SMBDX80DIN
for mounting to 35 mm DIN Rail

Segmented Indicator Label Kits



SALK-K80L4
4-segment transparent laser label (includes 30 labels and 1 protective cover labels)



SALK-K804-0
1-segment transparent laser label (includes 30 labels)



**5-Pin M12/
Euro-Style**
Straight connector models listed; for right-angle models, add RA to the end of model number (example, MQDC1-506RA)

MQDC1-506
2 m (6.5')
MQDC1-515
5 m (15')
MQDC1-530
9 m (30')

Additional accessories are available at bannerengineering.com



SP Series Signal Lights

- Intense levels of light output for outdoor applications
- Controlled field of view for signage and narrow lane use
- Rugged, cost-effective and easy-to-install
- Compact devices are completely self-contained — no controller needed
- Immune to EMI and RFI interference
- Choose NPN or PNP input, and 15 to 30 V dc or 85-130 V ac operation, depending on model

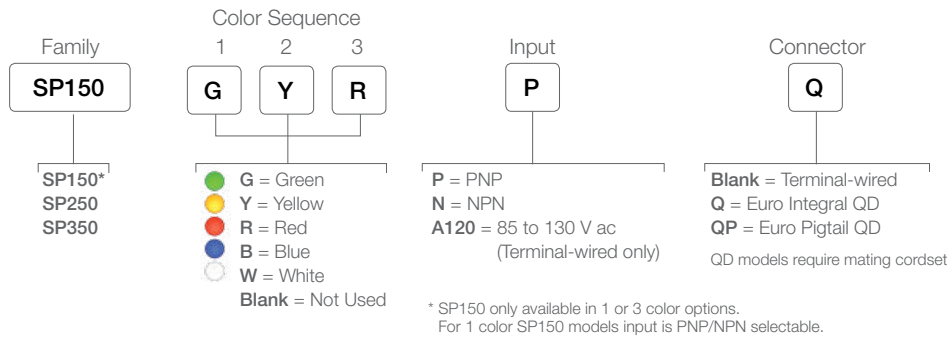

Supply Voltage	15 to 30 V dc 85 to 130 V ac
Construction	Flat or DIN-mount polycarbonate
Environmental Rating	SP150: IEC IP67 SP250: IEC IP65 SP350: IEC IP65
Operating Conditions	-40 to +50 °C (-40 to +122 °F)
Certifications	CE

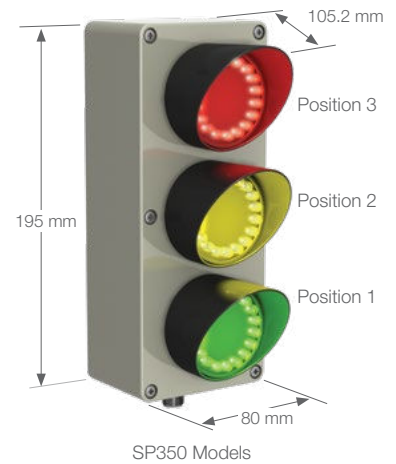
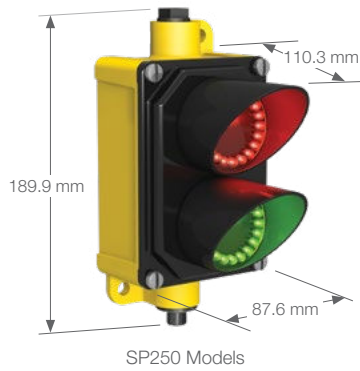

SMBDX80DIN
for mounting to 35 mm DIN Rail



SMBSP350 (Tabs only)



4-Pin M12/Euro-Style
straight connector models listed;
for right-angle models, add RA
to the end of model number
(example, MQDC-406RA)

MQDC-406	2 m (6.5')
MQDC-415	5 m (15')
MQDC-430	9 m (30')

Additional accessories are available at bannerengineering.com

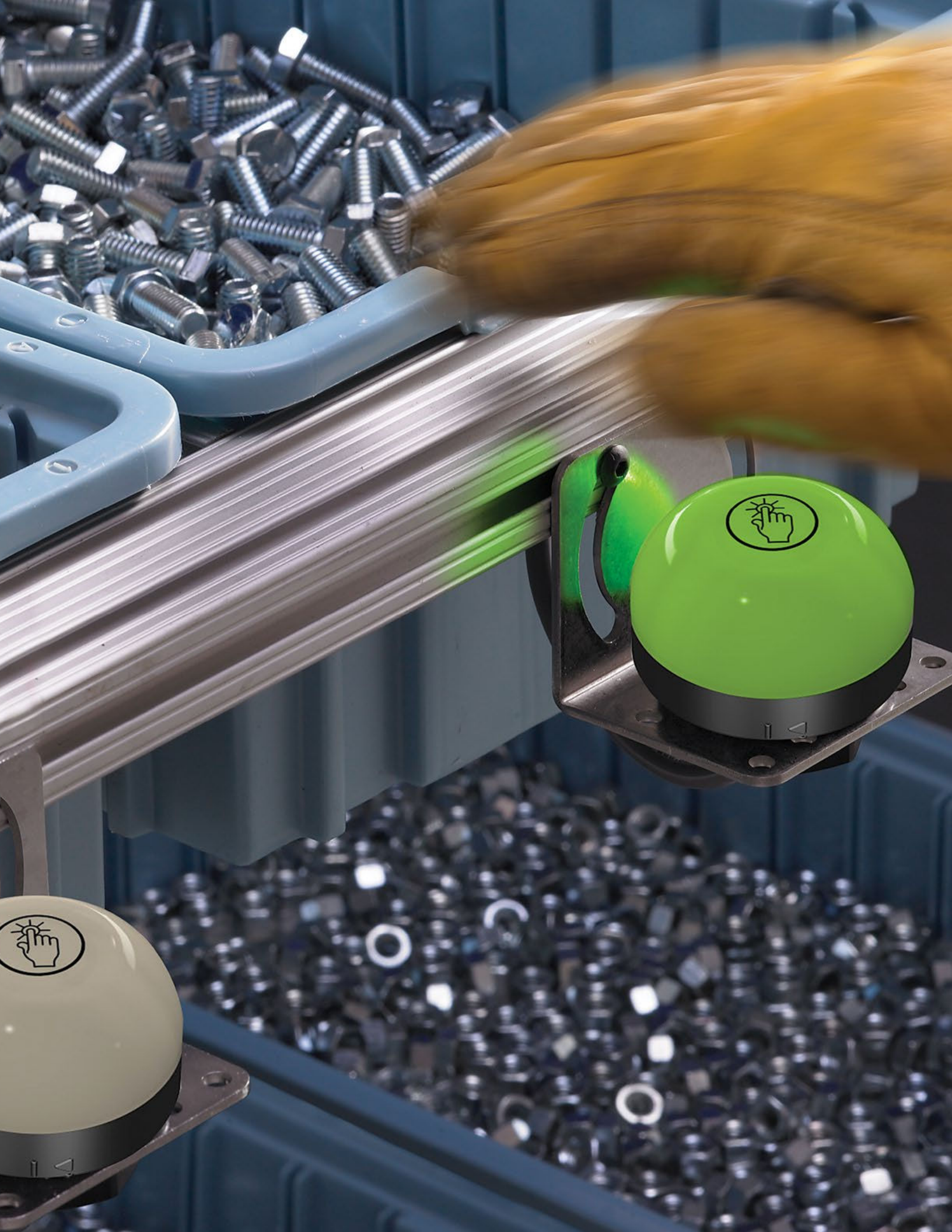



Touch Buttons and Pick-to-Light

Banner is the leader in ergonomic, visual and sealed operator touch buttons for industrial applications. Since Banner Touch Buttons can have multiple colors and I/O capabilities, they can replace several conventional buttons, making them ideal in lean manufacturing environments.

Pick-to-light sensors help industrial automation manufacturers reduce the risk of error in the assembly process, boosting product quality and reducing cost.

Selection Guide



Touch Buttons

Page	102	104	106	108	110	112	114	116	118
Family Name	S22	K30	K50	K70	K30L/K50L Push Button	OTB	VTB	Illuminated E-Stops	Flush-Mount Illuminated E-Stops
Size (mm)	20 mm surface	30 mm dome	50 mm dome	70 mm dome	30/50 mm dome	74.2 x 59.9 x 43.2	73.3 x 43.2 x 43.2	119.8 x ø 80	102.1 x 80.8 x 80.3
Actuation Method									
Color Available									
Multicolor Option									
IP Rating	IP66, IP67, IP69K	IP67, IP69K	IP67, IP69K	IP65	IP65	IP66	IP66	IP65	IP65
Logic Function	F2, H	F2, H	F2, H	F2, H					



Pick-to-Light

102	120	106	124	126	128	130	132	136	134
S22	K30	K50	K70L	K50 Optical	K50 Modbus	K30/K50/K80 Push Button	PVD	PVL	PVA
20 mm surface	30 mm dome	50 mm dome	70 mm dome	50 mm dome	50 mm dome	30/50/50 mm dome	137.8 or 266.4	327.5 or 608	137.8 to 416.6
					or				
IP66, IP67, IP69K	IP67, IP69K	IP67, IP69K	IP65	IP67, IP69K	IP67	IP67	IP62	IP50	IP62
C, E, C3, C4	C, D, E	C, D, E C3, C4	C, D, E C3, C4	C, D, E C3, C4	S1	C, D, E C3, C4			



Logic Functions

Illuminated buttons are available with different logic options to solve a variety of applications with optimized wiring. Multicolor models provide clear operator guidance to improve speed and accuracy.

PICK-TO-LIGHT: Two-color logic options for error-proofing, picking, putting and verification

- C** | Input activates Color 1. Touch activates Color 2 and Output.
- D** | Input activates Color 1. Touch activates Output.
- E** | Input activates Color 1. Touch activates Output. Touch with inactive input activates Color 2.

MULTIPURPOSE: Full color control via three inputs independent of button; momentary output follows button

- F2** | Three inputs activate three colors. Color 3 overrides Colors 1 and 2, and Color 2 overrides Color 1. Touch changes output state.

ILLUMINATED BUTTONS: One or two colors with momentary or latching bipolar outputs that follow button

- H** | Power activates Color 1. Touch changes bipolar output state and activates Color 2. Latch and momentary options.

SPECIALTY PICK-TO-LIGHT: Three-color logic options for error-proofing, picking, putting and verification

- C3** | Input activates Color 1. Touch with active input activates Color 3 and Output. Touch with inactive input activates Color 2 and Output.
- C4** | Input activates Color 1. Touch with active input activates Color 3 and Output. Touch with inactive input activates Color 2 and Output for 5 seconds.

MODBUS: Color control and input monitoring via Modbus RTU

- S1** | Modbus commands activate Colors. Touch activates Modbus output.

Actuation Methods

The actuation method is the means by which an operator's actions are sensed. Banner's Pick-to-Light line includes a variety of actuation methods, including contact and non-contact sensors covering a single point on a small bin or a wide opening on a large bin. These actuation methods enable error proofing in a large variety of assembly and kitting applications. Below is a description of each actuation method offered to help you select the best solution for your specific application.



Push Buttons

Push buttons take physical force to press and actuate the button.



Touch Buttons

Touch buttons can be actuated with no force, just contact with the surface. The contact can be made with a whole hand, palm or finger.

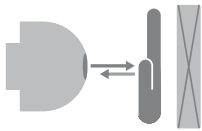

Fixed-Field Mode

Background suppression sensors have a definite limit to their sensing range, ignoring objects that lie beyond their range.

Fixed-field sensors compare the amount of reflected light that is seen by two differently aimed receiver elements. If the light reaching the second receiver element is equal to or greater than the light reaching the first receiver element, then the object will be recognized.

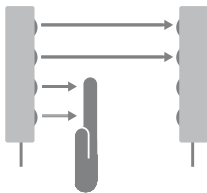

Emitter/Receiver

In opposed-mode sensing, the sensor's emitter and receiver are housed in two separate units. The emitter is placed opposite the receiver, so that the light beam goes directly from the emitter to the receiver.

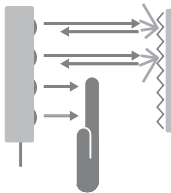

Retroreflective Mode

Retroreflective sensors contain both the emitter and receiver elements. The beam(s) is(are) established between the emitter, the retroreflector and the receiver. An object is sensed when it interrupts or "breaks" the effective beam.

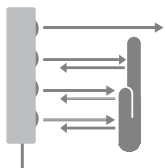

Diffuse

With a diffuse-mode sensor, the object is detected when the object reflects the sensor's transmitted light energy back to the sensor.



S22 Flush-Mount Touch Buttons

- Large, bright illuminated area for clear visibility of input and touch status
- Flush mount design sits tight against panel, machine and bracket surfaces
- Independent color control or preconfigured models to suit your indication needs
- Momentary versions remain activated as long as touch is present, while latching versions toggle between activated and not activated states on successive touches
- Excellent immunity to false triggering by water spray, detergents, oils, and other foreign materials
- Rugged, water-resistant IP69K design for washdown environments
- Ergonomically designed to eliminate hand, wrist and arm stresses, requiring no physical pressure to operate and can be actuated with bare hands or work gloves

RGB Multicolor

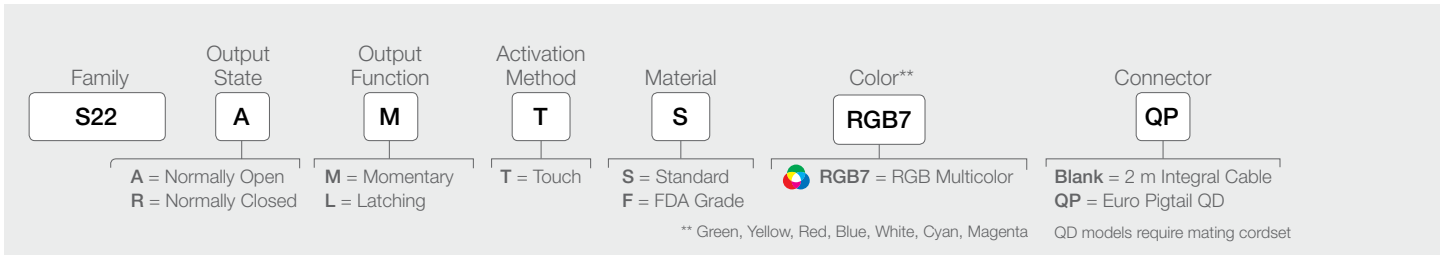

One- or Two-Color/Function

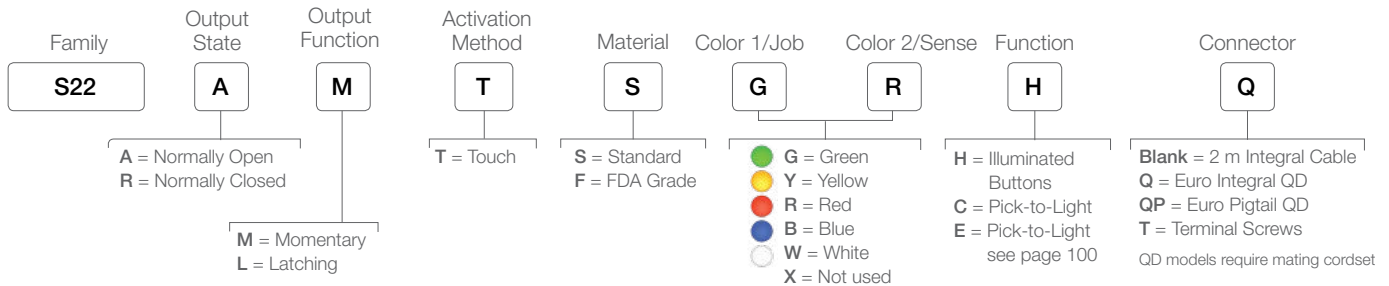

One-, Two-, or Three Color/Function

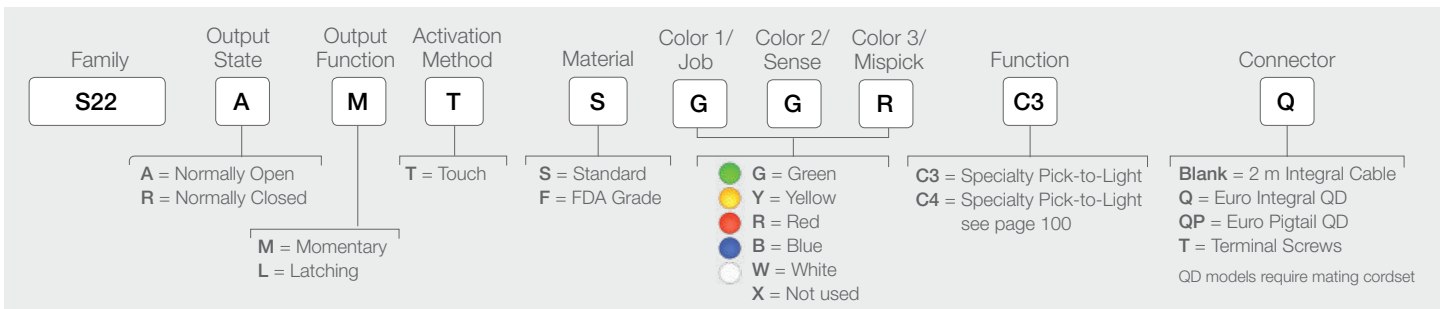

Supply Voltage	10 to 30 V dc
Supply Current	80 mA max current (exclusive of load)
Supply Protection Circuitry	Protected against reverse polarity and transient voltages
Construction	Housing: Polycarbonate or FDA grade plastic, depending on model Translucent dome: Polycarbonate or FDA grade plastic, depending on model Mounting Nut: PBT or FDA grade plastic
Environmental Rating	Standard: UL Type 4x, 13 FDA Grade: UL Type 4x (indoor) Cable, Pigtail, QD models: IEC IP66, IP67, IP69K per DIN 40050-9 on front and back Terminal models: IEC IP66, IP67, IP69K per DIN 40050-9 on front only
Connections	2 m PVC integral cable, integral Euro-style QD 150 mm Euro-style pigtail QD or terminal screws
Operating Conditions	Temperature: -40 to +50 °C Storage Temperature: -40 to +70 °C
Certifications	

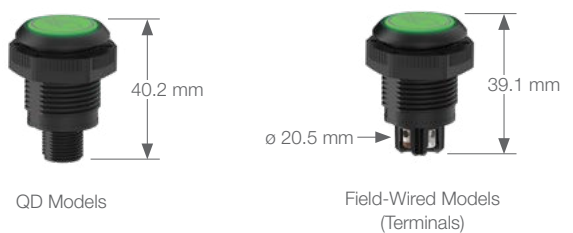

5-Pin Euro-Style
Straight connector models listed; for right-angle models, add RA to the end of model number (example, MQDC1-506RA)

MQDC1-506
2 m (6.5')
MQDC1-515
5 m (15')
MQDC1-530
9 m (30')

5-pin M12 Euro-Style Washdown Cordset
Straight connector models only

MQDC-WDSS-0506
2 m (6.5')
MQDC-WDSS-0515
5 m (15')
MQDC-WDSS-0530
9 m (30')

Additional accessories are available at bannerengineering.com



K30 Illuminated Touch Buttons

- Ergonomic design requires no physical pressure to operate, preventing stress on hands and wrists
- Simple operation with the touch of a finger
- Easily actuated with bare hands or work gloves
- Rugged, fully encapsulated IP69K construction for high-pressure wash-down environments
- Models with either latching or momentary outputs
- 1-, 2-, or 3- color models available to solve a variety of applications

Independent Input/Output Models with up to Three Indicator Colors Controlled by Separate Inputs

The output is activated by touching the device and is totally independent of the indicator inputs.

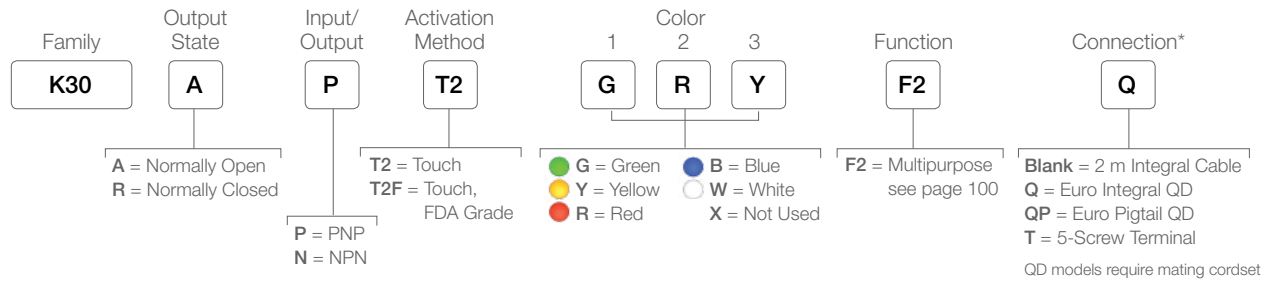

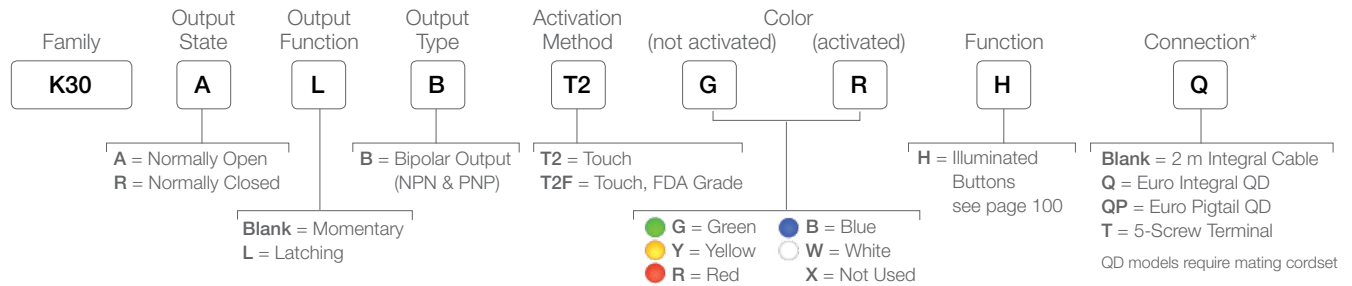

One- or Two-Color Momentary or Latching Bipolar (1 NPN and 1 PNP) Output Models

These models do not have inputs to control the indicator. The color of the indicator is determined by the non-activated or activated condition.



* FDA Grade models only available with pigtail QD

Supply Voltage	12 to 30 V dc
Construction	Housing: Polycarbonate Translucent dome: Polycarbonate Mounting Nut: PBT
Environmental Rating	IEC IP67, IP69K per DIN 40050
Operating Temperature	-40 to +50 °C (-40 to +122 °F)
Certifications	 



Laser Marking Available



4-Pin M12/Euro-Style
Straight connector models listed;
for right-angle models, add RA
to the end of model number
(example, MQDC-406RA)



MQDC-406
2 m (6.5')
MQDC-415
5 m (15')
MQDC-430
9 m (30')

Additional accessories are available at
bannerengineering.com



K50 Illuminated Touch Buttons

- Ergonomic design requires no physical pressure to operate, preventing stress on hands and wrists
- Simple operation with the touch of a finger, hand or whole palm
- Easily actuated with bare hands or work gloves
- Rugged, fully encapsulated IP69K construction for high-pressure wash-down environments
- Models with either latching or momentary outputs
- One-, two- and three-color models available to solve a variety of applications
- Smart electric field sensing on second generation models provides excellent immunity to false triggering from water spray, detergents and other foreign materials
- Second generation models feature superior electrical noise immunity
- Models made with food-grade materials available

Independent Input/Output Models with up to Three Indicator Colors Controlled by Separate Inputs

The output is activated by touching the device and is totally independent of the indicator inputs.

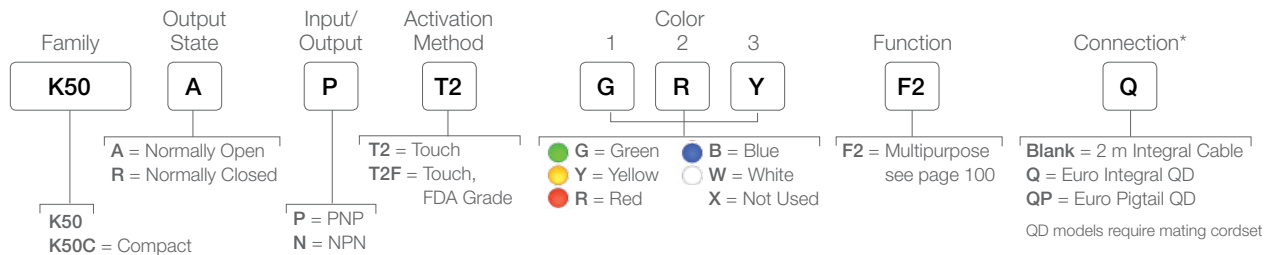

One- or Two-Color Momentary or Latching Bipolar (1 NPN and 1 PNP) Output Models

These models do not have inputs to control the indicator. The color of the indicator is determined by the non-activated or activated condition.

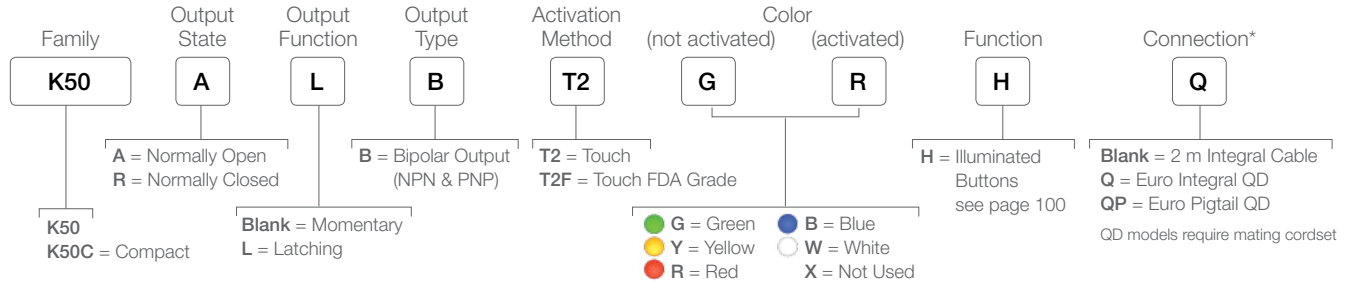

* FDA Grade models only available with pigtail QD

Supply Voltage	12 to 30 V dc
Construction	Housing: Polycarbonate Translucent dome: Polycarbonate Mounting Nut: PBT
Environmental Rating	Standard: UL Type 4x, 13 FDA Grade: UL Type 4x IEC IP67, IP69K per DIN 40050
Operating Temperature	-40 to +50 °C (-40 to +122 °F)
Certifications	



Laser Marking Available



Additional accessories are available at bannerengineering.com

4-Pin M12/Euro-Style

For use with K30 models

Straight connector models listed; for right-angle models, add RA to the end of model number (example, MQDC-406RA)

MQDC-406
2 m (6.5')
MQDC-415
5 m (15')
MQDC-430
9 m (30')

5-Pin M12/ Euro-Style

Straight connector models listed; for right-angle models, add RA to the end of model number (example, MQDC1-506RA)

MQDC1-506
2 m (6.5')
MQDC1-515
5 m (15')
MQDC1-530
9 m (30')

8-Pin M12/Euro-Style

For use with 3 color F2 models.

Straight connector models listed; for right-angle models, add RA to the end of model number (example, MQDC2S-806RA)

MQDC2S-806
2 m (6.5')
MQDC2S-815
5 m (15')
MQDC2S-830
9 m (30')



K70 Illuminated Touch Button

- Excellent immunity to false triggering by water spray, detergents, oils, and other foreign materials
- Ergonomically designed to eliminate hand, wrist, and arm stresses associated with repeated switch operation; require no physical force to operate
- Can be actuated with bare hands or work gloves
- Rugged IP65 polycarbonate construction
- Momentary versions remain activated as long as touch is present
- Latching versions start up not activated and toggle between activated and not activated on successive touches
- Available in five color options and one-, two- and three-color models
- Wireless models simplify installation and provide a simple operator interface for pick-to-light, call button and general industrial applications

Independent Input/Output Models with up to Three Indicator Colors Controlled by Separate Inputs

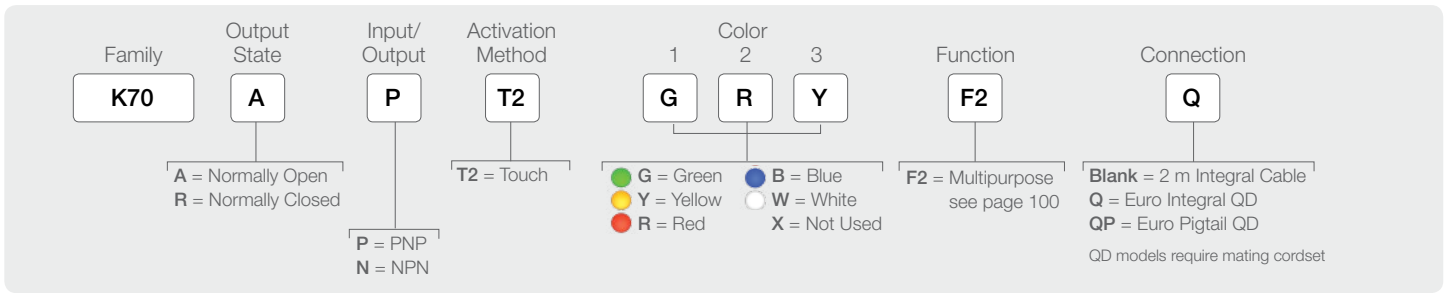

One- or Two-Color Momentary or Latching Bipolar (1 NPN and 1 PNP) Output Models

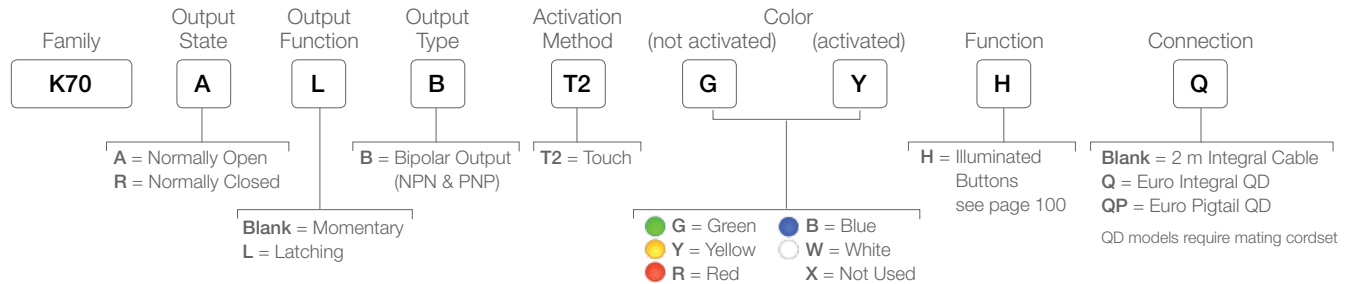

Wireless

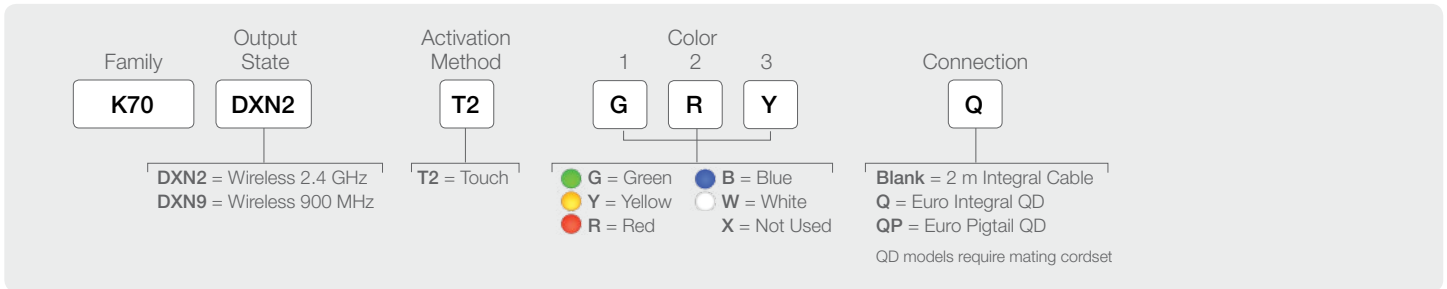

Supply Voltage and Current

12 V to 30 V dc; 220 mA Max. at 12 V dc;
110 mA Max. at 30 V dc

Supply Protection Circuitry

Protected against transient voltages

Construction

Housing: Polycarbonate
Dome: Polycarbonate

Environmental Rating

IEC IP65

Operating Temperature

-40 to 50 °C

Certifications



Laser
Marking
Available



SMB30A



SMB30MM



SMBAMS30P



SSA-MBK-EEC1



5-Pin M12/Euro-Style

Straight connector models listed; for right-angle models, add RA to the end of model number (example, MQDC1-506RA)

MQDC1-506
2 m (6.5')
MQDC1-515
5 m (15')
MQDC1-530
9 m (30')

Additional accessories are available at
bannerengineering.com



K50L and K30L Illuminated Push Buttons

- Three sourcing inputs control the green, yellow and red indicator lights
- Ideal for use in abusive environments, featuring rugged, fully encapsulated construction
- Cabled and Euro Quick Disconnect models available
- Available in momentary push button output

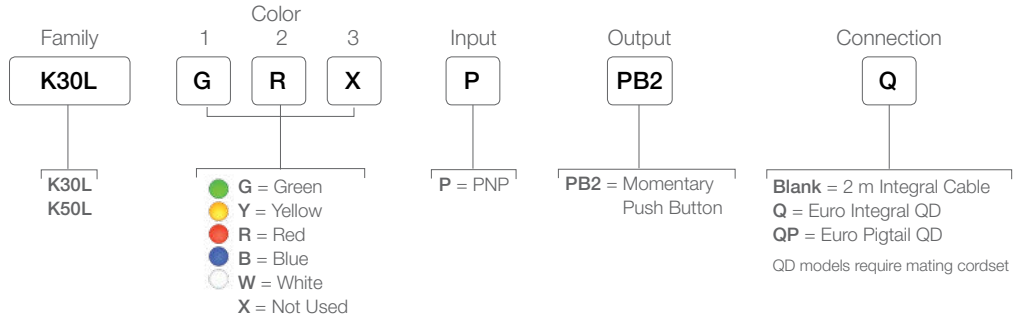

Supply Voltage

K30L: 10 to 30 V dc
K50L: 12 to 30 V dc

Construction

Base: Polycarbonate
Translucent dome: Polycarbonate
Push button: Thermoplastic

Environmental Rating

IEC IP65

Operating Temperature

-40 to +50 °C (-40 to +122 °F)

Certifications



K30 Push Models

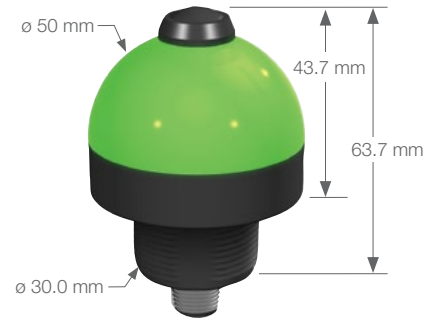

K50 Push Models



SMBCK30
use with K30L
on 28 mm pipe



SMB22A
use with K30L



SMB30A
use with K50L

Additional accessories are available at bannerengineering.com



4-Pin M12/Euro-Style

For use with K30 models

Straight connector models listed;
for right-angle models, add RA
to the end of model number
(example, MQDC-406RA)

MQDC-406
2 m (6.5')
MQDC-415
5 m (15')
MQDC-430
9 m (30')

5-Pin M12/ Euro-Style

Straight connector models listed;
for right-angle models, add RA
to the end of model number
(example, MQDC1-506RA)

MQDC1-506
2 m (6.5')
MQDC1-515
5 m (15')
MQDC1-530
9 m (30')

8-Pin M12/Euro-Style

For use with 3 color F2 models.

Straight connector models listed;
for right-angle models, add RA
to the end of model number
(example, MQDC2S-806RA)

MQDC2S-806
2 m (6.5')
MQDC2S-815
5 m (15')
MQDC2S-830
9 m (30')



OTB Optical Touch Buttons

- OPTO-TOUCH Optical Touch Buttons are zero-force ergonomic replacements for mechanical push buttons.
- OTB models are momentary-action touch buttons with electromechanical relay or solid-state outputs.

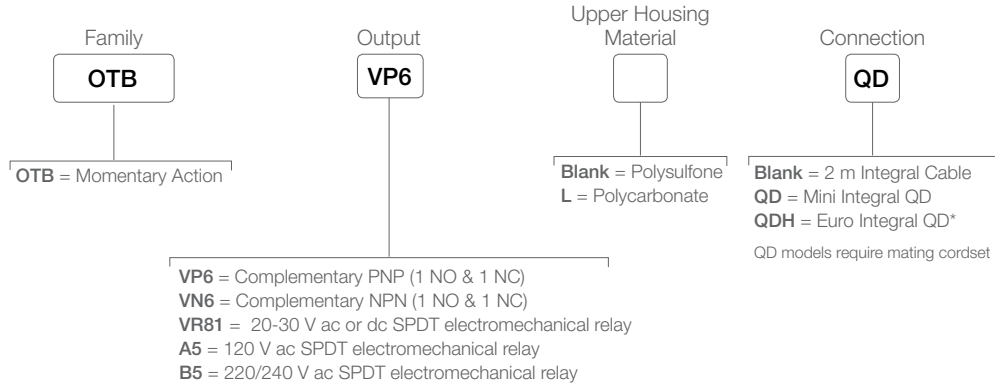

* Only available for OTBV6P or OTBV6N models

Supply Voltage	Models for 105 to 130 V ac, 210 to 250 V ac (50/60 Hz), 10 to 30 V dc, or 20 to 30 V ac/dc
Construction	Upper Housing: Black polysulfone or Polycarbonate Base: Fiber-reinforced PBT
Environmental Rating	IEC IP66 NEMA 1, 3, 4X, 12 and 13
Operating Temperature	-20 to +50°C (-4 to +122°F)
Certifications	CE, SP, cULUS



SMB30A

SMB30MM

SMB30SC

Optional Field Covers



- Black OTC-1-BK
- Green OTC-1-GN
- Red OTC-1-RD
- Yellow OTC-1-YW



- Black OTCL-1-BK
- Green OTCL-1-GN
- Red OTCL-1-RD
- Yellow OTCL-1-YW

Additional accessories are available at bannerengineering.com

4-Pin M12/
Euro-Style

Straight connector models listed; for right-angle models, add RA to the end of model number (example, MQDC-406RA)



- MQDC-406
2 m (6.5')
- MQDC-415
5 m (15')
- MQDC-430
9 m (30')

4-Pin Mini-Style



- MBCC-406
1.83 m (6')
- MBCC-412
3.66 m (12')
- MBCC-430
9.14 m (30')

5-Pin Mini-Style

- MBCC-506
1.83 m (6')
- MBCC-512
3.66 m (12')
- MBCC-530
9.14 m (30')



VTB Verification Touch Buttons

- Replaces capacitive touch switches and mechanical push buttons
- Features illuminated base (to provide a bright, easy-to-see job light) solid, flashing or multiple color models available
- Offers choice of models with red, green or blue job light
- Require no physical pressure to operate, eliminating hand, wrist and arm stresses associated with repeated switch operation
- Offers a cost-effective and easy-to-install pick-to-light solution for areas that cannot accommodate a light screen
- Cuts through heavy airborne contamination to function in almost any environment
- Withstands exposure to a variety of chemicals, depending on model

One-Color Illuminated Base Models

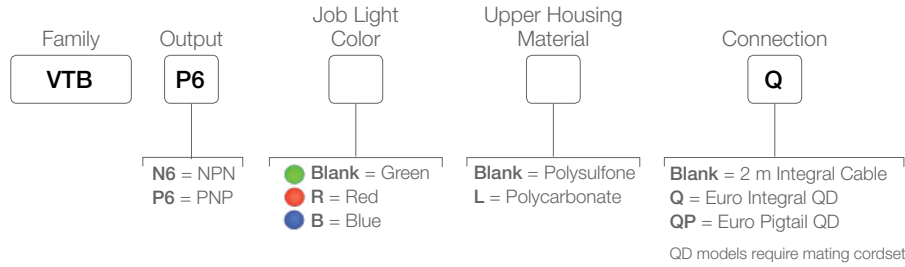

Two-Color Illuminated Base Models

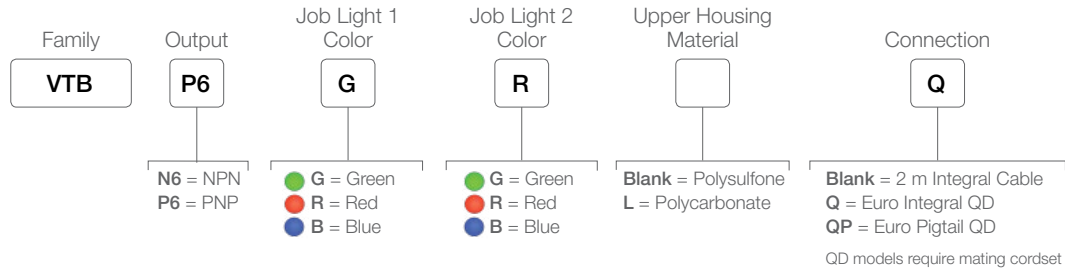

Supply Voltage	12 to 30 V dc
Construction	Upper Housing: Polysulfone or polycarbonate Base: White polycarbonate
Environmental Rating	IP66
Operating Temperature	-20 to +50 °C (-4 to +122 °F)
Certifications	



SMB30MM SMB30FA SMB30SC SMBAMS30RA

4-Pin M12/Euro-Style
For use with K30 models

Straight connector models listed;
for right-angle models, add RA
to the end of model number
(example, MQDC-406RA)

- MQDC-406
2 m (6.5')
- MQDC-415
5 m (15')
- MQDC-430
9 m (30')

5-Pin M12/ Euro-Style
Straight connector models listed;
for right-angle models, add RA
to the end of model number
(example, MQDC1-506RA)

- MQDC1-506
2 m (6.5')
- MQDC1-515
5 m (15')
- MQDC1-530
9 m (30')

Optional Field Covers

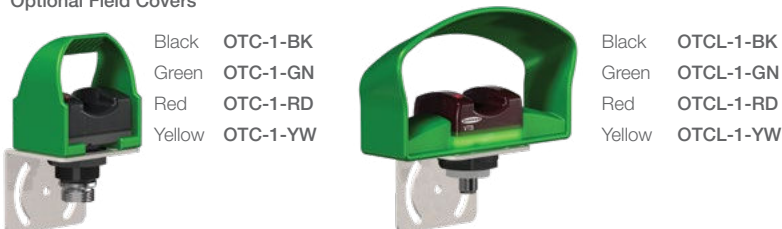

Additional accessories are available at
bannerengineering.com





30 mm Mount Illuminated E-Stops

- Available with two-color: yellow and red, one color: red
- Reduces intensive labor costs with a fully enclosed E-Stop button ready for installation
- Multiple buttons can be wired in series, with built-in logic allowing for clear indication of pushed button
- Latching design complies with ISO 13850 direct (positive) opening operation per IEC 60947-5-1
- Rugged design rated to IP65
- Available with illuminated Safety BUS Gateway compatibility

Model*	Description	Illumination	Model*	Description	Illumination
SSA-EB1PLYR-12ECQ8	2NC / 1NO (PNP)	YEL/RED-Flash/Solid	SSA-EB1PLYR-02ECQ5B	2NC – Safety BUS node compatible	YEL/RED-Flash
SSA-EB1PLGR-12ECQ8	2NC / 1NO (PNP)	GREEN/RED-Flash/Solid	SSA-EB1PLXR-02ECQ5A	2NC – Safety BUS node compatible	OFF/RED-Flash
SSA-EB1PLXR-12ECQ8	2NC / 1NO (PNP)	OFF/RED-Flash/Solid	SSA-EB1PLXR-02ECQ5B	2NC – Safety BUS node compatible	OFF/RED-Flash
SSA-EB1PL-12ECQ8	2NC / 1NO (PNP)	OFF/RED-Solid/Solid	SSA-EB1PL-02ECQ5A	2NC – Safety BUS node compatible	OFF/RED-Solid
SSA-EB1PLYR-02ECQ5A	2NC – Safety BUS node compatible	YEL/RED-Flash	SSA-EB1PL-02ECQ5B	2NC – Safety BUS node compatible	OFF/RED-Solid

* Washdown cover can be ordered separately or ad -WC to the end of the model number

Supply Voltage	12 to 30 V dc
Construction	Upper Housing: Polycarbonate/Polymide Base: White polycarbonate
Environmental Rating	IP65, IP69K with cover
Operating Temperature	Temperature: -25 to +55 °C (-13 to +131 °F) Humidity: 45% to 85% RH (no condensation)
Certifications	 



CSS Series Hookup Cordset Solution

This interconnection solution allows for quick hookup of a series string of emergency stop buttons. The user must ensure that the CSS series hookup cordsets are installed so that they cannot be easily defeated by not allowing access to the QD connectors or allowing improper connection bypassing the function of the Emergency Stop.

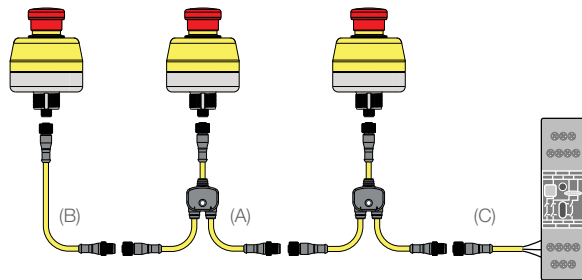

SSA-MBK-EEC1



SSA-MBK-EEC2



SSA-MBK-EEC3

Cordsets available on page 119



Flush-Mount Illuminated E-Stop Buttons

- Available with two-color: yellow (or green) and red or one color: red
- Rugged design rated to IP65
- Available with illuminated Safety BUS Gateway compatibility
- Latching design complies with ISO 13850 direct (positive) opening operation per IEC 60947-5-1
- Safe Break Action ensures NC contacts will open if the contact block is separated from the actuator
- Multiple buttons can be interfaced and series connected with CSS Series Hookup Cordsets
- Compliant with ANSI B11.19, ANSI NFPA79, and IEC/EN 60204-1 Emergency Stop requirements

Illuminated Flush-mount E-Stop Push-Buttons

Model	Description	Illumination
SSA-EB1PLYR-12ED1Q8	2NC / 1NO (PNP)	YEL/RED-Flash/Solid
SSA-EB1PLGR-12ED1Q8	2NC / 1NO (PNP)	GREEN/RED-Flash/Solid
SSA-EB1PLXR-12ED1Q8	2NC / 1NO (PNP)	OFF/RED-Flash/Solid
SSA-EB1PL-12ED1Q8	2NC / 1NO (PNP)	OFF/RED-Solid/Solid
SSA-EB1PLYR-02ED1Q5A	2NC – Safety BUS node compatible	YEL/RED-Flash

Model	Description	Illumination
SSA-EB1PLYR-02ED1Q5B	2NC – Safety BUS node compatible	YEL/RED-Flash
SSA-EB1PLXR-02ED1Q5A	2NC – Safety BUS node compatible	OFF/RED-Flash
SSA-EB1PLXR-02ED1Q5B	2NC – Safety BUS node compatible	OFF/RED-Flash
SSA-EB1PL-02ED1Q5A	2NC – Safety BUS node compatible	OFF/RED-Solid
SSA-EB1PL-02ED1Q5B	2NC – Safety BUS node compatible	OFF/RED-Solid

Lockable Illuminated Flush-mount E-Stop Push-Buttons

Model	Description	Illumination
SSA-EB1MLYRP-12ED1Q8	2NC / 1NO (PNP)	YEL/RED-Flash/Solid
SSA-EB1MLGRP-12ED1Q8	2NC / 1NO (PNP)	GREEN/RED-Flash/Solid

Model	Description	Illumination
SSA-EB1MLXRP-12ED1Q8	2NC / 1NO (PNP)	OFF/RED-Flash/Solid
SSA-EB1MLP-12ED1Q8	2NC / 1NO (PNP)	OFF/RED-Solid/Solid

E-stops can be cascaded.
See diagram on page 117.

Supply Voltage	12 to 30 V dc
Construction	Upper Housing: Polycarbonate/Polymide Base: White polycarbonate
Environmental Rating	IP65
Operating Temperature	Temperature: -25 to +55 °C (-13 to +131 °F) Humidity: 45% to 85% RH (no condensation)
Certifications	

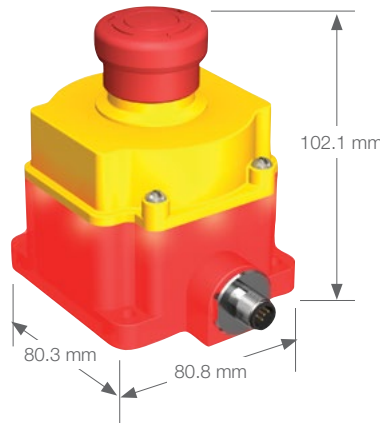

Illuminated Flush-mount Model

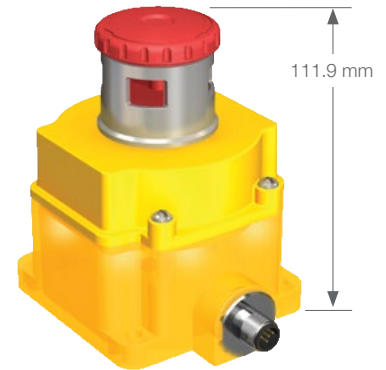

Lockable Illuminated Flush-mount Model

4-Pin M12/
Euro-Style
Straight connector
models listed



MQDC-406
2 m (6.5')
MQDC-415
5 m (15')
MQDC-430
9 m (30')

5-Pin Double-Ended
Euro-Style
(Male/Female)



DEE2R-51D 0.31 m (1')	DEE2R-525D 7.62 m (25')
DEE2R-53D 0.91 m (3')	DEE2R-550D 15.2 m (50')
DEE2R-58D 2.44 m (8')	DEE2R-575D 22.9 m (75')
DEE2R-515D 4.57 m (15')	DEE2R-5100D 30.5 m (100')

8-Pin M12/
Euro-Style
Straight connector
models listed



MQDC2S-806
2 m (6.5')
MQDC2S-815
5 m (15')
MQDC2S-830
9 m (30')

8-Pin Double-Ended
Euro-Style
(Male/Female)

DEE2R-81D 0.31 m (1')	DEE2R-825D 7.62 m (25')
DEE2R-83D 0.91 m (3')	DEE2R-850D 15.2 m (50')
DEE2R-88D 2.44 m (8')	DEE2R-875D 22.9 m (75')
DEE2R-815D 4.57 m (15')	DEE2R-8100D 30.5 m (100')

4-Pin M12
Euro-Style Splitter
(Female/Male/Female)



CSS-M12F41M12M41M12F41

8-Pin M12
Euro-Style Splitter
(Female/Male/Female)

CSS-M12F81M12M81M12F81



K30 Pick-to-Light Touch Buttons

- Ergonomic design requires no physical pressure to operate, preventing stress on hands and wrists
- Simple operation with the touch of a finger; easily actuated with bare hands or work gloves
- Rugged, fully encapsulated IP69K construction for high-pressure wash-down environments; Models with food grade materials available
- Models with either latching or momentary outputs
- Ideal for pick-to-light and call button applications in a variety of industries
- One-, two-, or three-color models available to solve a variety of applications
- Smart electric field sensing provides excellent immunity to false triggering from water spray, detergents and other foreign materials
- Superior electrical noise immunity

Independent Input/Output Models with up to Three Indicator Colors Controlled by Separate Inputs

The output is activated by touching the device and is totally independent of the indicator inputs.

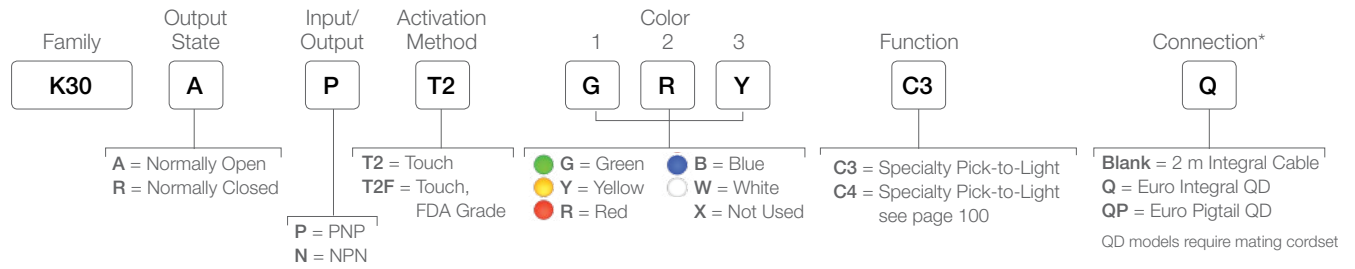

One- or Two-Color Momentary or Latching Bipolar (1 NPN and 1 PNP) Output Models

These models do not have inputs to control the indicator. The color of the indicator is determined by the non-activated or activated condition.

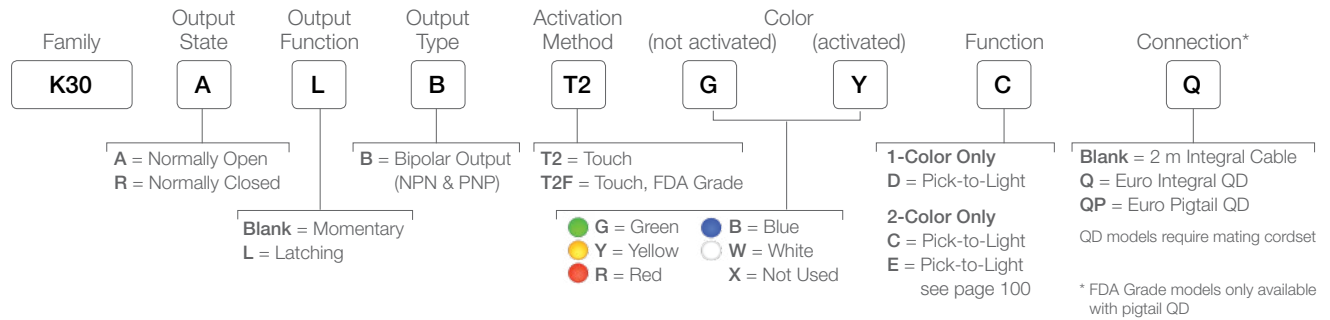

Supply Voltage	12 to 30 V dc
Construction	Housing: Polycarbonate Translucent dome: Polycarbonate Mounting Nut: PBT
Environmental Rating	IEC IP67, IP69K per DIN 40050
Operating Temperature	-40 to +50 °C (-40 to +122 °F)
Certifications	



Laser Marking Available



4-Pin M12/Euro-Style
Straight connector models listed; for right-angle models, add RA to the end of model number (example, MQDC-406RA)

MQDC-406
2 m (6.5')
MQDC-415
5 m (15')
MQDC-430
9 m (30')

Additional accessories are available at bannerengineering.com



K50 Pick-to-Light Touch Buttons

- Ergonomic design requires no physical pressure to operate, preventing stress on hands and wrists
- Simple operation with the touch of a finger, hand or whole palm
- Easily actuated with bare hands or work gloves
- Rugged, fully encapsulated IP69K construction for high-pressure wash-down environments
- Models with either latching or momentary outputs
- Ideal for pick-to-light and call button applications in a variety of industries
- One-, two- and three-color models available to solve a variety of applications

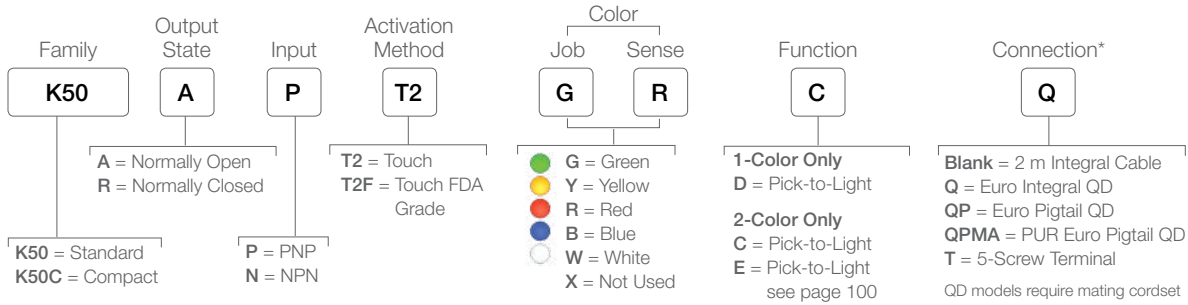

One- or Two-Color

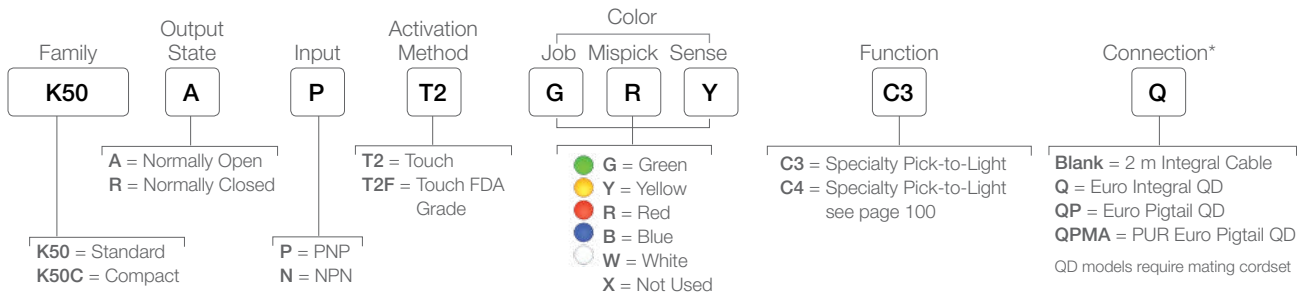

Three-Color



* FDA Grade models only available with pigtail QD

Supply Voltage	12 to 30 V dc
Construction	Housing: Polycarbonate Translucent dome: Polycarbonate Mounting Nut: PBT
Environmental Rating	Standard: UL Type 4x, 13 FDA Grade: UL Type 4x IEC IP67, IP69K per DIN 40050
Operating Temperature	-40 to +50 °C (-40 to +122 °F)
Certifications	 



Additional accessories are available at bannerengineering.com

4-Pin M12/Euro-Style

For use with K30 models
Straight connector models listed;
for right-angle models, add RA
to the end of model number
(example, MQDC-406RA)

- MQDC-406
2 m (6.5')
- MQDC-415
5 m (15')
- MQDC-430
9 m (30')

5-Pin M12/ Euro-Style

Straight connector models listed;
for right-angle models, add RA
to the end of model number
(example, MQDC1-506RA)

- MQDC1-506
2 m (6.5')
- MQDC1-515
5 m (15')
- MQDC1-530
9 m (30')

8-Pin M12/Euro-Style

For use with 3 color F2 models.
Straight connector models listed;
for right-angle models, add RA
to the end of model number
(example, MQDC2S-806RA)

- MQDC2S-806
2 m (6.5')
- MQDC2S-815
5 m (15')
- MQDC2S-830
9 m (30')



K70 Illuminated Pick-to-Light Touch Button

- Excellent immunity to false triggering by water spray, detergents, oils, and other foreign materials
- Ergonomically designed to eliminate hand, wrist, and arm stresses associated with repeated switch operation; requires no physical force to operate
- Can be actuated with bare hands or work gloves
- Rugged IP65 polycarbonate construction
- Momentary versions remain activated as long as touch is present
- Latching versions start up not activated and toggle between activated and not activated on successive touches
- One-, two- and three-color models available

Pick-To-Light

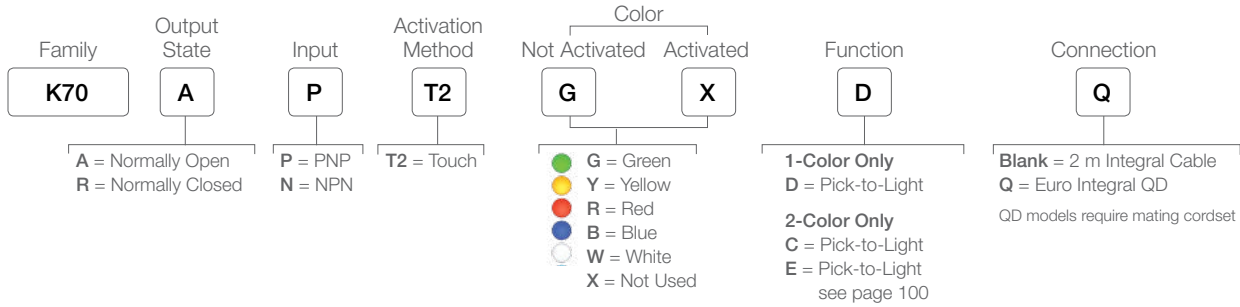

Specialty Models

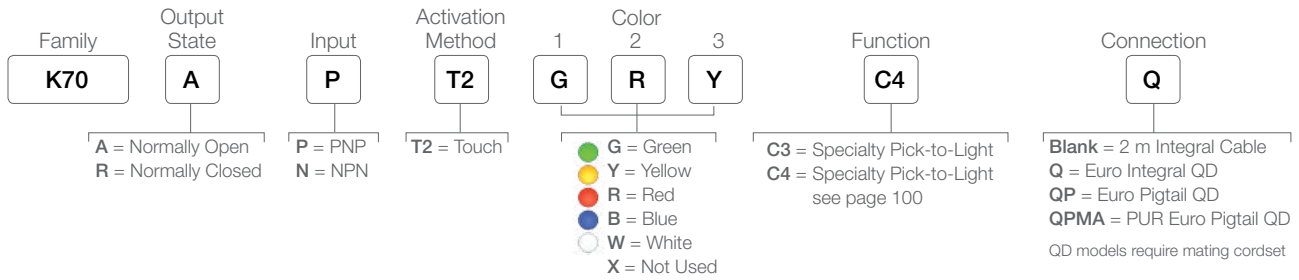

Supply Voltage and Current

12 V to 30 V dc; 220 mA Max. at 12 V dc;
110 mA Max. at 30 V dc

Supply Protection Circuitry

Protected against transient voltages

Construction

Housing: Polycarbonate
Dome: Polycarbonate

Environmental Rating

IEC IP65

Operating Temperature

-40 to 50 °C

Certifications



Laser
Marking
Available



SMB30A



SMB30MM



SMBAMS30P



SSA-MBK-EEC1



5-Pin M12/Euro-Style

Straight connector models listed; for right-angle models, add RA to the end of model number (example, MQDC1-506RA)

MQDC1-506
2 m (6.5')
MQDC1-515
5 m (15')
MQDC1-530
9 m (30')

Additional accessories are available at bannerengineering.com



K50 Optical Pick-to-Light Series

- Rugged, cost-effective and easy-to-install solutions for error-proofing and parts-verification applications
- Illuminated dome provides easy-to-see job light status
- Choose either polarized retro-reflective or fixed-field models
- Fully encapsulated IP67 construction

One- or Two-Color Models



Three-Color Models



Sensing Range	Polarized Retroreflective: 2.0 m Fixed-field: 50 mm or 100 mm
Supply Voltage	12 to 30 V dc
Construction	Housing: Polycarbonate Translucent dome: Polycarbonate Mounting Nut: PBT
Environmental Rating	IEC IP67, IP69K per DIN 40050
Operating Temperature	-40 to +50 °C (-40 to +122 °F)
Certifications	CE  Some models pending. Contact factory for additional information.

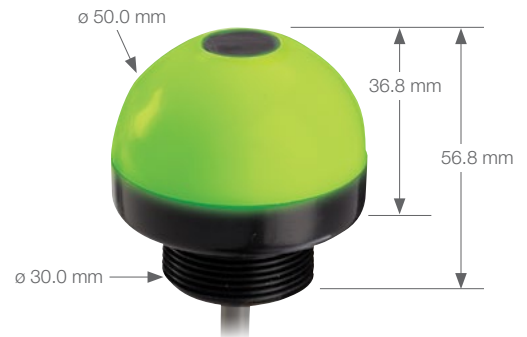

SMB30A

SMB30FA

SMB30RAVK

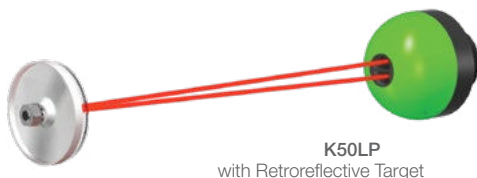

K50LP
with Retroreflective Target

**5-Pin M12/
Euro-Style**
Straight connector models listed;
for right-angle models, add RA
to the end of model number
(example, MQDC1-506RA)



MQDC1-506
2 m (6.5')
MQDC1-515
5 m (15')
MQDC1-530
9 m (30')



Retroreflective Targets
BRT-2X2
BRT-35X35B
BRT-51X51BM
BRT-50D
BRT-100X18A

Retroreflective Tape
BRT-THG-1-100
BRT-THG-2-100
BRT-THG-3-100
BRT-TVHG-2X2

Additional accessories are available at
bannerengineering.com



K50 Modbus Pick-to-Light Series

- Rugged, cost-effective and easy-to-install solutions for error-proofing and parts-verification applications
- Illuminated dome provides easy-to-see job light status
- Choose either polarized retroreflective or fixed-field models
- Fully encapsulated IP67 construction
- User can customize or select standard function configurations
- Modbus communication minimizes the cabling and system programming requirements

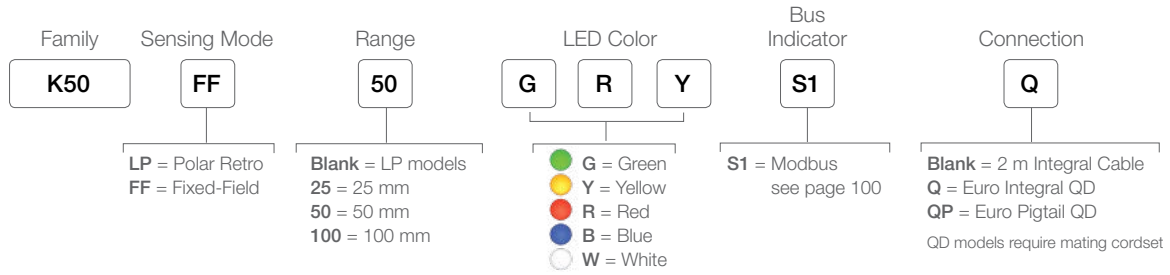

Sensing Range	Polarized Retroreflective: 2.0 m Fixed-field: 50 mm or 100 mm
Supply Voltage	12 to 30 V dc
Construction	Housing: Polycarbonate Translucent dome: Polycarbonate Mounting Nut: PBT
Environmental Rating	IEC IP67
Operating Temperature	-40 to +50 °C (-40 to +122 °F)
Certifications	CE

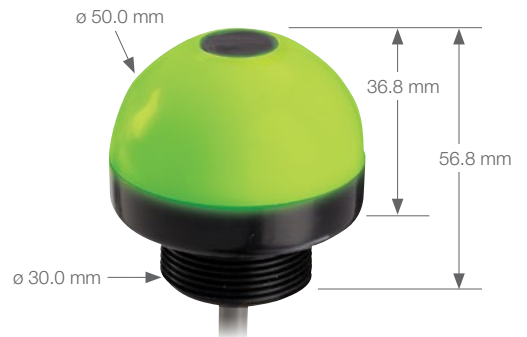



K30/K50/K80 Push Button Pick-to-Light Series

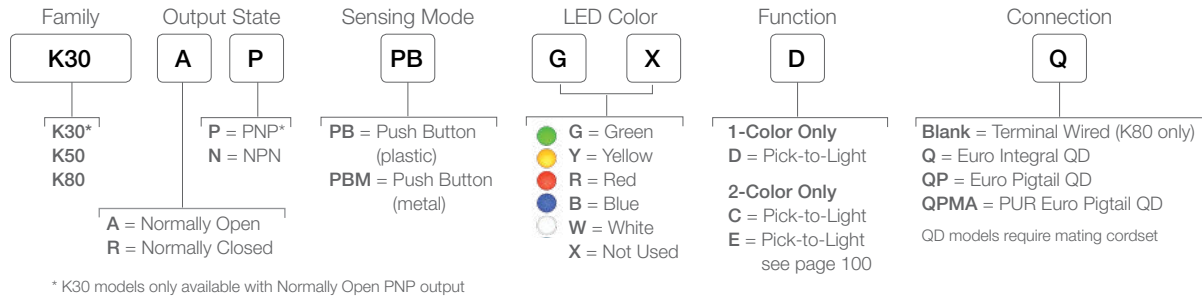

- Illuminated dome provides an easy-to-see green job light some models also light red for alternate operation
- Up to three independent colors in one unit
- Waterproof IP65 construction for wet environments
- Immune to EMI and RFI interference
- 12 to 30 V dc operation
- Cabled and Quick Disconnect models available

One- or Two-Color

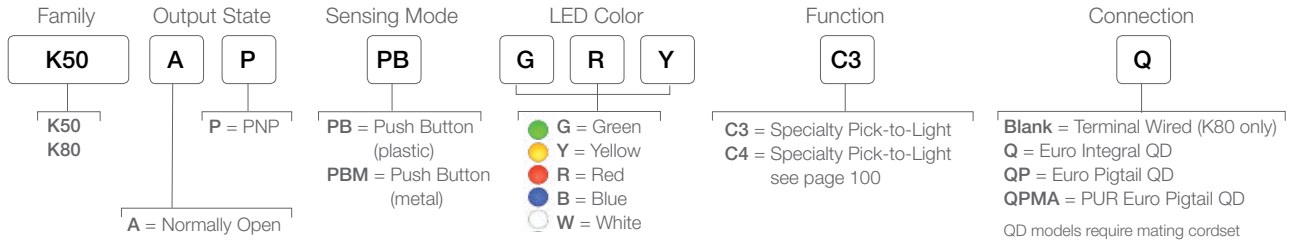

Three-Color



Supply Voltage	12 to 30 V dc
Construction	Base and Translucent Dome: Polycarbonate Push Button: Thermoplastic or Stainless Steel
Environmental Rating	K30: IP65 Other models: IP67
Operating Temperature	-40 to +50 °C (-40 to +122 °F)
Certifications	 

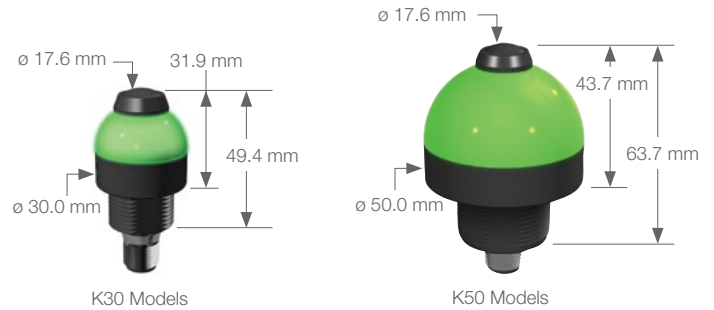



PVD Diffuse/Retroreflective Parts Verification Array

- One-component system, easy to mount and even easier to use. Automatically operates in either diffuse or retroreflective mode, depending on the application
- Automatic setup and adjustment; wide beam pattern provides easy alignment
- Range up to 2 m (6.5 ft) when used with retroreflective target; 400 mm (15.7 in) when used in diffuse mode
- Large job lights on either side of the metal housing can be remotely controlled to initiate user action with a solid or a blinking green light; job lights turn red to indicate bin-picking errors
- Compact package size; only 30 mm wide x 15 mm deep (1.2 in x 0.6 in)
- Available in 2 lengths to fit existing parts bin sizes and configurations
- Heavy-duty protective brackets available

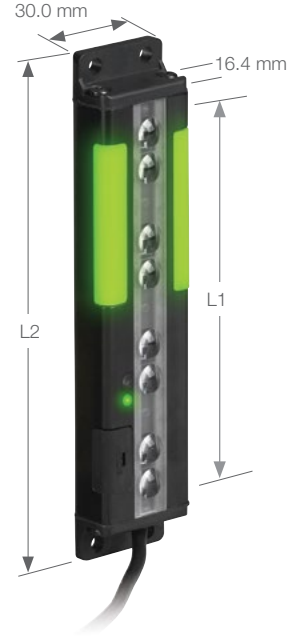
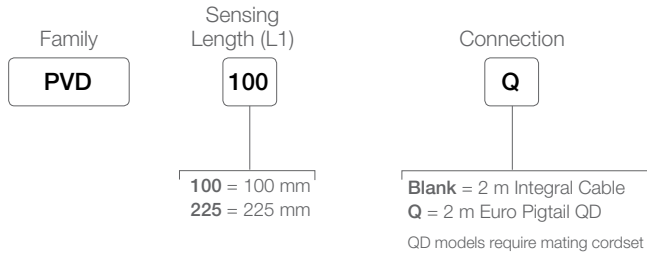

Sensing Range	Retroreflective: 2 m Diffuse: 400 mm
Supply Voltage	12 to 30 V dc
Construction	Housing: Black painted aluminum Lenses: Acrylic End Caps: Thermoplastic Switch Cover: Thermoplastic
Environmental Rating	NEMA 2; IEC IP62
Operating Temperature	0 to +50 °C (+32 to 122 °F)
Certifications	

Models	No. of Beams	Sensing Length (L1)	Overall Length (L2)
PVD100	4	100 mm	137.8 mm
PVD225	8	225 mm	266.4 mm



4-Pin M12/Euro-Style
 For use with K30 models
 Straight connector models listed;
 for right-angle models, add RA
 to the end of model number
 (example, MQDC-406RA)

5-Pin M12/ Euro-Style
 Straight connector models listed;
 for right-angle models, add RA
 to the end of model number
 (example, MQDC1-506RA)



MQDC-406	2 m (6.5')
MQDC-415	5 m (15')
MQDC-430	9 m (30')
MQDC1-506	2 m (6.5')
MQDC1-515	5 m (15')
MQDC1-530	9 m (30')

Additional accessories are available at bannerengineering.com



PVL Retroreflective Parts Verification Array

- Cost-effective coverage with the highest reliability
- Opto-mechanical alignment with bright red emitter beams allows for easy setup
- Easy installation with no assembly required
- Can mount directly to racking profile vertically or horizontally
- Rugged, metal compact housing for high durability
- Highly visible, two-color integrated job LED arrows for confirmation of correct pick or indication of mis-pick
- Retroreflective tape can be placed on adjacent unit or one of the brackets for reduced installation costs
- Large mounting holes for securing directly to slotted racking systems
- Slotted housing design allows cable to exit on either end

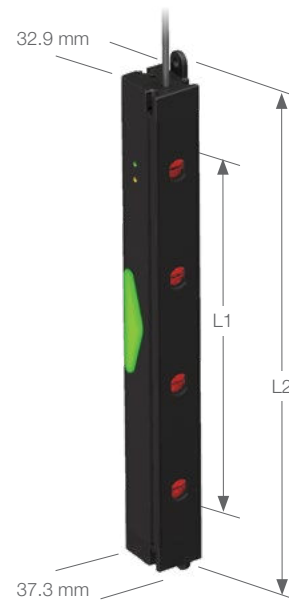
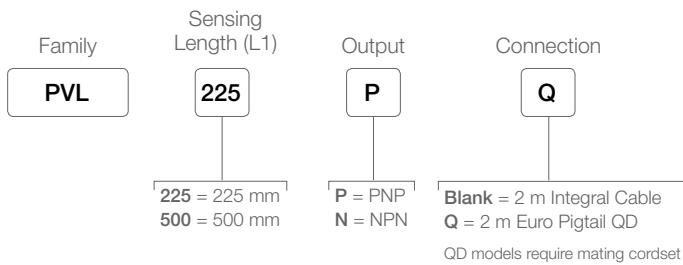

Sensing Range	Retroreflective: 1.5 m
Supply Voltage	12 to 30 V dc
Construction	Housing: aluminum anodized Translucent Indicator: polycarbonate
Environmental Rating	IP50
Operating Temperature	0 to +50 °C (+32 to 122 °F)
Certifications	CE

Models	No. of Beams	Sensing Length (L1)	Hole-to-Hole Length (L2)
PVL225	4	225 mm	327.5 mm
PVL500	8	500 mm	608.0 mm

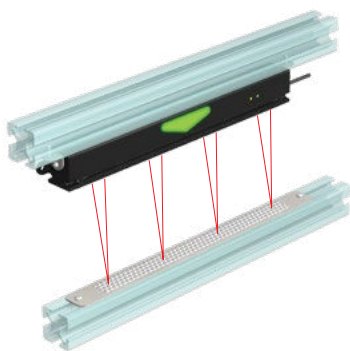

SMBPVL1 and SMBPVL2-225 or -500



SMBPVL4 and SMBPVL3-225 or -500 for use on 28 mm pipe



4-Pin M12/Euro-Style
 Straight connector models listed; for right-angle models, add RA to the end of the model number (example, MQDC-406RA)

- MQDC-406 2 m (6.5')
- MQDC-415 5 m (15')
- MQDC-430 9 m (30')



BRT-THG-1-100
 Replacement retroreflective tape
BRT-84X84A
 Long Range Reflectors

Additional accessories are available at bannerengineering.com



PVA Opposed-Mode Parts Verification Array

- Compact package, available in 4 lengths to fit many sizes and configurations of existing parts bins
- Range up to 2 m (6.5 ft)
- Two-component system (asynchronous emitter and receiver) needs no sync wire or controller box.
- Clearly visible green job indicator lights mounted on either side of emitter and receiver housings; the light can be remotely controlled to initiate user action with a solid ON or blinking condition
- Two frequency settings to prevent crosstalk in close-proximity, multiple-array installations
- Heavy-duty protective brackets available

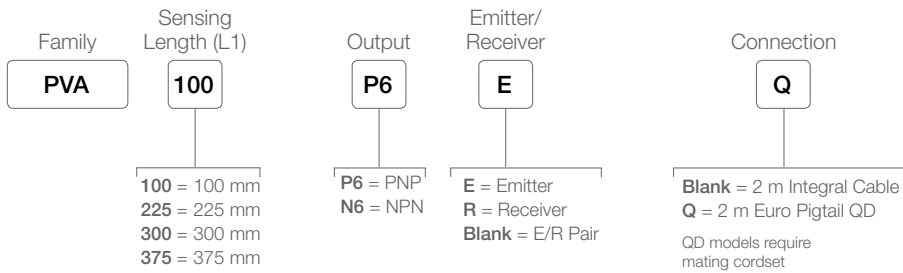

Sensing Range	2 m
Supply Voltage	12 to 30 V dc
Construction	Housing: Black painted aluminum Lenses: Acrylic End Caps: PBT Switch Cover: Thermoplastic
Environmental Rating	NEMA 2; IEC IP62
Operating Temperature	0 to +50 °C (+32 to 122 °F)
Certifications	

Models	No. of Beams	Sensing Length (L1)	Overall Length (L2)
PVA100	5	100 mm	137.8 mm
PVA225	10	225 mm	266.4 mm
PVA300	13	300 mm	341.4 mm
PVA375	16	375 mm	416.6 mm



SMBPVA1
pair included with the PVA

SMBPVA2
for use on 28 mm pipe

SMBPVA6
for use on 28 mm pipe

SMBPVA5
Protective Bracket



4-Pin M12/Euro-Style
Straight connector models listed; for right-angle, add RA to the end of the model number (example, MQDC-406RA)

- MQDC-406**
2 m (6.5')
- MQDC-415**
5 m (15')
- MQDC-430**
9 m (30')

Additional accessories are available at bannerengineering.com

Legacy Products



T30 and T18 T-Style Indicators

- Rugged, cost-effective and easy-to-install indicators
- Easy-to-see operator guidance and indication of equipment status
- Compact devices are completely self-contained — no controller needed
- Displays up to three colors
- Immune to EMI and RFI interference



K80 Call Light Battery Powered Flashing Indicators

- Illuminated dome provides easy-to-see call-for-assistance indication
- Powered by two 9 V alkaline batteries: lasts up to 100 hours with continuous operation
- Flashes ON/OFF
- Switch activated
- No assembly required
- Rugged, cost-effective and easy-to-install



TL30F Linear Segmented Indicators

- Illuminated tower light segments provide easy-to-see operator guidance and indication of equipment status
- Displays up to 5 colors
- Durable flat metal housing is easily mounted on horizontal or vertical surfaces of work centers or automation machinery
- Energy efficient LED light sources ensure long operating life with no maintenance
- Compact devices are completely self-contained — no controller needed, no assembly required
- Immune to ambient light, EMI and RFI interference



T8L T-Style Indicators

- Rugged, cost-effective and easy-to-install indicators
- Easy-to-see operator guidance and indication of equipment status
- Compact devices are completely self-contained — no controller needed
- Displays two colors
- Immune to EMI and RFI interference



M18 Metal Barrel Indicators

- Rugged, cost-effective and easy-to-install indicators
- Easy-to-see operator guidance and indication of equipment status
- Compact devices are completely self-contained — no controller needed
- Displays up to three colors
- Immune to EMI and RFI interference



K80L Flat-Mount Domed Indicators

- Rugged, cost-effective and easy-to-install indicators
- Illuminated dome provides easy-to-see operator guidance and indication of equipment status
- Compact devices are completely self-contained — no controller needed
- 18 to 30 V dc operation 85 to 130V ac operation
- Displays up to three colors
- Immune to EMI and RFI interference



LTB Optical Touch Button

- Optimized for easy mounting with 30 mm threaded base
- Ergonomic design eliminates hand, wrist and arm stress
- Momentary and alternate action models available
- Available in a wide variety of voltage ranges and output types to suit any application
- Field covers (black) included to prevent inadvertent activation from loose clothing, debris, etc.

Advanced Vision Lighting Solutions



Reliable Vision Performance Requires Advanced Lighting Solutions

Banner knows lights. We've been designing and perfecting LED-based industrial controls for over 40 years. We've developed a comprehensive line of lighting solutions dedicated to your machine vision applications.

For complete information on Banner's full Vision Lighting family visit www.bannerengineering.com/visionlights



Linear Array Lights

Linear Array Lights effectively illuminate large areas over long distances while cutting through dust, mist and grime



LED Area Lights

Area Lights provide even illumination with high-intensity lights for the highest levels of contrast to help vision sensors detect the presence or absence of a feature



LED On-Axis Lights

Banner's innovative On-Axis Lights use a beam splitter to focus light along a camera's optical axis, providing even, diffused illumination



LED Back Lights

Banner Backlights provide more optical contrast by creating an image that shows a silhouette of a part, allowing for inspection of size and shape



LED Ring Lights

Ring Lights brightly illuminate the area directly in front of a camera and are especially useful for small parts and high-speed inspections



Low-Angle Ring Lights

Low-Angle Ring Lights enhance the contrast of surface features, making them ideal for a number of quality, identification and verification applications



LED Spot Lights

Banner's Spot Lights are compact to fit into tight spaces, and when properly placed can effectively create shadows or highlights to boost optical contrast

New Products

Touch Buttons Pick-to-Light



S22 Flush Touch Button
page 102



K50L Touch
page 106

LED Lighting



WLS15 Strip Light
page 20



K70 Domed Indicator
page 72

Indicators



S22L2 Flush Indicator
page 86

K30L2 and K50L2
Indicators
page 66



S22 Flush
Touch Button
page 102



RGB Multicolor Options

New LED technology maximizes product performance, driving model standardization and enabling advanced customization.

TL50 Tower Lights
page 52



WLS27LED
Strip Lights
page 26



More Information Online

For the latest products, brackets, cordsets, accessories, and new solutions, find us on the web at www.bannerengineering.com.

You also have access to more detailed information such as engineering drawings, complete specifications, installation instructions, product configurators and product videos.

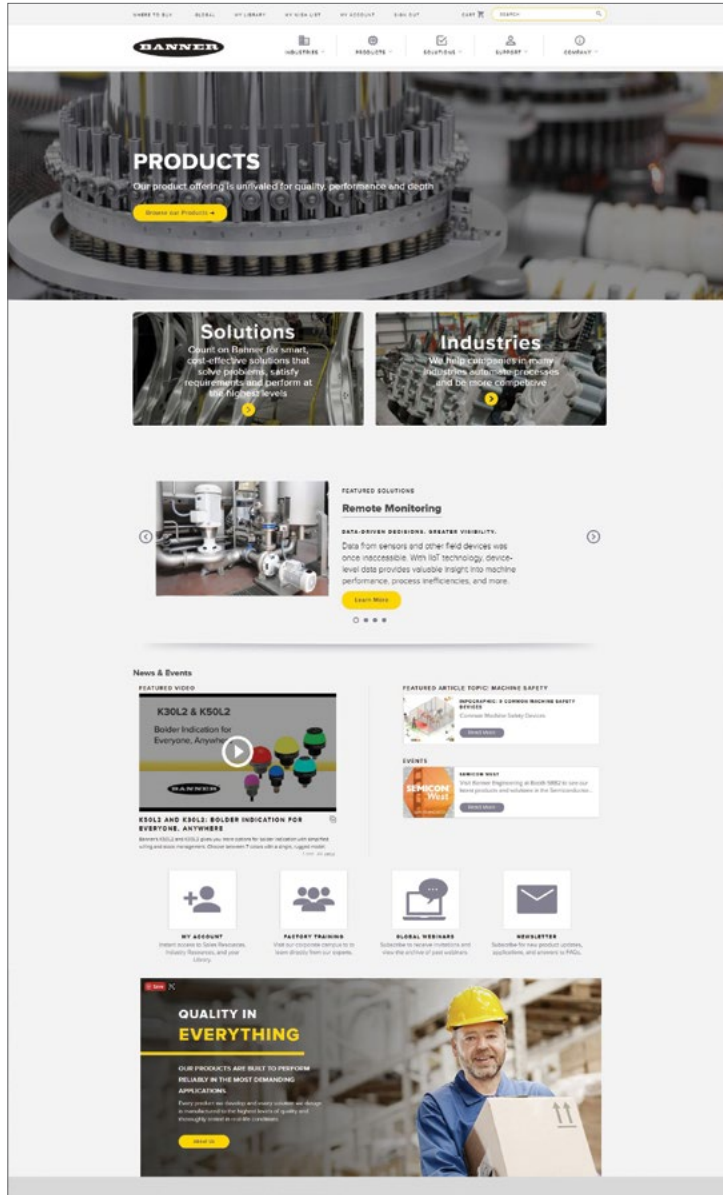

How to Reach Us

Global Sales and Support

Questions? Need additional assistance?

Banner has more than 3,000 representatives and distributors worldwide — ready to help you. Our highly skilled application engineers and industry experts are ready to support you wherever you are. For a complete listing, go to bannerengineering.com and find your local Banner Representative.

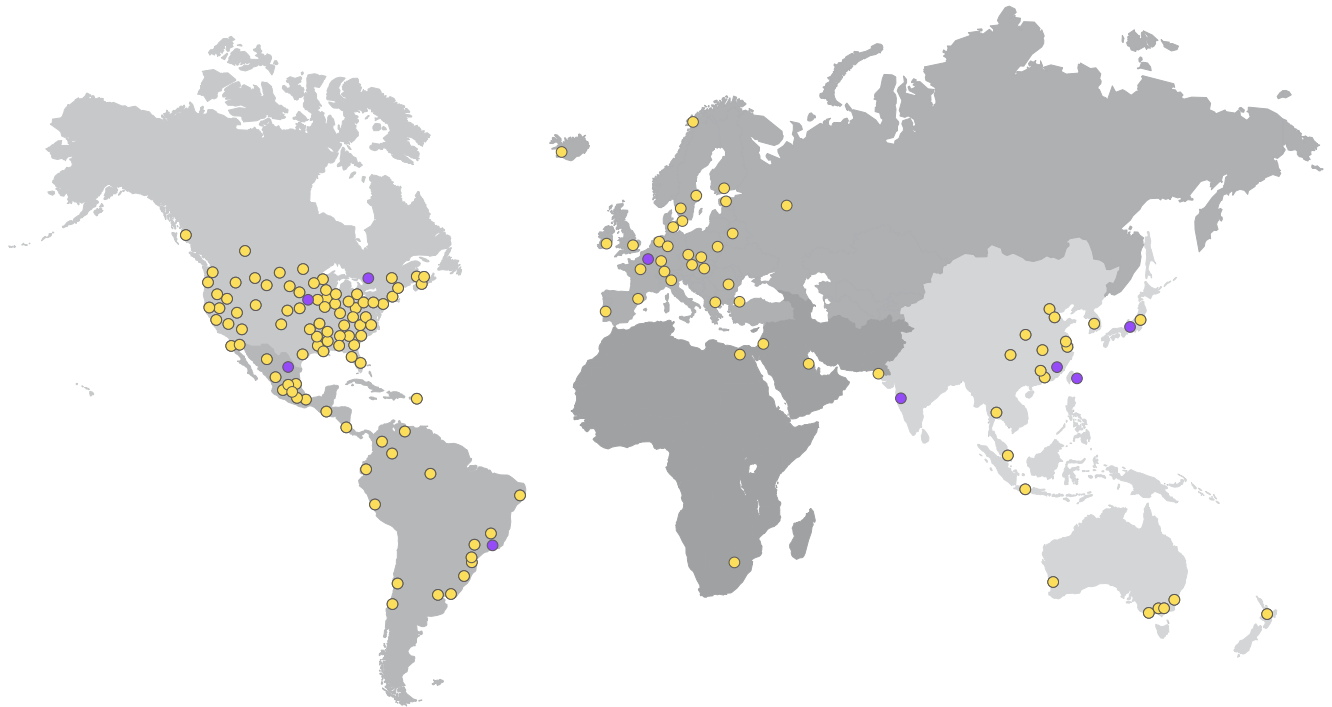

To contact a Banner Engineer about your application, call 1-888-3SENSOR (1-888-373-6767) or visit our website at www.bannerengineering.com/contact-us





Banner Engineering Corp.

9714 Tenth Avenue North • Minneapolis, Minnesota 55441
763-544-3164 • 1-888-373-6767

www.bannerengineering.com